

使用说明书 装配控制器

型号 EYFRW2

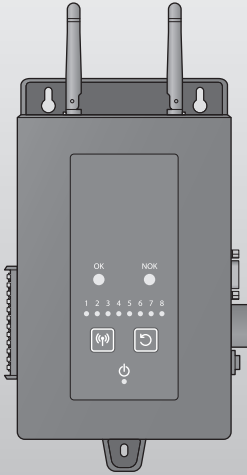

重要信息

使用本产品之前,请先详细阅读说明书,并妥加保管,以便日后使用。
请在购买国外控制使用无线功能。
否则会与各国的法令及规定等发生冲突。

原版说明书:英文
原版说明书译本:其他语言

目次

前言	2
安全注意事项	4
功能说明	7
系统配置	11
可连接的工具 / 安装注意事项	14

使用前的准备	16
设置控制器	22
与工具的配对连接	28
设置工具	32
设置工具的紧固参数	36
设置紧固控制模式	42
与外部设备连接	52
与外部设备通过 I/O 连接	53
与外部设备通过 Open Protocol 连接 ..	57
经由外部接入点连接	63
指示灯和蜂鸣器	64
操作键设置	66
确认连接工具信息	67
作业显示器功能	68
无线通信中断时的工具动作	70
运用中的数量计数复位操作	71
确认紧固履历数据	72
系统设置	77

维护、保管	79
-------------	----

性能、规格	83
无线认证	87
许可规定	89
错误代码	90
动作日志数据	92

使用前

操作

维护、保管

通知

使用时

本产品的设置中使用Web浏览器。
请准备支持以下内容的计算机。

运行环境

支持操作系统	Windows 10 以上 (支持以下浏览器的操作系统)
Web 浏览器	Microsoft Edge 版本 102 以上 或 Google Chrome 版本 102 以上

- 部分计算机即使满足运行环境也无法使用。
- 根据所用计算机的使用环境不同,本书的说明内容、画面和实际的内容、画面或有差异,敬请谅解。
- 本书的内容如有更改,恕不另行通知。
- 禁止擅自转载本书内容的部分或全部。
- 本书中使用的插图均为示意图。

【要求】

请始终更新为最新的固件后再使用。
最新固件数据可从以下使用说明书所载的网站进行确认。
关于固件更新方法,请参见“更新固件”。

参见 P81

使用说明书的获取方法

本产品的最新版使用说明书及相关资料请从以下网站下载。

<https://panasonic.net/electricworks/ecm/powerelctrictools/download/>

商标

- Microsoft 及 Windows 是美国 Microsoft Corporation 在美国及其他国家的注册商标或商标。
- 根据 Microsoft Corporation 的指南使用画面照片。
- Wi-Fi、Wi-Fi 标志是 Wi-Fi Alliance 的注册商标。

其他记载的各种名称、公司名称、产品名称等为各公司的商标或注册商标。另外,本文中部分™、®未注明。

本产品

本产品是利用工具和无线进行通信的控制器。
可以接收工具的紧固履历数据或控制工具设置及紧固数量。

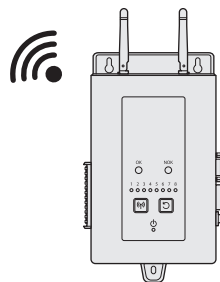

01 最多连接8台工具

02 支持2.4 GHz/5 GHz段

03 紧固控制、履历保存功能

操作

安装在可与工具进行无线通信的范围内使用。
通过AC插座接通电源,并在需要时,利用各类通信IF与外部设备连接。

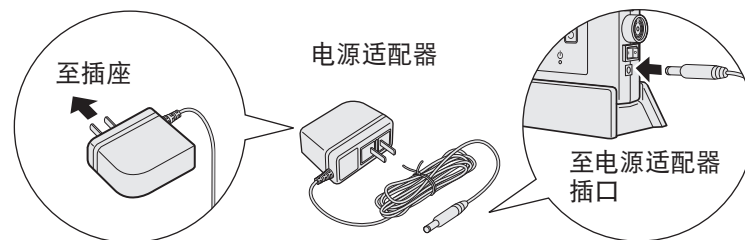
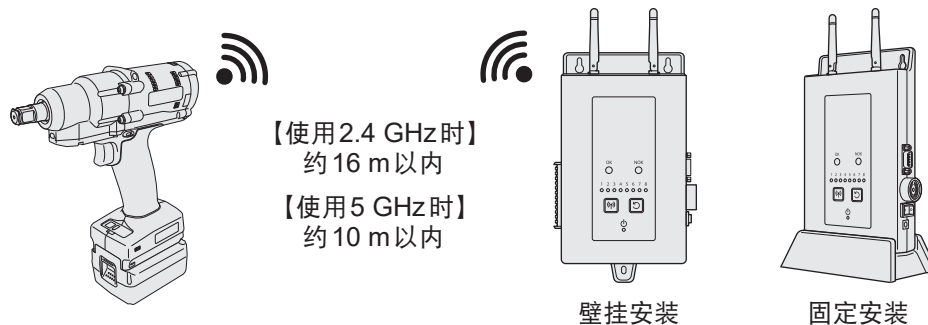



例: WEYFRW1K7951



- 本产品内置有纽扣电池,用以维持时钟功能(RTC)。建议始终打开电源,以控制内置纽扣电池的消耗。
- 无线通信距离因环境而异。



为了防止对人的危害和财产的损害,请必须遵守说明事项。



■ 针对错误使用时产生的危害和损害程度进行区分并说明。

 警告	可能造成死亡或重伤的内容。
 注意	可能造成轻伤或发生财产损失危险的内容。

■ 使用以下图片符号表示必须遵守的内容。(以下是图片符号的示例)

	绝对禁止的内容。
	必须执行的内容。

 警告	
 必须遵守	<ul style="list-style-type: none"> ● 确认安装位置是否有电线管、自来水管及煤气管等埋设管线。一旦接触埋设物可能会导致触电、漏电、煤气泄漏等事故。
	<ul style="list-style-type: none"> ● 确保电源插头插入插座。 插入不到位,可能引起触电或因发热引起火灾的危险。请勿使用损坏的插头或松动的插座。
	<ul style="list-style-type: none"> ● 定期清理电源插头上的灰尘等。 插头上积满灰尘等,可能因湿气等引起绝缘不良,进而引起火灾。请拔出插头,用干燥的布擦拭插头。
	<ul style="list-style-type: none"> ● 使用指定的电源线。 如不遵守,会导致触电、短路、火灾。
	<ul style="list-style-type: none"> ● 作业场所需足够明亮。 因昏暗导致的视线不佳可能引起事故或受伤。

 警告	
 禁止	<ul style="list-style-type: none"> ● 不得使用超过额定值或交流电 100 V-240 V 以外的插座或接线器具。 多脚布线等会超出额定值,导致发热引发火灾。
	<ul style="list-style-type: none"> ● 不得损坏电源线和插头。(不可有损伤、破损、加工、靠近热器具、强行弯曲、强拧、拉伸、放置重物、夹入、捆扎等) 如果在损伤状态下使用,会造成触电、短路、火灾。 请定期检查电线和插头,如有损坏,请立即咨询销售店。
	<ul style="list-style-type: none"> ● 请勿在直流电源及引擎发电机、变压器上使用控制器。 ● 请勿在有可燃性液体或气体的场所使用。 否则可能会出现发热、冒烟、起火、破裂。
	<ul style="list-style-type: none"> ● 请勿将控制器安装在水泥砂浆墙壁上。 用螺丝固定时,如有漏电,可能会使水泥砂浆内的板条网发热,导致起火。
	<ul style="list-style-type: none"> ● 不用时,请将电源插头从插座上拔出。 如果不遵守,有可能因绝缘劣化而导致触电或漏电火灾。
 禁止分解	<ul style="list-style-type: none"> ● 不可改造产品。不可进行拆解或修理。 有引起火灾、触电或受伤的危险。 修理请咨询购买的销售店或本公司的服务窗口。
 禁止浸水	<p>请不要对充电工具做以下操作。</p> <ul style="list-style-type: none"> ● 不可在雨淋或潮湿的地方使用或放置。 ● 不可浸水使用。 有冒烟、起火、破裂的危险。
 禁止湿手	<ul style="list-style-type: none"> ● 请勿用湿手将电源插头从插座上拔出。 有触电的危险。

注意



禁止

- 请勿用于非指定用途。
否则可能会造成人员受伤。
- 不要放在儿童够得着的地方。
有造成事故或故障的危险。
- 控制器中沾有油等异物时,请勿使用。
如果油等异物进入内部,可能会导致发热、起火、破裂。
- 请勿将本体保存在45℃以上环境中。
有动作异常的危险。
- 请勿采用不合理的姿势工作。
可能因摔倒而受伤。
始终注意脚下,保持身体平衡。
- 疲惫状态下不要使用。
有可能发生事故或受伤。
- 请勿让儿童等非作业人员靠近车间或触碰控制器。
有受伤的危险。
- 控制器只可用于适用机型。
否则会因误运转而引发事故。



必须遵守

- 壁挂安装控制器时,要用螺丝固定牢固,防止掉落。
否则可能会因掉落而导致人员受伤。
- 拔下电源插头时,请勿握住电源线,必须拿着电源插头拔出。
握住电线拔出的话,可能导致触电和短路。
- 使用前,请确认控制器及其他零件有无损伤,是否能正常运转。
如不遵守,可能会因破损等而造成人员受伤。
- 保持工作场所的干净。
散乱的场所和工作台是事故引发的原因。
- 注意操作和作业方法、周围的状况等,运用常识进行作业。
如果不按规定操作,可能会发生事故或受伤。

主体

■ 左侧面

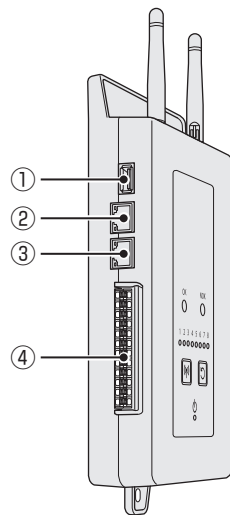

■ 正面

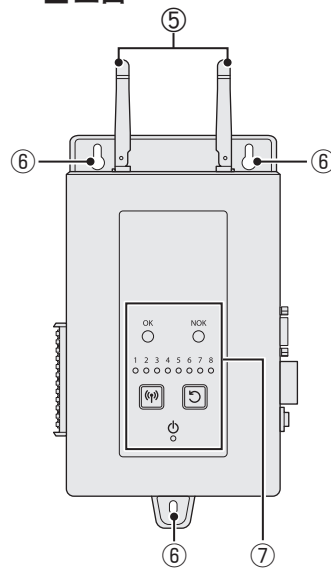

■ 右侧面

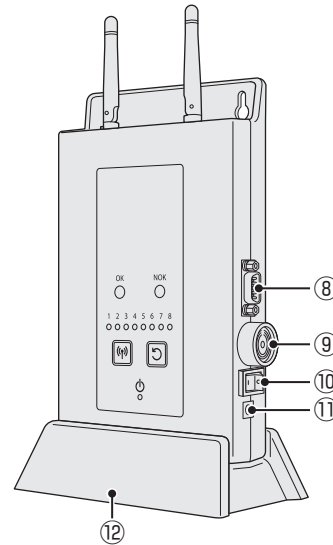

■ 电源适配器

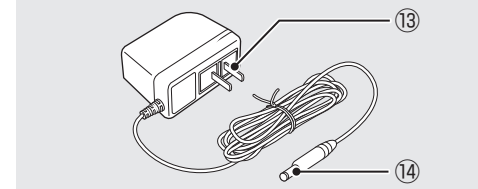

①	USB 端口 (Type-A)
②	Ethernet 端口 (维护用)
③	Ethernet 端口 (网络用)
④	1~24 I/O 端口
⑤	分集天线
⑥	壁挂孔
⑦	控制面板

⑧	IOIOI 串行端口 (RS232C)
⑨	蜂鸣器
⑩	电源开关
⑪	电源适配器插口
⑫	控制器支架
⑬	电源插头
⑭	电源端子

■ 控制面板

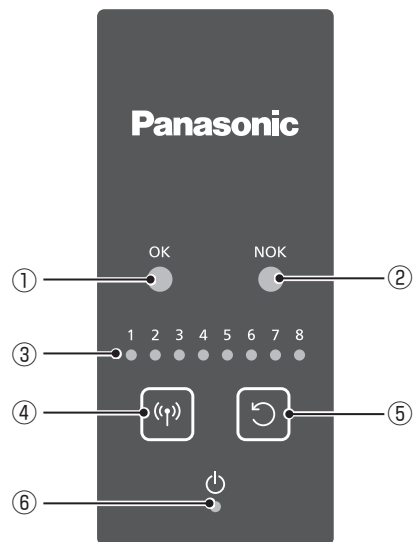

①	紧固 OK 指示灯 亮绿灯: 接收紧固 OK 信号 熄灭: 未接收紧固 OK 信号
②	紧固 NOK 指示灯 亮红灯: 接收紧固 NOK 信号 熄灭: 未接收紧固 NOK 信号
③	通信指示灯 (No.1~No.8) 亮蓝灯: 工具已注册 蓝灯闪烁: 工具注册中或通信范围外 熄灭: 工具未注册

④	配对键
⑤	复位键
⑥	电源指示灯 亮黄灯: 电源 ON (接收模式) 熄灭: 电源 OFF 黄灯闪烁: 发生错误

■ 通信接口

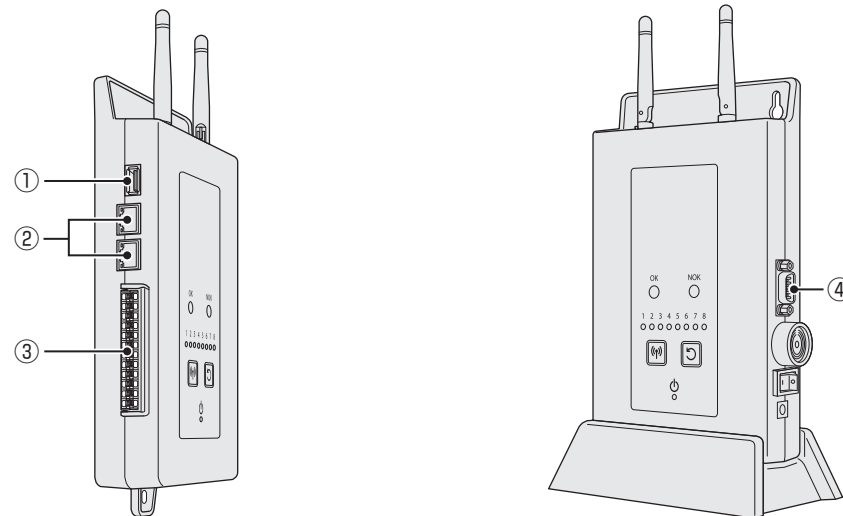

接口		详情
①	USB	使用USB存储器更新固件时使用。 • USB2.0 Type-A×1 • 仅限直接连接USB存储器(不可延长)
②	Ethernet (维护用/网络用)	用于和设置用计算机或上游系统连接。 • 10Base-T/100Base-TX×2 • 电缆长度30 m以下 ※ Ethernet端口(维护用)请和设置用计算机直接连接。 (不使用HUB)
③	输入输出端子(I/O)	用于和外部设备(PLC等)连接。 • 输入8点 输出8点 • 电缆长度10 m以下 • 输入端子额定值:DC24 V 50 mA • 输出端子额定值:DC30 V 3 A
④	串口(RS232C)	用于和外部设备(PLC等)连接。 • RS232C×1 • 电缆长度10 m以下

网络构成模式

可在以下3种模式下使用。

■ 不管理工具的IP地址

※自动分配(使用控制器内置接入点)

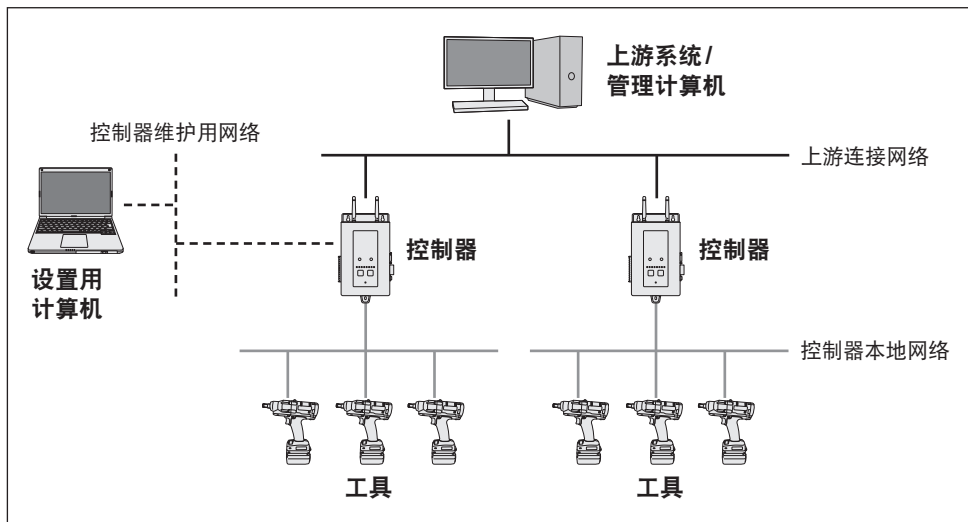

■ 管理工具的IP地址(使用控制器内置接入点)

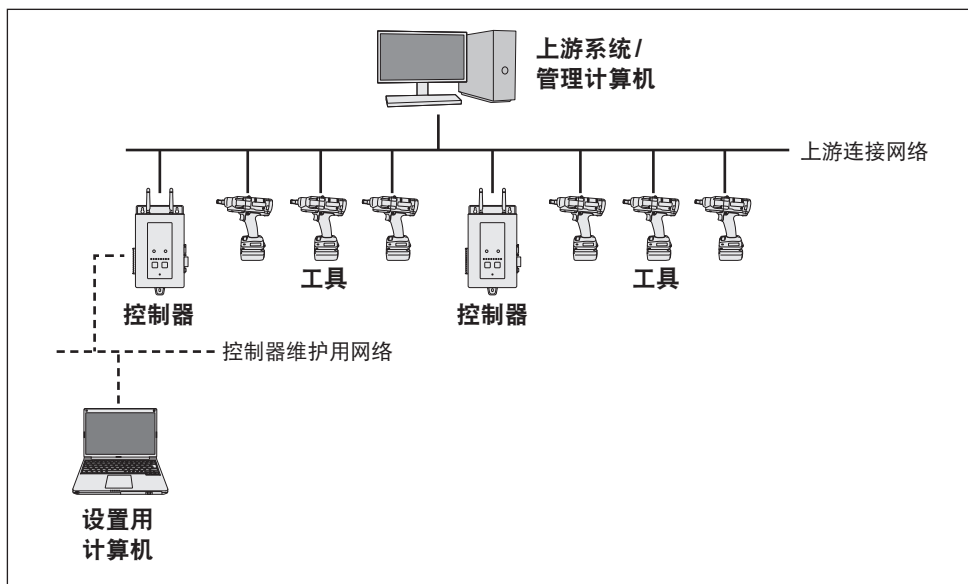

■ 管理工具的IP地址(使用外部接入点)

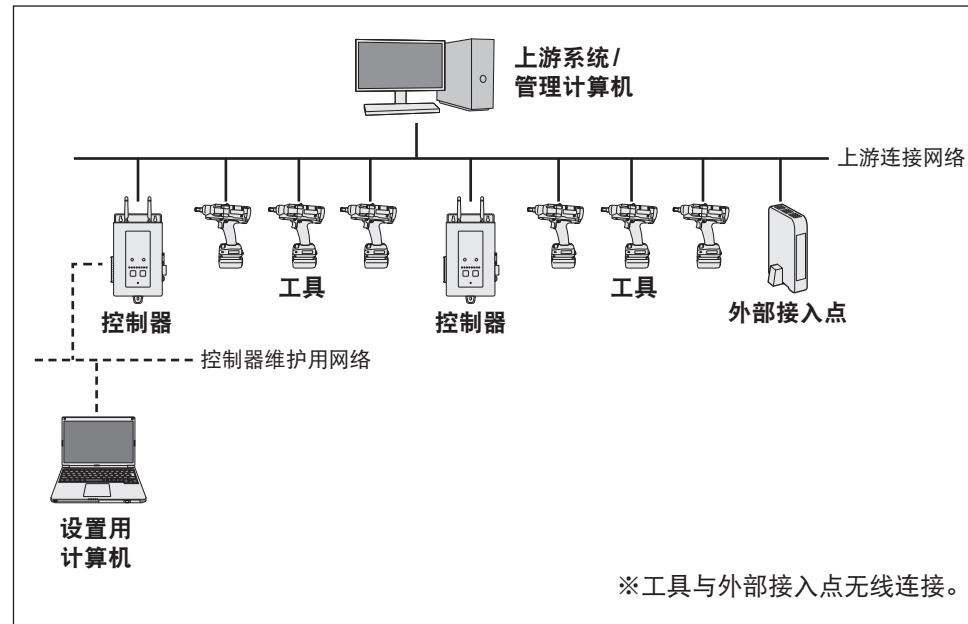

※ 本系统请在本地网络环境(无联网)中使用。

※ 在实际开始使用之前,请务必确认控制器的网络用IP地址设置。(需要时请更改默认值)

可连接的工具 / 安装注意事项

连接对象工具 型号一览

可注册型号

EYFMH1WC、EYFMH2WC

安装注意事项

控制器请安装在高度 80 cm 以上的场所。另外,如有多个控制器相邻,请在安装时至少距离 10 cm 以上。(建议 1 m 以上)

安装控制器的天线时,要确保天线周围没有障碍物。

控制器采用分集天线型,有 2 根天线,在安装时请确保 2 根天线的周边均没有障碍物。

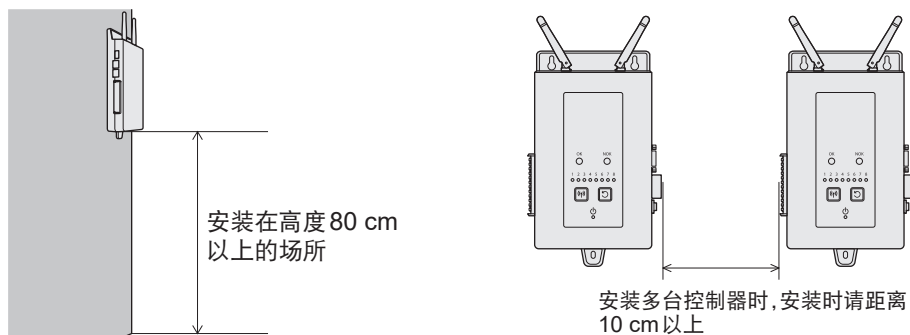

通信不稳定时,请调整天线角度。

※安装在金属盘内时,调整天线角度可能会使通信稳定。

安装时,前倾 30~45° 左右

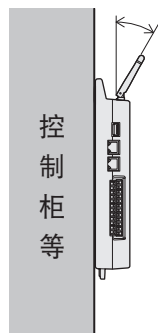

从正面看,安装时朝外伸出 30~45°

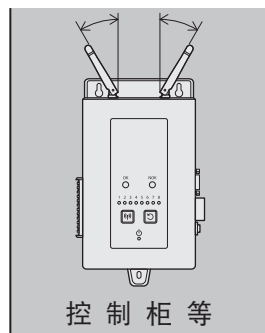

请勿如下安装。

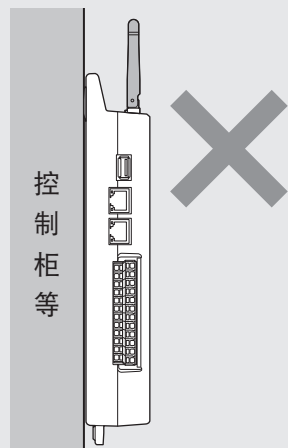

背面的控制柜(金属物)与天线平行

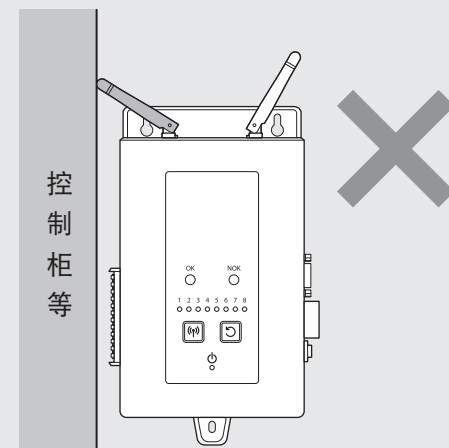

天线接触到控制柜(金属物)

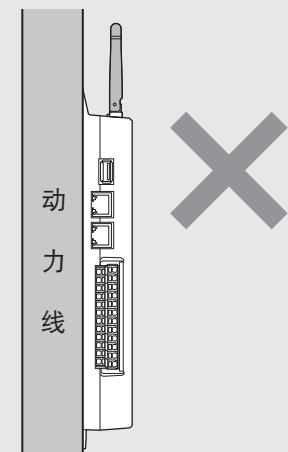

安装在过于靠近动力线的位置

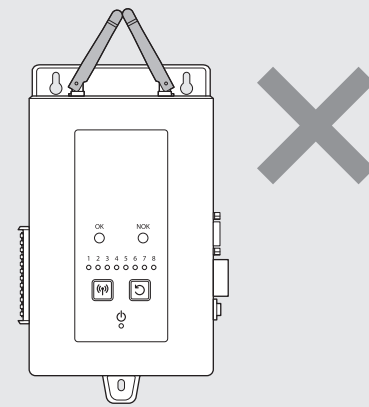

天线之间相接触

使用前

使用前的准备

设置用计算机侧的网络设置

首次连接控制器和设置用计算机时,请将设置用计算机的网络设置更改如下。

1 单击(单击画面左下方的) - (Settings) - [Network & Internet] - [Change adapter options]

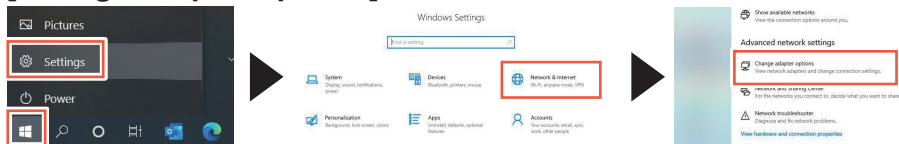

2 右击要连接的设备,然后单击 [Properties]

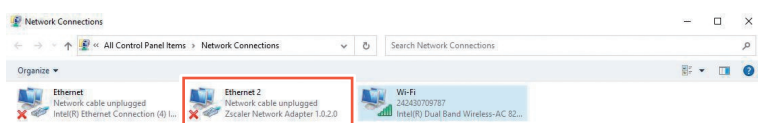

3 选择“Internet Protocol Version 4”,单击 [Properties]

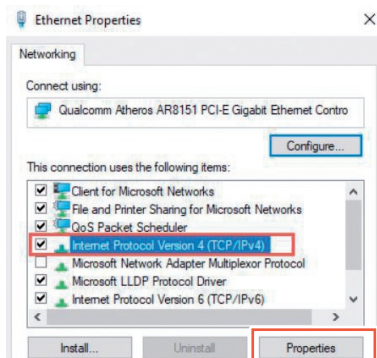

4 如下设置“IP address”及“Subnet mask”



IP address	192 . 168 . 20 . 200
Subnet mask	255 . 255 . 255 . 0

※首次连接后,如果任意更改了控制器的IP地址,通过将设置用计算机的网络设置(IP address及Subnet mask)恢复到更改之前后可连接。这时,请确保控制器和设置用计算机为同一网络环境后,再设置IP地址。

※请记住更改前的设置用计算机的网络设置(IP address及Subnet mask),以免丢失。

※ Default gateway 建议不设置(空白)。

显示设置画面

设置控制器时,请用Web浏览器访问控制器进行。
按以下步骤可显示控制器的设置画面。

首次使用时,请拔出背面纽扣电池的保护膜后再使用。

1 打开控制器的电源

- ① 将自带的电源适配器连接到控制器,将电源插头插入插座。
- ② 打开控制器的电源开关。

※ 启动需要数十秒。
※ 启动中,紧固OK指示灯、紧固NOK指示灯、通信指示灯(No.1~No.8)全部闪烁。
※ 请勿连接LAN电缆。

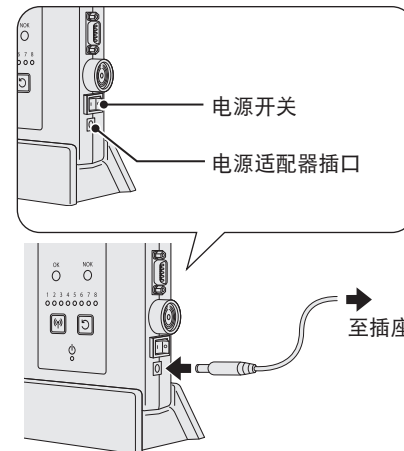

2 用LAN电缆连接控制器和设置用计算机

- ① 将LAN电缆插入控制器的Ethernet端口。
※ Ethernet端口有维护用和网络用2个端口。
首次连接时,请使用维护用端口。
- ② 用LAN电缆和设置用计算机连接。

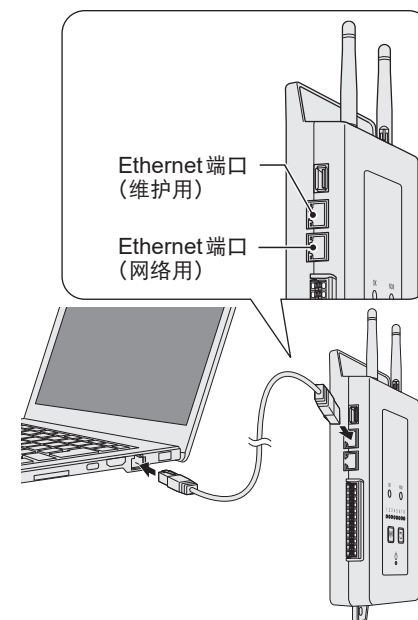

3 在设置用计算机上启动Web浏览器,访问控制器

① 在设置用计算机上启动Web浏览器。(推荐Microsoft Edge)

② 在Web浏览器的地址栏中输入控制器的IP地址。

※默认的Ethernet端口(维护用)IP地址为“192.168.20.10”。

在Web浏览器的地址栏中输入“http://192.168.20.10/controller”后访问。
※仅“192.168.20.10/controller”也可访问。

※关于从Ethernet端口(网络用)访问的方法,请参见“经由网络的连接方法”。

参见 P21

※还需要对设置用计算机侧的IP地址进行设置。

③ 显示登录画面后,输入User ID和Password。

※首次登录时的用户ID和密码请参见以下内容。

④ 显示Home画面(设置画面初始页面)。

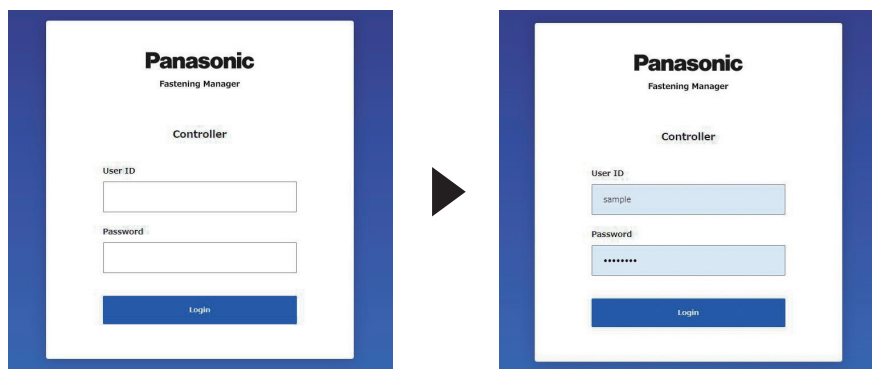

首次登录时的用户ID和密码

请用以下用户ID和密码登录。

■ User ID: root

■ Password: abcABC123

※首次登录时的帐户类型为“默认”。

关于帐户的类型,请参见“帐户的类型(权限)”。**参见 P19**

※用上述用户ID和密码登录后,只可创建帐户。实际使用时,请创建新帐户。

※为了安全起见,建议在首次登录后修改上述密码。

帐户的类型(权限)

帐户有以下几种。请根据用途使用。

帐户的类型	可使用的功能
默认	<ul style="list-style-type: none"> 首次登录用。参见 P18 追加和更改用户帐户。
Administrator	<ul style="list-style-type: none"> 确认紧固履历。 设置控制器。 设置工具。 追加和更改用户帐户。 ※至少要创建1个以上的管理员帐户。
General	<ul style="list-style-type: none"> 仅确认紧固履历(包括浏览作业显示器)。

最多可注册10个帐户。

请在多名作业人员同时登录使用等的情况下使用。

※仅可用1个管理员帐户同时访问。

如有多个访问重叠,后发的会话优先。

创建用户帐户

使用前,请创建新的用户帐户。

1 从Home画面(设置画面初始页面)右上方的选项键中选择“Account Settings”

显示“Account Settings”画面。

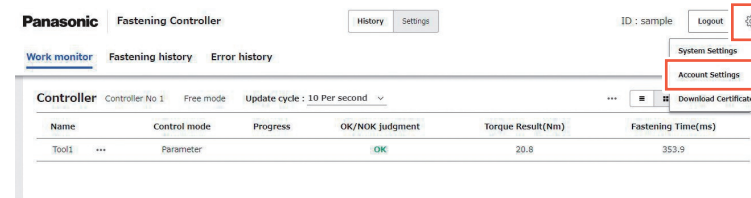

2 单击“Account Settings”画面中的[Add]

显示“Add account”画面。

•更改帐户请单击[Change],删除帐户请单击[Delete]。

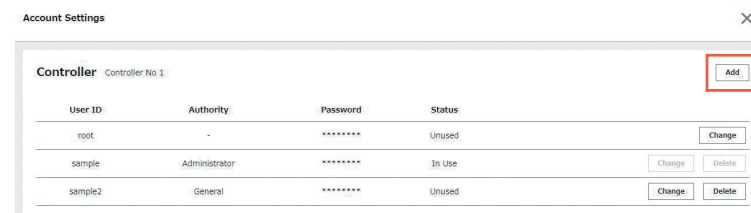

3 输入“User ID”、“Password”，选择“Authority”后单击[Add]

※进行工具设置时,请创建管理员帐户。

※密码请务必组合大写字母、小写字母、数字、符号中的3种以上。

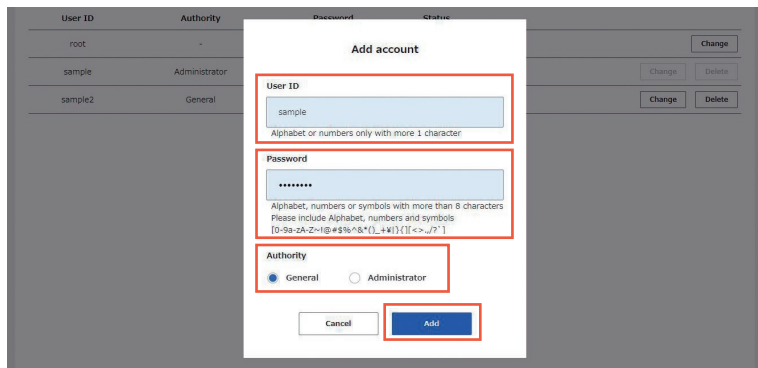

获取证书

从Ethernet端口(网络用)访问控制器时需要证书。

证书可按以下步骤获取。

1 通过Home画面(设置画面初始页面)右上方的选项键选择“Download Certificate”

证书数据下载到设置用计算机中。

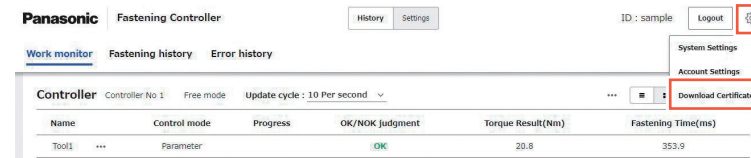

2 在“经由网络访问控制器的设置用计算机”中安装证书

①双击下载的证书数据,选择“Install Certificate”。

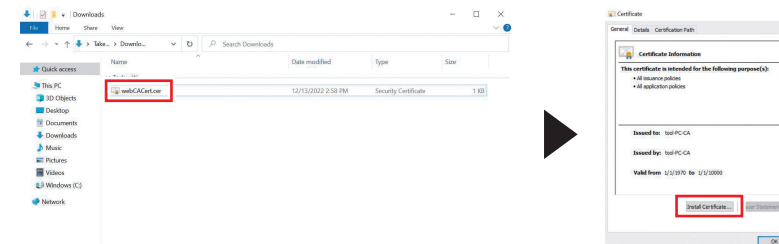

②从“Place all certificates in the following store”指定“Trusted Root Certification Authorities”。

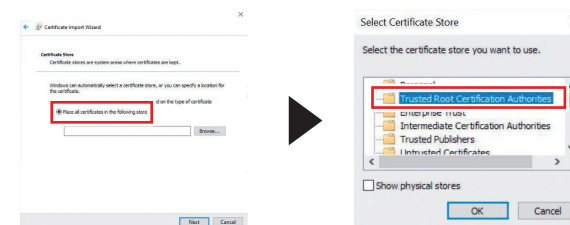

【参考】用户ID/密码丢失时的处理方法

■ 普通帐户

【方法①】用管理员帐户登录后更改该帐户。

※由于普通帐户无法更改用户ID/密码,需要让管理员帐户持有者进行处理。

【方法②】用新建的管理员帐户登录后更改该帐户。

※请用首次登录时的用户ID和密码登录,然后新建管理员帐户。

参见 P18

■ 管理员帐户时

A) 创建多个管理员帐户时

【方法①】用其他管理员帐户登录后更改该帐户。

【方法②】用新建的管理员帐户登录后更改该帐户。

※请用首次登录时的用户ID和密码登录,然后新建管理员帐户。

参见 P18

【方法③】如果包括初始ID在内的所有管理员帐户的ID/密码丢失,进行初始化。

参见 P79

B) 只有1个管理员帐户时

【方法①】用新建的管理员帐户登录后更改该帐户。

※请用首次登录时的用户ID和密码登录,然后新建管理员帐户。

参见 P18

【方法②】如果包括初始ID在内的所有管理员帐户的ID/密码丢失,进行初始化。

参见 P79

经由网络的连接方法

从Ethernet端口(网络用)连接控制器时,请在Web浏览器的地址栏中输入“https://XXX.XXX.XXX.XXX/controller”后访问。

※在XXX.XXX.XXX.XXX中输入IP地址。

※初始设置IP地址为“192.168.0.10”。更改初始设置时,请输入更改后的地址。

参见 P26

基本设置 (Basic settings)

单击 Home 画面 (设置画面初始页面) 上部的 [Settings], 然后选择 “Basic settings” 选项卡。

可以设置控制器主体。

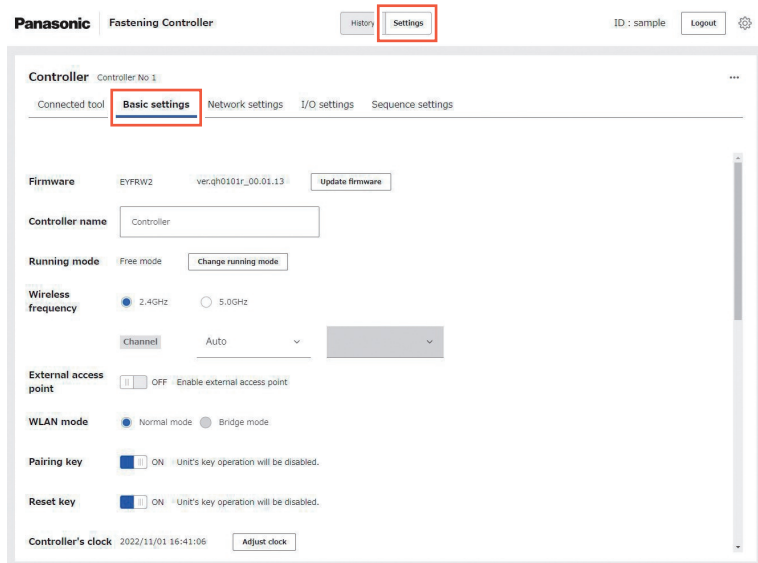

时间设置

选择 “Timezone” 后, 单击 [Adjust clock]。更新时间。

- 出厂时未设置时间。首次使用时请务必设置时间。

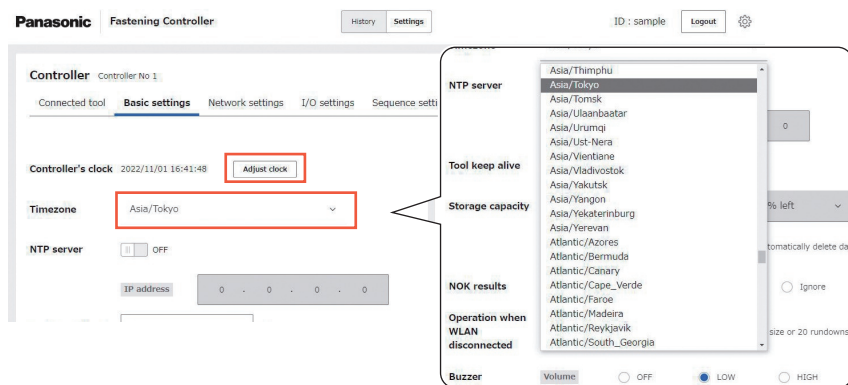

※如果使用 NTP 服务器, 请输入 IP 地址。

无线频率、通道的设置

可以设置要使用的频率。

选择 “2.4GHz” 或 “5GHz”, 然后选择使用通道。

※ “2.4GHz” 和 “5GHz” 可选择的通道不同。

※可进行 “自动通道” 设置。

电源 ON 时, 会自动在周围环境中选择空闲的通道。
请灵活用于针对电波干扰的措施。

※将多台控制器靠近安装时, 请避免设置相邻的通道。

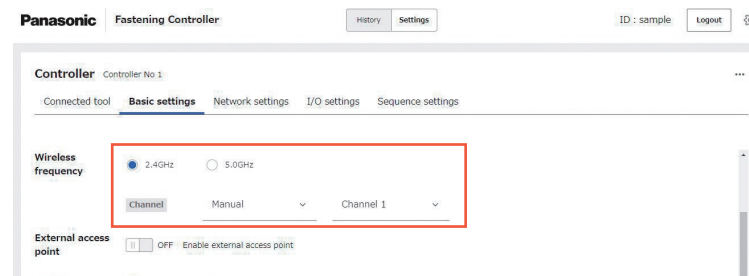

设置项目一览

Firmware

显示控制器的固件版本。

单击 [Update firmware] 可更新固件。

更新步骤请参见 “更新固件”。 **参见 P81**

Controller name

可注册控制器的名称。

最多 32 位英文数字。

[默认值] Controller

[设置范围] 最多 32 个英文数字字符串

※仅可使用 “-” (连字符) “_” (下划线) “ ” (半角空格) 符号

Running mode

选择控制器的动作模式。

[默认值] Free mode

[设置范围] Free mode / Repeat mode (Basic mode / Sequence mode) / External control mode

Wireless frequency

选择用于无线通信的频率通道。

[默认值] 2.4GHz

[设置范围] 2.4GHz (Auto / Channel 1 ~ 13) / 5GHz (Auto / Channel 36, 40, 44, 48)

※ Channel 12 和 13 不可在中国和韩国使用。

External access point
<p>启用使用外部接入点的通信。 参见 P63</p> <p>[默认值] OFF (禁用)</p> <p>[设置范围] OFF (禁用)/ON (启用)</p> <p>※ WLAN mode: 不使用外部接入点动作时的设置。 [Normal mode]: 不管理 (自动分配) 工具的 IP 地址时 [Bridge mode]: 要管理 (指定) 工具的 IP 地址时</p>
Pairing key
<p>启用主体配对键的操作。</p> <p>[默认值] ON (启用)</p> <p>[设置范围] OFF (禁用)/ON (启用)</p>
Reset key
<p>启用主体复位键的操作。</p> <p>[默认值] ON (启用)</p> <p>[设置范围] OFF (禁用)/ON (启用)</p>
Controller's clock
<p>设置控制器的时间。</p> <p>单击 [Adjust clock] 可更新时间。</p>
Timezone
<p>同步控制器时钟时, 可设置任意的时区。</p>
NTP server
<p>设置 NTP 服务器可自动同步时间。</p>

Tool keep alive
<p>设置在无线通信模式中从控制器对工具进行生存确认的时间间隔。 如果工具无反应, 会被视为脱机并断开。</p> <p>[默认值] 30 s</p> <p>[设置范围] 10 s ~ 3600 s</p>
Storage capacity
<p>设置在存储器剩余空间变少时是否进行通知, 以及空间不足时的动作。</p> <p>[默认值] (通知) OFF (动作) Automatically delete data</p> <p>[设置范围] (通知) OFF / ON (剩余空间 10/20/30/40/50%) (动作) Suspend operation / Automatically delete data</p> <p>默认设置为“Automatically delete data”。 请在考虑数据的处理方法之后, 再根据需要更改为“Suspend operation”。</p>
NOK results
<p>选择紧固 NOK 数据的处理。</p> <p>[默认值] Store data only</p> <p>[设置范围] Report to system / Store data only / Ignore</p>
Operation when WLAN disconnected
<p>选择无线通信暂时切断时的作业处理。</p> <p>[默认值] Suspend tool</p> <p>[设置范围] Suspend tool / Enable fastening (Until batch size or 20 rundowns)</p> <p>详情请参见“无线通信中断时的工具动作”。 参见 P70</p>
Buzzer
<p>选择蜂鸣器的音量及要通知的内容。</p> <p>[默认值] (Volume) LOW (Beep) 全部 ON</p> <p>[设置范围] (Volume) OFF / LOW / HIGH (Beep) 各项目 OFF / ON</p>

网络设置 (Network settings)

单击Home画面(设置画面初始页面)上部的[Settings],然后选择“Network settings”选项卡。
完成控制器的网络设置。

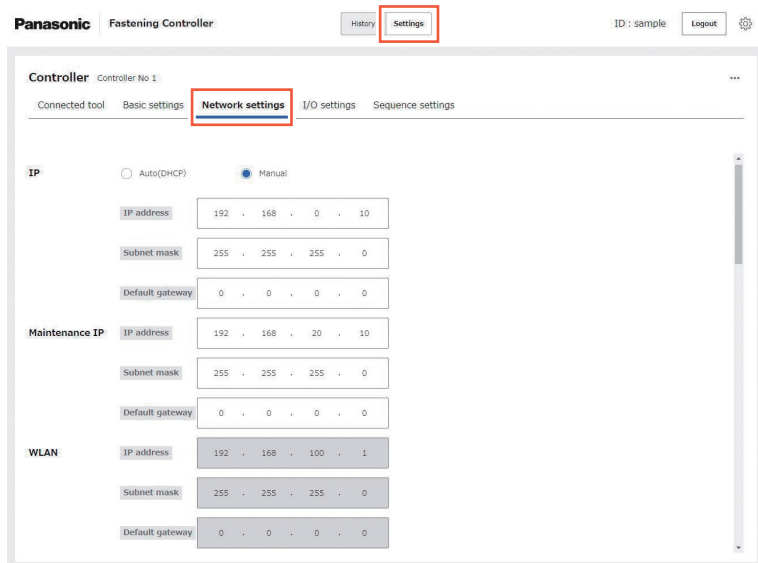

■ 设置项目一览

IP
设置Ethernet端口(网络用)的IP地址。 [默认值] Manual [设置范围] Auto (DHCP) / Manual ※手动设置时 [默认值] (IP address) 192.168.0.10 (Subnet mask) 255.255.255.0 (Default gateway) 0.0.0.0
Maintenance IP
设置Ethernet端口(维护用)的IP地址。 [默认值] (IP address) 192.168.20.10 (Subnet mask) 255.255.255.0 (Default gateway) 0.0.0.0

WLAN
设置与工具进行无线通信的IP地址(控制器端)。 [默认值] (IP address) 192.168.100.1 (Subnet mask) 255.255.255.0 (Default gateway) 0.0.0.0
Atlas Open Protocol
设置Atlas Open Protocol相关项目。 详情请参见“通过Open Protocol通信连接”。 参见 P57
Access point
设置用于和工具进行无线通信的内置接入点。 [默认值] (SSID) 控制器型号-MAC地址 (Security) WPA2 [设置范围](SSID) 最多32个英文数字字符 (Security) WPA2
External access point
设置要使用的外部接入点。 [默认值] (SSID) 无 (Security) 无 (Password) 无 [设置范围](SSID) 最多32个英文数字字符 (Security) Open/WPA2 (Password) 8-63个英文数字字符 ※ 不可使用“”“¥”“,”“` (重音符)”符号。 ※ 在“Basic settings”中,仅在设置“External access point”“ON”时,启用设置。

- 请确保“IP”和“Maintenance IP”的IP地址子网不重复。
(“Subnet mask”为默认设置(255.255.255.0)时,请避免“192.168.0”及“192.168.20”的部分不一致)

控制器的配对操作

利用“主体按键操作”和“设置画面操作”2种方法,可使控制器进入配对模式。
配对模式持续2分钟,如果在此期间在通信范围内使工具进入配对模式,将会自动建立配对。

如果在该时间内未完成配对,则会解除配对模式。

※配对操作后到进入配对模式可能需要较长时间。

■ 主体按键操作

操作控制器主体上的配对键。

选择通信指示灯上的未注册No.(熄灭),长按进入配对模式。

详情请参见以下章节。

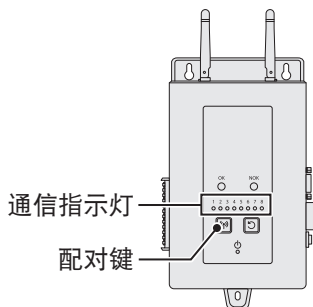

(注册工具No.4时)

- 1 按下控制器主体的配对键4次,选择工具No.4
通信指示灯No.4闪烁。



- 2 在选中No.4的状态下,长按控制器主体上的配对键,进入工具No.4的配对模式
进入配对模式后,通信指示灯No.4的闪烁变成快速闪烁。

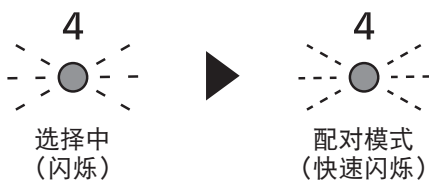

- 3 操作工具,使工具No.4完成配对
通信指示灯No.4点亮。
有关工具的操作,请确认“工具主体的配对操作”。[参见 P30](#)



■ 设置画面操作

单击Home画面(设置画面初始页面)上部的[Settings],然后选择“Connected tool”选项卡。

在“Connected tool”画面中单击对象工具No.的[Pairing]。

控制器进入配对模式后,进行“工具主体的配对操作”。[参见 P30](#)

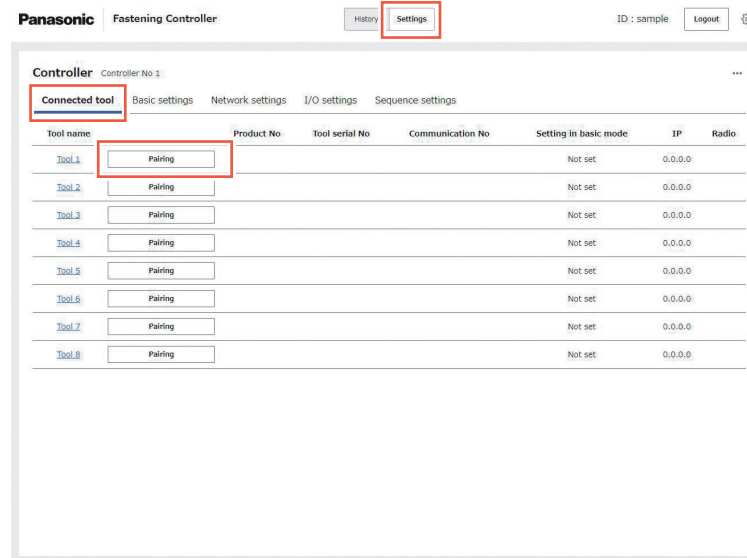

【参考】与备用工具进行替换

如果由于工具故障等原因,替换为与同一型号的工具进行配对注册时,按配对解除 [参见 P30](#) ▶ 配对操作 [参见 P28](#) 的顺序对应后,将自动沿用紧固参数等设定值。

※要配对登录其他型号的工具时,请在解除配对后删除注册信息,然后再进行配对注册。[参见 P34](#)

配对完成时的显示

配对完成后,如果在设置画面没有显示配对的工具信息,请在设置画面进行画面内更新。

※“Bridge mode”“External access point”请在配对注册前设置工具IP地址。

工具主体的配对操作

请在控制器进入配对模式后,再进行工具主体的配对操作。

操作步骤

1 安装电池组后,按住LED灯ON/OFF按钮,拉出触发开关

进入配对模式。
自动建立无线通信,配对注册完成。
※详细内容请参见工具主体的使用说明书。
※如果配对未建立,请先在控制器端进行配对解除操作,然后重新进行配对操作。

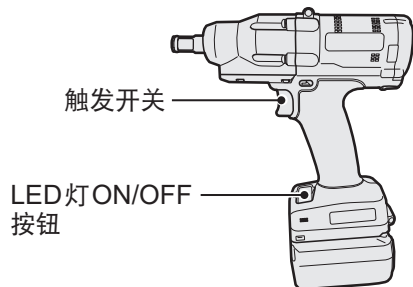

配对解除

可以利用“主体按键操作”和“设置画面操作”2种方法解除控制器的配对注册。

主体按键操作

操作控制器主体上的配对键。
选择要解除注册的通信指示灯的工具No.(点亮),
长按后可解除配对注册。
详情请参见以下章节。

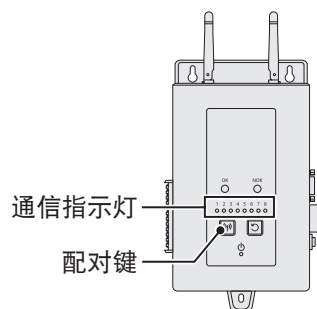

(解除工具No.4时)

1 按下控制器主体的配对键4次,选择工具No.4 通信指示灯No.4闪烁。



2 在No.4选中状态长按控制器主体上的配对键,解除工具No.4的配对注册

解除配对注册后,通信指示灯No.4的闪烁变为熄灭。

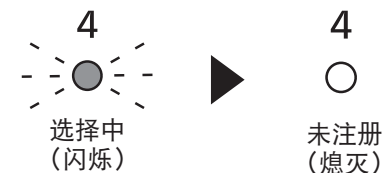

设置画面操作

单击Home画面(设置画面初始页面)上部的[Settings],然后选择“Connected tool”选项卡。
在“Connected tool”画面中单击对象工具No.的[Cancel Pairing]。

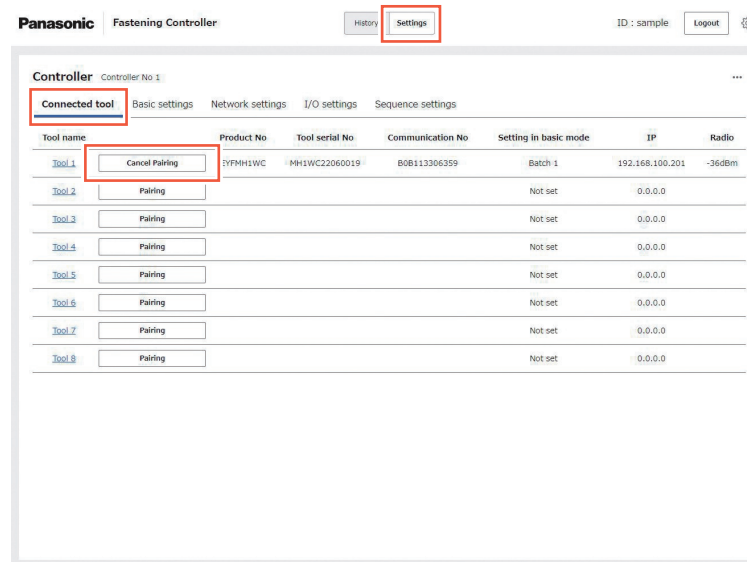

※ 在工具电源 OFF 状态等控制器与工具间无法通信时,请勾选配对解除确认对话框中的 [Force to unpair]。

工具画面的显示

单击 Home 画面 (设置画面初始页面) 上部的 [Settings], 然后选择 “Connected tool” 选项卡。

在 “Connected tool” 画面中单击对象工具 No.。
显示工具 No. 画面。

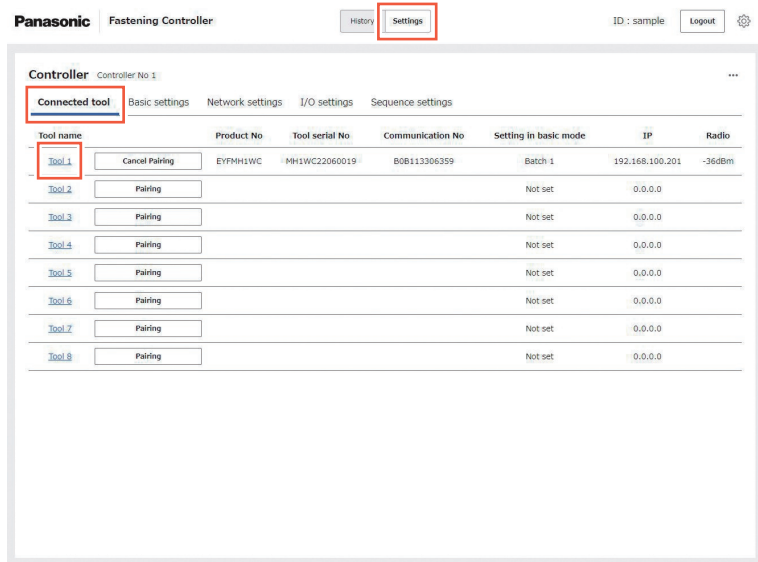

工具设置画面的显示

可以从工具 No. 画面的 “Device settings” 选项卡选择工具的基本设置及通用参数的设置。

※切换工具时,也可以从工具列表选择。

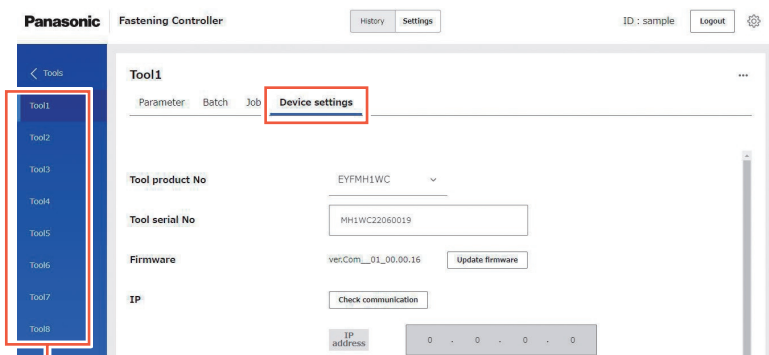

工具列表

工具设置项目

Tool product No

选择工具型号。

[默认值] 未选择

[设置范围] 下拉选择

※先进行配对时自动选择。

※配对后不可更改型号。请先解除配对后再重新设置。

Tool serial No

显示/设置工具的个体识别信息。

[默认值] 型号识别 5 位 + 制造编号 8 位 (制造年份 2 位 + 月份 2 位 + 生产批次 4 位)

[设置范围] 13 ~ 16 个英文数字字符

※如果更改,可能无法正确识别机型。

从管理规定上来讲,如非必要,使用时请勿更改。

Firmware

显示工具通信部的固件版本。

单击 [Update firmware], 可更新固件。

更新步骤请参见 “更新固件”。 **参见 P81**

IP

设置与工具进行无线通信用的 IP 地址 (工具侧)。

[默认值] (IP address) 192.168.100.201 (工具 1) ~ 208 (工具 8)

(Subnet mask) 255.255.255.0

(Default gateway) 0.0.0.0

※ 启用 Bridge mode 或 External access point 时,全部为 “0.0.0.0”。

Tool's clock

显示工具的时间。单击 [Adjust to controller] 可同步时间。

- 有关其他设置项目,请参见工具主体的使用说明书。

删除注册信息

停止使用该 No. 的工具时,或在配对使用其他型号的工具时,请删除注册信息。
※请解除配对后再进行。

- 1 单击 Home 画面 (设置画面初始页面) 上部的 [Settings], 然后选择 “Connected tool” 选项卡
显示 “Connected tool” 画面。
- 2 在 “Connected tool” 画面中单击对象工具 No.
显示工具 No. 画面。

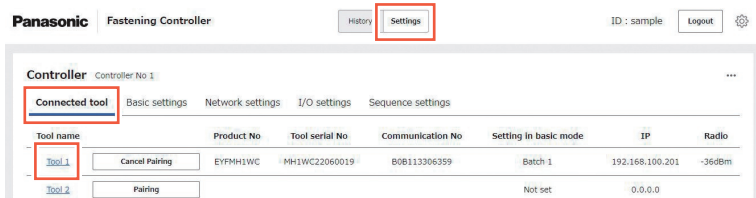

- 3 从 ... (工具选项键) 单击 [Delete tool settings]
显示 “Delete tool settings” 画面。

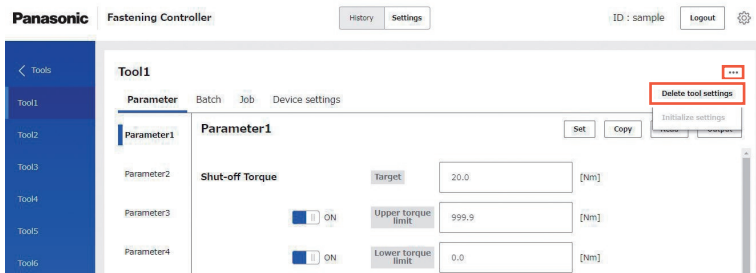

- 4 在 “Delete tool settings” 画面中单击 [OK]

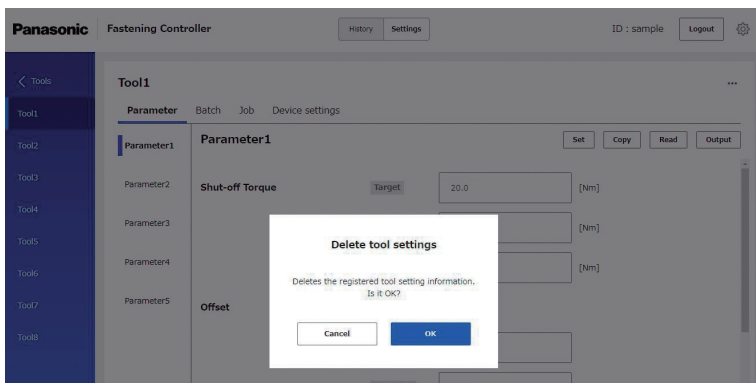

复位到出厂状态

可将工具的设置复位到出厂状态。
※复位后解除配对。

- 1 单击 Home 画面 (设置画面初始页面) 上部的 [Settings], 然后选择 “Connected tool” 选项卡
显示 “Connected tool” 画面。
- 2 在 “Connected tool” 画面中单击对象工具 No.
显示工具 No. 画面。

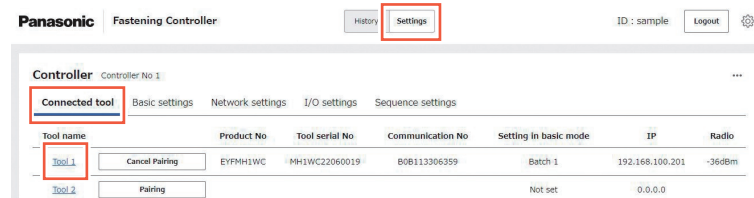

- 3 从 ... (工具选项键) 单击 [Initialize settings]
显示 “Initialize settings” 画面。

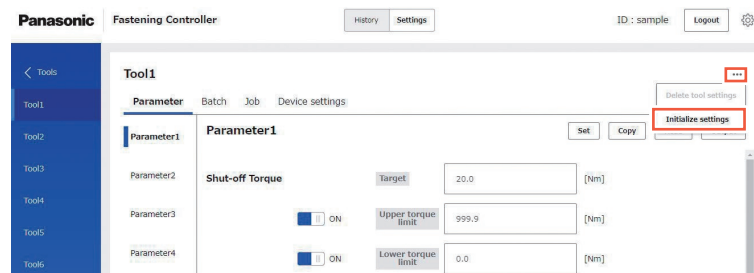

- 4 在 “Initialize settings” 画面中单击 [OK]

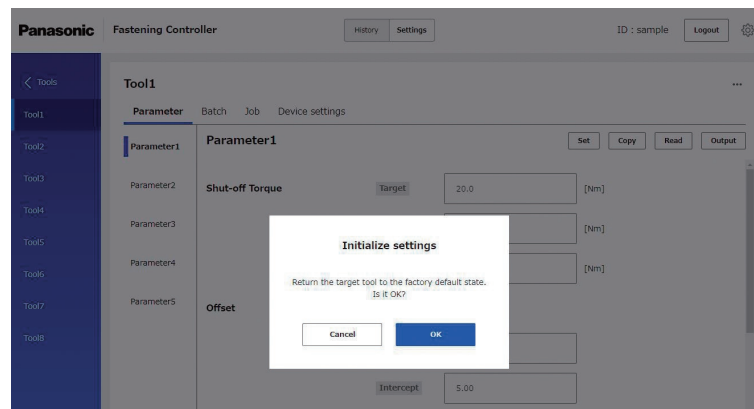

设置工具的紧固参数

参数设置

单击Home画面(设置画面初始页面)上部的[Settings],然后选择“Connected tool”选项卡。

在“Connected tool”画面中单击对象工具No.。

可从工具NO.画面中的“Parameter”选项卡进行设置。

每台工具可注册5种参数(参数1~5)。

※切换工具时,也可从工具列表选择。

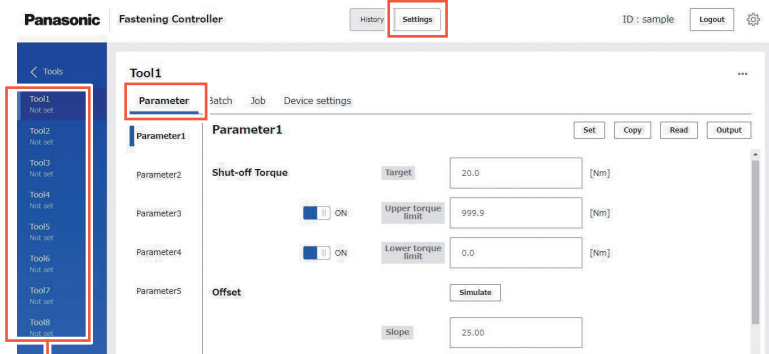

工具列表

复制参数

要根据已创建完成的参数创建新参数时,或者要在其他工具中使用同一参数时,可进行复制。

从工具NO.画面的“Parameter”选项卡单击[Copy]后,会显示参数的复制画面,请选择复制路径,并单击参数复制画面中的[Copy]。

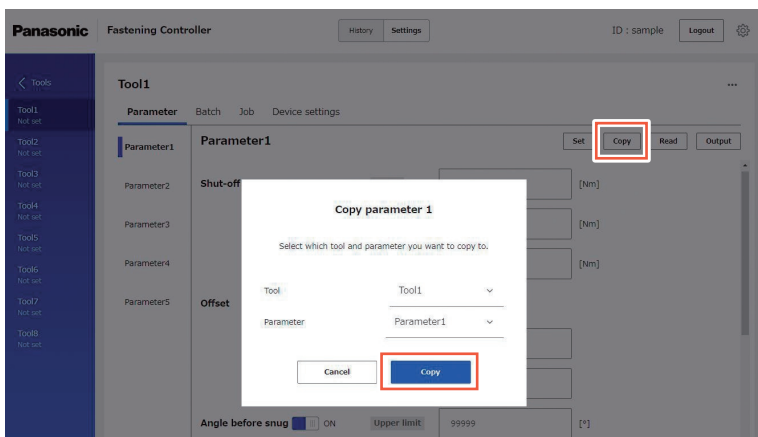

读取参数

可以将保存在设置用计算机中的参数文件读取到控制器进行注册。

也可以读取用“Tool Manager”创建的参数文件。

请从工具NO.画面的“Parameter”选项卡单击[Read],打开参数文件。

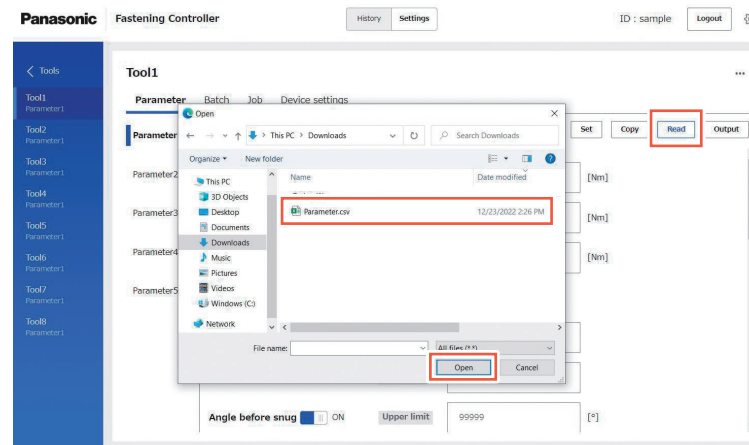

输出参数

可将创建的参数输出到设置用计算机。

请用于备份用途或复制到其他控制器、移到其他设置用计算机等。

请从工具NO.画面的“Parameter”选项卡单击[Output],保存参数文件。

请勿对输出的参数文件进行编辑。

否则可能无法正常读取。

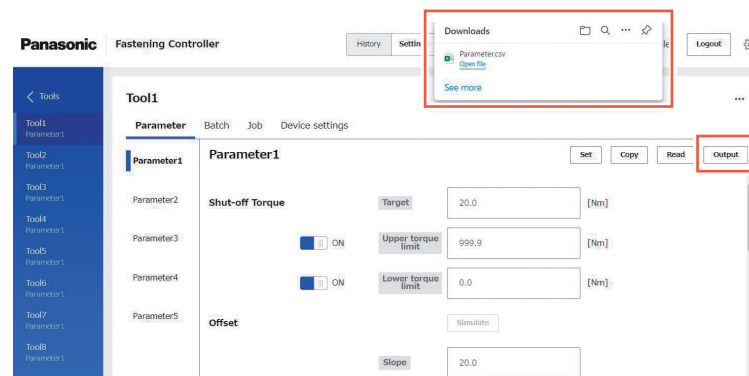

设置工具的紧固参数 (续)

注册参数

利用控制器的动作模式“Free mode”进行控制时,进行注册以指定在工具中使用的参数。
※如果是“Repeat mode”、“External control mode”,则没有影响。

(有关“Free mode”、“Repeat mode”、“External control mode”的详细内容,请确认“设置动作模式”**参见P45**)

请从工具NO.画面的“Parameter”选项卡单击[Set]。

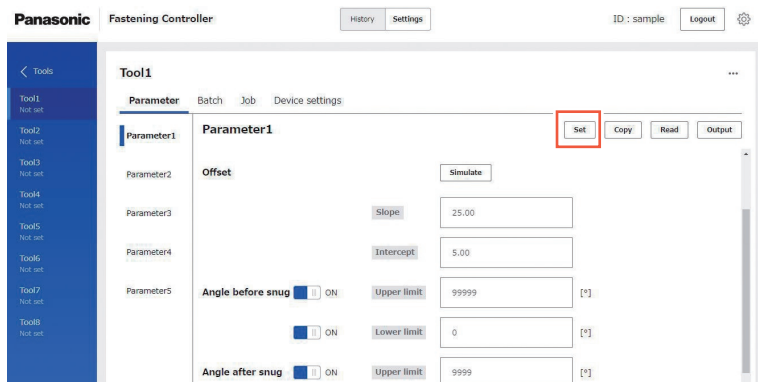

参数项目

设置紧固参数的项目。

详细内容请参见工具主体的使用说明书。

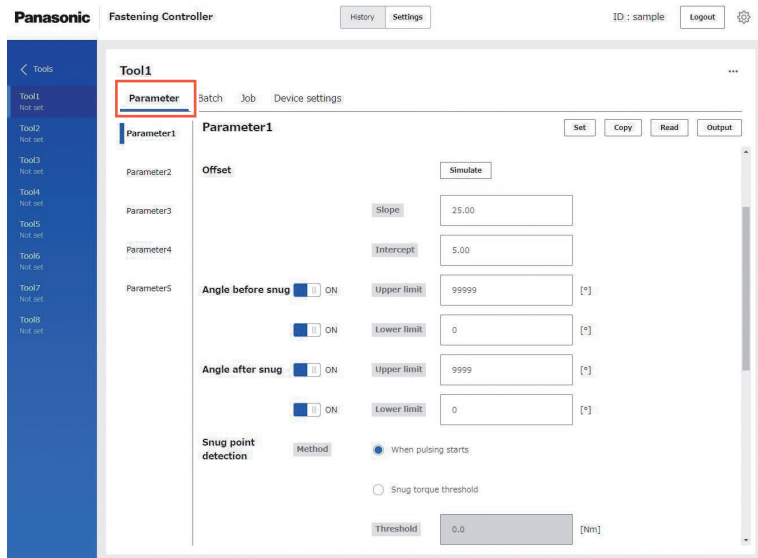

■ 设置偏移 (参数设置 参考①)

请设置偏移,使扭矩输出值与实测值一致。

- 1 从工具No.画面的“Parameter”选项卡单击“Offset”项目中的[Simulate]显示“Offset”页。

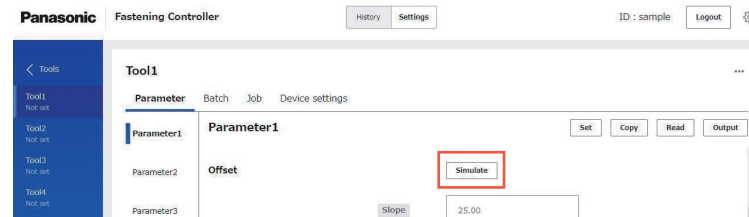

- 2 输入设定值后,单击[Apply]

请输入“Socket length”“Shut-off Torque”。单击[Apply]后,输入的设定值被发送到工具。工具变为偏移模式(T2标识)。

- 3 用工具执行实际的作业后,单击[Get data]

紧固履历数据被添加到“Offset”页的履历列表中。
※[Get data]后,工具变为可紧固状态(“C模式”),但在偏移设置完成之前,请勿进行正常的紧固作业。

- 4 选中已获取的紧固履历数据中的相应行,输入实测扭矩(紧固)值,单击[Calculate]

自动计算修正工具输出扭矩和实测扭矩的偏移值。

- 5 确认偏移值更新后,单击[Apply]

调整的设定值被发送到工具。

- 6 重复步骤3~5,直至差值变得极小

※请将95%~105%范围内的%显示作为基准。

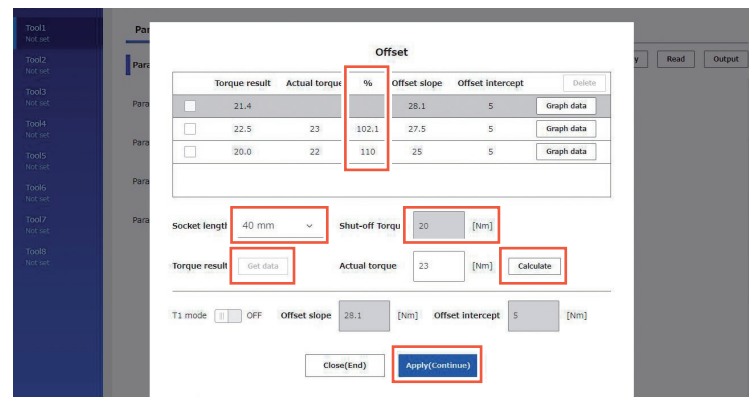

设置工具的紧固参数 (续)

【最小输出模式】

勾选偏移设置画面中的[T1 mode],主体在最小输出模式下动作。
(解除勾选[T1 mode]后,主体将返回到“Offset Mode”)



T1 mode

【功能概要】

目标扭矩接近主体的扭矩控制功能运转范围下限时,可确认是否可进行扭矩控制。该模式下的主体以最低打击数(最小输出)关机。

此时,不会记录作业履历。

在该模式作业后,使用扭矩测量仪或扭力扳手确认主体输出的扭矩是否低于目标扭矩。

对于超过扭矩的作业,在该模式下可能无法使用主体。

※偏移设置中,其他工具会暂时无法进行紧固动作。

■ 进行着座设置(参数设置 参考②)

可根据波形数据进行着座设置。

1 从工具 No. 画面的“Parameter”选项卡单击“Snug point detection”项目的[Select from graph]

- 显示“Snug point detection”画面,在画面上显示对象工具的最新波形数据。
- 需要参照的紧固履历数据。请至少进行1次紧固作业后再设置。
- 用于设置的图表可从图表切换(①)进行更改。

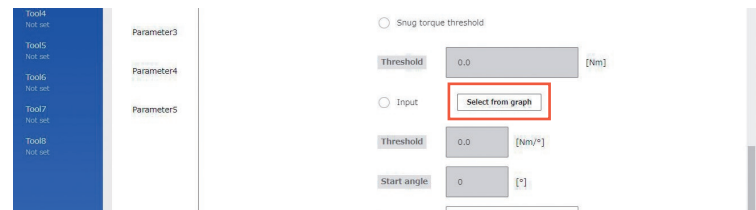

2 从图表选择

- 有一个显示整个图表的主窗口(②)和放大图表任意部分的副窗口(③)。
- 主窗口的显示范围可通过在图表下方的“X-axis”(④)中输入显示开始和结束角度进行更改。
- 移动竖线,可设置着座判定开始角度(⑤)。
- 副窗口的显示范围可通过移动主窗口的选择框(⑥)更改。
- 请从副窗口(③)选择阈值进行设置。

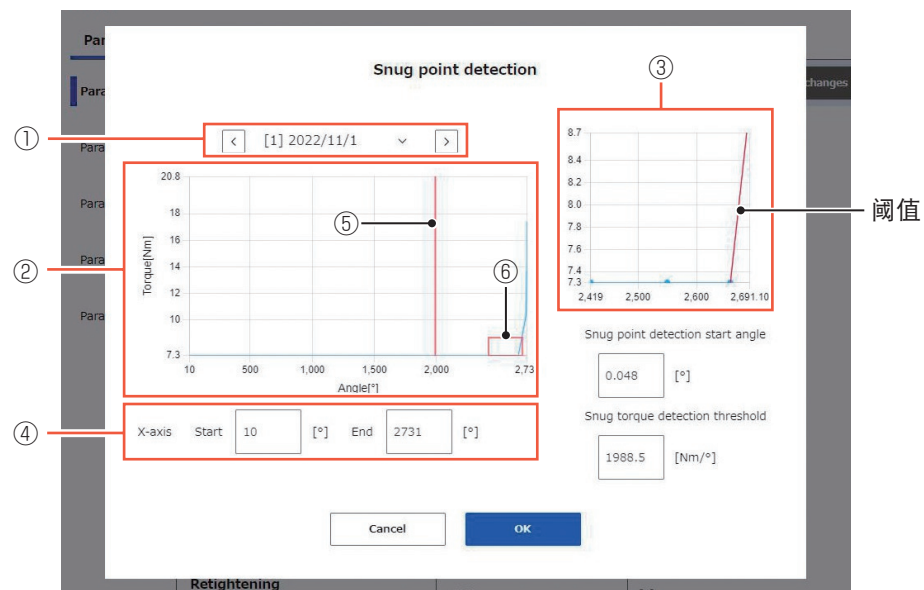

设置紧固控制模式

工具的紧固控制

利用控制器可对最多8台的连接工具进行紧固控制。
另外,还会按每个紧固作业接收紧固数据,对紧固数量进行计数。

连接台数:最多8台



紧固控制模式的概要

紧固控制在多种模式下进行。各模式的概要请参见以下内容。

模式	[Free mode]	[Repeat mode]																						
		[Basic mode]	[Sequence mode]																					
OK判定基准	— (无数量管理)	紧固数量完成	按指定的顺序,多个工具分别完成紧固数量																					
[Batch] “单一设定值” (相同条件紧固) ※单一工件	<table border="1"> <tr> <th>设定值</th> <th>紧固数量</th> </tr> <tr> <td>10 Nm</td> <td>∞</td> </tr> </table> <p>Parameter</p>	设定值	紧固数量	10 Nm	∞	<table border="1"> <tr> <th>设定值</th> <th>紧固数量</th> </tr> <tr> <td>10 Nm</td> <td>10个</td> </tr> </table> <p>Batch</p>	设定值	紧固数量	10 Nm	10个	<table border="1"> <tr> <th>设定值</th> <th>紧固数量</th> </tr> <tr> <td>10 Nm</td> <td>10个</td> </tr> </table> <table border="1"> <tr> <th>设定值</th> <th>紧固数量</th> </tr> <tr> <td>20 Nm</td> <td>5个</td> </tr> </table> <p>Batch×Sequence</p>	设定值	紧固数量	10 Nm	10个	设定值	紧固数量	20 Nm	5个					
设定值	紧固数量																							
10 Nm	∞																							
设定值	紧固数量																							
10 Nm	10个																							
设定值	紧固数量																							
10 Nm	10个																							
设定值	紧固数量																							
20 Nm	5个																							
[Job] “多个设定值” (不同条件紧固) ※多个工件	<table border="1"> <tr> <th>设定值</th> <th>紧固数量</th> </tr> <tr> <td>10 Nm</td> <td>2个</td> </tr> <tr> <td>20 Nm</td> <td>3个</td> </tr> <tr> <td>30 Nm</td> <td>5个</td> </tr> </table> <p>Job</p>	设定值	紧固数量	10 Nm	2个	20 Nm	3个	30 Nm	5个	<table border="1"> <tr> <th>设定值</th> <th>紧固数量</th> </tr> <tr> <td>10 Nm</td> <td>2个</td> </tr> <tr> <td>20 Nm</td> <td>3个</td> </tr> <tr> <td>30 Nm</td> <td>5个</td> </tr> </table> <table border="1"> <tr> <th>设定值</th> <th>紧固数量</th> </tr> <tr> <td>20 Nm</td> <td>5个</td> </tr> <tr> <td>30 Nm</td> <td>10个</td> </tr> </table> <p>Job×Sequence</p>	设定值	紧固数量	10 Nm	2个	20 Nm	3个	30 Nm	5个	设定值	紧固数量	20 Nm	5个	30 Nm	10个
设定值	紧固数量																							
10 Nm	2个																							
20 Nm	3个																							
30 Nm	5个																							
设定值	紧固数量																							
10 Nm	2个																							
20 Nm	3个																							
30 Nm	5个																							
设定值	紧固数量																							
20 Nm	5个																							
30 Nm	10个																							
备注	—	※任务最多到10个步骤	※时序最多可设置10步																					

可注册件数

控制器中可注册的控制模式数如下所示。

控制器模式	工具动作设置	可注册件数
Free mode	Parameter	○ 每台工具最多可注册 5 种
Repeat mode	Basic mode (独立控制)	○ 每台工具最多可注册 5 种
		○ 每台工具最多可注册 5 种
	Sequence mode (顺序控制)	○ 最多可注册 5 种
External control mode	—	○

设置动作模式

控制器的动作模式可按以下步骤设置。

- 1 单击Home画面(设置画面初始页面)上部的[Settings],然后选择“Basic settings”选项卡
- 2 从“Basic settings”选项卡单击[Change running mode]显示“Change running mode”画面。

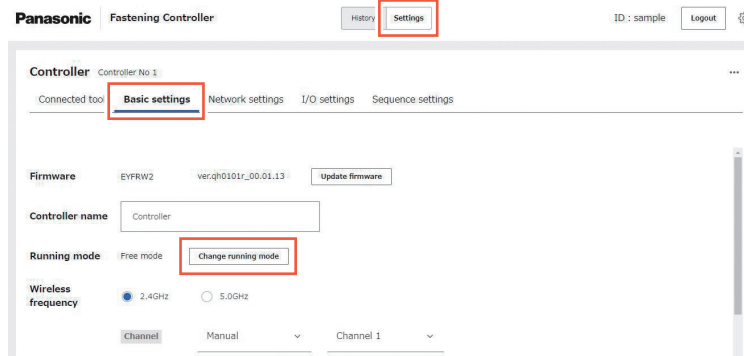

- 3 选择“Running mode”,单击[OK]设置动作模式。
动作模式可从“Free mode”“Repeat mode”“External control mode”中选择。另外,可在设置“Repeat mode”时选择“Basic mode”、“Sequence mode”。

参见 P46 ~ 49

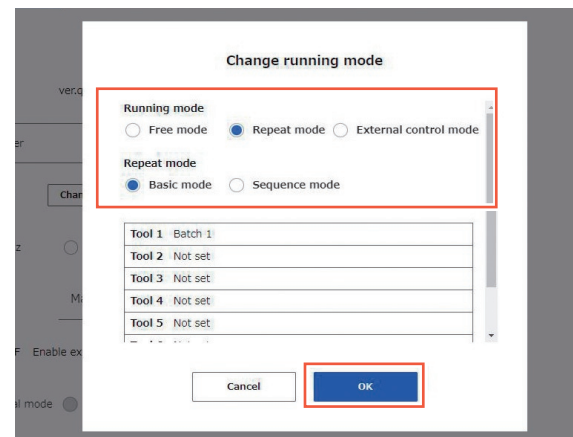

※设置为“Free mode”时,需要事先注册“Parameter”。
※设置为“Repeat mode”时,需要事先注册“Batch/Job”。

设置紧固控制模式 (续)

Free mode

无需管理紧固数量,可自由紧固的模式。
各工具按事先注册的“Parameter”进行紧固。
最多8台工具可单独紧固。
基于I/O的输出设置启用。
※可在用外部设备对紧固数量进行计数时使用。

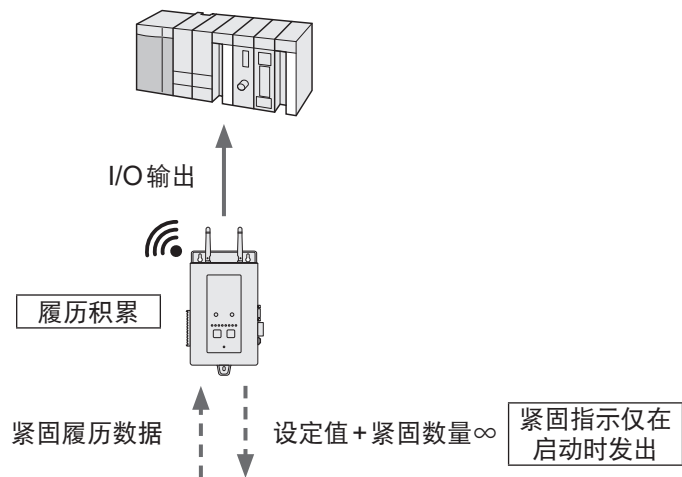

设定值 紧固数量	设定值 紧固数量	设定值 紧固数量	设定值 紧固数量
10 Nm ∞	20 Nm ∞	30 Nm ∞	40 Nm ∞

最多可同时使用8台

设定值 紧固数量	设定值 紧固数量	设定值 紧固数量	设定值 紧固数量
50 Nm ∞	60 Nm ∞	70 Nm ∞	80 Nm ∞

Repeat mode (Basic mode)

重复控制“Batch”“Job”的模式。
各工具按照事先注册的“Batch”或“Job”进行紧固。
最多8台工具可单独紧固。
基于I/O的输出设置启用。

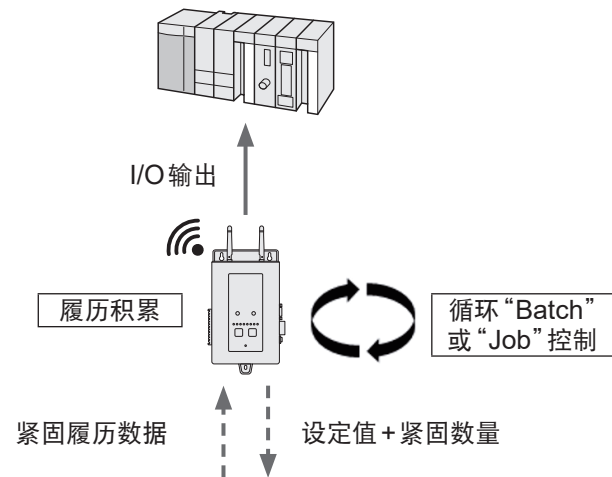

设定值 紧固数量	设定值 紧固数量	设定值 紧固数量	设定值 紧固数量
10 Nm 10个	20 Nm 10个	30 Nm 10个	40 Nm 10个

最多可同时使用8台

设定值 紧固数量	设定值 紧固数量	设定值 紧固数量	设定值 紧固数量
50 Nm 10个	60 Nm 10个	70 Nm 10个	80 Nm 10个
60 Nm 5个	70 Nm 5个	80 Nm 5个	90 Nm 5个
70 Nm 5个	80 Nm 5个	90 Nm 5个	10 Nm 5个

设置紧固控制模式 (续)

Repeat mode (Sequence mode)

按顺序控制可使用的工具以重复“Sequence”的模式。
各工具根据事先注册的“Sequence”，按顺序进行紧固。
最多可设置10个步骤。时序内可使用的工具最多为8台，一次只能使用1台。
基于I/O的输出设置启用。

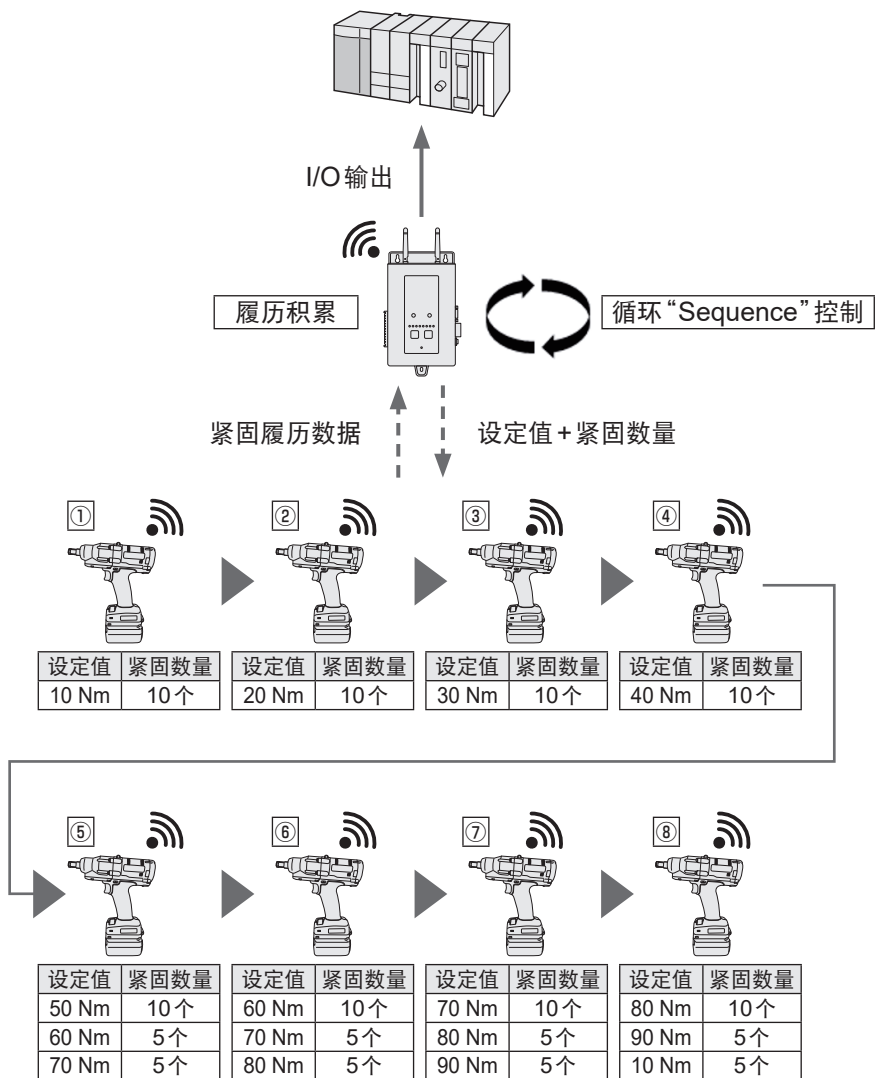

External control mode

根据外部设备(上游系统)发出的指示来控制紧固的模式。
可在以下2种模式下控制。

- **利用 Open Protocol 进行控制 (Open Protocol 启用)**
可根据上游系统发出的 Open Protocol 指示进行紧固控制。
最多可单独控制8台工具。
※不支持任务控制、时序控制。
- **通过 I/O 进行控制 (Open Protocol 禁用)**
可根据来自外部设备的 I/O 输入指示进行紧固控制。
最多可单独或时序控制8台工具。

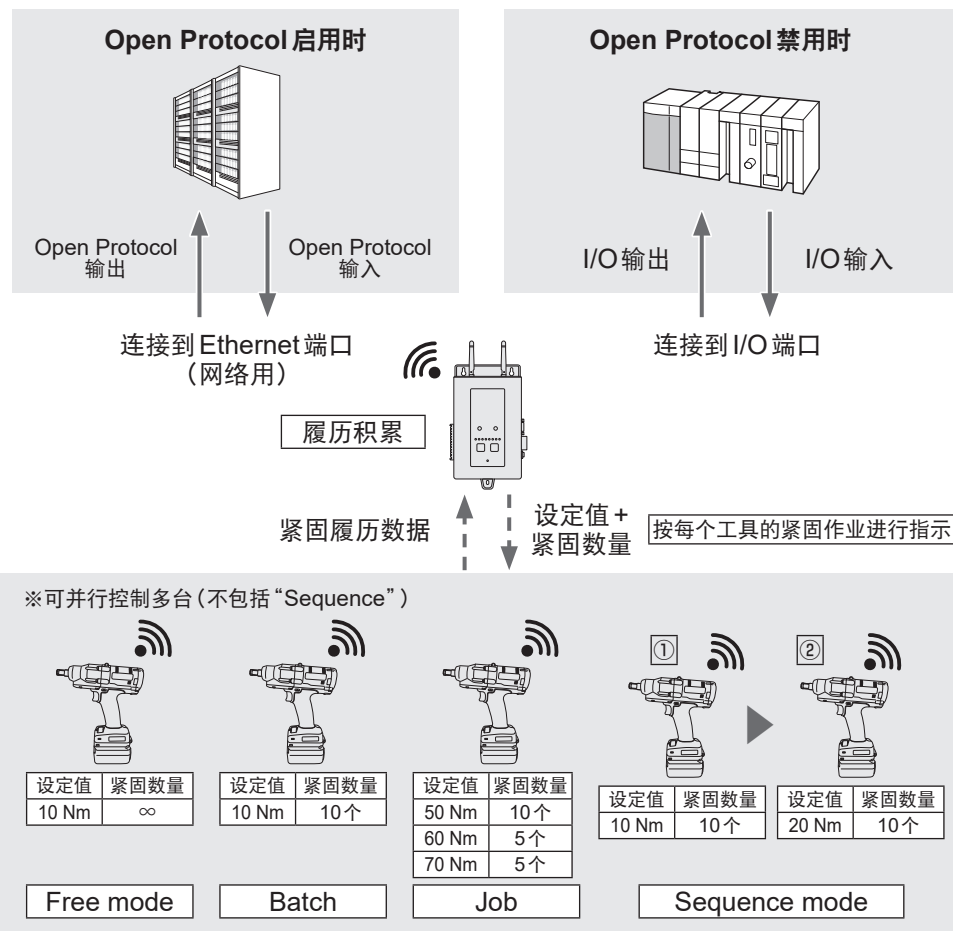

※ 如果在紧固作业中控制器电源关闭,重启后不会重新开始紧固。
要重新接受外部设备发出的指示后再开始作业。
※ 基于 I/O 的输出设置启用。

创建 (设置) 批处理

单击Home画面(设置画面初始页面)上部的[Settings],然后选择“Connected tool”选项卡。在“Connected tool”画面中单击对象工具No.。
 可从工具NO.画面中的“Batch”选项卡进行设置。
 下拉选择“Parameter”,然后设置“Batch size”(紧固数量。最多99个)。进行[Set]后,即可作为“Repeat mode (Basic mode)”时的动作设置。
 ※切换工具时,也可从工具列表选择。
 ※批处理最多可注册5种。

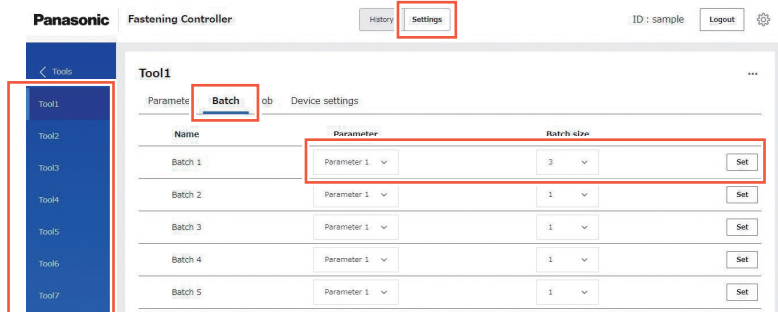

工具列表

创建 (设置) 任务

单击Home画面(设置画面初始页面)上部的[Settings],然后选择“Connected tool”选项卡。在“Connected tool”画面中单击对象工具No.。
 可从工具NO.画面中的“Job”选项卡进行设置。
 下拉选择“Parameter”,然后设置“Batch size”(紧固数量。最多99个)。进行[Set]后,即可作为“Repeat mode (Basic mode)”时的动作设置。
 ※最多可注册10步。
 ※切换工具时,也可从工具列表选择。
 ※任务最多可注册5种。

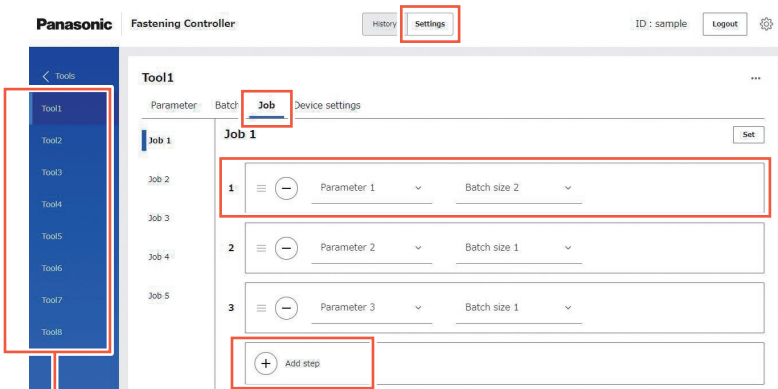

工具列表

创建 (设置) 时序

单击Home画面(设置画面初始页面)上部的[Settings],然后选择“Sequence settings”选项卡。
 在“Sequence settings”画面中,下拉选择“Tool”后,设置“Batch”或“Job”。
 设为[Set as running mode]后,即可作为“Repeat mode (Sequence mode)”时的动作设置。
 ※最多可注册5个时序。
 ※最多可注册10个步。
 ※在同一时序内也可设置使用多次工具。

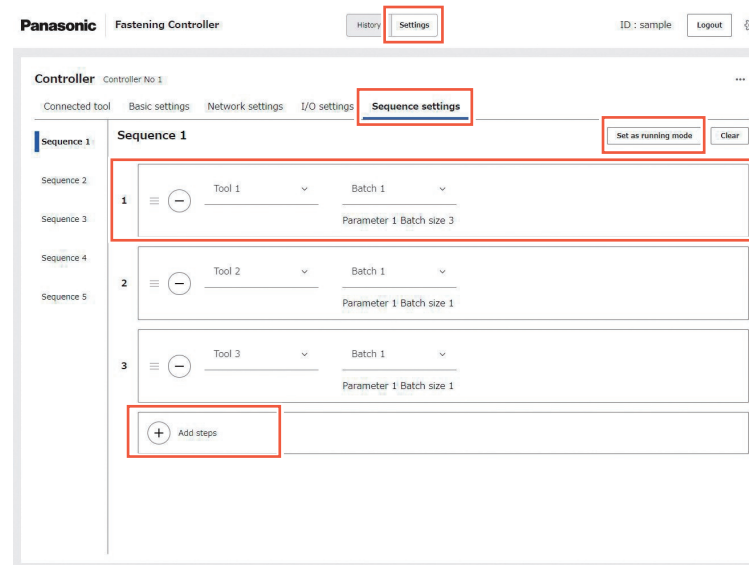

外部设备连接的概要

本产品可与以下外部设备连接。

对象	设置用计算机	PLC	客户上游系统
连接示意图			
通信方式	Ethernet	I/O	Ethernet
通信协议	http/https	— (仅 ON/OFF 信号)	Open Protocol
主要用途	<ul style="list-style-type: none"> 浏览 / 保存紧固履历 更改设置 	<ul style="list-style-type: none"> 输出 OK/NOK 信号 切换紧固指示 	<ul style="list-style-type: none"> 输出紧固履历 切换紧固指示
可输出数据	<ul style="list-style-type: none"> 工具串行 时间 OK/NOK 扭矩值、角度值、紧固时间 波形数据 	<ul style="list-style-type: none"> OK/NOK Batch/job/sequence 完成 Batch/job/sequence 选择中 工具运转中 	<ul style="list-style-type: none"> 工具串行 时间 OK/NOK 扭矩值、角度值、紧固时间 波形数据
支持紧固指示切换	—	<ul style="list-style-type: none"> Batch/job/sequence 选择中 	<ul style="list-style-type: none"> Parameter/batch 选择中
其他	显示使用 Web 浏览器推荐 Microsoft Edge	输入 / 输出各 8 端口	关于对应命令, 请参见“Open Protocol 支持命令一览”。 参见 P61 控制时序请单独确认。

远程连接设置用计算机

可从安装有证书的设置用计算机经由网络远程连接控制器。但仅有 1 个访问可同时访问设置功能。连接时, 请在 Web 浏览器中输入对象控制器的 IP 地址。

参见 P21

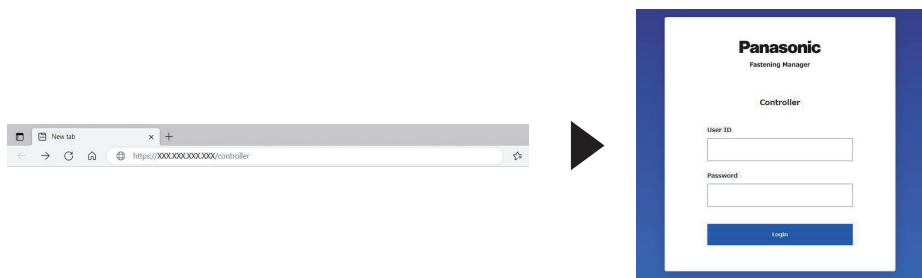

通过 I/O 连接

可分别向 8 个输入端子、8 个输出端子自由分配命令。从“I/O settings”画面进行设置。可分配到各个端口的命令如下。

输入	可选内容	输出	可选内容
1	Batch (工具 1~5) Job (工具 1~5) Sequence (1~5) Batch reset (1~8) Reset Suspend tool (1~8) Suspend controller	1	OK (工具 1~8) NOK (工具 1~8) Batch complete (工具 1~5) Job complete (工具 1~5) Sequence complete (1~5) Tool active (工具 1~8) Batch selected (工具 1~5) Job selected (工具 1~5) Sequence selected (1~5)
2		2	
3		3	
4		4	
5		5	
6		6	
7		7	
8		8	

设置 I/O

单击 Home 画面 (设置画面初始页面) 上部的 [Settings], 然后选择 “I/O settings” 选项卡。

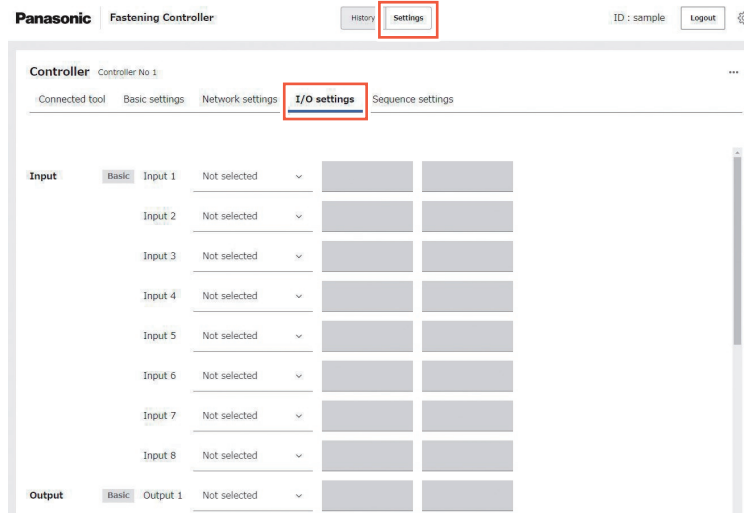

※ 未设置的动作及现象也可自行分配 (不包括任务选择、时序选择)

可分配到输入的命令

可分配到输入 (Input 端口) 的命令如下。
如果外部设备已向各端口输入信号, 将根据分配的命令进行紧固控制。

大项目 (动作)	中项目 (对象工具)	小项目 (批处理 No. 等)
Batch	工具 1-8	1-5
Job	工具 1-8	1-5
Sequence	—	1-5
Suspend tool ※1	工具 1-8	—
Suspend controller ※1	—	—
Batch reset	工具 1-8	—
Reset	—	—

※1 仅在输入信号维持中启用。

“Suspend tool”或“Suspend controller”命令输入中的注意事项

- 不接收“Suspend controller”输入中的紧固指示。
- 不接收和“Suspend tool”输入中工具No.相同的工具No.的“Batch”或“Job”的紧固指示。
- 接收和“Suspend tool”输入中工具No.不同的工具No.的“Batch”或“Job”的紧固指示。
- 接收“Suspend tool”输入中的“Sequence”的紧固指示。
此时, 会一直进行控制, 直至“Suspend tool”输入中的工具符合为止。
- “Batch reset”和“Reset”也和紧固指示一样处理。

在大项目中选择动作后, 选择对象工具, 如果还需要, 选择 No. (批处理 No. 等)。



※如果输入未注册的信号, 将不反应。(不出现错误)

可分配到输出的命令

可分配到输出 (Output 端口) 的命令如下。
发生对象现象时, 按分配的命令, 从各端口将输出信号输出到外部设备。

大项目 (现象)	中项目 (对象工具)	小项目 (批处理 No. 等)
OK	工具 1-8	—
NOK	工具 1-8	—
Batch complete	工具 1-8	1-5
Job complete	工具 1-8	1-5
Sequence complete	—	1-5
Tool active	工具 1-8	—
Batch selected	工具 1-8	1-5
Job selected	工具 1-8	1-5
Sequence selected	—	1-5

在大项目中选择现象后, 选择对象工具, 如果还需要, 选择 No. (批处理 No. 等)。

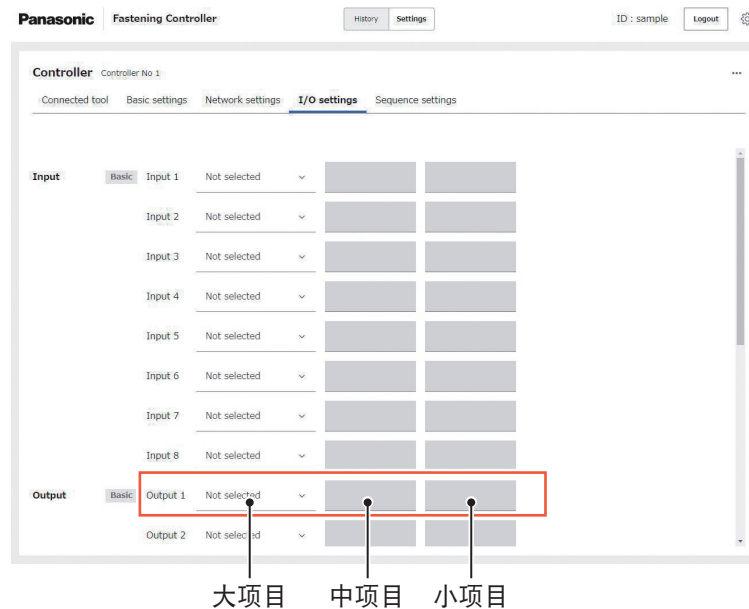

※如果在输出命令中切断控制器的电源, 在恢复供电后将不能从中途重新开始。(但会保存紧固履历数据)

其他设置

其他与 I/O 相关的设置可按以下设置。

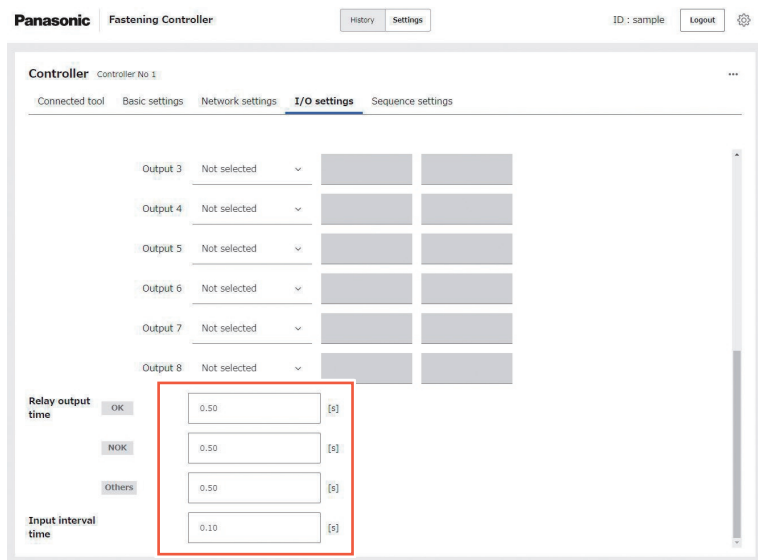

Relay output time (OK)

选择从继电器输出紧固 OK 信号的时间 (期间)。

[默认值] 0.5 s

[设置范围] 0.01 s ~ 10 s

Relay output time (NOK)

选择从继电器输出紧固 NOK 信号的时间 (期间)。

[默认值] 0.5 s

[设置范围] 0.01 s ~ 10 s

Relay output time (Others)

选择从继电器输出紧固 OK/NOK 以外信号的时间 (期间)。

[默认值] 0.5 s

[设置范围] 0.01 s ~ 10 s

Input interval time

选择不对连续的输入信号进行计数 (不受理) 的时间。
用于防止因干扰等造成重复计数的设置。

[默认值] 0.1 s

[设置范围] 0.01 s ~ 10 s

通过 Open Protocol 通信连接

单击 Home 画面 (设置画面初始页面) 上部的 [Settings], 然后选择 “Network settings” 选项卡。

将 “Atlas Open Protocol” 设为 “Enable”。
对要使用的工具分别设置端口 No.。

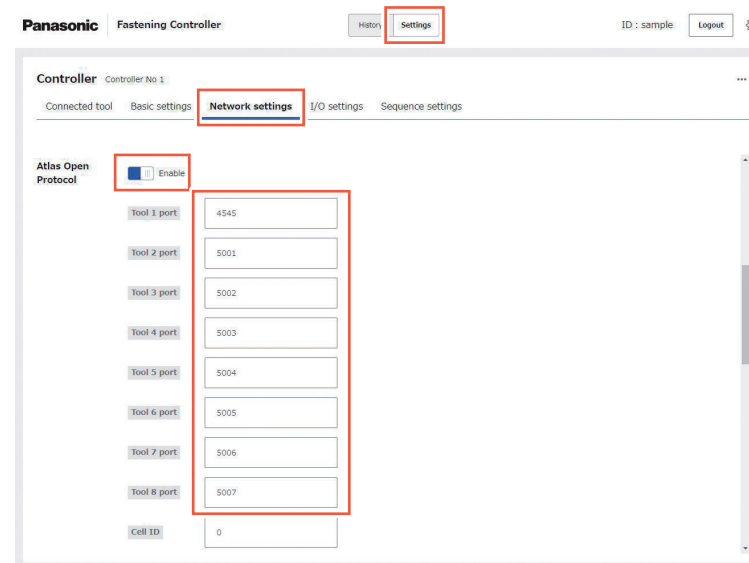

Tool port

将通过 Open Protocol 进行通信的端口 No. 按工具进行分配。

[默认值] (Tool 1) 4545

(Tool 2-8) 5001 - 5007

[设置范围] (Tool 1-8) 1024 ~ 49151

其他设置项目

根据需要设置其他的设置项目。

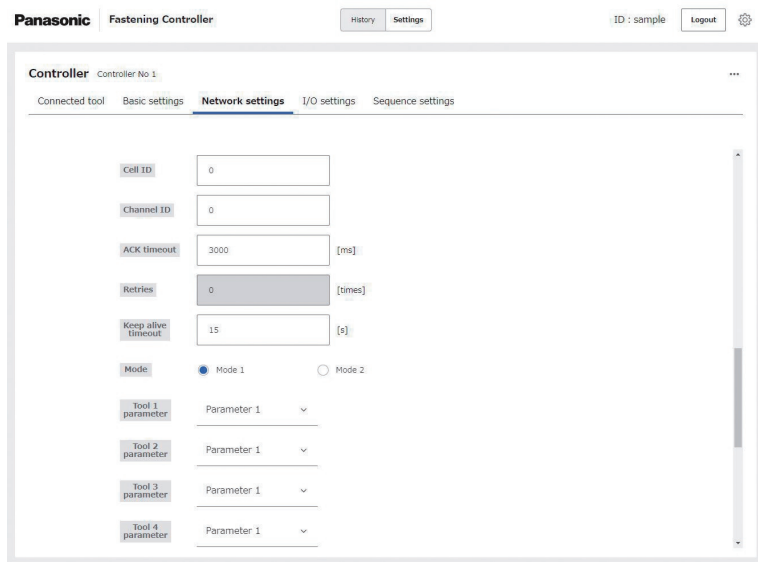

Cell ID

设置单元格 ID。

[默认值] 0

[设置范围] 0~9999

Channel ID

设置通道 ID。

[默认值] 0

[设置范围] 0~99

ACK timeout

设置对来自控制器发出的请求信息发送的响应等待超时时间。

[默认值] 3000 ms

[设置范围] 100 ms~30000 ms

Retries

设置重新发送来自控制器的请求信息的次数。

[默认值] 0 times

[设置范围] 不可更改(固定)

Keep alive timeout

设置与上游系统的最后通信起至判断通信中断的时间。

[默认值] 15 s

[设置范围] 1 s~60 s

Mode

设置动作模式。

Mode 1:按照预先注册的紧固参数进行自由紧固的模式

Mode 2:按照上游指示的紧固参数进行紧固的模式

[默认值] Mode 1

[设置范围] Mode 1 / Mode 2

分配紧固参数 (Mode 1 时)

以“Mode 1”(无参数指示)使用时,需要预先针对各工具注册紧固参数。请从下方中选择以下拉方式使用的参数。

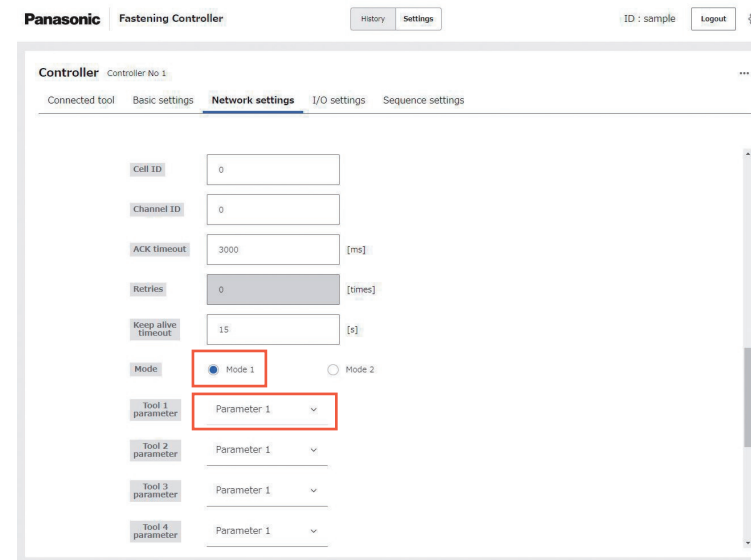

分配紧固参数 (Mode 2 时)

可利用 MID 0018 命令从外部设备进行紧固指示。
紧固指示中可分配“Parameter”或“Batch”。

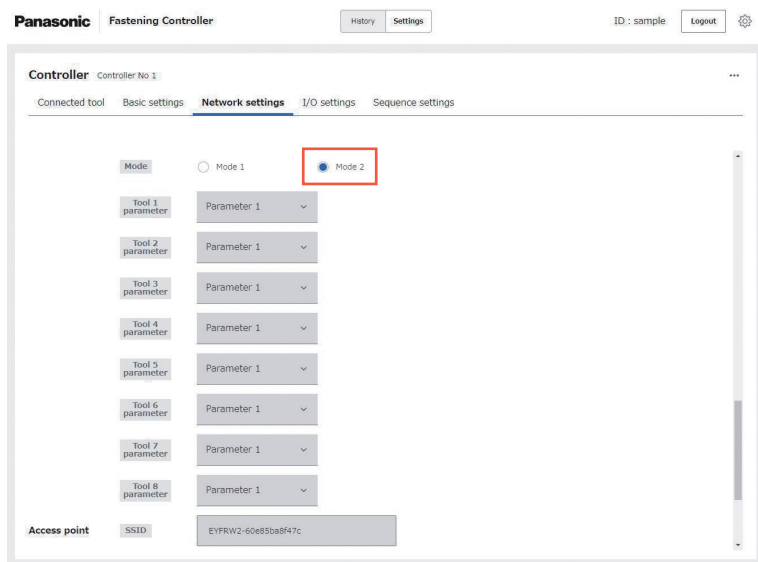

在紧固指示中指定“Parameter”时

请将 ID 的第 100 位设为 0。
10 位和 1 位表示参数编号。

示例：参数 1 的 ID 为“001”
参数 5 的 ID 为“005”

在紧固指示中指定“Batch”时

请将 ID 的第 100 位设为 1。
10 位和 1 位表示批处理编号。

示例：批处理 1 的 ID 为“101”
批处理 5 的 ID 为“105”

※“Job”和“Sequence”不可分配。

Open Protocol 支持命令一览

本产品支持以下命令。
有关各命令的详情,请参见 Open Protocol 规格书 (Open Protocol Specification)。

MID 0001 Application communication start 支持 Revision1。 [内容] 通信开始
MID 0002 Application communication start acknowledge 支持 Revision1。 [内容] 通信响应
MID 0004 Application command error 支持 Revision1。 [内容] 命令错误
MID 0005 Application command accepted 支持 Revision1。 [内容] 命令接收
MID 0018 Select parameter set, Dynamic Job included 支持 Revision1。 分配方法请参见“分配紧固参数 (Mode 2 时)”。 参见 P60 [内容] 参数集指示
MID 0042 Disable tool 支持 Revision1。 [内容] 不可使用工具
MID 0043 Enable tool 支持 Revision1。 [内容] 可使用工具
MID 0050 Vehicle ID number download request 支持 Revision1。 [内容] 车辆 ID 获取请求

MID 0060 Last tightening result data subscribe
支持 Revision1-2。 [内容] 最终紧固结果数据注册
MID 0061 Last tightening result data
支持 Revision1-2。 [内容] 紧固结果上传
MID 0062 Last tightening result data acknowledge
支持 Revision1-2。 [内容] 紧固结果上传响应
MID 9999 Keep alive message
支持 Revision1。 [内容] 生存确认

操作

可不使用控制器内置的接入点,而使用外部接入点和工具进行无线通信。
 可不受控制器安装场所的限制使用工具。
 接入点和控制器请用有线 LAN 连接。
 ※无线通信距离、通信性能根据使用的接入点而异。

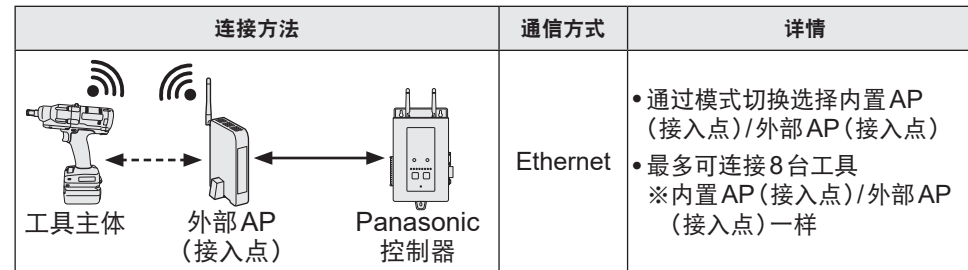

设置方法

- 单击 Home 画面 (设置画面初始页面) 上部的 [Settings], 然后选择 “Basic settings” 选项卡, 将 “External access point” 设为 “ON”
 ※ “WLAN mode” 设置中 “External access point” 设置为 ON 时不在范围内。

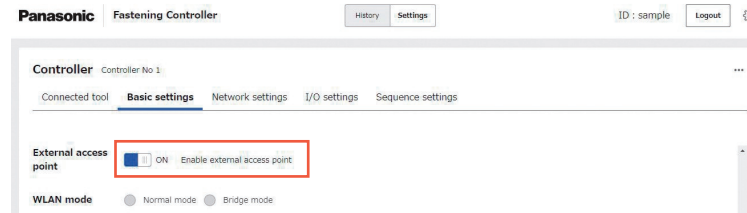

- 单击 Home 画面 (设置画面初始页面) 上部的 [Settings], 然后选择 “Network Settings” 选项卡, 设置 “Network Settings” 画面中 “External access point” 的 “SSID”、“Security”、“Password”
 ※可在控制器中注册的 SSID 仅有 1 种。(无法对每个工具进行设置)
 ※请参见使用的外部 AP (接入点) 使用说明书。
 ※请务必在与工具进行配对注册前设置。
 ※请在配对注册前设置工具 IP 地址。

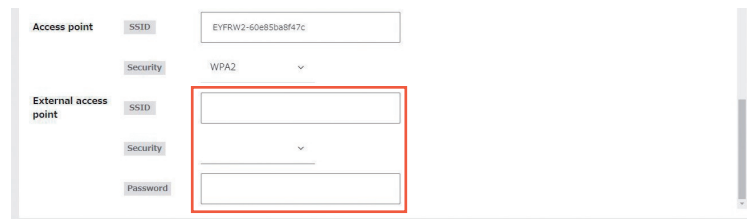

指示灯和蜂鸣器

指示灯和蜂鸣器的规格

通过指示灯和蜂鸣器提醒主体的状态。

注意

开机时指示灯闪烁表示可能需要进行程序初始化,请勿关闭电源开关。

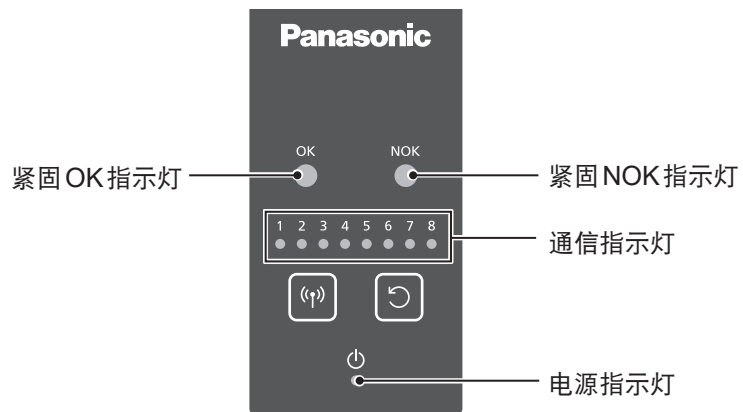

状态	指示灯	蜂鸣器
电源 ON	电源 (黄色) 指示灯亮灯	—
配对 工具选择中	通信 (蓝色) 指示灯慢速闪烁	—
配对 连接中	通信 (蓝色) 指示灯快速闪烁	—
配对完成	通信 (蓝色) 指示灯亮灯	哔 (短音) ■
配对未连接	通信 (蓝色) 指示灯极慢速闪烁	—
配对断开	通信 (蓝色) 指示灯熄灭	—
紧固 OK	OK (绿色) 指示灯亮灯	哔 (短音) ■
紧固 NOK	NOK (红色) 指示灯亮灯	哔 - (长音) ■■
Batch/job 完成	OK (绿色) 指示灯闪烁 2 次	哔哔 (短音) ■■
Sequence 完成	OK (绿色) 指示灯闪烁 3 次	哔哔哔 (短音) ■■■
发生错误	电源 (黄色) 指示灯闪烁	哔 - 哔 - (长音) ■■ ■■

蜂鸣器设置

单击 Home 画面 (设置画面初始页面) 上部的 [Settings], 然后选择 “Basic settings” 选项卡。

可在 “Buzzer” 中设置 “Volume” 和 “Beep”。

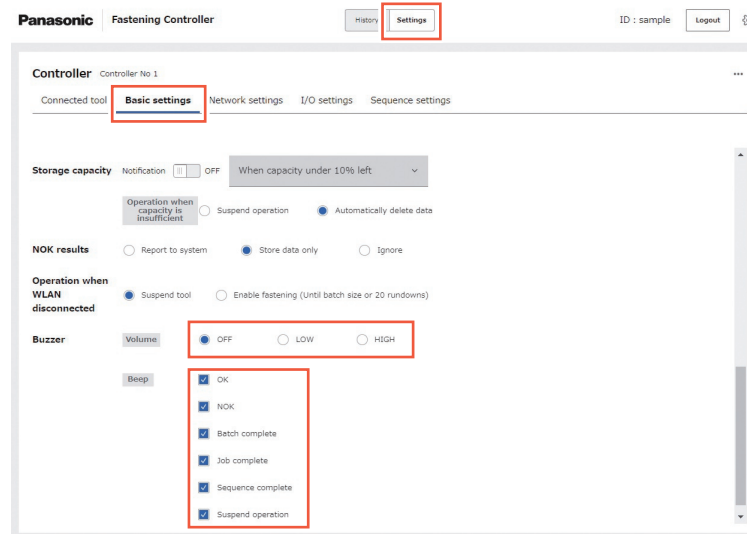

项目	规格
Volume	3 档 (OFF/LOW/HIGH) (LOW: 75 dB、HIGH: 85 dB)
Beep	从设置用计算机选择 (OK/NOK/Batch complete/Job complete/Sequence complete/Suspend operation)

单击 Home 画面 (设置画面初始页面) 上部的 [Settings], 然后选择 “Basic settings” 选项卡。

可从 “Pairing key” 设置和 “Reset key” 设置禁用控制面板的配对键和复位键。

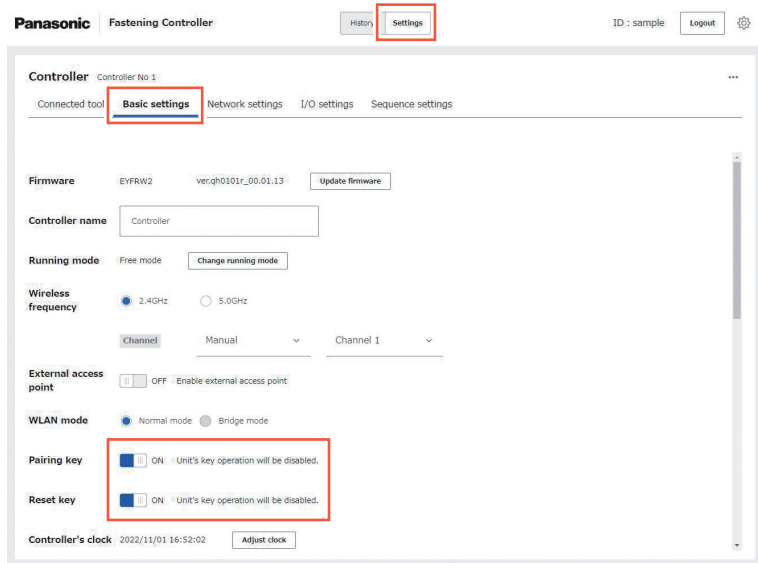

Pairing key

可以切换启用/禁用控制面板的配对键。

[默认值] ON

[设置范围] ON (启用)/OFF (禁用)

Reset key

可以切换启用/禁用控制面板的复位键。

[默认值] ON

[设置范围] ON (启用)/OFF (禁用)

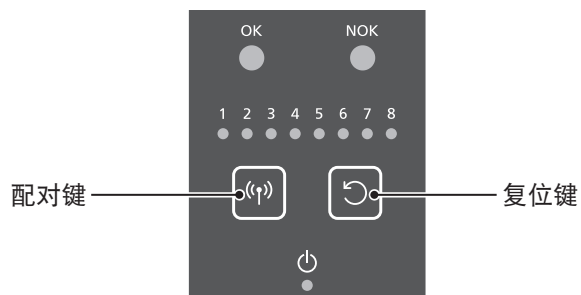

单击 Home 画面 (设置画面初始页面) 上部的 [Settings], 然后选择 “Connected tool” 选项卡。

可确认连接到控制器的工具信息及状态。

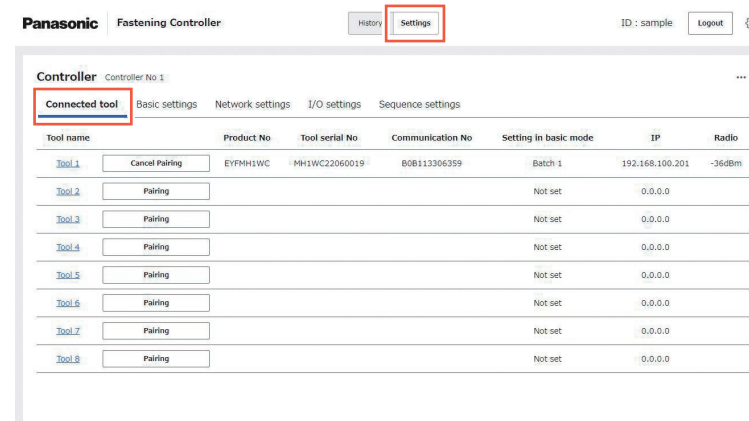

各显示项目如下。

Tool name

显示注册的工具编号 (No.1-8)。

Tool serial No

显示/设置工具的个体识别信息。

默认值为型号识别 5 位 + 制造编号 8 位 (制造年份 2 位 + 月份 2 位 + 生产批次 4 位)。

Product No

显示工具型号。

Communication No

显示工具通信部的个体识别信息 (MAC 地址)。

Setting in basic mode

显示将动作模式设为 “Repeat mode (Basic mode)” 时动作的内容。

IP

显示工具的 IP 地址。

Radio

显示工具发出的电波接受灵敏度 (RSSI)。

※显示最新通信时的数值。

※由于使用外部 AP 时无法测量, 显示为 “0dBm”。

作业显示器功能

单击 Home 画面(设置画面初始页面)上部的 [History], 然后选择“Work monitor”选项卡。
可按每个工具显示最新的紧固履历。请在 一边确认作业结果, 一边在作业等时使用。
※也可从多台设置用计算机同时显示。(最多接入 8 台。帐户相同也可)
※用多个帐户登录时, 建议使用其他终端。
※用同一终端使用多个帐户时, 建议用其他的浏览器软件登录。
※设置更改仅 1 个接入有效。

切换显示形式

可选择“列表显示”和“网格显示”。
可通过画面右上方的显示图标切换。

■ 列表显示

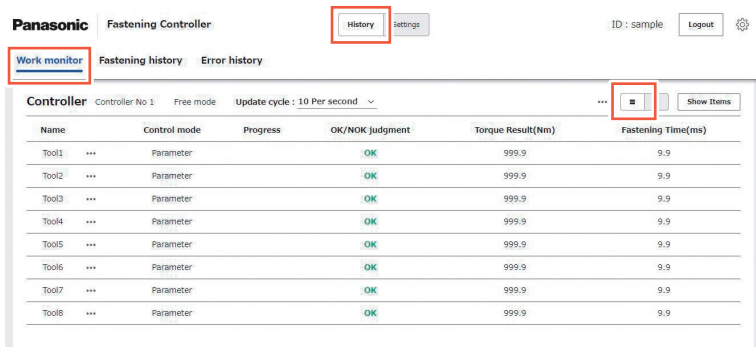

■ 网格显示

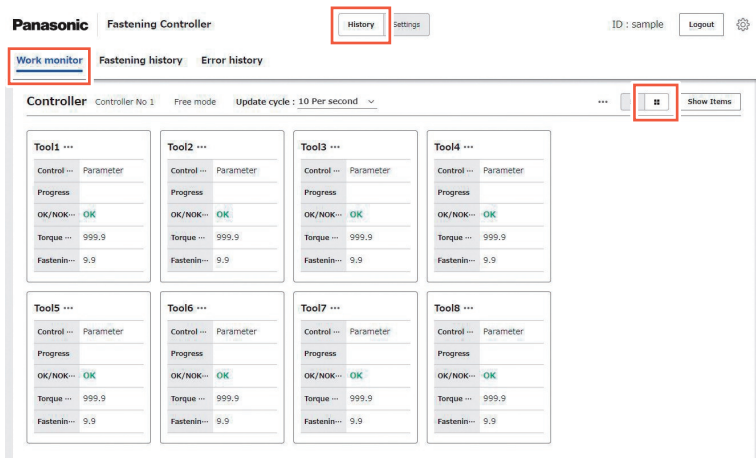

选择显示项目

要显示的项目可从“Show Items”选择。

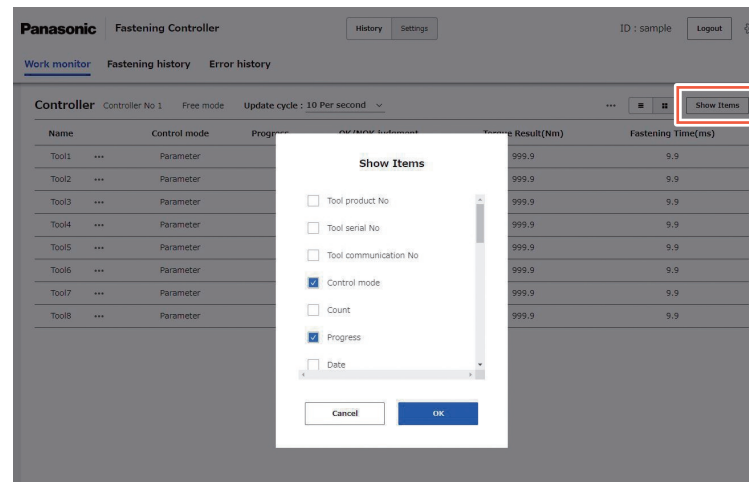

※设置“列表显示”时, 如果显示项目较多, 需要滚动。
※设置“网格显示”时, 最多可显示 5 个项目。

更改画面更新频次

画面可进行自动更新设置。
请从以下“2 Per second”“5 Per second”“10 Per second”中选择更新频次。

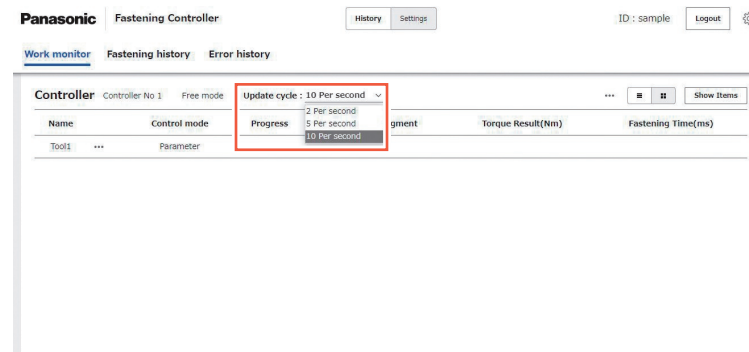

※如果连接工具台数较多, 可连接的设置用计算机较多, 建议将更新频次设置为“10 Per second”。(数据处理可能需要较长时间)

无线通信中断时的工具动作

工具和控制器的无线通信暂时断开时,可允许通过同一参数继续进行紧固作业。

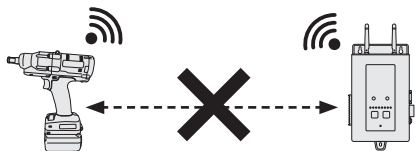

单击Home画面(设置画面初始页面)上部的[Settings],然后选择“Basic settings”选项卡。

将“Operation when WLAN disconnected”设置为“Suspend tool”时,通信断开后,无法在下次紧固中进行紧固。

即使设为“Enable fastening”,达到上限紧固后依旧无法进行紧固。

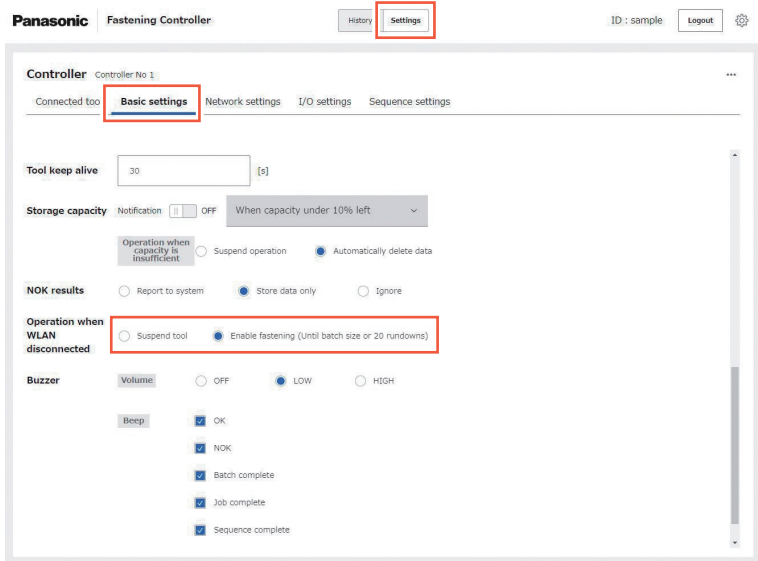

“Enable fastening”时的各模式下的上限紧固数量如下。

模式		动作
Free mode		最多可继续紧固 20 个
Repeat mode	Basic mode	可继续紧固至批处理完成,或最多 20 个
	Sequence mode	可继续紧固至批处理完成,或最多 20 个 ※非对象工具无影响
External control mode		可继续紧固至批处理完成,或最多 20 个

运用中的数量计数复位操作

如果在用控制器进行紧固管理中更改设置,需要先停止紧固管理。设置更改时显示确认对话框。

可用“主体按键操作”和“设置画面操作”2种方式复位数量计数。

※不包括在“Free mode”下的应用。

主体按键操作

请长按控制器主体的复位键 3 秒以上。

※紧固作业中的所有工具计数将被复位。

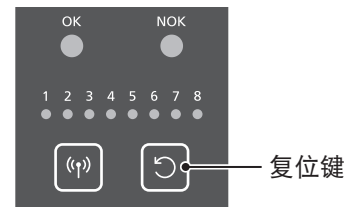

设置画面操作

单击Home画面(设置画面初始页面)上部的[History],然后选择“Work monitor”选项卡。

■ 复位每个工具时

在“Work monitor”画面中,从对象工具 No. 的 ... (工具选项键) 单击 [Batch reset]。

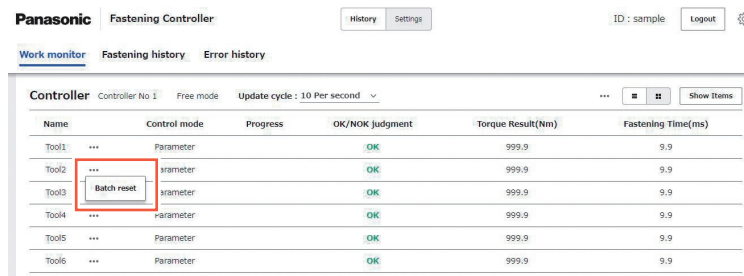

■ 一次性复位所有的工具时

请从“Work monitor”画面右上方的 ... (控制器选项键) 单击 [Reset]。

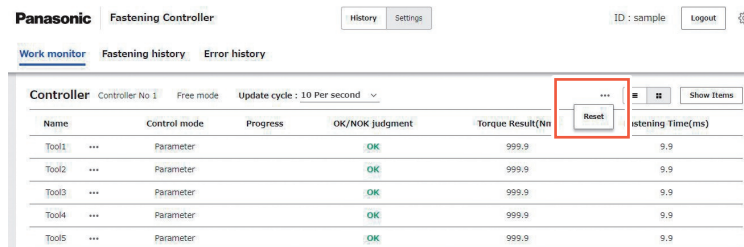

※时序模式时,复位至开头的工具。

操作

确认紧固履历数据

显示紧固履历数据

单击Home画面(设置画面初始页面)上部的[History],然后选择“Fastening history”选项卡。

可浏览从工具发送到控制器的紧固履历数据。

要显示数据时,请从左侧的工具列表选择显示对象控制器/工具,然后单击右上方的[Get data]。

按新的顺序显示紧固履历数据。

※有关紧固履历项目的内容,请参见工具主体的使用说明书。

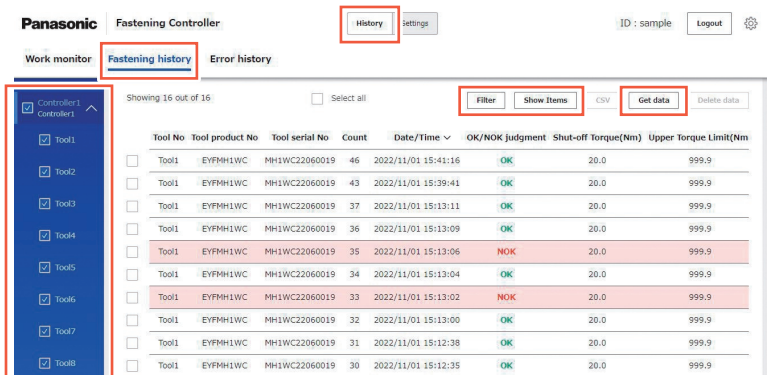

工具列表

按照日期时间提取紧固履历

单击[Filter],输入日期时间,可筛选要显示的紧固履历。

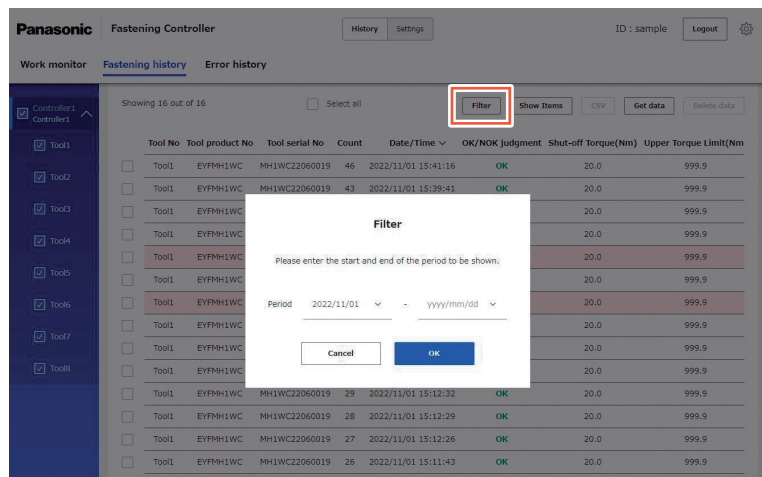

设置显示项目

单击[Show Items],选择项目,可更改要显示的项目。

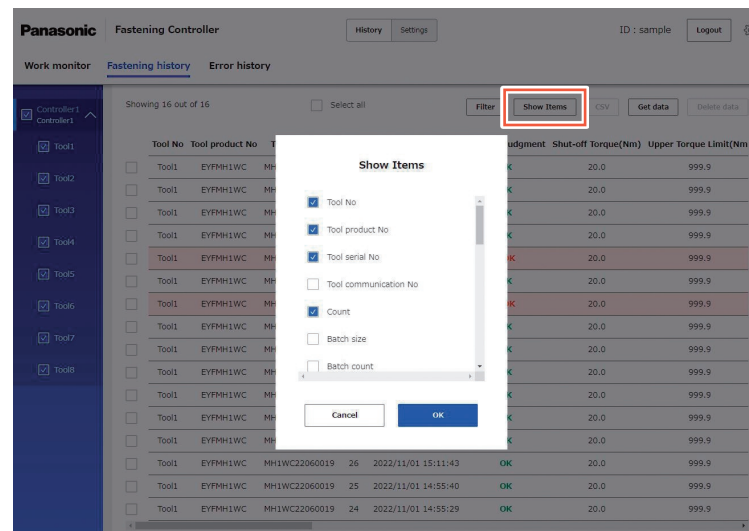

操作

管理紧固履历数据

控制器中可保存的紧固履历数据(包括波形数据)大约为20万条。如果超过该数量,则会根据设置变为“Suspend operation”或“Automatically delete data(覆盖)”。

请根据需要,按以下基准定期输出CSV。

存储器容量达到上限的基准期限

工具台数	每台工具的紧固数量/1日		
	1000条	3000条	5000条
2台	约100日	约33日	约20日
4台	约50日	约16日	约10日
8台	约25日	约8日	约5日

确认紧固履历数据 (续)

输出 CSV 紧固履历数据

单击 Home 画面 (设置画面初始页面) 上部的 [History], 然后选择 “Fastening history” 选项卡。

请在选择对象数据后, 单击 [CSV]。
可用 CSV 格式输出紧固履历数据。

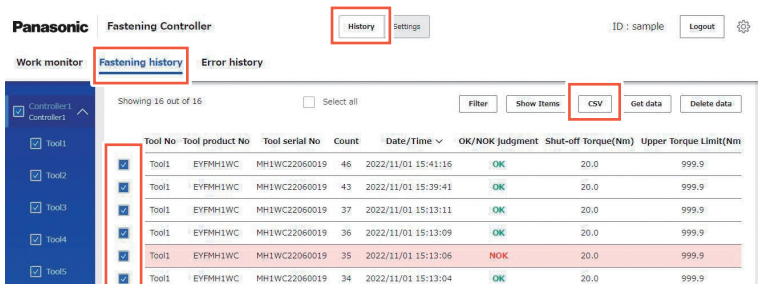

CSV 格式可从 “Decimal point is a period, delimiter is a comma”、 “Decimal point is a comma, delimiter is a semicolon” 中选择。

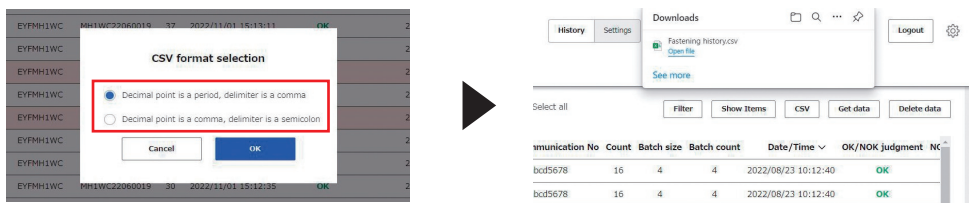

删除紧固履历数据

单击 Home 画面 (设置画面初始页面) 上部的 [History], 然后选择 “Fastening history” 选项卡。

请在选择对象数据后, 单击 [Delete data]。
可删除紧固履历数据。

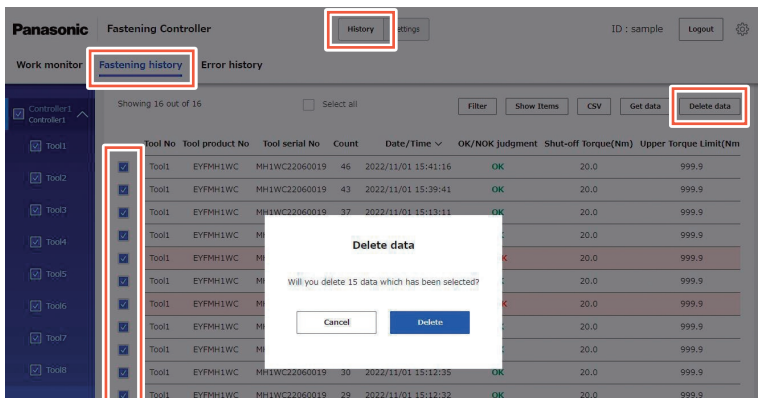

显示波形数据

单击 Home 画面 (设置画面初始页面) 上部的 [History], 然后选择 “Fastening history” 选项卡。

如果设置为保存波形数据, 双击紧固履历中的对象履历时, 将弹出显示每个紧固的波形数据。

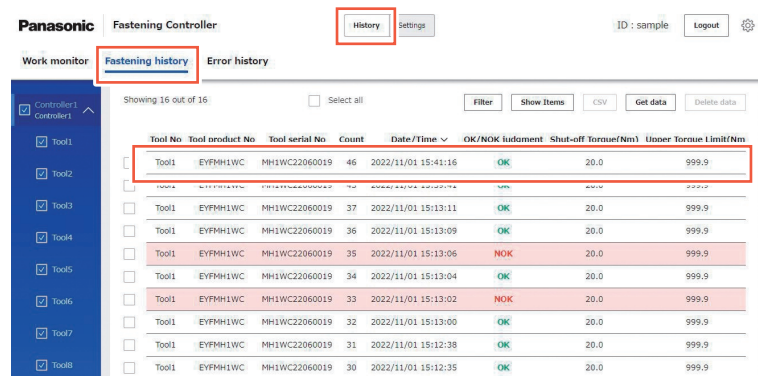

可选择 “X-axis”、“Y-axis”、“Scale” 进行显示。
另外也可单击 [Output], 以 CSV 格式输出。

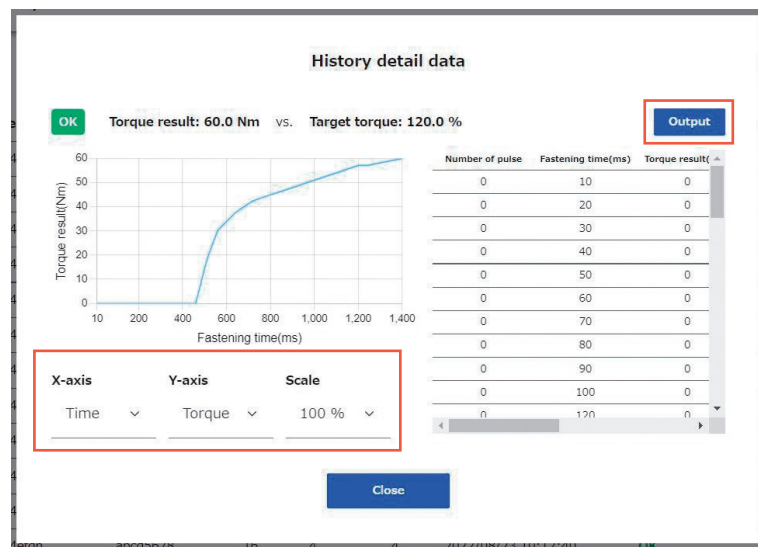

※ 请将 “Device settings” 的 “Graph sending timing” 设置为 “After every fastening”。

操作

显示错误履历

单击Home画面(设置画面初始页面)上部的[History],然后选择“Error history”选项卡。可确认已发生错误的履历。

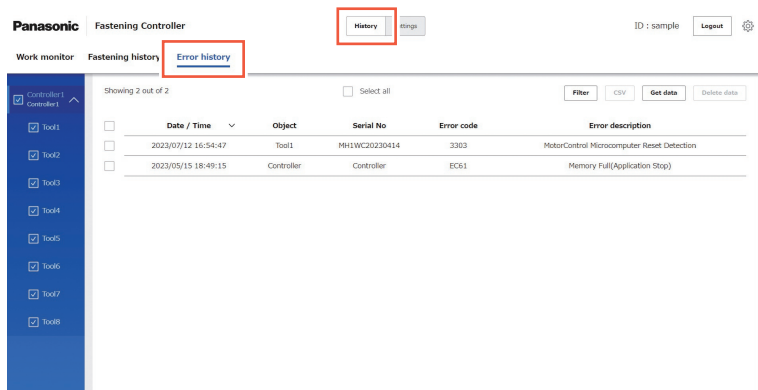

显示项目如下。

※错误代码的内容请参见“错误代码”。 **参见 P90**

Date / Time	显示发生错误的日期/时间。
Object	显示错误的对象(控制器或工具1-8)。
Serial No	显示错误的对象(控制器或工具1-8)识别信息。
Error code	显示发生的错误代码。
Error description	显示发生的错误内容。

更改显示语言

显示语言可从“Japanese”或“English”中选择。

- 1 从Home画面(设置画面初始页面)右上方的选项键中选择“System Settings”
显示“System Settings”画面。

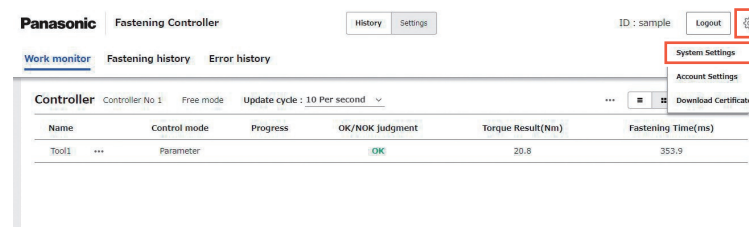

- 2 在“System Settings”画面中选择语言
可从“Japanese”或“English”中选择语言。

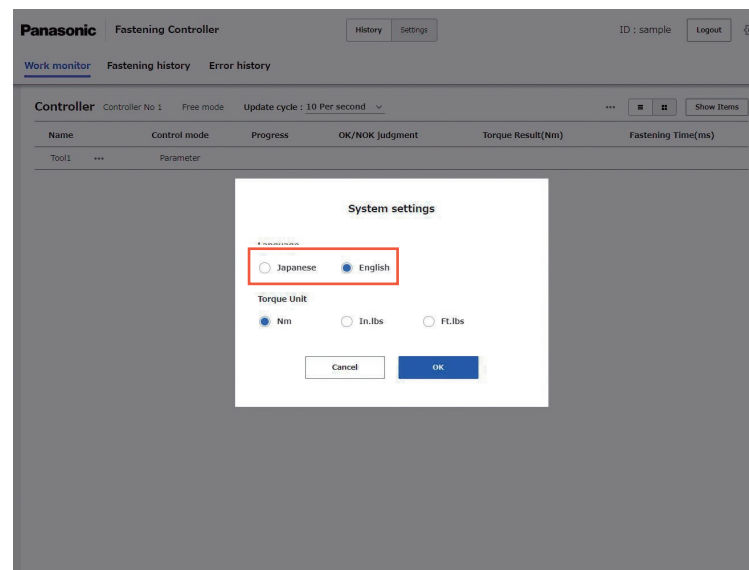

更改显示扭矩单位

可从“Nm”、“In.lbs”、“Ft.lbs”中选择显示扭矩单位。

1 从 Home 画面 (设置画面初始页面) 右上方的选项键中选择“System Settings”

显示“System Settings”画面。

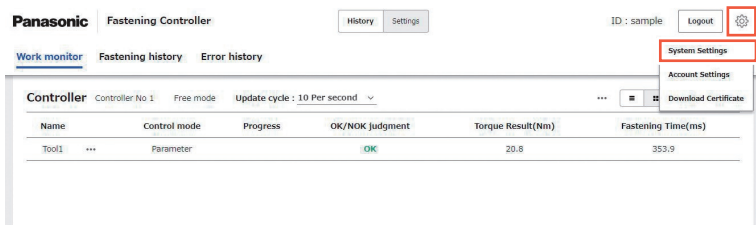

2 在“System Settings”画面中选择“Torque Unit”

可从“Nm”、“In.lbs”、“Ft.lbs”中选择“Torque Unit”。

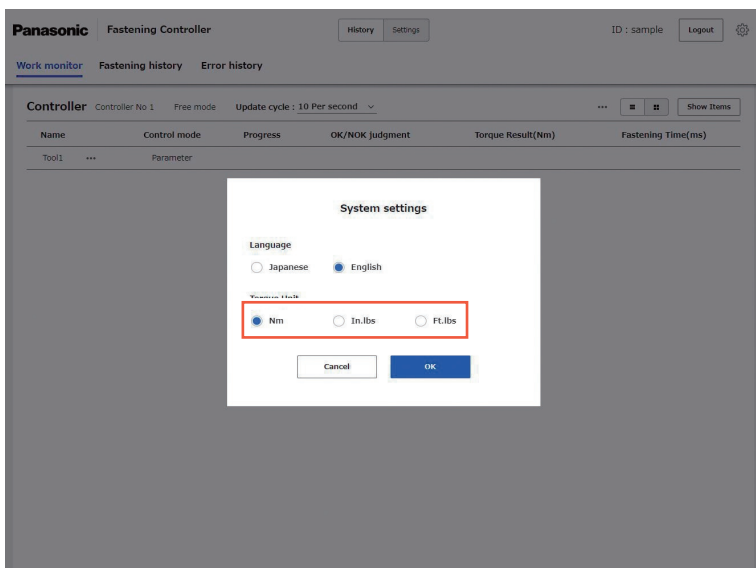

维护方法

用软布擦拭

请勿使用湿布、稀释液、酒精或苯等挥发性物品。(否则会造成变色、变形、开裂)

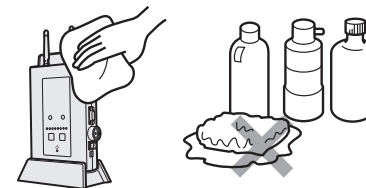

保管方法

请在保管时避免以下条件。

- 车内等高温场所
- 阳光直射场所
- 水或潮湿等较多的场所
- 垃圾及粉尘较多的场所
- 儿童可触及的场所
- 有汽油等引火物的场所
- 有掉落危险的场所

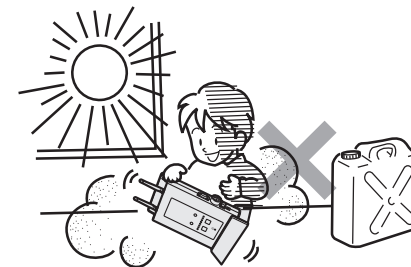

初始化控制器

初始化控制器 (恢复出厂设置) 时, 请同时按住配对键和复位键并保持 10 秒以上。

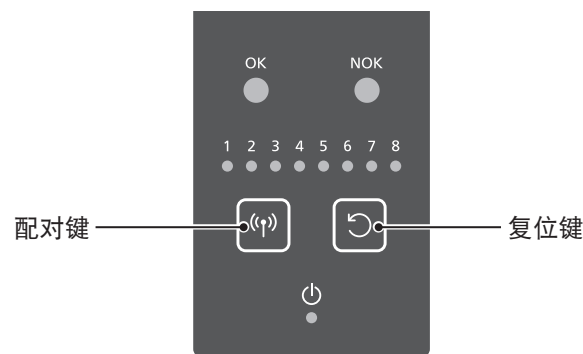

※根据存储使用容量不同, 可能需要 5 分钟以上。

※将主体按键操作设为禁用时, 无法操作。 **参见 P66**

设置备份功能

请单击 Home 画面 (设置画面初始页面) 上部的 [Settings]。
 请从 ... (控制器选项键) 单击 [Backup controller data]。
 可备份控制器的设置内容及工具的设置内容。
 ※ 紧固履历数据不可备份。需要时请输出 CSV。

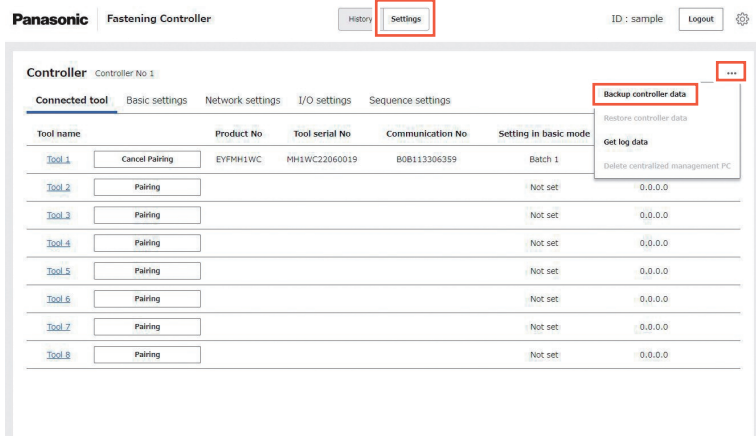

设置的恢复功能

请单击 Home 画面 (设置画面初始页面) 上部的 [Settings]。
 请从 ... (控制器选项键) 单击 [Restore controller data]。
 可从备份恢复控制器的设置内容及工具的设置内容。
 ※ 紧固控制中无法实施。
 ※ 在配对注册工具的状态下无法实施。请设为未注册状态。

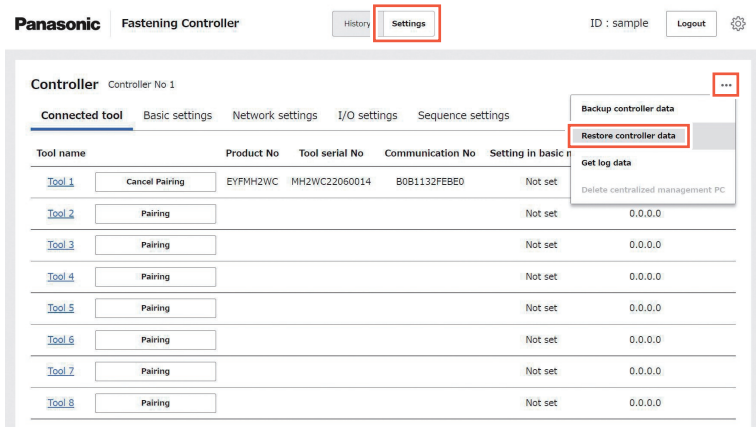

更新固件

可对控制器及工具的通信部进行固件更新。

有 2 种方法可更新固件。

- ① 使用控制器 USB 端口
 - ※ 不可使用带密码锁定功能的 USB。
 - ※ 请在 USB 存储器下保存 1 个固件数据。
- ② 从设置用计算机写入
 - ※ “Upload file” 时, 请在选择画面上选择保存在计算机中的固件数据。

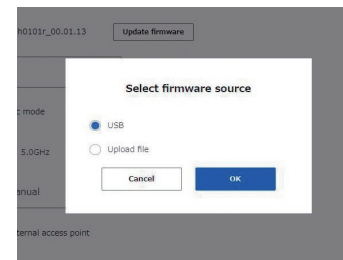

最新固件请确认本公司主页。 **参见 P2**
 或咨询营业负责人。

控制器时

单击 Home 画面 (设置画面初始页面) 上部的 [Settings], 然后从 “Basic settings” 选项卡单击 [Update firmware]。

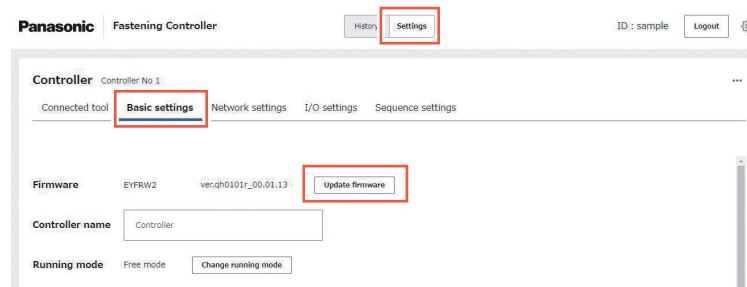

工具通信部时

单击 Home 画面 (设置画面初始页面) 上部的 [Settings], 然后选择 “Connected tool” 选项卡。
 在 “Connected tool” 画面中单击对象工具 No。
 请从工具 No. 画面的 “Device settings” 选项卡单击 [Update firmware]。

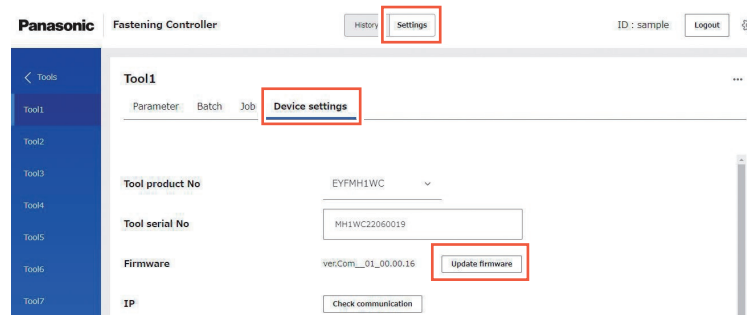

更换纽扣电池

为维持控制器的时钟功能(RTC),请参考以下更换基准期限更换纽扣电池。

■ 电池类型



CR2450

■ 更换基准期限

纽扣电池在电源关闭时用于维持时钟功能。为了减少消耗,建议一般情况下不要关闭电源。

电源每天打开 12 小时 (仅平时)	始终打开电源时
约 3 年	约 8 年

请按以下方法更换,或咨询销售店。
建议安排具备电气知识的人员来进行作业。

1 拆下更换部盖板螺丝(2颗), 然后拆下更换部盖板

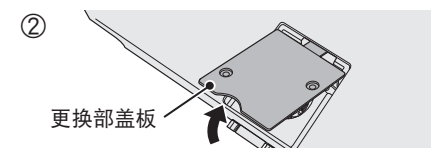
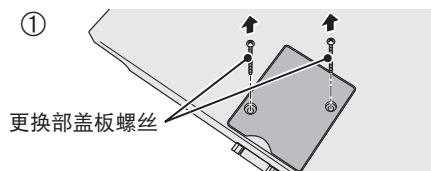

2 使用更换部盖板取出纽扣电池 请在拆下时用更换部盖板的挂钩勾住纽扣电池。

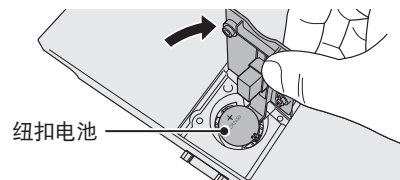

3 安装新纽扣电池,用更换部盖板螺丝(2颗)安装更换部盖板

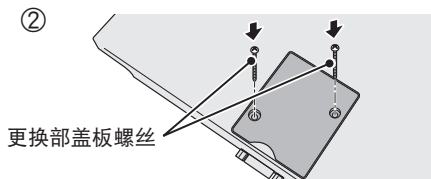
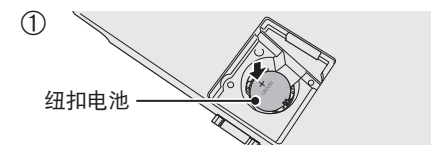

主体规格

接收室内产品组作业中的紧固OK/NOK信号

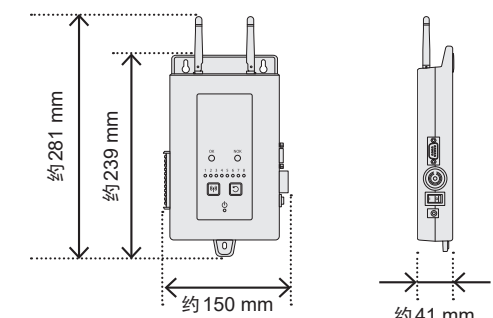
型号	EYFRW2
电源	AC100 V-240 V 50-60 Hz
无线通信标准	无线 LAN (IEEE.802.11 a/b/g/n) n : 仅限 HT20
频带	2.4 GHz 频带: 2.412 GHz~2.472 GHz 5 GHz 频带: 5.180 GHz~5.240 GHz [仅中国和韩国适用] 2.4 GHz 频带: 2.412 GHz~2.462 GHz 5 GHz 频带: 5.180 GHz~5.240 GHz
通道	2.4 GHz 频带: 1~13 通道 5 GHz 频带: 36、40、44、48 通道 [仅中国和韩国适用] 2.4 GHz 频带: 1~11 通道 5 GHz 频带: 36、40、44、48 通道
通信范围	使用 2.4 GHz 时: 约 16 m 使用 5 GHz 时: 约 10 m
可注册工具数	最多 8 台
输入输出端子(I/O)	输入 8 点 输出 8 点
输入端子额定值	DC24 V 50 mA
输出端子额定值	DC30 V 3 A
功率	约 30 W
使用温湿度范围	0 °C~45 °C 20%~90%
大小(大概尺寸) 全长×全高×宽度	约 150×239×41 mm (含天线高度:约 281 mm) 
质量(重量)	约 550 g (仅主体)
通信接口	Ethernet×2、RS232C×1、USB-A×1
保存数据条数	紧固履历 约 200,000 条 (包含波形数据)
适用工具机型	EYFMH1WC、EYFMH2WC

无线规格

每个通道的频率

频带	通道	频率
2.4 GHz 频带	通道 1	2.412 GHz
	通道 2	2.417 GHz
	通道 3	2.422 GHz
	通道 4	2.427 GHz
	通道 5	2.432 GHz
	通道 6	2.437 GHz
	通道 7	2.442 GHz
	通道 8	2.447 GHz
	通道 9	2.452 GHz
	通道 10	2.457 GHz
	通道 11	2.462 GHz
	通道 12	2.467 GHz
5 GHz 频带	通道 36	5.180 GHz
	通道 40	5.200 GHz
	通道 44	5.220 GHz
	通道 48	5.240 GHz

• 通道 12 和 13 不可在中国和韩国使用。

WebUI 规格

支持操作系统	Windows10 以上 (支持以下浏览器的操作系统)
支持浏览器	Microsoft Edge 版本 102 以上 或 Google Chrome 版本 102 以上
支持语言	日语 / 英语
推荐屏幕分辨率	1024 × 768 以上

注意

- 部分计算机即使满足运行环境也无法使用。
- 根据所用计算机的使用环境不同, 本书的说明内容、画面和实际的内容、画面或有差异, 敬请谅解。
- 本书的内容如有更改, 恕不另行通知。
- 禁止擅自转载本书内容的部分或全部。
- 本书中的 Windows 操作说明使用 Windows10 中的步骤及画面。
- 除支持操作系统中所列的操作系统之外, 不可使用“WebUI 功能”。
- 不保证推荐环境中的所有计算机均可正常运行。

■ 操作 (务必阅读)

< 限制事项 >

“WebUI 功能”为 EYFRW2 的设置用软件。

注意

- 使用本功能时, 请注意以下几点。
使用时, 视为同意以下【使用条件】。

【使用条件】

本公司不对本功能进行任何保证。
本公司对使用本功能或动作导致的直接损失、间接损失、波及损失、结果损失或特别损失概不负责。
本公司禁止转载及发布本功能。

触点 I/O 规格

输出继电器和输入端子的分配

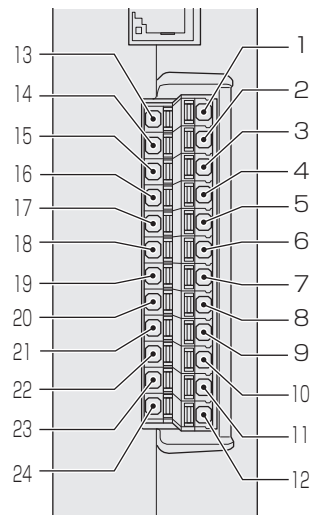

编号	引脚排列	编号	引脚排列
1	+24 V	13	RY1
2	+24 V	14	RY1-RY2 COM
3	IN COM	15	RY2
4	IN 1	16	RY3
5	IN 2	17	RY3-RY4 COM
6	IN 3	18	RY4
7	IN 4	19	RY5
8	IN 5	20	RY5-RY6 COM
9	IN 6	21	RY6
10	IN 7	22	RY7
11	IN 8	23	RY7-RY8 COM
12	24 V return	24	RY8

端子台连接图

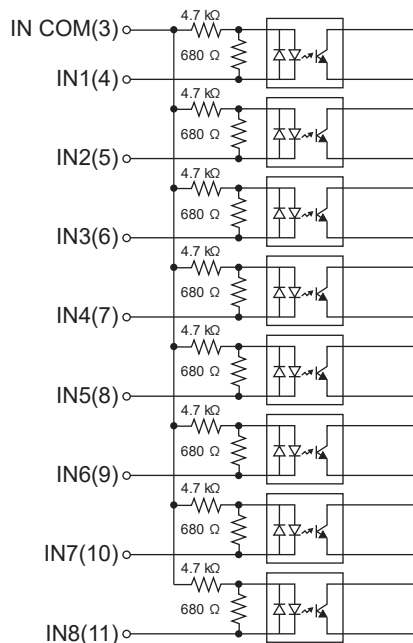
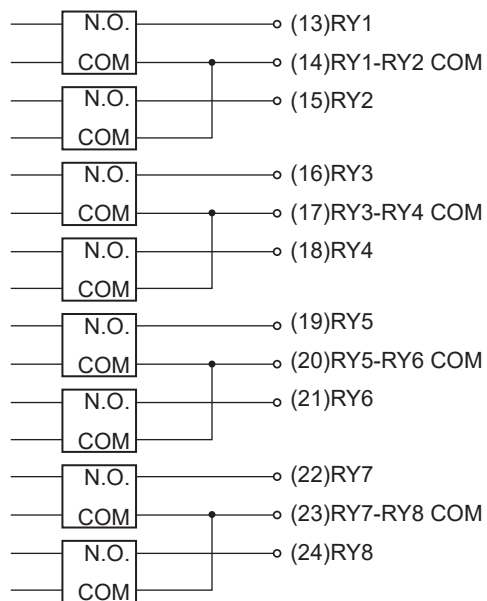

[中国大陆]

- (一) 符合“微功率短距离无线电发射设备目录和技术要求”的具体条款和使用场景,采用的天线类型和性能,控制、调整及开关等使用方法;
- (二) 不得擅自改变使用场景或使用条件、扩大发射频率范围、加大发射功率(包括额外加装射频功率放大器),不得擅自更改发射天线;
- (三) 不得对其他合法的无线电台(站)产生有害干扰,也不得提出免受有害干扰保护;
- (四) 应当承受辐射射频能量的工业、科学及医疗(ISM)应用设备的干扰或其他合法的无线电台(站)干扰;
- (五) 如对其他合法的无线电台(站)产生有害干扰时,应立即停止使用,并采取措施消除干扰后方可继续使用;
- (六) 在航空器内和依据法律法规、国家有关规定、标准划设的射电天文台、气象雷达站、卫星地球站(含测控、测距、接收、导航站)等军民用无线电台(站)、机场等的电磁环境保护区域内使用微功率设备,应当遵守电磁环境保护及相关行业主管部门的规定;
- (七) 禁止在以机场跑道中心点为圆心、半径 5000 米的区域内使用各类模型遥控器;
- (八) 微功率设备使用时温度和电压的环境条件。

■ CMIIT ID 表显示位置

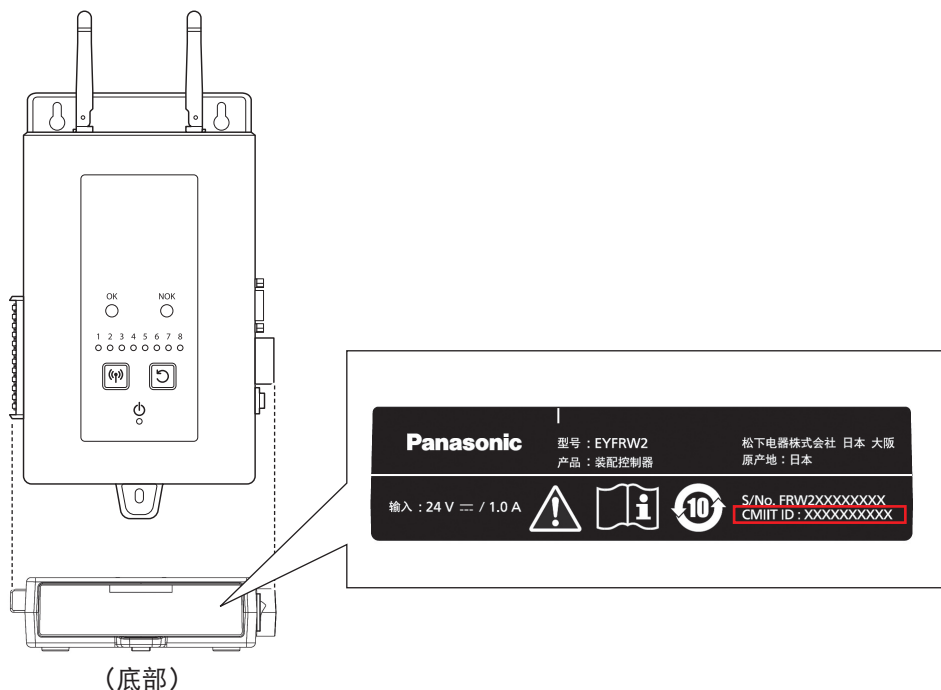

■ 无线规格

无线通讯标准	无线网络 (IEEE 802.11 a/b/g/n) n: 仅限 HT20
频带	频带 2.412 GHz - 2.462 GHz / 5.180 GHz - 5.240 GHz
通道数	通道数 2.4 GHz 频段: 1ch - 11ch 5 GHz 频段: 36ch, 40ch, 44ch, 48ch

■ 无线电功能角色:

工具和控制器之间的无线配对
也 双向数据通讯 (对刀信息、拧紧工作结果等)

软件许可规定

本产品由以下类型的软件构成。

- (1) Panasonic (株) (Panasonic) 自主开发的软件
- (2) 第三方持有并授权给 Panasonic 的软件
- (3) 根据 GNU GENERAL PUBLIC LICENSE Version1.0 (GPL V1.0) 授权的软件
- (4) 根据 GNU GENERAL PUBLIC LICENSE Version2.0 (GPL V2.0) 授权的软件
- (5) 根据 GNU GENERAL PUBLIC LICENSE Version3.0 (GPL V3.0) 授权的软件
- (6) 根据 GNU LESSER GENERAL PUBLIC LICENSE Version2.1 (LGPL V2.1) 授权的软件
- (7) 根据 GNU LESSER GENERAL PUBLIC LICENSE Version3.0 (LGPL V3.0) 授权的软件
- (8) 根据 SMAIL GENERAL PUBLIC LICENSE (SMAIL) 授权的软件
- (9) 根据 Mozilla Public License Version 1.1 (MPL V1.1) 授权的软件
- (10) 根据 Mozilla Public License Version 2.0 (MPL V2.0) 授权的软件
- (11) 根据 GPL V1.0 GPL V2.0 GPL V3.0、LGPL V2.1 LGPL V3.0 SMAIL MPL V1.1 MPL V2.0 之外的条件授权的开源软件

对于属于上述 (3)~(11) 的软件, 虽基于其可能有用的意图而发布, 但本公司不就此作出任何保证, 包括关于“商品性”或“针对特定用途的适用性”的默示保证。

关于著作权者的信息及许可详情, 请参见 P.95 以后。

自本产品发售之日起至少 3 年内, Panasonic 将向联系以下咨询窗口的第三方提供依据 GPL V1.0 GPL V2.0 GPL V3.0、LGPL V2.1 LGPL V3.0 SMAIL 或规定有义务公开源代码的其他条件授权软件相对应的机器可读完整源代码以及各自的著作权者信息, 费用按实际情况收取。请联系使用说明书中的“电器设备资材产品咨询窗口”。

Contact Information: oss-cd-powertools-gl@ml.jp.panasonic.com

错误代码

对象	错误代码	区分	分类	发生现象	处理方法
控制器	0xEF21	警告	硬件异常	副CPU异常(故障)	请重启控制器。 如未消除,可能是设备故障,请咨询销售店。
	0xEF51	警告	硬件异常	Ether0异常	可能是设备故障,请咨询销售店。
	0xEF52	警告	硬件异常	Ether1异常	可能是设备故障,请咨询销售店。
	0xEF61	警告	硬件异常	Wi-Fi模块异常(故障)	请重启控制器。 如未消除,可能是设备故障,请咨询销售店。
	0xCE42	错误	软件异常	设置信息异常	请将控制器恢复出厂设置后再进行设置。
	0xCE43	错误	软件异常	保存信息异常	请长按控制器的复位键3秒以上。
	0xEC61	警告	软件异常	紧固履历区域剩余空间用尽(动作停止)	请从紧固履历画面删除紧固履历数据,确认可用空间。 请根据需要,在删除数据前进行备份。
工具	0x4301	注意	软件异常	达到存储上限	请连接到工具设置软件(Tool Manager软件)后删除作业履历。
	0x4302	注意	软件异常	达到未发送结果累积上限	由于工具无法与控制器进行通信,请移动作业场所。 如未消除,可能是设备故障,请咨询销售店。
	0x3303	错误	软件异常	电机控制微机复位检测	发生错误,已消除。
	0x3304	错误	软件异常	扭矩运算微机复位检测	发生错误,已消除。

对象	错误代码	区分	分类	发生现象	处理方法
工具	0x4305	注意	软件异常	RTC电池余量低	请更换工具主体内部的纽扣电池。
	0x4306	注意	软件异常	FW更新异常	请确认固件文件是否正确。
	0x4315	注意	软件异常	USB通信错误	发生错误,已消除。
	0x4316	注意	软件异常	WiFi模块重启	发生错误,已消除。
	0x1401	警告	硬件异常	WiFi模块异常	发生错误,已消除。
	0x1402	警告	硬件异常	电机控制微机异常	发生错误,已消除。
	0x1403	警告	硬件异常	扭矩运算微机异常	发生错误,已消除。
	0x1404	警告	硬件异常	外置Flash异常	发生错误,已消除。
	0x1405	警告	硬件异常	RTC异常	发生错误,已消除。
	0x1406	警告	硬件异常	电路识别异常	发生错误,已消除。
	0x1407	警告	硬件异常	Swap空间用尽	发生错误,已消除。
	0x1408	警告	硬件异常	参数空间损坏	发生错误,已消除。

动作日志数据

请单击 Home 画面 (设置画面初始页面) 上部的 [Settings]。
请从 ... (控制器选项键) 单击 [Get log data]。
可获取控制器的动作日志信息。

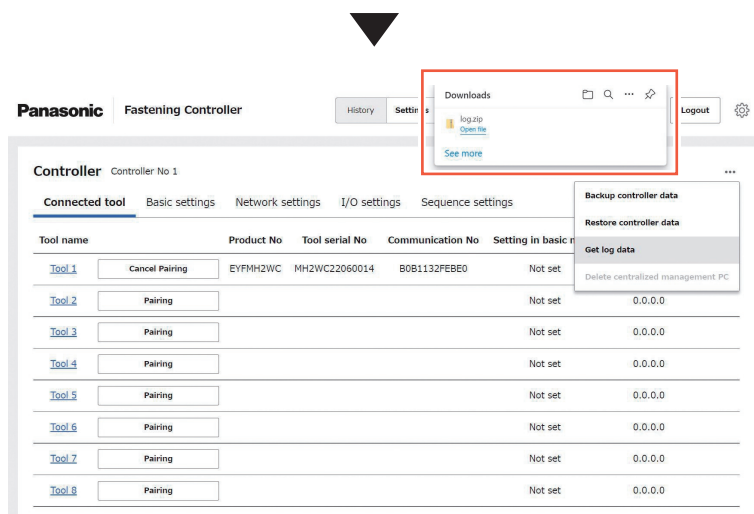
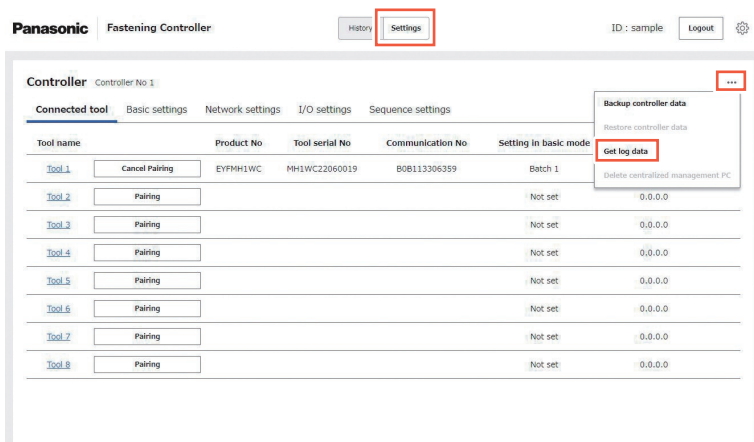

[中国大陆]

产品中有害物质的名称及含量

部件名称	有毒有害物质或元素					
	铅(Pb)	汞(Hg)	镉(Cd)	6价铬(Cr(VI))	多溴联苯(PBB)	多溴二苯醚(PBDE)
外壳	○	○	○	○	○	○
回路基板	×	○	○	○	○	○
马达	○	○	○	○	○	○
其他付属品	○	○	○	○	○	○
机构部	○	○	○	○	○	○

本表格依据 SJ/T11364 的规定编制。

○: 表示该有害物质在该部件所有均质材料中的含量均在 GB/T 26572 规定的限量要求以下。

×: 表示该有害物质至少在该部件的某一均质材料中的含量超出 GB/T 26572 规定的限量要求。

执行标准	装配控制器: GB 4343.1 - 2018, GB 17625.1 - 2012
	电源适配器: GB 4943.1 - 2022, GB/T 9254.1 - 2021, GB17625.1 - 2022

사용설명서

어셈블리 컨트롤러

모델 번호:
EYFRW2

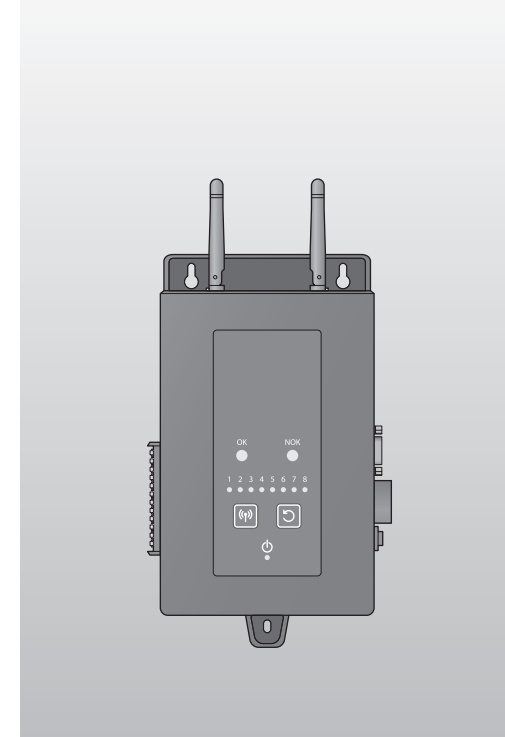

중요

이 제품을 사용하기 전에 안전 사용설명서를 읽고 따르십시오.

제품을 구입한 국가 밖에서 무선 기능을 사용해서는 안 됩니다.

사용하면 현지 법률 및 규정을 위반할 수 있습니다.

원문 지침: 영어

원문 지침의 번역: 기타 언어

목차

시작하기	2	사용 전
안전 예방 조치	4	
기능 설명	7	
시스템 구성	11	
연결 가능 도구 / 설치 주의 사항	14	

사용 전 준비 사항	16	전면
컨트롤러 구성	22	
도구와 페어링	28	
도구 구성	32	
도구 체결 매개 변수 설정	36	
체결 제어 모드 설정	42	
외부 장치에 연결	52	
I/O를 통해 외부 장치에 연결	53	
개방형 프로토콜을 통해 외부 장치에 연결	57	
외부 액세스 포인트를 통해 연결	63	
표시 램프 및 버저	64	
작동 키 설정	66	
연결된 도구 정보 확인	67	
작업 모니터	68	
무선 통신 연결이 끊긴 상태에서 도구의 동작	70	
작동 중 카운트 재설정	71	
체결 이력 데이터 확인	72	
시스템 설정	77	

청소 및 보관	79	청소 및 보관
---------------	----	---------

용량 및 사양	83	전면
라디오 인증	87	
라이선스 조건	89	
오류 코드	90	
작동 로그 데이터	92	

시작하기

작동 환경

컨트롤러를 구성하려면 웹 브라우저를 사용해야 합니다.
다음 요구 사항을 충족하는 PC를 준비하십시오.

작동 환경

호환 OS	Windows 10 이상 (아래 웹 브라우저 지원)
웹 브라우저	Microsoft Edge 버전 102 이상 또는 Google Chrome 버전 102 이상

- 일부 PC는 작동 환경을 충족하더라도 사용할 수 없습니다.
- PC의 사용 환경 등에 따라 본 사용설명서의 설명 및 화면이 실제 설명 및 화면과 다를 수 있습니다.
미리 양해를 구합니다.
- 이 사용설명서의 내용은 사전 통지 없이 변경될 수 있습니다.
- 이 사용설명서의 내용 전체 또는 일부를 무단으로 복제하는 것은 금지되어 있습니다.
- 이 사용설명서의 그림은 참조용입니다.

[중요]

펌웨어를 항상 최신 상태로 유지하십시오.
사용설명서에 대한 액세스를 제공하는 다음 웹사이트에서 최신 펌웨어 데이터를 찾을 수 있습니다.
펌웨어를 업데이트하는 방법은 “펌웨어 업데이트”를 참조하십시오.

P81 참조

사용설명서에 액세스하는 방법

컨트롤러의 사용설명서 및 기타 리소스의 현재 버전은 아래 웹 사이트에서 다운로드할 수 있습니다.

<https://panasonic.net/electricworks/ecm/powerelctrictools/download/>

상표

- Microsoft 및 Windows는 미국 및/또는 기타 국가에서 Microsoft Corporation의 등록 상표 또는 상표입니다.
- 스크린샷은 Microsoft Corporation의 지침에 따라 사용됩니다.
- Wi-Fi 및 Wi-Fi 로고는 Wi-Fi Alliance의 등록 상표입니다.

이 사용설명서에 있는 회사 이름 및 제품 이름을 포함한 기타 이름은 해당 회사의 상표 또는 등록 상표입니다.
™ 및 ®는 이 사용설명서에서 생략될 수 있습니다.

사용 목적

이 제품은 무선으로 도구와 통신하는 컨트롤러입니다.
도구로부터 체결 이력 데이터를 받아 도구 설정 및 체결 수량을 제어할 수 있습니다.

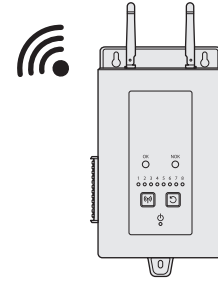

- 01 최대 8개의 도구에 연결
- 02 2.4 GHz 및 5 GHz 대역 지원
- 03 체결 제어 기능 및 이력 저장 기능 지원

설정

도구와의 무선 통신이 가능한 범위에 컨트롤러를 설치하십시오.
AC 콘센트를 통해 전원을 공급하고 필요에 따라 통신 인터페이스를 통해 외부 장치에 연결합니다.

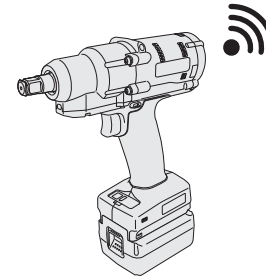

[2.4 GHz]
약 16 m 이내
[5 GHz]
약 10 m 이내

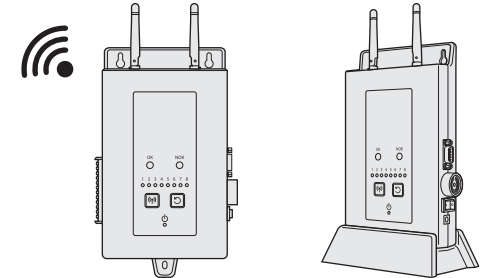

벽에 걸기

자유롭게 세우기

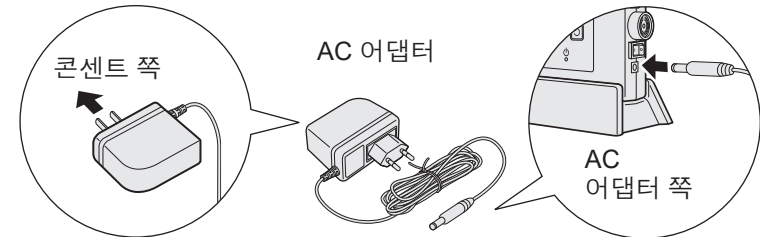



예: WEYFRW1K7951

- 컨트롤러에는 시계 기능 (RTC)을 계속 실행하기 위한 코인 셀 배터리가 포함되어 있습니다.
내부 코인 셀 배터리 소모를 줄이기 위해 전원을 켜두는 것이 좋습니다.
- 무선 범위는 환경에 따라 변경될 수 있습니다.



다음은 인명 피해 및 재산 피해를 방지하기 위해 항상 준수해야 하는 지침입니다.





■ 잘못된 사용으로 인한 피해 및 피해의 심각도는 다음과 같습니다.

 경고	사망하거나 중상을 입을 수 있습니다.
 주의	경상을 입거나 재산 피해가 발생할 수 있습니다.

■ 준수해야 할 내용은 다음 기호로 표시됩니다. (다음은 예시임)

	금지되는 행동입니다.
	따라야 하는 행동입니다.

 경고	
 필수	<ul style="list-style-type: none"> ● 설치 장소에 전선관, 수도관, 가스관 등이 매설되지 않았는지 확인하십시오. 이러한 매설물과 접촉하면 감전이나 누전, 가스 누출의 원인이 됩니다.
	<ul style="list-style-type: none"> ● 전원 플러그를 끝까지 꽂으십시오. 제대로 삽입하지 않으면 감전이나 발열로 인해 화재가 발생할 수 있습니다. 손상된 플러그나 느슨한 소켓을 사용하지 마십시오.
	<ul style="list-style-type: none"> ● 전원 플러그의 먼지를 정기적으로 청소하십시오. 플러그에 먼지가 쌓이면 수분을 흡수하므로 절연 불량으로 인해 화재가 발생할 수 있습니다. 전원 플러그를 뽑고 마른 천으로 닦으십시오.
	<ul style="list-style-type: none"> ● 지정된 전원 코드만 사용하십시오. 다른 플러그를 사용하면 감전, 단락 또는 화재가 발생할 수 있습니다.
	<ul style="list-style-type: none"> ● 작업장을 충분히 밝게 유지하십시오. 어두운 작업장에서는 시야가 제대로 확보되지 않아 사고나 부상을 입을 수 있습니다.

 경고	
 금지	<ul style="list-style-type: none"> ● 정격 값을 초과하는 방식으로 소켓이나 배선 장치를 사용하지 마십시오. 100 V-240 V AC 만 사용하십시오. 소켓의 과부하로 인해 정격 값을 초과하면 열로 인해 화재가 발생할 수 있습니다.
	<ul style="list-style-type: none"> ● 전원 코드나 플러그를 손상시키지 마십시오. (손상, 파손, 개조, 열원에 접근, 무리한 구부림, 비틀림, 당기기, 무거운 하중, 끼임, 결속 등을 피하십시오.) 손상된 코드나 플러그를 사용하면 감전, 단락 또는 화재가 발생할 수 있습니다. 코드와 플러그를 주기적으로 점검하고 손상된 부분이 있으면 대리점에 문의하십시오.
	<ul style="list-style-type: none"> ● 컨트롤러를 DC 전원 공급 장치, 엔진 발전기 또는 변압기와 함께 사용하지 마십시오. ● 가연성 액체나 가스가 있는 장소에서 컨트롤러를 사용하지 마십시오. 그런 곳에서 사용하면 발열, 연기, 화재, 폭발의 원인이 됩니다.
	<ul style="list-style-type: none"> ● 모르타르 벽에 컨트롤러를 설치하지 마십시오. 모르타르 벽면에 나사로 고정하면 내부의 철망에서 열로 인해 누전 시 화재가 발생할 수 있습니다.
	<ul style="list-style-type: none"> ● 사용이 끝나면 전원 플러그를 분리하십시오. 계속 전원에 연결하면 절연 불량으로 인해 감전이나 누전으로 인한 화재가 발생할 수 있습니다.
 분해 금지	<ul style="list-style-type: none"> ● 컨트롤러를 개조하지 마십시오. 컨트롤러를 분해하거나 수리하지 마십시오. 그렇게 하면 화재, 감전, 부상의 원인이 됩니다. 수리하려면 대리점이나 고객 지원 센터에 문의하십시오.
	<ul style="list-style-type: none"> ● 충전된 도구를 다음과 같이 사용하지 마십시오. ● 비나 습기에 노출된 상태로 두거나 사용하지 마십시오. ● 물에 잠긴 상태에서 사용하지 마십시오. 그렇게 하면 연기, 화재, 폭발의 원인이 됩니다.
 건조한 상태 유지	
 젖은 손 접촉 금지	<ul style="list-style-type: none"> ● 젖은 손으로 전원 플러그를 콘센트에 연결하거나 분리하지 마세요. 그렇게 하면 감전될 수 있습니다.

주의



- 원래 목적 이외의 용도로 컨트롤러를 사용하지 마십시오.
그렇게 하면 부상을 입을 수 있습니다.
- 컨트롤러를 어린이의 손이 닿는 곳에 두지 마십시오.
그렇게 하면 사고나 고장의 원인이 됩니다.
- 컨트롤러에 기름이나 기타 이물질이 묻은 상태로 사용하지 마십시오.
이러한 기름이나 이물질이 내부로 유입되어 발열, 화재, 폭발의 원인이 됩니다.
- 온도가 45 °C 이상으로 올라갈 수 있는 장소에 본체를 보관하지 마십시오.
그렇게 하면 오작동의 원인이 됩니다.
- 비정상적인 위치에서 작업하지 마십시오.
그렇지 않으면 넘어져 다칠 수 있습니다.
항상 안정된 발판에 서서 균형을 제대로 잡으십시오.
- 피곤할 때 컨트롤러를 사용하지 마십시오.
그렇게 하면 사고나 부상의 원인이 됩니다.
- 어린이나 작업자가 아닌 사람이 작업장에 접근하거나 컨트롤러를 만지지 않도록 하십시오.
그렇게 하면 부상을 입을 수 있습니다.
- 호환되지 않는 장치와 함께 컨트롤러를 사용하지 마십시오.
그렇게 하면 고장으로 인해 사고가 발생할 수 있습니다.



- 컨트롤러를 벽에 설치할 경우 떨어지지 않도록 나사로 고정하십시오.
떨어지면 부상을 입을 수 있습니다.
- 전원 플러그를 뺄 때는 코드를 당기지 말고 항상 전원 플러그를 잡으십시오.
코드를 잡아당기면 감전 또는 단락이 발생할 수 있습니다.
- 사용하기 전에 컨트롤러 및 기타 부품에 손상이 없는지 검사하고 정상적인 작동을 확인하십시오.
그렇지 않으면 파손으로 이어져 부상을 입을 수 있습니다.
- 작업장을 청결하게 유지하십시오.
정리되지 않은 작업장이나 작업대는 사고로 이어질 수 있습니다.
- 취급 및 작업 방법을 잘 고려하고, 주변 환경에 주의를 기울이며, 상식적인 수준에서 작업하십시오.
그렇게 하지 않으면 사고를 당하거나 부상을 입을 수 있습니다.

본체

■ 좌측면

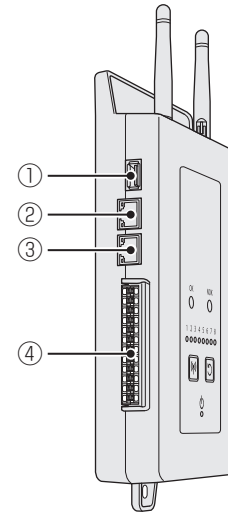

■ 전면

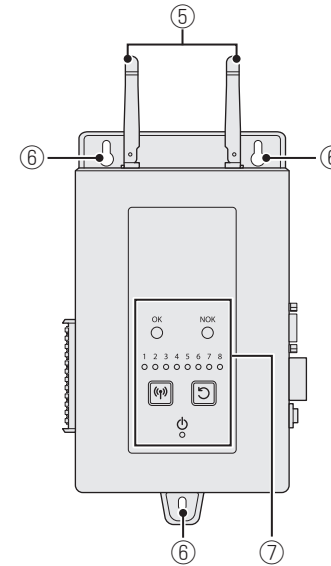

■ 우측면

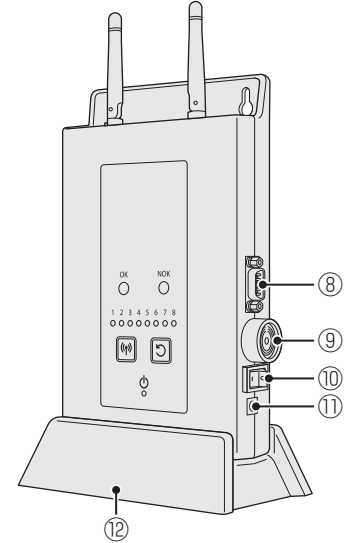

■ AC 어댑터

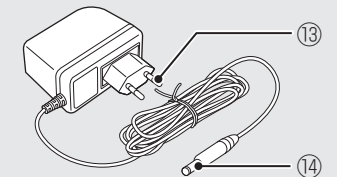

①	USB 포트 (Type-A)
②	이더넷 포트 (유지 보수용)
③	이더넷 포트 (네트워크용)
④	1~24 I/O 포트
⑤	다이버시티 안테나
⑥	벽걸이 구멍
⑦	제어판

⑧	IOI이 직렬 포트 (RS232C)
⑨	버저
⑩	전원 스위치
⑪	AC 어댑터 소켓
⑫	컨트롤러 스탠드
⑬	전원 플러그
⑭	전원 커넥터

■ 제어판

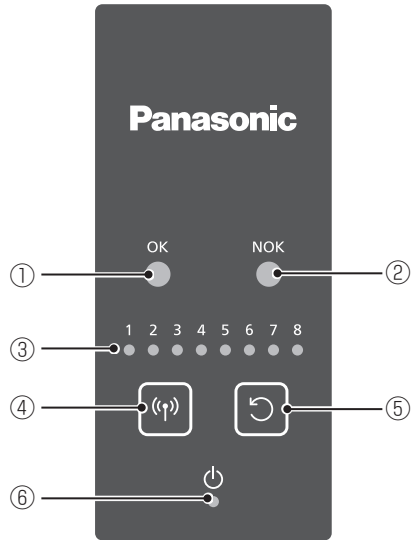

①	<p>체결 OK 램프 솔리드 녹색: 체결 완료 신호를 수신했습니다.</p> <p>OFF: 체결 완료 신호가 수신되지 않았습니다.</p>
②	<p>체결 NOK 램프 솔리드 빨간색: 체결 실패 신호를 수신했습니다.</p> <p>OFF: 체결 실패 신호가 수신되지 않았습니다.</p>
③	<p>통신 램프 (1~8 번) 솔리드 파란색: 도구가 등록되었습니다.</p> <p>파란색 깜박임: 도구가 등록 중이거나 범위를 벗어났습니다.</p> <p>OFF: 도구가 등록되지 않았습니다.</p>

④	페어링 키
⑤	재설정 키
⑥	<p>전원 램프 노란색 점등: 전원 켜기(수신 모드)</p> <p>OFF: 전원 끄기 노란색 깜박임: 오류</p>

■ 통신 인터페이스

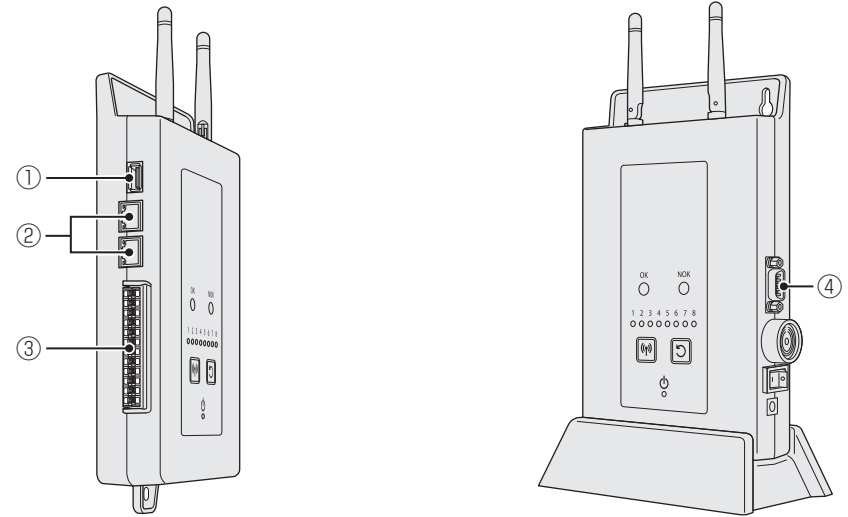

인터페이스		세부 정보
①	USB	<p>firmware를 업데이트하려면 이 포트를 사용하여 USB 플래시 드라이브를 연결합니다.</p> <ul style="list-style-type: none"> • USB 2.0 Type-A × 1 • USB 플래시 드라이브 직접 연결 (확장 없음)
②	이더넷 (유지 보수 및 네트워크용)	<p>이 포트를 사용하여 구성용 PC 또는 호스트 시스템에 연결합니다.</p> <ul style="list-style-type: none"> • 10Base-T/100Base-TX × 2 • 케이블 길이: 30 m 이하 <p>* 이더넷 포트 (유지 보수용)를 구성용 PC에 직접 연결합니다. (허브를 사용하지 않음)</p>
③	입력/출력 (I/O) 단자	<p>이 포트를 사용하여 외부 장치(예: PLC)에 연결합니다.</p> <ul style="list-style-type: none"> • 입력 8개 및 출력 8개 • 케이블 길이: 10 m 이하 • 입력 단자 정격: 24 V DC, 50 mA • 출력 단자 정격: 30 V DC, 3 A
④	직렬 포트 (RS232C)	<p>이 포트를 사용하여 외부 장치(예: PLC)에 연결합니다.</p> <ul style="list-style-type: none"> • RS232C × 1 • 케이블 길이: 10 m 이하

액세서리

■ AC 어댑터 × 1

[중국에만 해당]
(WEYFRW1K7951)

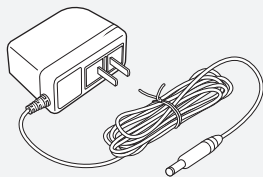

[한국에만 해당]
(WEYFRW1K7051)

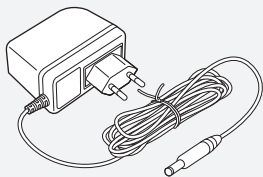

[말레이시아에만 해당]
(WEYFRW1K7851)

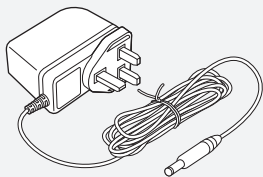

[인도에만 해당]
(WEYFRW1K7151)

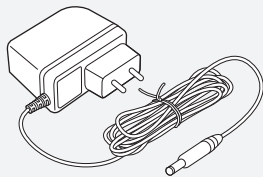

[태국/인도네시아만 해당]
(WEYFRW1K7751)

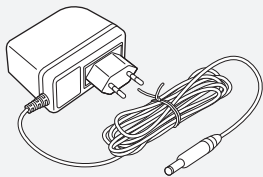

■ 컨트롤러 스탠드 × 1
(EYFRW1F7001)

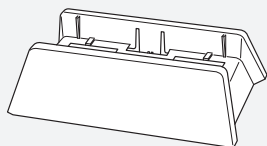

소모품

■ 코인 셀 배터리 (CR2450) × 1

교체 방법은 “코인 셀 배터리 교체” 를 참조하십시오.

P82 참조



시스템 구성

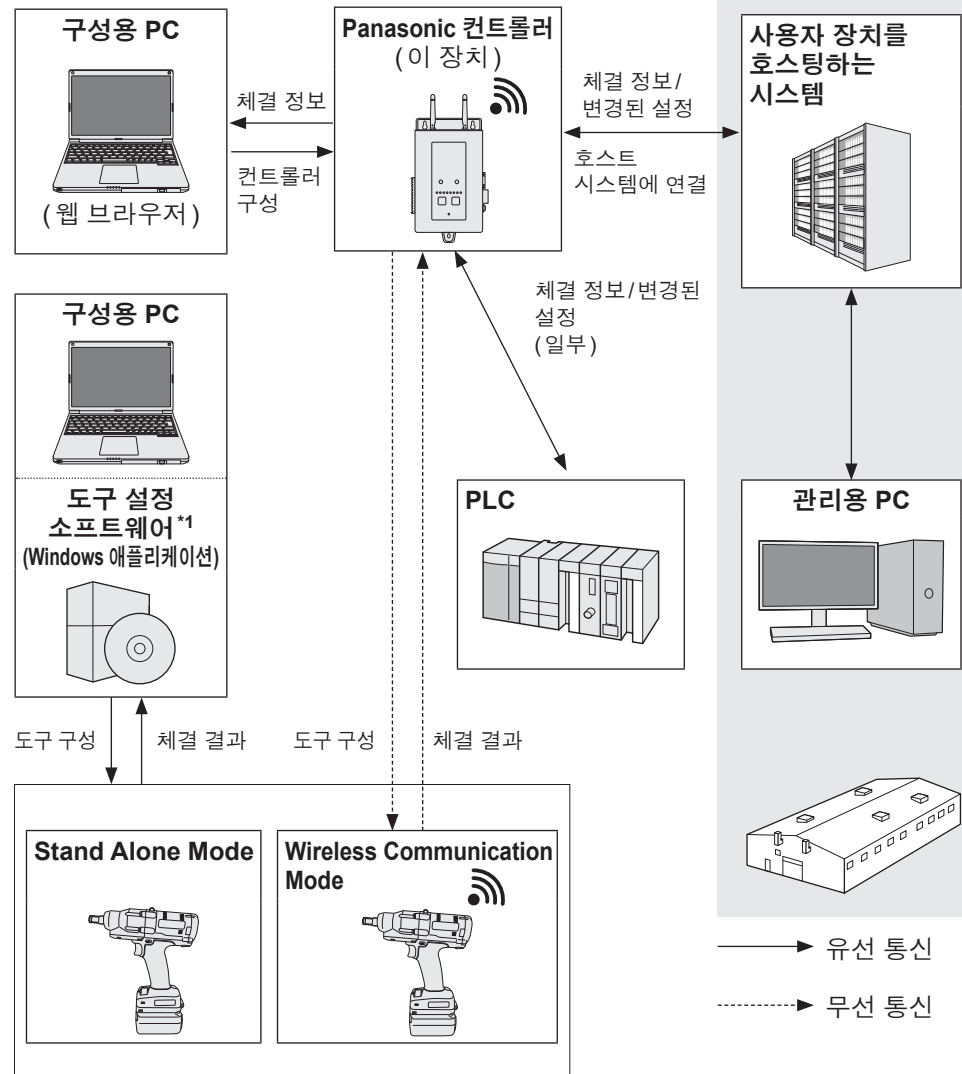

*1 “도구 설정 소프트웨어”는 웹 사이트에서 다운로드할 수 있습니다. **P2** 참조

일반적인 네트워크 구성

컨트롤러는 아래 3가지 구성으로 사용할 수 있습니다.

■ 도구의 IP 주소를 관리하지 않음

* 자동 할당 (컨트롤러에 내장된 액세스 포인트 사용)

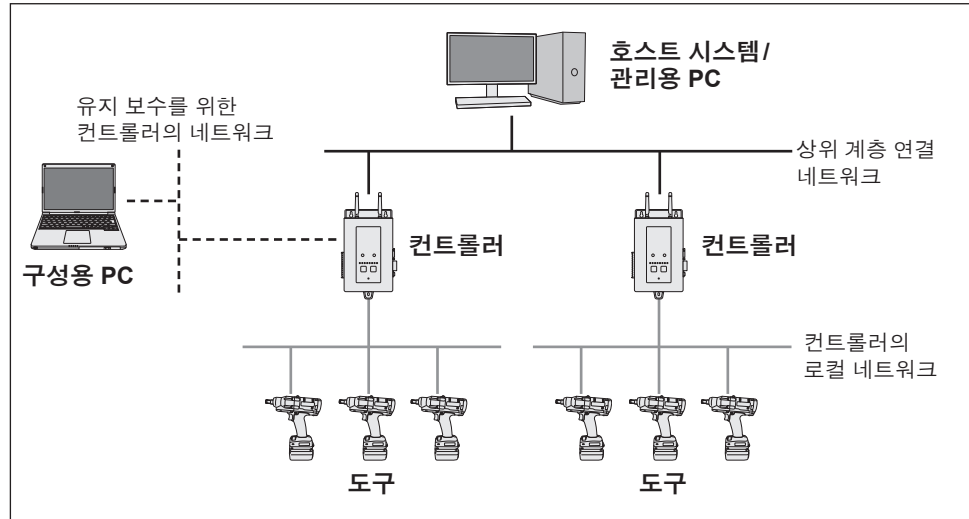

■ 도구의 IP 주소 관리 (컨트롤러에 내장된 액세스 포인트 사용)

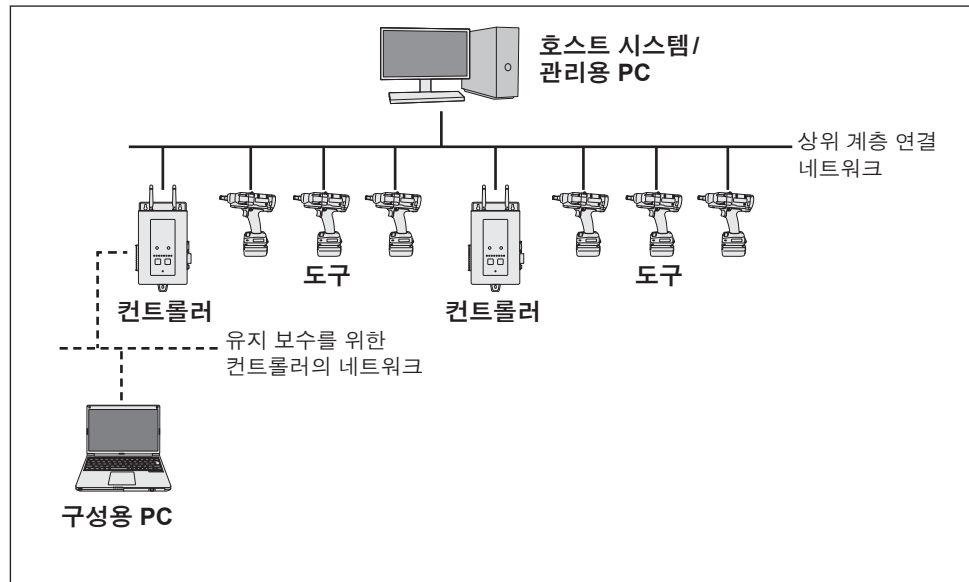

■ 도구의 IP 주소 인식 (외부 액세스 포인트 사용)

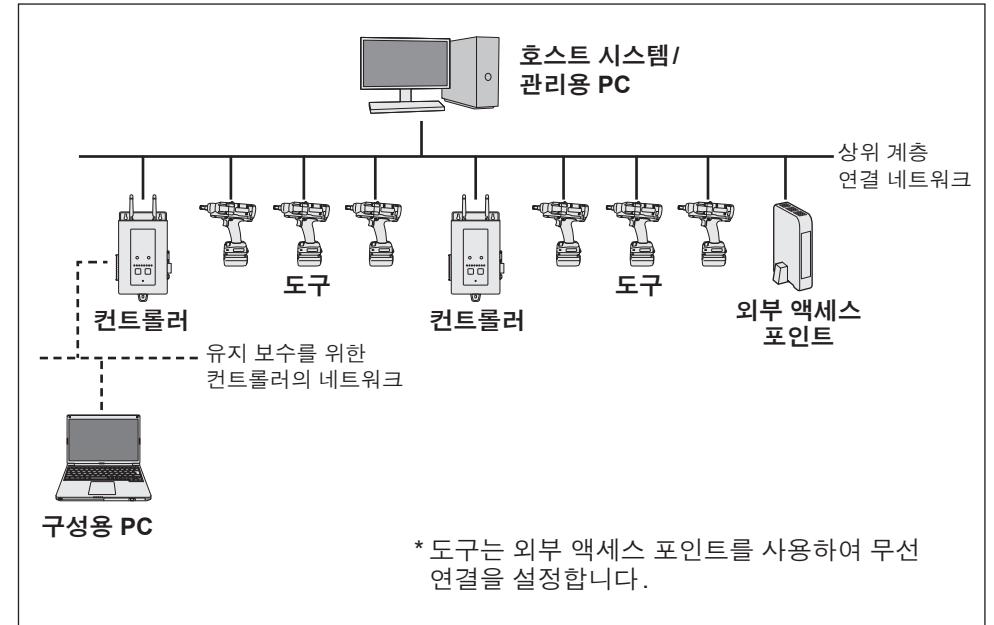

- * 로컬 네트워크 내에서 시스템을 사용하십시오 (인터넷에 연결하지 않음).
- * 사용을 시작하기 전에 컨트롤러의 네트워크에 대한 IP 주소 설정을 확인하십시오. (필요한 경우 기본값 변경)

연결 가능 도구/설치 주의 사항

적용 가능한 도구 모델 목록

등록 가능한 모델

EYFMH1WC, EYFMH2WC

설치 주의

컨트롤러는 바닥에서 80 cm 이상 위에 설치하십시오. 설치된 컨트롤러 사이에 10 cm 이상을 유지하십시오. (1 m 이상 권장)
 설치된 컨트롤러의 안테나가 장애물에 가리지 않게 하십시오.
 컨트롤러에는 2개의 다이버시티 안테나가 있습니다. 양쪽 안테나가 장애물에 가리지 않게 하십시오.

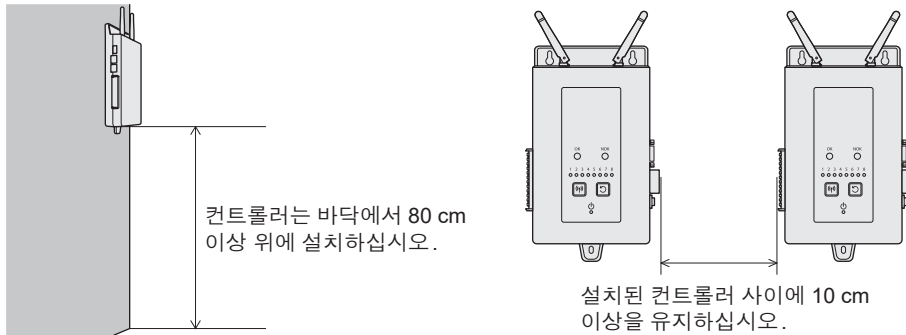

통신이 불안정한 경우 안테나의 각도를 조정하십시오.
 * 특히 금속 패널에 설치되는 컨트롤러의 경우 안테나의 각도를 조정하면 통신 안정성이 향상될 수 있습니다.

안테나를 벽에서 30~45° 기울입니다.



정면에서 보았을 때 안테나를 바깥쪽으로 30~45° 기울입니다.

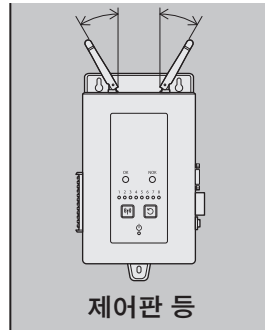

■ 다음 설치를 피하십시오.

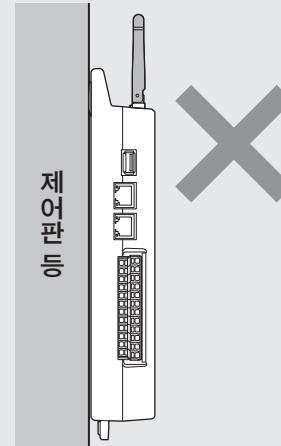

안테나가 후면의 제어판(금속 패널)과 평행합니다.

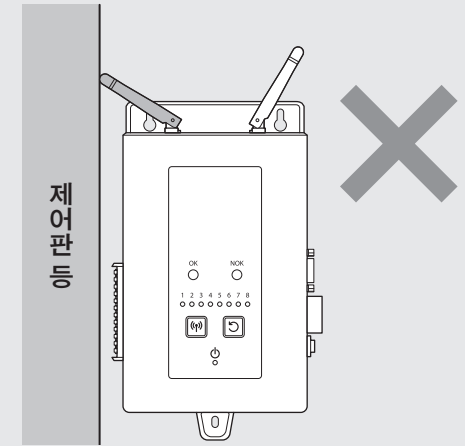

안테나는 제어판(금속 패널)과 접촉합니다.

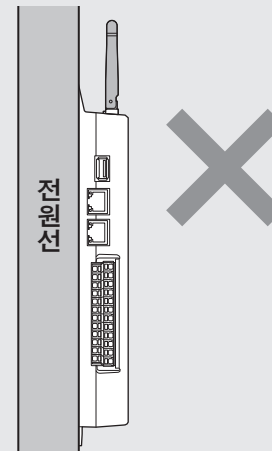

컨트롤러는 전원선에 매우 가깝게 설치됩니다.

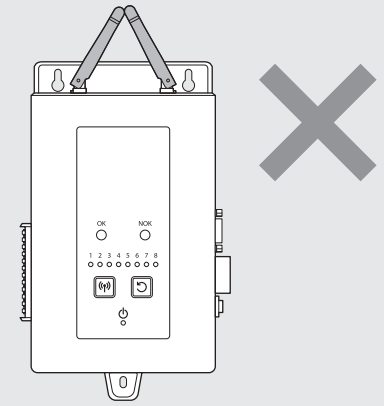

안테나는 서로 접촉되어 있습니다.

사용 전 준비 사항

구성용 PC의 네트워크 설정

구성용 PC와 컨트롤러를 처음 연결할 때 아래와 같이 구성용 PC의 네트워크 설정을 설정하십시오.

1 화면 좌측 하단의 를 클릭하고 **(Settings) - [Network & Internet] - [Change adapter options]** 을 클릭합니다.

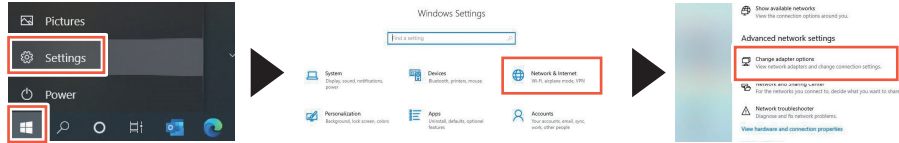

2 장치를 마우스 오른쪽 버튼으로 클릭하여 연결하고 **[Properties]** 를 클릭합니다.

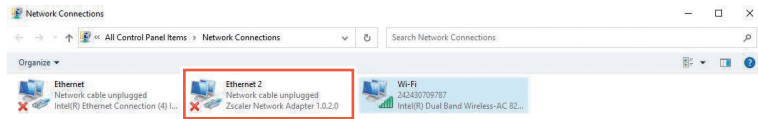

3 “Internet Protocol Version 4” 를 선택하고 **[Properties]** 를 클릭합니다.

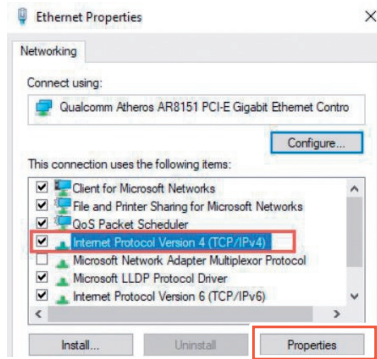

4 “IP address”와 “Subnet mask” 를 아래와 같이 설정합니다.

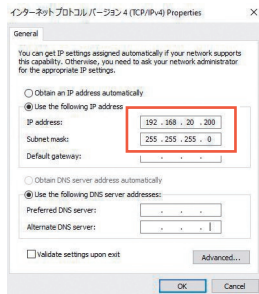

IP address	192 . 168 . 20 . 200
Subnet mask	255 . 255 . 255 . 0

- * 처음 연결 후 컨트롤러의 IP 주소를 변경한 경우 구성용 PC에서 네트워크 설정 (IP 주소 및 서브넷 마스크)을 반환하여 연결을 활성화합니다. 이 때 컨트롤러와 구성용 PC가 같은 네트워크에 있도록 IP 주소를 설정합니다.
- * 변경하기 전에 구성용 PC의 네트워크 설정 (IP 주소 및 서브넷 마스크)을 기록하고 보관합니다.
- * 기본 게이트웨이를 미지정 상태 (공백)로 두는 것이 좋습니다.

설정 화면 표시

컨트롤러를 구성하려면 웹 브라우저를 통해 액세스하십시오. 컨트롤러의 설정 화면을 아래와 같이 표시합니다.

컨트롤러를 처음 사용하는 경우 코인 셀 배터리에서 보호 필름을 제거하십시오.

1 컨트롤러를 켭니다.

- ① 제공된 AC 어댑터를 컨트롤러에 연결하고 전원 플러그를 콘센트에 연결합니다.
- ② 컨트롤러의 전원 스위치를 켭니다.
 - * 시작하는 데 수십 초가 걸립니다.
 - * 시작하는 동안 체결 OK 램프, 체결 NOK 램프, 통신 램프(1~8번)가 함께 깜박입니다.
 - * LAN 케이블을 연결하지 마십시오.

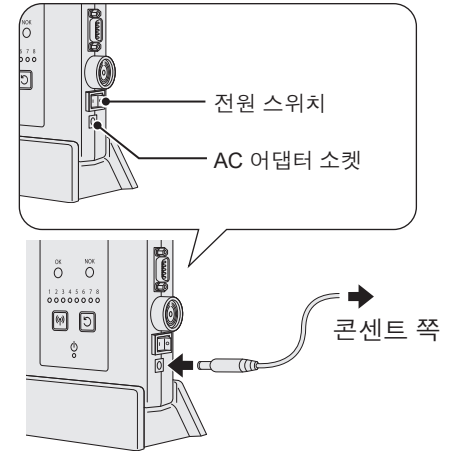

2 LAN 케이블을 사용하여 컨트롤러를 구성용 PC에 연결합니다.

- ① LAN 케이블을 컨트롤러의 이더넷 포트에 연결합니다.
 - * 컨트롤러에는 2개의 이더넷 포트가 있습니다. 하나는 유지 보수용이고 다른 하나는 네트워크용입니다. 처음 연결할 때는 유지 보수용을 사용하십시오.
- ② LAN 케이블을 사용하여 구성용 PC에 연결합니다.

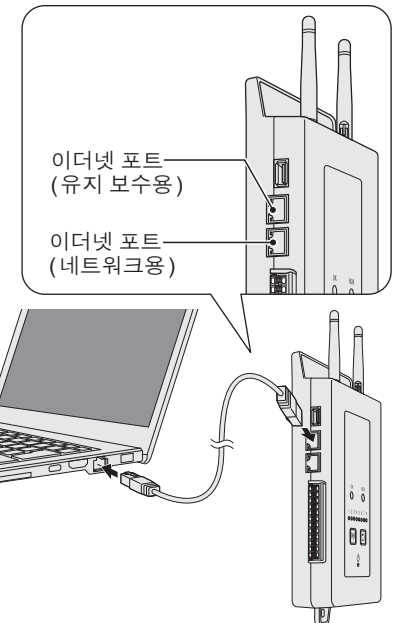

3 구성용 PC에서 웹 브라우저를 시작하고 컨트롤러에 액세스합니다.

- ① 구성용 PC에서 웹 브라우저를 시작합니다. (Microsoft Edge 권장)
- ② 웹 브라우저의 주소 표시줄에 컨트롤러의 IP 주소를 입력합니다.
* 이더넷 포트(유지 보수용)의 기본 IP 주소는 "192.168.20.10"입니다.

웹 브라우저의 주소 표시줄에서 "http://192.168.20.10/controller" 를 입력하여 액세스합니다.

* "192.168.20.10/controller" 를 입력해도 액세스가 허용됩니다.

* 이더넷 포트(네트워크용)를 통한 액세스 방법은 "네트워크를 통해 연결"을 참조하십시오. **P21 참조**

* IP 주소도 구성용 PC에 설정해야 합니다.

- ③ 표시되는 로그인 화면에서 사용자 ID와 비밀번호를 입력합니다.
* 초기 로그인용 사용자 ID와 비밀번호는 아래와 같습니다.
- ④ 상단 페이지(설정 화면의 초기 페이지)가 표시됩니다.

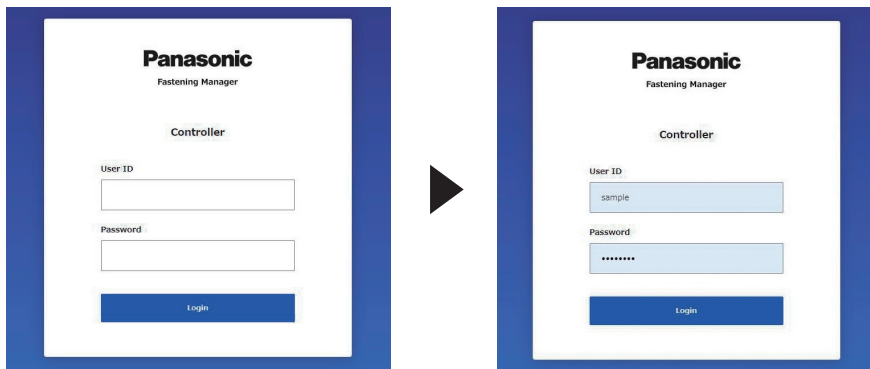

초기 로그인용 사용자 ID 및 비밀번호

아래 사용자 ID와 비밀번호로 로그인합니다.

■ 사용자 ID: root

■ 비밀번호: abcABC123

* 초기 로그인용 계정 유형은 "default"입니다.

계정 유형의 경우 "계정 유형(권한)"을 참조하십시오. **P19 참조**

* 위 사용자 ID와 비밀번호로 로그인해야만 계정 생성이 가능합니다. 사용을 시작하기 전에 새 계정을 생성합니다.

* 보안을 위해 최초 로그인 후 위 비밀번호를 변경하는 것이 좋습니다.

계정 유형(권한)

다음은 계정 유형입니다. 용도에 따라 사용하십시오.

계정 유형	기능
기본	<ul style="list-style-type: none"> • 초기 로그인용의 경우. P18 참조 • 사용자 계정 추가 또는 변경.
Administrator	<ul style="list-style-type: none"> • 체결 기록 보기. • 컨트롤러 구성. • 도구 구성. • 사용자 계정 추가 또는 변경. * 하나 이상의 관리자 계정을 생성합니다.
General	<ul style="list-style-type: none"> • 체결 기록 보기(작업 모니터 보기 포함).

최대 10개의 계정을 등록할 수 있습니다.

따라서 한 명 이상의 운영자가 동시에 로그인할 수 있습니다.

* 동시에 하나의 계정만 관리자로 로그인할 수 있습니다.

다중 접속 시도 시 마지막 세션이 우선합니다.

사용자 계정 생성

사용을 시작하기 전에 새 계정을 생성합니다.

1 상단 페이지(설정 화면의 초기 페이지)에서 우측 상단의 옵션 키를 클릭하고 "Account Settings"를 선택합니다.

"Account Settings" 화면이 표시됩니다.

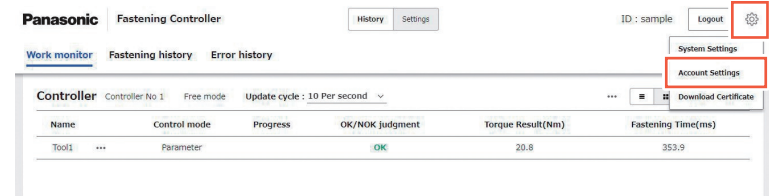

2 "Account Settings" 화면에서 [Add]를 클릭합니다.

"Add account" 화면이 표시됩니다.

- 계정을 변경하려면 [Change]를 클릭하고 계정을 삭제하려면 [Delete]를 클릭합니다.

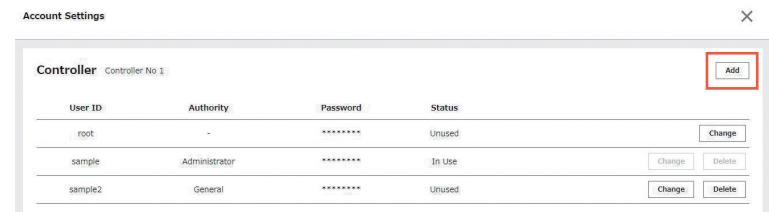

3 “User ID” 및 “Password” 를 입력하고 “Authority” 을 선택한 다음 [Add] 를 클릭합니다.

- * 도구를 구성하려면 관리자 계정을 생성합니다.
- * 비밀번호는 항상 대문자, 소문자, 숫자, 기호 중 3가지 이상의 조합을 사용해야 합니다.

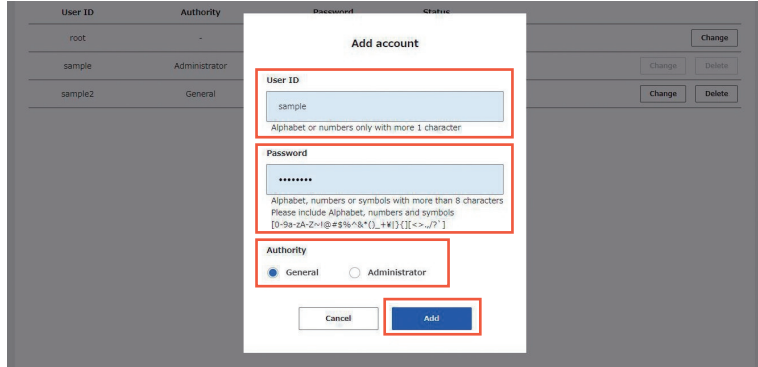

[참조] 사용자 ID나 비밀번호를 분실한 경우

■ 일반 계정

- [방법 1] 관리자 로 로그인하고 관련 계정을 변경합니다.
* 일반 사용자는 사용자 ID와 비밀번호를 변경할 수 없으며 관리자에게 변경을 요청해야 합니다.
- [방법 2] 새로 생성된 관리자 계정으로 로그인하여 해당 계정을 변경합니다.
* 초기 로그인용 사용자 ID와 비밀번호로 로그인하고 새 관리자 계정을 생성합니다. **P18 참조**

■ 관리자 계정

A) 관리자 계정이 여러 개 생성된 경우

- [방법 1] 다른 관리자 계정으로 로그인하여 해당 계정을 변경합니다.
- [방법 2] 새로 생성된 관리자 계정으로 로그인하여 해당 계정을 변경합니다.
* 초기 로그인용 사용자 ID와 비밀번호로 로그인하고 새 관리자 계정을 생성합니다. **P18 참조**
- [방법 3] 모든 관리자 계정의 ID와 비밀번호를 분실한 경우 설정을 초기화합니다.
P79 참조

B) 관리자 계정이 하나만 생성된 경우

- [방법 1] 새로 생성된 관리자 계정으로 로그인하여 해당 계정을 변경합니다.
* 초기 로그인용 사용자 ID와 비밀번호로 로그인하고 새 관리자 계정을 생성합니다. **P18 참조**
- [방법 2] 모든 관리자 계정의 ID와 비밀번호를 분실한 경우 설정을 초기화합니다.
P79 참조

인증서 받기

이더넷 포트 (네트워크용)를 통해 컨트롤러에 액세스하려면 인증서가 필요합니다. 아래와 같이 인증서를 받을 수 있습니다.

1 상단 페이지 (설정 화면의 초기 페이지)에서 우측 상단의 옵션 키를 클릭하고 “Download Certificate” 를 선택합니다.

인증서 데이터가 구성용 PC에 다운로드됩니다.

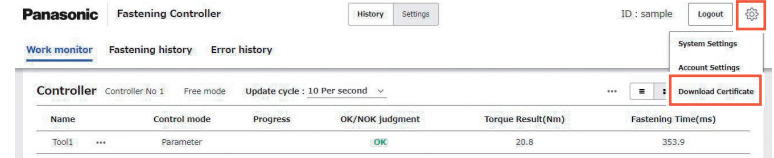

2 “네트워크를 통해 컨트롤러에 액세스하는 데 사용되는 구성용 PC” 에 인증서를 설치합니다.

① 다운로드한 인증서 데이터를 두 번 클릭하고 “Install Certificate”를 선택합니다.

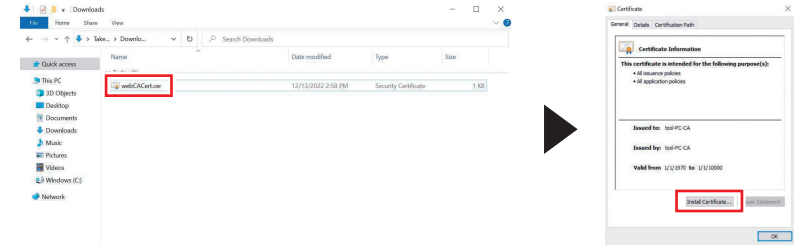

② “Place all certificates in the following store” 를 선택한 다음 “Trusted Root Certification Authorities” 를 선택합니다.

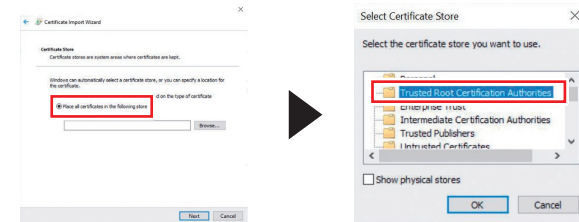

네트워크를 통해 연결

웹 브라우저의 주소 표시줄에 “https://XXX.XXX.XXX.XXX/controller” 를 입력하여 이더넷 포트 (네트워크용)를 통해 컨트롤러를 연결합니다.

* “XXX.XXX.XXX.XXX” 는 IP 주소입니다.

* 기본 IP 주소는 “192.168.0.10” 입니다. 기본 주소를 변경한 경우 변경된 주소를 입력합니다. **P26 참조**

기본 설정

상단 페이지 (설정 화면의 초기 페이지)에서 위에 있는 [Settings] 를 클릭하고 “Basic settings” 탭을 선택합니다.
컨트롤러를 구성할 수 있습니다.

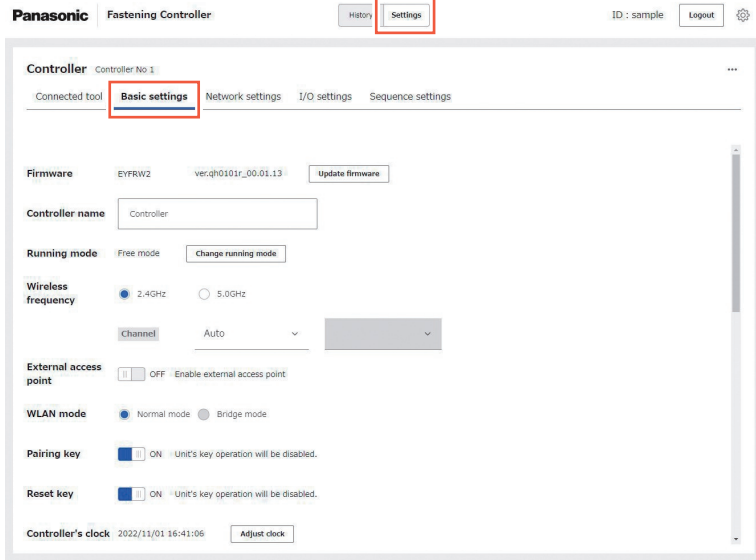

시간 설정

“Timezone” 을 선택한 다음 [Adjust clock] 을 클릭합니다.
시간이 업데이트됩니다.

• 제품 선적 시에는 아직 시간이 설정되어 있지 않습니다. 컨트롤러를 처음 사용할 때 시간을 설정하십시오.

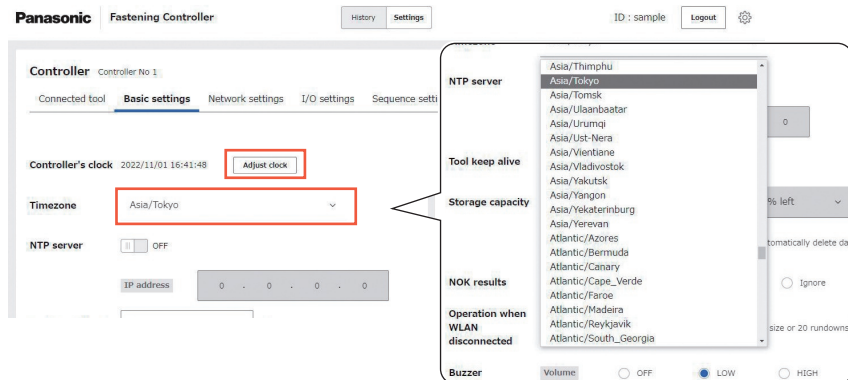

* NTP 서버를 사용하는 경우 IP 주소를 입력합니다.

무선 주파수 및 채널 설정

사용할 주파수를 설정할 수 있습니다.

“2.4GHz” 또는 “5GHz” 를 선택한 다음 사용할 채널을 선택합니다.

* 선택 가능한 채널은 “2.4GHz” 와 “5GHz” 가 다릅니다.

* “Auto Channel” 을 설정할 수 있습니다.

이 기능을 켜면 컨트롤러가 주변 환경에서 사용할 수 있는 채널을 자동으로 선택합니다.

이 설정은 무선 간섭에 효과적일 수 있습니다.

* 여러 컨트롤러를 서로 가까이 설치할 때 인접 채널을 설정하지 마십시오.

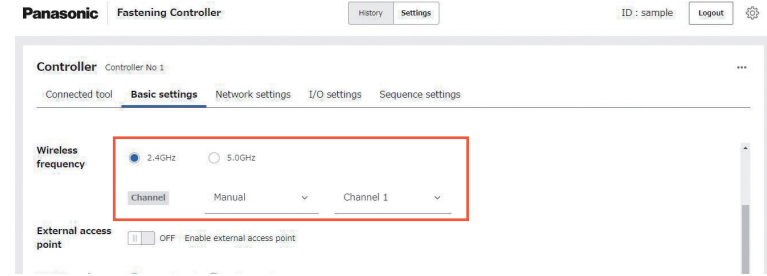

설정 항목

Firmware

컨트롤러의 펌웨어 버전이 표시됩니다.

펌웨어를 업데이트하려면 [Update firmware] 를 클릭합니다.

업데이트 방법은 “펌웨어 업데이트” 를 참조하십시오. **P81 참조**

Controller name

컨트롤러의 이름을 등록할 수 있습니다.

최대 32자의 영숫자 문자를 사용하십시오.

[기본] Controller

[설정 범위] 최대 32자의 영숫자 문자

* 기호의 경우 “-”(하이픈), “_”(밑줄), “ ”(반각 공백)만 사용할 수 있습니다.

Running mode

컨트롤러의 실행 모드를 선택합니다.

[기본] Free mode

[설정 범위] Free mode / Repeat mode (Basic mode / Sequence mode) / External control mode

Wireless frequency

무선 통신에 사용할 주파수 채널을 선택합니다.

[기본] 2.4GHz

[설정 범위] 2.4GHz (Auto / Channel 1 ~ 13) / 5GHz (Auto / Channel 36, 40, 44, 48)

* 채널 12와 13은 중국과 한국에서 사용할 수 없습니다.

External access point	
외부 액세스 포인트를 통해 통신을 활성화할 수 있습니다. P63 참조	
[기본]	OFF (비활성화됨)
[설정 범위]	OFF (비활성화됨) / ON (활성화됨)
* WLAN mode: 이 설정은 외부 액세스 포인트를 사용하지 않고 작동시키는 설정입니다. Normal mode: 도구의 IP 주소를 관리하지 않을 때 (자동 할당) Bridge mode: 도구의 IP 주소를 관리 (지정)할 때	
Pairing key	
페어링 키를 활성화할 수 있습니다.	
[기본]	ON (활성화됨)
[설정 범위]	OFF (비활성화됨) / ON (활성화됨)
Reset key	
재설정 키를 활성화할 수 있습니다.	
[기본]	ON (활성화됨)
[설정 범위]	OFF (비활성화됨) / ON (활성화됨)
Controller's clock	
컨트롤러의 시계를 설정합니다. 시간을 업데이트하려면 [Adjust clock] 을 클릭합니다.	
Timezone	
컨트롤러의 시계를 조정할 때 원하는 시간대를 설정할 수 있습니다.	
NTP server	
자동 시계 조정을 사용하는 경우 NTP 서버를 설정합니다.	

Tool keep alive	
컨트롤러가 Wireless Communication Mode 에서 도구의 가용성을 확인하는 시간 간격을 설정합니다. 응답하지 않는 도구는 오프라인으로 감지된 다음 연결이 끊어집니다.	
[기본]	30 s
[설정 범위]	10 s ~ 3600 s
Storage capacity	
저장 용량 부족 알림을 활성화 또는 비활성화하고 용량 부족 시 동작을 설정합니다.	
[기본]	알림 - OFF, 용량 부족 시 동작 - Automatically delete data
[설정 범위]	알림 - OFF/ON(남은 용량 10/20/30/40/50%), 용량 부족 시 동작 - Suspend operation/Automatically delete data
기본 설정은 "Automatically delete data" 입니다. 필요에 따라 "Suspend operation" 을 선택하기 전에 데이터 처리 방법을 잘 고려하십시오.	
NOK results	
체결 실패 결과 처리 방법을 선택합니다.	
[기본]	Store data only
[설정 범위]	Report to system / Store data only / Ignore
Operation when WLAN disconnected	
무선 통신이 일시적으로 중단되는 경우 동작을 선택합니다.	
[기본]	Suspend tool
[설정 범위]	Suspend tool / Enable fastening (Until batch size or 20 rundowns)
자세한 내용은 "무선 통신 연결이 끊긴 상태에서 도구의 동작" 을 참조하십시오. P70 참조	
Buzzer	
버저의 음량과 의미를 선택합니다.	
[기본]	Volume - LOW, Beep - 모두 선택됨
[설정 범위]	Volume - OFF / LOW / HIGH, Beep - 각 항목 선택 또는 선택 해제

네트워크 설정

상단 페이지 (설정 화면의 초기 페이지)에서 위에 있는 [Settings] 를 클릭하고 “Network settings” 탭을 선택합니다.
컨트롤러의 네트워크 설정을 할 수 있습니다.

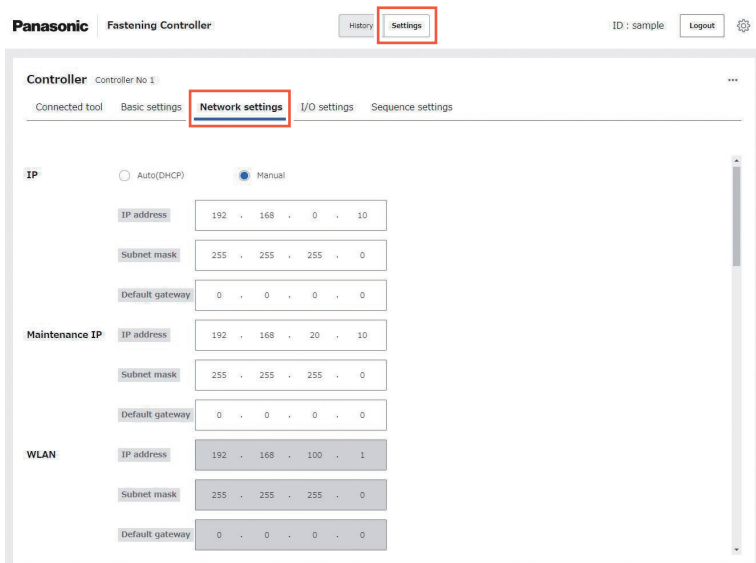

■ 설정 항목

IP

이더넷 포트 (네트워크용)의 IP 주소를 설정합니다.

[기본] Manual
[설정 범위] Auto (DHCP) / Manual

* “Manual”

[기본] IP address - 192.168.0.10
Subnet mask - 255.255.255.0
Default gateway - 0.0.0.0

Maintenance IP

이더넷 포트 (유지 보수용)의 IP 주소를 설정합니다.

[기본] IP address - 192.168.20.10
Subnet mask - 255.255.255.0
Default gateway - 0.0.0.0

WLAN

도구와의 무선 통신을 위한 IP 주소 (컨트롤러 측)를 설정합니다.

[기본] IP address - 192.168.100.1
Subnet mask - 255.255.255.0
Default gateway - 0.0.0.0

Atlas Open Protocol

Atlas Open Protocol 관련 매개 변수를 설정합니다.

자세한 내용은 “개방형 프로토콜 통신을 통한 연결”을 참조하십시오. **P57 참조**

Access point

도구와의 무선 통신을 위한 내부 액세스 포인트를 설정합니다.

[기본] SSID - 컨트롤러의 모델 번호-MAC 주소
Security - WPA2
[설정 범위] SSID - 최대 32자의 영숫자 문자
Security - WPA2

External access point

사용할 외부 액세스 포인트를 설정합니다.

[기본] SSID - 비어 있음
Security - 비어 있음
Password - 비어 있음
[설정 범위] SSID - 최대 32자의 영숫자 문자
Security - 개방형/WPA2
Password - 8~63자의 영숫자 문자

* 기호의 경우 “”, “¥”, “,”, “” (역따옴표)만 사용할 수 있습니다.

* 이 옵션은 기본 설정에서 “External access point”가 “ON”으로 설정된 경우에만 활성화됩니다.

- “IP” 및 “Maintenance IP”의 IP 주소는 동일한 서브넷을 사용하지 마십시오.
(“Subnet mask”에 기본값(255.255.255.0)을 설정할 때 “192.168.0” 또는 “192.168.20”에 해당하는 부분에 다른 값을 설정합니다.)

컨트롤러에서 페어링 모드 시작

“장치의 키 사용” 또는 “설정 화면의 설정”을 통해 컨트롤러를 페어링 모드로 전환할 수 있습니다.

페어링 모드 2분 동안 적용 범위 내의 도구에서 페어링 모드를 시작하여 자동으로 페어링을 설정합니다.

시간 내에 페어링이 설정되지 않으면 페어링 모드가 종료됩니다.

* 페어링을 시작한 후 컨트롤러가 페어링 모드로 전환될 때까지 시간이 걸릴 수 있습니다.

장치의 키 사용

컨트롤러 장치에서 페어링 키를 사용합니다.

등록되지 않은 (램프 꺼짐) 번호의 통신 램프를 선택하고 페어링 키를 길게 눌러 페어링 모드로 전환합니다.

자세한 내용은 다음 절차를 참조하십시오.

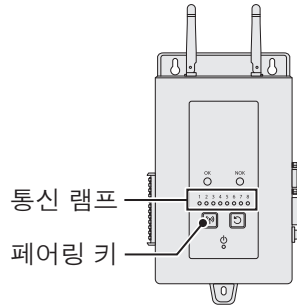

(4번 도구를 등록하려면)

1 컨트롤러에서 페어링 키를 4번 눌러 4번 도구를 선택합니다.

4번 통신 램프가 깜박입니다.



2 4번을 선택하고 있는 동안 컨트롤러의 페어링 키를 길게 눌러 4번 도구의 페어링 모드로 이동합니다.

페어링 모드에서 4번 통신 램프가 빠르게 깜박이기 시작합니다.



3 4번 도구를 작동시켜 페어링을 설정합니다.

4번 통신 램프가 켜져 있습니다. 도구 작동 방법은 “도구에서 페어링 모드 시작”을 참조하십시오.

P30 참조



설정 화면의 설정

상단 페이지 (설정 화면의 초기 페이지)에서 위에 있는 [Settings] 를 클릭하고 “Connected tool” 탭을 선택합니다.

“Connected tool” 화면에서 원하는 도구 번호의 [Pairing] 을 클릭합니다.

컨트롤러가 페어링 모드로 전환된 후 “도구의 페어링 모드 시작”의 절차를 수행합니다.

P30 참조

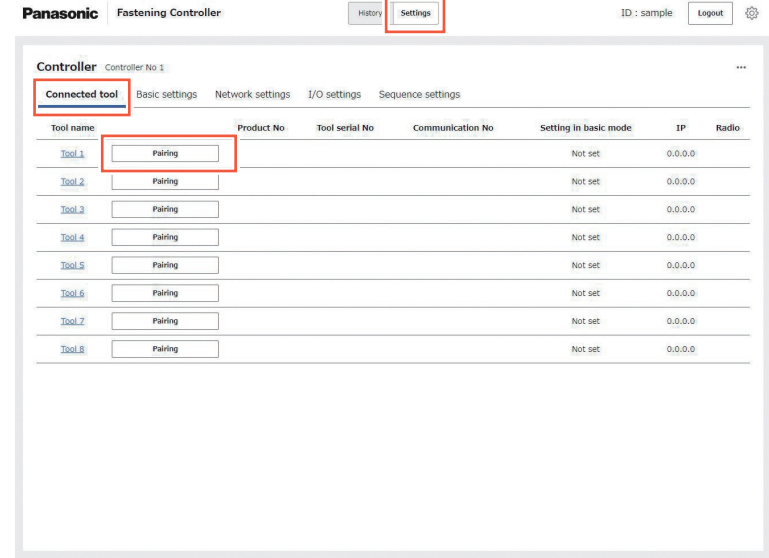

<참조용> 예비 도구로 교체

페어링된 도구에 결함이 있어 동일한 모델 번호의 새 것으로 교체할 때 페어링을 취소 **P30 참조** 한 다음 페어링 **P28 참조** 을 수행하면 체결 매개 변수 및 기타 설정이 자동으로 전송될 수 있습니다.

* 제품 번호가 다른 도구와 페어링하려면 페어링을 취소하여 현재 페어링 정보를 삭제한 후 페어링하십시오. **P34 참조**

페어링 완료 후 표시

페어링이 완료된 후 설정 화면에 페어링된 도구의 정보가 표시되지 않으면 설정 화면에서 디스플레이 업데이트를 수행합니다.

* “Bridge mode” 에서나 “External access point” 가 활성화되었을 때 페어링 등록을 시작하기 전에 도구의 IP 주소를 설정하십시오.

도구에서 페어링 모드 시작

도구에서 페어링 모드를 시작하기 전에 컨트롤러를 페어링 모드로 전환합니다.

■ 절차

- 1** 배터리 팩을 설정합니다. LED 라이트 ON/OFF 버튼을 누른 상태에서 트리거 스위치를 당깁니다.

도구가 페어링 모드로 전환됩니다. 무선 통신이 자동으로 설정되고 페어링 등록이 완료됩니다.

- * 자세한 내용은 도구의 사용설명서를 참조하십시오.
- * 페어링에 실패하는 경우 컨트롤러에서 페어링을 취소한 다음 다시 시도하십시오.

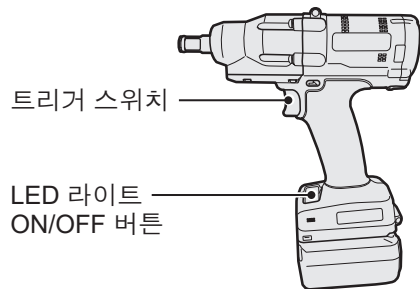

페어링 취소

“장치의 키 사용” 또는 “설정 화면의 설정” 을 통해 컨트롤러에서 페어링 등록을 취소할 수 있습니다.

■ 장치의 키 사용

컨트롤러 장치에서 페어링 키를 사용합니다.

등록을 취소 (램프 점등) 할 도구 번호의 통신 램프를 선택하고 페어링 키를 길게 눌러 페어링 등록을 취소합니다. 자세한 내용은 다음 절차를 참조하십시오.

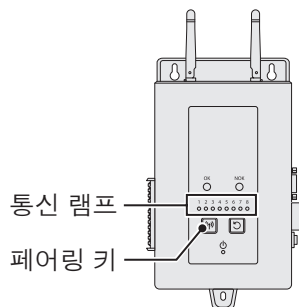

(4번 도구를 취소하려면)

- 1** 컨트롤러에서 페어링 키를 4번 눌러 4번 도구를 선택합니다.

4번 통신 램프가 깜박입니다.



- 2** 4번을 선택하고 있는 동안 컨트롤러의 페어링 키를 길게 눌러 4번 도구의 페어링 등록을 취소합니다.

페어링이 취소되면 4번 통신 램프가 깜박임을 멈추고 꺼집니다.



■ 설정 화면의 설정

상단 페이지 (설정 화면의 초기 페이지)에서 위에 있는 [Settings] 를 클릭하고 “Connected tool” 탭을 선택합니다.

“Connected tool” 화면에서 원하는 도구 번호의 [Cancel Pairing] 을 클릭합니다.

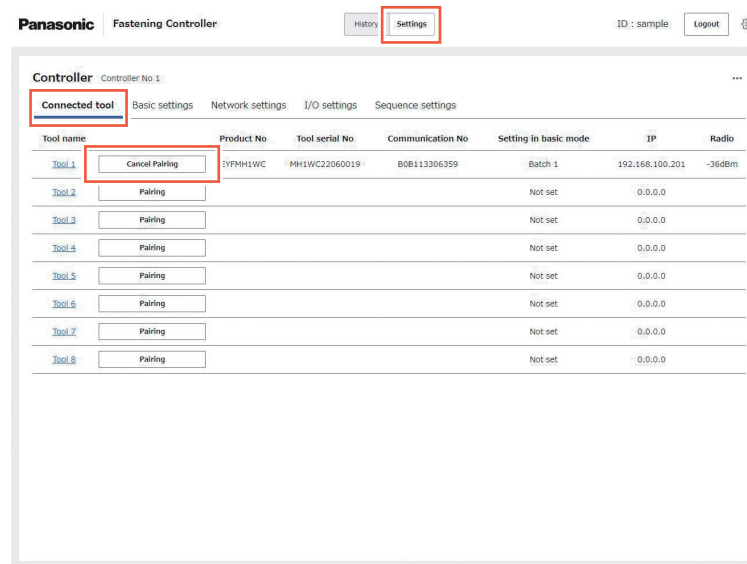

* 도구가 꺼져 있거나 다른 이유로 컨트롤러가 도구와 통신할 수 없는 경우 페어링 취소 확인 대화 상자에서 [Force to unpair] 를 선택하십시오.

도구 화면 표시

상단 페이지(설정 화면의 초기 페이지)에서 위에 있는 [Settings] 를 클릭하고 “Connected tool” 탭을 선택합니다.

“Connected tool” 화면에서 원하는 도구 번호를 클릭합니다.
도구 번호에 대한 화면이 표시됩니다.

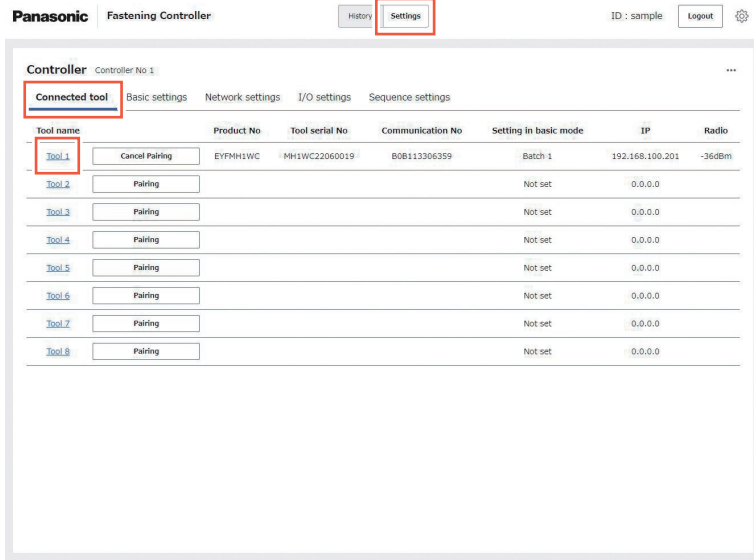

도구 설정 화면 표시

도구 번호에 대한 화면의 “Device settings” 탭에서 도구의 기본 설정을 지정하고 공통 매개 변수를 입력할 수 있습니다.

* 도구를 전환하려면 도구 목록에서 원하는 도구를 선택합니다.

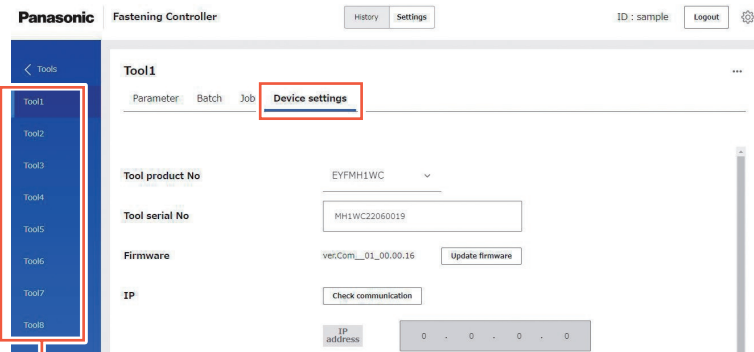

도구 목록

도구 설정 항목

Tool product No

도구 제품 번호를 선택합니다.

[기본] 비어 있음

[설정 범위] 폴다운 메뉴에서 선택 가능

* 사전에 페어링을 설정하면 자동으로 선택됩니다.

* 페어링 후에는 도구 제품 번호를 변경할 수 없습니다. 페어링을 취소한 다음 변경하십시오.

Tool serial No

도구의 장치 식별을 설정하고 표시할 수 있습니다.

[기본] 모델 ID 5자리 + 일련 번호 8자리 (제조연도 2자리 + 월 2자리 + 생산 로트 4자리)

[설정 범위] 영숫자 13~16자

* 정보가 변경되면 모델 번호가 올바르게 인식되지 않을 수 있습니다. 관리 규칙에 따라 필요하지 않는 한 변경하지 마십시오.

Firmware

도구 통신 부분의 펌웨어 버전이 표시됩니다.

펌웨어를 업데이트하려면 [Update firmware] 를 클릭합니다.

업데이트 방법은 “펌웨어 업데이트” 를 참조하십시오. **P81 참조**

IP

도구와의 무선 통신을 위한 IP 주소 (도구 측) 를 설정합니다.

[기본] IP address - 192.168.100.201(도구 1)~208(도구 8)

Subnet mask - 255.255.255.0

Default gateway - 0.0.0.0

* Bridge mode 에서나 “External access point” 가 활성화된 경우 모두 “0.0.0.0” 이 됩니다.

Tool's clock

도구의 시계가 표시됩니다. 시계를 조정하려면 [Adjust to controller] 를 클릭합니다.

• 다른 설정 항목은 도구의 사용설명서를 참조하십시오.

등록 정보 삭제

도구 사용을 중지하거나 제품 번호가 다른 도구를 페어링하려면 페어링 정보를 삭제하십시오.

* 사전에 페어링을 취소하십시오.

1 상단 페이지 (설정 화면의 초기 페이지)에서 위에 있는 [Settings] 를 클릭하고 “Connected tool” 탭을 선택합니다.

“Connected tool” 화면이 표시됩니다.

2 “Connected tool” 화면에서 원하는 도구 번호를 클릭합니다. 도구 번호에 대한 화면이 표시됩니다.

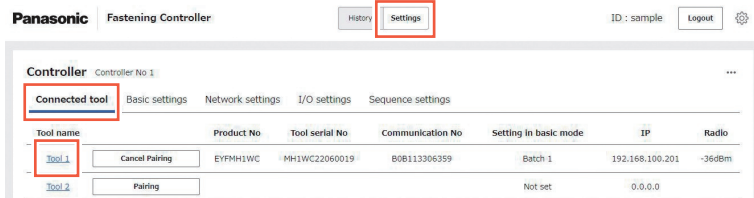

3 ... (도구 옵션 키) 를 클릭한 다음 [Delete tool settings] 를 클릭합니다.

“Delete tool settings” 화면이 표시됩니다.

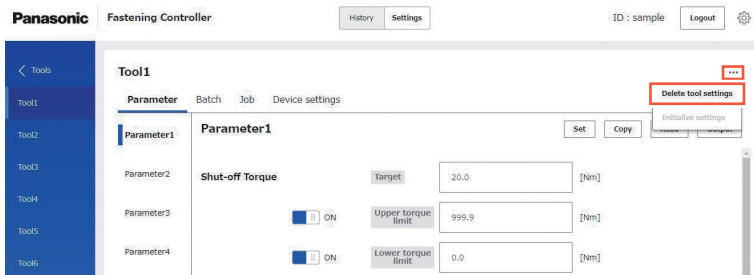

4 “Delete tool settings” 화면에서 [OK] 를 클릭합니다.

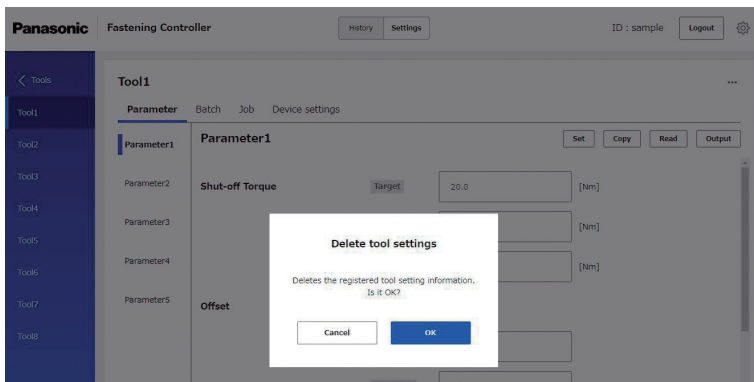

공장 설정으로 재설정

도구를 공장 설정으로 재설정할 수 있습니다.

* 재설정하면 페어링이 취소됩니다.

1 상단 페이지 (설정 화면의 초기 페이지)에서 위에 있는 [Settings] 를 클릭하고 “Connected tool” 탭을 선택합니다.

“Connected tool” 화면이 표시됩니다.

2 “Connected tool” 화면에서 원하는 도구 번호를 클릭합니다. 도구 번호에 대한 화면이 표시됩니다.

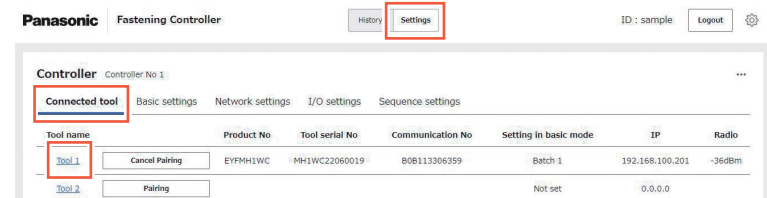

3 ... (도구 옵션 키) 를 클릭한 다음 [Initialize settings] 를 클릭합니다. “Initialize settings” 화면이 표시됩니다.

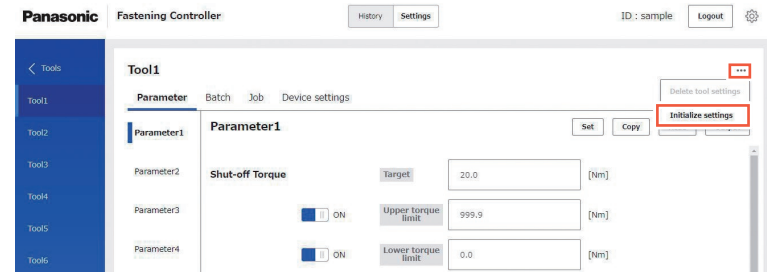

4 “Initialize settings” 화면에서 [OK] 를 클릭합니다.

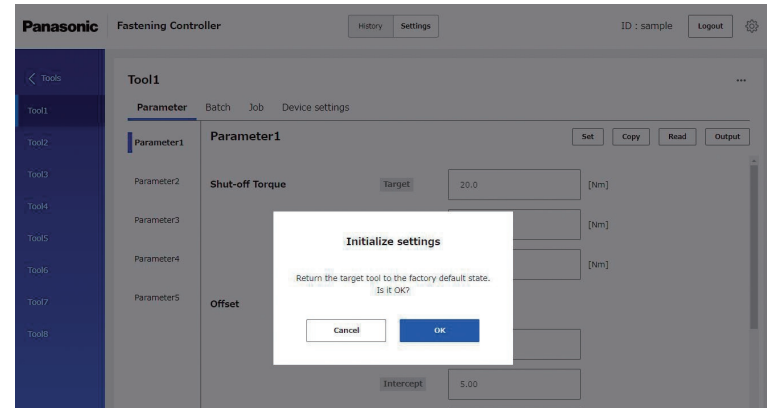

도구 체결 매개 변수 설정

매개 변수 설정

상단 페이지 (설정 화면의 초기 페이지)에서 위에 있는 [Settings] 를 클릭하고 “연결된 도구” 탭을 선택합니다.

“Connected tool” 화면에서 원하는 도구 번호를 클릭합니다.

도구 번호에 대한 화면에서 “Parameter” 탭을 선택하여 설정합니다.

각 도구에 대해 5개의 매개 변수 (매개 변수 1~5)를 설정할 수 있습니다.

* 도구를 전환하려면 도구 목록에서 원하는 도구를 선택합니다.

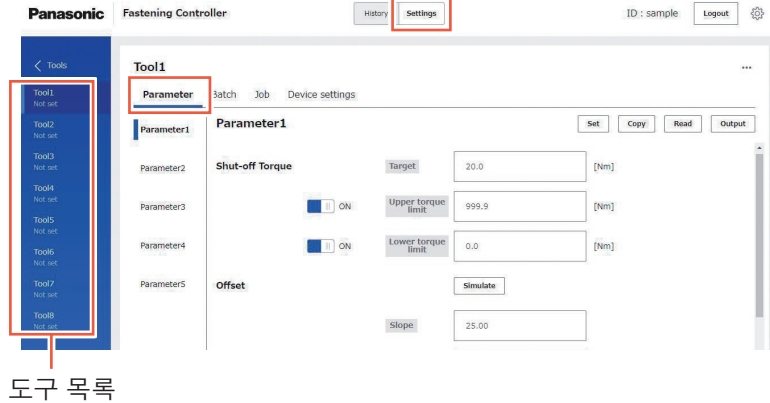

매개 변수 복사

설정된 매개 변수를 복사하여 새 매개 변수를 생성하거나 다른 도구에서 사용할 수 있습니다.

도구 번호에 대한 화면의 “Parameter” 탭에서 [Copy] 를 클릭하여 매개 변수 복사 화면을 표시합니다. 화면에서 대상을 선택하고 [Copy] 를 클릭합니다.

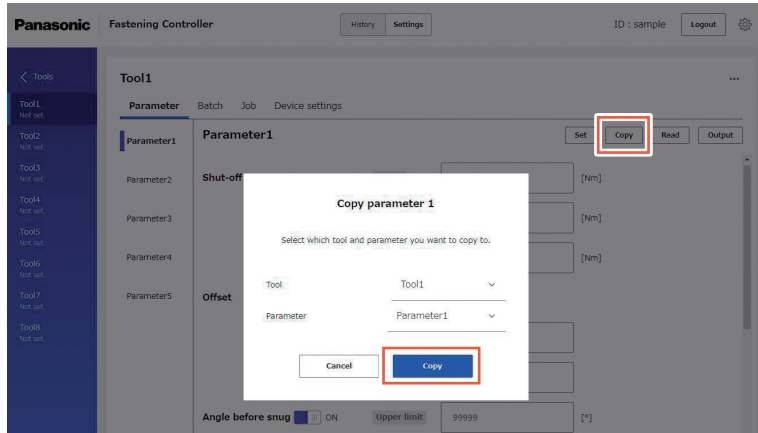

매개 변수 로드

구성용 PC에 저장된 매개 변수 파일을 컨트롤러에 불러와 매개 변수를 등록할 수 있습니다.

“Tool Manager” 로 생성한 매개 변수 파일을 로드할 수도 있습니다.

도구 번호에 대한 화면의 “Parameter” 탭에서 [Read] 를 클릭하여 매개 변수 파일을 엽니다.

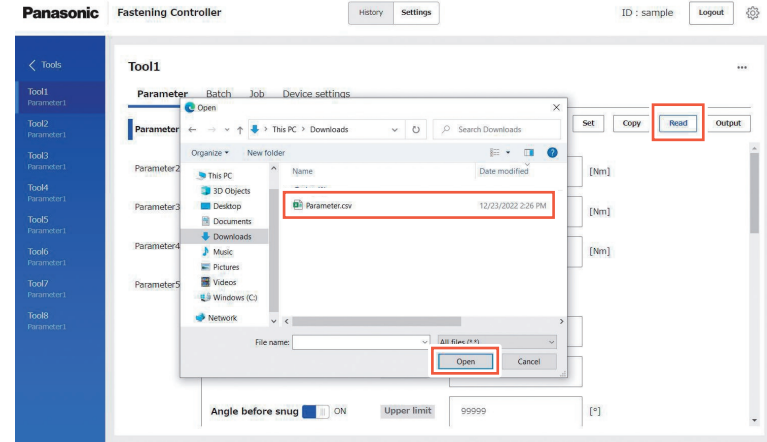

매개 변수 내보내기

생성된 매개 변수를 구성용 PC 로 내보낼 수 있습니다.

내보낸 파일을 백업으로 사용하여 다른 컨트롤러에 복사하거나 다른 구성용 PC로 옮길 수 있습니다.

도구 번호에 대한 화면의 “Parameter” 탭에서 [Output] 을 클릭해 매개 변수 파일을 저장합니다.

내보낸 매개 변수 파일을 편집하지 마십시오.
편집하면 올바르게 읽지 못할 수 있습니다.

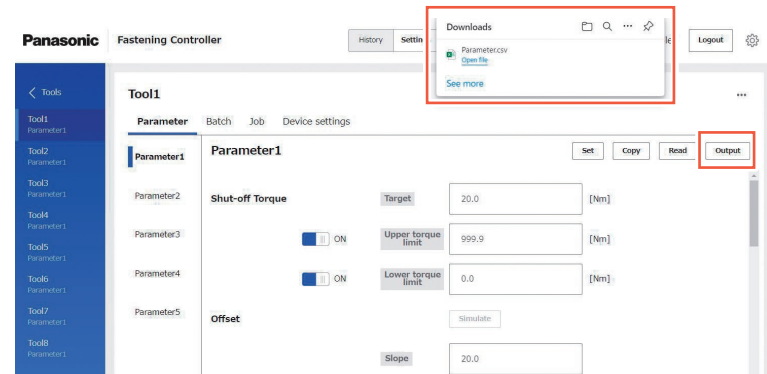

매개 변수 등록

컨트롤러 실행 모드 중 “Free mode” 에서 도구를 제어하는 데 사용하기 위해 매개 변수를 등록합니다.

* “Repeat mode” 와 “External control mode” 에서는 사용되지 않습니다.
 (“Free mode”, “Repeat mode”, “External control mode” 는 “실행 모드 설정” 을 참조하십시오. **P45 참조**)

도구 번호에 대한 화면의 “Parameter” 탭에서 [Set] 을 클릭합니다.

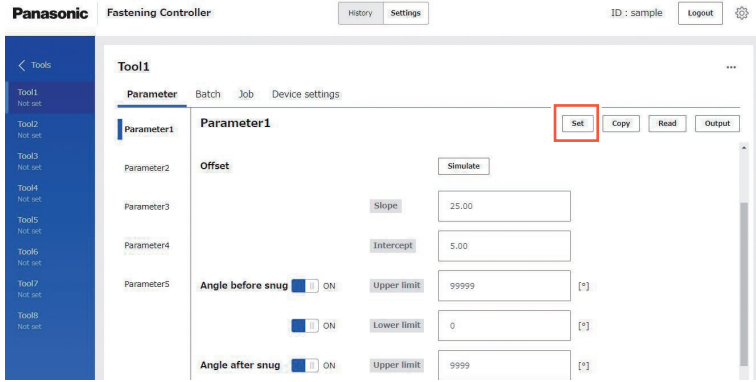

매개 변수 항목

체결 매개 변수 항목을 설정합니다.
 자세한 내용은 도구의 사용설명서를 참조하십시오.

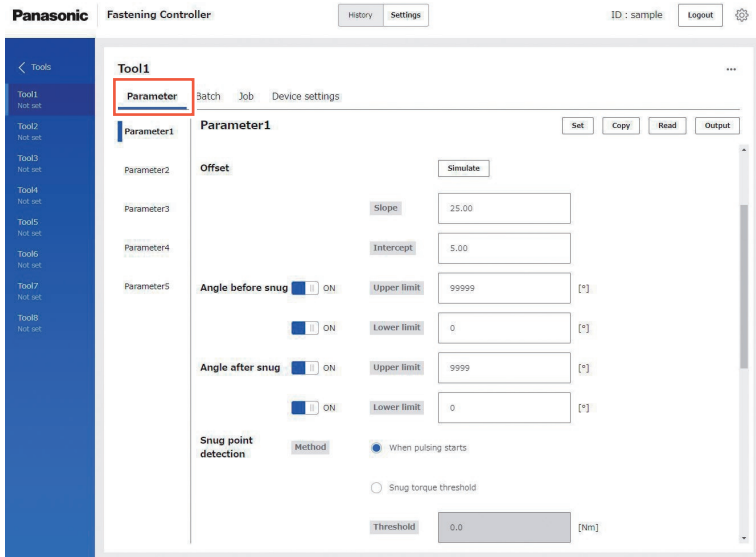

■ 오프셋 설정 (매개 변수, 참조 ①)

토크 출력 값과 실제 측정 값이 일치하도록 오프셋을 설정합니다.

- 1 도구 번호에 대한 화면의 “Parameter” 탭에서 “Offset” 에 있는 [Simulate] 를 클릭합니다.
 “Offset” 페이지가 표시됩니다.

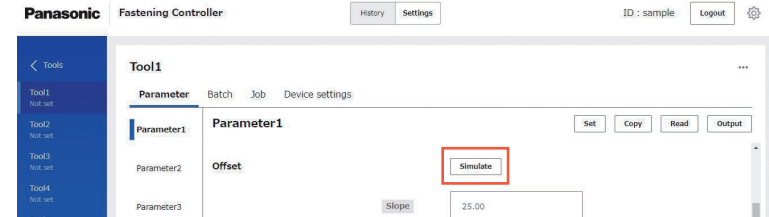

- 2 값을 입력하고 설정하고 [Apply] 를 클릭합니다.
 “Socket length” 와 “Shut-Off Torque” 를 입력합니다.
 [Apply] 를 클릭하여 입력 값을 도구로 보냅니다.
 도구가 오프셋 모드로 전환됩니다 (T2에 표시된 대로).
- 3 도구를 사용하여 실제 작업을 수행한 다음 [Get data] 를 클릭합니다.
 체결 기록 로그가 “Offset” 페이지의 기록 목록에 추가됩니다.
 * [Get data] 를 클릭하면 도구 체결 준비가 완료 (“C 모드”) 되지만 오프셋 설정이 완료될 때까지 정상적인 체결을 시작하지 마십시오.
- 4 획득한 체결 기록 로그를 선택한 상태에서 실제 측정된 토크 (다시 체결) 값을 입력하고 [Calculate] 를 클릭합니다.
 도구의 실제 측정된 토크와 출력 토크를 일치시키는 오프셋이 자동으로 계산됩니다.
- 5 오프셋이 업데이트되었는지 확인하고 [Apply] 를 클릭합니다.
 조정된 값이 도구로 전송됩니다.
- 6 차이가 충분히 작아질 때까지 3~5 단계를 반복합니다.
 * “%” 열의 값이 95%에서 105% 범위 내로 유지하십시오.

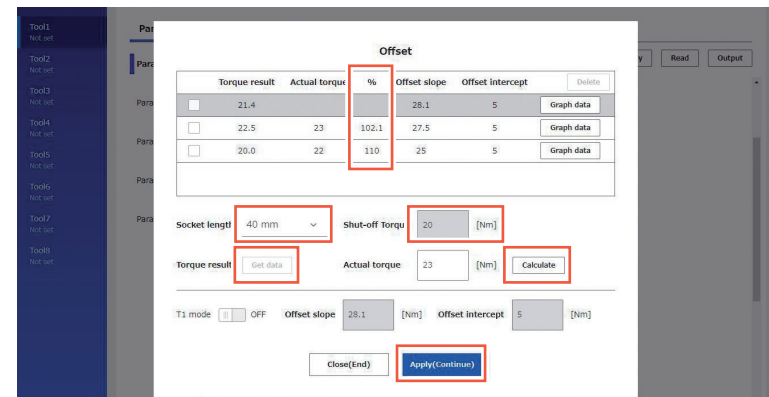

[T1 mode 정보]

오프셋 설정 화면에서 [T1 mode] 를 선택하면 컨트롤러가 최소 출력 모드로 전환됩니다.

([T1 mode] 선택을 취소하면 컨트롤러가 “Offset Mode” 로 되돌아갑니다.)



T1 mode

[설명]
 목표 토크가 컨트롤러의 토크 제어 범위의 하한에 가까워졌을 때 토크 제어가 잘 되는지 확인할 수 있습니다. 이 모드에서는 컨트롤러가 분당 최소 카운트(최소 출력)에서 차단됩니다.
 이때 작업 기록 로고는 저장되지 않습니다.
 이 모드에서 작업한 후 토크 게이지 또는 토크 렌치를 사용하여 컨트롤러의 출력 토크가 목표 토크를 초과하지 않았는지 확인하십시오.
 이 모드에서 출력 토크가 목표 토크를 초과하면 컨트롤러 장치를 일부 작업에 사용하지 못할 수 있습니다.

* 오프셋을 설정하는 동안 다른 도구를 사용한 체결이 일시 중지됩니다.

■ 스너그 포인트 설정(매개 변수, 참조 ②)

파형을 기반으로 스너그 포인트를 설정할 수 있습니다.

1 도구 번호에 대한 화면의 “Parameter” 탭에서 “Snug point detection” 에 있는 [Select from graph] 를 클릭합니다.

- 도구의 현재 파형을 보여주는 “Snug Point detection” 화면이 표시됩니다.
- 체결 기록 데이터는 참조용으로 필요합니다. 한 번 이상 체결 후 설정합니다.
- 화살표(①)와 함께 사용할 파형을 전환할 수 있습니다.

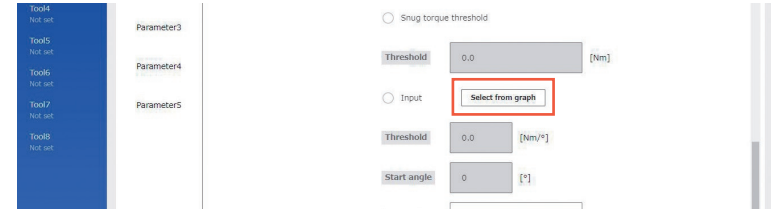

2 그래프에서 임계값을 설정합니다.

- 기본 창(②)은 전체 파형을 표시하고 하위 창(③)은 전체 파형의 특정 부분을 확대합니다.
- 그래프 아래 “X-axis”(④)에서 시작 각도와 종료 각도를 입력하여 기본 창에 표시되는 파형 범위를 변경할 수 있습니다.
- 세로 막대를 이동시켜 스너그 포인트 감지 시작 각도(⑤)를 설정할 수 있습니다.
- 기본 창에서 선택 프레임(⑥) 위치를 조정하여 하위 창의 표시 범위를 변경합니다.
- 하위 창(③)에서 설정할 임계값을 선택합니다.

체결 제어 모드 설정

도구로 체결 제어

컨트롤러는 체결을 위해 최대 8개의 연결된 도구를 제어할 수 있습니다. 각 체결 작업의 체결 데이터를 수신하여 체결 수량을 카운트합니다.

최대 연결 장치 수: 8

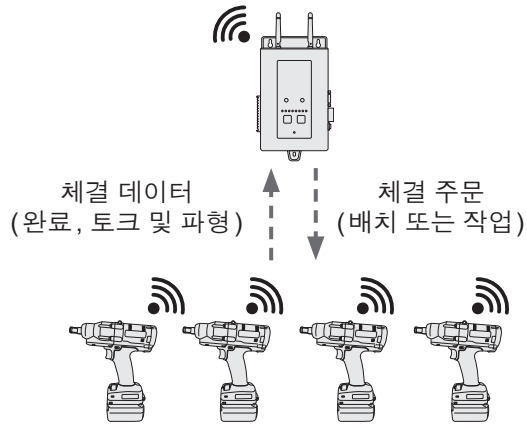

일반적인 체결 제어 조합

다양한 체결 제어 설정 조합을 생성할 수 있습니다. 아래와 같은 일반적인 조합을 참조하십시오.

모드	[Free mode]	[Repeat mode]	
		[Basic mode]	[Sequence mode]
통과 기준	- (수량은 지정되지 않음)	목표 수량 체결이 완료됨	도구는 지정된 주문으로 각각의 목표 수량 체결 완료
[Batch] "단일 설정 값" (동일한 조건에서 체결) * 단일 유형의 공작물	 설정 값 목표 수량 10 Nm ∞ Parameter	 설정 값 목표 수량 10 Nm 10 Batch	 설정 값 목표 수량 10 Nm 10 설정 값 목표 수량 20 Nm 5 Batch 및 Sequence
[Job] 다중 설정 값 (다른 조건에서 체결) * 여러 유형의 공작물		 설정 값 목표 수량 10 Nm 2 20 Nm 3 30 Nm 5 Job	 설정 값 목표 수량 10 Nm 2 20 Nm 3 30 Nm 5 설정 값 목표 수량 20 Nm 5 30 Nm 10 Job 및 Sequence
주의	-	* 작업에는 최대 10단계가 포함될 수 있습니다.	* 시퀀스에는 최대 10단계가 포함될 수 있습니다.

등록 가능한 조합 수

컨트롤러에 등록할 수 있는 조합의 수는 아래와 같습니다.

컨트롤러의 모드		도구의 설정	등록 가능한 조합 수
Free mode		Parameter	○ 도구당 5개의 조합
Repeat mode	Basic mode (독립 제어)	Batch	○ 도구당 5개의 조합
		Job	○ 도구당 5개의 조합
	Sequence mode (순차 제어)	Batch/Job	○ 5개의 조합
External control mode		-	○

실행 모드 설정

컨트롤러의 실행 모드를 아래와 같이 설정합니다.

- 1 상단 페이지(설정 화면의 초기 페이지)에서 위에 있는 [Settings] 를 클릭하고 “Basic settings” 탭을 선택합니다.
- 2 “Basic settings” 탭에서 [Change running mode] 를 클릭합니다. “Change running mode” 화면이 표시됩니다.

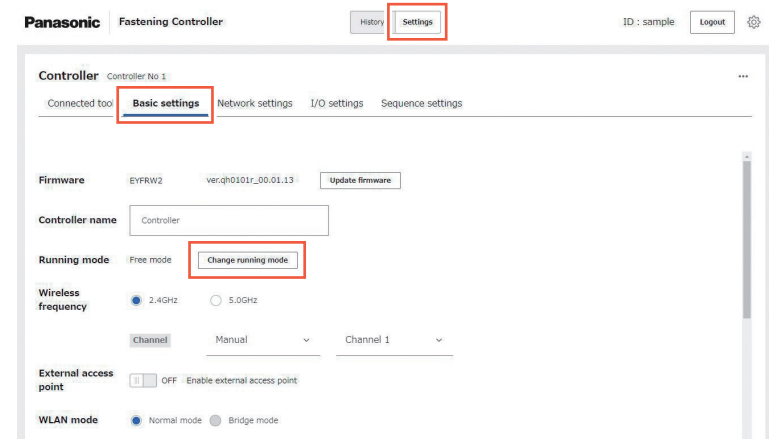

- 3 “Running mode” 를 선택하고 [OK] 를 클릭합니다. 실행 모드가 설정됩니다. “Free mode”, “Repeat mode”, “External control mode” 중에서 실행 모드를 선택합니다. “Repeat mode” 의 경우, “Basic mode” 또는 “Sequence mode” 를 선택합니다. **P46 ~ 49 참조**

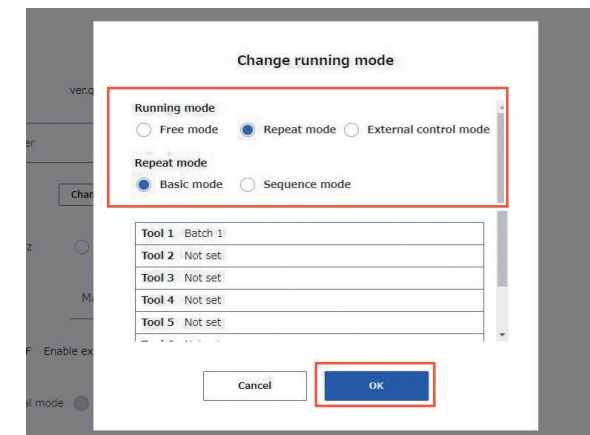

- * “Free mode” 로 설정하기 전에 “Parameter” 를 등록합니다.
- * “Repeat mode” 로 설정하기 전에 “Batch/Job” 을 등록합니다.

체결 제어 모드 설정 (계속)

Free mode

이 모드에서는 체결 수량 지정 없이 무조건 체결할 수 있습니다.
 도구는 체결을 위해 미리 등록된 매개 변수를 사용합니다.
 최대 8개의 도구가 독립적으로 작동할 수 있습니다.
 I/O 출력 설정이 활성화됩니다.
 * 외부 장치에서 체결 수량을 카운트할 때 사용하는 모드입니다.

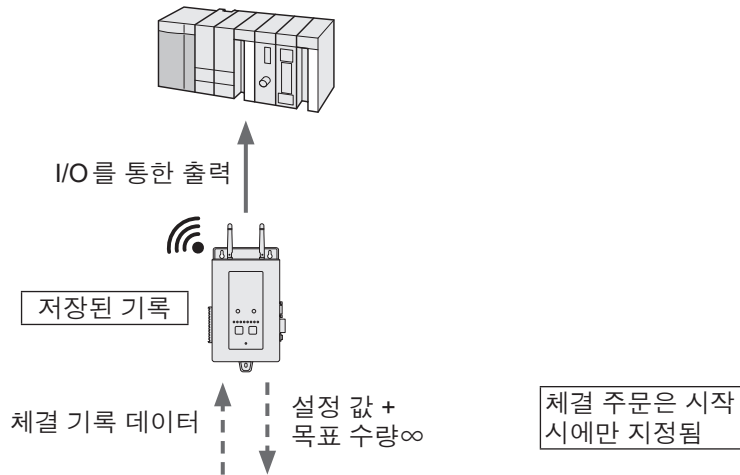

설정 값	목표 수량	설정 값	목표 수량	설정 값	목표 수량	설정 값	목표 수량
10 Nm	∞	20 Nm	∞	30 Nm	∞	40 Nm	∞

최대 8개의 도구를 동시에 제어할 수 있음

설정 값	목표 수량	설정 값	목표 수량	설정 값	목표 수량	설정 값	목표 수량
50 Nm	∞	60 Nm	∞	70 Nm	∞	80 Nm	∞

Repeat mode (Basic mode)

이 모드는 "Batch" 또는 "Job" 프로세스를 반복합니다.
 도구는 체결을 위해 미리 등록된 "Batch" 또는 "Job" 설정을 사용합니다.
 최대 8개의 도구가 독립적으로 작동할 수 있습니다.
 I/O 출력 설정이 활성화됩니다.

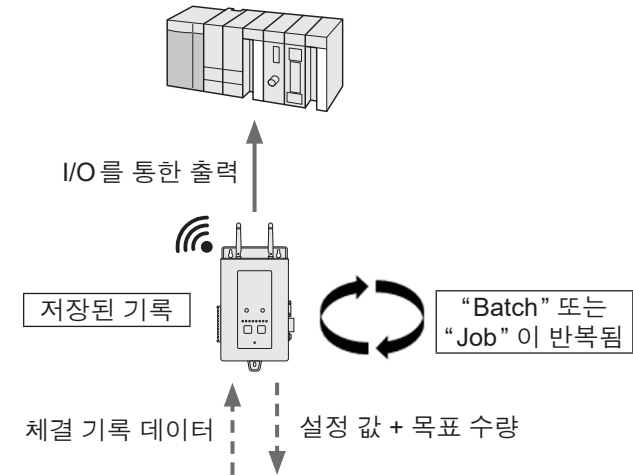

설정 값	목표 수량	설정 값	목표 수량	설정 값	목표 수량	설정 값	목표 수량
10 Nm	10	20 Nm	10	30 Nm	10	40 Nm	10

최대 8개의 도구를 동시에 제어할 수 있음

설정 값	목표 수량	설정 값	목표 수량	설정 값	목표 수량	설정 값	목표 수량
50 Nm	10	60 Nm	10	70 Nm	10	80 Nm	10
60 Nm	5	70 Nm	5	80 Nm	5	90 Nm	5
70 Nm	5	80 Nm	5	90 Nm	5	10 Nm	5

체결 제어 모드 설정 (계속)

Repeat mode (Sequence mode)

이 모드는 사용 가능한 도구가 주문대로 제어되는 "Sequence" 프로세스를 반복합니다. 도구는 순차 체결을 위해 미리 등록된 "Sequence" 설정을 사용합니다. 최대 10 단계까지 설정할 수 있습니다. 시퀀스는 최대 8개의 도구를 지원하지만 한 번에 하나의 도구만 작동시킬 수 있습니다. I/O 출력 설정이 활성화됩니다.

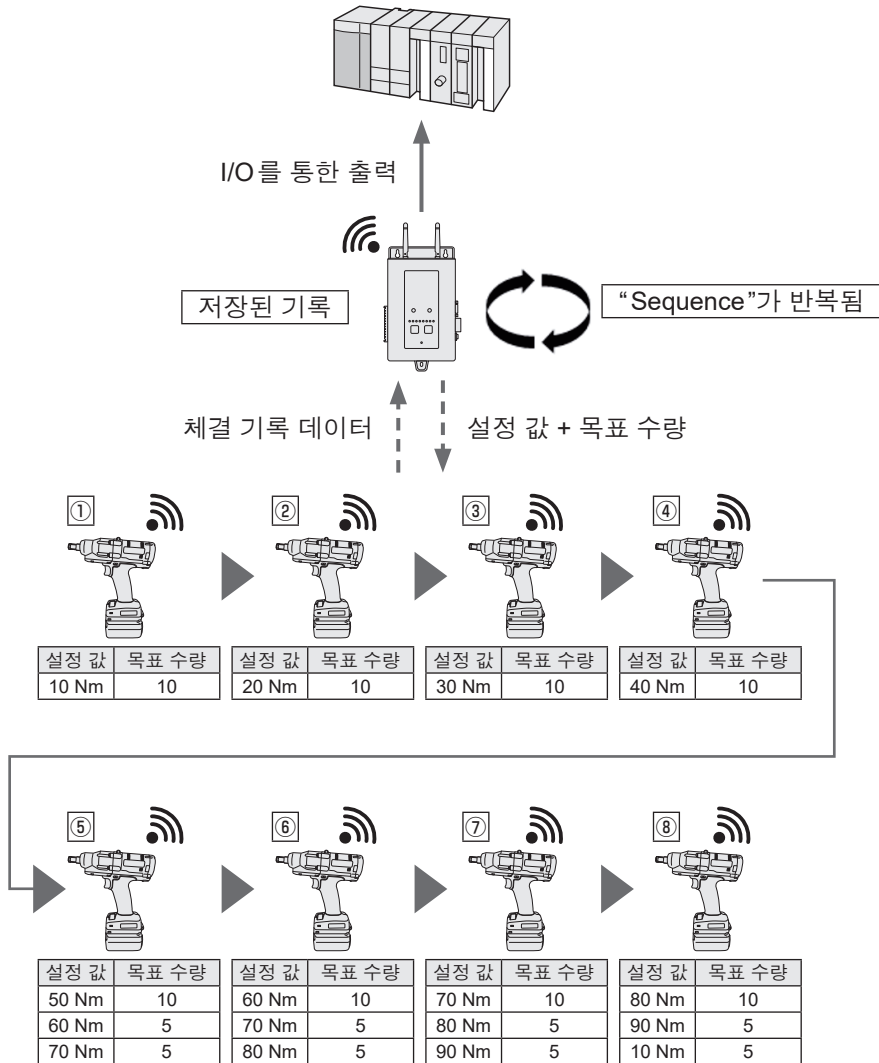

External control mode

이 모드에서는 외부 장치(호스트 시스템)의 주문에 따라 체결 제어가 가능합니다. 다음 2가지 유형의 제어가 지원됩니다.

● 개방형 프로토콜을 통한 제어(개방형 프로토콜 활성화)

호스트 시스템이 개방형 프로토콜을 통해 체결을 제어합니다. 최대 8개의 도구를 독립적으로 제어할 수 있습니다. *작업 및 시퀀스 제어는 지원되지 않습니다.

● I/O를 통한 제어(개방형 프로토콜 비활성화)

외부 장치의 I/O 포트를 통한 입력으로 체결을 제어합니다. 최대 8개의 도구를 독립적으로 제어하거나 순차적으로 제어할 수 있습니다.

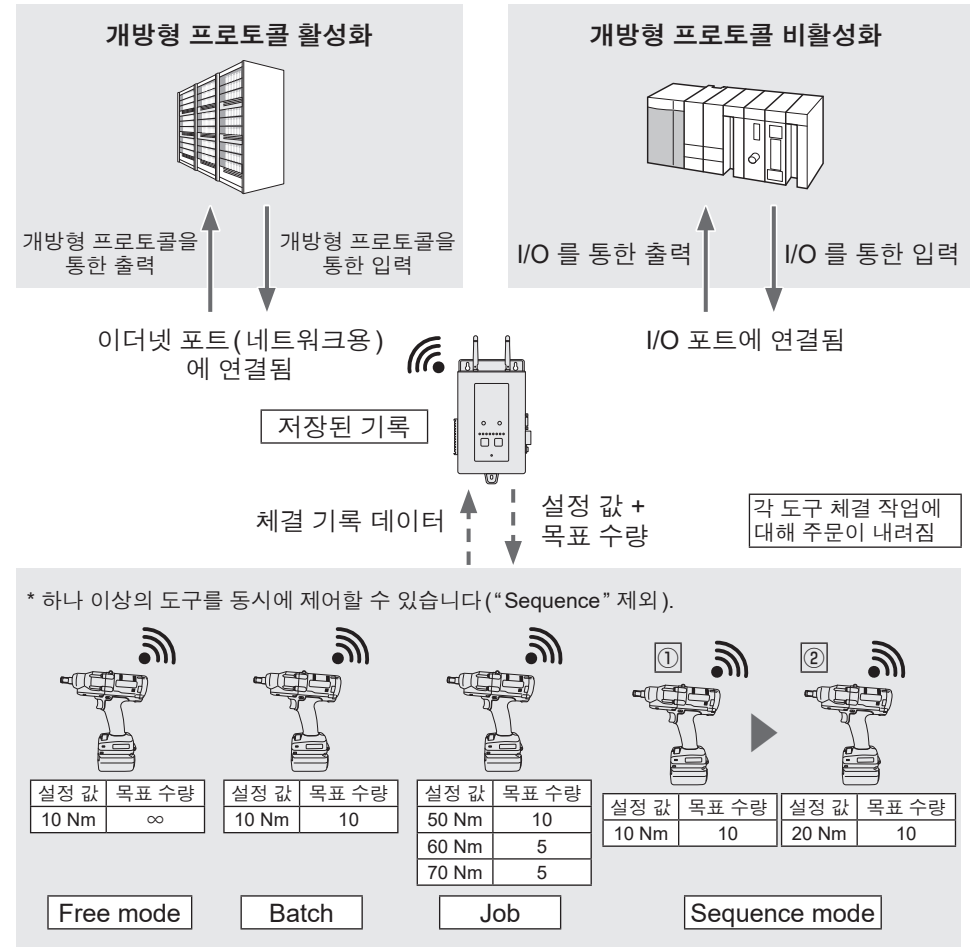

* 체결 도중 컨트롤러가 꺼지면 컨트롤러가 켜진 후 체결이 재개되지 않습니다. 외부 장치에서 주문하면 체결이 다시 시작됩니다.

* I/O 출력 설정이 활성화됩니다.

배치 생성 (설정)

상단 페이지(설정 화면의 초기 페이지)에서 위에 있는 [Settings] 를 클릭하고 “Connected tool” 탭을 선택합니다. “Connected tool” 화면에서 원하는 도구 번호를 클릭합니다. 도구 번호에 대한 화면에서 “Batch” 탭을 선택하여 설정합니다. “Parameter” 풀다운 메뉴에서 매개 변수를 선택하고 “Batch size” (체결 수량, 최대 99 개)를 설정합니다. [Set] 을 클릭하여 “Repeat mode (Basic mode)” 의 값을 설정합니다.

- * 도구를 전환하려면 도구 목록에서 원하는 도구를 선택합니다.
- * 최대 5개의 배치를 등록할 수 있습니다.

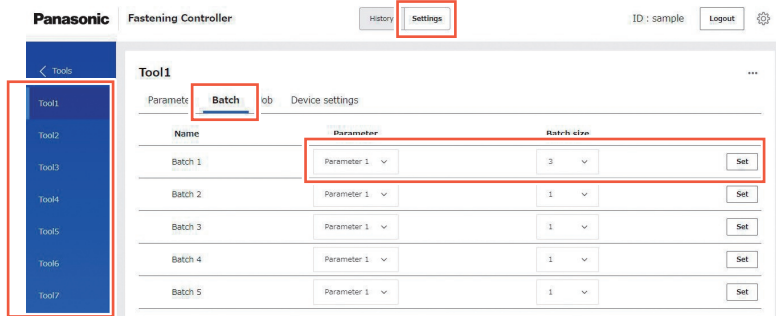

도구 목록

작업 생성 (설정)

상단 페이지(설정 화면의 초기 페이지)에서 위에 있는 [Settings] 를 클릭하고 “Connected tool” 탭을 선택합니다. “Connected tool” 화면에서 원하는 도구 번호를 클릭합니다. 도구 번호에 대한 화면에서 “Job” 탭을 선택하여 설정합니다. “Parameter” 풀다운 메뉴에서 매개 변수를 선택하고 “Batch size” (체결 수량, 최대 99 개)를 설정합니다. [Set] 을 클릭하여 “Repeat mode (Basic mode)” 의 값을 설정합니다.

- * 최대 10단계를 등록할 수 있습니다.
- * 도구를 전환하려면 도구 목록에서 원하는 도구를 선택합니다.
- * 최대 5개의 작업을 등록할 수 있습니다.

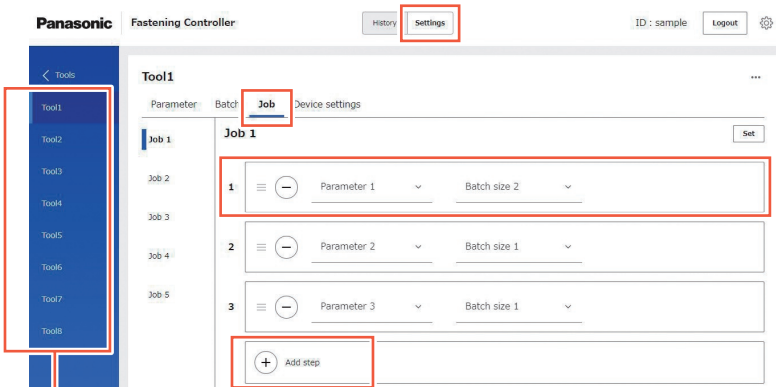

도구 목록

시퀀스 생성 (설정)

상단 페이지(설정 화면의 초기 페이지)에서 위에 있는 [Settings]를 클릭하고 “Sequence settings” 탭을 선택합니다.

“Sequence settings” 화면의 “Tool” 풀다운 메뉴에서 도구를 선택하고 “Batch” 또는 “Job” 을 설정합니다.

[Set as running mode] 를 클릭하여 “Repeat mode (Sequence mode)” 에 대한 값을 설정합니다.

- * 최대 5개의 시퀀스를 등록할 수 있습니다.
- * 최대 10단계를 등록할 수 있습니다.
- * 동일한 도구를 시퀀스에서 두 번 이상 사용할 수 있습니다.

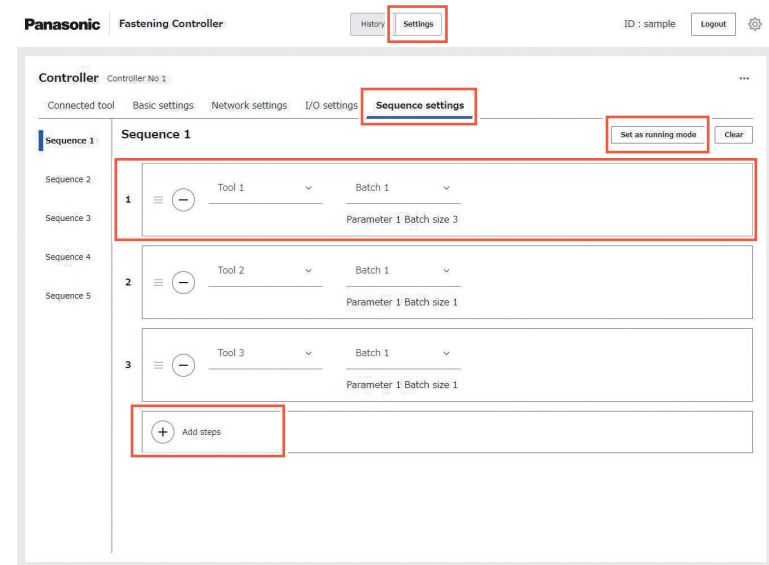

지원되는 외부 장치 유형

컨트롤러는 다음 유형의 외부 장치를 지원합니다.

기능	구성용 PC	PLC	고객의 호스트 시스템
그림			
통신 방법	Ethernet	I/O	Ethernet
통신 프로토콜	http/https	— (ON/OFF 신호만)	개방형 프로토콜을
주 용도	<ul style="list-style-type: none"> 체결 기록 보기 및 저장 설정 변경 	<ul style="list-style-type: none"> 완료 및 실패 신호 출력 체결 주문 전환 	<ul style="list-style-type: none"> 체결 기록 내보내기 체결 주문 전환
내보낼 수 있는 데이터	<ul style="list-style-type: none"> 도구의 일련 번호 시간 완료 및 실패 결과 토크 값, 각도, 체결 시간 길이 파형 데이터 	<ul style="list-style-type: none"> 완료 및 실패 결과 Batch/job/sequence 완료 Batch/job/sequence 선택됨 도구 활성화 	<ul style="list-style-type: none"> 도구의 일련 번호 시간 완료 및 실패 결과 토크 값, 각도, 체결 시간 길이 파형 데이터
체결 주문 전환	—	<ul style="list-style-type: none"> Batch/job/sequence 선택됨 	<ul style="list-style-type: none"> Parameter/batch 선택됨
기타	웹 브라우저에 표시됩니다. Microsoft Edge 가 권장됩니다.	각 입력 및 출력용 포트 8개	지원되는 명령은 “개방형 프로토콜과 호환되는 명령”을 참조하십시오. P61 참조 제어 순서는 각각 검토해야 합니다.

원격 위치에서 구성용 PC에 연결

인증서가 설치된 구성용 PC는 컨트롤러에 원격으로 연결할 수 있습니다. 한 번에 하나의 구성 기능 액세스만 허용됩니다. 연결하려면 웹 브라우저에 원하는 컨트롤러의 IP 주소를 입력합니다.

P21 참조



I/O를 통한 연결

8개의 입력 포트와 8개의 출력 포트에 지원되는 명령을 원하는 대로 할당할 수 있습니다.

“I/O settings” 화면에서 할당합니다.

포트에 할당할 수 있는 명령은 다음과 같습니다.

입력	지원되는 명령	출력	지원되는 명령
1	Batch (도구 1~5) Job (도구 1~5) Sequence (1~5) Batch reset (1~8) Reset Suspend tool (1~8) Suspend controller	1	OK(도구 1~8) NOK(도구 1~8) Batch complete (도구 1~5) Job complete (도구 1~5) Sequence complete (1~5) Tool active (도구 1~8) Batch selected (도구 1~5) Job selected (도구 1~5) Sequence selected (1~5)
2		2	
3		3	
4		4	
5		5	
6		6	
7		7	
8		8	

I/O 설정

상단 페이지(설정 화면의 초기 페이지)에서 위에 있는 [Settings] 를 클릭하고 “I/O settings” 탭을 선택합니다.

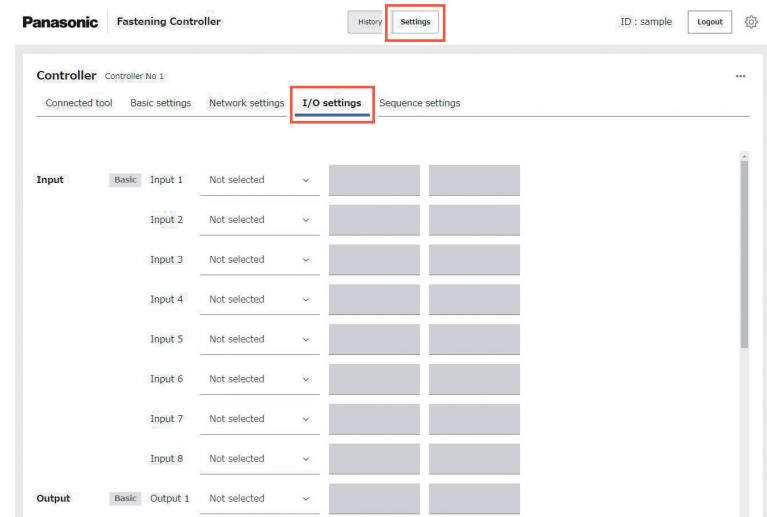

* 아직 등록되지 않은 동작이나 이벤트를 지정할 수 있습니다. (직업 선택 및 시퀀스 선택 제외)

입력 포트에 할당된 명령

입력 포트에 할당할 수 있는 명령은 다음과 같습니다.
외부 장치의 신호가 포트 중 하나에 입력되면 할당된 명령이 실행됩니다.

주요 범주 (동작)	중간 범주 (도구)	부분 범주 (배치 번호 등)
Batch	도구 1~8	1-5
Job	도구 1~8	1-5
Sequence	-	1-5
Suspend tool*1	도구 1~8	-
Suspend controller*1	-	-
Batch reset	도구 1~8	-
Reset	-	-

*1 입력 신호가 유지되는 동안에만 활성화됩니다.

“Suspend tool” 또는 “Suspend controller” 명령이 입력인 경우

- “Suspend controller” 가 활성 상태인 경우 체결 주문이 허용되지 않습니다.
- “Suspend tool” 이 활성화된 도구 번호의 경우 “Batch” 또는 “Job” 체결 주문이 허용되지 않습니다.
- “Suspend tool” 이 활성화된 도구 번호 이외의 도구 번호에서는 “Batch” 또는 “Job” 체결 주문이 허용됩니다.
- “Suspend tool” 이 활성 상태인 경우 “Sequence” 체결 주문이 허용되지 않습니다. 이때 “Suspend tool” 이 활성화된 도구에 도달할 때까지 프로세스가 계속됩니다.
- “Batch reset” 및 “Reset” 은 체결 주문과 동일한 방식으로 취급됩니다.

주요 범주에서 동작을 선택하고 도구를 선택한 다음 필요에 따라 번호 (예: 배치 번호)를 선택합니다.

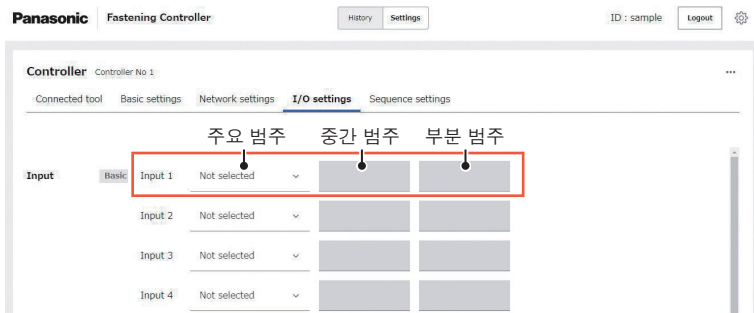

* 할당되지 않은 신호가 입력되면 아무 조치도 취하지 않습니다. (발생 오류 없음)

출력 포트에 할당된 명령

출력 포트에 할당할 수 있는 명령은 다음과 같습니다.
해당 이벤트가 발생하면 컨트롤러는 할당된 명령에 지정된 대로 해당 포트에서 외부 장치로 신호를 출력합니다.

주요 범주 (이벤트)	중간 범주 (도구)	부분 범주 (배치 번호 등)
OK	도구 1~8	-
NOK	도구 1~8	-
Batch complete	도구 1~8	1-5
Job complete	도구 1~8	1-5
Sequence complete	-	1-5
Tool active	도구 1~8	-
Batch selected	도구 1~8	1-5
Job selected	도구 1~8	1-5
Sequence selected	-	1-5

주요 범주에서 이벤트를 선택하고 도구를 선택한 다음 필요에 따라 번호 (예: 배치 번호)를 선택합니다.

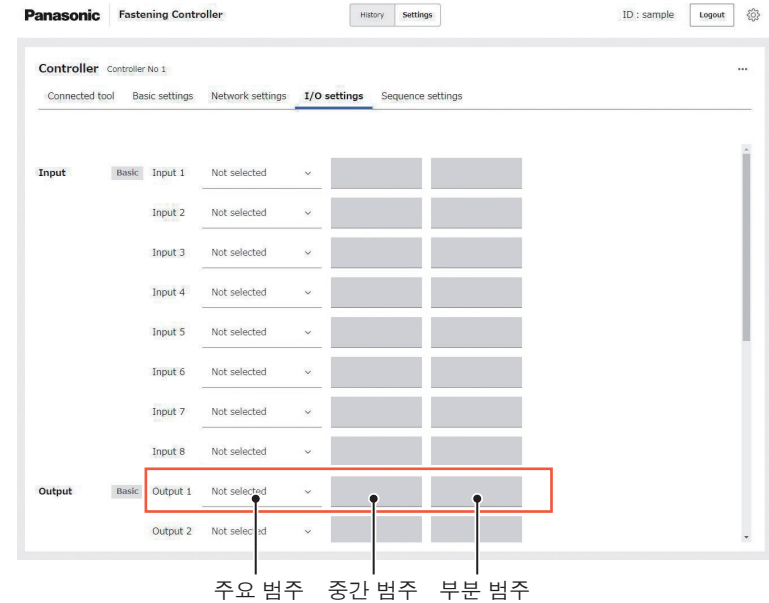

* 출력 명령을 실행하는 동안 컨트롤러가 꺼지면 컨트롤러가 켜진 후 프로세스가 다시 시작되지 않습니다. (체결 기록 데이터가 저장됩니다.)

기타 설정

아래와 같이 기타 I/O 관련 설정을 지정할 수 있습니다.

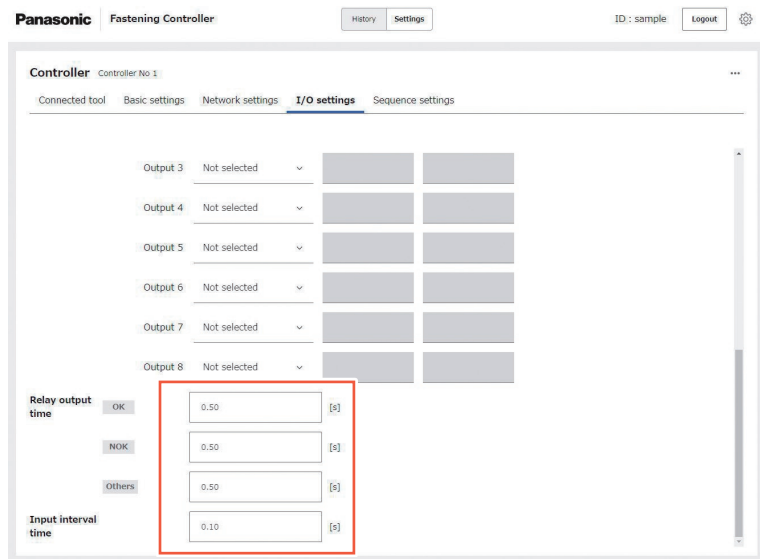

Relay output time (OK)

체결 완료 신호가 릴레이로 출력될 때까지의 시간을 선택합니다.

[기본] 0.5 s

[설정 범위] 0.01 s~10 s

Relay output time (NOK)

체결 실패 신호가 릴레이로 출력될 때까지의 시간을 선택합니다.

[기본] 0.5 s

[설정 범위] 0.01 s~10 s

Relay output time (Others)

체결 완료 및 실패 신호 이외의 신호가 릴레이에서 출력될 때까지의 시간을 선택합니다.

[기본] 0.5 s

[설정 범위] 0.01 s~10 s

Input interval time

연속 입력 신호를 카운트(수락)하지 않는 시간을 선택합니다.

노이즈 등에 의한 중복 카운트를 방지하기 위해 설정합니다.

[기본] 0.1 s

[설정 범위] 0.01 s~10 s

개방형 프로토콜 통신을 통한 연결

상단 페이지(설정 화면의 초기 페이지)에서 위에 있는 [Settings] 를 클릭하고 “Network settings” 탭을 선택합니다.

“Atlas Open Protocol” 을 활성화합니다.
각각 사용하는 도구에 포트 번호를 설정합니다.

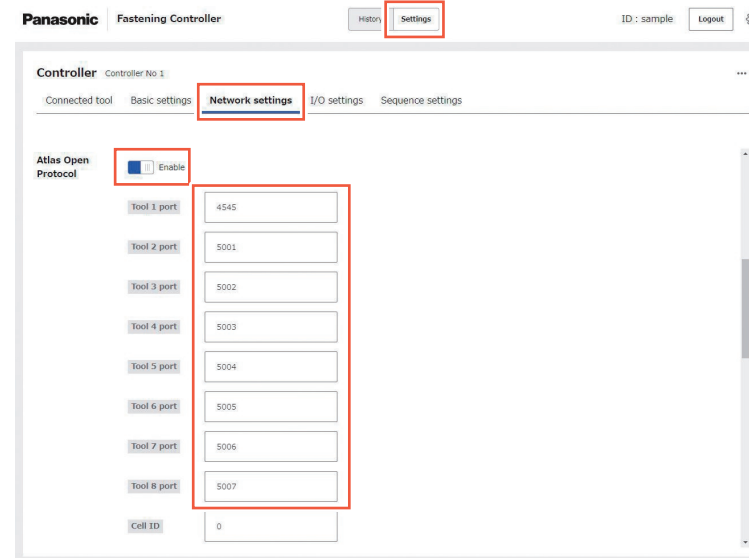

Tool port

개방형 프로토콜 통신을 위한 포트 번호를 각 도구에 할당합니다.

[기본] 도구 1 - 4545,

도구 2~8 - 5001~5007

[설정 범위] 도구 1~8 - 1024~49151

기타 설정

필요에 따라 다른 항목을 설정합니다.

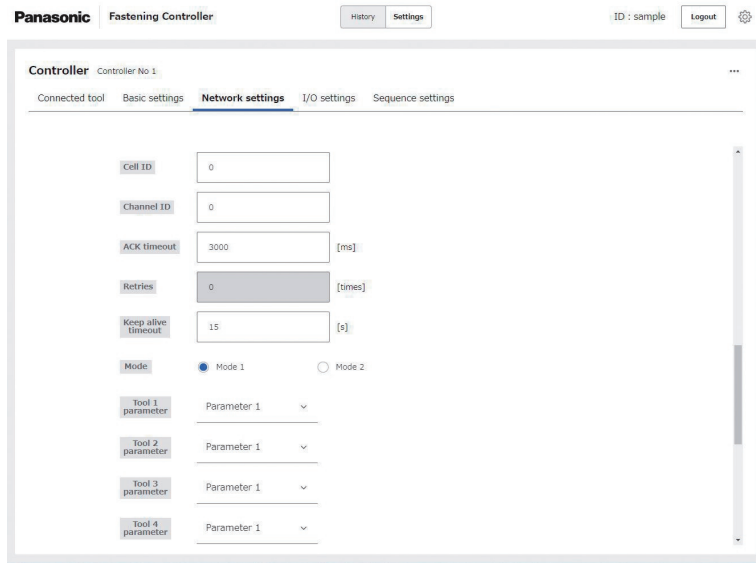

Cell ID
셀 ID를 설정합니다. [기본] 0 [설정 범위] 0~9999
Channel ID
채널 ID를 설정합니다. [기본] 0 [설정 범위] 0~99
ACK timeout
컨트롤러의 요청 메시지에 대한 응답을 기다리는 시간을 설정합니다. [기본] 3000 ms [설정 범위] 100 ms~30000 ms
Retries
컨트롤러에서 요청 메시지 전송을 반복할 횟수를 설정합니다. [기본] 0 times [설정 범위] 선택할 수 없음(고정됨)

Keep alive timeout

호스트 시스템과의 마지막 통신 후 연결이 끊어진 경우를 판단하는 시간을 설정합니다.
 [기본] 15 s
 [설정 범위] 1 s~60 s

Mode

실행 모드를 설정합니다.
 Mode 1: 미리 등록된 매개 변수로 무조건 체결
 Mode 2: 호스트 시스템에서 주문한 매개 변수로 체결
 [기본] Mode 1
 [설정 범위] Mode 1 / Mode 2

체결 매개 변수 할당 (Mode 1)

“Mode 1”(주문한 매개 변수 없음)에는 도구에 미리 등록된 체결 매개 변수가 필요합니다.

아래와 같이 풀다운 메뉴에서 매개 변수를 선택합니다.

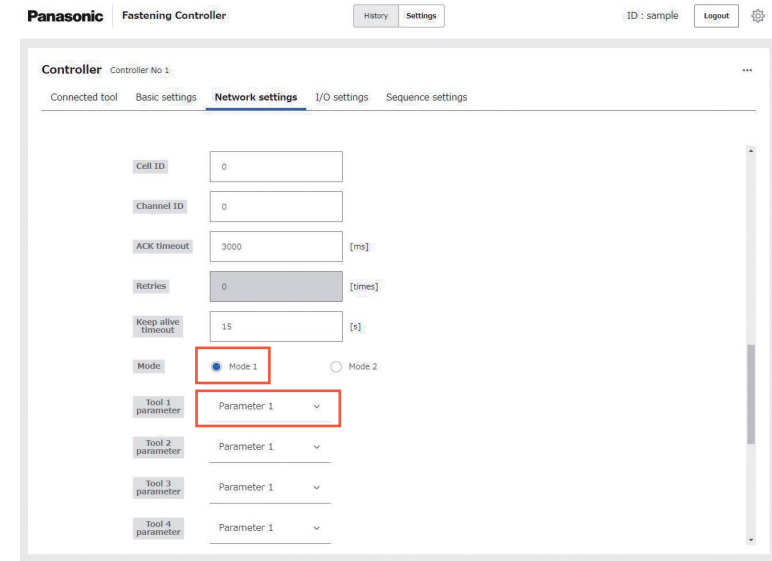

체결 매개 변수 할당 (Mode 2)

체결은 외부 장치에서 MID 0018 주문을 통해 명령할 수 있습니다.
체결 주문에 “Parameter” 또는 “Batch” 를 지정할 수 있습니다.

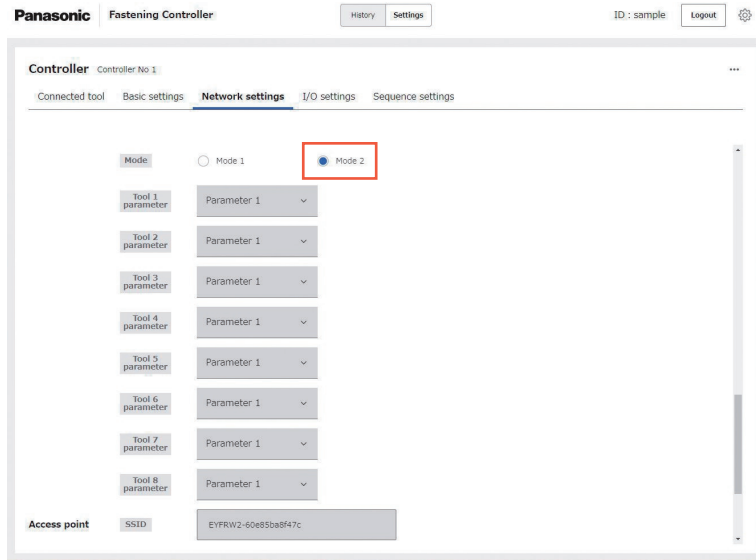

체결 주문에 “Parameter” 를 지정하려면

ID 의 백 자리에 “0” 을 입력합니다.
십의 자리와 일의 자리는 매개 변수 번호를 나타냅니다.

예: 매개 변수 1 의 ID: 001
매개 변수 5 의 ID: 005

체결 주문에 “Batch” 를 지정하려면

ID 의 백 자리에 “1” 을 입력합니다.
십의 자리와 일의 자리는 배치 번호를 나타냅니다.

예: 배치 1 의 ID: 101
배치 5 의 ID: 105

* “Job” 및 “Sequence” 제어는 지원되지 않습니다.

개방형 프로토콜과 호환되는 명령

컨트롤러는 다음 명령을 지원합니다.
명령에 대한 자세한 내용은 개방형 프로토콜 사양을 참조하십시오.

MID 0001 Application communication start
개정 1 이 지원됩니다. [내용] 통신 시작
MID 0002 Application communication start acknowledge
개정 1 이 지원됩니다. [내용] 통신 확인
MID 0004 Application command error
개정 1 이 지원됩니다. [내용] 명령 오류
MID 0005 Application command accepted
개정 1 이 지원됩니다. [내용] 명령 수락
MID 0018 Select parameter set, Dynamic Job included
개정 1 이 지원됩니다. 할당 방법은 “체결 매개 변수 할당 (Mode 2)” 을 참조하십시오. P60 참조 [내용] 매개 변수 설정 주문
MID 0042 Disable tool
개정 1 이 지원됩니다. [내용] 도구 비활성화됨
MID 0043 Enable tool
개정 1 이 지원됩니다. [내용] 도구 활성화됨
MID 0050 Vehicle ID number download request
개정 1 이 지원됩니다. [내용] 차량 ID 취득 요청

MID 0060 Last tightening result data subscribe
개정 1과 2가 지원됩니다. [내용] 최종 체결 결과 데이터 등록
MID 0061 Last tightening result data
개정 1과 2가 지원됩니다. [내용] 체결 결과 업로드
MID 0062 Last tightening result data acknowledge
개정 1과 2가 지원됩니다. [내용] 체결 결과 업로드 승인
MID 9999 Keep alive message
개정 1이 지원됩니다. [내용] 가용성 확인

설정

컨트롤러는 내장된 액세스 포인트 대신 외부 액세스 포인트를 사용하여 무선 통신을 통해 도구에 연결할 수 있습니다.

컨트롤러는 설치된 위치에 관계없이 도구를 제어할 수 있습니다.

액세스 포인트와 컨트롤러를 유선 LAN에 연결합니다.

* 무선 범위와 성능은 사용하는 액세스 포인트에 따라 달라집니다.

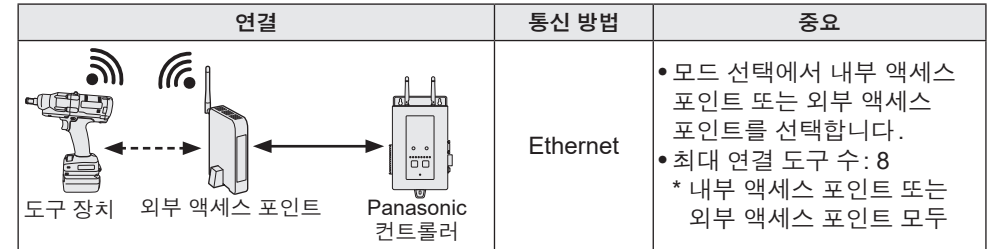

설정 절차

1 상단 페이지 (설정 화면의 초기 페이지)에서 위에 있는 [Settings]를 클릭하고 “Basic settings” 탭을 선택한 다음 “External access point”를 “ON”으로 설정합니다.

* “External access point”가 활성화되면 “WLAN mode”가 비활성화됩니다.

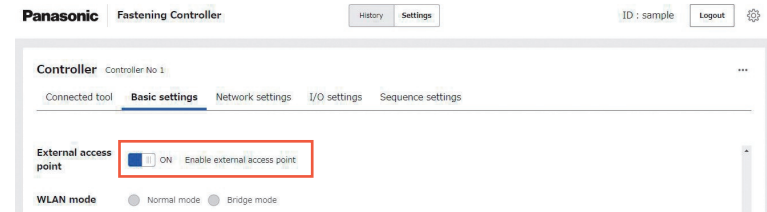

2 상단 페이지 (설정 화면의 초기 페이지)에서 위에 있는 [Settings]를 클릭하고 “Network settings” 탭을 선택합니다. “External access point”에서 “SSID”, “Security”, “Password”를 설정합니다.

* 컨트롤러에는 하나의 SSID만 등록할 수 있습니다. (도구마다 다른 SSID를 등록할 수 없음)

* 외부 액세스 포인트의 사용설명서를 참조하십시오.

* 도구와 페어링 등록을 시작하기 전에 이 설정을 지정합니다.

* 페어링 등록을 시작하기 전에 도구의 IP 주소를 설정합니다.



표시 램프 및 버저

표시 램프 및 버저는 컨트롤러의 상태를 표시합니다.

주의

램프가 깜박이는 동안에는 전원 스위치를 끄지 마십시오.
초기화가 필요할 수 있습니다.

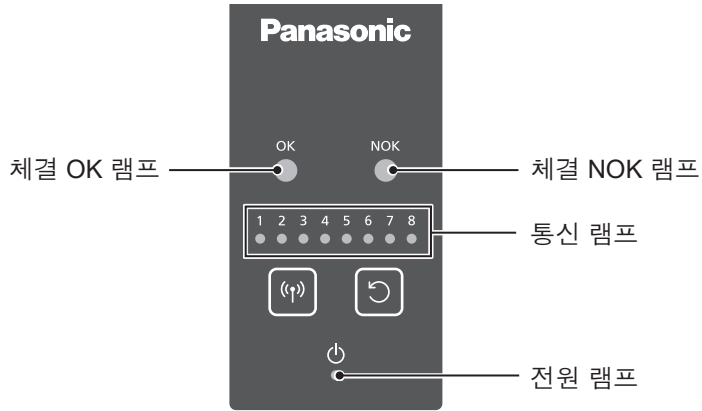

상태	표시 램프	버저
전원 켜짐	전원 램프 (노란색) 계속 켜짐	—
페어링할 도구가 선택됨	통신 램프 (파란색) 느리게 깜박임	—
페어링 설정됨	통신 램프 (파란색) 빠르게 깜박임	—
페어링 완료됨	통신 램프 (파란색) 계속 켜짐	짧은 신호음 ■
페어링되지 않음	통신 램프 (파란색) 매우 느리게 깜박임	—
페어링 연결 끊김	통신 램프 (파란색) 꺼짐	—
체결 완료	OK 램프 (녹색) 계속 켜짐	짧은 신호음 ■
체결 실패	NOK 램프 (빨간색) 계속 켜짐	긴 신호음 ■■■
Batch/job 완료	OK 램프 (녹색) 두 번 깜박임	짧은 신호음 2 번 ■■
시퀀스 완료	OK 램프 (녹색) 세 번 깜박임	짧은 신호음 3 번 ■■■
오류	전원 램프 (노란색) 깜박임	긴 신호음 2 번 ■■■■

버저 설정

상단 페이지 (설정 화면의 초기 페이지)에서 위에 있는 [Settings] 를 클릭하고 “Basic settings” 탭을 선택합니다.
“Buzzer” 에서 “Volume” 및 “Beep” 를 설정합니다.

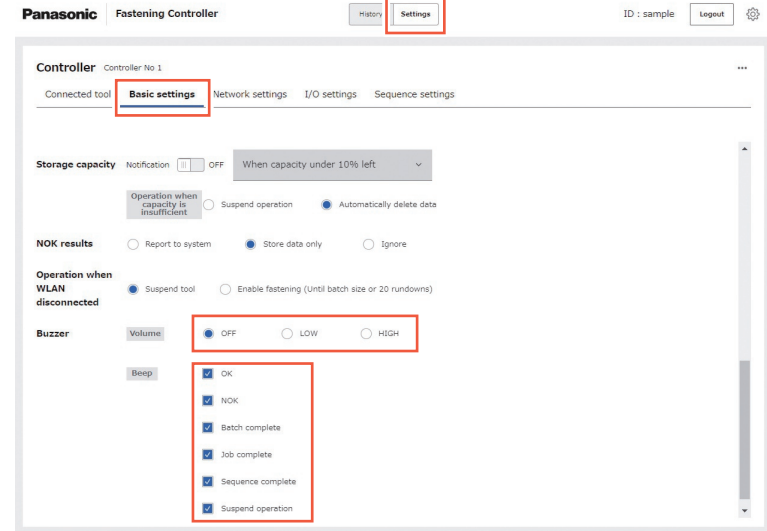

항목	설명
Volume	3 레벨 (OFF/LOW/HIGH) (LOW: 75dB, HIGH: 85dB)
Beep	구성용 PC 에서 선택됨 (OK/NOK/Batch complete/Job complete/Sequence complete/Suspend operation)

작동 키 설정

상단 페이지(설정 화면의 초기 페이지)에서 위에 있는 [Settings] 를 클릭하고 “Basic settings” 탭을 선택합니다.
 “Pairing key” 및 “Reset key” 에서 제어판의 페어링 키 및 재설정 키를 비활성화할 수 있습니다.

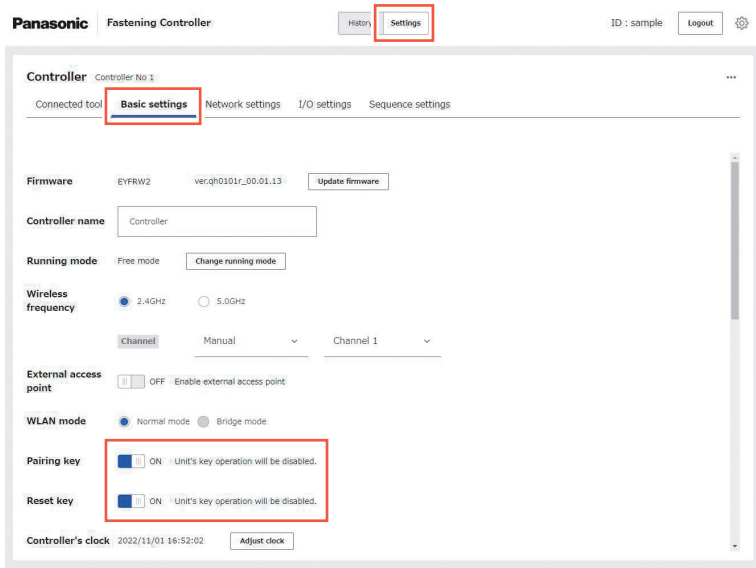

Pairing key	
제어판에서 페어링 키를 활성화하거나 비활성화합니다.	
[기본]	ON
[설정 범위]	ON(활성화됨) / OFF(비활성화됨)

Reset key	
제어판에서 재설정 키를 활성화하거나 비활성화합니다.	
[기본]	ON
[설정 범위]	ON(활성화됨) / OFF(비활성화됨)

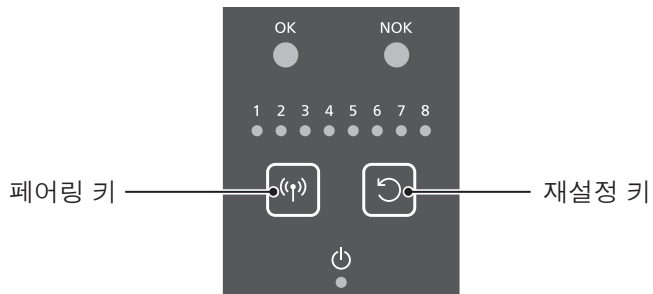

연결된 도구 정보 확인

상단 페이지(설정 화면의 초기 페이지)에서 위에 있는 [Settings] 를 클릭하고 “Connected tool” 탭을 선택합니다.
 컨트롤러에 연결된 도구의 정보와 상태를 볼 수 있습니다.

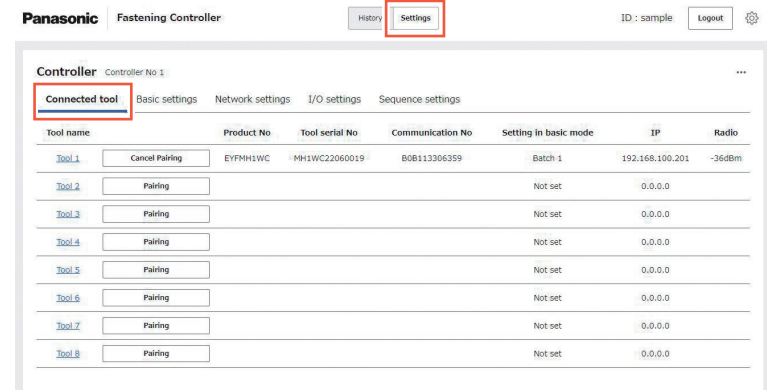

아래는 표시된 항목입니다.

Tool name	등록된 도구 번호(1~8)가 표시됩니다.
Tool serial No	도구의 장치 식별을 설정하고 표시할 수 있습니다. 기본: 5자리 모델 ID + 8자리 일련 번호(2자리 제조연도 + 2자리 월 + 4자리 생산 로트)
Product No	도구 제품 번호가 표시됩니다.
Communication No	도구의 통신 부분에 대한 장치 식별(MAC 주소)이 표시됩니다.
Setting in basic mode	Running mode 가 “Repeat mode (Basic mode)” 로 설정된 경우의 동작이 표시됩니다.
IP	도구의 IP 주소가 표시됩니다.
Radio	도구에서 수신한 무선 신호(RSSI)의 강도가 표시됩니다. * 마지막 통신의 강도가 표시됩니다. * 외부 액세스 포인트를 사용하는 경우 측정할 수 없으며 “0dBm” 이 표시됩니다.

작업 모니터

상단 페이지(설정 화면의 초기 페이지)에서 위에 있는 [History] 를 클릭하고 “Work monitor” 탭을 선택합니다.
 도구별 최근 체결 기록이 표시됩니다. 작업 결과를 참고하여 작업에 활용할 수 있습니다.

- * 둘 이상의 구성용 PC 에서 동시에 표시할 수 있습니다. (최대 8개 액세스. 동일한 계정에서 다중 액세스가 허용됩니다.)
- * 하나 이상의 계정으로 로그인하려면 다른 PC 를 사용하는 것이 좋습니다.
- * 동일한 PC 에서 여러 계정을 사용하려면 서로 다른 웹 브라우저를 사용하는 것이 좋습니다.
- * 한 번에 하나의 구성 기능 액세스만 허용됩니다.

보기 형식 전환

“목록 보기” 및 “그리드 보기” 에서 선택할 수 있습니다.
 화면 우측 상단의 보기 아이콘을 사용하십시오.

■ 목록 보기

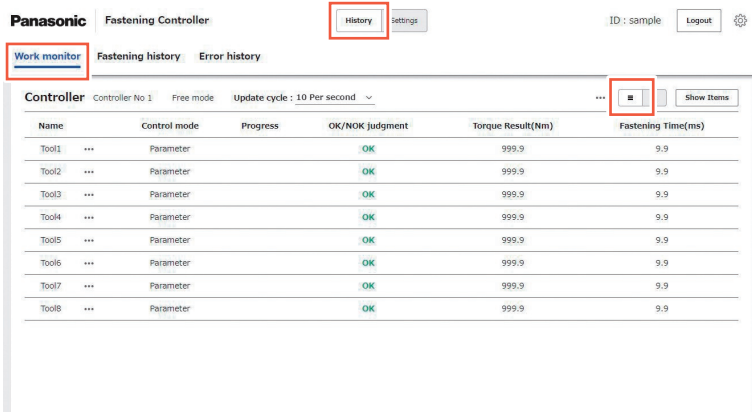

■ 그리드 보기

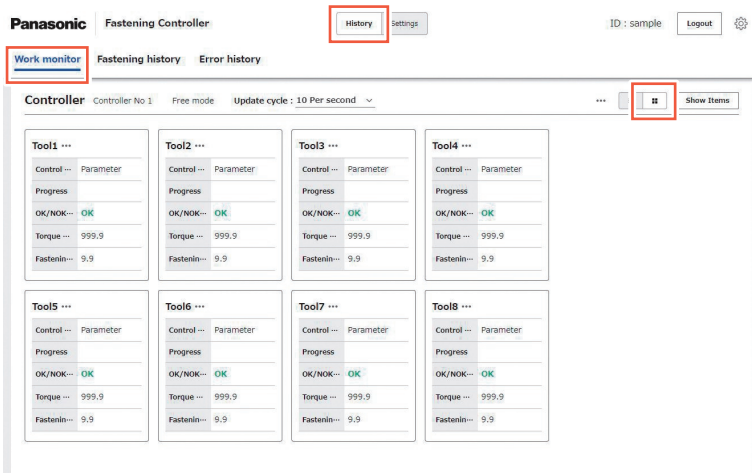

표시할 항목 선택

“Show Items” 를 사용하여 표시할 항목을 선택합니다.

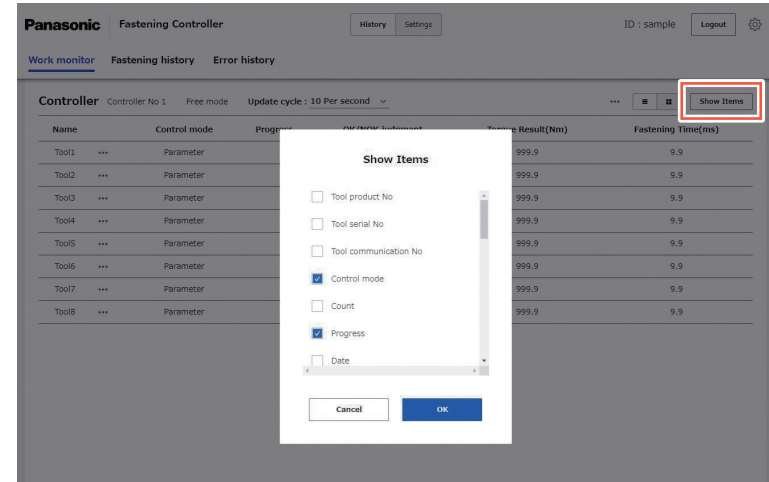

- * “목록 보기”에서 아래로 스크롤하여 표시할 많은 항목을 선택할 수 있습니다.
- * “그리드 보기”에서는 최대 5개의 항목을 표시할 수 있습니다.

디스플레이 업데이트 주기 선택

자동 디스플레이 업데이트를 설정할 수 있습니다.
 아래와 같이 “2 Per second”, “5 Per second”, “10 Per second” 에서 업데이트 주기를 선택합니다.

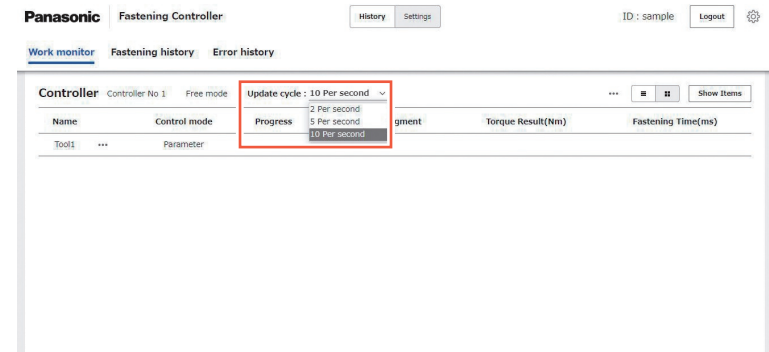

- * 많은 개수의 도구나 구성용 PC가 연결된 경우 “10 Per second” 업데이트 주기가 권장됩니다. (데이터 처리에 다소 시간이 걸릴 수 있습니다.)

무선 통신 연결이 끊긴 상태에서 도구의 동작

도구와 컨트롤러 사이의 무선 통신이 일시적으로 중단되는 경우 동일한 매개 변수로 체결을 계속할 수 있습니다.

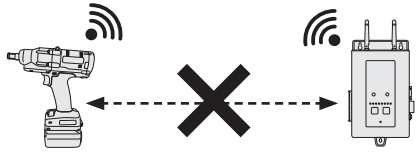

상단 페이지 (설정 화면의 초기 페이지)에서 위에 있는 [Settings] 를 클릭하고 “Basic settings” 탭을 선택합니다.

“Operation when WLAN disconnected” 를 “Suspend tool” 로 설정하면 중단 후 진행 중인 체결이 완료되지만 더 이상의 체결은 진행되지 않습니다.

“Enable fastening” 을 설정하면 체결 수량이 상한에 도달한 후 더 이상 체결하지 않습니다.

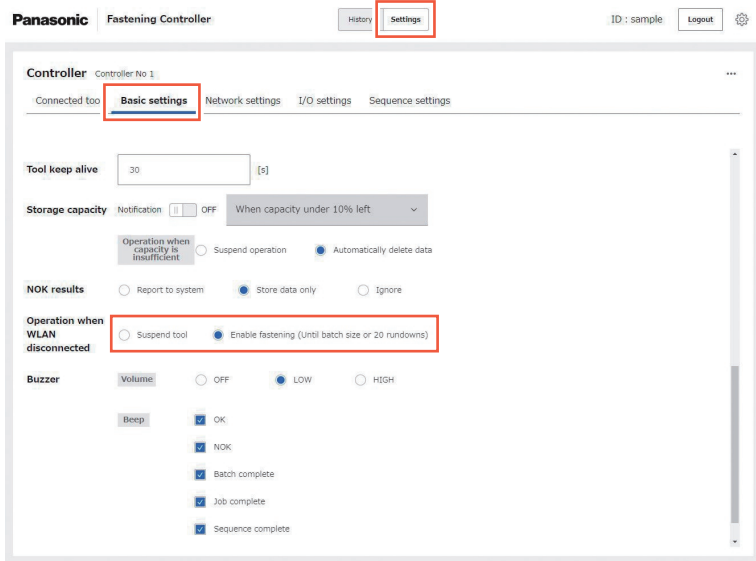

“Enable fastening” 에서 모드별 상한 수량은 아래와 같습니다.

모드		동작
Free mode		최대 20개의 나사를 계속 체결
Repeat mode	Basic mode	배치가 끝날 때까지 또는 최대 20개의 나사까지 계속 체결
	Sequence mode	배치가 끝날 때까지 또는 최대 20개의 나사까지 계속 체결 * 해당 도구 이외의 도구는 계속해서 정상적으로 실행됩니다.
External control mode		배치가 끝날 때까지 또는 최대 20개의 나사까지 계속 체결

작동 중 카운트 재설정

설정을 변경하기 위해 컨트롤러가 체결 제어를 진행 중이면 중지하십시오. 변경 사항을 적용하면 확인 대화 상자가 나타납니다.

“장치의 키 사용” 또는 “설정 화면의 설정” 으로 카운트된 수량을 재설정할 수 있습니다.
* 이는 “Free mode” 에 적용되지 않습니다.

장치의 키 사용

컨트롤러의 재설정 키를 3초 이상 길게 누릅니다.

* 모든 활성 도구의 수량이 재설정됩니다.

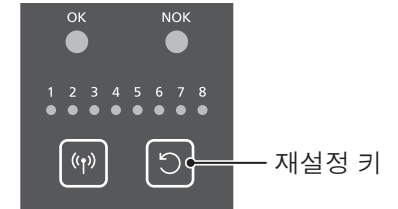

설정 화면의 설정

상단 페이지 (설정 화면의 초기 페이지)에서 위에 있는 [History] 를 클릭하고 “Work monitor” 탭을 선택합니다.

도구로 수량을 재설정하려면

“Work monitor” 화면에서 ... (도구 옵션 키)을 클릭한 다음 원하는 도구 번호의 [Batch reset] 을 클릭합니다.

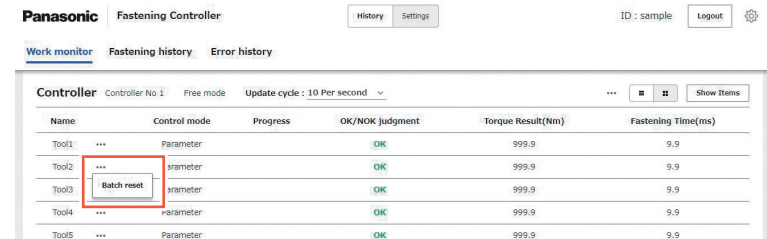

모든 도구의 수량을 일괄적으로 재설정하려면

“Work monitor” 화면에서 ... (컨트롤러 옵션 키)을 클릭한 다음 오른쪽 상단의 [Reset] 을 클릭합니다.

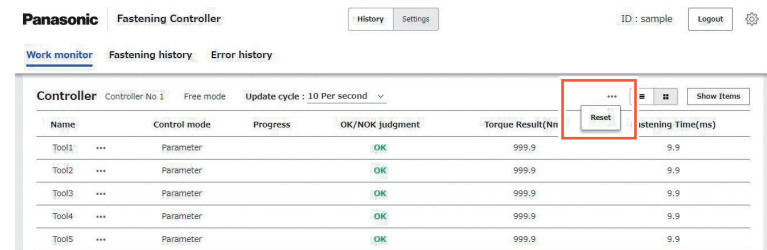

* Sequence mode 에서 수량은 첫 번째 도구까지 재설정됩니다.

체결 이력 데이터 확인

체결 기록 데이터 표시

상단 페이지(설정 화면의 초기 페이지)에서 위에 있는 [History] 를 클릭하고 “Fastening history” 탭을 선택합니다.

도구에서 컨트롤러로 전송된 체결 기록 데이터를 볼 수 있습니다.

데이터를 표시하려면 왼쪽의 도구 목록에서 원하는 컨트롤러 및 도구를 선택하고 오른쪽 상단에서 [Get data] 를 클릭합니다.

체결 기록 로그는 최신에서 가장 오래된 순으로 표시됩니다.

* 체결 기록 항목의 내용은 도구의 사용설명서를 참조하십시오.

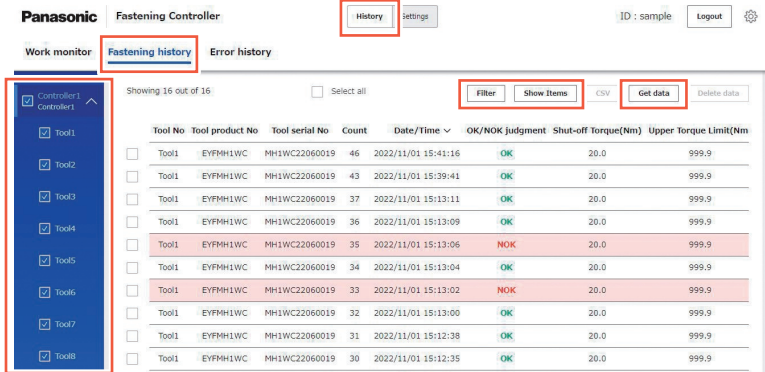

도구 목록

기간별 체결 기록 로그 추출

[Filter] 를 클릭하고 표시할 체결 기록 로그의 범위를 좁히기 위해 기간을 지정합니다.

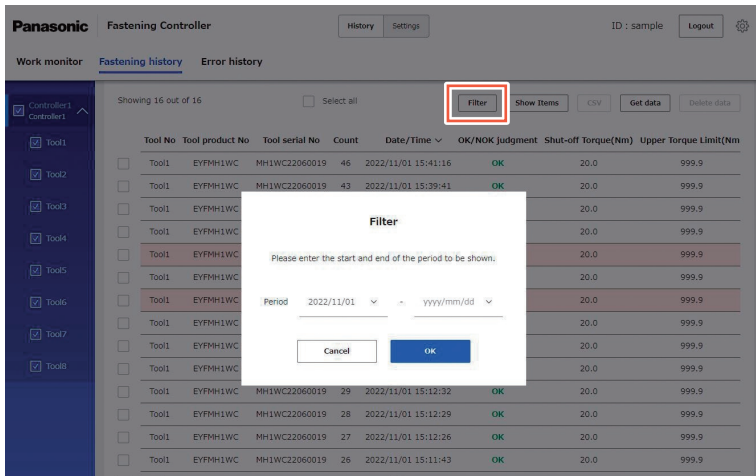

표시할 항목 설정

표시된 항목을 변경하려면 [Show Items] 를 클릭하고 원하는 항목을 선택합니다.

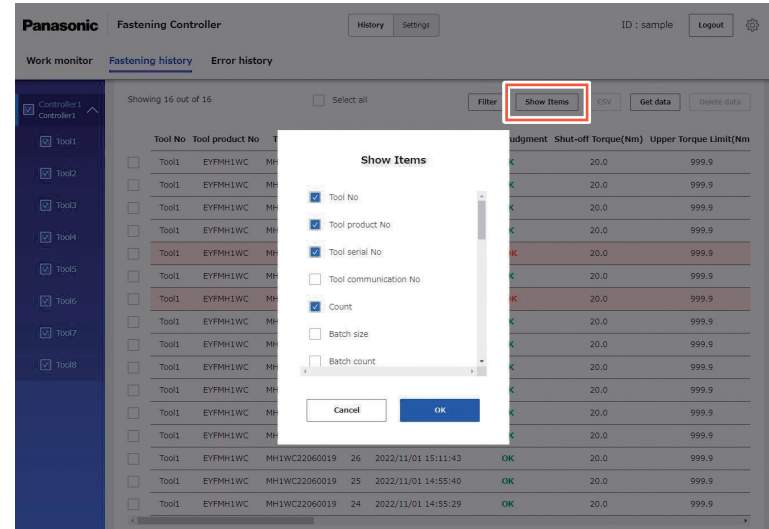

체결 기록 데이터 용량

컨트롤러는 최대 약 200,000개의 체결 기록 로그(파형 데이터 포함)를 저장할 수 있습니다.

더 많은 로그를 수신하면 작업을 일시 중지하거나 로그를 자동으로 삭제(덮어쓰기)합니다.

아래 가이드를 참조하여 주기적으로 로그를 CSV 형식으로 내보내는 것이 좋습니다.

전체 저장 용량에 도달하는 예상 시간

도구 수	도구당 일일 수량		
	1,000	3,000	5,000
2	약 100 일	약 33 일	약 20 일
4	약 50 일	약 16 일	약 10 일
8	약 25 일	약 8 일	약 5 일

체결 이력 데이터 확인 (계속)

체결 기록 데이터를 CSV 형식으로 내보내기

상단 페이지(설정 화면의 초기 페이지)에서 위에 있는 [History] 를 클릭하고 “Fastening history” 탭을 선택합니다.

원하는 로그를 선택하고 [CSV] 를 클릭합니다.
체결 기록 로그는 CSV 형식으로 내보냅니다.

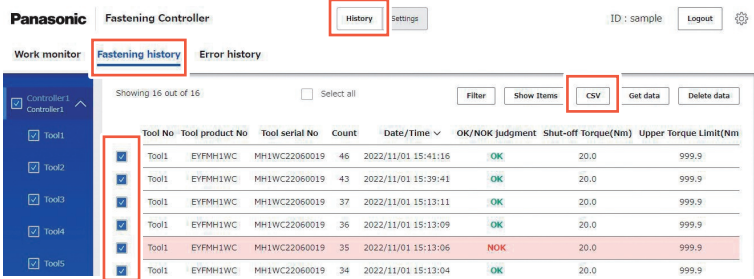

“Decimal point is a period, delimiter is a comma” 와 “Decimal point is a comma, delimiter is a semicolon” 중에서 선택할 수 있습니다.

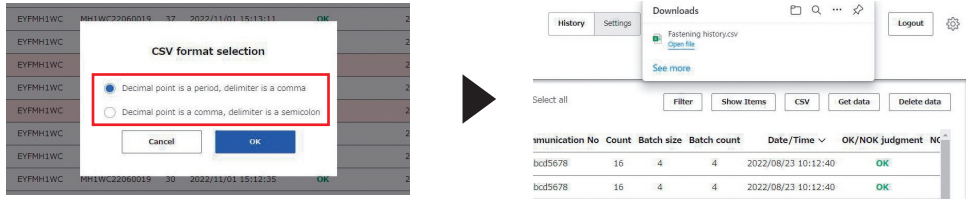

체결 기록 데이터 삭제

상단 페이지(설정 화면의 초기 페이지)에서 위에 있는 [History] 를 클릭하고 “Fastening history” 탭을 선택합니다.

원하는 로그를 선택하고 [Delete data] 를 클릭합니다.
체결 기록 로그가 삭제됩니다.

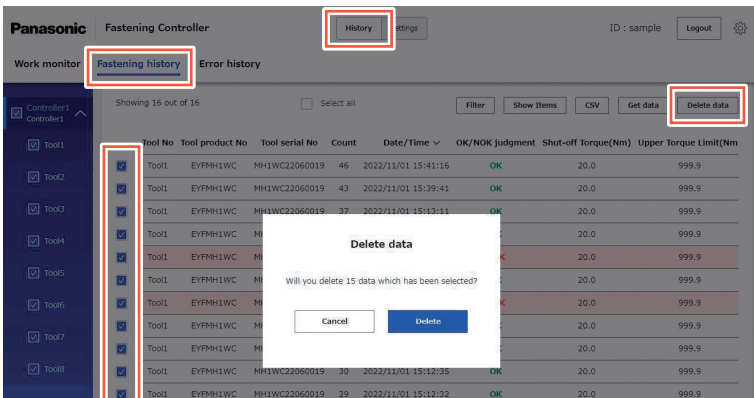

파형 데이터 표시

상단 페이지(설정 화면의 초기 페이지)에서 위에 있는 [History] 를 클릭하고 “Fastening history” 탭을 선택합니다.

파형 데이터를 저장하도록 설정한 경우 원하는 체결 기록 로그 행을 두 번 클릭하여 파형 데이터 팝업 창을 표시할 수 있습니다.

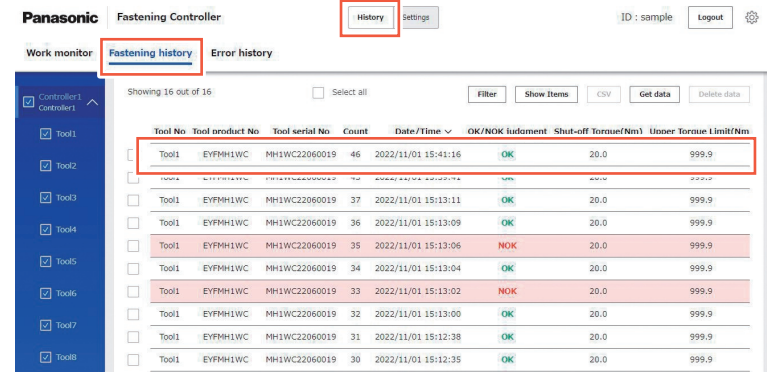

“X-axis”, “Y-axis”, “Scale” 을 선택하여 디스플레이를 조정할 수 있습니다.
[Output] 을 클릭하면 데이터를 CSV 형식으로 내보냅니다.

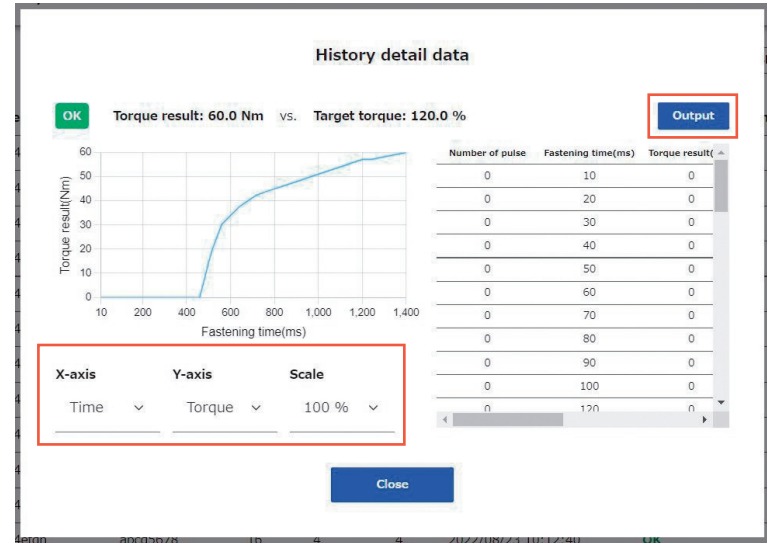

* “Device settings” 에서 “Graph sending timing” 을 “After every fastening” 으로 설정합니다.

오류 기록 표시

상단 페이지 (설정 화면의 초기 페이지)에서 위에 있는 [History] 을 클릭하고 “Error history” 탭을 선택합니다.
 생성된 오류 기록이 표시됩니다.

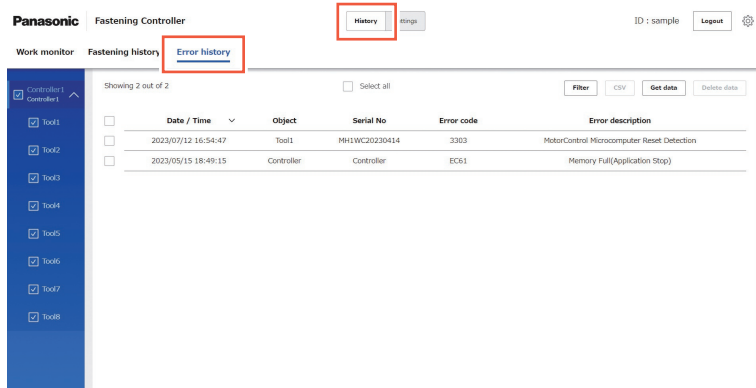

아래는 표시된 항목입니다.

* 오류 내용은 “오류 코드” 를 참조하십시오. **P90 참조**

Date / Time	오류가 발생한 날짜와 시간이 표시됩니다.
Object	오류를 발생시킨 장치 (컨트롤러 또는 도구 1~8 중 하나)가 표시됩니다.
Serial No	오류가 발생한 장치 (컨트롤러 또는 도구 1~8 중 하나)의 일련 번호가 표시됩니다.
Error code	발생한 오류 코드가 표시됩니다.
Error description	발생한 오류 내용이 표시됩니다.

언어 변경

“Japanese” 또는 “English” 를 선택할 수 있습니다.

- 1 상단 페이지 (설정 화면의 초기 페이지)에서 우측 상단의 옵션 키를 클릭하고 “System settings” 를 선택합니다.
 “System settings” 화면이 표시됩니다.

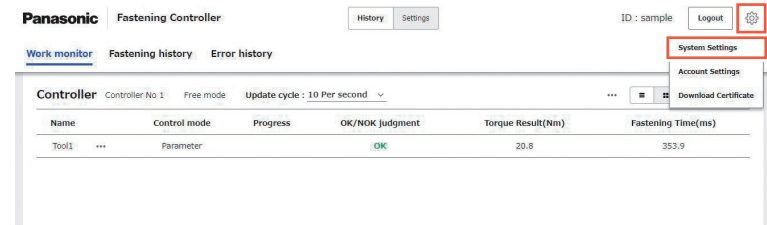

- 2 “System settings” 화면에서 언어를 선택합니다.
 “Japanese” 또는 “English” 를 선택할 수 있습니다.

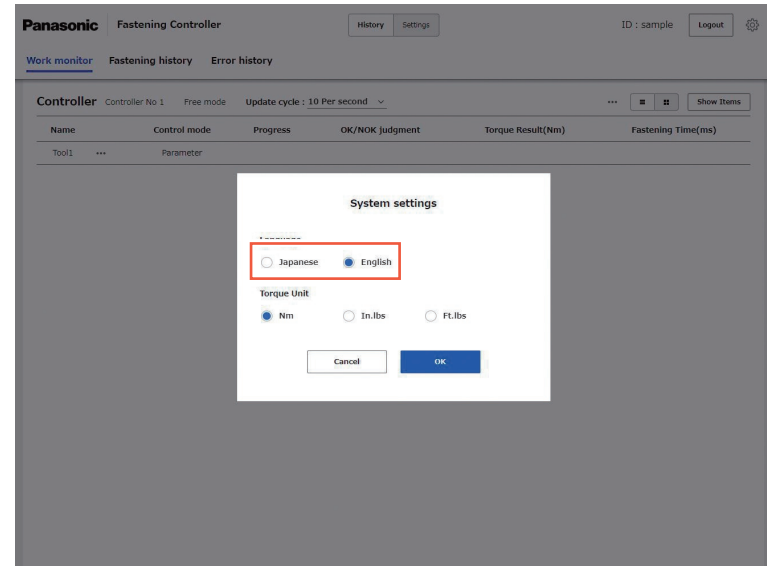

표시할 토크 단위 변경

“Nm”, “In.lbs”, “Ft.lbs” 를 선택할 수 있습니다.

- 1 상단 페이지(설정 화면의 초기 페이지)에서 우측 상단의 옵션 키를 클릭하고 “System settings” 를 선택합니다.
“System settings” 화면이 표시됩니다.

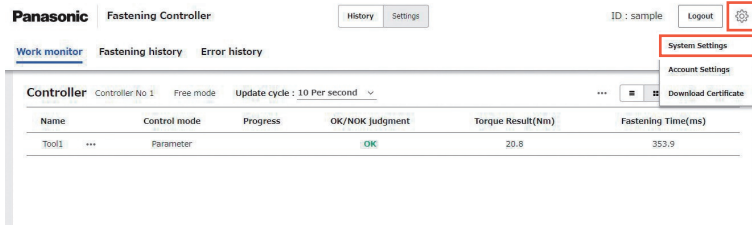

- 2 “System settings” 화면에서 토크 단위를 선택합니다.
“Nm”, “In.lbs”, “Ft.lbs” 중에서 토크 단위를 선택할 수 있습니다.

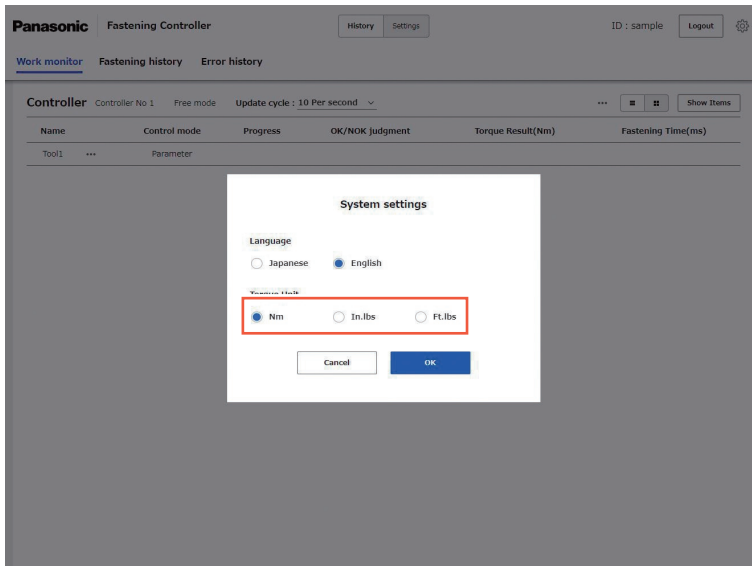

청소 방법

부드러운 천으로 닦기

젖은 천, 시너, 알코올, 벤진 또는 기타 휘발성 액체를 사용하지 마십시오.
(변색, 변형, 균열의 원인이 됨)

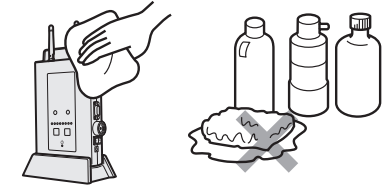

보관 방법

보관 중에는 다음 조건을 피하십시오.

- 차량 보관소 또는 기타 뜨거운 장소
- 직사광선에 노출된 장소
- 물이나 습기에 노출된 장소
- 이물질이나 먼지가 많은 장소
- 어린이의 손이 닿는 장소
- 휘발유나 기타 가연성 물질이 있는 장소
- 넘어질 위험이 있는 장소

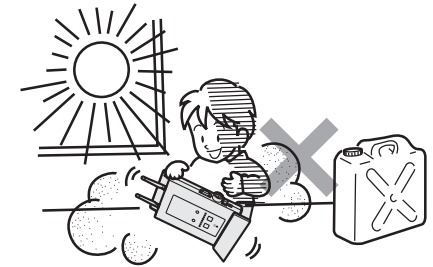

컨트롤러 초기화

컨트롤러를 초기화(공장 재설정)하려면 페어링 키와 재설정 키를 함께 10초 이상 길게 누릅니다.

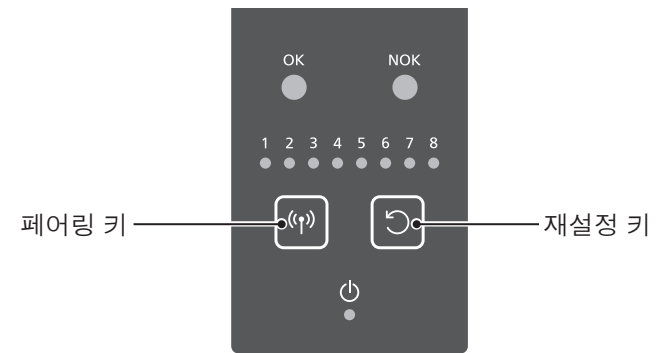

* 저장소 사용량에 따라 5분 이상 소요될 수 있습니다.

* 장치의 키가 비활성화되어 있으면 작업을 수행할 수 없습니다. **P66 참조**

설정 백업

상단 페이지(설정 화면의 초기 페이지)에서 위에 있는 [Settings] 를 클릭합니다.
 ... (컨트롤러 옵션 키)을 클릭한 다음 [Backup controller data] 를 클릭합니다.
 컨트롤러 및 도구의 설정을 백업할 수 있습니다.
 * 체결 기록 데이터는 백업되지 않습니다. 필요한 경우 CSV 형식으로 내보냅니다.

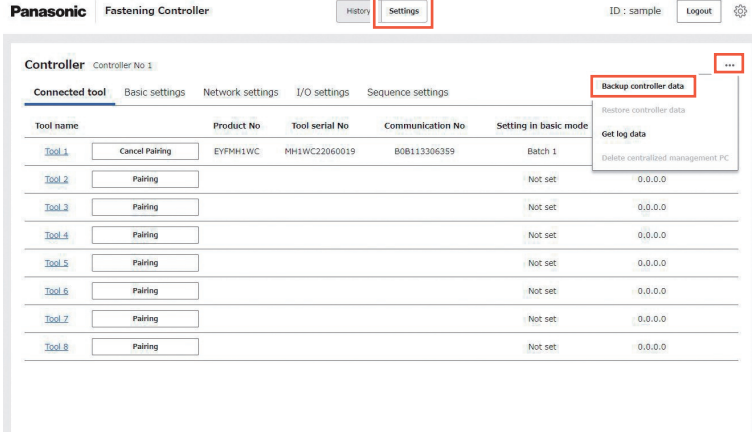

설정 복원

상단 페이지(설정 화면의 초기 페이지)에서 위에 있는 [Settings] 를 클릭합니다.
 ... (컨트롤러 옵션 키)을 클릭한 다음 [Restore controller data] 를 클릭합니다.
 백업에서 컨트롤러 및 도구의 설정을 복원할 수 있습니다.
 * 체결 제어 중에는 작업을 수행할 수 없습니다.
 * 도구와의 페어링이 등록되어 있으면 실행할 수 없습니다. 페어링을 취소합니다.

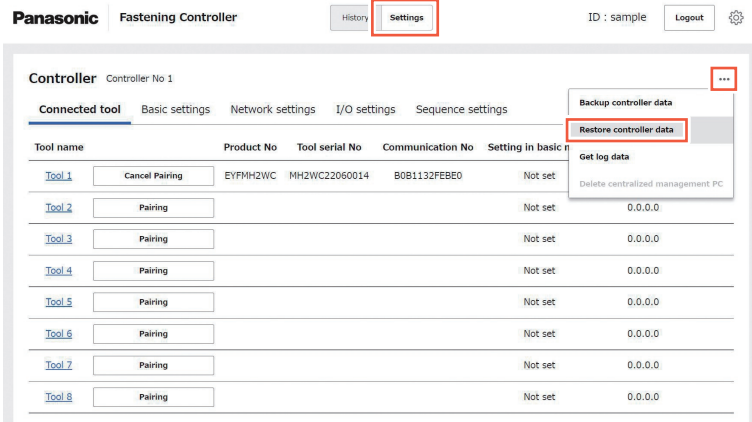

펌웨어 업데이트

컨트롤러의 펌웨어와 도구의 통신 부분을 업데이트할 수 있습니다.

다음 중 하나를 사용하여 펌웨어를 업데이트합니다.

- 컨트롤러의 USB 포트 사용.
 - * 비밀번호 잠금이 설정된 USB 플래시 드라이브는 사용할 수 없습니다.
 - * 폴더를 만들지 않고 펌웨어 데이터 파일 하나만 USB 플래시 드라이브에 직접 저장합니다.
- 구성용 PC 에 기록.
 - * “파일 업로드”를 선택할 때 선택 화면에서 PC 에 저장된 펌웨어 데이터 파일을 선택합니다.

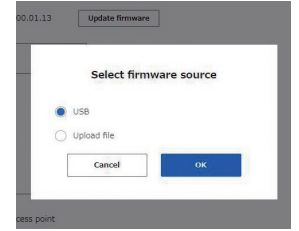

현재 펌웨어 버전은 회사 웹 사이트에 액세스하십시오. **P2 참조**
 또는 영업 담당자에게 문의하십시오.

컨트롤러의 경우

상단 페이지(설정 화면의 초기 페이지)에서 위에 있는 [Settings] 를 클릭하고 “Basic settings” 탭을 선택한 다음 [Update firmware] 를 클릭합니다.

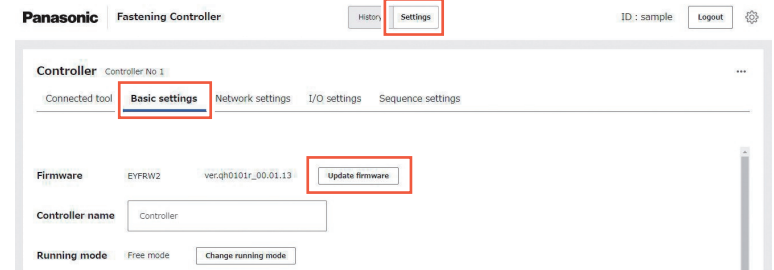

도구의 통신 부분의 경우

상단 페이지(설정 화면의 초기 페이지)에서 위에 있는 [Settings] 를 클릭하고 “Connected tool” 탭을 선택합니다.
 “Connected tool” 화면에서 원하는 도구 번호를 클릭합니다.
 도구 번호에 대한 화면의 “Device settings” 탭에서 [Update firmware] 를 클릭합니다.

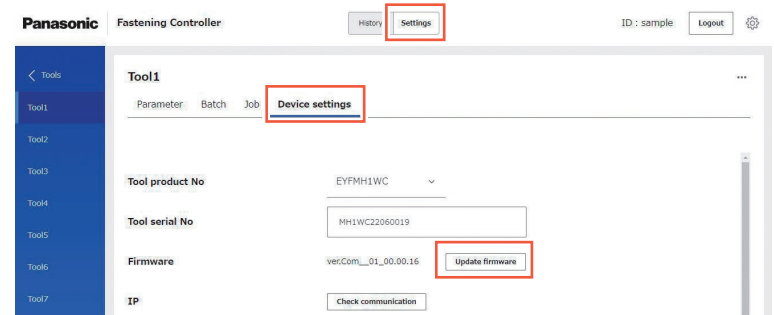

코인 셀 배터리 교체

컨트롤러의 시계 (RTC)를 계속 실행하려면 아래 교체 가이드를 참조하여 코인 셀 배터리를 교체하십시오.

■ 배터리 유형



CR2450

■ 교체 가이드

코인 셀 배터리는 컨트롤러가 꺼져 있을 때 시계를 계속 실행하는 데 사용됩니다. 소비를 최소화하기 위해 원칙적으로 제어 장치부를 끄지 않습니다.

전원이 하루 12시간 켜짐 (영업일에만)	전원이 항상 켜짐
약 3년	약 8년

다음 절차에 따라 교체하거나 대리점에 문의하십시오. 전기 지식이 있는 사람이 작업하는 것이 좋습니다.

1 2개의 보관함 커버 고정 나사를 제거한 후 보관함 커버를 제거합니다.

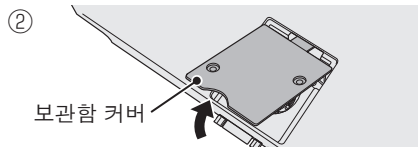
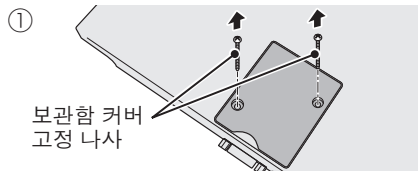

2 보관함 커버를 사용하여 코인 셀 배터리를 꺼냅니다. 보관함 커버의 고리로 코인 셀 배터리를 들어 올립니다.

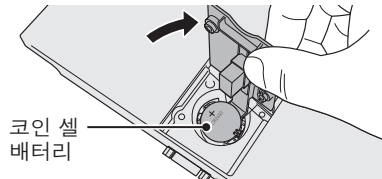

3 새 코인 셀 배터리를 넣고 보관함 커버를 2개의 보관함 커버 고정 나사로 부착합니다.

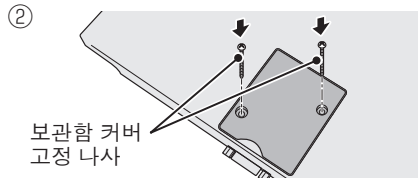
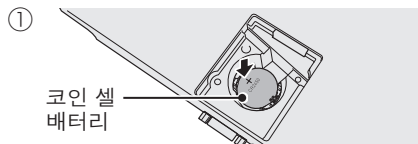

컨트롤러 사양

실내 제품 조립 작업 시 체결 완료 및 고장 신호 수신

모델 번호	EYFRW2
전원 공급 장치	100 V-240 V AC, 50/60 Hz
무선 통신 표준	무선 LAN (IEEE.802.11 a/b/g/n) n: HT20에만 해당
주파수 대역	2.4 GHz: 2.412 GHz~2.472 GHz 5 GHz: 5.180 GHz~5.240 GHz [중국, 한국에만 해당] 2.4 GHz: 2.412 GHz~2.462 GHz 5 GHz: 5.180 GHz~5.240 GHz
채널	2.4 GHz: 1~13 채널 5 GHz: 36, 40, 44, 48 채널 [중국, 한국에만 해당] 2.4 GHz: 1~11 채널 5 GHz: 36, 40, 44, 48 채널
적용 범위	2.4 GHz: 약 16 m 5 GHz: 약 10 m
등록 가능한 도구 수	8개 (최대)
입력/출력 (I/O) 단자	8개 입력 및 8개 출력
입력 단자 등급	24 V DC, 50 mA
출력 단자 등급	30 V DC, 3 A
전력 소비	약 30 W
작동 온도 및 습도 범위	0 °C~45 °C, 20%~90%
크기 (예상 치수) 총 길이 × 총 높이 × 너비	약 150 × 239 × 41 mm (안테나 포함 높이: 281 mm)
질량 (무게)	약 550 g (본체만)
통신 인터페이스	Ethernet × 2, RS232C × 1, USB-A × 1
저장할 수 있는 데이터 수	약 200,000 개의 체결 이력 로그 (파형 데이터 포함)
호환 가능한 도구 모델	EYFMH1WC, EYFMH2WC

무선 사양

채널별 주파수

주파수 대역	채널	주파수
2.4 GHz	채널 1	2.412 GHz
	채널 2	2.417 GHz
	채널 3	2.422 GHz
	채널 4	2.427 GHz
	채널 5	2.432 GHz
	채널 6	2.437 GHz
	채널 7	2.442 GHz
	채널 8	2.447 GHz
	채널 9	2.452 GHz
	채널 10	2.457 GHz
	채널 11	2.462 GHz
	채널 12	2.467 GHz
	채널 13	2.472 GHz
5 GHz	채널 36	5.180 GHz
	채널 40	5.200 GHz
	채널 44	5.220 GHz
	채널 48	5.240 GHz

• 채널 12와 13은 중국과 한국에서 사용할 수 없습니다.

WebUI 사양

호환 OS	Windows 10 이상 (아래 웹 브라우저 지원)
지원되는 웹 브라우저	Microsoft Edge 버전 102 이상 또는 Google Chrome 버전 102 이상
지원 언어	영어, 일본어
권장 화면 해상도	1024 × 768 이상

주의

- 일부 PC는 작동 환경을 충족하더라도 사용할 수 없습니다.
- PC의 사용 환경 등에 따라 본 사용설명서의 설명 및 화면이 실제 설명 및 화면과 다를 수 있습니다.
미리 양해를 구합니다.
- 이 사용설명서의 내용은 사전 통지 없이 변경될 수 있습니다.
- 이 사용설명서의 내용 전체 또는 일부를 무단으로 복제하는 것은 금지되어 있습니다.
- 이 사용설명서에서 Windows를 작동하는 방법에 대한 설명은 Windows 10의 절차 및 화면을 사용합니다.
- WebUI는 호환 OS 이외의 OS에서는 동작하지 않습니다.
- 권장 환경을 충족하는 모든 PC에서 작동이 보장되는 것은 아닙니다.

■ 이용 약관 (사용 전 읽어보기)

<제한 사항>

WebUI는 EYFRW2용 구성 소프트웨어입니다.

주의

- 기능을 사용할 때 다음 사항을 준수하십시오.
기능을 사용하면 다음 이용 약관에 동의하는 것으로 간주됩니다.

[사용 조건]

Panasonic은 기능과 관련하여 어떠한 종류의 보증도 하지 않습니다.
Panasonic은 직접 손실, 간접 손실, 확산 손실, 결과적 손실 및 기능의 사용 또는 작동으로 인한 특수 손실을 포함하되 이에 국한되지 않는 모든 손실에 대해 책임을 지지 않습니다.
해당 기능의 무단 전제 및 배포를 금지합니다.

접촉 I/O 사양

출력 릴레이 단자와 입력 단자 간의 할당

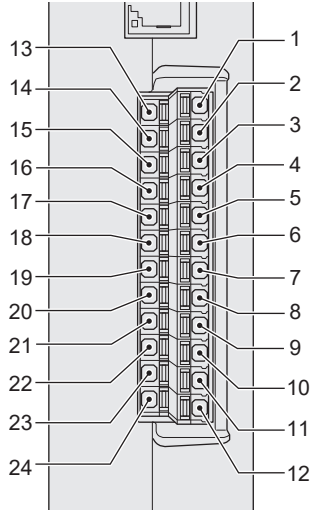

번호	핀 할당	번호	핀 할당
1	+24 V	13	RY1
2	+24 V	14	RY1-RY2 COM
3	IN COM	15	RY2
4	IN 1	16	RY3
5	IN 2	17	RY3-RY4 COM
6	IN 3	18	RY4
7	IN 4	19	RY5
8	IN 5	20	RY5-RY6 COM
9	IN 6	21	RY6
10	IN 7	22	RY7
11	IN 8	23	RY7-RY8 COM
12	24 V return	24	RY8

단자 블록 연결도

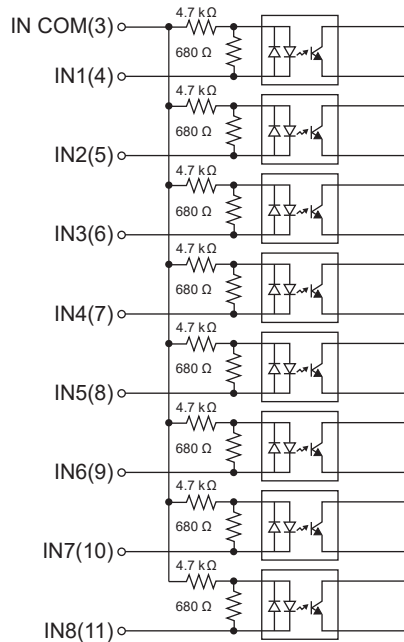
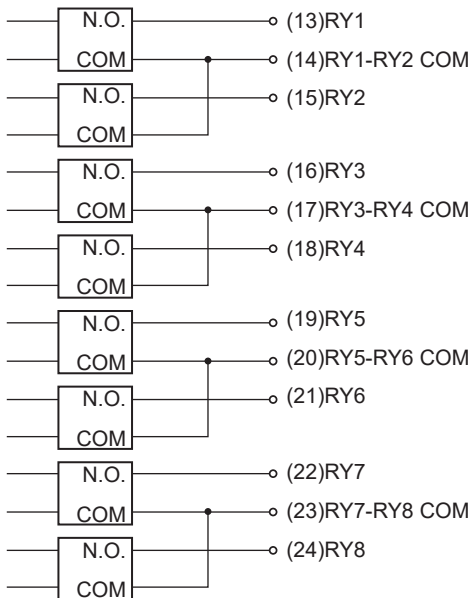

무선 통신 유의 사항

WLAN 장치 사용 시 주의 사항

본 기기는 산업, 과학 및 의료 기기(예: 마이크로웨이브)와 공장 생산 라인에서 사용되는 모바일 식별용 전제 라디오 방송국(라이선스 필요) 및 저전력 방송국(라이선스 불필요) 및 아마추어 방송국(라이선스 필요) 등의 다른 유형 장치와 공유되는 주파수 대역을 사용합니다.

1. 장치 사용 전, 부근에 모바일 식별용 전제 라디오 방송국, 저전력 방송국 또는 아마추어 방송국이 없도록 하십시오.
2. 장치 사용으로 인해 모바일 식별용 전제 라디오 방송국에 유해한 간섭이 발생하는 경우, 대역 사용을 즉시 중단하고 다음에 나와 있는 지원 센터와 간섭 문제 해결책(예: 파티션 설치)을 상의하십시오.
3. 본 기기가 모바일 식별용 전제 또는 저전력 방송국 또는 아마추어 방송국에 유해한 간섭 등의 문제를 초래하는 경우, 지원 센터에 문의하십시오.

■ 다음과 같은 환경 조건에서는 노이즈, 짧은 전파 도달 거리 또는 고장이 발생할 수 있습니다.

- 무선 운용 가능 도구 유닛 및 컨트롤러 간의 원활한 무선 전파를 방해하는 방해물 (예: 금속 또는 강화 콘크리트 구조물)이 있습니다.
- 컨트롤러의 안테나는 금속으로 마감되어 있습니다.
- 오퍼레이터의 바디가 오퍼레이터 (무선 운용 가능 도구 유닛)와 컨트롤러 사이의 무선 전파를 방해합니다.
- 부근에 마이크로웨이브, PC 또는 기타 기기 등 노이즈를 초래하는 장치가 있습니다.
- 무선 운용이 가능한 도구 유닛과 컨트롤러 주변에서 휴대폰이나 PHS 폰을 사용합니다.

소프트웨어 라이선스 조건

이 제품은 다음 소프트웨어를 통합합니다.

- (1) Panasonic Corporation 에서 독자적으로 개발했거나 Panasonic Corporation 에서 사용하기 위해 개발된 소프트웨어,
- (2) 제 3자가 소유하고 Panasonic Corporation 에 라이선스가 부여된 소프트웨어,
- (3) GNU General Public License, Version 1.0 (GPL V1.0)에 따라 라이선스가 부여된 소프트웨어,
- (4) GNU General Public License, Version 2.0 (GPL V2.0)에 따라 라이선스가 부여된 소프트웨어,
- (5) GNU General Public License, Version 3.0 (GPL V3.0)에 따라 라이선스가 부여된 소프트웨어,
- (6) GNU LESSER General Public License, Version 2.1 (LGPL V2.1)에 따라 라이선스가 부여된 소프트웨어,
- (7) GNU LESSER General Public License, Version 3.1 (LGPL V3.1)에 따라 라이선스가 부여된 소프트웨어,
- (8) SMAIL General Public License (SMAIL)에 따라 라이선스가 부여된 소프트웨어,
- (9) Mozilla Public License Version 1.1 (MPL V1.1)에 따라 라이선스가 부여된 소프트웨어,
- (10) Mozilla Public License Version 2.0 (MPL V2.0)에 따라 라이선스가 부여된 소프트웨어 및/또는
- (11) GPL V1.0, GPL V2.0, GPL V3.0, LGPL V2.1, LGPL V3.1, SMAIL, MPL V1.1 및/또는 MPL V2.0 에 따라 라이선스가 부여된 소프트웨어 이외의 오픈 소스 소프트웨어.

(3) - (11)로 분류된 소프트웨어는 유용할 것이라는 확신을 가지고 배포하지만 상품성 또는 특정 목적에의 적합성에 대한 묵시적 보증을 포함하여 어떠한 보증도 하지 않습니다.

저작권자 및 라이선스에 대한 자세한 내용은 95 페이지 이후를 참조하십시오.

이 제품의 인도로부터 최소 3년 동안 Panasonic 은 아래에 제공된 연락처 정보로 연락하는 모든 제 3자에게 GPL V1.0, GPL V2.0, GPL V3.0, LGPL V2.1, LGPL V3.1, SMAIL 또는 그렇게 해야 할 의무가 있는 기타 라이선스에 포함되는 해당 소스 코드와 해당 저작권 표시 하에 물리적으로 소스 코드 배포를 수행하는 당사 비용보다 적은 비용으로 완전한 기계 판독 가능 사본을 제공할 예정입니다.

연락처 정보 : oss-cd-powertools-gl@ml.jp.panasonic.com

장치	오류 코드	유형	범주	이벤트	조치
컨트롤러	0xEF21	경고	하드웨어 장애	보조 CPU 오류 (장애)	컨트롤러를 다시 시작합니다. 문제가 지속되면 장치가 고장난 것일 수 있습니다. 대리점에 문의하십시오.
	0xEF51	경고	하드웨어 장애	Ether0 오류	장치가 고장난 것일 수 있습니다. 대리점에 문의하십시오.
	0xEF52	경고	하드웨어 장애	Ether1 오류	장치가 고장난 것일 수 있습니다. 대리점에 문의하십시오.
	0xEF61	경고	하드웨어 장애	Wi-Fi 모듈 오류 (장애)	컨트롤러를 다시 시작합니다. 문제가 지속되면 장치가 고장난 것일 수 있습니다. 대리점에 문의하십시오.
	0xCE42	오류	소프트웨어 장애	설정 내용 오류	컨트롤러를 공장 초기화하고 다시 설정하십시오.
	0xCE43	오류	소프트웨어 장애	수축 정보 오류	컨트롤러의 재설정 키를 3초 이상 길게 누릅니다.
	0xEC61	경고	소프트웨어 장애	체결 이력 저장 용량이 가득 참 (작동 중단)	체결 이력 화면에서 체결 이력 로그를 삭제하여 여유 공간을 확보하십시오. 필요한 경우 삭제하기 전에 내보냅니다.
도구	0x4301	주의	소프트웨어 장애	저장 용량이 가득 참	도구 설정 소프트웨어 (Tool Manager 소프트웨어)에 액세스하고 작업 이력 로그를 삭제합니다.
	0x4302	주의	소프트웨어 장애	대기열의 전송된 결과 수가 상한에 도달함	도구가 컨트롤러와 통신할 수 없습니다. 작업장을 바꾸십시오. 문제가 지속되면 장치가 고장난 것일 수 있습니다. 대리점에 문의하십시오.
	0x3303	오류	소프트웨어 장애	모터 제어 마이크로컨트롤러 재설정이 감지됨	발생한 오류가 해결되었습니다.
	0x3304	오류	소프트웨어 장애	토크 계산 마이크로컨트롤러 재설정이 감지됨	발생한 오류가 해결되었습니다.

장치	오류 코드	유형	범주	이벤트	조치
도구	0x4305	주의	소프트웨어 장애	RTC 배터리 부족	도구 장치 내부의 코인 셀 배터리를 교체하십시오.
	0x4306	주의	소프트웨어 장애	펌웨어 업데이트 오류	펌웨어 파일이 올바른지 확인하십시오.
	0x4315	주의	소프트웨어 장애	USB 통신 오류	발생한 오류가 해결되었습니다.
	0x4316	주의	소프트웨어 장애	Wi-Fi 모듈이 다시 시작됨	발생한 오류가 해결되었습니다.
	0x1401	경고	하드웨어 장애	Wi-Fi 모듈 오류	발생한 오류가 해결되었습니다.
	0x1402	경고	하드웨어 장애	모터 제어 마이크로컨트롤러 오류	발생한 오류가 해결되었습니다.
	0x1403	경고	하드웨어 장애	토크 계산 마이크로컨트롤러 오류	발생한 오류가 해결되었습니다.
	0x1404	경고	하드웨어 장애	외장 플래시 드라이브 오류	발생한 오류가 해결되었습니다.
	0x1405	경고	하드웨어 장애	RTC 오류	발생한 오류가 해결되었습니다.
	0x1406	경고	하드웨어 장애	회로 식별 오류	발생한 오류가 해결되었습니다.
	0x1407	경고	하드웨어 장애	남은 스왑 공간 없음	발생한 오류가 해결되었습니다.
	0x1408	경고	하드웨어 장애	손상된 매개 변수 공간	발생한 오류가 해결되었습니다.

작동 로그 데이터

상단 페이지(설정 화면의 초기 페이지)에서 위에 있는 [Settings] 를 클릭합니다.
... (컨트롤러 옵션 키)을 클릭한 다음 [Get log data] 를 클릭합니다.
컨트롤러의 작업 로그를 받을 수 있습니다.

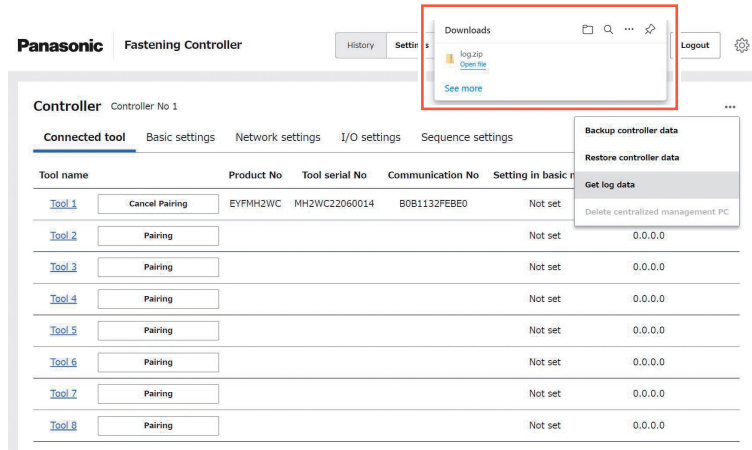
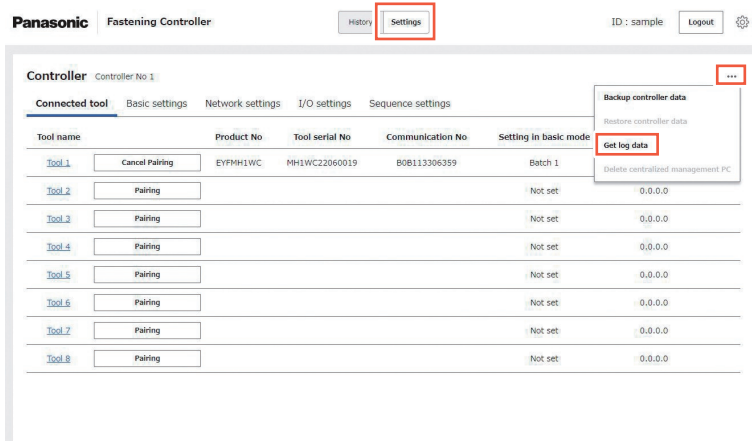

Operating Instructions Assembly Controller

Model No.:
EYFRW2

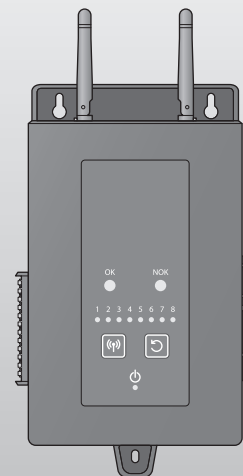

IMPORTANT

Read and follow the safety and operating instructions before using this product. Do not use the wireless function outside the country where you purchased the product. Doing so may violate the local laws and regulations.

Original instructions: English
Translation of the original instructions:
Other languages

Table of Contents

GETTING STARTED	2	BEFORE USE
SAFETY PRECAUTIONS	4	
FUNCTIONAL DESCRIPTION.....	7	
SYSTEM CONFIGURATION.....	11	
CONNECTABLE TOOLS / CAUTIONS FOR INSTALLATION	14	

PREPARATION BEFORE USE	16	OPERATION
CONFIGURING THE CONTROLLER.....	22	
PAIRING WITH A TOOL	28	
CONFIGURING A TOOL.....	32	
SETTING FASTENING PARAMETERS OF TOOLS	36	
SETTING THE FASTENING CONTROL MODE	42	
CONNECTING TO EXTERNAL DEVICE ..	52	
CONNECTING TO EXTERNAL DEVICE VIA I/O	53	
CONNECTING TO EXTERNAL DEVICE VIA OPEN PROTOCOL.....	57	
CONNECTING VIA AN EXTERNAL ACCESS POINT.....	63	
INDICATOR LAMPS AND BUZZER	64	
SETTING THE OPERATION KEYS.....	66	
CHECKING THE INFORMATION OF CONNECTED TOOLS	67	
WORK MONITOR	68	
TOOLS' BEHAVIOUR WITH WIRELESS COMMUNICATION DISCONNECTED	70	
RESETTING THE COUNT DURING OPERATION	71	
CHECKING THE FASTENING HISTORY DATA	72	
SYSTEM SETTINGS.....	77	

CLEANING AND STORAGE	79	CLEANING AND STORAGE
----------------------------	----	-----------------------------

CAPACITY AND SPECIFICATIONS.....	83	INFORMATION
RADIO CERTIFICATION	87	
LICENCE TERMS	89	
ERROR CODE	90	
OPERATION LOG DATA	92	

Operating Environment

You need to use a web browser to configure the controller.
Prepare a PC satisfying the following requirements.

Operating environment

Compatible OS	Windows 10 or later (supporting any of the web browsers below)
Web browser	Microsoft Edge version 102 or later or Google Chrome version 102 or later

- Some PCs are not available even if they meet the operating environment.
- Depending on the use environment etc. of your PC, the descriptions and screens in this Operating Instructions might be different from the actual descriptions and screens. Please be forewarned.
- The contents of this Operating Instructions are subject to change without prior notice.
- Any reproduction of the contents of this Operating Instructions in whole or in part is prohibited without permission.
- Figures in this Operating Instructions are for reference only.

[Note]

Always keep the firmware up to date.
You can find the latest firmware data on the following website which provides access to the Operating Instructions.
For how to update the firmware, see "Updating the Firmware".

Refer to P81

How to Access the Operating Instructions

The current version of the controller's Operating Instructions and other resources can be downloaded from the web site below.

<https://panasonic.net/electricworks/ecm/powerelctrictools/download/>

Trademark

- Microsoft and Windows are either registered trademarks or trademarks of Microsoft Corporation in the U.S. and/or other countries.
- The screenshots are used in accordance with the guidelines of Microsoft Corporation.
- Wi-Fi and Wi-Fi logo are registered trademarks of the Wi-Fi Alliance.

Other names including company names and product names in this Operating Instructions are trademarks or registered trademarks of their respective companies.
™ and ® may be omitted in this Operating Instructions.

Intended Use

This product is a controller that wirelessly communicates with tools.
It can receive fastening history data from tools, make settings of tools, and control the quantity to fasten.

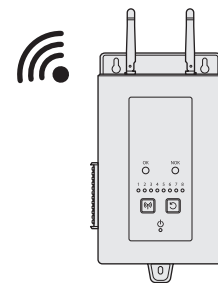

- 01 Connect to up to 8 tools.
- 02 Support 2.4 GHz and 5 GHz bands
- 03 Support a fastening control function and a history storing function

Setup

Install the controller in a range where wireless communication with tools is possible.
Supply power via an AC outlet and connect to external devices through communication interfaces as necessary.

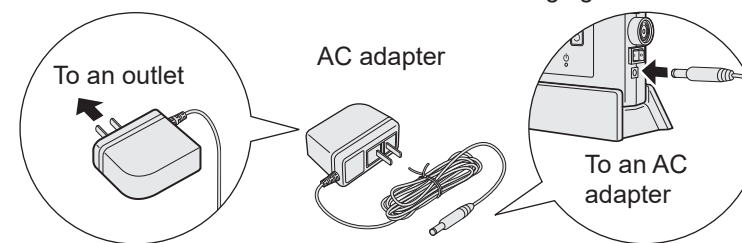
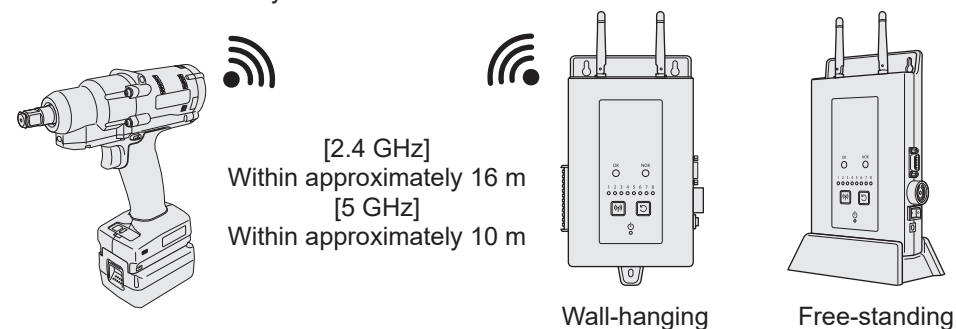



Example: WEYFRW1K7951



- The controller contains a coin cell battery to keep the clock function (RTC) running. It is recommended that you keep the power on to reduce consumption of the internal coin cell battery.
- The wireless coverage may change depending on the environment.



Below are the instructions you should always adhere to, to prevent human harm and property damage.





■ **The severity of harm and damage caused by incorrect use is presented with the following.**

 WARNING	May cause death or serious injury.
 CAUTION	May cause minor injury or property damage.

■ **The content that should be observed is presented with the following symbols. (The following are examples)**

	You MUST NOT do the action.
	You MUST do the action.

 WARNING	
 Mandatory	<ul style="list-style-type: none"> ● Make sure that there are no buried objects such as conduits, water pipes, and gas pipes in the installation place. Touching such buried objects may cause electric shock or lead to electric leakage or gas leakage.
	<ul style="list-style-type: none"> ● Insert the power plug all the way seated. Incomplete insertion may cause electric shock or heat generation resulting in fire. Do not use a damaged plug or loose socket.
	<ul style="list-style-type: none"> ● Clean dust off the power plug routinely. Accumulated dust on the plug may absorb moisture and cause poor insulation resulting in fire. Disconnect the power plug and wipe it with dry cloth.
	<ul style="list-style-type: none"> ● Use the specified power cord only. Using any other plug may cause electric shock, short circuit, or fire.
	<ul style="list-style-type: none"> ● Keep the workplace sufficiently bright. Poor visibility in a dark workplace may lead to an accident or injury.

 WARNING	
 Prohibited	<ul style="list-style-type: none"> ● Do not use a socket or wiring device in the manner of exceeding the rated value. Use 100 V-240 V AC only. Exceeding the rated value due to an overloaded socket may cause heat generation resulting in fire.
	<ul style="list-style-type: none"> ● Do not damage the power cord or plug. (Avoid damaging, breaking, modifying, putting close to a heat source, bending with force, twisting, pulling, putting a heavy load on it, pinching, or binding) Using the damaged cord or plug may cause electric shock, short circuit, or fire. Check the cord and plug periodically and if any damage, consult your dealer.
	<ul style="list-style-type: none"> ● Do not use the controller with a DC power supply, engine generator, or transformer. ● Do not use the controller in a place with flammable liquid or gas. Doing so may cause generation of heat, smoke, fire, or burst.
	<ul style="list-style-type: none"> ● Do not install the controller on a mortar wall. Screwing it on a mortar wall may cause heat generation from wire mesh inside, resulting in fire in case of electric leakage.
	<ul style="list-style-type: none"> ● Disconnect the power plug between uses. Keeping it connected may cause poor insulation resulting in electric shock or fire from electric leakage.
 No disassembly	<ul style="list-style-type: none"> ● Do not modify the controller. Do not disassemble or repair the controller. Doing so may cause fire, electric shock, or injury. For repair, consult your dealer or our Customer Support Centre.
 Keep dry	<p>Avoid the following use of charged tools.</p> <ul style="list-style-type: none"> ● Do not use or leave them exposed to rain or moisture. ● Do not use them immersed under water. Doing so may cause smoke, fire, or burst.
 No wet hand	<ul style="list-style-type: none"> ● Do not use a wet hand to connect or disconnect the power plug to or from the outlet. Doing so may cause electric shock.

⚠ CAUTION



Prohibited

- **Do not use the controller for any other purpose than intended.**
Doing so may cause injury.
- **Do not put the controller in a place accessible by a child.**
Doing so may cause an accident or trouble.
- **Do not use the controller with oil or other foreign material attached to it.**
Such oil or other foreign material may enter the inside, resulting in generation of heat, fire, or burst.
- **Do not store the main body in a place where the temperature may rise to 45 °C or higher.**
Doing so may lead to abnormal operation.
- **Do not work in an unusual position.**
Otherwise you may fall over and be injured.
Always stand on a stable footing and keep a good balance.
- **Do not use the controller when you are tired.**
Doing so may cause an accident or injury.
- **Do not allow a child or any other person who is not an operator to come near the workplace or touch the controller.**
Doing so may cause injury.
- **Do not use the controller with incompatible devices.**
Doing so may cause malfunction resulting in an accident.



Mandatory

- **To install the controller on a wall, secure it with screws to prevent it from falling.**
You may be injured if it falls.
- **To disconnect the power plug, always hold the power plug without pulling the cord.**
Pulling the cord may cause electric shock or short circuit.
- **Before use, check the controller and other parts for any damage and confirm their normal operation.**
Failure to do so may lead to breakage resulting in injury.
- **Keep the workplace clean.**
A disordered workplace or work table may lead to an accident.
- **Consider well how to handle and work, pay attention to the surrounding environment, and use common sense during work.**
Failure to do so may cause an accident or injury.

Main Body

■ Left side

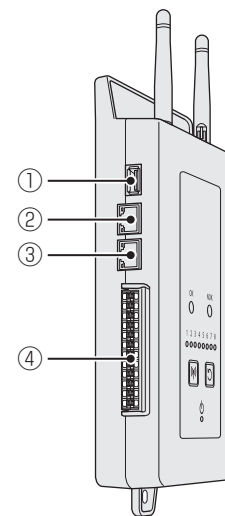

■ Front side

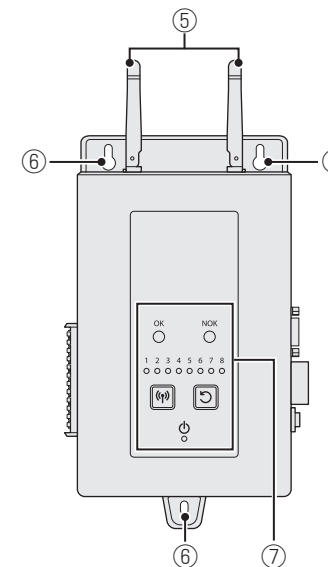

■ Right side

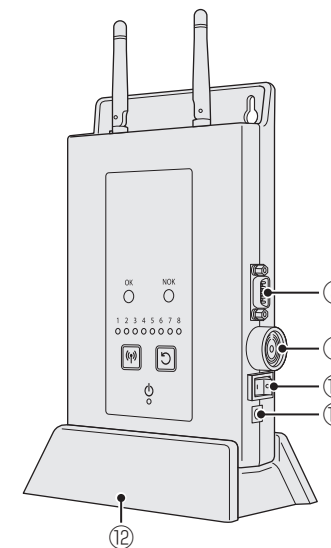

■ AC adapter

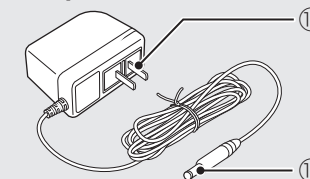

①	USB Port (Type-A)
②	Ethernet port (for maintenance)
③	Ethernet port (for network)
④	1~24 I/O port
⑤	Diversity antenna
⑥	Wall-hanging hole
⑦	Control panel

⑧	IOIOI Serial port (RS232C)
⑨	Buzzer
⑩	Power switch
⑪	AC adapter socket
⑫	Controller stand
⑬	Power plug
⑭	Power connector

BEFORE USE

Control panel

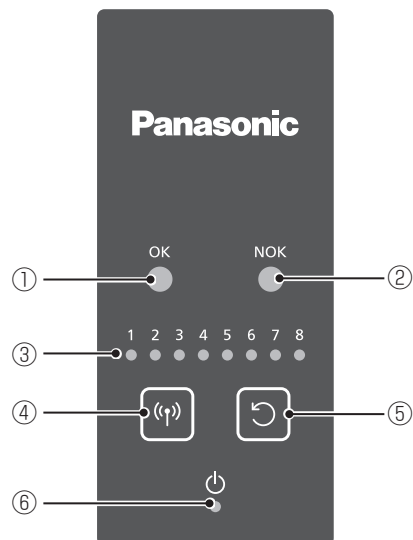

①	<p>Fastening OK lamp Solid green: A fastening completion signal has been received.</p> <p>Off: A fastening completion signal is not received yet.</p>
②	<p>Fastening NOK lamp Solid red: A fastening failure signal has been received.</p> <p>Off: A fastening failure signal is not received yet.</p>
③	<p>Communication lamp (No. 1 to No. 8) Solid blue: A tool has been registered.</p> <p>Blinking blue: A tool is being registered or out of coverage.</p> <p>Off: A tool is not registered yet.</p>

④	Pairing key
⑤	Reset key
⑥	<p>Power lamp Solid yellow: Power on (receiving mode)</p> <p>Off: Power off</p> <p>Blinking yellow: Error</p>

Communication interface

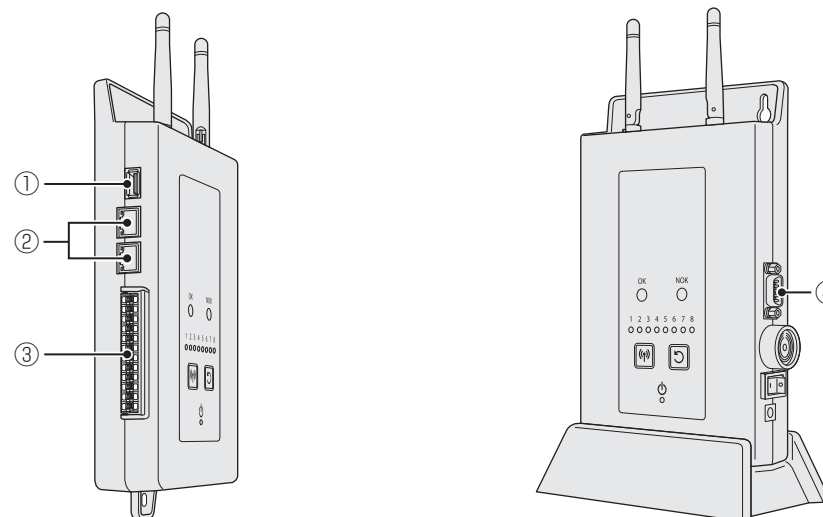

Interface		Details
①	USB	<p>Use this port to connect a USB flash drive to update the firmware.</p> <ul style="list-style-type: none"> • USB2.0 Type-A × 1 • Directly connect a USB flash drive (without extension)
②	Ethernet (for maintenance and network)	<p>Use this port to connect to a PC for configuration or a host system.</p> <ul style="list-style-type: none"> • 10Base-T/100Base-TX × 2 • Cable length: Less than 30 m <p>* Connect the Ethernet port (for maintenance) directly to a PC for configuration. (Do not use a hub)</p>
③	Input/output (I/O) terminal	<p>Use this port to connect to an external device (e.g., a PLC).</p> <ul style="list-style-type: none"> • 8 inputs and 8 outputs • Cable length: 10 m or less • Input terminal rating: 24 V DC, 50 mA • Output terminal rating: 30 V DC, 3 A
④	Serial port (RS232C)	<p>Use this port to connect to an external device (e.g., a PLC).</p> <ul style="list-style-type: none"> • RS232C × 1 • Cable length: 10 m or less

Accessory

■ AC adapter × 1

[For China only]
(WEYFRW1K7951)

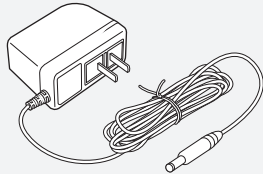

[For Korea only]
(WEYFRW1K7051)

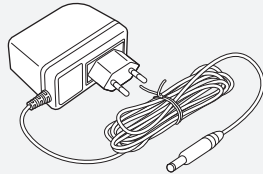

[[For Malaysia only]
(WEYFRW1K7851)

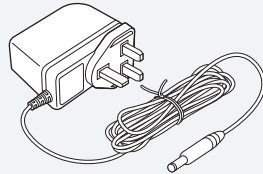

[For India only]
(WEYFRW1K7151)

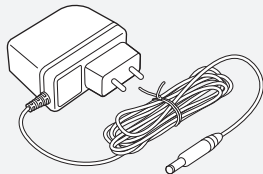

[For Thailand/Indonesia only]
(WEYFRW1K7751)

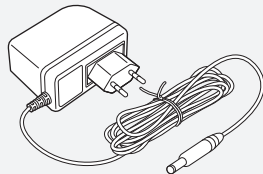

■ Controller stand × 1 (EYFRW1F7001)

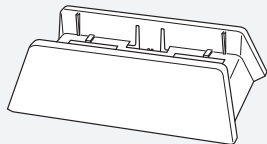

Consumables

■ Coin cell battery (CR2450) × 1

For how to replace, see "Replacing the Coin Cell Battery".

Refer to P82



System Configuration

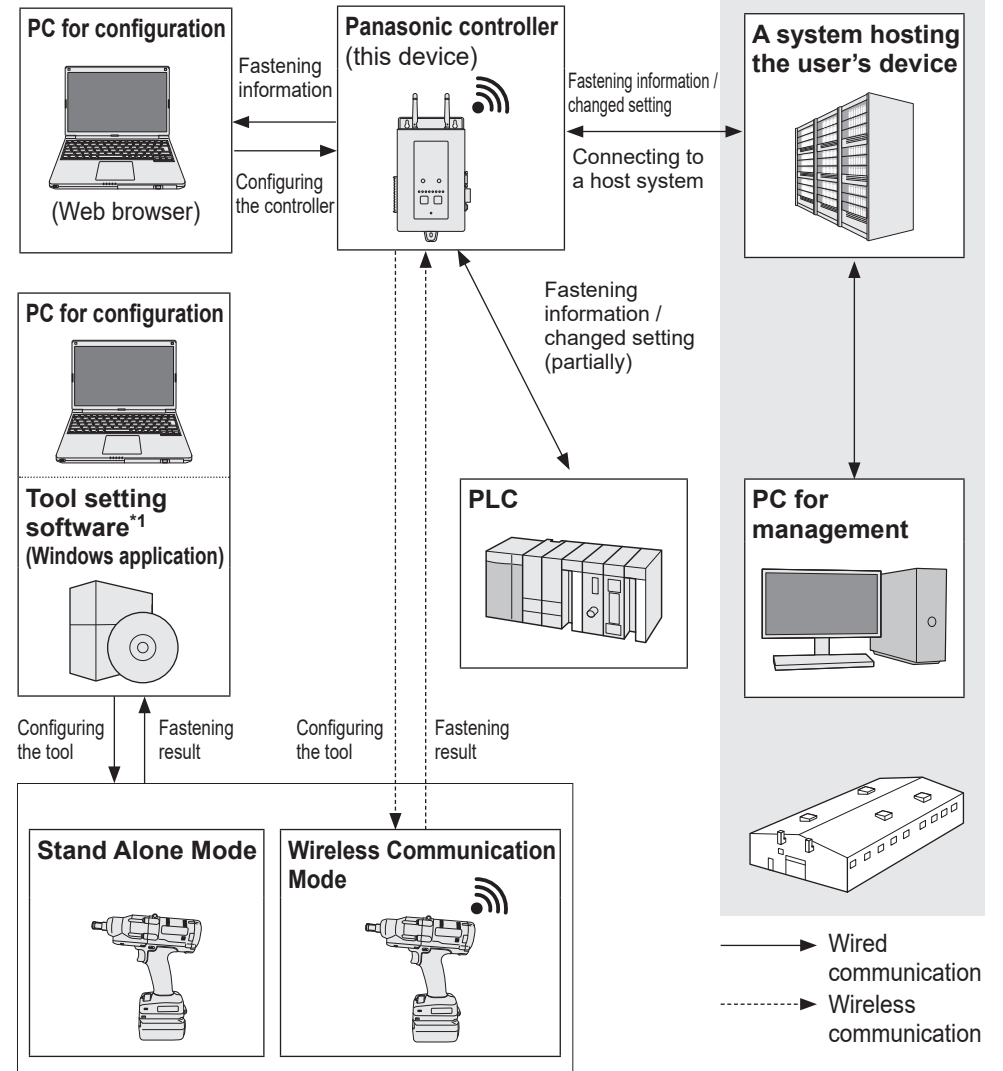

*1 The "tool setting software" can be downloaded from our web site. Refer to P2

BEFORE USE

Typical Network Configurations

The controller can be used in the 3 configurations below.

Not managing tools' IP addresses

* Automatic assignment (using the access point built in the controller)

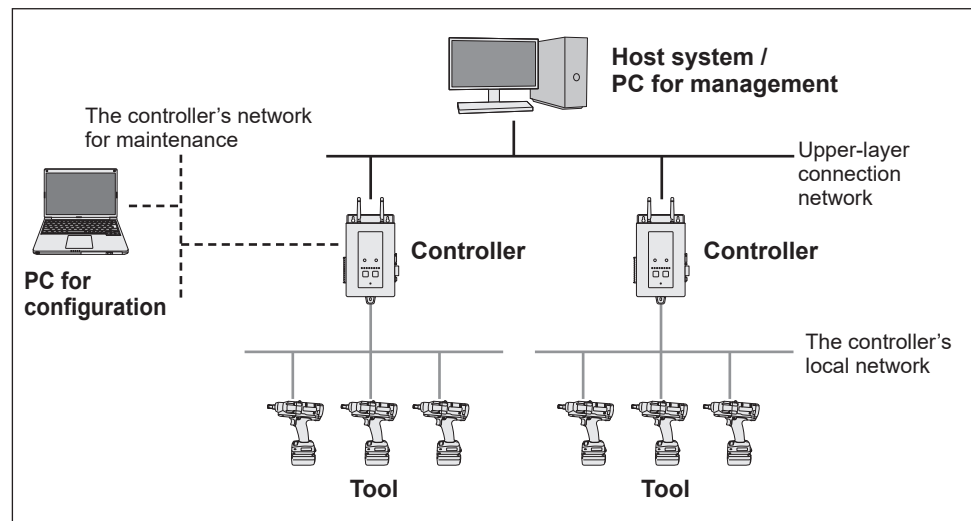

Managing tools' IP addresses (using the access point built in the controller)

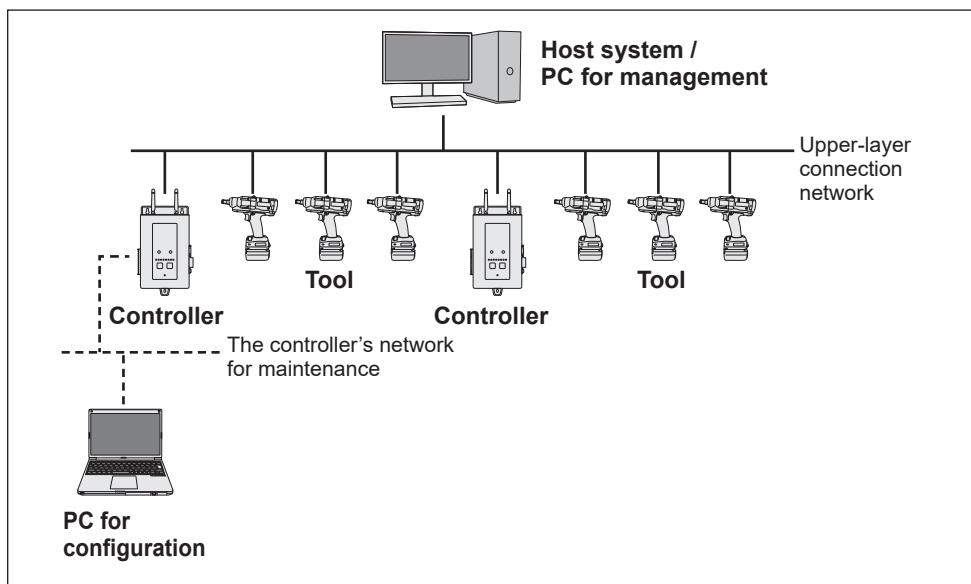

Recognising tools' IP addresses (using external access points)

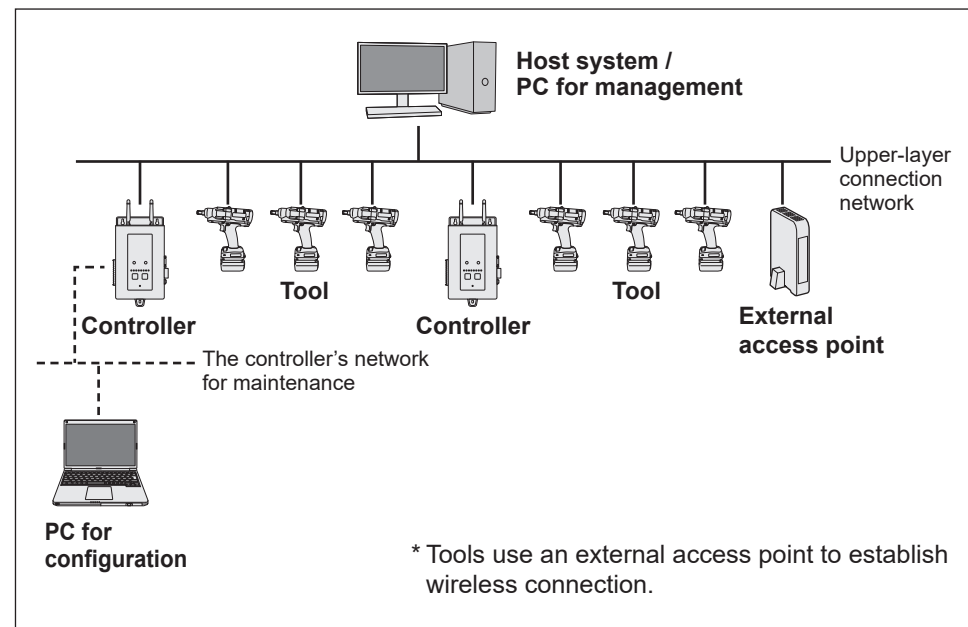

* Use the system within your local network (with no Internet connection).

* Be sure to check the IP address setting for network of the controller before starting use. (Change the default if necessary)

Applicable Tool Models List

Models that can be registered

EYFMH1WC, EYFMH2WC

Cautions for Installation

Install the controller 80 cm or more above the floor. Keep 10 cm or more between the installed controllers. (1 m or more is recommended)

Keep obstructions away from the antennas of the installed controller.

The controller has 2 diversity antennas. Keep obstructions away from both antennas.

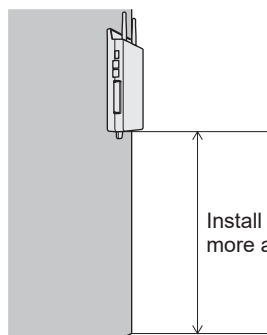

Install the controller 80 cm or more above the floor.

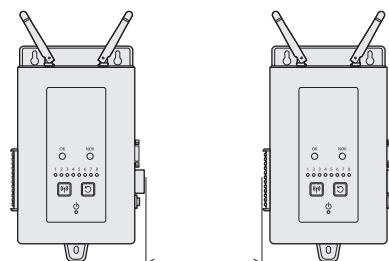

Keep 10 cm or more between the installed controllers.

Adjust the antennas' angles if communication is unstable.

* Particularly for the controller installed on a metal panel, adjusting the antennas' angles may improve the communication stability.

Tilt the antennas 30 to 45° from the wall.

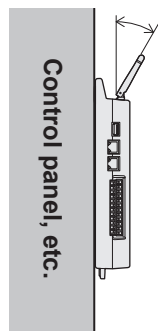

Tilt the antennas 30 to 45° outward when seen from the front.

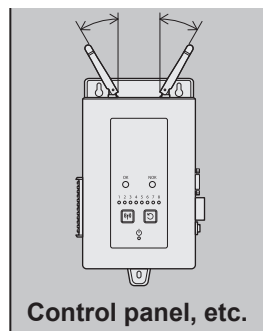

Avoid the following installation.

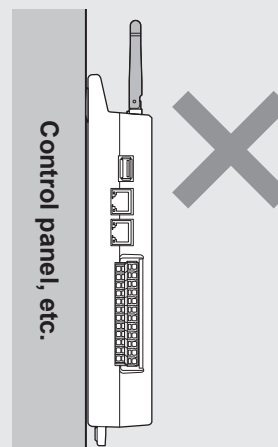

The antenna is in parallel with the control panel (metal panel) on the back side.

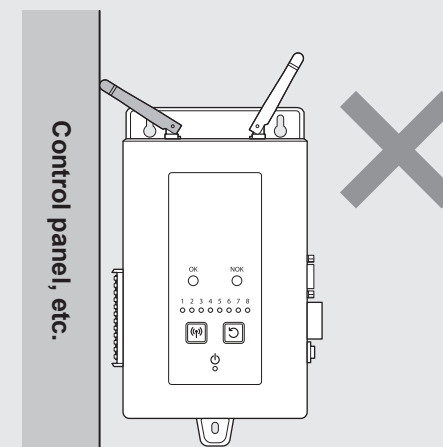

The antenna is in contact with the control panel (metal panel).

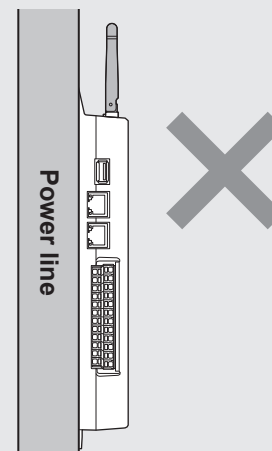

The controller is installed very close to a power line.

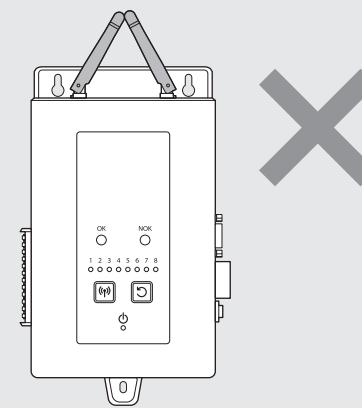

The antennas are in contact with each other.

PREPARATION BEFORE USE

Network Settings on the PC for Configuration

Set the network settings on the PC for configuration as below when you connect it and the controller for the first time.

- 1 Click on the lower left of the screen and click (Settings) - [Network & Internet] - [Change adapter options].

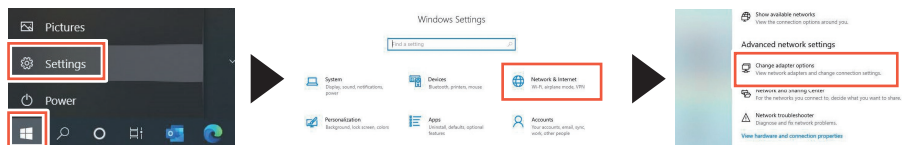

- 2 Right-click the device to connect and click [Properties].

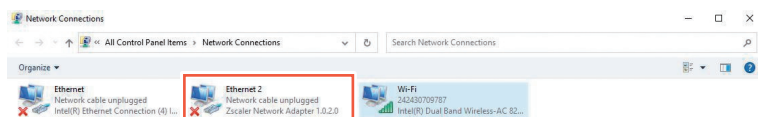

- 3 Select "Internet Protocol Version 4" and click [Properties].

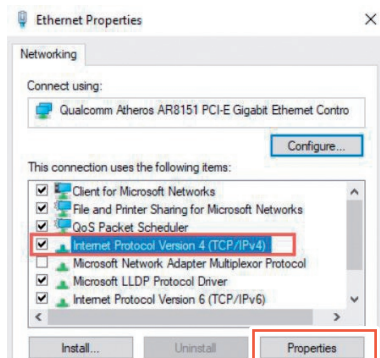

- 4 Set the "IP address" and "Subnet mask" as below.

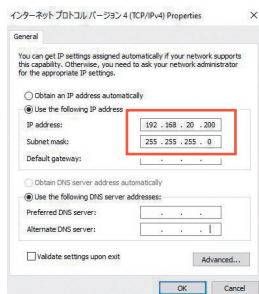

IP address	192 . 168 . 20 . 200
Subnet mask	255 . 255 . 255 . 0

- * If you changed the IP address for the controller after initial connection, enable connection by returning the network settings (IP address and subnet mask) on the PC for configuration. At the time, set the IP address so that the controller and the PC for configuration belong to the same network.
- * Write down and keep the network settings of the PC for configuration (IP address and subnet mask) before you change it.
- * Leaving the default gateway unspecified (blank) is recommended.

Displaying the Setting Screen

To configure the controller, access it via a web browser. Display the controller's setting screen as below.

When you use the controller for the first time, remove the protective film from the coin cell battery.

- 1 Turn the controller on.

- 1 Connect the supplied AC adapter to the controller and connect the power plug to an outlet.

- 2 Turn the controller's Power switch on.

- * It takes a few tens of seconds to start up.
- * During startup, the fastening OK lamp, fastening NOK lamp, and communication lamps (No. 1 to No. 8) blink together.
- * Do not connect LAN cables.

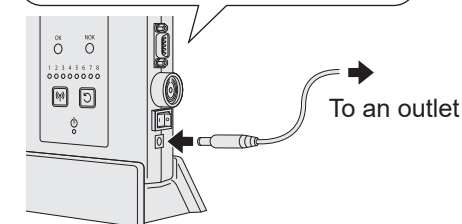
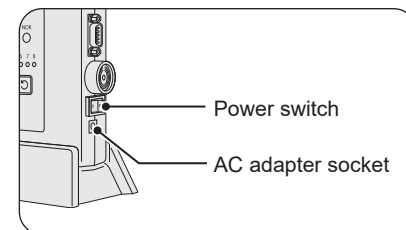

- 2 Connect the controller to the PC for configuration with a LAN cable.

- 1 Connect a LAN cable to the Ethernet port of the controller.
 - * The controller has 2 Ethernet ports: one for maintenance and one for network. Use the one for maintenance for the first connection.

- 2 Connect to the PC for configuration with the LAN cable.

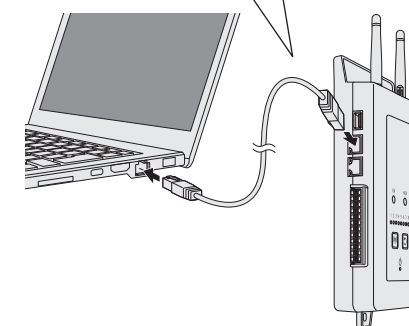
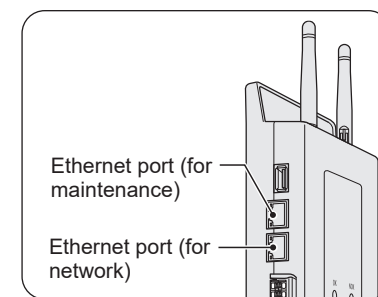

3 Start a web browser on the PC for configuration and access the controller.

- ① Start a web browser on the PC for configuration. (Microsoft Edge is recommended)
- ② Input the IP address of the controller in the address bar of the web browser.

* The default IP address for the Ethernet port (for maintenance) is “192.168.20.10”.

In the address bar of the web browser, input “http://192.168.20.10/controller” to access.

* Inputting “192.168.20.10/controller” only also allows for access.

* For how to access via the Ethernet port (for network), see “Connecting via Network”. Refer to P21

* The IP address should also be set on the PC for configuration.

- ③ In the displayed login screen, input the user ID and password.
 - * The user ID and password for the initial login are shown below.
- ④ The top page (the initial page of the setting screen) is displayed.

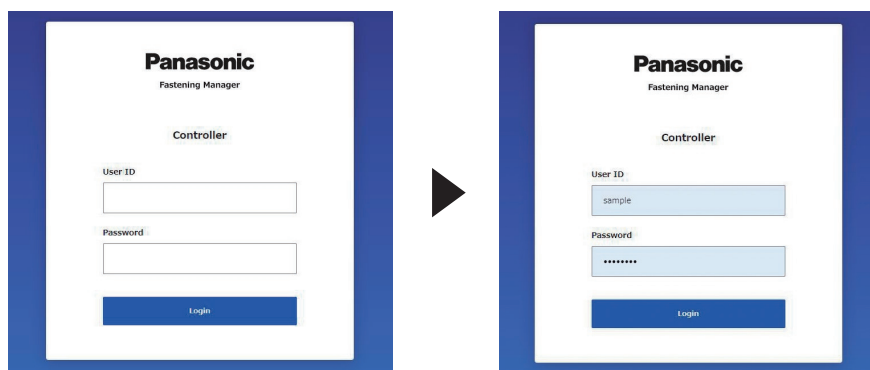

User ID and password for the initial login

Log in with the user ID and password below.

■ User ID: root

■ Password: abcABC123

* The account type for the initial login is “default”.

For the account types, see “Account Types (Authorities)”. Refer to P19

* Only account creation is possible when you log in with the user ID and password above. Create a new account before starting use.

* For security, changing the password above is recommended after the initial login.

Account Types (Authorities)

Below are the account types. Use them according to the applications.

Account Type	Function
Default	<ul style="list-style-type: none"> • For the initial login. Refer to P18 • Adding or changing a user account.
Administrator	<ul style="list-style-type: none"> • Viewing the fastening history. • Configuring the controller. • Configuring tools. • Adding or changing a user account. * Create at least one administrator account.
General	<ul style="list-style-type: none"> • Viewing the fastening history (including viewing the work monitor).

Up to 10 accounts can be registered.

Thus, more than one operator can log in simultaneously.

* Only one account can log in as administrator at the same time.

When multiple accesses are attempted, the last session takes priority.

Creating a User Account

Create a new account before starting use.

- 1 In the top page (the initial page of the setting screen), click the option key on the upper right and select “Account Settings”. The “Account Settings” screen is displayed.

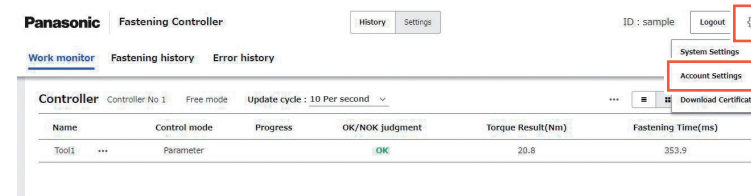

- 2 In the “Account Settings” screen, click [Add].

The “Add account” screen is displayed.

• Click [Change] to change the account and [Delete] to delete the account.

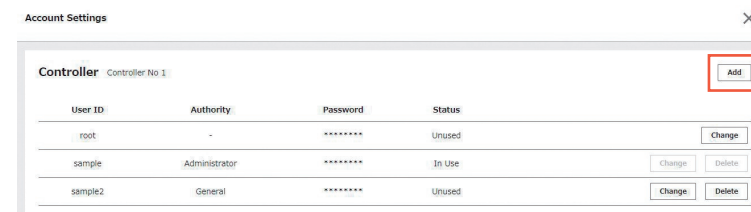

3 Input "User ID" and "Password", select "Authority", and click [Add].

- * Create an administrator account to configure tools.
- * For a password, always use a combination of 3 or more types from upper case, lower case, number, and symbol.

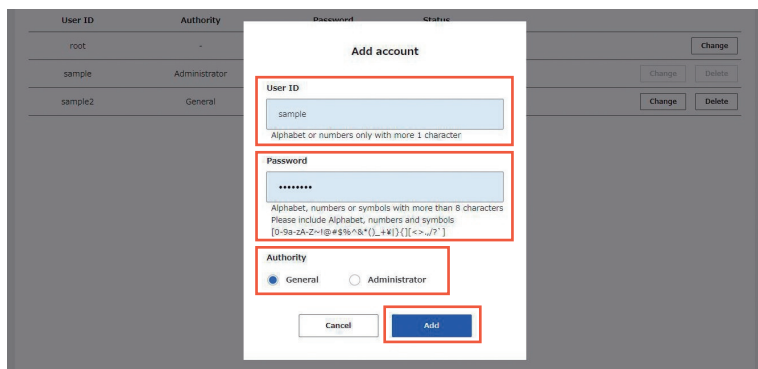

[Reference] If you lost the user ID or password

■ General account

- [Method 1] Log in as administrator and make changes to the account concerned.
- * A general user cannot change the user ID and password and needs to ask an administrator to change them.
- [Method 2] Log in with a newly created administrator account and make changes to the account concerned.
- * Log in with the user ID and password for the initial login and create a new administrator account. **Refer to P18**

■ Administrator account

- A) When multiple administrator accounts have been created
- [Method 1] Log in with another administrator account and make changes to the account concerned.
- [Method 2] Log in with a newly created administrator account and make changes to the account concerned.
- * Log in with the user ID and password for the initial login and create a new administrator account. **Refer to P18**
- [Method 3] Initialise the settings if you lost IDs and passwords of all administrator accounts. **Refer to P79**
- B) When only one administrator account has been created
- [Method 1] Log in with a newly created administrator account and make changes to the account concerned.
- * Log in with the user ID and password for the initial login and create a new administrator account. **Refer to P18**
- [Method 2] Initialise the settings if you lost IDs and passwords of all administrator accounts. **Refer to P79**

Obtaining a Certificate

A certificate is necessary to access the controller via the Ethernet port (for network). You can obtain a certificate as below.

1 In the top page (the initial page of the setting screen), click the option key on the upper right and select "Download Certificate".

A certificate datum is downloaded to the PC for configuration.

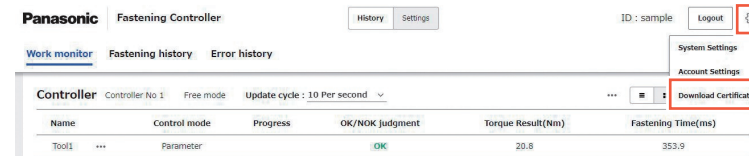

2 Install the certificate in the "PC for configuration used to access the controller via network".

① Double-click the downloaded certificate datum and select "Install Certificate".

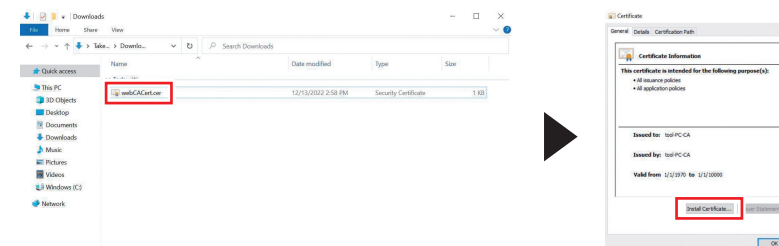

② Select "Place all certificates in the following store" and then select "Trusted Root Certification Authorities".

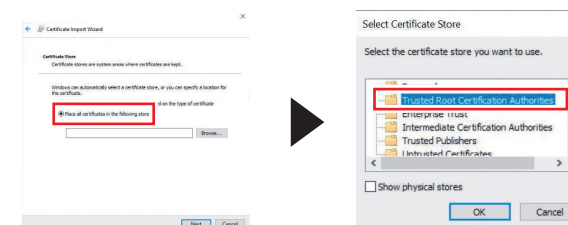

Connecting via Network

In the address bar of the web browser, input "https://XXX.XXX.XXX.XXX/controller" to connect the controller via the Ethernet port (for network).

- * "XXX.XXX.XXX.XXX" is an IP address.
- * The default IP address is "192.168.0.10". If you changed the default address, input the changed one. **Refer to P26**

Basic settings

In the top page (the initial page of the setting screen), click [Settings] on the top and select the “Basic settings” tab.

You can configure the controller.

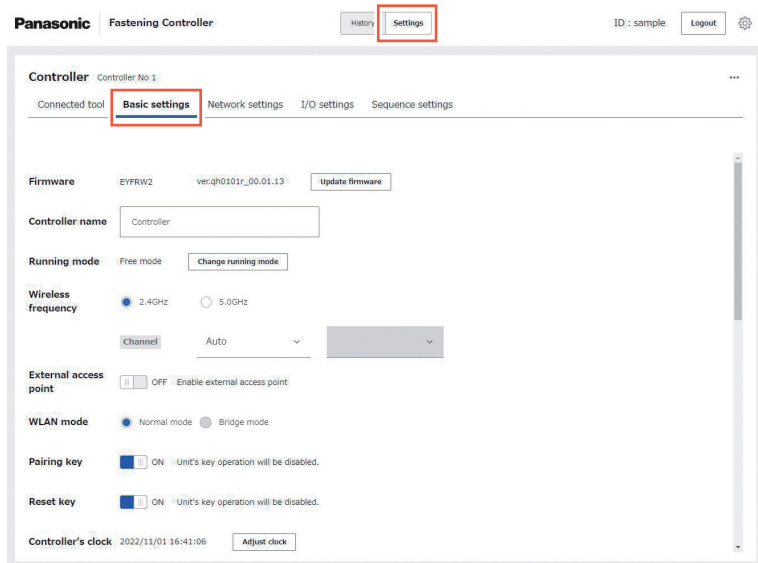

Time setting

Select “Timezone” and then click [Adjust clock].
The time is updated.

- The time is not set yet at the time of shipment. Be sure to set the time when you use the controller for the first time.

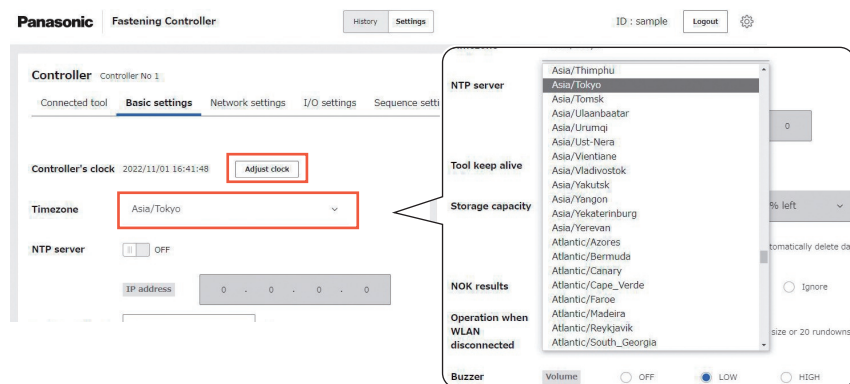

* If you use an NTP server, input the IP address.

Radio frequency and channel setting

You can set the frequency to use.

Select “2.4GHz” or “5GHz” and then the channel to use.

* Selectable channels differ between “2.4GHz” and “5GHz”.

* You can set “Auto Channel”.

The controller automatically selects available channels in the surrounding environment when it turns on.

The setting may be effective against radio interference.

* When installing multiple controllers close to each other, do not set adjacent channels.

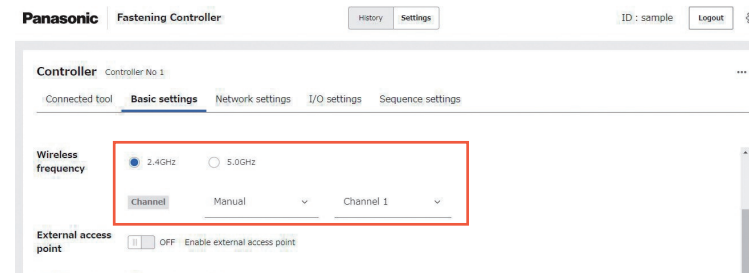

Setting items

Firmware

The firmware version of the controller is displayed.

Click [Update firmware] to update the firmware.

For how to update, see “Updating the Firmware”. **Refer to P81**

Controller name

You can register the controller’s name.

Use a maximum of 32 alphanumeric characters.

[Default] Controller

[Setting range] Up to 32 alphanumeric characters

* For symbols, only “-” (hyphen), “_” (underscore), and “ ” (half-width space) can be used.

Running mode

Select the running mode of the controller.

[Default] Free mode

[Setting range] Free mode / Repeat mode (Basic mode / Sequence mode) / External control mode

Wireless frequency

Select the frequency channel to use for wireless communication.

[Default] 2.4GHz

[Setting range] 2.4GHz (Auto / Channel 1 to 13) / 5GHz (Auto / Channel 36, 40, 44, 48)

* Channels 12 and 13 are not available in China and Korea.

<p>External access point</p> <p>You can enable communication via an external access point. Refer to P63</p> <p>[Default] OFF (disabled) [Setting range] OFF (disabled) / ON (enabled)</p> <p>* WLAN mode: This setting is for operation without using an external access point. Normal mode: When not managing tool's IP addresses (automatic assignment) Bridge mode: When managing (specifying) tools' IP addresses</p>
<p>Pairing key</p> <p>You can enable the Pairing key.</p> <p>[Default] ON (enabled) [Setting range] OFF (disabled) / ON (enabled)</p>
<p>Reset key</p> <p>You can enable the Reset key.</p> <p>[Default] ON (enabled) [Setting range] OFF (disabled) / ON (enabled)</p>
<p>Controller's clock</p> <p>Set the controller's clock. Click [Adjust clock] to update the time.</p>
<p>Timezone</p> <p>You can set a desired time zone when adjusting the controller's clock.</p>
<p>NTP server</p> <p>Set an NTP server if you use automatic clock adjustment.</p>

<p>Tool keep alive</p> <p>Set the time interval when the controller checks availability of tools in the wireless communication mode. Tools not responding are detected as offline and then disconnected.</p> <p>[Default] 30 s [Setting range] 10 s to 3600 s</p>
<p>Storage capacity</p> <p>Enable or disable notification of low storage capacity and set the behaviour in case of capacity shortage.</p> <p>[Default] Notification - OFF, Operation when capacity is insufficient - Automatically delete data</p> <p>[Setting range] Notification - OFF/ON (remaining capacity 10/20/30/40/50%), Operation when capacity is insufficient - Suspend operation / Automatically delete data</p> <p>The default setting is "Automatically delete data". Consider well how to handle data before selecting "Suspend operation" as necessary.</p>
<p>NOK results</p> <p>Select how to handle the fastening failure results.</p> <p>[Default] Store data only [Setting range] Report to system / Store data only / Ignore</p>
<p>Operation when WLAN disconnected</p> <p>Select the behaviour in case of temporary disruption of wireless communication.</p> <p>[Default] Suspend tool [Setting range] Suspend tool / Enable fastening (Until batch size or 20 rundowns) For details, see "TOOLS' BEHAVIOUR WITH WIRELESS COMMUNICATION DISCONNECTED". Refer to P70</p>
<p>Buzzer</p> <p>Select the volume and meaning of the buzzer.</p> <p>[Default] Volume - LOW, Beep - All checked</p> <p>[Setting range] Volume - OFF/LOW/HIGH, Beep - Check or uncheck each item</p>

Network Settings

In the top page (the initial page of the setting screen), click [Settings] on the top and select the “Network settings” tab.

You can make network settings of the controller.

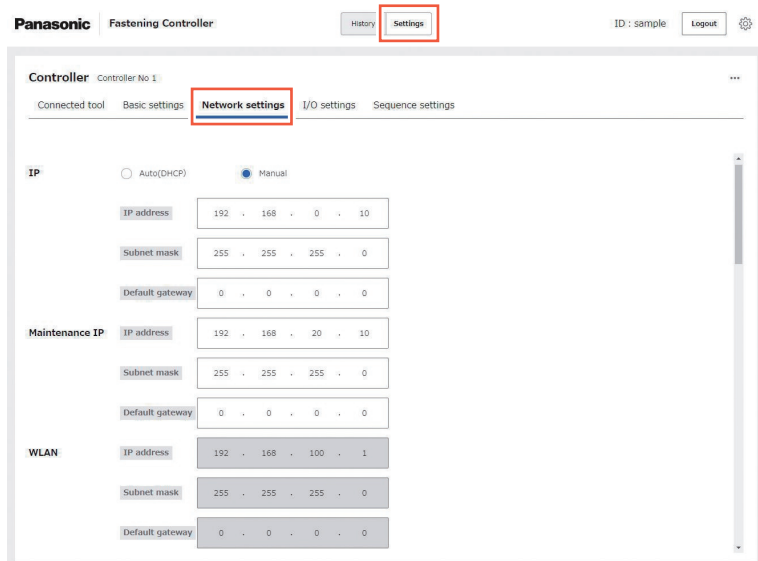

Setting items

IP

Set the IP address of the Ethernet port (for network).

[Default] Manual
[Setting range] Auto (DHCP) / Manual

* For “Manual”

[Default] IP address - 192.168.0.10
Subnet mask - 255.255.255.0
Default gateway - 0.0.0.0

Maintenance IP

Set the IP address of the Ethernet port (for maintenance).

[Default] IP address - 192.168.20.10
Subnet mask - 255.255.255.0
Default gateway - 0.0.0.0

WLAN

Set the IP address (on the controller’s side) for wireless communication with tools.

[Default] IP address - 192.168.100.1
Subnet mask - 255.255.255.0
Default gateway - 0.0.0.0

Atlas Open Protocol

Set the parameters related to Atlas Open Protocol.

For details, see “Connecting via Open Protocol Communication”. **Refer to P57**

Access point

Set the internal access point for wireless communication with tools.

[Default] SSID - Controller’s model number-MAC address
Security - WPA2
[Setting range] SSID - A maximum of 32 alphanumeric characters
Security - WPA2

External access point

Set the external access point to use.

[Default] SSID - Blank
Security - Blank
Password - Blank
[Setting range] SSID - A maximum of 32 alphanumeric characters
Security - Open/WPA2
Password - 8 to 63 alphanumeric characters

* For symbols, only “””, “¥”, “, ”, and “” (back quote)” can be used.

* The option is enabled only when “External access point” has been set to “ON” in the basic setting.

- For the IP addresses for “IP” and “Maintenance IP”, do not use the same subnet. (When you set a default value (255.255.255.0) in “Subnet mask”, set different values in the part corresponding to “192.168.0” or “192.168.20”.)

Starting the Pairing Mode on the Controller

You can put the controller in the pairing mode by “Using the key on the unit” or “Setting in the setting screen”.

During 2 minutes of the pairing mode, start the pairing mode on a tool within the coverage to automatically establish pairing.

If pairing is not established within the time, the pairing mode will end.

* After you attempt to start pairing, it may take some time until the controller enters the pairing mode.

Using the key on the unit

Use the Pairing key on the controller unit. Select the communication lamp of the number with no registration (lamp off) and hold the pairing key down to enter the pairing mode. See the following procedure for details.

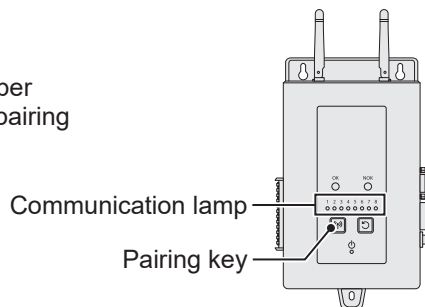

(To register Tool No. 4)

1 Press the Pairing key on the controller 4 times to select Tool No. 4.

Communication lamp No. 4 blinks.

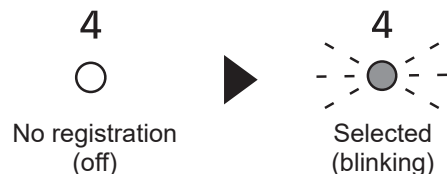

2 While No. 4 is selected, hold down the Pairing key on the controller to enter the pairing mode of Tool No. 4.

In the pairing mode, Communication lamp No. 4 starts blinking rapidly.



3 Operate Tool No. 4 to establish pairing.

Communication lamp No. 4 stays lit. For how to operate the tool, see “Starting the Pairing Mode on a Tool”. **Refer to P30**



Setting in the setting screen

In the top page (the initial page of the setting screen), click [Settings] on the top and select the “Connected tool” tab.

In the “Connected tool” screen, click [Pairing] of the desired tool number.

After the controller enters the pairing mode, perform the procedure in “Starting the Pairing Mode on a Tool”. **Refer to P30**

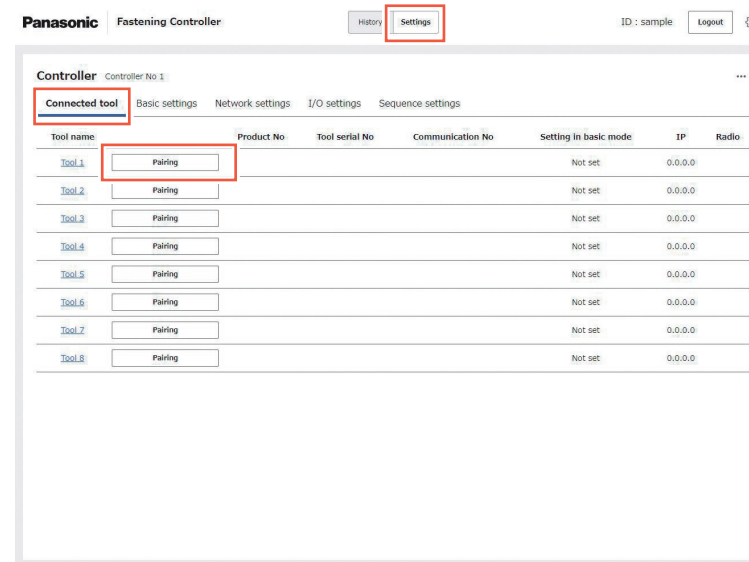

<For reference> Replacing with a spare tool

When replacing a defective paired tool with a new one with the same model number, cancel pairing **Refer to P30** and then conduct pairing **Refer to P28** so that the fastening parameters and other settings can be automatically transferred.

* To pair with a tool with a different product number, cancel pairing to delete the current pairing information before pairing with it. **Refer to P34**

Display after pairing is completed

After pairing is completed, if the setting screen does not display the information of the paired tool, conduct display update in the setting screen.

* In the “Bridge mode” or when “External access point” is enabled, set the tool’s IP address before starting pairing registration.

Starting the Pairing Mode on a Tool

Put the controller in the pairing mode before starting the pairing mode on a tool.

■ Procedure

- 1 Set the battery pack. While holding down the LED light ON/OFF button, pull the Trigger switch.**

The tool enters the pairing mode. Wireless communication is automatically established and pairing registration is completed.

* For details, see the tool's Operating Instructions.

* If pairing fails, cancel pairing on the controller and then try again.

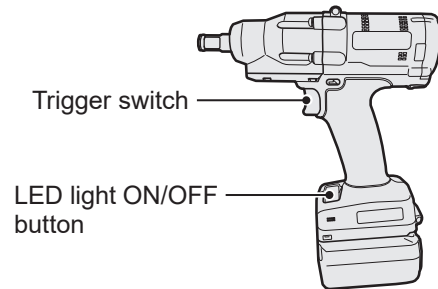

Cancelling Pairing

You can cancel pairing registration on the controller by “Using the key on the unit” or “Setting in the setting screen”.

■ Using the key on the unit

Use the Pairing key on the controller unit. Select the communication lamp of the tool number you want to cancel registration (lamp on) and hold the pairing key down to cancel pairing registration.

See the following procedure for details.

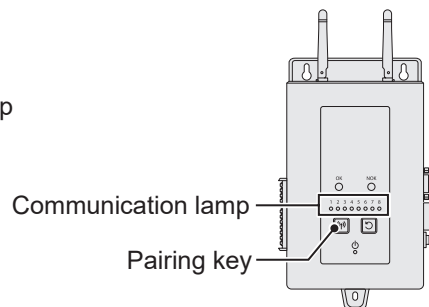

(To cancel Tool No. 4)

- 1 Press the Pairing key on the controller 4 times to select Tool No. 4.**

Communication lamp No. 4 blinks.



- 2 While No. 4 is selected, hold down the Pairing key on the controller to cancel pairing registration of Tool No. 4.**

When pairing is cancelled, Communication lamp No. 4 stops blinking and turns off.



■ Setting in the setting screen

In the top page (the initial page of the setting screen), click [Settings] on the top and select the “Connected tool” tab.

In the “Connected tool” screen, click [Cancel Pairing] of the desired tool number.

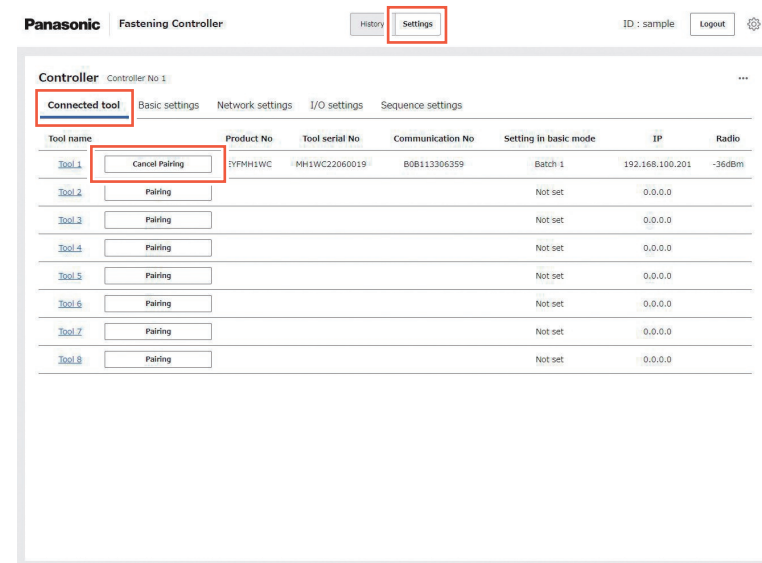

* If the controller cannot communicate with the tool due to the tool being turned off or any other reason, check [Force to unpair] in the pairing cancellation confirmation dialogue.

Displaying the Tool Screen

In the top page (the initial page of the setting screen), click [Settings] on the top and select the “Connected tool” tab.

In the “Connected tool” screen, click the desired tool number.
The screen for the tool number is displayed.

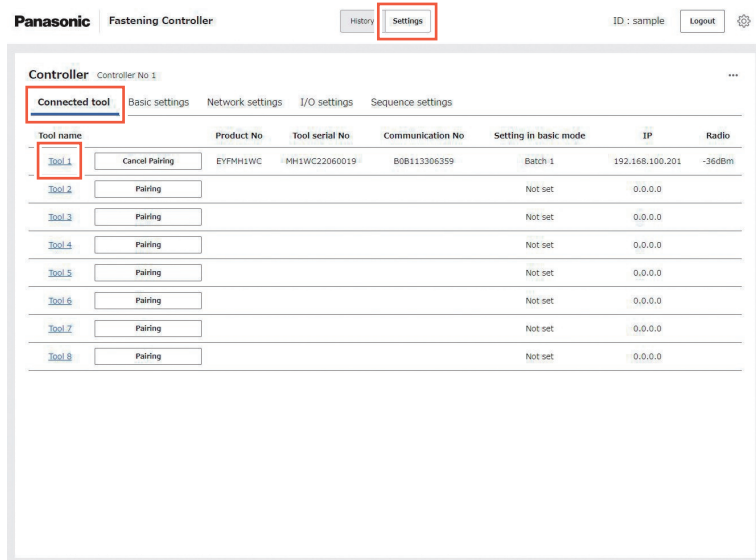

Displaying the Tool Setting Screen

From the “Device settings” tab in the screen for the tool number, you can make basic settings of the tool and enter common parameters.

* To switch the tool, select the desired one from the tool list.

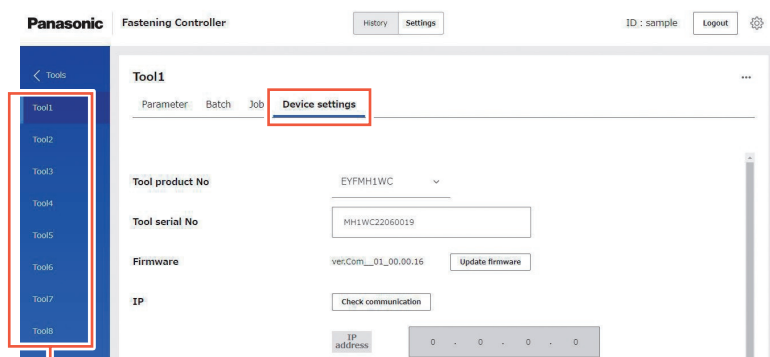

Tool list

Tool Setting Items

Tool product No

Select the tool product number.

[Default] Blank

[Setting range] Selectable from the pull-down menu

* Automatically selected if you establish pairing beforehand.

* The tool product number cannot be changed after pairing. Cancel pairing and then change it.

Tool serial No

You can set and display the tool's unit identification.

[Default] 5-digit model ID + 8-digit serial number (2-digit manufacturing year + 2-digit month + 4-digit production lot)

[Setting range] 13 to 16 alphanumeric characters

* The model number may not be recognised correctly if the information is changed.

Do not change it unless required by the management rule.

Firmware

The firmware version of the tool's communication part is displayed.

Click [Update firmware] to update the firmware.

For how to update, see “Updating the Firmware”. **Refer to P81**

IP

Set the IP address (on the tool's side) for wireless communication with tools.

[Default] IP address - 192.168.100.201 (Tool 1) to 208 (Tool 8)

Subnet mask - 255.255.255.0

Default gateway - 0.0.0.0

* They all become “0.0.0.0” in the Bridge mode or when “External access point” is enabled.

Tool's clock

The tool's clock is displayed. Click [Adjust to controller] to adjust the time.

• For other setting items, see the tool's Operating Instructions.

Deleting the Registration Information

To stop use of a tool or pair a tool with a different product number, delete the pairing information.

* Cancel pairing beforehand.

1 In the top page (the initial page of the setting screen), click [Settings] on the top and select the “Connected tool” tab.

The “Connected tool” screen is displayed.

2 In the “Connected tool” screen, click the desired tool number.

The screen for the tool number is displayed.

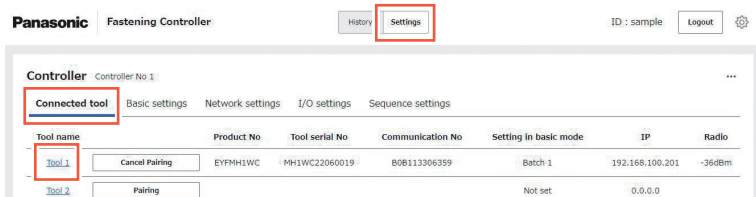

3 Click ... (tool option key) and then [Delete tool settings].

The “Delete tool settings” screen is displayed.

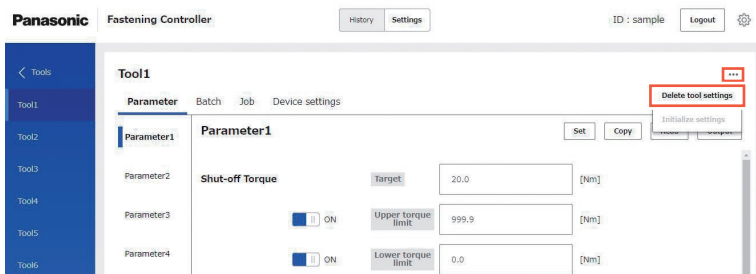

4 In the “Delete tool settings” screen, click [OK].

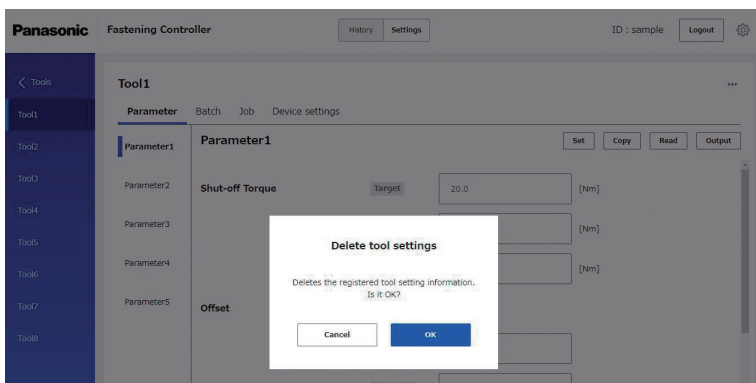

Resetting to Factory Settings

You can reset a tool to its factory settings.

* Resetting cancels pairing.

1 In the top page (the initial page of the setting screen), click [Settings] on the top and select the “Connected tool” tab.

The “Connected tool” screen is displayed.

2 In the “Connected tool” screen, click the desired tool number.

The screen for the tool number is displayed.

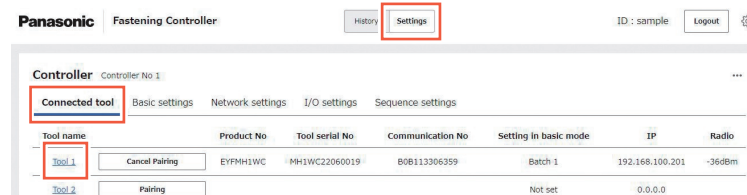

3 Click ... (tool option key) and then [Initialize settings].

The “Initialize settings” screen is displayed.

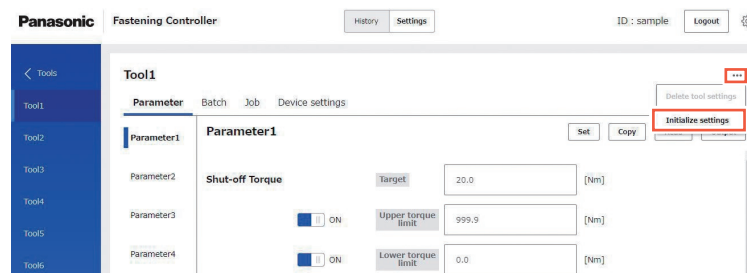

4 In the “Initialize settings” screen, click [OK].

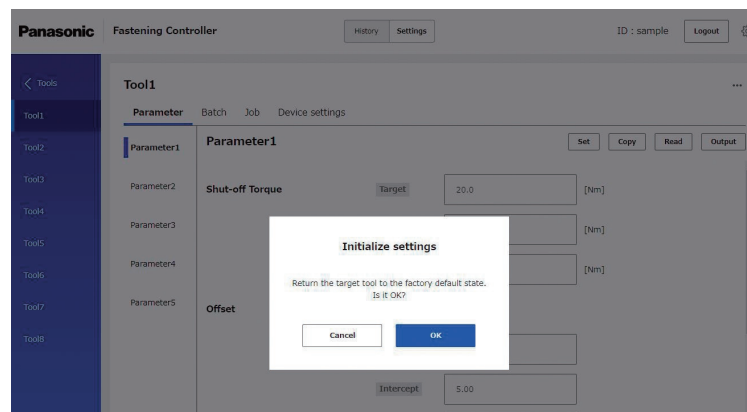

SETTING FASTENING PARAMETERS OF TOOLS

Setting Parameters

In the top page (the initial page of the setting screen), click [Settings] on the top and select the “Connected tool” tab.

In the “Connected tool” screen, click the desired tool number.

In the screen for the tool number, select the “Parameter” tab to make settings.

You can set five parameters (Parameter 1 to 5) for each tool.

* To switch the tool, select the desired one from the tool list.

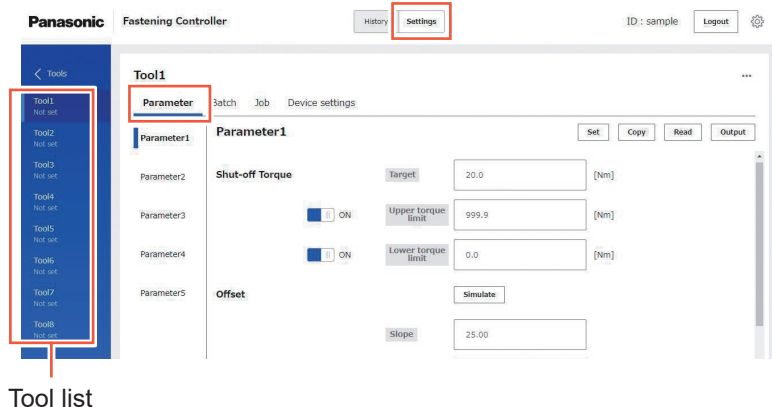

Loading Parameters

You can register a parameter by loading a parameter file saved in the PC for configuration into the controller.

You can also load a parameter file created with “Tool Manager”.

From the “Parameter” tab in the screen for the tool number, click [Read] and open the parameter file.

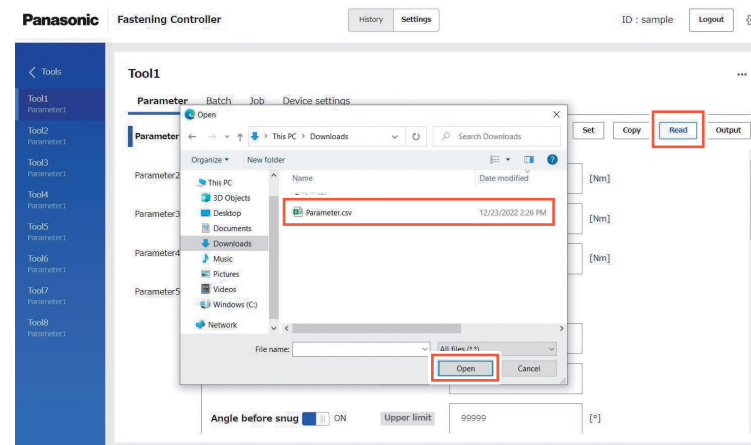

Copying Parameters

You can copy the set parameter to create a new parameter from it or use it on another tool.

In the “Parameter” tab in the screen for the tool number, click [Copy] to display the screen for copying the parameter. In the screen, select the destination and click [Copy].

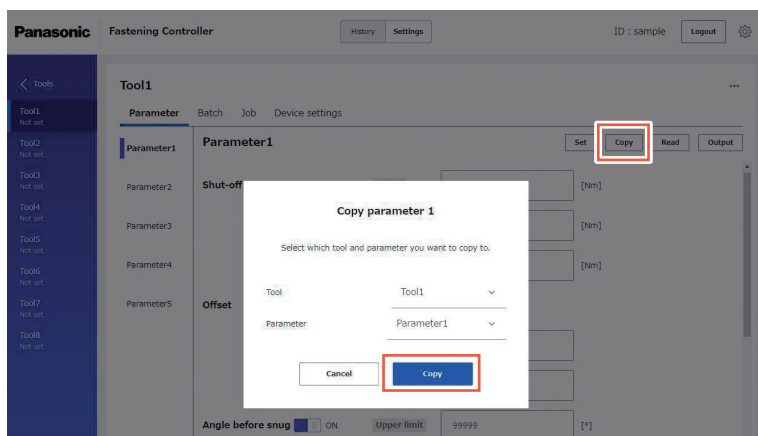

Exporting Parameters

You can export the created parameter to the PC for configuration.

You can use the exported file as a backup, to copy it to another controller, or to move it to another PC for configuration.

From the “Parameter” tab in the screen for the tool number, click [Output] and save the parameter file.

Do not edit the exported parameter file.
Otherwise it may not be read correctly.

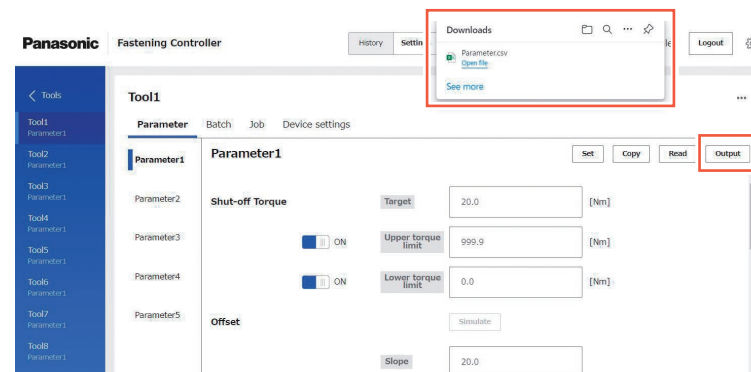

Registering Parameters

Register a parameter to use it to control a tool in “Free mode” of the controller’s running mode.

* It is not used in “Repeat mode” and “External control mode”.

(For “Free mode”, “Repeat mode”, and “External control mode”, see “Setting the Running Mode”. **Refer to P45**)

From the “Parameter” tab in the screen for the tool number, click [Set].

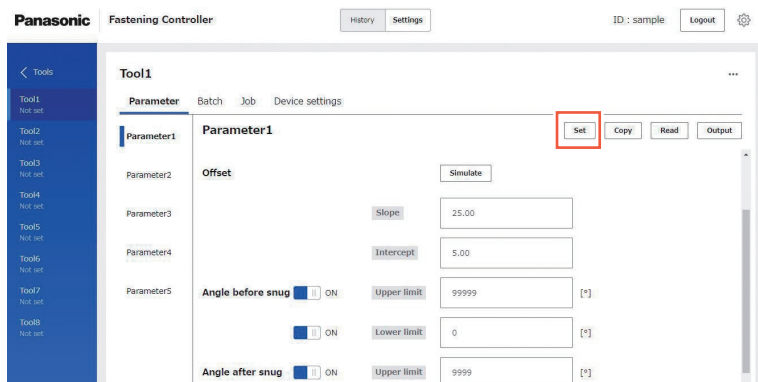

Parameter Items

Set the fastening parameter items.

For details, see the tool’s Operating Instructions.

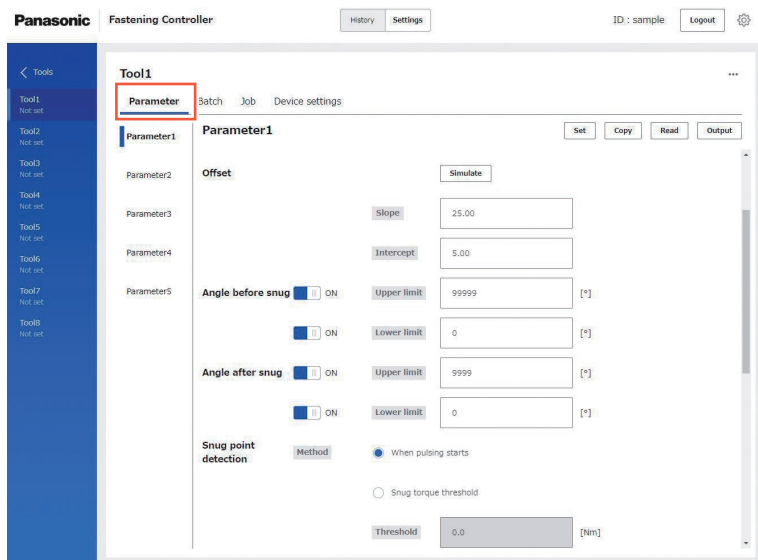

Setting an offset (Parameter, reference ①)

Set an offset to match the torque output value with the actual measured value.

1 From the “Parameter” tab in the screen for the tool number, click [Simulate] in “Offset”.

The “Offset” page is displayed.

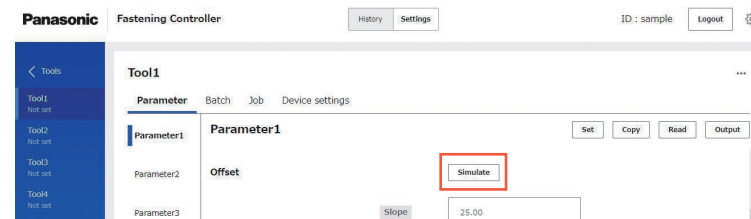

2 Input a value to set and click [Apply].

Input “Socket length” and “Shut-off Torque”.
Click [Apply] to send the input values to the tool.
The tool enters the offset mode (shown as T2).

3 Conduct actual work using the tool and then click [Get data].

A fastening history log is added to the history list in the “Offset” page.
* Although the tool becomes ready for fastening (“C mode”) after you click [Get data], do not start normal fastening until offset setting is completed.

4 While the obtained fastening history log is selected, input an actual measured torque (refastening) value and click [Calculate].

An offset to match the output torque with the actual measured torque of the tool is automatically calculated.

5 Confirm that the offset is updated and click [Apply].

The adjusted value is sent to the tool.

6 Repeat steps 3 to 5 until the difference becomes sufficiently small.

* Keep the values in the “%” column within the range of 95% to 105%.

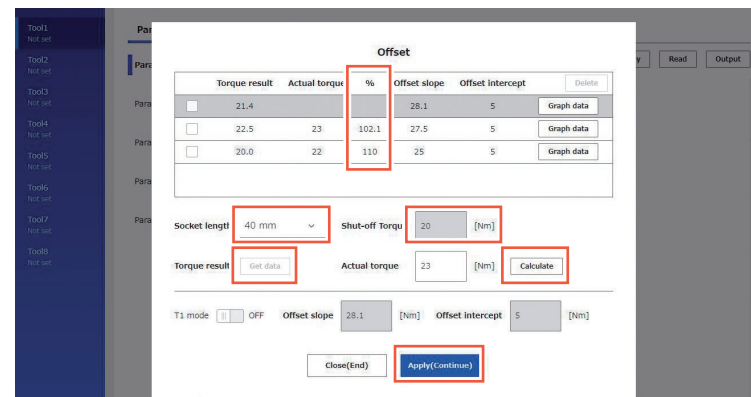

[About T1 mode]

Checking [T1 mode] in the offset setting screen puts the controller in the minimum output mode.

(Unchecking [T1 mode] returns the controller to “Offset Mode”.)



T1 mode

[Description]

You can check whether torque control works successfully when the target torque is close to the lower limit of the controller’s torque control range. In this mode, the controller is shut off at the minimum counts per minute (minimum output).

At the time, the work history log is not stored.

After working in this mode, use a torque gauge or torque wrench to confirm that the controller’s output torque has not exceeded the target torque.

The controller unit may not be usable for some work if its output torque exceeds the target torque in this mode.

* Fastening by other tools is suspended while you are setting an offset.

■ Setting a snug point (Parameter, reference ②)

You can set a snug point based on a waveform.

1 From the “Parameter” tab in the screen for the tool number, click [Select from graph] in “Snug point detection”.

- The “Snug point detection” screen is displayed showing the current waveform of the tool.
- Fastening history data are necessary for reference. Make this setting after at least one time of fastening.
- You can switch the waveform to use with arrows (①).

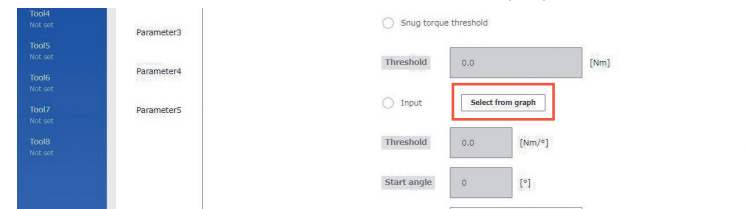

2 Set a threshold in the graph.

- The main window (②) shows an entire waveform and the subwindow (③) enlarges a specific part from the entire waveform.
- You can change the range of waveform shown in the main window by inputting the start and end angles in “X-axis” (④) below the graph.
- You can set the snug point detection start angle (⑤) by moving the vertical bar.
- Adjust the position of the selection frame (⑥) in the main window to change the display range of the subwindow.
- Select a threshold to set in the subwindow (③).



SETTING THE FASTENING CONTROL MODE

Controlling Fastening by Tools



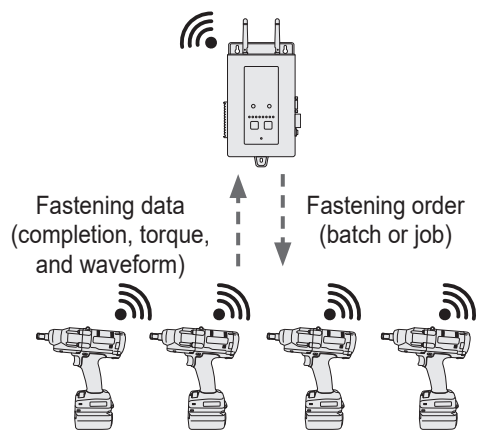

The controller can control up to 8 connected tools for fastening. It receives fastening data of each fastening job and counts up the fastened quantity.

Maximum number of connected devices: 8

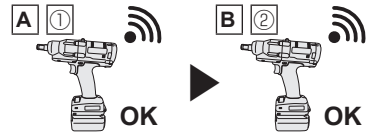

Typical Fastening Control Combinations

You can create different combinations of fastening control settings. See typical combinations as below.

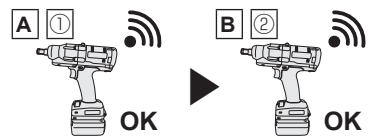
Mode	[Free mode]	[Repeat mode]																						
		[Basic mode]	[Sequence mode]																					
Pass criterion	— (The quantity is not specified)	Fastening the target quantity is completed	Tools complete fastening the respective target quantities in the specified order																					
[Batch] “Single set value” (Fastening in the same condition) * Single type of workpiece	 <table border="1" data-bbox="1344 715 1523 774"> <tr><th>Set value</th><th>Target quantity</th></tr> <tr><td>10 Nm</td><td>∞</td></tr> </table> <p>Parameter</p>	Set value	Target quantity	10 Nm	∞	 <table border="1" data-bbox="1545 715 1724 774"> <tr><th>Set value</th><th>Target quantity</th></tr> <tr><td>10 Nm</td><td>10</td></tr> </table> <p>Batch</p>	Set value	Target quantity	10 Nm	10	 <table border="1" data-bbox="1747 715 1926 774"> <tr><th>Set value</th><th>Target quantity</th></tr> <tr><td>10 Nm</td><td>10</td></tr> </table> <table border="1" data-bbox="1937 715 2116 774"> <tr><th>Set value</th><th>Target quantity</th></tr> <tr><td>20 Nm</td><td>5</td></tr> </table> <p>Batch and Sequence</p>	Set value	Target quantity	10 Nm	10	Set value	Target quantity	20 Nm	5					
Set value	Target quantity																							
10 Nm	∞																							
Set value	Target quantity																							
10 Nm	10																							
Set value	Target quantity																							
10 Nm	10																							
Set value	Target quantity																							
20 Nm	5																							
[Job] Multiple set values (Fastening in different conditions) * Multiple types of workpiece	 <table border="1" data-bbox="1545 1029 1724 1141"> <tr><th>Set value</th><th>Target quantity</th></tr> <tr><td>10 Nm</td><td>2</td></tr> <tr><td>20 Nm</td><td>3</td></tr> <tr><td>30 Nm</td><td>5</td></tr> </table> <p>Job</p>	Set value	Target quantity	10 Nm	2	20 Nm	3	30 Nm	5	 <table border="1" data-bbox="1747 1029 1926 1141"> <tr><th>Set value</th><th>Target quantity</th></tr> <tr><td>10 Nm</td><td>2</td></tr> <tr><td>20 Nm</td><td>3</td></tr> <tr><td>30 Nm</td><td>5</td></tr> </table> <table border="1" data-bbox="1937 1029 2116 1141"> <tr><th>Set value</th><th>Target quantity</th></tr> <tr><td>20 Nm</td><td>5</td></tr> <tr><td>30 Nm</td><td>10</td></tr> </table> <p>Job and Sequence</p>	Set value	Target quantity	10 Nm	2	20 Nm	3	30 Nm	5	Set value	Target quantity	20 Nm	5	30 Nm	10
Set value	Target quantity																							
10 Nm	2																							
20 Nm	3																							
30 Nm	5																							
Set value	Target quantity																							
10 Nm	2																							
20 Nm	3																							
30 Nm	5																							
Set value	Target quantity																							
20 Nm	5																							
30 Nm	10																							
Remark	—	* A job can contain up to 10 steps.	* A sequence can contain up to 10 steps.																					

Number of Combinations That Can Be Registered

See the number of combinations that can be registered in the controller as below.

Controller's mode		Tool's setting	Number of Combinations That Can Be Registered
Free mode		Parameter	5 combinations per tool
Repeat mode	Basic mode (Independent control)	Batch	5 combinations per tool
		Job	5 combinations per tool
	Sequence mode (Sequential control)	Batch/Job	5 combinations
External control mode		—	5 combinations

Setting the Running Mode

Set the running mode of the controller as below.

- 1 In the top page (the initial page of the setting screen), click [Settings] on the top and select the “Basic settings” tab.
- 2 In the “Basic settings” tab, click [Change running mode]. The “Change running mode” screen is displayed.

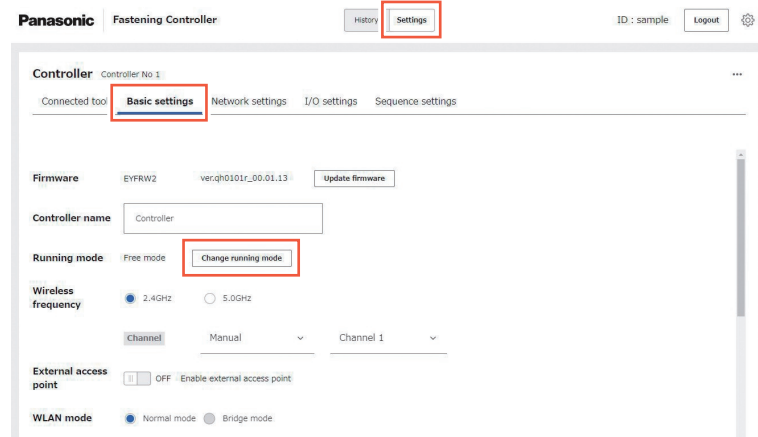

- 3 Select a “Running mode” and click [OK]. The running mode is set. Select a running mode from “Free mode”, “Repeat mode”, and “External control mode”. For “Repeat mode”, select “Basic mode” or “Sequence mode”.

Refer to P46 to 49

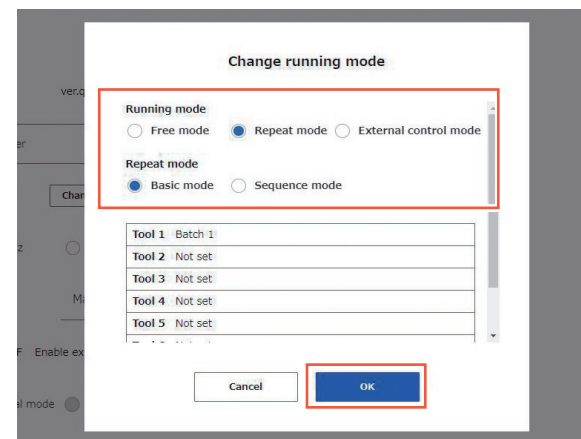

- * Register “Parameter” before setting to “Free mode”.
- * Register a “Batch/Job” before setting to “Repeat mode”.

SETTING THE FASTENING CONTROL MODE (cont.)

Free mode

This mode allows for unconditional fastening without specifying the quantity to fasten. Tools use pre-registered parameters for fastening. Up to 8 tools can conduct independent operation. The I/O output settings are enabled.

* Use the mode when the fastened quantity is counted by an external device.

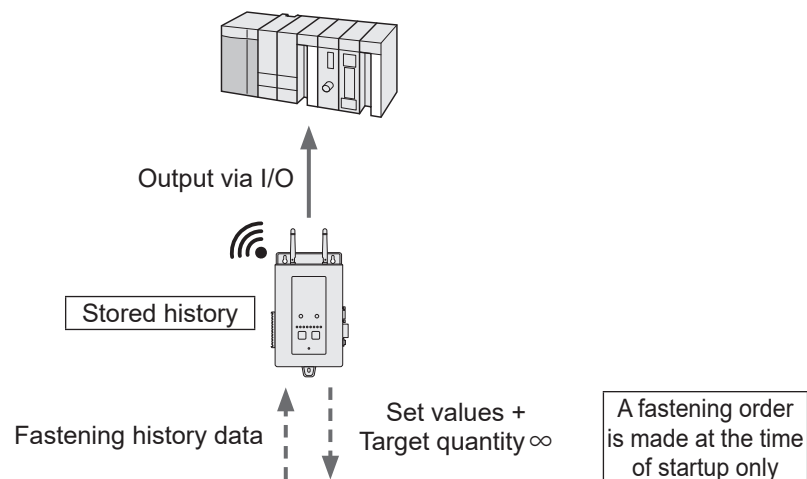

Set value	Target quantity
10 Nm	∞

Set value	Target quantity
20 Nm	∞

Set value	Target quantity
30 Nm	∞

Set value	Target quantity
40 Nm	∞

Up to 8 tools can be controlled at the same time

Set value	Target quantity
50 Nm	∞

Set value	Target quantity
60 Nm	∞

Set value	Target quantity
70 Nm	∞

Set value	Target quantity
80 Nm	∞

Repeat mode (Basic mode)

This mode repeats a "Batch" or "Job" process. Tools use pre-registered "Batch" or "Job" settings for fastening. Up to 8 tools can conduct independent operation. The I/O output settings are enabled.

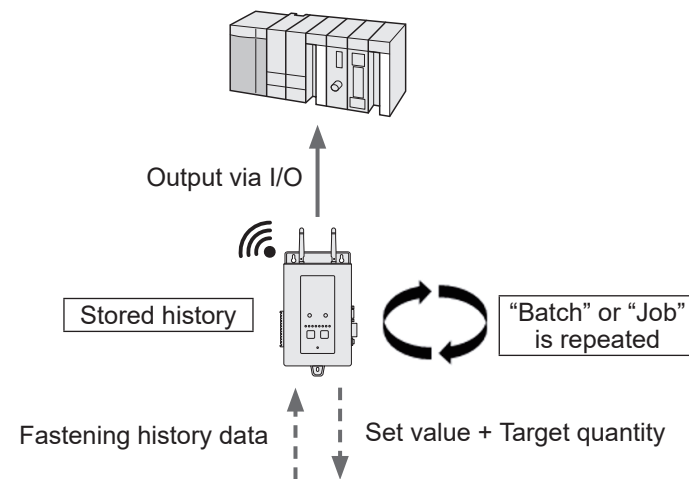

Set value	Target quantity
10 Nm	10

Set value	Target quantity
20 Nm	10

Set value	Target quantity
30 Nm	10

Set value	Target quantity
40 Nm	10

Up to 8 tools can be controlled at the same time

Set value	Target quantity
50 Nm	10
60 Nm	5
70 Nm	5

Set value	Target quantity
60 Nm	10
70 Nm	5
80 Nm	5

Set value	Target quantity
70 Nm	10
80 Nm	5
90 Nm	5

Set value	Target quantity
80 Nm	10
90 Nm	5
10 Nm	5

Repeat mode (Sequence mode)

This mode repeats a "Sequence" process where available tools are controlled in order. Tools use pre-registered "Sequence" settings for sequential fastening. Up to 10 steps can be set. A sequence supports up to 8 tools but allows only one tool to operate at a time. The I/O output settings are enabled.

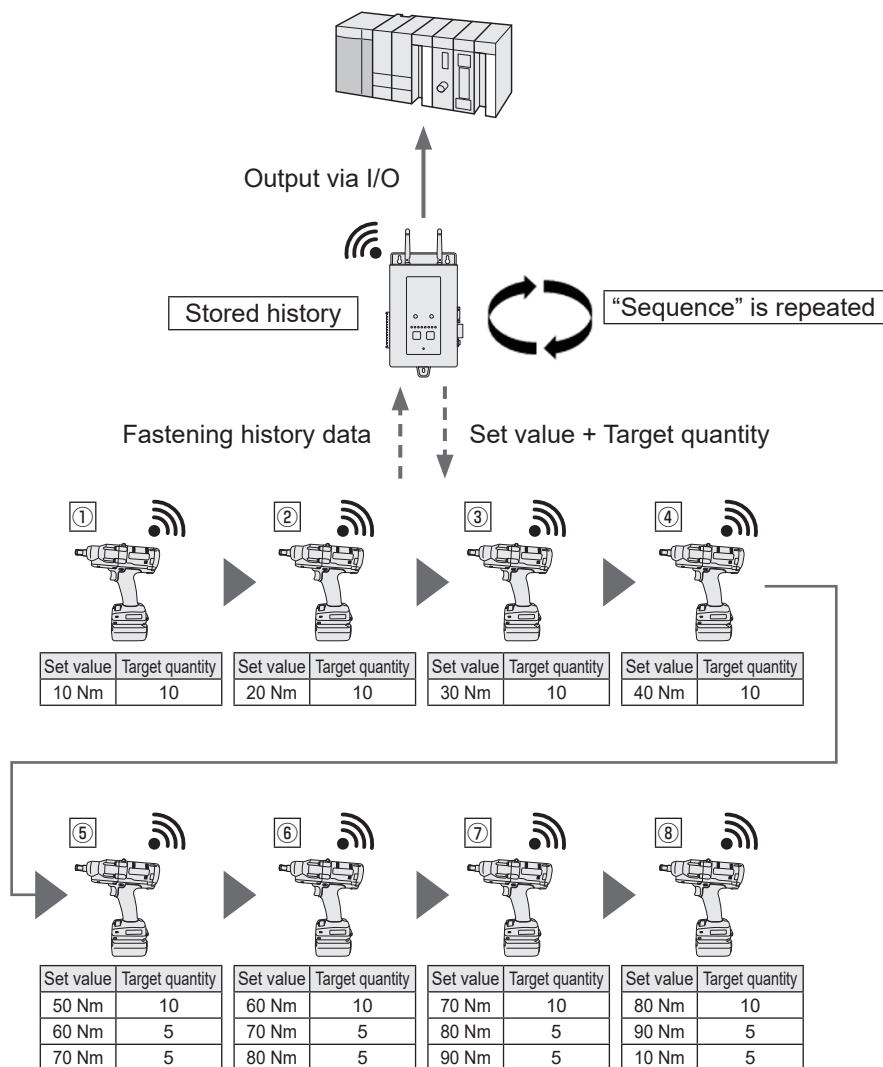

External control mode

This mode allows for fastening control as ordered by an external device (host system). The following 2 types of control are supported.

Control via Open Protocol (with Open Protocol enabled)

Fastening is controlled via Open Protocol by a host system. Up to 8 tools can be controlled independently. * Job and sequence controls are not supported.

Control via I/O (with Open Protocol disabled)

Fastening is controlled by inputs via the I/O port from an external device. Up to 8 tools can be controlled independently or sequentially.

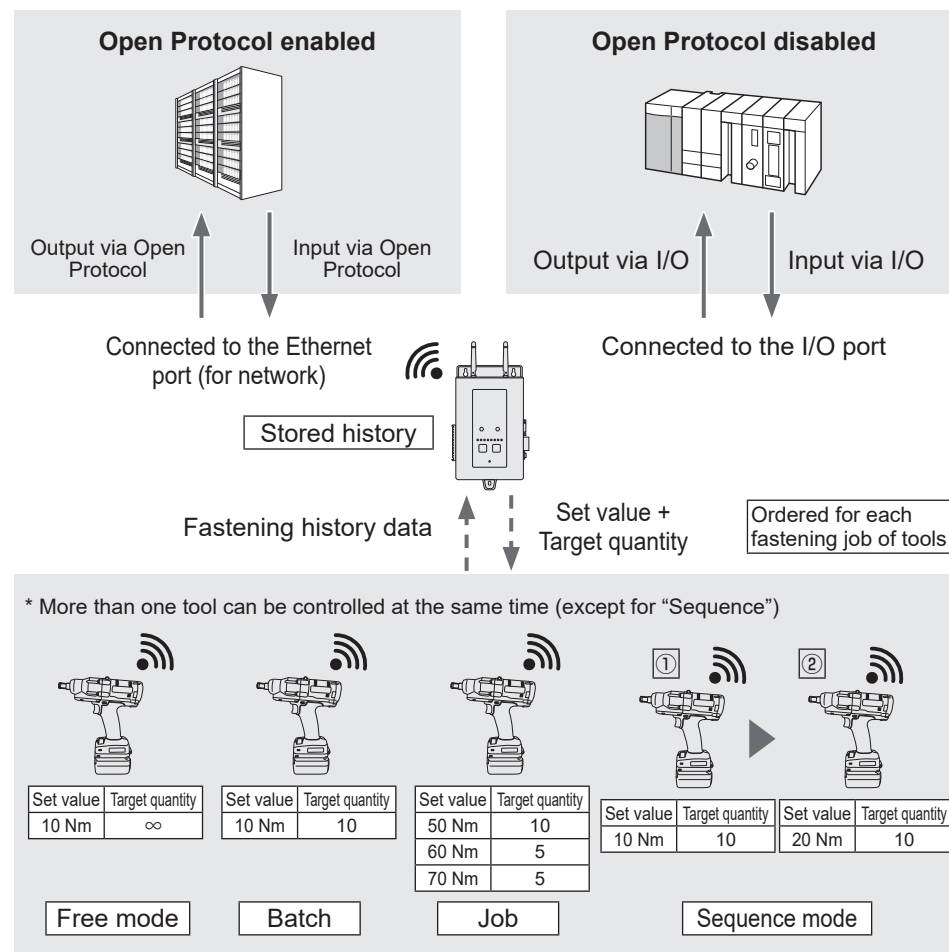

* If the controller turns off during fastening, fastening does not resume after the controller turns on. Fastening starts again when ordered by an external device.
* The I/O output settings are enabled.

Creating (Setting) a Batch

In the top page (the initial page of the setting screen), click [Settings] on the top and select the “Connected tool” tab. In the “Connected tool” screen, click the desired tool number. In the screen for the tool number, select the “Batch” tab and make settings. Select a parameter from the “Parameter” pull-down menu and set “Batch size” (quantity to fasten, up to 99). Click [Set] to set the values for “Repeat mode (Basic mode)”.

- * To switch the tool, select the desired one from the tool list.
- * Up to 5 batches can be registered.

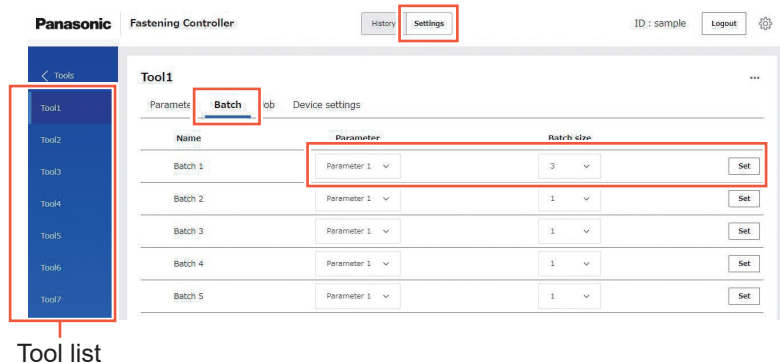

Creating (Setting) a Job

In the top page (the initial page of the setting screen), click [Settings] on the top and select the “Connected tool” tab. In the “Connected tool” screen, click the desired tool number. In the screen for the tool number, select the “Job” tab and make settings. Select a parameter from the “Parameter” pull-down menu and set “Batch size” (quantity to fasten, up to 99). Click [Set] to set the values for “Repeat mode (Basic mode)”.

- * Up to 10 steps can be registered.
- * To switch the tool, select the desired one from the tool list.
- * Up to 5 jobs can be registered.

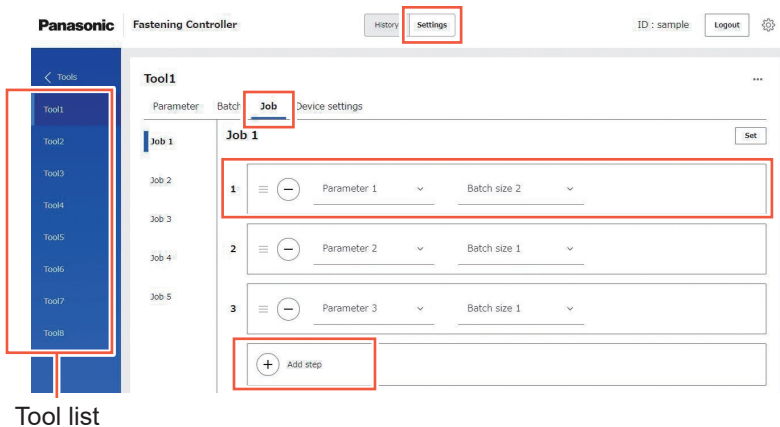

Creating (Setting) a Sequence

In the top page (the initial page of the setting screen), click [Settings] on the top and select the “Sequence settings” tab.

In the “Sequence settings” screen, select a tool from the “Tool” pull-down menu and set “Batch” or “Job”.

Click [Set as running mode] to set the values for “Repeat mode (Sequence mode)”.

- * Up to 5 sequences can be registered.
- * Up to 10 steps can be registered.
- * The same tool can be used more than once in a sequence.

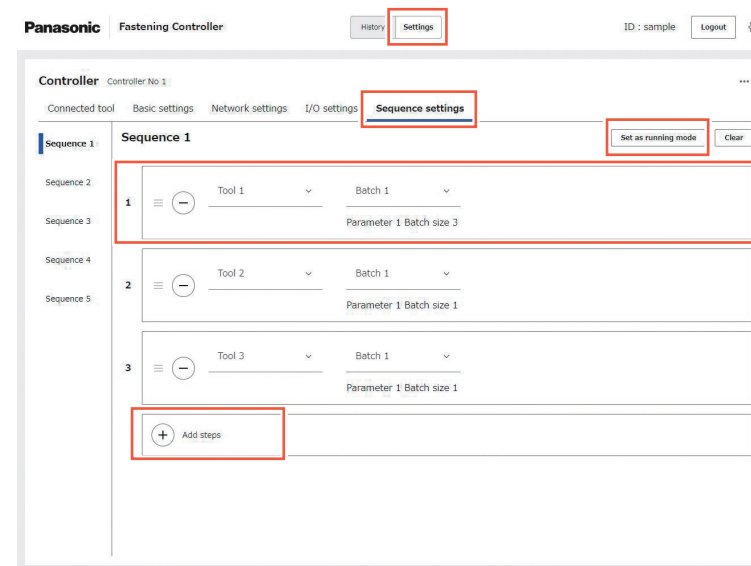

Supported Types of External Devices

The controller supports the following types of external device.

Feature	PC for Configuration	PLC	Customer's Host System
Illustration			
Communication method	Ethernet	I/O	Ethernet
Communication protocol	http/https	— (ON/OFF signal only)	Open Protocol
Main use	<ul style="list-style-type: none"> Viewing and storing the fastening history Changing the settings 	<ul style="list-style-type: none"> Outputting completion and failure signals Switching the fastening order 	<ul style="list-style-type: none"> Exporting the fastening history Switching the fastening order
Data that can be exported	<ul style="list-style-type: none"> Serial numbers of tools Time Completion and failure results Torque values, angles, fastening time lengths Waveform data 	<ul style="list-style-type: none"> Completion and failure results Batch/job/sequence complete Batch/job/sequence selected Tool active 	<ul style="list-style-type: none"> Serial numbers of tools Time Completion and failure results Torque values, angles, fastening time lengths Waveform data
Switching the fastening order	—	• Batch/job/sequence selected	• Parameter/batch selected
Other	Displayed in a web browser. Microsoft Edge is recommended.	8 ports each for input and output	For supported commands, see "Commands compatible with Open Protocol". Refer to P61 Control sequences should be reviewed respectively.

Connecting to the PC for Configuration in a Remote Location

The PC for configuration with the certificate installed can remotely connect to controllers. Note that only one access to the configuration function is accepted at a time. To connect, input the IP address of the desired controller in a web browser.

Refer to P21

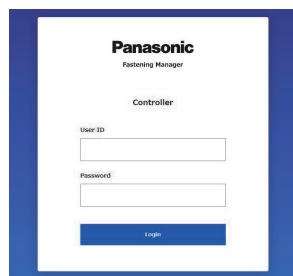
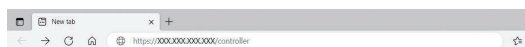

Connecting via I/O

You can assign supported commands to 8 input ports and 8 output ports as desired. Assign them in the "I/O settings" screen.

Below are the commands that can be assigned to the ports.

Input	Supported command	Output	Supported command
1	Batch (Tool 1 to 5) Job (Tool 1 to 5) Sequence (1 to 5) Batch reset (1 to 8) Reset Suspend tool (1 to 8) Suspend controller	1	OK (Tool 1 to 8) NOK (Tool 1 to 8) Batch complete (Tool 1 to 5) Job complete (Tool 1 to 5) Sequence complete (1 to 5) Tool active (Tool 1 to 8) Batch selected (Tool 1 to 5) Job selected (Tool 1 to 5) Sequence selected (1 to 5)
2		2	
3		3	
4		4	
5		5	
6		6	
7		7	
8		8	

Setting I/O

In the top page (the initial page of the setting screen), click [Settings] on the top and select the "I/O settings" tab.

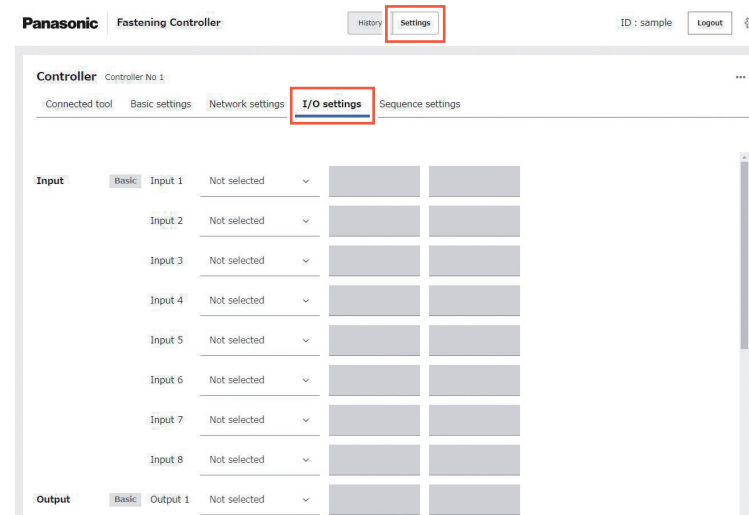

* It is possible to assign a behaviour or event not registered yet. (Except for job selection and sequence selection)

Commands Assigned to Input Ports

Below are the commands that can be assigned to the input ports. When a signal from an external device is input to one of the ports, the assigned command is executed.

Major Category (Behaviour)	Medium Category (Tool)	Minor Category (Batch No., Etc.)
Batch	Tool 1 to 8	1-5
Job	Tool 1 to 8	1-5
Sequence	—	1-5
Suspend tool*1	Tool 1 to 8	—
Suspend controller*1	—	—
Batch reset	Tool 1 to 8	—
Reset	—	—

*1 Enabled only while the input signal is held.

Notes when the “Suspend tool” or “Suspend controller” command is input

- While “Suspend controller” is active, no fastening order is accepted.
- For the tool number with “Suspend tool” active, no “Batch” or “Job” fastening order is accepted.
- For other tool numbers than that with “Suspend tool” active, a “Batch” or “Job” fastening order is accepted.
- While “Suspend tool” is active, no “Sequence” fastening order is accepted. At the time, the process continues until it reaches the tool with “Suspend tool” active.
- “Batch reset” and “Reset” are treated in the same manner as a fastening order.

After selecting a behaviour in the major category, select a tool and then a number (e.g., batch number) as necessary.

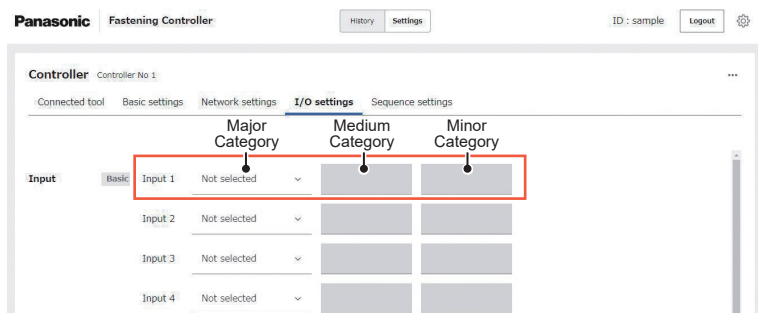

* No action is conducted if an unassigned signal is input. (No error occurs)

Commands Assigned to Output Ports

Below are the commands that can be assigned to the output ports. When a relevant event has occurred, the controller outputs a signal from the corresponding port to an external device as specified by the assigned command.

Major Category (Event)	Medium Category (Tool)	Minor Category (Batch No., Etc.)
OK	Tool 1 to 8	—
NOK	Tool 1 to 8	—
Batch complete	Tool 1 to 8	1-5
Job complete	Tool 1 to 8	1-5
Sequence complete	—	1-5
Tool active	Tool 1 to 8	—
Batch selected	Tool 1 to 8	1-5
Job selected	Tool 1 to 8	1-5
Sequence selected	—	1-5

After selecting an event in the major category, select a tool and then a number (e.g., batch number) as necessary.

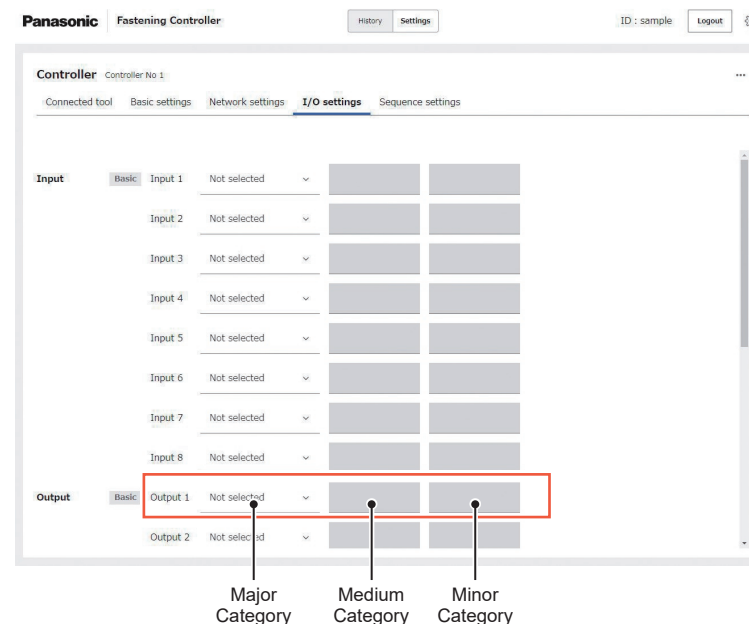

* If the controller turns off while executing an output command, the process does not resume after the controller turns on. (Note that fastening history data are saved.)

Other Settings

You can set other I/O related settings as below.

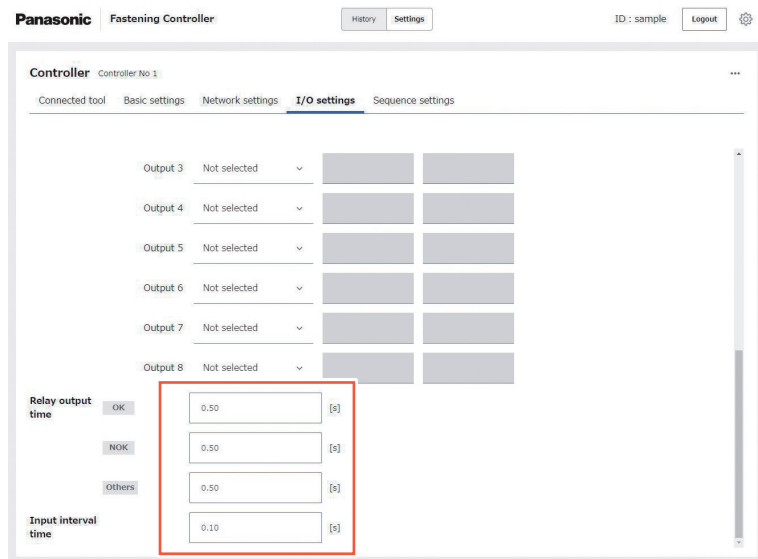

Relay output time (OK)

Select the time length until a fastening completion signal is output by the relay.

[Default] 0.5 s

[Setting range] 0.01 s to 10 s

Relay output time (NOK)

Select the time length until a fastening failure signal is output by the relay.

[Default] 0.5 s

[Setting range] 0.01 s to 10 s

Relay output time (Others)

Select the time length until any other signal than fastening completion and failure signals is output by the relay.

[Default] 0.5 s

[Setting range] 0.01 s to 10 s

Input interval time

Select the time length when the successive input signals are not counted (accepted). Set it to prevent double-counting caused by noise, etc.

[Default] 0.1 s

[Setting range] 0.01 s to 10 s

Connecting via Open Protocol Communication

In the top page (the initial page of the setting screen), click [Settings] on the top and select the "Network settings" tab.

Enable "Atlas Open Protocol".

Set port numbers to the tools used respectively.

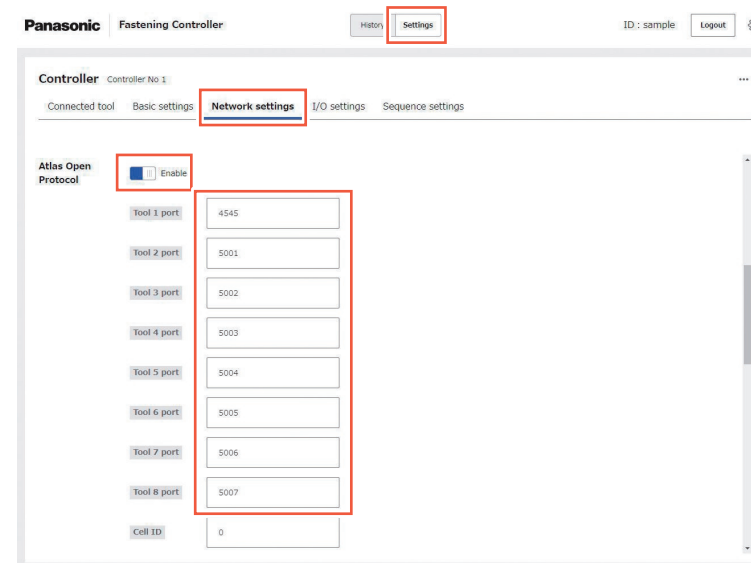

Tool port

Assign a port number for Open Protocol communication to each tool.

[Default] Tool 1 - 4545,

Tool 2 to 8 - 5001 to 5007

[Setting range] Tool 1 to 8 - 1024 to 49151

Other Settings

Set other items as necessary.

Cell ID

Set the cell ID.

[Default] 0

[Setting range] 0 to 9999

Channel ID

Set the channel ID.

[Default] 0

[Setting range] 0 to 99

ACK timeout

Set the time length to wait for a response to a request message from the controller.

[Default] 3000 ms

[Setting range] 100 ms to 30000 ms

Retries

Set the number of times to repeat sending a request message from the controller.

[Default] 0 times

[Setting range] Not selectable (Fixed)

Keep alive timeout

Set the time length to determine occurrence of disconnection after the last communication with a host system.

[Default] 15 s

[Setting range] 1 s to 60 s

Mode

Set the running mode.

Mode 1: Unconditional fastening with pre-registered parameters

Mode 2: Fastening with parameters ordered by a host system

[Default] Mode 1

[Setting range] Mode 1 / Mode 2

Assigning Fastening Parameters (Mode 1)

“Mode 1” (without parameters ordered) requires fastening parameters pre-registered to tools.

Select a parameter from the pull-down menu as below.

Assigning Fastening Parameters (Mode 2)

Fastening can be ordered with a MID 0018 command by an external device. You can specify “Parameter” or “Batch” in a fastening order.

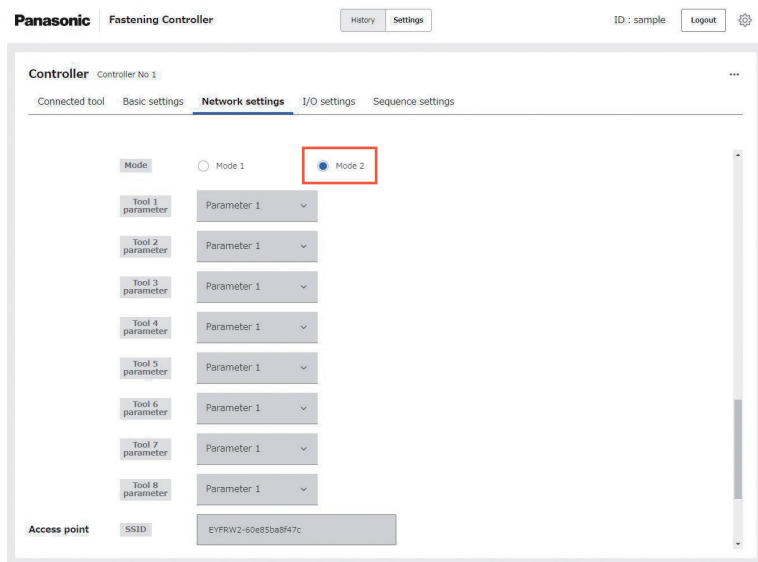

To specify “Parameter” in a fastening order

Put “0” in the hundreds digit of ID.

The tens and ones digits show a parameter number.

Example: Parameter 1’s ID: 001
Parameter 5’s ID: 005

To specify “Batch” in a fastening order

Put “1” in the hundreds digit of ID.

The tens and ones digits show a batch number.

Example: Batch 1’s ID: 101
Batch 5’s ID: 105

* “Job” and “Sequence” are not supported.

Commands compatible with Open Protocol

The controller supports the following commands.

For details of commands, see the Open Protocol Specification.

MID 0001 Application communication start Revision 1 is supported. [Content] Communication start
MID 0002 Application communication start acknowledge Revision 1 is supported. [Content] Communication acknowledgement
MID 0004 Application command error Revision 1 is supported. [Content] Command error
MID 0005 Application command accepted Revision 1 is supported. [Content] Command acceptance
MID 0018 Select parameter set, Dynamic Job included Revision 1 is supported. For how to assign, see “Assigning Fastening Parameters (Mode 2)”. Refer to P60 [Content] Parameter set order
MID 0042 Disable tool Revision 1 is supported. [Content] Tool disabled
MID 0043 Enable tool Revision 1 is supported. [Content] Tool enabled
MID 0050 Vehicle ID number download request Revision 1 is supported. [Content] Vehicle ID acquisition request

MID 0060 Last tightening result data subscribe

Revision 1 and 2 are supported.
[Content] Final fastening result data registration

MID 0061 Last tightening result data

Revision 1 and 2 are supported.
[Content] Fastening result upload

MID 0062 Last tightening result data acknowledge

Revision 1 and 2 are supported.
[Content] Fastening result upload acknowledgement

MID 9999 Keep alive message

Revision 1 is supported.
[Content] Availability check

Setup

The controller can connect to tools via wireless communication using an external access point instead of the built-in access point.

The controller can control tools wherever it is installed.

Connect the access point and the controller to wired LAN.

* The wireless coverage and performance change depending on the access point used.

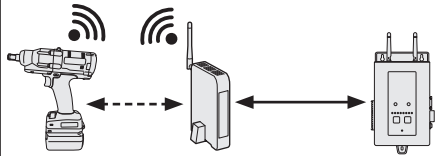
Connection	Communication Method	Note
 <p>Tool unit External access point Panasonic controller</p>	Ethernet	<ul style="list-style-type: none"> In the mode selection, select the internal access point or external access point. Maximum number of connected tools: 8 * For both the internal access point or external access point

Setting Procedure

- In the top page (the initial page of the setting screen), click [Settings] on the top, select the “Basic settings” tab, and set “External access point” to “ON”.

* “WLAN mode” is disabled when “External access point” is enabled.

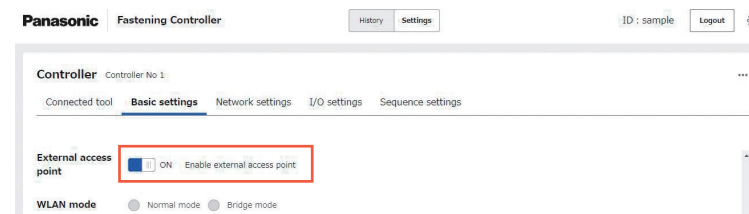

- In the top page (the initial page of the setting screen), click [Settings] on the top and select the “Network settings” tab. In “External access point”, set “SSID”, “Security”, and “Password”.

* You can register only one SSID in the controller. (You cannot register different SSIDs for different tools)

* See the Operating Instructions of your external access point.

* Make this setting before starting pairing registration with tools.

* Set the tool's IP address before starting pairing registration.

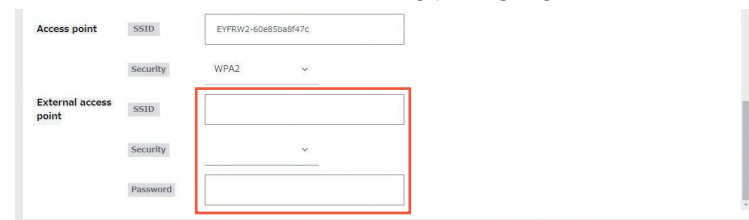

INDICATOR LAMPS AND BUZZER

Indicator Lamps and a Buzzer

The indicator lamps and buzzer show the controller's status.

CAUTION

Do not turn off the power switch while the lamp is blinking startup. Initialization may be required.

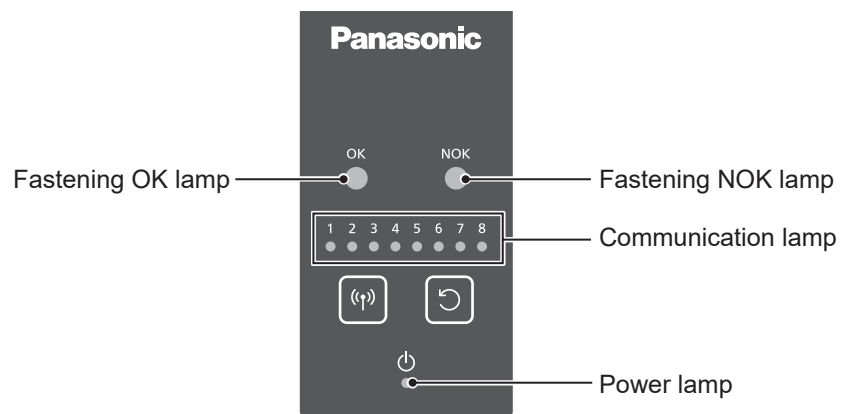

Status	Indicator Lamp	Buzzer
Power on	Power lamp (yellow) Stays lit	—
A tool to pair selected	Communication lamp (blue) Blinks slowly	—
Pairing established	Communication lamp (blue) Blinks rapidly	—
Pairing completed	Communication lamp (blue) Stays lit	A short beep ■
Pairing not established	Communication lamp (blue) Blinks very slowly	—
Pairing disconnected	Communication lamp (blue) Off	—
Fastening completion	OK lamp (green) Stays lit	A short beep ■
Fastening failure	NOK lamp (red) Stays lit	A long beep ■■
Batch/job completion	OK lamp (green) Blinks twice	Two short beeps ■■
Sequence complete	OK lamp (green) Blinks three times	Three short beeps ■■■
Error	Power lamp (yellow) Blinks	Two long beeps ■■

Buzzer Setting

In the top page (the initial page of the setting screen), click [Settings] on the top and select the "Basic settings" tab.

In "Buzzer", set "Volume" and "Beep".

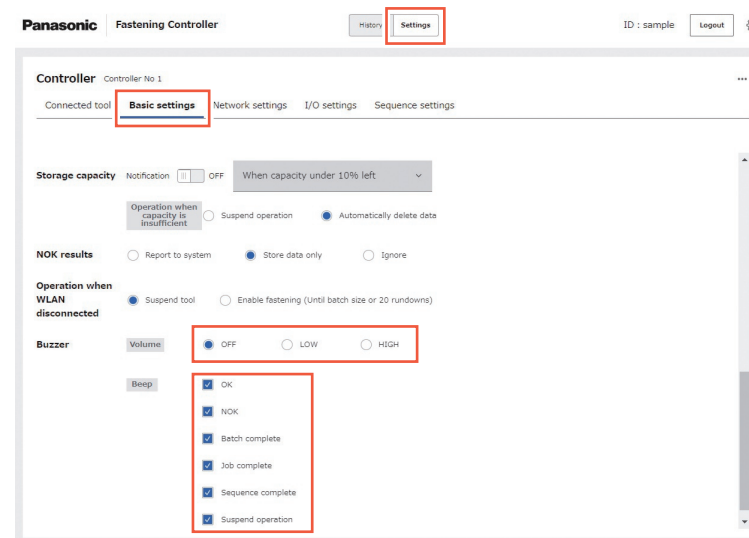

Item	Description
Volume	3 levels (OFF/LOW/HIGH) (LOW: 75 dB, HIGH: 85 dB)
Beep	Selected on the PC for configuration (OK / NOK / Batch complete / Job complete / Sequence complete / Suspend operation)

SETTING THE OPERATION KEYS

In the top page (the initial page of the setting screen), click [Settings] on the top and select the “Basic settings” tab.
In “Pairing key” and “Reset key”, you can disable the Pairing key and Reset key on the control panel.

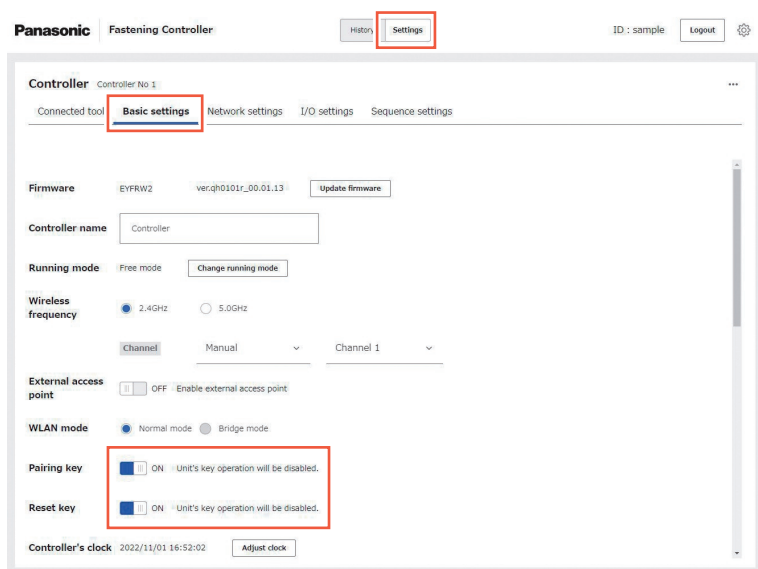

Pairing key

Enable or disable the Pairing key on the control panel.
[Default] ON
[Setting range] ON (enabled) / OFF (disabled)

Reset key

Enable or disable the Reset key on the control panel.
[Default] ON
[Setting range] ON (enabled) / OFF (disabled)

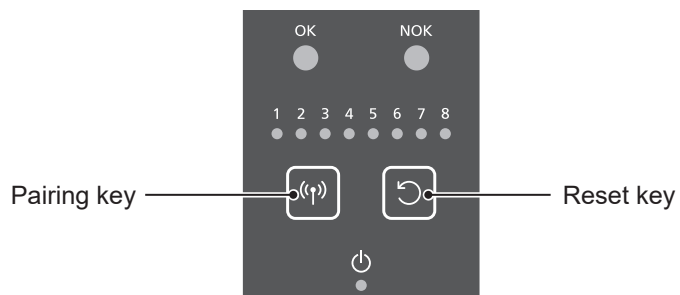

CHECKING THE INFORMATION OF CONNECTED TOOLS

In the top page (the initial page of the setting screen), click [Settings] on the top and select the “Connected tool” tab.
You can see the information and status of the tools connected to the controller.

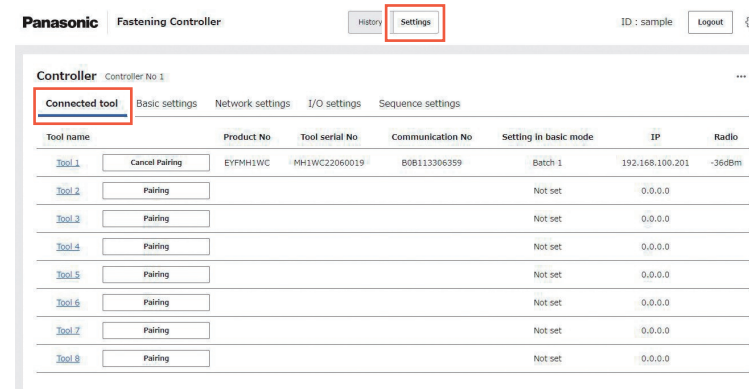

Below are the displayed items.

Tool name

The registered tool number (1 to 8) is displayed.

Tool serial No

You can set and display the tool's unit identification.
Default: 5-digit model ID + 8-digit serial number (2-digit manufacturing year + 2-digit month + 4-digit production lot)

Product No

The tool product number is displayed.

Communication No

Unit identification (MAC address) of the tool's communication part is displayed.

Setting in basic mode

A behaviour when the Running mode is set to “Repeat mode (Basic mode)” is displayed.

IP

The IP address of the tool is displayed.

Radio

Strength of a radio signal (RSSI) received from the tool is displayed.
* Strength at the last communication is displayed.
* It cannot be measured and “0dBm” appears when an external access point is used.

WORK MONITOR

In the top page (the initial page of the setting screen), click [History] on the top and select the “Work monitor” tab.

The latest fastening history logs by tool are displayed. You can use them to work by referring to the work results.

- * More than one PCs for configuration can display them at the same time. (Up to 8 accesses. Multiple accesses from the same account are accepted.)
- * To log in with more than one account, using different PCs is recommended.
- * To use more than one account on the same PC, using different web browsers is recommended.
- * Only one access to the configuration function is accepted at a time.

Switching the View Format

You can select between “List view” and “Grid view”. Use the view icon on the upper right of the screen.

List view

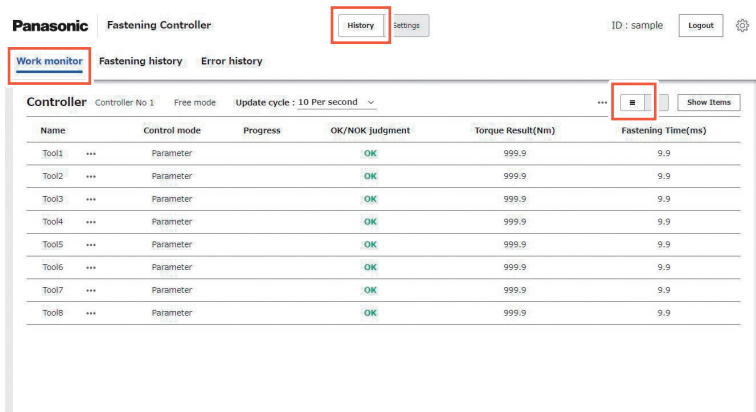

Grid view

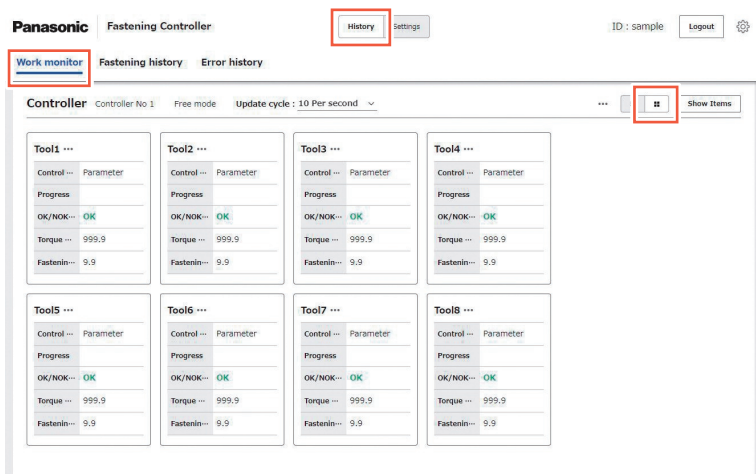

Selecting Items to Show

Select items to show using “Show Items”.

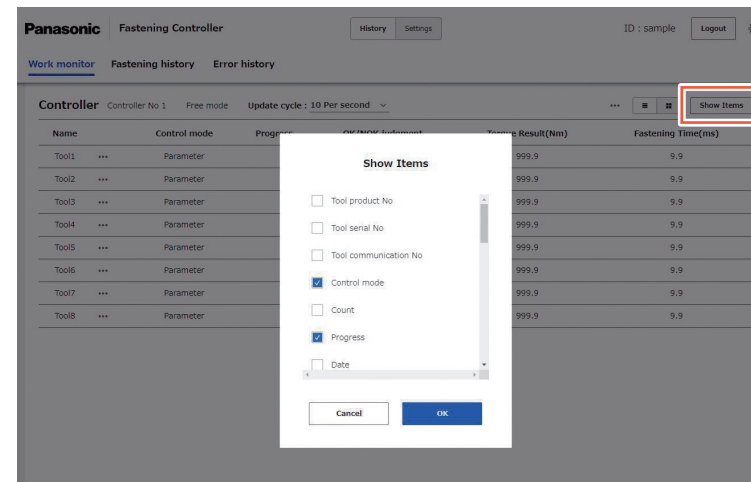

* In “List view”, you can scroll down and select many items to show.

* In “Grid view”, you can show up to 5 items.

Selecting the Display Update Cycle

You can set automatic display update.

Select the update cycle from “2 Per second”, “5 Per second”, and “10 Per second” as below.

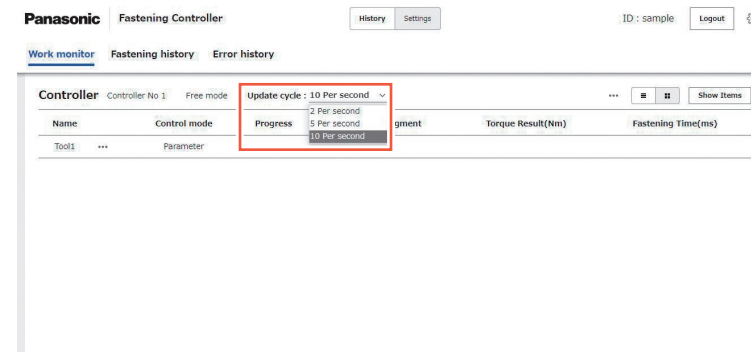

* If a large number of tools or PCs for configuration are connected, the update cycle of “10 Per second” is recommended. (It may take some time to process data.)

TOOLS' BEHAVIOUR WITH WIRELESS COMMUNICATION DISCONNECTED

You can continue the fastening with the same parameters in case of temporary disruption of wireless communication between a tool and the controller.

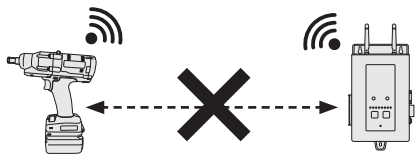

In the top page (the initial page of the setting screen), click [Settings] on the top and select the "Basic settings" tab.

If you set "Operation when WLAN disconnected" to "Suspend tool", the ongoing fastening is completed after disruption but no further fastening is conducted.

If you set "Enable fastening", no further fastening is conducted after the fastened quantity has reached the upper limit.

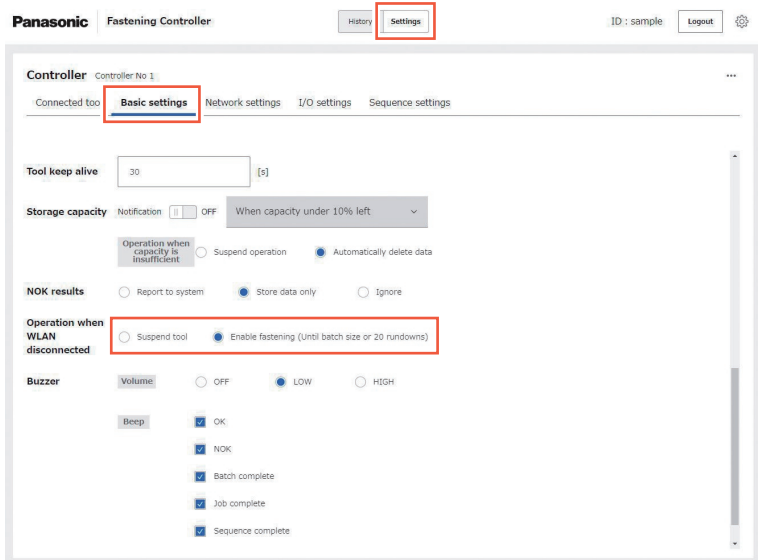

With "Enable fastening", the upper limit quantities by mode are as below.

Mode		Behaviour
Free mode		Continues fastening up to 20 screws
Repeat mode	Basic mode	Continues fastening up to the end of the batch or up to 20 screws
	Sequence mode	Continues fastening up to the end of the batch or up to 20 screws * Tools other than the one concerned continue to run normally.
External control mode		Continues fastening up to the end of the batch or up to 20 screws

RESETTING THE COUNT DURING OPERATION

To change settings, stop fastening control by the controller if it is ongoing. A confirmation dialogue appears when you apply the change.

You can reset the counted quantities by "Using the key on the unit" or "Setting in the setting screen".

* This does not apply to "Free mode".

Using the key on the unit

Hold down the Reset key on the controller 3 seconds or more.

* The quantities of all active tools are reset.

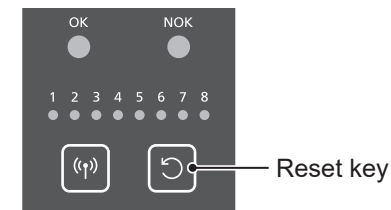

Setting in the setting screen

In the top page (the initial page of the setting screen), click [History] on the top and select the "Work monitor" tab.

To reset the quantities by tool

In the "Work monitor" screen, click ... (tool option key) and then [Batch reset] of the desired tool number.

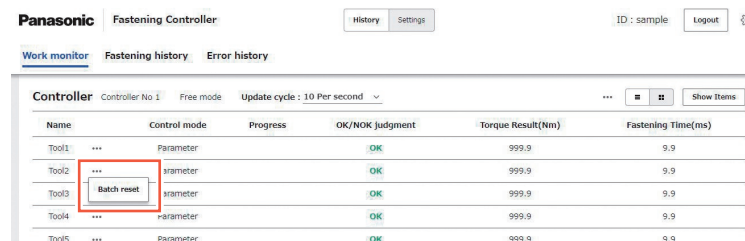

To reset the quantities of all tools collectively

In the "Work monitor" screen, click ... (controller option key) and then [Reset] on the upper right.

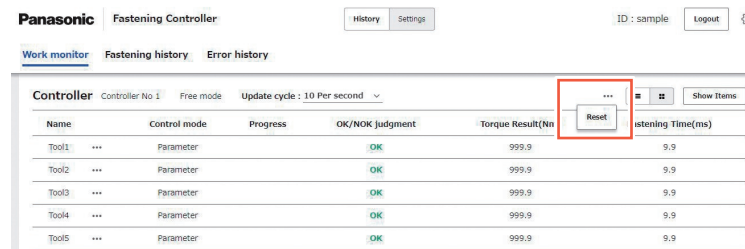

* In the Sequence mode, the quantities are reset up to the first tool.

CHECKING THE FASTENING HISTORY DATA

Displaying the Fastening History Data

In the top page (the initial page of the setting screen), click [History] on the top and select the “Fastening history” tab.

You can view the fastening history data sent from tools to the controller.

To display the data, select the desired controller and tools from the tool list on the left and click [Get data] on the upper right.

The fastening history logs are displayed from newest to oldest.

* For the content of fastening history items, see the tool’s Operating Instructions.

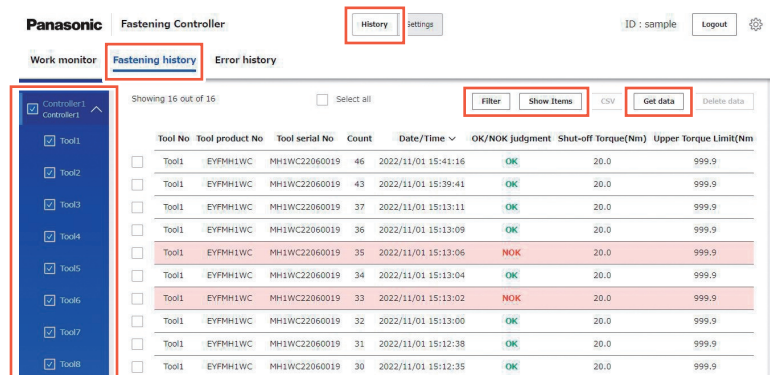

Tool list

Extracting the fastening history logs by time period

Click [Filter] and specify the time period to narrow down the fastening history logs to display.

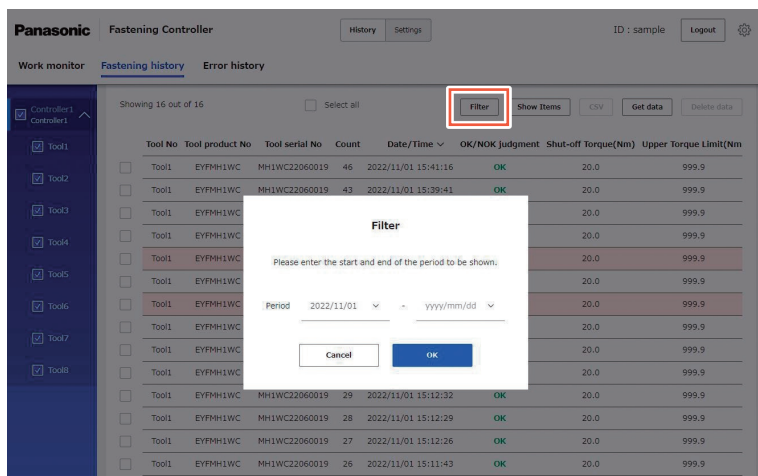

Setting Items to Display

To change the displayed items, click [Show Items] and select the desired items.

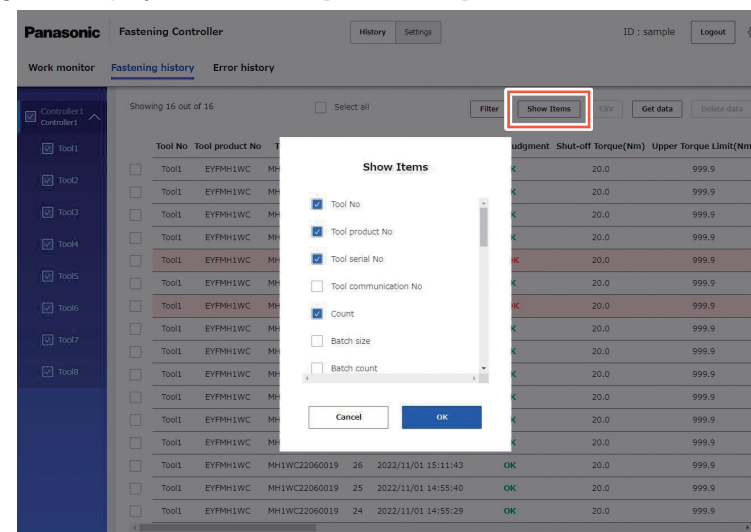

Capacity for Fastening History Data

The controller can store a maximum of about 200,000 fastening history logs (including waveform data).

It suspends operation or automatically deletes the logs (by overwriting) if it receives more logs.

It is recommended that you periodically export the logs in the CSV format as necessary by referring to the guide below.

Estimated time to reach full storage capacity

Number of Tools	Quantity per Day per Tool		
	1,000	3,000	5,000
2	About 100 days	About 33 days	About 20 days
4	About 50 days	About 16 days	About 10 days
8	About 25 days	About 8 days	About 5 days

Exporting the Fastening History Data in the CSV Format

In the top page (the initial page of the setting screen), click [History] on the top and select the “Fastening history” tab. Select the desired logs and click [CSV]. The fastening history logs are exported in the CSV format.

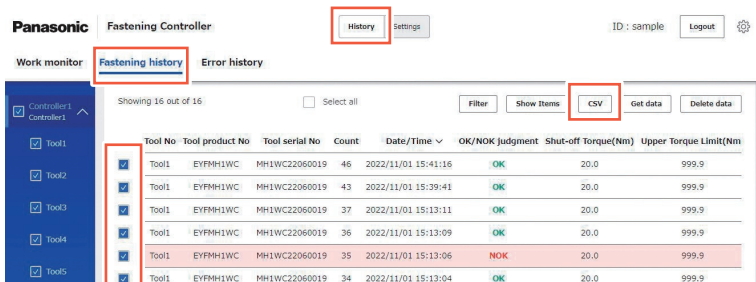

You can select between “Decimal point is a period, delimiter is a comma” and “Decimal point is a comma, delimiter is a semicolon”.

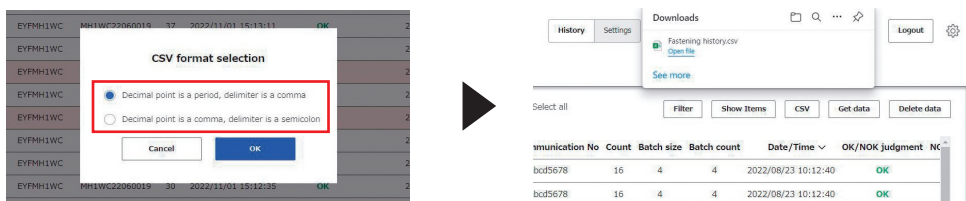

Deleting the Fastening History Data

In the top page (the initial page of the setting screen), click [History] on the top and select the “Fastening history” tab. Select the desired logs and click [Delete data]. The fastening history logs are deleted.

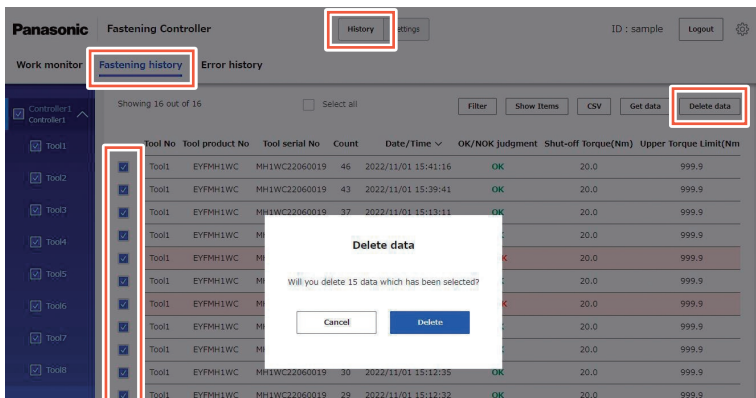

Displaying the Waveform Data

In the top page (the initial page of the setting screen), click [History] on the top and select the “Fastening history” tab. If you have enabled to save waveform data, you can double-click on the row of the desired fastening history log to display a waveform data popup window.

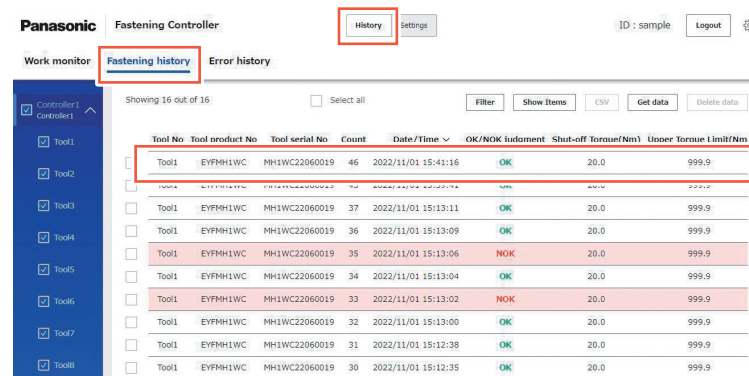

You can adjust the display by selecting “X-axis”, “Y-axis”, and “Scale”. Clicking [Output] exports the data in the CSV format.

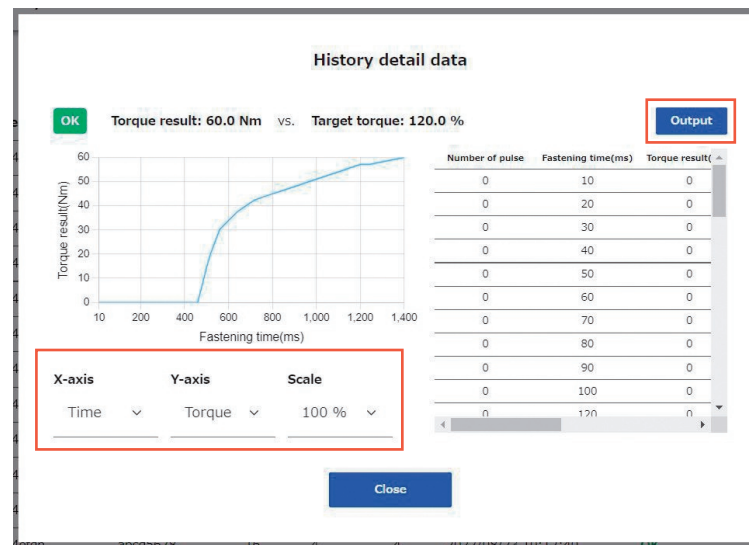

* Please set “Graph sending timing” in “Device settings” to “After every fastening”.

Displaying the Error History

In the top page (the initial page of the setting screen), click [History] on the top and select the “Error history” tab.

The history of errors that occurred is displayed.

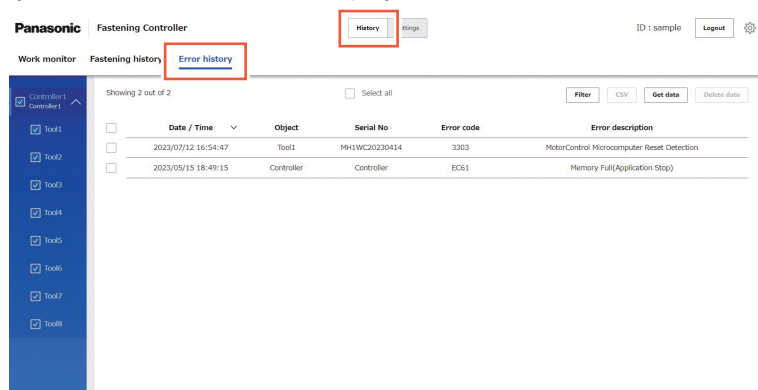

Below are the displayed items.

* For the error content, see “ERROR CODE”. Refer to P90

Date / Time
The date and time of error occurrence are displayed.
Object
The device (the controller or any of Tool 1 to 8) causing an error is displayed.
Serial No
The serial number of the device (the controller or any of Tool 1 to 8) causing an error is displayed.
Error code
An error code that occurred is displayed.
Error description
Content of an error that occurred is displayed.

Changing the Language

You can select “Japanese” or “English”.

- 1 In the top page (the initial page of the setting screen), click the option key on the upper right and select “System Settings”. The “System settings” screen is displayed.

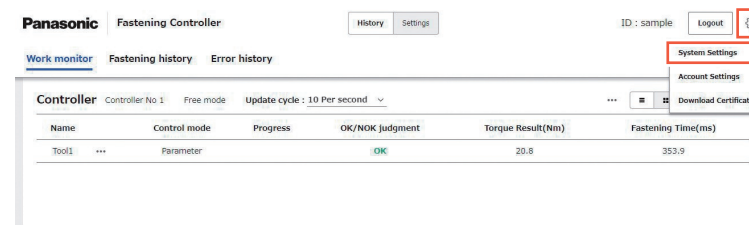

- 2 Select the language in the “System settings” screen. You can select “Japanese” or “English”.

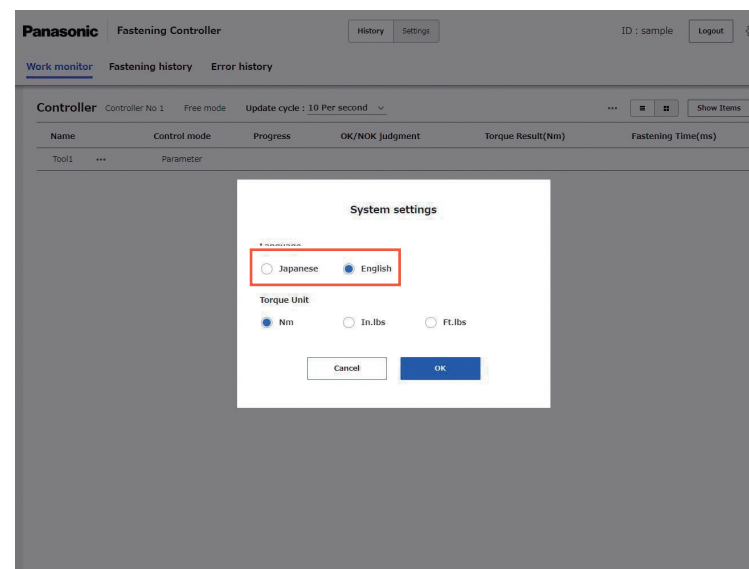

Changing the Torque Unit to Display

You can select “Nm”, “In.lbs”, or “Ft.lbs”.

- 1 In the top page (the initial page of the setting screen), click the option key on the upper right and select “System Settings”.**
The “System settings” screen is displayed.

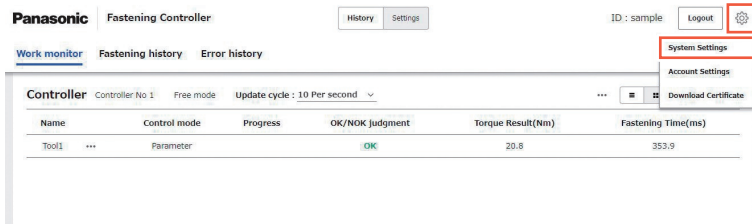

- 2 Select the torque unit in the “System settings” screen.**
You can select the torque unit from “Nm”, “In.lbs”, and “Ft.lbs”.

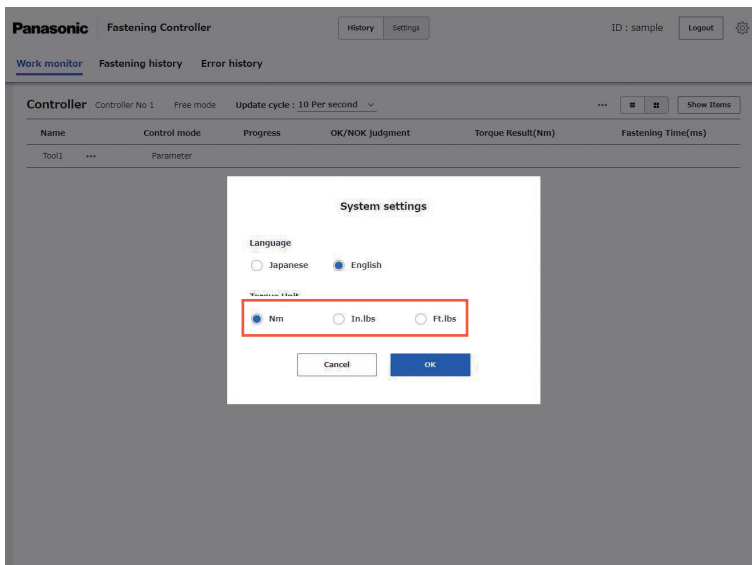

How to Clean

Wiping with Soft Cloth

Do not use wet cloth, thinner, alcohol, benzene, or other volatile liquids.
(Cause of discoloration, deformation, or crack)

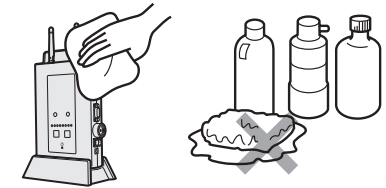

How to Store

Avoid the following conditions during storage.

- Car cabin or other hot places
- Places exposed to direct sunlight
- Places exposed to water or dampness
- Places with a lot of foreign bodies or dust
- Places within reach of children
- Places with gasoline or other flammables
- Places with risk of fall

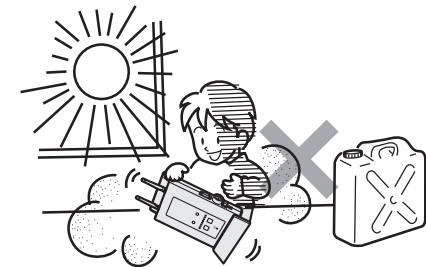

Initialising the Controller

To initialise (factory-reset) the controller, hold down the Pairing key and Reset key together 10 seconds or more.

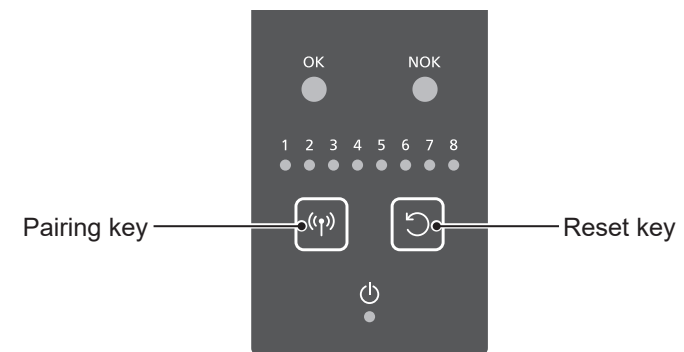

* It may take more than 5 minutes depending on the storage usage.

* You cannot conduct it when the keys on the unit are disabled. **Refer to P66**

Making a Backup of the Settings

In the top page (the initial page of the setting screen), click [Settings] on the top. Click ... (controller option key) and then [Backup controller data].

You can back up the settings of the controller and tools.

* The fastening history data are not backed up. Export them in the CSV format as necessary.

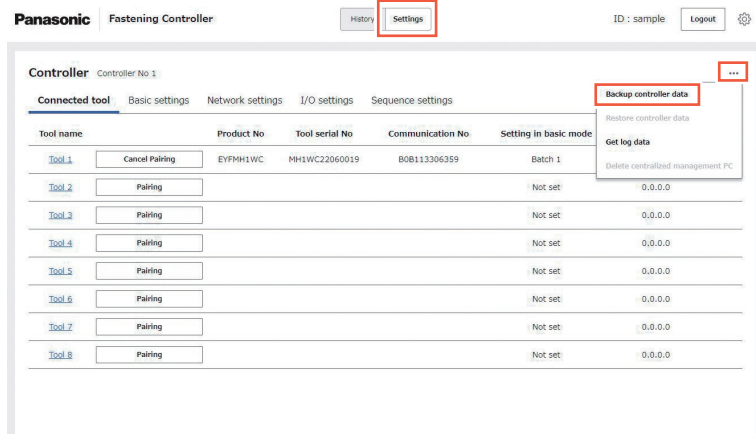

Restoring the Settings

In the top page (the initial page of the setting screen), click [Settings] on the top. Click ... (controller option key) and then [Restore controller data].

You can restore the settings of the controller and tools from their backup.

* You cannot conduct it during fastening control.

* You cannot conduct it when pairing with tools is registered. Cancel the pairing.

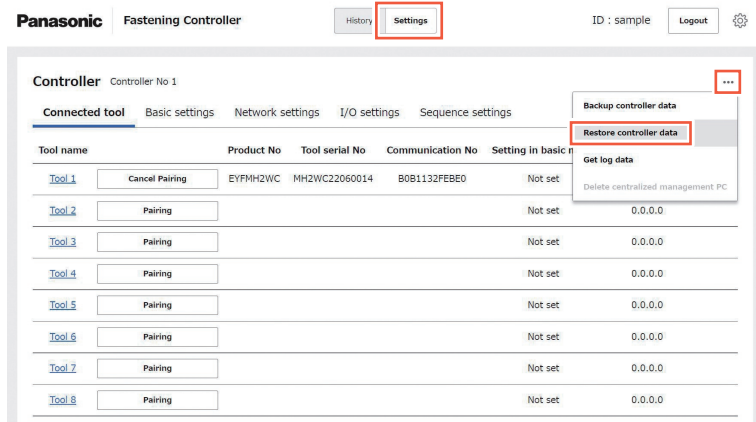

Updating the Firmware

You can update the firmware of the controller and the tool's communication part.

Use either of the following to update the firmware.

- Using the USB port of the controller.
 - A USB flash drive with a password lock cannot be used.
 - Save only one firmware data file directly in a USB flash drive without creating a folder.
- Writing from the PC for configuration.
 - When selecting "Upload file", select the firmware data file saved on the PC in the selection screen.

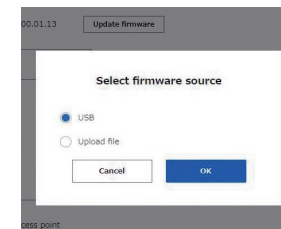

For the current firmware version, access our web site. **Refer to P2**
Or contact our sales person.

For the controller

In the top page (the initial page of the setting screen), click [Settings] on the top, select the "Basic settings" tab, and click [Update firmware].

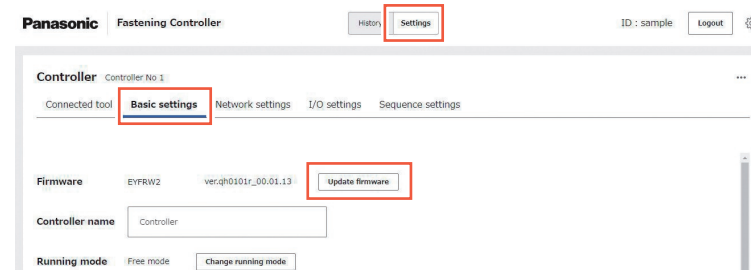

For the tool's communication part

In the top page (the initial page of the setting screen), click [Settings] on the top and select the "Connected tool" tab.

In the "Connected tool" screen, click the desired tool number.

From the "Device settings" tab in the screen for the tool number, click [Update firmware].

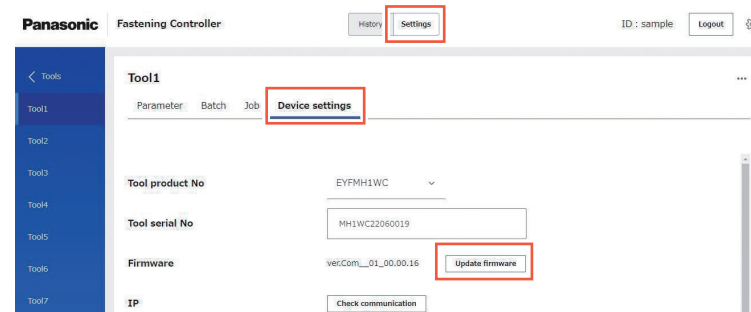

Replacing the Coin Cell Battery

To keep the clock (RTC) of the controller running, replace the coin cell battery by referring to the replacement guide below.

Battery type



CR2450

Replacement guide

The coin cell battery is used to keep the clock running when the controller is off. To minimise its consumption, in principle, do not turn the controlled off.

Power is on 12 hours per day (business days only)	Power is always on
About 3 years	About 8 years

Replace it with the following procedure or contact your dealer. It is recommended that a person who has electrical knowledge should do the work.

- Remove the 2 compartment cover fixing screws and then remove the compartment cover.**

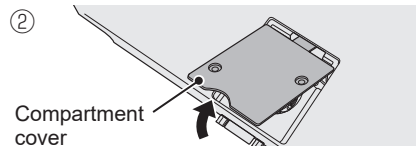
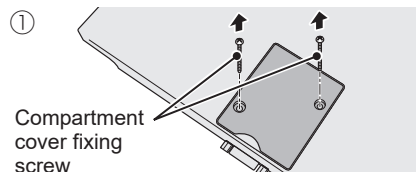

- Using the compartment cover, take out the coin cell battery.**

Pick up the coin cell battery with the hook of the compartment cover.

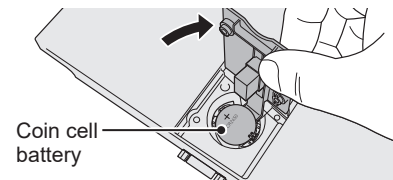

- Put a new coin cell battery and attach the compartment cover with the 2 compartment cover fixing screws.**

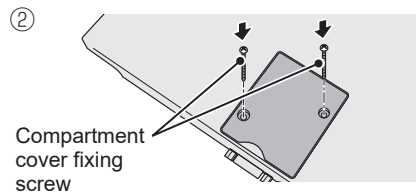
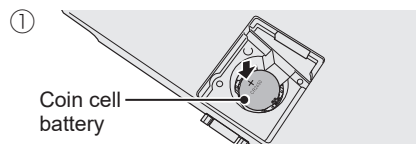

Controller Specifications

Receiving fastening completion and failure signals during indoor product assembly work

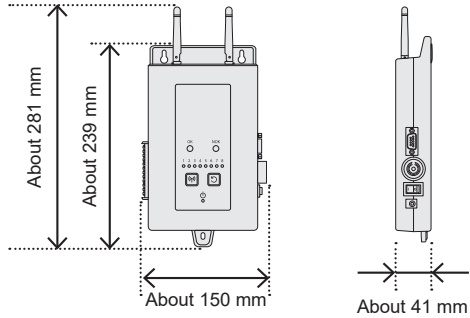
Model No.	EYFRW2
Power Supply	100 V-240 V AC, 50/60 Hz
Wireless Communication Standard	Wireless LAN (IEEE.802.11 a/b/g/n) n: HT20 only
Frequency Band	2.4 GHz: 2.412 GHz to 2.472 GHz 5 GHz: 5.180 GHz to 5.240 GHz [For China, Korea only] 2.4 GHz: 2.412 GHz to 2.462 GHz 5 GHz: 5.180 GHz to 5.240 GHz
Channel	2.4 GHz: 1 to 13 channels 5 GHz: 36, 40, 44, 48 channels [For China, Korea only] 2.4 GHz: 1 to 11 channels 5 GHz: 36, 40, 44, 48 channels
Coverage	2.4 GHz: About 16 m 5 GHz: About 10 m
Number of Tools That Can Be Registered	8 (maximum)
Input/output (I/O) Terminals	8 inputs and 8 outputs
Input Terminal Rating	24 V DC, 50 mA
Output Terminal Rating	30 V DC, 3 A
Power Consumption	About 30 W
Operating Temperature and Humidity Ranges	0 °C to 45 °C, 20% to 90%
Size (Estimated Dimensions) Total Length × Total Height × Width	About 150 × 239 × 41 mm (height including antennas: 281 mm) 
Mass (Weight)	About 550 g (main unit only)
Communication interface	Ethernet × 2, RS232C × 1, USB-A × 1
Number of Data That Can Be Stored	About 200,000 fastening history logs (including waveform data)
Compatible Tool Models	EYFMH1WC, EYFMH2WC

Wireless Specifications

Frequencies by channel

Frequency Band	Channel	Frequency
2.4 GHz	Channel 1	2.412 GHz
	Channel 2	2.417 GHz
	Channel 3	2.422 GHz
	Channel 4	2.427 GHz
	Channel 5	2.432 GHz
	Channel 6	2.437 GHz
	Channel 7	2.442 GHz
	Channel 8	2.447 GHz
	Channel 9	2.452 GHz
	Channel 10	2.457 GHz
	Channel 11	2.462 GHz
	Channel 12	2.467 GHz
	Channel 13	2.472 GHz
5 GHz	Channel 36	5.180 GHz
	Channel 40	5.200 GHz
	Channel 44	5.220 GHz
	Channel 48	5.240 GHz

• Channels 12 and 13 are not available in China and Korea.

WebUI Specifications

Compatible OS	Windows 10 or later (supporting any of the web browsers below)
Supported Web Browser	Microsoft Edge version 102 or later or Google Chrome version 102 or later
Supported language	English, Japanese
Recommended screen resolution	1024 × 768 or more

CAUTION

- Some PCs are not available even if they meet the operating environment.
- Depending on the use environment etc. of your PC, the descriptions and screens in this Operating Instructions might be different from the actual descriptions and screens.
Please be forewarned.
- The contents of this Operating Instructions are subject to change without prior notice.
- Any reproduction of the contents of this Operating Instructions in whole or in part is prohibited without permission.
- Descriptions on how to operate Windows in this Operating Instructions use the procedures and screens of Windows 10.
- WebUI does not work on OS other than the compatible OS.
- Operation is not guaranteed for all the PCs meeting the recommended environment.

■ Terms of use (Read before use)

<Limitations>

WebUI is configuration software for EYFRW2.

CAUTION

- Observe the following when using the feature.
You are deemed to agree the following terms of use by using the feature.

[Use conditions]

Panasonic makes no warranty of any kind regarding the feature.
Panasonic bears no responsibility for any damage including but not limited to direct loss, indirect loss, spreading loss, consequential loss, and special loss caused by use or operation of the feature.
Unauthorised reproduction and distribution of the feature is prohibited.

Contact I/O Specifications

Assignment between output relay terminals and input terminals

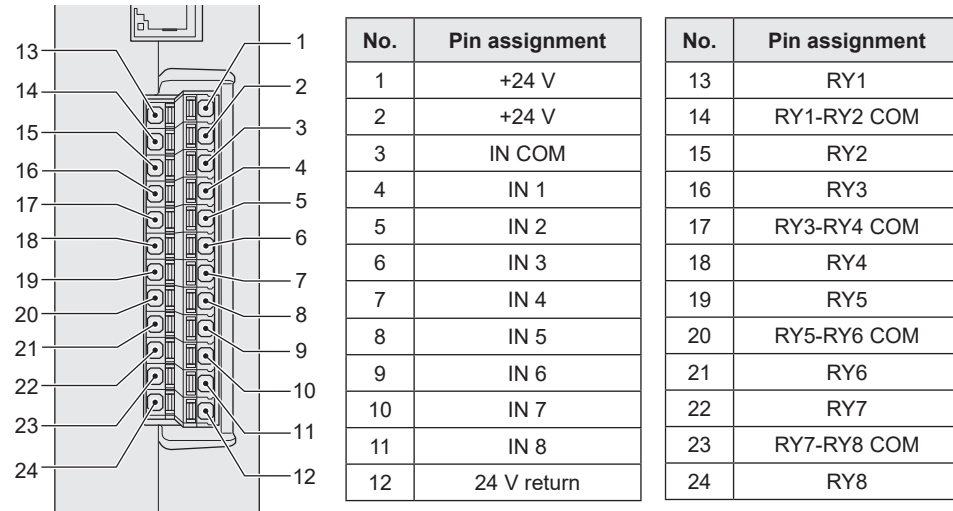

Terminal block connection diagram

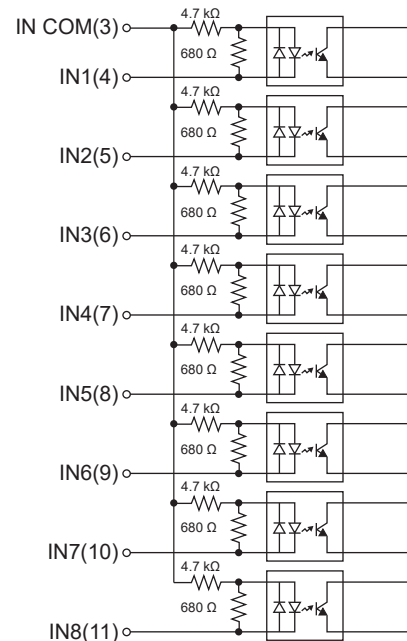
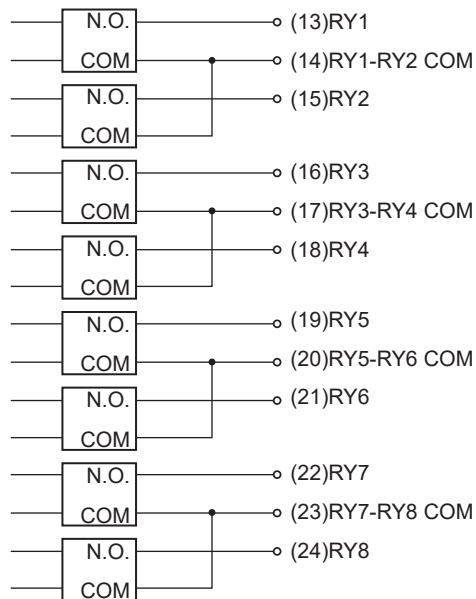

PRECAUTIONS FOR WIRELESS COMMUNICATION

Cautions for using a WLAN device

The device uses a frequency band shared with other types of equipment including industrial, scientific, and medical devices (e.g., a microwave) and radio stations such as a premises radio station (licenced) and low-power radio station (unlicenced) for mobile identification used in factory manufacturing lines and an amateur radio station (licenced).

1. Before using the device, confirm that there is no premises or low-power radio station for mobile identification or no amateur radio station operating in the vicinity.
2. If the device causes harmful interference with a premises radio station for mobile identification, stop use of the band immediately and consult the support centre below for the solution of the interference problem (e.g., installing a partition).
3. If the device causes harmful interference with a premises or low-power radio station for mobile identification or an amateur radio station or such other problems, consult the support centre.

■ **There may be noise, shorter radio coverage, or malfunction occurring in the following environmental conditions.**

- There is an obstruction (e.g., a metal or reinforced concrete object) that prevents smooth radio propagation between the wireless-enabled tool unit and the controller.
- The antennas of the controller are covered with metal.
- An operator's body is interfering with radio propagation between an operator (the wireless-enabled tool unit) and the controller.
- There is a microwave, PC, or any other device causing noise in the vicinity.
- A cell-phone or PHS phone is used near the wireless-enabled tool unit and the controller.

Software Licence Terms

This product incorporates the following software:

- (1) the software developed independently by or for Panasonic Corporation,
- (2) the software owned by third party and licenced to Panasonic Corporation,
- (3) the software licenced under the GNU General Public License, Version 1.0 (GPL V1.0),
- (4) the software licenced under the GNU General Public License, Version 2.0 (GPL V2.0),
- (5) the software licenced under the GNU General Public License, Version 3.0 (GPL V3.0),
- (6) the software licenced under the GNU LESSER General Public License, Version 2.1 (LGPL V2.1),
- (7) the software licenced under the GNU LESSER General Public License, Version 3.1 (LGPL V3.1),
- (8) the software licenced under the SMAIL General Public License(SMAIL),
- (9) the software licenced under the Mozilla Public License Version 1.1 (MPL V1.1),
- (10) the software licenced under the Mozilla Public License Version 2.0 (MPL V2.0), and/or
- (11) open source software other than the software licenced under the GPL V1.0, GPL V2.0, GPL V3.0, LGPL V2.1, LGPL V3.1, SMAIL, MPL V1.1 and/or MPL V2.0.

The software categorized as (3) - (11) are distributed in the hope that it will be useful, but WITHOUT ANY WARRANTY, without even the implied warranty of MERCHANTABILITY or FITNESS FOR A PARTICULAR PURPOSE.

For details on the copyright holders and licences, see from page 95 onwards.

At least 3 years from delivery of this product, Panasonic will give to any third party who contacts us at the contact information provided below, for a charge no more than our cost of physically performing source code distribution, a complete machine-readable copy of the corresponding source code covered under GPL V1.0, GPL V2.0, GPL V3.0, LGPL V2.1, LGPL V3.1, SMAIL or the other licences with the obligation to do so, as well as the respective copyright notice thereof.

Contact Information: oss-cd-powertools-gl@ml.jp.panasonic.com

ERROR CODE

Device	Error Code	Type	Category	Event	Action
Controller	0xEF21	Warning	Hardware failure	Secondary CPU error (failure)	Restart the controller. If the problem persists, the device may be broken. Contact your dealer.
	0xEF51	Warning	Hardware failure	Ether0 error	The device may be broken. Contact your dealer.
	0xEF52	Warning	Hardware failure	Ether1 error	The device may be broken. Contact your dealer.
	0xEF61	Warning	Hardware failure	Wi-Fi module error (failure)	Restart the controller. If the problem persists, the device may be broken. Contact your dealer.
	0xCE42	Error	Software failure	Setting content error	Factory-reset the controller and make settings again.
	0xCE43	Error	Software failure	Retraction information error	Hold down the reset key on the controller 3 seconds or more.
	0xEC61	Warning	Software failure	Capacity to store the fastening history is full (operation suspended)	Delete the fastening history logs in the fastening history screen to free up some capacity. Export them before deleting as necessary.
Tool	0x4301	Caution	Software failure	Storage capacity is full	Access the tool setting software (Tool Manager software) and delete the work history logs.
	0x4302	Caution	Software failure	The number of sent results in a queue has reached the upper limit.	The tool cannot communicate with the controller. Change the workplace. If the problem persists, the device may be broken. Contact your dealer.
	0x3303	Error	Software failure	Motor control microcontroller reset detected	An error that occurred has been solved.
	0x3304	Error	Software failure	Torque calculation microcontroller reset detected	An error that occurred has been solved.

Device	Error Code	Type	Category	Event	Action
Tool	0x4305	Caution	Software failure	Low RTC battery	Replace the coin cell battery inside the tool unit.
	0x4306	Caution	Software failure	Firmware update error	Confirm that the firmware file is correct.
	0x4315	Caution	Software failure	USB communication error	An error that occurred has been solved.
	0x4316	Caution	Software failure	Wi-Fi module restarted	An error that occurred has been solved.
	0x1401	Warning	Hardware failure	Wi-Fi module error	An error that occurred has been solved.
	0x1402	Warning	Hardware failure	Motor control microcontroller error	An error that occurred has been solved.
	0x1403	Warning	Hardware failure	Torque calculation microcontroller error	An error that occurred has been solved.
	0x1404	Warning	Hardware failure	External flash drive error	An error that occurred has been solved.
	0x1405	Warning	Hardware failure	RTC error	An error that occurred has been solved.
	0x1406	Warning	Hardware failure	Circuit identification error	An error that occurred has been solved.
	0x1407	Warning	Hardware failure	No remaining swap space	An error that occurred has been solved.
	0x1408	Warning	Hardware failure	Damaged parameter space	An error that occurred has been solved.

OPERATION LOG DATA

In the top page (the initial page of the setting screen), click [Settings] on the top. Click ... (controller option key) and then [Get log data]. You can get the operation logs of the controller.

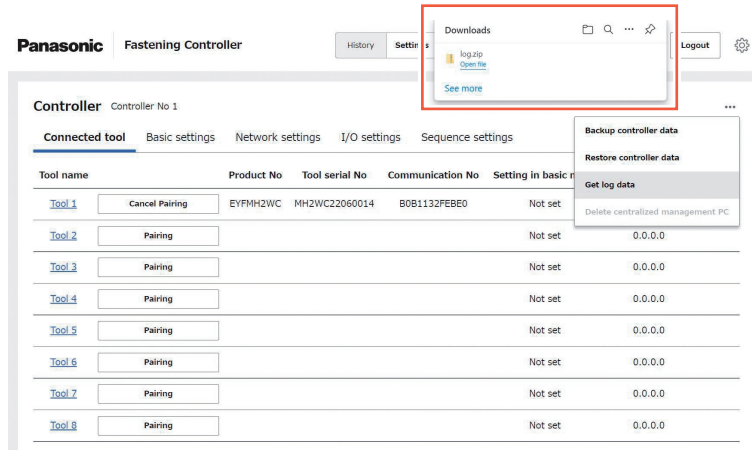
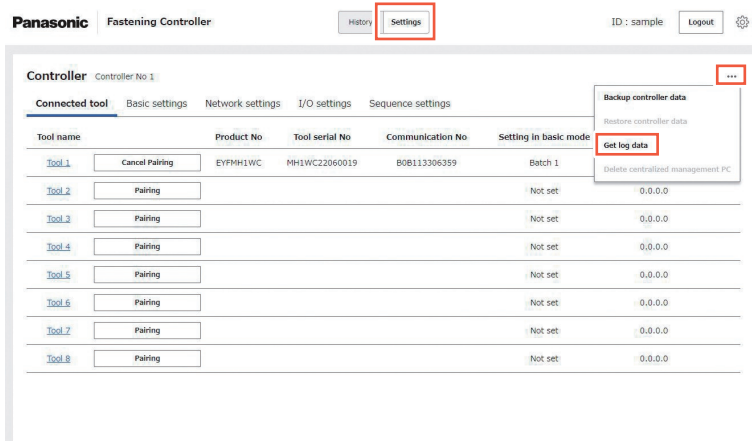

• Copyright holders' information

Copyright (C) 1994-2018 Free Software Foundation, Inc.
Copyright (c) 2007 by Jaroslav Kysela <perex@perex.cz>
Copyright (c) 2005 by Jaroslav Kysela <perex@perex.cz>
Copyright (C) 1994 X Consortium
Copyright (C) 1991, 1999 Free Software Foundation, Inc.
Copyright (C) 1996-2015 Free Software Foundation, Inc.
Copyright (C) 1996-2018 Free Software Foundation, Inc.
Copyright (C) 1992-1996, 1998-2012 Free Software Foundation, Inc.
Copyright (C) 2014 Free Software Foundation, Inc.
Copyright (c) 1998 by Frank van de Pol <F.K.W.van.de.Pol@inter.nl.net>
Copyright (c) 2015-2016 Takashi Sakamoto
Copyright (C) 1999-2018 Free Software Foundation, Inc. Written by Tom Tromey <tromey@cygnus.com>.
Copyright (C) 2011 Free Software Foundation, Inc.
Copyright 1992-2019 Free Software Foundation, Inc.
Copyright (C) 1999-2018 Free Software Foundation, Inc.
Copyright (C) 2004-2005, 2007, 2009, 2011-2015 Free Software Foundation, Inc. Written by Scott James Remnant, 2004.
Copyright (C) 2004, 2011-2015 Free Software Foundation, Inc. Written by Scott James Remnant, 2004
Copyright (C) 1996-2001, 2003-2015 Free Software Foundation, Inc. Written by Gordon Matzigkeit, 1996
Copyright (C) 2004-2005, 2007-2008, 2011-2015 Free Software Foundation, Inc. Written by Gary V. Vaughan, 2004
Copyright (C) 2004-2005, 2007-2009, 2011-2015 Free Software Foundation, Inc. Written by Gary V. Vaughan, 2004
Copyright (c) 2006-2007 Diego Pettenò <flameeyes@gmail.com>
Copyright (C) 1989, 1991 Free Software Foundation, Inc.
Copyright (c) by Abramo Bagnara <abramo@alsa-project.org>
Copyright (C) 1996-2018 Free Software Foundation, Inc. Originally written by Fran,cois Pinard <pinard@iro.umontreal.ca>, 1996.
Copyright (c) 2003 by Jaroslav Kysela <perex@perex.cz>
Copyright (c) 2002 by Jaroslav Kysela <perex@perex.cz>
Copyright(c) 2014-2015 Intel Corporation All rights reserved.
Copyright (c) 2000 by Abramo Bagnara <abramo@alsa-project.org>
Copyright (c) 2016 by Thomas Klausner <wiz@NetBSD.org>
Copyright (c) 1999 by Uros Bizjak <uros@kss-loka.si> Takashi Iwai <tiwai@suse.de>
Copyright (c) 1998-1999 by Frank van de Pol <fvdpol@coil.demon.nl>;(c) 1998-1999 by Jaroslav Kysela <perex@perex.cz>
Copyright (c) 1994-2000 by Jaroslav Kysela <perex@perex.cz>
Copyright (c) 1994-2003 by Jaroslav Kysela <perex@perex.cz>, Abramo Bagnara <abramo@alsa-project.org>
Copyright (C) 2003 Thomas Charbonnel (thomas@undata.org)
Copyright (C) 2012 Texas Instruments Inc.
Copyright (C) 2008-2010 SlimLogic Ltd
Copyright (c) by Jaroslav Kysela <perex@perex.cz>, Creative Labs, Inc.
Copyright (c) 1994-98 by Jaroslav Kysela <perex@perex.cz>
Copyright (C) 2003 Winfried Ritsch (IEM) based on hdsp.h from Thomas Charbonnel (thomas@undata.org)
Copyright (c) 2000 by Abramo Bagnara <abramo@alsa-project.org>, Jaroslav Kysela <perex@perex.cz>
Copyright (c) 1998 by Jaroslav Kysela <perex@perex.cz>
Copyright (c) 2003 by Abramo Bagnara <abramo@alsa-project.org>
Copyright (c) 2001 by Jaroslav Kysela <perex@perex.cz>
Copyright (c) 2000 by Jaroslav Kysela <perex@perex.cz>
Copyright (C) 2015 Intel Corporation
Copyright (c) 2015 by Takashi Iwai <tiwai@suse.de>
Copyright (c) 2005 Takashi Iwai <tiwai@suse.de>
Copyright (c) 2006 Takashi Iwai <tiwai@suse.de>
Copyright (C) 1995-1999, 2000 Free Software Foundation, Inc.
Copyright (C) 2011-2018 Free Software Foundation, Inc.
Copyright (c) 2000 by Jaroslav Kysela <perex@perex.cz> Abramo Bagnara <abramo@alsa-project.org>

LICENCE TERMS (cont.)

Copyright (C) 1998,99,2000 Takashi Iwai <tiwai@suse.de>, Jaroslav Kysela <perex@perex.cz>
Copyright (c) 1999 by Takashi Iwai <tiwai@suse.de>
Copyright (c) 2001 by Abramo Bagnara <abramo@alsa-project.org> Jaroslav Kysela <perex@perex.cz>
Copyright (c) 2010 by Jaroslav Kysela <perex@perex.cz>
Copyright (c) 2000 by Jaroslav Kysela <perex@perex.cz>
Copyright (c) 2006 by Jaroslav Kysela <perex@perex.cz>
Copyright (c) 1998,1999,2000 by Jaroslav Kysela <perex@perex.cz>
Copyright (c) 2007 Takashi Iwai <tiwai@suse.de>
Copyright (c) 2001 by Abramo Bagnara <abramo@alsa-project.org>
Copyright (c) 2003 by Takashi Iwai <tiwai@suse.de>
Copyright (c) 2000,2004 by Jaroslav Kysela <perex@perex.cz>
Copyright (c) 1998/1999/2000 by Jaroslav Kysela <perex@perex.cz>
Copyright (c) 2004 by Takashi Iwai <tiwai@suse.de>
Copyright (c) 2005 by Takashi Iwai <tiwai@suse.de>
Copyright (c) 2004 by Jaroslav Kysela <perex@perex.cz>
Copyright (c) 2003 by Jaroslav Kysela <perex@perex.cz> Takashi Iwai <tiwai@suse.de>
Copyright (c) 2007 by Takashi Iwai <tiwai@suse.de>
Copyright (C) 2000-2002 Richard W.E. Furse, Paul Barton-Davis, Stefan Westerfeld.
Copyright (c) 2000 by Abramo Bagnara <abramo@alsa-project.org> 2004 by Jaroslav Kysela <perex@perex.cz>
2006 by Takashi Iwai <tiwai@suse.de>
Copyright (c) 2000 by Abramo Bagnara <abramo@alsa-project.org>
Copyright (c) 2000 by Abramo Bagnara <abramo@alsa-project.org> 2004 by Jaroslav Kysela <perex@perex.cz>
Copyright (c) 1998 by Jaroslav Kysela <perex@perex.cz>
Copyright (c) 2001-2006 by Jaroslav Kysela <perex@perex.cz>
Copyright (c) 1998-2001 by Jaroslav Kysela <perex@perex.cz>
Copyright (C) 2004-2015 Free Software Foundation, Inc.
Copyright (C) 2010-2015 Free Software Foundation, Inc.
Copyright (C) 2002-2018 Free Software Foundation, Inc.
Copyright (C) 2001-2018 Free Software Foundation, Inc.
Copyright (C) 1997-2018 Free Software Foundation, Inc.
Copyright (C) 1999-2018 Free Software Foundation, Inc.
Copyright (C) 1996-2018 Free Software Foundation, Inc.
Copyright (C) 2003-2018 Free Software Foundation, Inc.
Copyright (C) 2009-2018 Free Software Foundation, Inc.
Copyright (C) 2006-2018 Free Software Foundation, Inc.
Copyright (C) 2004-2018 Free Software Foundation, Inc.
Copyright (c) 2006-2007 Diego Pettenò <flameeyes@gmail.com>
Copyright (c) 2006-2007 xine project dnl dnl
Copyright (C) 1996-2001, 2003-2015 Free Software Foundation, Inc. Written by Gordon Matzigkeit, 1996
Copyright (C) 2014 Free Software Foundation, Inc.
Copyright (C) 2011 Free Software Foundation, Inc.
Copyright (C) 2004-2005, 2007-2009, 2011-2015 Free Software Foundation, Inc. Written by Gary V. Vaughan, 2004
Copyright (C) 2004-2005, 2007-2008, 2011-2015 Free Software Foundation, Inc. Written by Gary V. Vaughan, 2004
Copyright (C) 2004, 2011-2015 Free Software Foundation, Inc. Written by Scott James Remnant, 2004
Copyright (C) 2004-2005, 2007, 2009, 2011-2015 Free Software Foundation, Inc. Written by Scott James Remnant, 2004.
Copyright (C) 2012 Free Software Foundation, Inc.
Copyright (C) 1996-2015 Free Software Foundation, Inc.
Copyright 1992-2019 Free Software Foundation, Inc.
Copyright (C) 2015 Intel Corporation.
Copyright (C) 2010 Wolfson Microelectronics PLC
Copyright (C) 2010 Texas Instruments Inc.
Copyright (C) 2010 Red Hat Inc. Authors: Liam Girdwood <lrg@slimlogic.co.uk> Stefan Schmidt <stefan@slimlogic.co.uk> Justin Xu <justinx@slimlogic.co.uk> Jaroslav Kysela <perex@perex.cz>
Copyright (C) 2010 Texas Instruments Inc.
Copyright (c) 2001 by Abramo Bagnara <abramo@alsa-project.org>
Copyright (c) 2000 by Abramo Bagnara <abramo@alsa-project.org>

Copyright (c) 1999 by Uros Bizjak <uros@kss-loka.si> Jaroslav Kysela <perex@perex.cz>
Copyright 1992 by Stichting Mathematisch Centrum, Amsterdam, The Netherlands.
Copyright (c) 2005 by Jaroslav Kysela <perex@perex.cz>
Copyright Matthias Hentges <devel@hentges.net> (c) 2007 License: GPL (see <http://www.gnu.org/licenses/gpl.txt> for a copy of the license)
Copyright (C) 1994 X Consortium
Copyright (C) 1999-2018 Free Software Foundation, Inc. Written by Tom Tromey <tromey@cygnus.com>.
Copyright 1992-2019 Free Software Foundation, Inc.
Copyright (C) 1999-2018 Free Software Foundation, Inc.
Copyright (C) 1996-2018 Free Software Foundation, Inc. Originally written by Fran,cois Pinard <pinard@iro.umontreal.ca>, 1996.
Copyright (C) 2011-2018 Free Software Foundation, Inc.
Copyright (C) 1999-2000 Takashi Iwai
Copyright (c) Clemens Ladisch <clemens@ladisch.de>
Copyright (C) 1994-2018 Free Software Foundation, Inc.
Copyright (C) 1999-2000 Takashi Iwai
Copyright (c) 2005 Clemens Ladisch <clemens@ladisch.de>
Copyright(c) 2014-2015 Intel Corporation
Copyright (c) 2018 Takashi Sakamoto <o-takashi@sakamocchi.jp>
Copyright (C) 1999 Takashi Iwai
Copyright (c) 2004-2006 Clemens Ladisch <clemens@ladisch.de>
Copyright (c) 2004-2005 Clemens Ladisch <clemens@ladisch.de>
Copyright (C) 2003 by Takashi Iwai <tiwai@suse.de>
Copyright (C) 1989, 1991 Free Software Foundation, Inc.
Copyright (C) 2007 Free Software Foundation.
Copyright (C) 1996-2018 Free Software Foundation, Inc.
Copyright (C) 1992-1996, 1998-2012 Free Software Foundation, Inc.
Copyright (C) 2000-2004 James Courtier-Dutton
Copyright (C) 2013-2015 Intel Corporation
Copyright (C) 2015 Caleb Crome
Copyright (C) 1999 Takashi Iwai Jaroslav Kysela <perex@perex.cz>
Copyright (C) 2013-2016 Intel Corporation
Copyright (C) 1995-1997, 2000-2007, 2009-2010 by Ulrich Drepper <drepper@gnu.ai.mit.edu>
Copyright (C) 2009 The ALSA Team Clemens Ladisch <clemens@ladisch.de>, 2009.
Copyright (C) 2005 Free Software Foundation, Inc. Takashi Iwai <tiwai@suse.de>, 2005.
Copyright (C) 2011 The ALSA Team Christoph J. Thompson <cjsthompson@gmail.com>, 2011.
Copyright 1996-2016 Free Software Foundation, Inc. Taken from GNU libtool, 2001 Originally by Gordon Matzigkeit <gord@gnu.ai.mit.edu>, 1996
Copyright (c) 1999-2002 SuSE GmbH Jan ONDREJ
copyright 2003 by Jordi Mallach <jordi@debian.org>
Copyright (C) 2005 THE alsa-utils'S COPYRIGHT HOLDER dushistov@mail.ru., 2005.
Copyright (C) YEAR THE PACKAGE'S COPYRIGHT HOLDER FIRST AUTHOR <EMAIL@ADDRESS>, YEAR.
Copyright (c) by Abramo Bagnara <abramo@alsa-project.org> Jaroslav Kysela <perex@perex.cz>
Copyright (c) 2010 by Jaroslav Kysela <perex@perex.cz>
Copyright (c) by Jaroslav Kysela <perex@perex.cz>
Copyright (C) 2004-2005 Kay Sievers <kay.sievers@vrfy.org>
Copyright (C) 2005-2006 Kay Sievers <kay.sievers@vrfy.org> 2008 Jaroslav Kysela <perex@perex.cz>
Copyright (c) 1998,1999 Tim Janik Jaroslav Kysela <perex@perex.cz>
Copyright (c) 1874 Lewis Carroll
Copyright (c) by Jaroslav Kysela <perex@perex.cz>, Greg Kroah-Hartman <greg@kroah.com>, Kay Sievers <kay.sievers@vrfy.org>
Copyright (C) 2003 Greg Kroah-Hartman <greg@kroah.com>
Copyright (c) by Takashi Iwai <tiwai@suse.de>
Copyright (c) 2010 Clemens Ladisch <clemens@ladisch.de>
Copyright (c) 1999 by Jaroslav Kysela <perex@perex.cz>
Copyright (c) 1999-2000 by Jaroslav Kysela <perex@perex.cz>
Copyright (C) 2008-2010 SlimLogic Ltd

LICENCE TERMS (cont.)

Copyright (c) by Jaroslav Kysela <perex@perex.cz> Based on vplay program by Michael Beck
Copyright 1992-2019 Free Software Foundation, Inc.
Copyright (C) 1999 Takashi Iwai
Copyright(c) 2010-2011 Texas Instruments Incorporated, All rights reserved.
Copyright (C) 1999-2000 Takashi Iwai
Copyright (C) 2002-2018 Free Software Foundation, Inc.
Copyright (C) 2001-2018 Free Software Foundation, Inc.
Copyright (C) 1997-2018 Free Software Foundation, Inc.
Copyright (C) 1999-2018 Free Software Foundation, Inc.
Copyright (C) 1996-2018 Free Software Foundation, Inc.
Copyright (C) 2003-2018 Free Software Foundation, Inc.
Copyright (C) 2009-2018 Free Software Foundation, Inc.
Copyright (C) 2006-2018 Free Software Foundation, Inc.
Copyright (C) 2004-2018 Free Software Foundation, Inc.
Copyright (C) 1995-2014, 2016 Free Software Foundation, Inc.
Copyright (C) 2000-2002, 2007-2014, 2016 Free Software Foundation, Inc.
Copyright (C) 2004-2014, 2016 Free Software Foundation, Inc.
Copyright (C) 1996-2003, 2009-2016 Free Software Foundation, Inc.
Copyright (C) 2001-2016 Free Software Foundation, Inc.
Copyright (C) 2001-2005, 2008-2016 Free Software Foundation, Inc.
Copyright (C) 1995-2003, 2005-2006, 2008-2014, 2016 Free Software dnl Foundation, Inc.
Copyright © 2004 Scott James Remnant <scott@netsplit.com>.
Copyright © 2012-2015 Dan Nicholson <dbn.lists@gmail.com>
Copyright (C) 1996-2003, 2005, 2008-2016 Free Software Foundation, Inc.
Copyright (C) 2002-2018 Free Software Foundation, Inc.
Copyright (C) 2001-2018 Free Software Foundation, Inc.
Copyright (C) 1997-2018 Free Software Foundation, Inc.
Copyright (C) 1999-2018 Free Software Foundation, Inc.
Copyright (C) 1996-2018 Free Software Foundation, Inc.
Copyright (C) 2003-2018 Free Software Foundation, Inc.
Copyright (C) 2009-2018 Free Software Foundation, Inc.
Copyright (C) 2006-2018 Free Software Foundation, Inc.
Copyright (C) 2004-2018 Free Software Foundation, Inc.
Copyright (C) 1995-2014, 2016 Free Software Foundation, Inc.
Copyright (C) 2000-2002, 2007-2014, 2016 Free Software Foundation, Inc.
Copyright (C) 2004-2014, 2016 Free Software Foundation, Inc.
Copyright (C) 1996-2003, 2009-2016 Free Software Foundation, Inc.
Copyright (C) 2001-2016 Free Software Foundation, Inc.
Copyright (C) 2001-2005, 2008-2016 Free Software Foundation, Inc.
Copyright (C) 1995-2003, 2005-2006, 2008-2014, 2016 Free Software dnl Foundation, Inc.
Copyright © 2004 Scott James Remnant <scott@netsplit.com>.
Copyright © 2012-2015 Dan Nicholson <dbn.lists@gmail.com>
Copyright (C) 1996-2003, 2005, 2008-2016 Free Software Foundation, Inc.
Copyright (C) 2012 Free Software Foundation, Inc.
Copyright (C) 2012 Free Software Foundation, Inc.
Copyright (C) 2005 Nathan Hurst
Copyright (C) 2013-2015 Intel Corporation
Copyright (C) 1999-2000 Takashi Iwai Debugging
Copyright © 1999 Takashi Iwai Jaroslav Kysela <perex@perex.cz>
Copyright © 1999-2000 Takashi Iwai Debugging
Copyright (C) 1999-2000 Takashi Iwai
Copyright © 1999-2000 Takashi Iwai
Copyright (C) 1999 Takashi Iwai
Copyright © 1999 Takashi Iwai
Copyright (C) 1999 Takashi Iwai
Copyright (c) 2009 Clemens Ladisch <clemens@ladisch.de>
Copyright (C) 2005-2006 Kay Sievers <kay.sievers@vrfy.org>

Copyright (C) 2010 Wolfson Microelectronics PLC
Copyright (C) 2010 Texas Instruments Inc.
Copyright (C) 2010 Red Hat Inc. Authors: Liam Girdwood <lrg@slimlogic.co.uk> Stefan Schmidt <stefan@slimlogic.co.uk> Justin Xu <justinx@slimlogic.co.uk> Jaroslav Kysela <perex@perex.cz>
Copyright 1992-2019 Free Software Foundation, Inc.; Copyright 1992-2019 Free Software Foundation, Inc.
Copyright (C) 1995-1997, 2000-2007, 2009-2010 by Ulrich Drepper <drepper@gnu.ai.mit.edu>
Copyright 1996-2016 Free Software Foundation, Inc. Taken from GNU libtool, 2001 Originally by Gordon Matzigkeit <gord@gnu.ai.mit.edu>, 1996
copyright 1998 Jason Gunthorpe
Copyright (C) 1992-1996, 1998-2012 Free Software Foundation, Inc.
Copyright © 2002-2015 Free Software Foundation, Inc. Peter Karlsson <peterk@debian.org>, 2002-2008. Daniel Nylander <po@danielnylander.se>, 2005-2010. Anders Jonsson <anders.jonsson@norsjovallen.se>, 2015.
Copyright (C) 2007-2014 Free Software Foundation, Inc. Theppiak Karoonboonyanan <thep@debian.org>, 2007-2008, 2012, 2014. Arthit Suriyawongkul <arthit@gmail.com>, 2008.
Copyright (c) 2000-2001, Aaron D. Gifford All rights reserved.
© Luis Lopes <andrelop@ig.com.br>, 2003-2004
Copyright (C) 2002-2010 Free Software Foundation, Inc.
Copyright: Lars Bahner <bahner@debian.org>, 2002-2003. Axel Bojer <axelb@skolelinux.no>, 2003-2004. Klaus Ade Johnstad <klaus@skolelinux.no>, 2004. Bjorn Steensrud <bjornst@powertech.no>, 2004. Hans Fredrik Nordhaug <hans@nordhaug.priv.no>, 2003, 2005-2010. Petter Reinholdtsen <pere@hung
Copyright (C) 2003-2017 Debian Japanese List <debian-japanese@lists.debian.org> This file is distributed under the same license as the apt package.
Copyright (c) 2009 Rosetta Contributors and Canonical Ltd 2009
copyrigh 1998 Jason Gunthorpe
Copyright (C) 1989, 1991 Free Software Foundation, Inc.
Copyright 1991 by the Massachusetts Institute of Technology
Copyright (C) 2010 Julian Andres Klode <jak@debian.org>
copyright 1999 Jason Gunthorpe
Copyright (C) 2006, 2008 Free Software Foundation, Inc.
Copyright (C) 2005 Software in the Public Interest, Inc. Eric Pareja <xenos@upm.edu.ph>
copyright 1997, 1998, 1999 Jason Gunthorpe and others. Apt is currently developed by APT Development Team <deity@lists.debian.org>.
Copyright (C) 2004 Krzysztof Fiertek <akfedux@megapolis.pl>
Copyright (C) 2002 Free Software Foundation, Inc. Gustavo Noronha Silva <kov@debian.org>, 2002. Andre Luis Lopes <andrelop@debian.org>, 2002-2005. Felipe Augusto van de Wiel (faw) <faw@debian.org>, 2006-2008.
Copyright (C) 2000-2018 Debian French I10n team <debian-i10n-french@lists.debian.org>
Copyright © 2002, 2003, 2004, 2005, 2006, 2008, 2009, 2010, 2011, 2012 Software in the Public Interest, Inc. Antoni Bella Perez <bella5@teleline.es>, 2002, 2003. Matt Bonner <mateubonet@yahoo.com>, 2003. Jordi Mallach <jordi@debian.org>
Copyright (C) 1996-2018 Free Software Foundation, Inc.
Copyright (C) 1997, 1998, 1999 Jason Gunthorpe and others. Holger Wansing <linux@wansing-online.de>, 2008, 2009, 2010, 2012, 2014, 2017, 2018. Jens Seidel <jensseidel@users.sf.net>, 2008. Michael Piefel <piefel@informatik.hu-berlin.de>, 2001, 2002, 2003, 2004, 2006. Rüdiger Kuhlmann
Copyright (c) (c) 2006 Canonical Ltd, and Rosetta Contributors 2006. Gintautas Miliauskas <gintas@akl.lt>, 2008. Andrius Kokiančikis <napalm@mintis.lt>, 2008.
Copyright (C) 2009 Free Software Foundation, Inc.
Copyright (C) 2004 Free Software Foundation, Inc.
Copyright (c) 2000 Licensed under the GNU General Public License v2
copyright 1998-1999 Jason Gunthorpe
Copyright (c) 2014 Anthony Towns
Copyright (C) 2000-2017 Debian Italian I10n team <debian-i10n-italian@lists.debian.org> Translators: Eugenia Franzoni, 2000 Hugh Hartmann, 2000-2012 Gabriele Stilli, 2012 Beatrice Torracca <beatricet@libero.it>, 2012, 20
Copyright (C) 1998, Ben Gertzfield <che@debian.org>
copyright 1997 Manoj Srivastava
copyright 1997 by Joey Hess.
Copyright (C) 1997, 1998, 1999 Jason Gunthorpe and others. Chris Leick <c.leick@vollbio.de>, 2009-2018.
Copyright (C) 2014 apt & nedenstående oversættelse. This file is distributed under the same license as the apt

LICENCE TERMS (cont.)

package. Claus Hindsgaul <claus.hindsgaul@gmail.com>, 2002, 2003, 2004, 2005, 2006, 2007. Joe Hansen <joedalton2@yahoo.dk>, 2010, 2012, 2013, 2014, 2017.
Copyright (C) 2003, 2004, 2009, 2010, 2012 Software in the Public Interest
Copyright (C) 2002-2010, 2011, 2012, 2013, 2014, 2015, 2017, 2018, 2019 The Free Software Foundation, Inc.
Samuele Giovanni Tonon <samu@debian.org>, 2002. Milo Casagrande <milo@milo.name>, 2009, 2010, 2011, 2012, 2013, 2014
(C) 2015 Julian Andres Klode <jak@debian.org>
copyright 1997 Tom Lees
Copyright (C) 2001 Free Software Foundation, Inc. Project Vine, Daisuke SUZUKI <daisuke@linux.or.jp>, 2001-2002
Debian Project, Masato Taruishi <taru@debian.org>, 2002 Debian Project, Keita Maehara <maehara@debian.org>, 2003 Debian Project, Kenshi Muto <kmuto@debian.org>, 2004-2012 Takuma
copyright 1999 Jason Gunthorpe
Copyright (C) 2012 Free Software Foundation, Inc.
Copyright (C) 2012 Free Software Foundation, Inc.
copyright© Luis Lopes <andrelap@debian.org> "n" Language-Team: <debian-l10n-portuguese@lists.debian.org>
copyright© Luis Lopes <email>andrelap@ig.com
copyright 1998 Jason Gunthorpe
copyright 1999 Jason Gunthorpe
copyright 1998-2001 Jason Gunthorpe
copyright Jason Gunthorpe 1998-2001
Copyright (c) 2013 Debian L10n Turkish 2013 Mert Dirik <mertdirik@gmail.com>, 2013-2018.
Copyright (C) 2000-2004, 2010, 2012 Robert Luberda <robert@debian.org>
Copyright (C) 2000-2004, 2010, 2012 Robert Luberda <robert@debian.org>
copyright 1998 Jason Gunthorpe
copyright 1999 Jason Gunthorpe
Copyright (C) 1995-2014, 2016 Free Software Foundation, Inc.
Copyright (C) 2000-2002, 2007-2014, 2016 Free Software Foundation, Inc.
Copyright (C) 2004-2014, 2016 Free Software Foundation, Inc.
Copyright (C) 1996-2003, 2009-2016 Free Software Foundation, Inc.
Copyright (C) 2001-2016 Free Software Foundation, Inc.
Copyright (C) 2001-2005, 2008-2016 Free Software Foundation, Inc.
Copyright (C) 1995-2003, 2005-2006, 2008-2014, 2016 Free Software dnl Foundation, Inc.
Copyright (C) 1996-2003, 2005, 2008-2016 Free Software Foundation, Inc.
Copyright (C) 1995-2014, 2016 Free Software Foundation, Inc.
Copyright (C) 2000-2002, 2007-2014, 2016 Free Software Foundation, Inc.
Copyright (C) 2004-2014, 2016 Free Software Foundation, Inc.
Copyright (C) 1996-2003, 2009-2016 Free Software Foundation, Inc.
Copyright (C) 2001-2016 Free Software Foundation, Inc.
Copyright (C) 2001-2005, 2008-2016 Free Software Foundation, Inc.
Copyright (C) 1995-2003, 2005-2006, 2008-2014, 2016 Free Software dnl Foundation, Inc.
Copyright (C) 1996-2003, 2005, 2008-2016 Free Software Foundation, Inc.
copyright Jason Gunthorpe 1998-2001
Copyright (C) 1994 X Consortium
Copyright (C) 1996-2015 Free Software Foundation, Inc.
Copyright (C) 1999-2018 Free Software Foundation, Inc. Written by Tom Tromey <tromey@cygnus.com>.
Copyright 1992-2019 Free Software Foundation, Inc.
Copyright (C) 1999-2018 Free Software Foundation, Inc.
Copyright (C) 2004-2005, 2007, 2009, 2011-2015 Free Software Foundation, Inc. Written by Scott James Remnant, 2004.
Copyright (C) 2004, 2011-2015 Free Software Foundation, Inc. Written by Scott James Remnant, 2004
Copyright (C) 1996-2001, 2003-2015 Free Software Foundation, Inc. Written by Gordon Matzigkeit, 1996
Copyright (C) 2004-2005, 2007-2008, 2011-2015 Free Software Foundation, Inc. Written by Gary V. Vaughan, 2004
Copyright (C) 2004-2005, 2007-2009, 2011-2015 Free Software Foundation, Inc. Written by Gary V. Vaughan, 2004
Copyright (C) 1996-2018 Free Software Foundation, Inc. Originally written by Fran.cois Pinard <pinard@iro.umontreal.ca>, 1996.
Copyright (C) 2011-2018 Free Software Foundation, Inc.
Copyright 1996-2016 Free Software Foundation, Inc. Taken from GNU libtool, 2001 Originally by Gordon Matzigkeit

<gord@gnu.ai.mit.edu>, 1996
Copyright 2004-2015 by the Avahi developers.
Copyright (C) 1994-2018 Free Software Foundation, Inc.
Copyright (C) 1999 Tom Tromey
Copyright (c) 2003-2004, Apple Computer, Inc. All rights reserved.
Copyright 2004-2009 by the Avahi developers.
Copyright (C) 1996-2018 Free Software Foundation, Inc.
Copyright (C) 1992-1996, 1998-2012 Free Software Foundation, Inc.
Copyright (C) 1995-2014, 2016 Free Software Foundation, Inc.
Copyright (C) 2000-2002, 2007-2014, 2016 Free Software Foundation, Inc.
Copyright (C) 2001-2005, 2008-2016 Free Software Foundation, Inc.
Copyright 1999-2016 Gentoo Foundation Distributed under the terms of the GNU General Public License v2
Copyright (C) 2004 Oren Ben-Kiki This file is distributed under the same terms as the Automake macro files.
Copyright (C) 1996-2003, 2005, 2008-2016 Free Software Foundation, Inc.
Copyright (C) 1995-2003, 2005-2006, 2008-2014, 2016 Free Software dnl Foundation, Inc.
Copyright (C) 1996-2003, 2009-2016 Free Software Foundation, Inc.
Copyright (C) 2001-2016 Free Software Foundation, Inc.
Copyright (C) 2004 Oren Ben-Kiki
Copyright (C) 2009 Avahi's COPYRIGHT HOLDER. Bruce Cowan <bcowan@fastmail.co.uk>, 2009.
Copyright (C) 2011 Free Software Foundation, Inc.
Copyright (C) YEAR THE PACKAGE'S COPYRIGHT HOLDER
Copyright (C) YEAR THE PACKAGE'S COPYRIGHT HOLDER
Copyright (C) 1995, 1996, 1997 by Ulrich Drepper <drepper@gnu.ai.mit.edu>
Copyright (C) 2006-2007 Collabora Ltd.
Copyright (C) 2006 Collabora Ltd.
Copyright (C) 2007 Collabora Ltd. author Sjoerd Simons <sjoerd@luon.net>
Copyright (C) 2000-2018 Free Software Foundation, Inc.
Copyright (C) 1994-2018 Free Software Foundation, Inc.
Copyright (C) 1991, 1999 Free Software Foundation, Inc.
Copyright 2003, 2004, 2004 Porchdog Software. All rights reserved.
Copyright 2003, 2004 Porchdog Software. All rights reserved.
Copyright 2010 Lennart Poettering
(C) 2005-02-02 David A.
Copyright 2003, 2004 Porchdog Software, Inc. All rights reserved.
Copyright 2009 Johan Dahlin
Copyright(C) 2005 James Willcox <snorp@snorp.net>
Copyright (C) 2004-2015 Free Software Foundation, Inc.
Copyright (C) 2010-2015 Free Software Foundation, Inc.
Copyright 1992-2019 Free Software Foundation, Inc.
Copyright (C) 2014 Free Software Foundation, Inc.
Copyright (C) 2011 Free Software Foundation, Inc.
Copyright (C) 2000 Red Hat, Inc.
Copyright (C) 2002-2018 Free Software Foundation, Inc.
Copyright (C) 2001-2018 Free Software Foundation, Inc.
Copyright (C) 1997-2018 Free Software Foundation, Inc.
Copyright (C) 1999-2018 Free Software Foundation, Inc.
Copyright (C) 1996-2018 Free Software Foundation, Inc.
Copyright (C) 2003-2018 Free Software Foundation, Inc.
Copyright (C) 2009-2018 Free Software Foundation, Inc.
Copyright (C) 2006-2018 Free Software Foundation, Inc.
Copyright (C) 2004-2018 Free Software Foundation, Inc.
Copyright (C) 1995-2002 Free Software Foundation, Inc.
Copyright (C) 2001-2003,2004 Red Hat, Inc.
Copyright (C) 2004-2013 Free Software Foundation, Inc.
Copyright © 2004 Scott James Remnant <scott@netsplit.com>.
Copyright © 2012-2015 Dan Nicholson <dbn.lists@gmail.com>
Copyright 2009 Johan Dahlin

LICENCE TERMS (cont.)

Copyright (C) 1996-2001, 2003-2015 Free Software Foundation, Inc. Written by Gordon Matzigkeit, 1996
Copyright (C) 2004-2005, 2007-2009, 2011-2015 Free Software Foundation, Inc. Written by Gary V. Vaughan, 2004
Copyright (C) 2004-2005, 2007-2008, 2011-2015 Free Software Foundation, Inc. Written by Gary V. Vaughan, 2004
Copyright (C) 2004, 2011-2015 Free Software Foundation, Inc. Written by Scott James Remnant, 2004
Copyright (C) 2004-2005, 2007, 2009, 2011-2015 Free Software Foundation, Inc. Written by Scott James Remnant, 2004.
Copyright (C) 1995-2003, 2005-2006, 2008-2014, 2016 Free Software dnl Foundation, Inc.
Copyright (C) 2012 Free Software Foundation, Inc.
Copyright (C) 2012 Free Software Foundation, Inc.
Copyright (C) 2004-2008 Rodney Dawes <dobey.pwns@gmail.com>
Copyright (C) 2004 Oren Ben-Kiki
Copyright (C) 1989, 1991 Free Software Foundation, Inc.
Copyright 1992-2019 Free Software Foundation, Inc.
Copyright 1991 by the Massachusetts Institute of Technology
copyright 2001 2002 2003 2004 2005 2007 Joey Hess Colin Watson David Mandelberg
Copyright (C) 1989, 1991 Free Software Foundation, Inc.
Copyright 1999-2002 Wichert Akkerman <wichert@deephackmode.org>
Copyright 1999 2002 Wichert Akkerman
Copyright (C) 1992-1996, 1998-2012 Free Software Foundation, Inc.
copyright 1999 2002 Wichert Akkerman
Copyright (C) 2008 Free Software Foundation, Inc.
Copyright (C) 2010 Software in the Public Interest
Copyright (C) Helge Kreutzmann <debian@helgefjell.de>, 2011.
Copyright (C) YEAR Free Software Foundation, Inc.
Copyright (C) 2010 Free Software Foundation, Inc. KURASAWA Nozomu <nabetaro@debian.or.jp>, 2010.
Copyright (C) 2004 Nicolas FRANCOIS
Copyright 1999-2002 Wichert Akkerman <wichert@deephackmode.org>
Copyright 2002, 2003, 2004 Colin Watson <cjwatson@debian.org>
Copyright 2001, 2002 Joey Hess
Copyright 2002, 2003, 2004, 2005, 2007 Colin Watson
Copyright 2007 David Mandelberg
copyright 2002, 2003 Colin Watson.
Copyright (C) 2012 Free Software Foundation, Inc.
copyright 2002, 2003 Colin Watson.
Copyright 1999 2002 Wichert Akkerman und 2002, 2003 Colin Watson.
copyright 2002, 2003 Colin Watson.
Copyright 1999 2002 Wichert Akkerman und 2002, 2003 Colin Watson.
copyright 1999 2002 Wichert Akkerman et le copyright 2002, 2003 Colin " Watson.
Copyright 2002, 2003, 2004 Colin Watson <cjwatson@debian.org>
Copyright 1992-2019 Free Software Foundation, Inc.; Copyright 1992-2019 Free Software Foundation, Inc.
Copyright 1996-2016 Free Software Foundation, Inc. Taken from GNU libtool, 2001 Originally by Gordon Matzigkeit <gord@gnu.ai.mit.edu>, 1996
Copyright (C) 1992-2018 Free Software Foundation, Inc.
Copyright (C) 1993-2009 Free Software Foundation, Inc.
Copyright (C) 2007 Free Software Foundation, Inc.
Copyright (C) 1987-2009, 2011-2012 Free Software Foundation, Inc.
Copyright (C) 1993-2016 Free Software Foundation, Inc.
Copyright (C) 1989-2017 Free Software Foundation, Inc.
Copyright (C) 2000, 2001, 2005, 2008, 2009 Free Software Foundation, Inc.
Copyright (C) 1993-2013 Free Software Foundation, Inc.
Copyright (C) 1994-2014 Free Software Foundation, Inc.
Copyright (C) 1987-2009 Free Software Foundation, Inc.
Copyright (C) 1996-2014 Free Software Foundation, Inc. Originally written by Fran.cois Pinard <pinard@iro.umontreal.ca>, 1996.
Copyright (C) 1987-2018 Free Software Foundation, Inc.
Copyright (C) 2000-2002 Free Software Foundation, Inc.
Copyright (C) 1992-1996, 1998-2012 Free Software Foundation, Inc.

Copyright (C) 1991-2016 Free Software Foundation, Inc.
Copyright (C) 1999-2018 Free Software Foundation, Inc.
Copyright (C) 2004 Servilio Afre Puentes <servilio@gmail.com>
Copyright (C) 2001-2010 Free Software Foundation, Inc.
Copyright (C) 2000-2009 Free Software Foundation, Inc.
Copyright (C) 2001, 2005, 2008, 2009 Free Software Foundation, Inc.
Copyright 2006 Yann Rouillard <yann@opencsw.org>
Copyright (C) 1993-2018 Free Software Foundation, Inc.
Copyright (C) 1997-2009 Free Software Foundation, Inc.
Copyright (C) 1993-2015 Free Software Foundation, Inc.
Copyright (C) 1993-2017 Free Software Foundation, Inc.
Copyright (C) 1997-2016 Free Software Foundation, Inc.
Copyright (C) 1987-2017 Free Software Foundation, Inc.
Copyright (C) 1987-2016 Free Software Foundation, Inc.
Copyright (C) 1993 Free Software Foundation, Inc.
Copyright (C) 1987-2015 Free Software Foundation, Inc.
Copyright (C) 1992-2002 Free Software Foundation, Inc.
Copyright 2003 Eelco Lempsink <eelcolempsink@gmx.net> 2011 Raphaël Droz <raphael.droz+floss@gmail.com>
Copyright (C) 2005-2006 Rocky Bernstein for Free Software Foundation, Inc.
Copyright (C) 1997-2017 Free Software Foundation, Inc.
Copyright (C) 1994-2018 Free Software Foundation, Inc.
Copyright 1999 Chester Ramey
Copyright 1997 Chester Ramey
Copyright 1996 Chester Ramey
Copyright 2002 Chester Ramey
Copyright (C) 2002-2008 Rocky Bernstein for Free Software Foundation, Inc.
Copyright (C) Ian Macdonald <ian@caliban.org>
Copyright 2011 Chester Ramey
Copyright (C) 1999-2015 Free Software Foundation, Inc.
Copyright (C) 2002, Richard S. Smith.
Copyright (C) 1996-2017 Free Software Foundation, Inc.
Copyright (C) 1999-2009 Free Software Foundation, Inc.
Copyright (C) 1987, 1991 Free Software Foundation, Inc.
Copyright (C) 1989-2019 Free Software Foundation, Inc.
Copyright (C) 1995-2010 Free Software Foundation, Inc.
Copyright (C) 1987-2016 Free Software Foundation, Inc.
Copyright (C) 1987, 1991, 2001, 2003, 2005, 2006, 2008, 2009 Free Software Foundation, Inc.
Copyright (C) 2001-2016 Free Software Foundation, Inc.
Copyright (C) 1996-2018 Free Software Foundation, Inc.
Copyright (C) 1987-2015 Free Software Foundation, Inc.
Copyright (C) 1995-2014 Free Software Foundation, Inc.
Copyright (C) 1985-2017 Free Software Foundation, Inc.
Copyright (C) 1991-2017 Free Software Foundation, Inc.
Copyright (C) 1985, 1988, 1989, 2008, 2009 Free Software Foundation, Inc.
Copyright (C) 2012 Free Software Foundation, Inc.
Copyright (C) 1987-2002 Free Software Foundation, Inc.
Copyright (C) 1989, 1990, 1991, 1992, 1993, 2008, 2009 Free Software Foundation, Inc.
Copyright (C) 1989-2017 Free Software Foundation, Inc.
Copyright (C) 1984, 1989-1990, 2000-2015, 2018 Free Software Foundation, Inc.
Copyright (C) 1989-2018 Free Software Foundation, Inc.
Copyright (C) 1997, 2001, 2005, 2008, 2009 Free Software Foundation, Inc.
Copyright (C) 1997-2015 Free Software Foundation, Inc.
Copyright (C) 2003 Free Software Foundation, Inc. Eugen Hoanca <eugenh@urban-grafx.ro>, 2003.
Copyright (C) 2002-2009 Free Software Foundation, Inc.
Copyright (C) 1994-2013 Free Software Foundation, Inc.
Copyright (C) 2011 Free Software Foundation, Inc. This file is distributed under the same license as the bash package. Sergio Pokrovskij <sergio.pokrovskij@gmail.com>, 1998, ... 2016.

LICENCE TERMS (cont.)

Copyright (C) 1984, 1989-1990, 2000-2015, 2018 Free Software Foundation, Inc.
Copyright (C) 2000-2001, 2003-2007, 2009-2011, 2012 Free Software Foundation, Inc.
Copyright (C) 2006 Free Software Foundation, Inc.
Copyright (C) 1998-1999, 2001, 2003, 2005-2007, 2009-2012 Free Software Foundation, Inc.
Copyright (C) 1989-2009 Free Software Foundation, Inc.
Copyright (C) 2010, 2011, 2013 Free Software Foundation, Inc. Xin Ye <alyex.ye@gmail.com>, 2010. Aron Xu <happyaron.xu@gmail.com>, 2011. Anthony Fok <foka@debian.org>, 2013. Wylmer Wang <wantinghard@gmail.com>, 2014. Mi
Copyright (C) 1987-2018 Free Software Foundation, Inc.
Copyright (C) 2018 Free Software Foundation, Inc. Pedro Albuquerque <palbuquerque73@gmail.com>, 2018.
Copyright (C) 1991, 1992, 1995, 2001, 2005, 2006, 2008,2009 Free Software Foundation, Inc.
Copyright (C) 1985, 1986, 1993,1994, 1995, 1998, 2001,2003,2005,2006,2008,2009 Free Software Foundation, Inc.
Copyright (C) 1996-2009 Free Software Foundation, Inc.
Copyright (C) 1985-2009 Free Software Foundation, Inc.
Copyright (C) 2018 Free Software Foundation, Inc.
Copyright 1999-2009 Free Software Foundation, Inc.
Copyright (C) 2006 Free Software Foundation, Inc. Ivan Masár <helix84@centrum.sk>, 2007, 2008, 2009, 2010, 2011.
Copyright (C) 1998-2011 Free Software Foundation, Inc.
Copyright (C) 2009-2010 Free Software Foundation, Inc.
Copyright (C) 2018 Free Software Foundation, Inc.
Copyright (C) 2000 Free Software Foundation, Inc.
Copyright (C) 1994, 1999 Free Software Foundation, Inc.
Copyright (C) 1999 Free Software Foundation, Inc.
Copyright © 2008, 2009, 2010, 2011, 2013, 2014, 2015, 2016, 2018 Free Software Foundation, Inc.
Copyright (C) 1999-2002 Free Software Foundation, Inc.
Copyright (C) 2000-2002 Free Software Foundation, Inc.
Copyright (C) 2008 Free Software Foundation, Inc. This file is distributed under the same license as the bash package.
Copyright (C) 1997-2002 Free Software Foundation, Inc.
Copyright (C) 2009 Free Software Foundation, Inc. This file is distributed under the same license as the bash package.
Copyright (C) 1993-2002 Free Software Foundation, Inc.
Copyright (C) 2002 Free Software Foundation, Inc.
Copyright (C) 1997 Free Software Foundation, Inc.
Copyright (C) 1991-2002 Free Software Foundation, Inc.
Copyright (C) 2002 Free Software Foundation, Inc. Ruslan Batdalov <linnando@tolkien.ru>, 2002. Pavel Maryanov <acid@jack.kiev.ua>, 2014, 2018.
Copyright (C) 2018 Free Software Foundation, Inc. Automatically generated, 2018.
Copyright (C) 2006-2010 Free Software Foundation, Inc.
Copyright (C) 2001-2002 Free Software Foundation, Inc.
Copyright (C) 2009 Free Software Foundation, Inc. This file is distributed under the same license as the bash package. Sergio Zanchetta <primes2h@ubuntu.com>, 2010, 2011.
Copyright (C) 1991,92,94,95,96,97,98,99,2000,2001 Free Software Foundation, Inc.
Copyright © 2015 Free Software Foundation, Inc. Clytie Siddall <clytie@riverland.net.au>, 2008, 2009, 2010. Nguyễn Thái Ngọc Duy <pclouds@gmail.com>, 2012. Trần Ngọc Quân <vnwildman@gmail.com>, 2012-2014, 2015.
Copyright (C) 2008,2009,2015 Free Software Foundation, Inc.
Copyright (C) 2004 Free Software Foundation, Inc.
Copyright (C) 2008,2009 Free Software Foundation, Inc.
Copyright (C) 1991 Free Software Foundation, Inc.
Copyright (C) 2010-2016 Free Software Foundation, Inc.
Copyright (C) 2001, 2006, 2009, 2010, 2012, 2015-2018 Free Software Foundation, Inc.
Copyright © 2018 Free Software Foundation, Inc.
Copyright (C) 2008 Free Software Foundation, Inc. Arif E. Nugroho <arif_endro@yahoo.com>, 2008, 2009, 2010, 2011, 2012, 2013, 2014.
Copyright (C) 2001,2006,2010,2012 Free Software Foundation, Inc.
Copyright (C) 2008 Free Software Foundation, Inc.

Copyright (C) 2001 Free Software Foundation, Inc.
Copyright (C) 2007-2010 Free Software Foundation, Inc.
Copyright (C) 1987, 1989, 1991 Free Software Foundation, Inc.
Copyright (C) 2002-2005 Free Software Foundation, Inc.
Copyright (C) 1998-2010 Free Software Foundation, Inc.
Copyright (C) 2001 Free Software Foundation, Inc. Toomas Soome <Toomas.Soome@microlink.ee>, 2006.
Copyright (C) 2006 Free Software Foundation, Inc.
Copyright (C) 2013 Free Software Foundation, Inc.
Copyright (C) 2007, 2010, 2011, 2013, 2014, 2015, 2016, 2018 Free Software Foundation, Inc. Andrzej M. Krzysztofowicz <ankry@mif.pg.gda.pl> 2006,2007. Jakub Bogusz <qboosh@pld-linux.org> 2010-2018.
Copyright (C) 1995 Free Software Foundation, Inc.
Copyright (C) 2009 Free Software Foundation, Inc.
Copyright (C) 2000-2015 Free Software Foundation, Inc.
Copyright (C) 2009-2015 Free Software Foundation, Inc.
Copyright (C) 1991, 1992 Free Software Foundation, Inc.
Copyright (C) 2002, 2003, 2010, 2014, 2015, 2017 Free Software Foundation, Inc. Montxo Vicente i Sempere <montxo@enmoviment.com>, 2003 (traducció), 2010 (revisions). Jordi Mas i Hernández <jmas@softcatala.org>, 2004
Copyright (C) 1991, 1994 Free Software Foundation, Inc.
Copyright (C) 1995-2018 Free Software Foundation, Inc.
Copyright (C) 1999-2017 Free Software Foundation, Inc.
Copyright (C) 2008 Free Software Foundation, Inc. Petr Pisar <petr.pisar@atlas.cz>, 2008, 2009, 2010, 2011, 2012, 2013, 2014. Petr Pisar <petr.pisar@atlas.cz>, 2015, 2016, 2018.
Copyright (C) 2003-2015 Free Software Foundation, Inc.
Copyright (C) 2010 Free Software Foundation, Inc.
Copyright (C) 2017 Free Software Foundation, Inc.
Copyright (C) 2008-2010 Free Software Foundation, Inc.
Copyright (C) 2005-2015 Free Software Foundation, Inc.
Copyright (C) 2018 Free Software Foundation, Inc. Cristian Othón Martínez Vera <cfuga@cfuga.mx>, 2000 - 2011. Francisco Javier Serrador <fserrador@gmail.com> Antonio Ceballos Roa <aceballos@gmail.com>, 2018
Copyright (C) 1995,2010 Free Software Foundation, Inc.
Copyright (C) 2017 Free Software Foundation, Inc. This file is distributed under the same license as the bash package. Åka Sikrom <a4@hush.com>, 2015-2017.
Copyright (C) 1987,1989 Free Software Foundation, Inc.
Copyright (C) 1998-2002 Free Software Foundation, Inc.
Copyright (C) 2011 Free Software Foundation, Inc.
Copyright (C) 1994-2017 Free Software Foundation, Inc.
Copyright (C) 2018 Free Software Foundation, Inc. Nils Naumann <nau@gmx.net>, 1996-2018.
Copyright (C) 1985, 1988, 1990-1991, 1995-2010, 2012, 2015 Free Software Foundation, Inc.
Copyright (C) 2012 - 2013 Free Software Foundation, Inc. This file is distributed under the same license as the bash package.
Copyright (C) 1988-2017 Free Software Foundation, Inc.
Copyright (C) 1987,1991 Free Software Foundation, Inc.
Copyright (C) 1985, 1988, 1990-1991, 1995-2010, 2012, 2015, 2017 Free Software Foundation, Inc.
Copyright (C) 1992-2009 Free Software Foundation, Inc.
Copyright (C) 1989, 1992-2009,2017 Free Software Foundation, Inc.
Copyright (C) 2014 Free Software Foundation, Inc. Мирослав Николић <miroslavnikolic@rocketmail.com>, 2014—2016.
Copyright (C) 1985, 1988, 1990-1991, 1995-2010, 2012, 2017 Free Software Foundation, Inc.
Copyright (C) 2010, 2016, 2017 Free Software Foundation, Inc.
Copyright (C) 2001-2015 Free Software Foundation, Inc.
Copyright (C) 2007, 2010, 2012, 2013, 2014, 2015, 2016 Free Software Foundation, Inc. Alexander Shopov <ash@kambanaria.org>, 2007, 2010, 2012, 2013, 2014, 2015, 2016.
Copyright (C) 1987,1991-2015 Free Software Foundation, Inc.
Copyright (C) 2000-2017 Free Software Foundation, Inc.
Copyright (C) 1999, 2010, 2011, 2013 Free Software Foundation, Inc. Kyoichi Ozaki <k@afromania.org>, 2000.
Takeshi Hamasaki <hmatrjp@users.sourceforge.jp>, 2011, 2013. Yasuaki Taniguchi <yasuakit@gmail.com>, 2011,

LICENCE TERMS (cont.)

2014, 201
Copyright (C) 1994-2015 Free Software Foundation, Inc.
Copyright (C) 2018 Free Software Foundation, Inc. Michel Robitaille <robitail@IRO.UMontreal.CA>, 2004 Christophe Combelles <ccomb@free.fr>, 2008, 2009, 2010, 2011
Copyright (C) 1994-2012 Free Software Foundation, Inc.
Copyright (C) 1994-2009,2017 Free Software Foundation, Inc.
Copyright (C) 1992-2015 Free Software Foundation, Inc.
Copyright (C) 2013 Free Software Foundation, Inc.
Copyright (C) 1987, 1989, 1992 Free Software Foundation, Inc.
Copyright (C) 1989-2015 Free Software Foundation, Inc.
Copyright (C) 2009 Free Software Foundation, Inc.
Copyright (C) 1987, 1989, 1992-2015, 2017 Free Software Foundation, Inc.
Copyright (C) 1987-2017 Free Software Foundation, Inc.
Copyright (C) 1994 Free Software Foundation, Inc.
Copyright (C) 2016 Free Software Foundation, Inc.
Copyright (C) 2018 Free Software Foundation, Inc. Halley Pacheco de Oliveira <halleypo@ig.com.br>, 2002. Rafael Fontenelle <rafaelff@gnome.org>, 2015, 2016, 2018.
Copyright (C) 1999 Jeff Solomon
Copyright (C) YEAR Free Software Foundation, Inc.
Copyright (C) 2004 Free Software Foundation, Inc. Petri Jooste <rkwjbj@puk.ac.za>, 2004.
Copyright (C) 1993-2017 Free Software Foundation, Inc.
Copyright (C) 1987,1991,2012 Free Software Foundation, Inc.
Copyright (C) 2001-2017 Free Software Foundation, Inc.
Copyright (C) 1988,1989-2009,2017 Free Software Foundation, Inc.
Copyright (C) 1997-2009,2017 Free Software Foundation, Inc.
Copyright @copyright{} 1988-2016 Free Software Foundation, Inc.
Copyright (C) 1988-2018 Free Software Foundation, Inc. end ignore
Copyright (C) 1988-2016 Free Software Foundation, Inc. Authored by Brian Fox and Chet Ramey.
Copyright (C) 1996-2002 Free Software Foundation, Inc.
Copyright (C) 1988-2018 Free Software Foundation, Inc. Authored by Brian Fox and Chet Ramey.
Copyright (C) 1988-2016 Free Software Foundation, Inc.
Copyright 1985, 1986, 1988, 1990, 1991, 1992, 1993, 1994, 1995, 1996, 1997, 1998, 1999, 2000, 2001, 2002, 2003, 2004, 2005, 2006, 2007, 2008, 2009, 2010, 2011, 2012, 2013, 2014, 2015 Free Software Foundation, Inc.
Copyright (C) 1992-2017 Free Software Foundation, Inc.
Copyright (C) 1985, 1988, 1990-1991, 1995-2010, 2012 Free Software Foundation, Inc.
Copyright (C) 1989-2009 Free Software Foundation, Inc.
Copyright (C) 1995-2009 Free Software Foundation, Inc.
Copyright (C) 1991-2010,2017 Free Software Foundation, Inc.
Copyright (C) 1988-2018 Free Software Foundation, Inc.
Copyright (C) 2000-2011 Free Software Foundation, Inc.
Copyright (C) 1987-2011 Free Software Foundation, Inc.
Copyright (C) 1989-2018 by the Free Software Foundation, Inc.
Copyright (C) 1998,2003,2017 Free Software Foundation, Inc.
Copyright (C) 1996-2015 Free Software Foundation, Inc.
Copyright (C) 1991-2004 Free Software Foundation, Inc.
Copyright (C) 2002-2013 Free Software Foundation, Inc.
Copyright (C) 2010-2017 Free Software Foundation, Inc.
Copyright (C) 1991-2018 Free Software Foundation, Inc.
Copyright (C) 2001-2003 Free Software Foundation, Inc.
Copyright (C) 1993-2003 Free Software Foundation, Inc.
Copyright (C) 1991-2003 Free Software Foundation, Inc.
Copyright (C) 2000, 2001, 2002, 2007, 2008 Free Software Foundation, Inc.
Copyright (C) 1985-2005 Free Software Foundation, Inc.
Copyright (C) 1998-2017 Free Software Foundation, Inc.
Copyright (C) 1995, 1997, 1998, 2000, 2001, 2005-2009 Free Software Foundation, Inc.
Copyright (C) 2003, 2005-2009 Free Software Foundation, Inc. Written by Bruno Haible <bruno@clisp.org>, 2003.
Copyright (C) 2001-2002, 2005-2009 Free Software Foundation, Inc.

Copyright (C) 2000-2003, 2005-2009 Free Software Foundation, Inc.
Copyright 1995-2014 by Chester Ramey.
Copyright (C) 1984, 1989, 1990, 2000, 2001, 2002, 2003, 2004 Free Software Foundation, Inc.
Copyright 2011 The Pragmatic Programmers, LLC
Copyright (C) 1995-1999, 2000, 2001, 2002, 2005-2009 Free Software Foundation, Inc. Contributed by Ulrich Drepper <drepper@gnu.ai.mit.edu>, 1995.:(C) tests whether C is a directory separator character. IS_ABSOLUTE_PATH(P) tests whether P is an absolute path. If it is not, it may be concatenated to a directory pathname.
Copyright (C) 1995-1997, 2000, 2001, 2002, 2006-2009 Free Software Foundation, Inc.
Copyright (C) 1995-1999, 2000-2001, 2003, 2005-2009 Free Software Foundation, Inc.
Copyright (C) 2000, 2001, 2005-2009 Free Software Foundation, Inc. Written by Ulrich Drepper <drepper@cygnus.com>, 2000.
Copyright (C) 1995-1998, 2000, 2001, 2002, 2005-2009 Free Software Foundation, Inc.
Copyright (C) 1995-1999, 2000-2003, 2005-2009 Free Software Foundation, Inc. Written by Ulrich Drepper <drepper@cygnus.com>, 1995.
Copyright (C) 1991,1992,1993,1994,1995,1996,1997,1998,1999,2000,2001,2002,2003, 2004,2005,2006,2007,2008, 2009,2010,2011 Free Software Foundation, Inc.
Copyright (C) 1995-1998, 2000-2003, 2008,2009 Free Software Foundation, Inc.
Copyright (C) 1995-1999, 2000-2003, 2005-2009 Free Software Foundation, Inc.
Copyright (C) 1995, 1997, 2000, 2001, 2002, 2005-2009 Free Software Foundation, Inc.
Copyright (C) 1995-1997, 2000, 2001, 2002, 2005, 2006, 2008,2009 Free Software Foundation, Inc.
Copyright (C) 1995-1999, 2000, 2001, 2002, 2006-2009 Free Software Foundation, Inc.
Copyright (C) 1996,1997,1998,1999,2000,2001,2005-2009 Free Software Foundation, Inc.
Copyright (C) 2003, 2005-2009 Free Software Foundation, Inc. Written by Bruno Haible <bruno@clisp.org>, 2003.
Copyright (C) 1995-1999, 2000-2003, 2006-2009 Free Software Foundation, Inc.
Copyright (C) 1995-1997, 2000-2003, 2004-2009 Free Software Foundation, Inc.
Copyright (C) 1995, 2000-2003, 2005-2009 Free Software Foundation, Inc.
Copyright (C) 2001-2009 Free Software Foundation, Inc.
Copyright (C) 2000, 2001, 2002, 2005-2009 Free Software Foundation, Inc. Written by Ulrich Drepper <drepper@cygnus.com>, 2000.
Copyright (C) 1995-1999, 2000-2002, 2005-2009 Free Software Foundation, Inc.
Copyright (C) 1995, 1997, 2000-2002, 2005-2009 Free Software Foundation, Inc.
Copyright (C) 1993-2010 Free Software Foundation, Inc.
Copyright (C) 1996-1999, 2000-2002, 2005-2009 Free Software Foundation, Inc. This file is part of the GNU C Library. Contributed by Ulrich Drepper <drepper@cygnus.com>, 1996.
Copyright (C) 1996-2009,2012,2016 Free Software Foundation, Inc.
Copyright (C) 1995-1999, 2000, 2001, 2005-2009 Free Software Foundation, Inc. Written by Ulrich Drepper <drepper@gnu.org>, 1995.
Copyright (C) 1987,1989,1991,1995,1998,2001,2003,2005,2006,2008,2009 Free Software Foundation, Inc.
Copyright (C) 2003, 2005-2009 Free Software Foundation, Inc.
Copyright (C) 1995-1998, 2000, 2001, 2005-2009 Free Software Foundation, Inc. Contributed by Ulrich Drepper <drepper@gnu.ai.mit.edu>, 1995.
Copyright (C) 2000-2002, 2006-2009 Free Software Foundation, Inc.
Copyright (C) 1990-2015 Free Software Foundation, Inc.
Copyright (C) 1996-2011 Free Software Foundation, Inc.
Copyright (C) 1991, 1992, 1996, 2008,2009 Free Software Foundation, Inc.
Copyright (C) 2002-2004 Free Software Foundation, Inc.
Copyright (C) 2001, 2005-2007, 2009-2010 Free Software Foundation, Inc.:(c) tests whether the single-byte character c is in the ISO C "basic character set". */
Copyright (C) 1996 Free Software Foundation, Inc.
Copyright (C) 1987-2010 Free Software Foundation, Inc.
Copyright (C) 1998 Richard Braakman
Copyright 1991 by the Massachusetts Institute of Technology
Copyright (C) 1995-1998, 2000-2002, 2008,2009 Free Software Foundation, Inc.
Copyright (C) 2005, 2007, 2009-2012 Free Software Foundation, Inc.
Copyright (C) 2001 Free Software Foundation, Inc.:(c) 1 else:(c) isascii(c) endif
Copyright (C) 1999 Free Software Foundation, Inc. */
Copyright 1992, 1993, 1994, 1995, 1996, 1997, 1998, 1999, 2001, 2002, 2003, 2004, 2005, 2006, 2007, 2008, 2009,

LICENCE TERMS (cont.)

2010, 2011, 2012, 2013, 2014 Free Software Foundation, Inc.
Copyright (C) 1996-2014 Free Software Foundation, Inc.
Copyright (C) 2008,2009,2011 Free Software Foundation, Inc.
Copyright (C) 1992-2006 Free Software Foundation, Inc.
Copyright (C) 1991-2009 Free Software Foundation, Inc.
Copyright (C) 1998-2018 Free Software Foundation, Inc.
Copyright (C) 1992 Simon Marshall
Copyright (C) 1998-2009 Free Software Foundation, Inc.
Copyright (C) 1996-2004 Free Software Foundation, Inc.
Copyright (C) 1990-2010 Free Software Foundation, Inc.
Copyright (C) 1999, 2000 Free Software Foundation, Inc.
Copyright (C) 1996, 1997 Free Software Foundation, Inc. Franc,ois Pinard <pinard@iro.umontreal.ca>, 1996.
Copyright 1996-2018 Free Software Foundation, Inc. Taken from GNU libtool, 2001 Originally by Gordon Matzigkeit <gord@gnu.ai.mit.edu>, 1996
Copyright (C) 1989-2002 Free Software Foundation, Inc.
Copyright (C) 1993, 2001, 2005, 2008,2009 Free Software Foundation, Inc.
Copyright (C) 2015 Free Software Foundation, Inc.
Copyright (C) 1998 Free Software Foundation, Inc.
Copyright (C) 2017 Free Software Foundation, Inc.
Copyright (C) 2016 Free Software Foundation, Inc.
Copyright 1995 Chester Ramey
Copyright 1992 Chester Ramey
Copyright 1994 Chester Ramey
Copyright 1998 Chester Ramey
Copyright 1991 Chester Ramey
Copyright 2001 Chester Ramey
Copyright (C) 1994 X Consortium
Copyright (C) 1989, 1991 Free Software Foundation, Inc.
Copyright © 2006-2008, Ian Macdonald <ian@caliban.org>;© 2009-2016
Copyright (C) 1996-2014 Free Software Foundation, Inc.
Copyright (C) 1995-2003 Free Software Foundation, Inc.
Copyright (C) 2000-2002 Free Software Foundation, Inc.
Copyright (C) 2002 Free Software Foundation, Inc.
Copyright (C) 1997-2002 Free Software Foundation, Inc.
Copyright (C) 1997-2003 Free Software Foundation, Inc.
Copyright (C) 1995-2002 Free Software Foundation, Inc.
Copyright (C) 1996-2003 Free Software Foundation, Inc.
Copyright (C) 2001-2003 Free Software Foundation, Inc.
Copyright (C) 1999-2002 Free Software Foundation, Inc.
Copyright (C) 1995-2003 Free Software Foundation, Inc.
Copyright (C) 2000-2002 Free Software Foundation, Inc.
Copyright (C) 2002 Free Software Foundation, Inc.
Copyright (C) 1997-2002 Free Software Foundation, Inc.
Copyright (C) 1997-2003 Free Software Foundation, Inc.
Copyright (C) 1995-2002 Free Software Foundation, Inc.
Copyright (C) 1996-2003 Free Software Foundation, Inc.
Copyright (C) 2001-2003 Free Software Foundation, Inc.
Copyright (C) 1999-2002 Free Software Foundation, Inc.
Copyright (C) 2012 Free Software Foundation, Inc.
Copyright (C) 1998-1999, 2001, 2003, 2005-2007, 2009-2012 Free Software Foundation, Inc.
Copyright (C) 2000-2001, 2003-2007, 2009-2011, 2012 Free Software Foundation, Inc.
Copyright (C) 2012 Free Software Foundation, Inc.
Copyright (C) 2012 Free Software Foundation, Inc.
Copyright (C) 1998-1999, 2001, 2003, 2005-2007, 2009-2012 Free Software Foundation, Inc.
Copyright (C) 2000-2001, 2003-2007, 2009-2011, 2012 Free Software Foundation, Inc.
Copyright (C) 2008-2016 Free Software Foundation, Inc.
Copyright (C) 2008-2013 Free Software Foundation, Inc.

Copyright (C) 2004 Servilio Afre Puentes <servilio@gmail.com>
Copyright (C) 2004 Servilio Afre Puentes <servilio@gmail.com>
Copyright (C) 2004 Servilio Afre Puentes <servilio@gmail.com>
Copyright (C) 2004 Servilio Afre Puentes <servilio@gmail.com>
Copyright (C) 1987-2015 Free Software Foundation, Inc.",
Copyright (C) 2018 Free Software Foundation, Inc.
Copyright (C) 2018 Free Software Foundation, Inc."
Copyright (C) 2012 Free Software Foundation, Inc."
Copyright (C) 2009 Free Software Foundation, Inc."
Copyright(C) 2009 Free Software Foundation, Inc.
Copyright (C) 2014 Free Software Foundation, Inc."
Copyright (C) 2018 Free Software Foundation, Inc.
Copyright © 2018 Free Software Foundation, Inc."
Copyright(C) 2009 Free Software Foundation, Inc."
Copyright(C) 2009 Free Software Foundation, Inc."
Copyright© Free Software Foundation, Inc., 2016"
Copyright© Free Software Foundation, Inc., 2014"
Copyright© Free Software Foundation, Inc., 2012"
Copyright© Free Software Foundation, Inc., 2009
Copyright (C) 2018 Free Software Foundation, Inc.
Copyright© Free Software Foundation, Inc, 2016."
Copyright© Free Software Foundation, Inc, 2012."
Copyright (C) 2018 Free Software Foundation, Inc."
Copyright © 2011 Free Software Foundation, Inc."
Copyright © 2009 Free Software Foundation, Inc.
Copyright© 2006 Free Software Foundation, Inc.
Copyright (C) 2018 Free Software Foundation, Inc.
Copyright © 2009 Free Software Foundation, Inc."
Copyright (C) 2013 Free Software Foundation, Inc."
Copyright (C) 2012 Free Software Foundation, Inc."
Copyright ©2014 Free Software Foundation, Inc."
Copyright ©2012 Free Software Foundation, Inc."
Copyright ©2009 Free Software Foundation, Inc.
Copyright© 2018 Free Software Foundation, Inc."
Copyright© 2012 Free Software Foundation, Inc."
Copyright (c) 1983, 1990, 1993 The Regents of the University of California. All rights reserved.
Copyright (c) 1993 by Digital Equipment Corporation.
Copyright (c) 1983, 1990, 1993 The Regents of the University of California. All rights reserved.
Copyright (c) 1993 by Digital Equipment Corporation.
Copyright(C) 2016 Free Software Foundation, Inc."
Copyright(C) 2014 Free Software Foundation, Inc."
Copyright(C) 2012 Free Software Foundation, Inc."
Copyright(C) 2016 Free Software Foundation, Inc."
Copyright 2011 The Pragmatic Programmers, LLC
Copyright 2011 The Pragmatic Programmers, LLC
Copyright (C) 2005 Glen Fowler.
Copyright (C) 2002 Josip Rodin
Copyright (C) 2003 Julian Gilbey
copyright 2003 by Julian Gilbey <jdgl@debian.org>,
copyright 1998 by Richard Braakman
copyright 2002 by Josip Rodin.
Copyright (C) 2002 Josip Rodin
Copyright (C) 2003 Julian Gilbey
copyright 2003 by Julian Gilbey <jdgl@debian.org>,
copyright 1998 by Richard Braakman
copyright 2002 by Josip Rodin.
Copyright (C) 2002-2014 Free Software Foundation, Inc.

Copyright (C) 2001-2014 Free Software Foundation, Inc.
Copyright (C) 1996-2014 Free Software Foundation, Inc.
Copyright (C) 2003-2014 Free Software Foundation, Inc.
Copyright (C) 1997-2014 Free Software Foundation, Inc.
Copyright (C) 2009-2014 Free Software Foundation, Inc.
Copyright (C) 2006-2014 Free Software Foundation, Inc.
Copyright (C) 2004-2014 Free Software Foundation, Inc.
Copyright (C) 1994 X Consortium
Copyright (C) 1996-2015 Free Software Foundation, Inc. This is free software
Copyright (C) 1999-2018 Free Software Foundation, Inc. Written by Tom Tromeu <tromeu@cygnus.com>.
Copyright 1992-2019 Free Software Foundation, Inc.
Copyright (C) 1999-2018 Free Software Foundation, Inc.
Copyright (C) 1996-2018 Free Software Foundation, Inc. Originally written by Fran.cois Pinard <pinard@iro.umontreal.ca>, 1996.
Copyright (C) 2011-2018 Free Software Foundation, Inc.
Copyright (C) 2014 Intel Corporation. All rights reserved.
Copyright (C) 2011-2014 Intel Corporation
Copyright (C) 1987-2011 Free Software Foundation, Inc.
Copyright (C) 2011-2012 Intel Corporation
Copyright (C) 1991-2013 Free Software Foundation, Inc.
Copyright (C) 2012-2014 Intel Corporation. All rights reserved.
Copyright (C) 2014 Intel Corporation
Copyright (C) 2013-2014 Intel Corporation. All rights reserved.
Copyright (C) 2014 Intel Corporation. All rights reserved.
Copyright (C) 2013 Intel Corporation
Copyright (C) 2006-2010 Nokia Corporation
Copyright (C) 2013-2014 Intel Corporation
Copyright (C) 2000-2001 Qualcomm Incorporated
Copyright (C) 2004-2010 Marcel Holtmann <marcel@holtmann.org>
Copyright (C) 2012 Instituto Nokia de Tecnologia - INdT
Copyright (C) 2010 GSyC/LibreSoft, Universidad Rey Juan Carlos.
Copyright (C) 2010 GSyC/LibreSoft, Universidad Rey Juan Carlos.
Copyright (C) 2012 Texas Instruments, Inc.
Copyright (C) 2010 Instituto Nokia de Tecnologia - INdT
Copyright (C) 2010 ST-Ericsson SA
Copyright (C) 2010 Instituto Nokia de Tecnologia - INdT
Copyright (C) 2010 ST-Ericsson SA
Copyright (C) 2012 Nordic Semiconductor Inc.
Copyright (C) 2014 Tieto Poland
Copyright (C) 2012 Marcel Holtmann <marcel@holtmann.org>
Copyright (C) 2006-2007 Nokia Corporation
Copyright (C) 2012 The Android Open Source Project
Copyright (C) 2011 The Android Open Source Project
Copyright (C) 2014 The Android Open Source Project
Copyright (C) 2013 The Android Open Source Project
Copyright (C) 2012-2014 The Android Open Source Project
Copyright (C) 2008 The Android Open Source Project
Copyright (C) 2015,2016 Felipe F. Tonello <eu@felipetonello.com>
Copyright (C) 2004-2010 Marcel Holtmann <marcel@holtmann.org>
Copyright (C) 2009,2017 Bastien Nocera <hadess@hadess.net>
Copyright (c) 2012 David Herrmann
Copyright (C) 2013 Intel Corporation. All rights reserved.
Copyright (C) 2014 Intel Corporation.
Copyright (C) 2003-2014 Marcel Holtmann <marcel@holtmann.org>
Copyright (C) 2012 Marcel Holtmann <marcel@holtmann.org>
Copyright (C) 2003-2010 Marcel Holtmann <marcel@holtmann.org>
Copyright (C) 1989, 1991 Free Software Foundation, Inc.
Copyright (C) 2009-2010 Marcel Holtmann <marcel@holtmann.org>
Copyright 2011, The Android Open-Source Project
Copyright 2008, The Android Open-Source Project
Copyright (C) 2005-2010 Marcel Holtmann <marcel@holtmann.org>
Copyright (C) 2002-2010 Marcel Holtmann <marcel@holtmann.org>
Copyright (C) 2015 Intel Corporation
Copyright (C) 2012-2013 Intel Corporation
Copyright (C) 2011 Intel Corporation. All rights reserved.
Copyright (C) 2007-2010 Marcel Holtmann <marcel@holtmann.org>
Copyright (C) 2012 Intel Corporation. All rights reserved.
Copyright (C) 2017 Intel Corporation. All rights reserved.
Copyright (C) 2002-2003 Maxim Krasnyansky <maxk@qualcomm.com>
Copyright (C) 2003-2011 Marcel Holtmann <marcel@holtmann.org>
Copyright (C) 2004-2011 Marcel Holtmann <marcel@holtmann.org>
Copyright (C) 2001-2002 Wayne Lee <waynelee@qualcomm.com>
Copyright (C) 2000-2002 Maxim Krasnyansky <maxk@qualcomm.com>
Copyright (C) 2011 André Dieb Martins <andre.dieb@gmail.com>
Copyright (C) 2002-2003 Takashi Sasai <sasai@sm.sony.co.jp>
Copyright (C) 2012 Tieto Poland
Copyright (c) 2013-2014, The Linux Foundation. All rights reserved. Not a Contribution.
Copyright (c) 2013-2015, The Linux Foundation. All rights reserved. Not a Contribution.
Copyright (C) 2012 Intel Corporation.
Copyright (C) 2001-2002 Ricky Yuen <ryuen@qualcomm.com>
Copyright (C) 2011 Intel Corporation.
Copyright (C) 2002-2011 Marcel Holtmann <marcel@holtmann.org>
Copyright (C) 2014-2015 Intel Corporation. All rights reserved.
Copyright (C) 2001-2002 Nokia Corporation
Copyright (C) 2017-2018 Codecoup
Copyright (C) 2003-2010 Marcel Holtmann <marcel@holtmann.org>
Copyright (C) 2015 Intel Corporation. All rights reserved.
Copyright (C) 2000-2005 CSR Ltd.
© Antonio Santos Cadenas <jcaden@libresoft.es> Francisco Alecrim <francisco.alecrim@openbossa.org> Daniel Orstadius <daniel.orstadius@gmail.com> Anderson Briglia <anderson.briglia@openbossa.org> Anderson Lizardo <anderson.lizardo@openbossa.org> Bruna Moreira <bruna.moreira@openbossa.org>
Copyright (C) 2005-2010 Marcel Holtmann <marcel@holtmann.org>
Copyright (C) 2008-2009 Marcel Holtmann <marcel@holtmann.org>
Copyright (c) 2009-2010 Atheros Communications Inc.
Copyright (C) 2014 Instituto Nokia de Tecnologia - INdT
Copyright (C) 2007-2008 Texas Instruments, Inc.
Copyright (C) 2011-2017 Intel Corporation. All rights reserved.
Copyright (C) 2014 Google Inc.
Copyright (C) 1991, 1999 Free Software Foundation, Inc.
Copyright (C) 1994, 1995, 1996, 1999, 2000, 2001, 2002, 2004, 2005 Free Software Foundation, Inc.
Copyright (C) 2010 Nokia Corporation
Copyright (C) 2011 Nokia Corporation
Copyright (C) 2015 Andrzej Kaczmarek <andrzej.kaczmarek@codecouple.pl>
Copyright (C) 2011 Nokia Corporation
Copyright (C) 2012 Texas Instruments Corporation
Copyright (C) 1996-2018 Free Software Foundation, Inc.
Copyright (C) 2011 Intel Corporation
Copyright (C) 2012 Intel Corporation
Copyright (C) 2011 Bartosz Szatkowski <bulislaw@linux.com> for Comarch
Copyright (C) 2013 BMW Car IT GmbH. All rights reserved.
Copyright (C) 2007-2010 Marcel Holtmann <marcel@holtmann.org>
Copyright (C) 2007-2010 Intel Corporation
Copyright (C) 2016 Intel Corporation
Copyright (C) 2007-2010 Nokia Corporation

LICENCE TERMS (cont.)

Copyright (C) 2010-2011 Nokia Corporation
Copyright (C) 2012-2013 BMW Car IT GmbH. All rights reserved.
Copyright (C) 2010 Marcel Mol <marcel@mesa.nl>
Copyright (C) 2009-2010 Intel Corporation
Copyright (C) 2008-2010 Intel Corporation. All rights reserved.
Copyright (C) 2012-2017 Intel Corporation. All rights reserved.
Copyright (C) 2018 Intel Corporation
Copyright (C) 2007-2010 Nokia Corporation
Copyright (C) 2015 Google Inc.
Copyright (C) 2018 Intel Corporation. All rights reserved.
Copyright (C) 1992-1996, 1998-2012 Free Software Foundation, Inc.
Copyright (c) 2013, Kenneth MacKay All rights reserved.
Copyright (C) 2016 Intel Corporation. All rights reserved.
Copyright (C) 2010-2011 ST-Ericsson SA ""
Copyright (C) 2011 Free Software Foundation, Inc.
Copyright (C) 1994-2018 Free Software Foundation, Inc.
Copyright (C) 2010-2011 Code Aurora Forum. All rights reserved.
Copyright (C) 2012 Intel Corporation. All rights reserved.
Copyright (C) 2013 Intel Corporation.
Copyright (C) 2012 Google Inc.
Copyright (C) 2011-2012 David Herrmann <dh.herrmann@googlemail.com>
Copyright (C) 2009 Bastien Nocera <hadess@hadess.net>
Copyright (C) 2012-2013 Tieto Poland
Copyright (C) 2013 Intel Corporation. All rights reserved.
Copyright (C) 2014 Google, Inc.
Copyright (C) 2004-2015 Free Software Foundation, Inc. This is free software
Copyright (C) 2010-2015 Free Software Foundation, Inc. This is free software
Copyright 1992-2019 Free Software Foundation, Inc.
Copyright (C) 2004-2010 Marcel Holtmann <marcel@holtmann.org>
Copyright (C) 2010 GSyC/LibreSoft, Universidad Rey Juan Carlos.
Copyright (C) 2002-2003 Maxim Krasnyansky <maxk@qualcomm.com>
Copyright (C) 2002-2010 Marcel Holtmann <marcel@holtmann.org>
Copyright (C) 2014 Google Inc.
Copyright (C) 2017 Red Hat Inc.
Copyright (C) 2010 Signove
Copyright (C) 2014 Intel Corporation. All rights reserved.
Copyright (C) 2015 Google Inc.
Copyright (C) 2011 Tieto Poland
Copyright (C) 2010 ST-Ericsson SA
Copyright (C) 2004-2010 Marcel Holtmann <marcel@holtmann.org>
Copyright (C) 2011 Texas Instruments, Inc.
Copyright (C) 2010 ST-Ericsson SA
Copyright (C) 2012 Instituto Nokia de Tecnologia - INdT
Copyright (C) 2009 Joao Paulo Rechi Vita
Copyright (C) 2004-2009 Marcel Holtmann <marcel@holtmann.org>
Copyright (C) 2011 BMW Car IT GmbH. All rights reserved.
Copyright (C) 2004-2009 Marcel Holtmann <marcel@holtmann.org>
Copyright (C) 2012-2012 Intel Corporation
Copyright (C) 2014 Google Inc.
Copyright (C) 2016 ROLI Ltd.
Copyright (C) 2011 Antonio Ospite <ospite@studenti.unina.it>
Copyright (C) 2013 Szymon Janc <szymon.janc@gmail.com>
Copyright (C) 2012 Marcel Holtmann <marcel@holtmann.org>
Copyright (C) 2012 Nordic Semiconductor Inc.
Copyright (C) 2009-2010 Nokia Corporation
Copyright (C) 2002-2010 Marcel Holtmann <marcel@holtmann.org>
Copyright (C) 2003-2011 Marcel Holtmann <marcel@holtmann.org>

Copyright 2012 The Android Open Source Project
Copyright (C) 2002-2003 Stephen Crane <steve.crane@rococosoft.com>
Copyright (C) 2002-2003 Jean Tourrilhes <jt@hpl.hp.com>
Copyright (C) 2011-2014 Intel Corporation
Copyright (C) 2008-2009 Mario Limonciello <mario_limonciello@dell.com>
Copyright (C) 2009-2011 Kay Sievers <kay.sievers@vrfy.org>
Copyright (c) 2010, Code Aurora Forum. All rights reserved.
Copyright 2012 The Android Open Source Project
Copyright (c) 2013-2014, The Linux Foundation. All rights reserved. Not a Contribution.
Copyright (C) 2005-2010 Marcel Holtmann <marcel@holtmann.org>
Copyright (C) 2010 Marcel Holtmann <marcel@holtmann.org>
Copyright (C) 2011 Marcel Holtmann <marcel@holtmann.org>
Copyright (C) 2007-2015 Free Software Foundation, Inc. dnl This file is free software
Copyright (C) 2002-2018 Free Software Foundation, Inc.
Copyright (C) 2001-2018 Free Software Foundation, Inc.
Copyright (C) 1997-2018 Free Software Foundation, Inc.
Copyright (C) 1999-2018 Free Software Foundation, Inc.
Copyright (C) 1996-2018 Free Software Foundation, Inc.
Copyright (C) 2003-2018 Free Software Foundation, Inc.
Copyright (C) 2009-2018 Free Software Foundation, Inc.
Copyright (C) 2006-2018 Free Software Foundation, Inc.
Copyright (C) 2004-2018 Free Software Foundation, Inc.
Copyright (C) 1996-2001, 2003-2015 Free Software Foundation, Inc. Written by Gordon Matzigkeit, 1996
Copyright (C) 2014 Free Software Foundation, Inc. This is free software
Copyright (C) 2011 Free Software Foundation, Inc. This config.lt script is free software
Copyright (C) 2004-2005, 2007-2009, 2011-2015 Free Software Foundation, Inc. Written by Gary V. Vaughan, 2004
Copyright (C) 2004-2005, 2007-2008, 2011-2015 Free Software Foundation, Inc. Written by Gary V. Vaughan, 2004
Copyright (C) 2004, 2011-2015 Free Software Foundation, Inc. Written by Scott James Remnant, 2004
Copyright (C) 2004-2005, 2007, 2009, 2011-2015 Free Software Foundation, Inc. Written by Scott James Remnant, 2004.
Copyright © 2004 Scott James Remnant <scott@netsplit.com>.
Copyright © 2012-2015 Dan Nicholson <dbn.lists@gmail.com> dnl dnl This program is free software
Copyright (C) 2011-2012 BMW Car IT GmbH. All rights reserved.
Copyright (C) 2007-2010 Marcel Holtmann <marcel@holtmann.org>
Copyright (C) 2002-2003 Stephen Crane <steve.crane@rococosoft.com>
Copyright (C) 2012 Free Software Foundation, Inc. This configure script is free software
Copyright (C) 2012 Free Software Foundation, Inc. This config.status script is free software
Copyright (C) 2005-2007 Johan Hedberg <johan.hedberg@nokia.com>
Copyright (c) 2012 Code Aurora Forum. All rights reserved.
Copyright© Nespresso S.A."
Copyright case 550: return "Merlinia A/S"
Copyright case 551: return "LifeBEAM Technologies"
Copyright case 552: return "Twocanoes Labs, LLC"
Copyright case 553: return "Muoverti Limited"
Copyright case 554: return "Stamer Musikanlagen GMBH"
Copyright case 555: return "Tesla Motors"
Copyright case 556: return "Pharynx Cor
Copyright (C) 2007-2008 Fabien Chevalier <fabchevalier@free.fr>
Copyright (C) 2012 Intel Corporation.
Copyright (C) 2013 Instituto Nokia de Tecnologia - INdT
Copyright (c) 2001-2006, Gerrit Pape All rights reserved.;copyright notice, this list of conditions and the following disclaimer in the documentation and/or other materials provided with the distribution. 3. The name of the author may not be used to endorse or promote products derived from this software without specific prior written p
Copyright (C) 1999-2005 by Erik Andersen <andersen@codepoet.org>
Copyright (C) 2008 by Vladimir Dronnikov <dronnikov@gmail.com>
Copyright (c) 1999 by David I. Bell Permission has been granted to redistribute this code under GPL.
Copyright (C) 1996..2008 Markus Franz Xaver Johannes Oberhumer All Rights Reserved.

LICENCE TERMS (cont.)

Copyright (C) 1992, 1993, 1994, 1995 Remy Card (card@masi.ibp.fr) Laboratoire MASI - Institut Blaise Pascal
Universite Pierre et Marie Curie (Paris VI)
Copyright (C) 1991,92,95,96,97,98,99,2000,01 Free Software Foundation, Inc. This file is part of the GNU C Library.
Copyright (C) 1995, 1996 by Bruce Perens <bruce@pixar.com>.
Copyright (C) 1991,92,95,96,97,98,99,2001 Free Software Foundation, Inc. This file is part of the GNU C Library.
Copyright (C) 2003 Manuel Novoa III <mjn3@codepoet.org>
Copyright 2006 by Rob Landley <rob@landley.net>
Copyright (C) 2007 Bernhard Reutner-Fischer
Copyright (C) 1999-2004 by Erik Andersen <andersen@codepoet.org>
Copyright (C) 2003 by Rob Landley <rob@landley.net>, Joey Hess
Copyright (c) 1989, 1991, 1993, 1994 The Regents of the University of California. All rights reserved.
Copyright (C) 2008 by Denys Vlasenko <vda.linux@googlemail.com>
Copyright (c) 2007 Denys Vlasenko <vda.linux@googlemail.com>
Copyright (C) 2005 Kay Sievers <kay.sievers@vrfy.org>
Copyright 2006, Bernhard Reutner-Fischer
Copyright (C) 1996, 1997, 1998, 1999 Free Software Foundation, Inc. This file is part of the GNU C Library.
Copyright (c) 1999 by David I. Bell Permission has been granted to redistribute this code under GPL.
Copyright (C) 2007 Denys Vlasenko
Copyright (C) 2007 Denys Vlasenko.
Copyright (C) 2017 Denys Vlasenko
Copyright 1993 MicroWalt Corporation
Copyright (C) 2017 Denys Vlasenko
Copyright (C) 2018 Denys Vlasenko
Copyright: 2006, 2007 Stefan Rompf <sux@loplof.de>. License: GPL v2.
Copyright (C) 2009 Denys Vlasenko
Copyright (C) 2011 Denys Vlasenko.
Copyright (C) 2002-2005 Free Software Foundation, Inc.
Copyright (C) 1997-2002 Free Software Foundation, Inc.
Copyright (C) 1999-2004 by Erik Andersen <andersen@codepoet.org>
Copyright (C) 1996-2002 Free Software Foundation, Inc.
(C) 2007 Gabriel Somlo <somlo at cmu.edu>
Copyright (C) 2000,2001 Larry Doolittle <larry@doolittle.boa.org>
Copyright (C) 1999 Matthew Ramsay <matthewr@moreton.com.au> Chris Trew <ctrew@moreton.com.au>
Copyright (C) 2011-2017 Denys Vlasenko.
Copyright (C) 2006 Jesse Dutton <jessedutton@gmail.com>
Copyright (C) 2008 Michele Sanges <michele.sanges@gmail.com>
Copyright (c) 2009 Denys Vlasenko <vda.linux@googlemail.com>
Copyright 1997, 2000, 2001 Larry Doolittle <LRDoolittle@lbl.gov>
Copyright (C) 2017 Denys Vlasenko <vda.linux@googlemail.com>
Copyright (C) [2003] by [Matteo Croce] <3297627799@wind.it> Hacked by Tito <farmatito@tiscali.it> for size optimization.
Copyright (C) 2006 Michael Opdenacker <michael@free-electrons.com>
Copyright (C) 2001 Magnus Damm <damm@opensource.se>
Copyright 1991-1997 Miquel van Smoorenburg.
Copyright (c) 2013 INSIDE Secure Corporation
Copyright 1994 Matthew Dillon (dillon@apollo.west.oic.com) version 2.3.2);(C) 2002
Copyright (C) 2001, Hewlett-Packard Company Author: Christopher Hoover <ch@hpl.hp.com>
Copyright 1999-2003 Donald Becker and Scyld Computing Corporation.
Copyright (C) 2000 Arcom Control System Ltd
Copyright 1994 Matthew Dillon (dillon@apollo.west.oic.com);(C) 2002
Copyright (C) 2011 Marek Bečka <yuen@klacno.sk>
Copyright (C) 2005 Roberto A. Foglietta (me@roberto.foglietta.name)
Copyright (C) 2019 Denys Vlasenko <vda.linux@googlemail.com> Licensed under GPLv2, see file LICENSE in this source tree.
Copyright (C) 2003 by Tito Ragusa <farmatito@tiscali.it>
Copyright (C) 1990, 91, 92, 93, 96 Free Software Foundation, Inc.
Copyright (C) 2005 by Rob Sullivan <cogito.ergo.cogito@gmail.com>

Copyright (C) 2006 Bernhard Reutner-Fischer
Copyright (C) 2008 by Bernhard Reutner-Fischer
Copyright (C) 2009 Bernhard Reutner-Fischer
Copyright (c) 1988, 1989, 1991, 1994, 1995, 1996, 1997, 1998, 1999, 2000 The Regents of the University of California. All rights reserved.:(C) 2005 <dzo@simtreas.ru>
Copyright (C) 2003 Paul Mundt <lethal@linux-sh.org>
Copyright (C) 2010 Malek Degachi <malek-degachi@laposte.net>
Copyright (C) 2005 by Marc Leeman <marc.leeman@barco.com>
Copyright (C) 2007 by Denys Vlasenko <vda.linux@googlemail.com>
Copyright 2003 Tito Ragusa <farmatito@tiscali.it>
Copyright (C) 2006-2015 wolfSSL Inc.
(C) 2009 Stefan Seyfried <seife@sphairon.com>
Copyright (C) 2000, Jan-Derk Bakker (J.D.Bakker@its.tudelft.nl)
Copyright (C) 2008 Denys Vlasenko <vda.linux@googlemail.com> Licensed under GPLv2, see file LICENSE in this source tree.
Copyright (C) 2003 by Arthur van Hoff (avh@strangeberry.com)
Copyright (C) 2000-2001 Jeff Tranter (tranter@pobox.com)
Copyright (C) 2017 Denys Vlasenko <vda.linux@googlemail.com>
Copyright (C) 1998, 1999 Charles P. Wright
Copyright (C) 2017 by Denys Vlasenko <vda.linux@googlemail.com>
Copyright (C) 1999 by Randolph Chung <tausq@debian.org>
Copyright (C) 2017 Markus Gothe <nietzsche@lysator.liu.se>
Copyright (C) 2001 Manuel Novoa III <mjn3@codepoet.org>
Copyright (C) 2014 by Bartosz Golaszewski <bartekgola@gmail.com>
Copyright 1997,... by Peter Hanecak <hanecak@megaloman.sk>. All rights reserved.
Copyright (c) 1988, 1993, 1994 The Regents of the University of California. All rights reserved.
Copyright (C) 1995, 1996 by Bruce Perens <bruce@pixar.com>.
Copyright 2006 Rob Landley <rob@landley.net>
Copyright (C) 2005 by Erik Andersen <andersen@codepoet.org>
Copyright (C) 2005 Manuel Novoa III <mjn3@codepoet.org>
Copyright (C) 2006 by Rob Sullivan, with ideas from code by Walter Harms
Copyright (C) 2005 by Robert Sullivan <cogito.ergo.cogito@gmail.com>
Copyright (c) 2011 Pere Orga <gotrunks@gmail.com> Licensed under GPLv2 or later, see file LICENSE in this source tree.
Copyright (C) 2005-6, Roberto A. Foglietta <me@roberto.foglietta.name>
(C) Copyright 2000, Axis Communications AB, LUND, SWEDEN
Copyright 2010 Rob Landley <rob@landley.net>
Copyright (C) 2004, Glenn McGrath
Copyright (C) 2002,2003 Glenn Engel <glenne@engel.org>
Copyright (C) 1989-1999 Free Software Foundation, Inc.
Copyright 2007 Tito Ragusa <farmatito@tiscali.it>
Copyright (C) 86, 89, 91, 1995-2002, 2004 Free Software Foundation, Inc.
Copyright (C) 2002 Jeff Angielski, The PTR Group <jeff@thptrgroup.com>
Copyright (C) 2000 by Matt Kraai <kraai@alumni.carnegiemellon.edu> SELinux support by Yuichi Nakamura <ynakam@hitachisoft.jp>
Copyright (C) 2000 by Glenn McGrath
Copyright (C) 2018 Denys Vlasenko
Copyright (C) 2002 by Bart Visscher <magick@linux-fan.com>
Copyright (C) 2015 by Ari Sundholm <ari@tuxera.com>
(C) 2009 <vonsch@gmail.com>
Copyright (c) 2002 AYR Networks, Inc.
Copyright (c) 2002 Glenn McGrath
Copyright 2003, Glenn McGrath
Copyright (C) 1999,2000 by Lineo, inc. and John Beppu
Copyright (C) 2009 Maksym Kryzhanovskyy <xmaks@email.cz>
Copyright (C) 2004 by Rob Landley <rob@landley.net>
Copyright (C) 2000,2001 Matt Kraai

LICENCE TERMS (cont.)

Copyright (C) 1994-2000 by Tomi Ollila
Copyright (C) 2010 Bradley M. Kuhn <bkuhn@ebb.org> Kuhn's copyrights are licensed GPLv2-or-later. File as a whole remains GPLv2.
Copyright (C) 1999 by Randolph Chung <tausq@debian.org>
Copyright (C) 2014 Isaac Dunham <ibid.ag@gmail.com>
Copyright (C) 2000 Edward Betts <edward@debian.org>.
Copyright (C) 2007 Denys Vlasenko.
Copyright (C) 2003-2004 by Erik Andersen <andersen@codepoet.org>
Copyright (c) 1991, 1993 The Regents of the University of California. All rights reserved.
Copyright (C) 2004 Kay Sievers <kay.sievers@vrfy.org>
Copyright (C) 2000 by Daniel Jacobowitz Written by Daniel Jacobowitz <dan@debian.org>
Copyright (C) 2006 by Jason Schoon <floydpink@gmail.com>
Copyright (C) 2012 S-G Bergh <sgb@systemasis.org>
Copyright (C) 2003 by Glenn McGrath SELinux support: by Yuichi Nakamura <ynakam@hitachisoft.jp>
Copyright (C) 1999-2004 by Erik Andersen <andersen@codepoet.org>;(C) 2002 Vladimir Oleynik <dzo@simtreas.ru>
Copyright (C) 1999,2000,2001 by Lineo, inc. and John Beppu
Copyright (C) 1999,2000,2001 by Lineo, inc. Written by Mark Whitley <markw@codepoet.org> deblotted by Bernhard Reutner-Fischer
Copyright (C) 2005 W. Michael Petullo <mike@flyn.org>
Copyright (C) 92, 1995-2004 Free Software Foundation, Inc.:(c) putchar(c);
Copyright (C) 1999-2004 by Erik Andersen <andersen@codepoet.org> based on original code by (I think) Bruce Perens <bruce@pixar.com>.
Copyright (C) 2013 Rolf Fokkens <rolf@fokkens.nl>
Copyright (C) 2003 Manuel Novoa III <mjn3@codepoet.org>
Copyright (C) 2018 Sven-Göran Bergh <sgb@systemaxion.se>
Copyright (C) 86, 1991-1997, 1999 Free Software Foundation, Inc.
Copyright (C) 2003 Yang Xiaopeng <yxp@hanwang.com.cn>
Copyright 1999 Dave Cinege
Copyright (c) by a whole pile of folks:
Copyright (C) 2001 Matt Kraai <kraai@alumni.carnegiemellon.edu>
Copyright (C) Andre Masella <andre@masella.no-ip.org>
Copyright (C) 1990-1999 Free Software Foundation, Inc.
Copyright (c) 2007 Bernhard Reutner-Fischer
Copyright (C) 2004 Kay Sievers <kay.sievers@vrfy.org>
Copyright (C) 91, 1995-2002 Free Software Foundation, Inc.
Copyright (C) 2003 Glenn L. McGrath
Copyright (C) 2001 by Matt Kraai <kraai@alumni.carnegiemellon.edu>
Copyright (C) 2000 by Randolph Chung <tausq@debian.org>
Copyright (C) 2001, 2002, 2003, 2004, 2005 Free Software Foundation.
Copyright (C) 89, 91, 1995-2006 Free Software Foundation, Inc.:(C) 2007 by Tito Ragusa <farmatito@tiscali.it>
Copyright (C) 2004 Peter Willis <psyphtreak@phreaker.net>
Copyright (c) 1987,1997, Prentice Hall All rights reserved.
Copyright (C) 2000,2001 Matt Kraai <kraai@alumni.carnegiemellon.edu>
Copyright (c) 2006 Bernhard Reutner-Fischer
Copyright (c) 1990 The Regents of the University of California. All rights reserved.
Copyright (C) 1996 Brian Candler <B.Candler@pobox.com>
Copyright (c) 1989 The Regents of the University of California. All rights reserved.
Copyright (c) 1980 The Regents of the University of California. All rights reserved.
Copyright (C) 2008 by Timo Teras <timo.teras@iki.fi>
Copyright (C) 1994,1996 Alessandro Rubini (rubini@ipvvis.unipv.it)
Copyright (c) 2008 Bernhard Reutner-Fischer
Copyright (C) 2009 Malek Degachi <malek-degachi@laposte.net>
Copyright (C) 2008 Timo Teras <timo.teras@iki.fi>
Copyright (C) 2016 by Bartosz Golaszewski <bartekgola@gmail.com>
Copyright (C) 2017 by <assafgordon@gmail.com>
Copyright (c) 2008 Pascal Bellard

Copyright (C) 2002 Matt Kraai.
Copyright (c) 1987, 1988 Regents of the University of California. All rights reserved.
Copyright (c) 2008 Timo Teras <timo.teras@iki.fi>
Copyright (c) 2008 Nuovation System Designs, LLC Grant Erickson <gerickson@nuovations.com>
Copyright (C) 1999-2004 by Erik Andersen <andersen@codepoet.org> and Ron Alder <alder@lineo.com>
Copyright (c) 2008 Vladimir Dronnikov
Copyright (c) 2009 Bernhard Reutner-Fischer
Copyright (C) 2010 Sergey Naumov <sknaumov@gmail.com>
Copyright (C) 2010 by Grigory Batalov <bga@altlinux.org>
Copyright (C) 1994-1998 Andries E. Brouwer <aeb@cw.nl>
Copyright (C) 1992 A. V. Le Blanc (LeBlanc@mcc.ac.uk)
Copyright (C) 2010 Kevin Cernekee <cernekee@gmail.com>
Copyright (C) 2004,2005 Enrik Berkhan <Enrik.Berkhan@inka.de>
Copyright (C) 2000 and written by Emanuele Caratti <wiz@iol.it> Adjusted a bit by Erik Andersen <andersen@codepoet.org> Unified with fdfush by Tito Ragusa <farmatito@tiscali.it>
Copyright (C) 2007 Loic Grenie <loic.grenie@gmail.com> written using Andries Brouwer <aeb@cw.nl>'s kbd_mode from console-utils v0.2.3, licensed under GNU GPLv2
Copyright (c) 1997, 1998, 1999, 2000 Frodo Looijaard <frodol@dds.nl>
Copyright 2005 Rob Landley <rob@landley.net>
Copyright (C) 2006 by Jan Kiszka <jan.kiszka@web.de>
Copyright (C) 2010 Timo Teras <timo.teras@iki.fi>
Copyright (C) 1999-2004 by Erik Andersen <andersen@codepoet.org> Written by Erik Andersen and Kent Robotti <robotti@metconnect.com>
Copyright (C) 2008 Denys Vlasenko.
Copyright (C) 1998 Enrique Zanardi <ezanardi@ull.es>
Copyright 2005 H. Peter Anvin Busybox'ed (2014) by Pascal Bellard <pascal.bellard@ads-lu.com>
Copyright (C) 1999 by Randolph Chung <tausq@debian.org>;(c) 1995-1999 by: Geert Uytterhoeven (Geert.Uytterhoeven@cs.kuleuven.ac.be)
Copyright (C) Arne Bernin <arne@matrix.loopback.org>
Copyright (C) 2008 by Patricia Muscalu <patricia.muscalu@axis.com>
Copyright 2006 Bernhard Reutner-Fischer
Copyright 2006 Rob Landley <rob@landley.net>
Copyright (C) 1999,2000,2001 by Lineo, inc. and Mark Whitley
Copyright (c) 2002 Manuel Novoa III <mjn3@codepoet.org>
(C) 2002,2003 by Vladimir Oleynik <dzo@simtreas.ru>
Copyright (C) 2005 Bernhard Reutner-Fischer
Copyright (C) 1993, 1994 Remy Card <card@masi.ibp.fr> Laboratoire MASI, Institut Blaise Pascal Universite Pierre et Marie Curie (Paris VI)
(C) 1991, 1992 Linus Torvalds.
Copyright (C) 1993, 1994, 1995, 1996, 1997, 1998, 1999, 2000, 2001, 2002, 2003, 2004, 2005 by Theodore Ts'o.
Copyright (C) Andreas Neuper, Sep 1998.
Copyright (C) 2008 by <u173034@informatik.uni-oldenburg.de>
(c) 2007 by Yuichi Nakamura <ynakam@hitachisoft.jp>
Copyright (c) 2006-2007 Bernhard Reutner-Fischer
Copyright 2015 Denys Vlasenko
Copyright (C) 2002 Robert Griebel <griebel@gmx.de>
Copyright (C) 1999-2005 by Erik Andersen <andersen@codepoet.org>
Copyright (c) 2017 Denys Vlasenko <vda.linux@gmail.com>
Copyright (C) Andreas Neuper, Sep 1998.
Copyright (C) KaiGai Kohei <kaigai@ak.jp.nec.com>
Copyright 2002 Andi Kleen, SuSE Labs.
Copyright 2005 Rob Landley <rob@landley.net>
Copyright (C) 2015 by Ari Sundholm <ari@tuxera.com> and Tuxera Inc.
Copyright (C) 2006 - 2007 KaiGai Kohei <kaigai@kaigai.gr.jp>
Copyright (C) 2010 Marek Polacek <mmpolacek@gmail.com>
Copyright (C) 2010 by Matheus Izvekov <mizvekov@gmail.com>
Copyright (C) 1993-2002 Werner Almesberger

LICENCE TERMS (cont.)

Copyright 2008-2009 Matt Mackall <mpm@selenic.com>
Copyright (C) 2002 by Dmitry Zakharov <dmit@crp.bank.gov.ua>
Copyright (c) 2002 by David I. Bell Permission is granted to use, distribute, or modify this source,
Copyright 2007 Rob Landley <rob@landley.net>
Copyright (C) 2007 Loic Grenie <loic.grenie@gmail.com>
Copyright (C) 2000,2001 by Matt Kraai <kraai@alumni.carnegiemellon.edu>
(C) Eero Tamminen <oak at welho dot com>
Copyright (C) 2003 Glenn McGrath
Copyright (C) 2000, 2001 Sterling Huxley <sterling@europa.com>;(c) isprint_asciionly(c) endif
Copyright 2004 Tony J. White
Copyright 1999 George Staikos
Copyright (C) 2007 Denys Vlasenko <vda.linux@googlemail.com>
Copyright (C) 2001 by Michael Habermann <mhhabermann@gmx.de>;(C) Mar 16, 2003 Manuel Novoa III (mjn3@codepoet.org)
Copyright (C) 2012 by Sven Oliver 'SvOlli' Moll <svolli@svolli.de>
Copyright (c) 2004 Nicholas Miell ported from procps by Pere Orga <gotrunks@gmail.com> 2011
Copyright (C) 2009 Denys Vlasenko.
Copyright (C) 2010 Nokia Corporation. All rights reserved. Written by Alexander Shishkin <virtuoso@slind.org>
Copyright 2005 Rob Landley <rob@landley.net>
Copyright 2006 by Natanael Copa <n@tanael.org> Licensed under GPLv2, see file LICENSE in this source tree.
copyrighted by many authors between 1998-2015. Licensed under GPLv2. See source distribution for detailed
Copyright 2005 by Rob Landley <rob@landley.net> Licensed under GPLv2, see file LICENSE in this source tree.
Copyright 2008 by Denys Vlasenko <vda.linux@googlemail.com> Licensed under GPLv2, see file LICENSE in this source tree.
Copyright 2008 by Denys Vlasenko Licensed under GPLv2, see file LICENSE in this source tree.
Copyright (C) 2003,2004 Free Software Foundation, Inc. Contributed by Kelley Cook, June 2004. Original code from Neil Booth, May 2003.
Copyright (C) 2014 Tito Ragusa <farmatito@tiscali.it>
Copyright 2006 by Mike Frysinger <vapier@gentoo.org> Licensed under GPLv2, see file LICENSE in this source tree.
Copyright 2017 by Denys Vlasenko <vda.linux@googlemail.com> Licensed under GPLv2, see file LICENSE in this source tree.
Copyright 2009 by Denys Vlasenko Licensed under GPLv2, see file LICENSE in this source tree.
Copyright 2010 by Denys Vlasenko Licensed under GPLv2, see file LICENSE in this source tree.
Copyright 2007 by Denys Vlasenko <vda.linux@googlemail.com> Licensed under GPLv2, see file LICENSE in this source tree.
Copyright 2018 by Denys Vlasenko Licensed under GPLv2 or later, see file LICENSE in this source tree.
Copyright 2018 by Denys Vlasenko <vda.linux@googlemail.com> Licensed under GPLv2, see file LICENSE in this source tree.
Copyright 2011 by Denys Vlasenko Licensed under GPLv2, see file LICENSE in this source tree.
Copyright 2007 by Denys Vlasenko Licensed under GPLv2, see file LICENSE in this source tree.
Copyright 2005 by Rob Landley
Copyright 2006 by Erik Hovland <erik@hovland.org> Licensed under GPLv2, see file LICENSE in this source tree.
Copyright 2015 by Bernhard Reutner-Fischer Licensed under GPLv2 or later, see file LICENSE in this source tree.
Copyright 2007 by Bernhard Reutner-Fischer Licensed under GPLv2 or later, see file LICENSE in this source tree.
Copyright 2006 by Rob Landley <rob@landley.net> Licensed under GPLv2, see file LICENSE in this source tree.
Copyright (c) 2001 David Schleef <ds@schleef.org>
Copyright 2002 by Kai Gernaschewski <kai.gernaschewski@gmx.de>
Copyright 2006 Bernhard Reutner-Fischer Licensed under GPLv2 or later, see file LICENSE in this source tree.
Copyright 2004 Matt Mackall <mpm@selenic.com>;(c) 1997 by Andi Kleen
Copyright (C) 2002 Khalid Aziz <khalid_aziz at hp.com>
Copyright Joern Engel <joern@lazybastard.org> Inspired by Linus Torvalds Original idea maybe from Keith Owens s390 port and big speedup by Arnd Bergmann <arnd@bergmann-dalldorf.de> Mips port by Juan Quintela <quintela@mandrakesoft.com> IA64 port via Andreas Dilger Arm port by Holger Schu
Copyright 2006 Rob Landley <rob@landley.net> Licensed under GPLv2 or later, see file LICENSE in this source tree.
Copyright (C) 2002-2003 Romain Lievin <roms@tilp.info> Released under the terms of the GNU GPL v2.0.

Copyright 2018 Thomas De Schampheleire <thomas.de_schampheleire@nokia.com> Licensed under GPLv2 or later, see file LICENSE in this source tree.
Copyright (C) 2002 Roman Zippel <zippel@linux-m68k.org> Released under the terms of the GNU GPL v2.0.
Copyright 2009 by Denys Vlasenko <vda.linux@googlemail.com> Licensed under GPLv2, see file LICENSE in this source tree.
Copyright 2005 by Bernhard Reutner-Fischer Licensed under GPLv2, see file LICENSE in this source tree.
Copyright (C) 2002-2005 Roman Zippel <zippel@linux-m68k.org>
Copyright 2010 Nokia Corporation Written by Alexander Shishkin Licensed under GPLv2 or later, see file LICENSE in this source tree.
Copyright 2014 by Denys Vlasenko <vda.linux@googlemail.com> Licensed under GPLv2, see file LICENSE in this source tree.
copyright (c) 2001 by glenn mcgrath
(c) 2002 Glenn McGrath
Copyright (C) 1996..2003 Markus Franz Xaver Johannes Oberhumer All Rights Reserved.
Copyright (C) 2002 Roman Zippel <zippel@linux-m68k.org> Released under the terms of the GNU GPL v2.0.
Copyright (C) 1984, 1989, 1990, 2000, 2001, 2002, 2003, 2004 Free Software Foundation, Inc.
Copyright (C) 2001 by Laurence Anderson
Copyright (C) 1992-1993 Jean-loup Gailly.
Copyright (C) 2004 by Ed Clark
Copyright (C) 2001,2002 by Laurence Anderson
Copyright (C) 2001 by Glenn McGrath
Copyright (C) 2002 by Glenn McGrath
Copyright (C) 1999 by Lineo, inc. and John Beppu
Copyright (C) 2000 by spoon <spoon@ix.netcom.com> Written by spoon <spon@ix.netcom.com>
Copyright (C) 2010 Denys Vlasenko <vda.linux@googlemail.com> Licensed under GPLv2, see file LICENSE in this source tree.
Copyright (C) 1996-2006 Julian Seward <jseward@bzip.org>
Copyright (C) 2008 by Denys Vlasenko <vda.linux@gmail.com>
Copyright (C) 2001 by Gennady Feldman <gfeldman@gena01.com>. Changes: Made this a standalone busybox module which uses standalone syslog() client interface.
copyright (C) 1996-2006 Julian R Seward. All rights reserved.
Copyright (C) 2000 by Gennady Feldman <gfeldman@gena01.com>
Copyright (C) 2006 Aurelien Jacobs <aurel@gnuage.org>
Copyright (c) 2017 Denys Vlasenko <vda.linux@googlemail.com>
Copyright 2002 Laurence Anderson
Copyright (C) 2008 Markus Franz Xaver Johannes Oberhumer
Copyright 2001 Glenn McGrath.
Copyright (C) 2006 Aurelien Jacobs <aurel@gnuage.org>
(c) 2002 Robert Griebel
Copyright (C) 1989, 1991 Free Software Foundation, Inc. 51 Franklin St, Fifth Floor, Boston, MA 02110-1301 USA
Everyone is permitted to copy and distribute verbatim copies of this license document, but changing it is not allowed.
Copyright (C) 2010 Denys Vlasenko
copyright information (GPLv2)
Copyright (C) 2015 Denys Vlasenko
Copyright (C) 2005 by Tito Ragusa <tito-wolit@tiscali.it>
Copyright (c) 2009 by Dan Fandrich <dan@coneharvesters.com>, et. al.
Copyright (C) 2003 Glenn McGrath
Copyright (C) 2007 by Stephane Billiard <stephane.billiard@gmail.com>
Copyright (C) many different people. If you wrote this, please acknowledge your work.
Copyright (C) 2006 Denys Vlasenko
Copyright 2011, Denys Vlasenko
Copyright 2003, Glenn McGrath
Copyright (C) 2014 Bartosz Golaszewski <bartekgola@gmail.com>
Copyright (c) 1992, 1993 The Regents of the University of California. All rights reserved.
Copyright (c) 1986-2003 may safely be consumed by a BSD or GPL license. Written by: Vladimir Oleynik <dzo@simtreas.ru>;(c) 1995 Erik Andersen <andersen@codepoet.org> (Majorly adjusted for busybox);(c) isspace(c) if ENABLE_FEATURE_EDITING_VI static bool BB_isalnum_or_underscore(CHAR_T c);(c) ispunct(c) endif if

LICENCE TERMS (cont.)

ENABLE_UNICODE_PRESERVE_BROKEN define unicode_mark_raw_byte(wc) ((wc) | 0x20000000) define unicode_is_raw_byte(wc) ((wc) & 0x20000000) else define unicode_is_raw_byte(wc) 0 endif;(c) bb_putchar(c) Should never be called: */ int adjust_width_and_validate_wc(unsigned *width_adj, int wc); endif
Copyright 1989 - 1991, Julianne Frances Haugh <jockgrl@austin.rr.com> All rights reserved.
Copyright (C) 2013 Denys Vlasenko;(c) ((c) == '_' || isalpha((unsigned char)(c)));(c) ((c) == '_' || isalnum((unsigned char)(c)))
Copyright (C) tons of folks. Tracking down who wrote what isn't something I'm going to worry about... If you wrote something here, please feel free to acknowledge your work.
Copyright (C) 1992, 1996 Free Software Foundation, Inc. Written by David MacKenzie <djm@gnu.ai.mit.edu>.
Copyright (C) 2008 Bernhard Reutner-Fischer
Copyright (C) 2014 by Fugro Intersite B.V. <m.stam@fugro.nl>
Copyright (C) 2006 Tito Ragusa <farmatito@tiscali.it>
Copyright (C) Vladimir N. Oleynik <dzo@simtreas.ru>
Copyright (C) 2010 Denys Vlasenko
Copyright (C) 2005, 2006 Rob Landley <rob@landley.net>
Copyright (C) 2003-2005 Vladimir Oleynik <dzo@simtreas.ru>
Copyright (C) 2001 Matt Kraai <kraai@alumni.carnegiemellon.edu>.
Copyright 2007 KaiGai Kohei <kaigai@kaigai.gr.jp>
Copyright 2012, Denys Vlasenko
Copyright (c) 1994 David Burren All rights reserved.
Copyright (C) 2001 by Matt Kraai <kraai@alumni.carnegiemellon.edu> SELinux support by Yuichi Nakamura <ynakam@hitachisoft.jp>
Copyright (C) Manuel Novoa III <mjn3@codepoet.org> and Vladimir Oleynik <dzo@simtreas.ru>
Copyright (C) 1991-2, RSA Data Security, Inc. Created 1991. All rights reserved.
Copyright (C) 2001 Larry Doolittle, <ldoolitt@recycle.lbl.gov>
Copyright 1998 by Albert Cahalan
Copyright (c) 2008 Denys Vlasenko
Copyright (C) (C) 2003 Vladimir Oleynik <dzo@simtreas.ru>
Copyright (c) 1989 The Regents of the University of California. All rights reserved.
Copyright (C) 2006 Gabriel Somlo <somlo at cmu.edu>
Copyright (C) 2016 Denys Vlasenko
Copyright (C) 2003 Bastian Blank <waldi@tuxbox.org>
Copyright (C) 2008 Denys Vlasenko
Copyright (C) 2008 Natanael Copa <natanael.copa@gmail.com>
Copyright (C) 2008 Tito Ragusa <farmatito@tiscali.it>
Copyright (C) 2006 by Rob Sullivan <cogito.ergo.cogito@gmail.com> I can't really claim much credit however, as the algorithm is very well-known)
Copyright (C) 2008 Rob Landley <rob@landley.net>
Copyright (C) 2014-2019 Free Software Foundation, Inc. Copying and distribution of this script, with or without modification,
Copyright (C) 1991, 1992 Linus Torvalds
Copyright (C) 1999-2004 by Erik Andersen <andersen@codepoet.org> Adjusted by so many folks, it's impossible to keep track.
Copyright (C) 2001 by Emanuele Aina <emanuele.aina@tiscali.it>
Copyright (C) 1996 Jeff Noxon <jeff@router.patch.net>,
Copyright (C) 1996-1999 Guy Maor <maor@debian.org>
Copyright (C) 2006 Gabriel Somlo <somlo at cmu.edu>
Copyright (c) 1997-2005 Herbert Xu <herbert@gondor.apana.org.au> was re-ported from NetBSD and debianized.
Copyright (c) 2001 Aaron Lehmann <aaronl@vitelus.com>
copyright(c) 2004 to support dynamic variables.
copyright(c) 2001-2005 to be used in busybox and size optimizations, rewrote arith (see notes to this), added locale support, rewrote dynamic variables.
copyright(C) 2003 Vladimir Oleynik <dzo@simtreas.ru>
Copyright (c) 1989, 1991, 1993, 1994 The Regents of the University of California. All rights reserved.
copyright notice, this list of conditions and the following disclaimer in the documentation and/or other materials provided with the distribution. 3. Neither the name of the University nor the names of its contributors may be used to endorse or promote products derived from this

Copyright (c) 1997-2005 Herbert Xu <herbert@gondor.apana.org.au> was re-ported from NetBSD and debianized.
Copyright (c) 2001 Aaron Lehmann <aaronl@vitelus.com>
Copyright(c) 2004 to support dynamic variables.
Copyright(c) 2001-2005 to be used in busybox and size optimizations, rewrote arith (see notes to this), added locale support, rewrote dynamic variables.
Copyright(C) 2003 Vladimir Oleynik <dzo@simtreas.ru>
Copyright (c) 1989, 1991, 1993, 1994 The Regents of the University of California. All rights reserved.
copyright notice, this list of conditions and the following disclaimer in the documentation and/or other materials provided with the distribution. 3. Neither the name of the University nor the names of its contributors may be used to endorse or promote products derived from this
Copyright (c) 2010 Denys Vlasenko Split from ash.c
Copyright (c) 2013-2015 INSIDE Secure Corporation
Copyright (c) PeerSec Networks, 2002-2011 All Rights Reserved
Copyright (c) PeerSec Networks, 2002-2011 All Rights Reserved
Copyright (C) 2003 Bernardo Innocenti <bernie@develer.com>
Copyright (C) 1999 Hewlett-Packard Co
Copyright (C) 1999 David Mosberger-Tang <davidm@hpl.hp.com>
Copyright (c) 1997-2005 Herbert Xu <herbert@gondor.apana.org.au> was re-ported from NetBSD and debianized.
Copyright (C) 2008,2009 Denys Vlasenko <vda.linux@googlemail.com>
Copyright (C) 1999-2004 by Erik Andersen <andersen@codepoet.org> written by Erik Andersen <andersen@codepoet.org>. That, in turn, is based in part on ladsh.c, by Michael K. Johnson and Erik W. Troan, which they placed in the public domain. I don't know how much of t
Copyright: 2006, 2007 Stefan Rompf <sux@loplof.de>. License: GPL v2.
copyright 0 otherwise assuming ascii char codes, as the original implementation did) */
Copyright (C) 1987, 1989, 1991 Free Software Foundation, Inc.
Copyright (C) 2003 Vladimir Oleynik <dzo@simtreas.ru>
Copyright (C) 1987, 1989, 1991 Free Software Foundation, Inc.
Copyright (C) 2003 Vladimir Oleynik <dzo@simtreas.ru>
Copyright (C) 2002 Mario Strasser <mast@gmx.net>, Zuercher Hochschule Winterthur, Netbeat AG Upstream has GPL v2 or later
Copyright (C) 2000 Jean-Pierre Lefebvre <helix@step.polymtl.ca> and Remi Lefebvre <remi@debian.org>
Copyright (C) 1999 Uwe Ohse <uwe@ohse.de>
Copyright (C) 2001 Hewlett-Packard Laboratories
Copyright (C) 2005 Odd Arild Olsen (oao at fibula dot no)
Copyright (C) 2003 Paul Sheer
Copyright (C) [2003] by [Matteo Croce] <3297627799@wind.it>
Copyright (C) 1998-2002 Richard Gooch
Copyright (C) 1998-2000 Richard Gooch
Copyright (C) 1997-1999 Richard Gooch
Copyright (C) 2000 Lennert Buytenhek
Copyright (C) 2006 Bernhard Reutner-Fischer <busybox@busybox.net>
Copyright (C) 2008 Darius Augulis <augulis.darius@gmail.com>
Copyright 1994-1996 Donald Becker
Copyright (C) 2008, BusyBox Team. -solar 4/26/08 Licensed under GPLv2 or later, see file LICENSE in this source tree.
Copyright (C) 2004 by David Brownell
copyright(c) 2008 */
Copyright (c) 1983,1991 The Regents of the University of California. All rights reserved.
copyright notice, this list of conditions and the following disclaimer in the documentation and/or other materials provided with the distribution. 3. All advertising materials mentioning features or use of this software must display the following acknowledgement: This pr
Copyright(c) 2008 */
Copyright (c) 1983,1991 The Regents of the University of California. All rights reserved.
copyright notice, this list of conditions and the following disclaimer in the documentation and/or other materials provided with the distribution. 3. All advertising materials mentioning features or use of this software must display the following acknowledgement: This pr
Copyright (C) 1998 Dave Cinege

LICENCE TERMS (cont.)

copyright(C) 2003 correct "-" option usage multiple "-u unsetenv" support GNU long option support use xfunc_error_retval
Copyright (c) 1988, 1993, 1994 The Regents of the University of California. All rights reserved.
Copyright(C) 2003 correct "-" option usage multiple "-u unsetenv" support GNU long option support use xfunc_error_retval
Copyright (c) 1988, 1993, 1994 The Regents of the University of California. All rights reserved.
Copyright 2006 Bernhard Reutner-Fischer
Copyright (C) 2005 by Mike Frysinger <vapier@gentoo.org>
Copyright (C) 1999-2007 Free Software Foundation, Inc. v, --verbose verbose debug output c FILE, --config=FILE use FILE as configuration file h HOST, --host=HOST explicitly query HOST n, --no-redirect disable content redirection s, --no-whoisserve
Copyright (C) 2003-2006 Vladimir Oleynik <dzo@simtreas.ru>
Copyright (C) 2005 by Erik Andersen <andersen@codepoet.org>
Copyright (C) 2002 Glenn McGrath
Copyright (C) 1995, 1996, 1997, 1998, 2000 Free Software Foundation, Inc.
Copyright (C) 2006-2017 wolfSSL Inc.
Copyright (c) 2003, 2004 Henning Brauer <henning@openbsd.org>
Copyright (c) 2004 Alexander Guy <alexander.guy@andern.org>
Copyright (c) University of Delaware 1992-2009
Copyright (c) 2003, 2004 Henning Brauer <henning@openbsd.org>
Copyright (c) 2004 Alexander Guy <alexander.guy@andern.org>
Copyright (c) University of Delaware 1992-2009
Copyright (c) 2003-2004 Erik Andersen <andersen@codepoet.org>
Copyright (c) 1999 Anthony Towns <aj@azure.humbug.org.au>
Copyright (C) 1999,2000,2001 by John Beppu <beppu@codepoet.org>
Copyright (C) 2017 Jo-Philipp Wich <jo@mein.io>
Copyright (C) 2015 by Ari Sundholm <ari@tuxera.com>
Copyright (C) 2008 Nokia Corporation. All rights reserved.
Copyright (c) 1989 The Regents of the University of California. All rights reserved.
Copyright (C) 1999 by Randolph Chung <tausq@debian.org>
Copyright (c) 1989 The Regents of the University of California. All rights reserved.
Copyright (C) 1999 by Randolph Chung <tausq@debian.org>
Copyright (c) 1991, 1993 The Regents of the University of California. All rights reserved.
Copyright (c) 1991, 1993 The Regents of the University of California. All rights reserved.
Copyright (C) 2002 Edward Betts <edward@debian.org>
Copyright (C) 2006 Rob Landley <rob@landley.net>
Copyright (c) 2000 Edward Betts <edward@debian.org>.
Copyright (C) 2003-2005 Vladimir Oleynik <dzo@simtreas.ru> reduced 464 bytes. 64 math support
Copyright (C) 2007 Natanael Copa <natanael.copa@gmail.com>
Copyright (C) 2007 Tito Ragusa <farmatito@tiscali.it>
copyright (C) 1990-1996 Free Software Foundation, Inc.
Copyright (C) 2012 S-G Bergh <sgb@systemasis.org>
Copyright (C) 2003 Glenn McGrath
Copyright (C) 2009 Vladimir Dronnikov <dronnikov@gmail.com>
Copyright (C) 2003-2004 Erik Andersen
Copyright (C) 2005 Tobias Klausner <tklausner@access.unizh.ch>
Copyright (C) 2008 by Tito Ragusa <farmatito@tiscali.it>
Copyright(C) 2004 to handle usernames of whatever length and to be more similar to GNU id. Z option support: by Yuichi Nakamura <ynakam@hitachisoft.jp>
Copyright(C) 2008 for SUSv3.
Copyright (C) 2005 by Mike Frysinger <vapier@gentoo.org>
Copyright (C) 2006 by Yoshinori Sato <ysato@users.sourceforge.jp>
Copyright (C) 2005 Tito Ragusa <farmatito@tiscali.it>
Copyright (c) Michiel Huisjes
Copyright (c) 1990 The Regents of the University of California. All rights reserved.
Copyright (c) 1990 The Regents of the University of California. All rights reserved.
Copyright 2006 Bernhard Reutner-Fischer <rep.nop@aon.at>

Copyright(c) 2008 Timo Teras <timo.teras@iki.fi>
Copyright (c) 2008 Vladimir Dronnikov
Copyright (C) 2008 by Vladimir Dronnikov <dronnikov@gmail.com>
Copyright (C) 2008 Timo Teras <timo.teras@iki.fi>
Copyright (C) 2005 by Rob Landley <rob@landley.net>
Copyright 1996, 1997 Linux International. I've only tested the code on mpc8xx platforms in big-endian mode. Did some cleanup and added USE_xxx_ENTRIES...
Copyright 1996, 1997 Linux International. Contributed by Ralf Baechle <ralf@gnu.ai.mit.edu>
Copyright 1996, 1997 Linux International. New implementation contributed by Richard Henderson <rth@tamu.edu>
Based on original work by Bjorn Ekwall <bj0rn@blox.se> Restructured (and partly rewritten) by: Björn Ekwall <bj0rn@blox.se> February 1999
Copyright 1996, 1997 Linux International.
Copyright 1996, 1997 Linux International.
Copyright (c) 2008 Bernhard Reutner-Fischer (initial depmod code)
Copyright (C) 2001,2002 Vladimir Oleynik <dzo@simtreas.ru> (initial bb port)
Copyright (C) 2008 Bernhard Reutner-Fischer
Copyright (C) 1999-2004 by Erik Andersen <andersen@codepoet.org>
Copyright (C) 2005-2006 by Rob Landley <rob@landley.net>
Copyright (C) 1993 Rick Sladkey <jrs@world.std.com>
Copyright (C) 1999-2004 by Erik Andersen <andersen@codepoet.org>
Copyright (C) 1999,2000,2001 by Mark Whitley <markw@codepoet.org>
Copyright(C) Vladimir Oleynik <dzo@simtreas.ru> - correction "-e pattern1 -e pattern2" logic and more optimizations. precompiled regex
Copyright(C) 2006 Jac Goudsmit added -o option
Copyright (c) 1989, 1993, 1994 The Regents of the University of California. All rights reserved.
Copyright (c) 1989, 1993, 1994 The Regents of the University of California. All rights reserved.
Copyright (C) 1993, 1994 Theodore Ts'o. Also licensed under GPL.
Copyright (C) 2007 by KaiGai Kohei <kaigai@kaigai.gr.jp>
Copyright (C) Andreas Neuper, Sep 1998. This file may be modified and redistributed under the terms of the GNU Public License.
Copyright 2005 Frank Sorenson <frank@tuxrocks.com>
Copyright (C) 2006 by Robert Sullivan <cogito.ergo.cogito@hotmail.com>
Copyright (c) 2003 Todd C. Miller <Todd.Miller@courtesan.com>
Copyright (C) 2002-2009 Craig Small
Copyright (C) 2010 Lauri Kasanen
Copyright (C) 2002 Matt Kraai
Copyright (C) 2003 by Glenn McGrath
Copyright (C) 2003,2004 by Rob Landley <rob@landley.net>
Copyright(C) 2002 <dzo@simtreas.ru>
Copyright (c) 1992 Branko Lankester
Copyright (c) 1992 Roger Binns
Copyright (C) 1994-1996 Charles L. Blake.
Copyright (C) 1992-1998 Michael K. Johnson
Copyright (C) 2001, 2002 Matt Kraai
copyright (C) 1997 by Vernon Hoxie. Linux HOWTO documents may be reproduced and distributed in whole or in part, in any medium physical or electronic, as long as
copyright (C) 1997 by Vernon Hoxie. Linux HOWTO documents may be reproduced and distributed in whole or in part, in any medium physical or electronic, as long as
Copyright (C) [YEAR] by [YOUR NAME] <YOUR EMAIL>
Copyright 2006 Glenn McGrath Licensed under GPLv2, see file LICENSE in this source tree.
Copyright (c) 2001 Erik Andersen <andersen@codepoet.org>
Copyright (c) 2001 Stuart Hughes <seh@zee2.com>
Copyright (c) 2002 Steven J. Hill <shill@broadcom.com>
Copyright (c) 2006 Freescale Semiconductor, Inc <stuarth@freescale.com>
Copyright (c) 2001 David Schleeff <ds@schleeff.org>
Copyright (c) 2006 Freescale Semiconductor, Inc <stuarth@freescale.com>
Copyright (C) 2002 Randy Dunlap <rddunlap@osdl.org>

LICENCE TERMS (cont.)

Copyright (C) 2002 Al Stone <ahs3 at fc.hp.com>
Copyright (C) 2002 Hewlett-Packard Company
copyright (c) 2002 Romain Lievin <roms@lpg.ticalc.org>. \n" Based on the source code from Roman Zippel.\n"
Copyright (C) 2002-2005 Sam Ravnborg <sam@ravnborg.org>
copyright (c) 1995 Ian Jackson <ian@chiark.greenend.org.uk>
Copyright (C) 2002 Roman Zippel <zippel@linux-m68k.org> Released under the terms of the GNU GPL v2.0.
Copyright (C) 1992-1993 Jean-loup Gailly.
Copyright (C) 1992-1993 Jean-loup Gailly The unzip code was written and put in the public domain by Mark Adler.
Portions of the lzw code are derived from the public domain 'compress' written by Spencer Thomas, Joe Orost, James Woods, Jim McKie, Steve Davies, Ken Turkowski, Dave Mack and
Copyright (C) 2006 Aurelien Jacobs <aurel@gnuage.org>
Copyright (C) 2002 Roman Zippel <zippel@linux-m68k.org>. \n"
Copyright (C) 2010 Nokia Corporation. All rights reserved. Written by Alexander Shishkin.
Copyright (C) 1992-1993 Jean-loup Gailly This is free software
Copyright (c) 1999 by David I. Bell Permission is granted to use, distribute, or modify this source,
Copyright (C) 1995 Bruce Perens
Copyright (C) 2001 by Laurence Anderson
Copyright (C) 1999,2000,2001 by John Beppu <beppu@codepoet.org>
Copyright (C) 2007 by Tito Ragusa <farmatito@tiscali.it>
Copyright (c) 1983, 1993 The Regents of the University of California. All rights reserved.
Copyright (c) 1983, 1993 The Regents of the University of California. All rights reserved.
Copyright (C) 2000 by Karl M. Hegbloom <karlheg@debian.org>
Copyright (C) 2000 by Gennady Feldman <gfeldman@gena01.com>
Copyright (C) 2001 by Gennady Feldman <gfeldman@gena01.com>
Copyright (C) 2007 Markus Franz Xaver Johannes Oberhumer
Copyright (C) 2006 Markus Franz Xaver Johannes Oberhumer
Copyright (C) 2005 Markus Franz Xaver Johannes Oberhumer
Copyright (C) 2004 Markus Franz Xaver Johannes Oberhumer
Copyright (C) 2003 Markus Franz Xaver Johannes Oberhumer
Copyright (C) 2002 Markus Franz Xaver Johannes Oberhumer
Copyright (C) 2001 Markus Franz Xaver Johannes Oberhumer
Copyright (C) 2000 Markus Franz Xaver Johannes Oberhumer
Copyright (C) 1999 Markus Franz Xaver Johannes Oberhumer
Copyright (C) 1998 Markus Franz Xaver Johannes Oberhumer
Copyright (C) 1997 Markus Franz Xaver Johannes Oberhumer
Copyright (C) 1996 Markus Franz Xaver Johannes Oberhumer All Rights Reserved.
Copyright (C) 1992-1993 Jean-loup Gailly The unzip code was written and put in the public domain by Mark Adler.
Portions of the lzw code are derived from the public domain 'compress' written by Spencer Thomas, Joe Orost, James Woods, Jim McKie, Steve Davies, Ken Turkowski, Dave Mack and
Copyright (C) 1999-2005 Igor Pavlov
copyright the software, and 2) offer you this license which gives you legal permission to copy, distribute and/or modify the software.
Copyright (C) <year> <name of author>
Copyright (C) year name of author Gnomovision comes with ABSOLUTELY NO WARRANTY
copyright the software, and 2) offer you this license which gives you legal permission to copy, distribute and/or modify the software.
Copyright (C) <year> <name of author>
Copyright (C) year name of author Gnomovision comes with ABSOLUTELY NO WARRANTY
Copyright (C) 2005 Free Software Foundation, Inc. memchr() is a GNU function that might not be available everywhere. It's basically the inverse of memchr() - search backwards in a memory block for a particular character.
Copyright (c) 1999, 2000 The ht://Dig Group */ char* FAST_FUNC strcasestr(const char *s, const char *pattern)
Copyright (C) 2004 Free Software Foundation, Inc. */ char* FAST_FUNC strsep(char **stringp, const char *delim)
Copyright (C) 2005 Vladimir Oleynik
Copyright (C) 2005 Bernhard Reutner-Fischer
Copyright (C) 2008 by Tito Ragusa <farmatito@tiscali.it>
Copyright 2006, Rob Landley <rob@landley.net>
Copyright 2010, Denys Vlasenko

copyright notice, this list of conditions and the following disclaimer in the documentation and/or other materials provided with the distribution. 3. Neither the name of Julianne F. Haugh nor the names of its contributors may be used to endorse or promote products derived from t
Copyright (c) 1999 by David I. Bell Permission has been granted to redistribute this code under GPL.
copyrighted by many authors between 1998-2015.\n" Licensed under GPLv2. See source distribution for detailed\n"
Copyright (c) 1999 by David I. Bell Permission has been granted to redistribute this code under GPL.
copyrighted by many authors between 1998-2015.\n" Licensed under GPLv2. See source distribution for detailed\n"
Copyright (C) 2003 Russ Dill <Russ.Dill@asu.edu>
Copyright (c) 1991, 1993 The Regents of the University of California. All rights reserved.
Copyright (C) 1995-1999 Free Software Foundation, Inc.
Copyright (C) 2001 Manuel Novoa III
Copyright (C) 2003 Glenn L. McGrath
Copyright (C) 2003 Erik Andersen
Copyright 2007 Rob Landley <rob@landley.net>
copyright and related or neighboring rights to the source code in this file. <http://creativecommons.org/publicdomain/zero/1.0/>
copyright(C) Lauri Kasanen, under the GPLv2.
Copyright (C) 1995-1999 Free Software Foundation, Inc.
Copyright (C) 2001 Manuel Novoa III
Copyright (C) 2003 Glenn L. McGrath
Copyright (C) 2003 Erik Andersen
Copyright 2007 Rob Landley <rob@landley.net>
copyright and related or neighboring rights to the source code in this file. <http://creativecommons.org/publicdomain/zero/1.0/>
Copyright(C) Lauri Kasanen, under the GPLv2.
Copyright (C) 2004 Erik Andersen <andersen@codepoet.org>
Copyright (C) 2001 Matt Krai
copyright notice, this list of conditions and the following disclaimer in the documentation and/or other materials provided with the distribution. 3. Neither the name of the author nor the names of other contributors may be used to endorse or promote products derived from this s
Copyright (C) 2006 Rob Landley
Copyright (C) 2006 Denys Vlasenko
Copyright (C) 2002 by Vladimir Oleynik <dzo@simtreas.ru>
Copyright(c) 2007 by Yuichi Nakamura <ynakam@hitachisoft.jp>
Copyright (C) 2008 Denys Vlasenko <vda.linux@googlemail.com>
Copyright (c) 2006, 2008 Junio C Hamano
copyright 1997 to 1999 by Joey Hess.
Copyright (C) YEAR THE PACKAGE'S COPYRIGHT HOLDER. Atila KOÇ <akoc@artielektronik.com.tr>, 2012.
Copyright (C) 2007 Carlos Lisboa <carloslisboa@gmail.com> Carlos Lisboa <carloslisboa@gmail.com>, 2007.
Miguel Figueiredo <elmig@debianpt.org>, 2007-2011.
Copyright (C) 2011 Martin Bagge <brother@bsnet.se>
Copyright (C) 2011 ca-certificates & nedenstående oversættelse. Claus Hindsgaul <claus.hindsgaul@gmail.com>, 2004, 2006. Joe Hansen <joedalton2@yahoo.dk>, 2010, 2011.
Copyright (c) 2003 Fumitoshi UKAI <ukai@debian.or.jp>
Copyright (C) 2003 Ilgiz Kalmetyev <translator@ilgiz.pp.ru>
Copyright (C) 2009 Philipp Kern <pkern@debian.org>
Copyright © 2007 Free Software Foundation, Inc. Clytie Siddall <clytie@riverland.net.au>, 2005-2007.
Copyright (C) YEAR THE PACKAGE'S COPYRIGHT HOLDER
Copyright (C) 2016 THE ca-certificates COPYRIGHT HOLDER. Translator: Izharul Haq <atoz.chevara@yahoo.com>, 2016.
Copyright (c) 2004, 2010, 2011 Software in the Public Interest, Inc.
© Draszik <andre.draszik@jci.com>
Copyright (C) 2005-2007 Software in the Public Interest
Copyright (C) 2006, 2007 Debian French I10n team <debian-i10n-french@lists.debian.org>
Copyright (C) 2011 THE PACKAGE'S COPYRIGHT HOLDER.Frans Pop <aragorn@tiscali.nl>, 2004, 2006. Frans Pop <elendil@planet.nl>, 2007. Jeroen Schot <schot@a-eskwadmaat.nl>, 2011.
Copyright (C) 2011 THE ca-certificates'S COPYRIGHT HOLDER ;© Luis Lopes <andreloup@debian.org>, 2006.

LICENCE TERMS (cont.)

Adriano Rafael Gomes <adrianorg@gmail.com>, 2011.
(c) 1999 VeriSign, Inc.
Copyright: 2003 Fumitoshi UKAI <ukai@debian.or.jp> 2009 Philipp Kern <pkern@debian.org> 2011 Michael Shuler <michael@pbandjelly.org>
Copyright: 1994-2000 Netscape
Copyright: 2003 Fumitoshi UKAI <ukai@debian.or.jp> 2009 Philipp Kern <pkern@debian.org> 2011 Michael Shuler <michael@pbandjelly.org>
Copyright (C) 2011 THE ca-certificates'S COPYRIGHT HOLDER. Automatically generated, 2011. Slavko <linux@slavino.sk>, 2011.
Copyright: 2013 System Administrator <root@localhost.localdomain>
Copyright (c) 2009 Philipp Kern <pkern@debian.org>
Copyright (C) 2007 Mikhail Gusarov <dottedmag@dottedmag.net> Yuri Kozlov <yuray@komyakino.ru>, 2011.
Copyright(c) 1999 VeriSign, Inc.
Copyright(c) 1999 VeriSign, Inc.
Copyright(c) 1999 Entrust.net Limited,OU=www.entrust.net/CPS_2048 incorp.
Copyright(c) 1999 Entrust.net Limited,OU=www.entrust.net/CPS_2048 incorp.
Copyright(c) 2006 Entrust, Inc.
Copyright(c) 2006 thawte, Inc.
Copyright(c) 2006 VeriSign, Inc.
Copyright (c) 2005,O=WISKey,C=CH
Copyright(c) 2008 GeoTrust Inc.
Copyright(c) 2007 thawte, Inc.
Copyright(c) 2008 thawte, Inc.
Copyright(c) 2008 thawte, Inc.
Copyright(c) 2007 GeoTrust Inc.
Copyright(c) 2008 VeriSign, Inc.
Copyright(c) 2008 VeriSign, Inc.
Copyright(c) 2007 VeriSign, Inc.
Copyright(c) 2007 VeriSign, Inc.
Copyright(c) 2009 Entrust, Inc.
Copyright(c) 2012 Entrust, Inc.
Copyright (C) 1989, 1991 Free Software Foundation, Inc.
Copyright (c) 2010,2011 Nikos Mavrogiannopoulos <nnav@gnutls.org>
Copyright (c) 2004 Michal Ludvig <mludvig@logix.net.nz>, SuSE Labs
Copyright (c) 2011, 2012 OpenSSL Software Foundation, Inc.
Copyright (c) 2011 Maxim Levitsky
Copyright (C) 2011 by Phil Sutter <phil.sutter@viprinet.com>
Copyright (C) 2010 by Phil Sutter <phil.sutter@viprinet.com>
Copyright (c) 2009-2013 Nikos Mavrogiannopoulos <nnav@gnutls.org>
Copyright (C) 2011 Free Software Foundation, Inc.
Copyright (c) 2006, 2008 Junio C Hamano
Copyright (c) 2010 Michael Weiser
Copyright (c) 2010 Phil Sutter
Copyright (c) 2009-2013 Nikos Mavrogiannopoulos <nnav@gnutls.org>
Copyright (c) 2009,2010,2011 Nikos Mavrogiannopoulos <nnav@gnutls.org>
Copyright (c) 2010 Phil Sutter
Copyright (c) 2011, 2012 OpenSSL Software Foundation, Inc.
Copyright (C) 1994 X Consortium
Copyright (C) 1996-2015 Free Software Foundation, Inc. This is free software
Copyright (C) 1999-2018 Free Software Foundation, Inc. Written by Tom Tromey <tromey@cygnus.com>.
Copyright 1992-2019 Free Software Foundation, Inc.
Copyright (C) 1999-2018 Free Software Foundation, Inc.
Copyright (C) 2004-2005, 2007, 2009, 2011-2015 Free Software Foundation, Inc. Written by Scott James Remnant, 2004.
Copyright (C) 2004, 2011-2015 Free Software Foundation, Inc. Written by Scott James Remnant, 2004
Copyright (C) 1996-2001, 2003-2015 Free Software Foundation, Inc. Written by Gordon Matzigkeit, 1996
Copyright (C) 2004-2005, 2007-2008, 2011-2015 Free Software Foundation, Inc. Written by Gary V. Vaughan, 2004

Copyright (C) 2004-2005, 2007-2009, 2011-2015 Free Software Foundation, Inc. Written by Gary V. Vaughan, 2004
Copyright (C) 1996-2018 Free Software Foundation, Inc. Originally written by Fran,cois Pinard <pinard@iro.umontreal.ca>, 1996.
Copyright (C) 2003 Red Hat, Inc.
Copyright (C) 2003 Red Hat, Inc.
Copyright © 2010-2011 Nokia Corporation
Copyright (C) 2003, 2004 Red Hat, Inc.
Copyright (C) 2005 g10 Code GmbH
Copyright (C) 2006 Red Hat, Inc.
Copyright (C) 2002 Red Hat Inc.
Copyright (C) 2007 Red Hat, Inc.
Copyright (C) 2005 Red Hat, Inc.
Copyright (C) 2002, 2003 Red Hat, Inc.
Copyright (C) 2002, 2006 Red Hat Inc.
Copyright (C) 2003 Red Hat Inc.
Copyright (C) 2003 CodeFactory AB
Copyright © 2003, 2004 Red Hat, Inc.
Copyright (C) 2003 CodeFactory AB
Copyright © 2011 Nokia Corporation
Copyright © 2014-2015 Canonical, Ltd.
Copyright (C) 2003 Red Hat Inc.
Copyright (C) 2004 Red Hat, Inc.
Copyright (C) 2002, 2003 Red Hat, Inc.
Copyright (C) 2002, 2003, 2006 Red Hat, Inc.
Copyright (C) 1994-2018 Free Software Foundation, Inc.
Copyright (C) 2002 Red Hat, Inc.
Copyright (C) 2004, 2005 Red Hat, Inc.
Copyright (C) 2003, 2004 Red Hat Inc.
Copyright (C) 2003 Red Hat, Inc.;(c) 2006 Mandriva
Copyright (C) 2003, 2005 Red Hat, Inc.
Copyright (C) 2002, 2003, 2006 Red Hat, Inc.:(c) ((DBusCondVar*) c)
Copyright (C) 2002, 2003 CodeFactory AB
Copyright © 2011-2012 Nokia Corporation
Copyright (C) 2002, 2003 Red Hat Inc.
Copyright (C) 2003, 2004, 2007 Red Hat, Inc.
Copyright (C) 2007 Red Hat Inc.
Copyright (C) 2005 Red Hat Inc.
Copyright (C) 2002, 2003, 2004, 2005 Red Hat, Inc.
Copyright (C) 2002, 2005 Red Hat Inc.
Copyright (C) 2002, 2003, 2004 Red Hat Inc.
Copyright (C) 2002, 2003, 2004, 2006 Red Hat Inc.
Copyright © 2014-2015 Canonical, Ltd.
Copyright (C) 2002, 2003, 2004, 2005 Red Hat Inc.
Copyright (C) 2002 Red Hat, Inc.
Copyright © 2003 Philip Blundell <philb@gnu.org>
Copyright © 2014-2015 Collabora Ltd.
Copyright (C) 2007 Ralf Habacker <ralf.habacker@freenet.de>
Copyright (c) 1992, 1993 The Regents of the University of California. All rights reserved.
Copyright (C) 2003 Philip Blundell <philb@gnu.org>
Copyright (C) 2002, 2004 Red Hat Inc.
Copyright (C) 2003, 2004, 2005 Red Hat, Inc.
Copyright (C) 2003 Philip Blundell <philb@gnu.org>
Copyright (C) 2002, 2003, 2004 Red Hat, Inc.
Copyright (C) 2006 Red Hat, Inc.
Copyright © 2003-2006 Red Hat, Inc.
Copyright (C) 2006 Thiago Macieira <thiago@kde.org>
Copyright (C) 2003, 2006 Red Hat, Inc.

LICENCE TERMS (cont.)

Copyright (C) 1994-1996, 1999-2002, 2004-2016 Free Software Foundation, Inc.
Copyright (C) 1996-2018 Free Software Foundation, Inc.
Copyright (C) 2002 CodeFactory AB
Copyright (C) 1992-1996, 1998-2012 Free Software Foundation, Inc.
Copyright (C) 2008, Benjamin Reed <rangerrick@befunk.com>
Copyright (C) 2015 Ralf Habacker <ralf.habacker@freenet.de>
Copyright © 2017 Collabora Ltd.
Copyright © 2018 KPIT Technologies Ltd.
Copyright (C) 2009 Klaralvdalens Datakonsult AB, a KDAB Group company, info@kdab.net;(C) FSF include "dbus-nonce.h" include "dbus-internals.h" include "dbus-protocol.h" include "dbus-sysdeps.h"
Copyright (C) 2009 Klaralvdalens Datakonsult AB, a KDAB Group company, info@kdab.net
Copyright (C) 2002, 2003, 2004, 2005 Red Hat Inc.
Copyright (C) 2002, 2003, 2004 Red Hat Inc.
Copyright (C) 2002 Red Hat Inc.
Copyright © 2006 Red Hat Inc.
Copyright (C) 2005 Red Hat, Inc.:(c) \;(c) \;(c) \;(c) \
Copyright © 2010-2012 Nokia Corporation
Copyright (C) 2002, 2004 Red Hat Inc.
Copyright © 2016 Collabora Ltd.
Copyright © 2013 Intel Corporation
Copyright © 2013 Intel Corporation
Copyright © 2011 Nokia Corporation
Copyright (C) 2003, 2005 Red Hat Inc.
Copyright (C) 2007, Tanner Lovelace <lovelace@wayfarer.org>
Copyright (C) 2002-2006 Red Hat Inc.
Copyright (C) 2002, 2003, 2006 Red Hat Inc.
Copyright (C) 2005 Novell, Inc.
Copyright (C) 2002, 2003, 2005 Red Hat Inc.
Copyright (C) 2011-2018 Free Software Foundation, Inc.
Copyright (C) 2011 Free Software Foundation, Inc.
Copyright (C) 2008, 2009 Free Software Foundation, Inc.
Copyright (c) 2012, 2016 Philip Withnall
Copyright © 2004 Scott James Remnant <scott@netsplit.com>.
Copyright (c) 2009 Tom Howard <tomhoward@users.sf.net>
Copyright (C) 2005, 2008, 2010-2014 Free Software Foundation, Inc.
Copyright (c) 2009 Allan Caffee <allan.caffee@gmail.com>
(C) 2003, 2004, 2005 Thomas Vander Stichele <thomas at apestaart dot org>
Copyright (c) 2008 Tom Howard <tomhoward@users.sf.net>
Copyright (c) 2008 Laurent Montel, <montel@kde.org>
Copyright (c) 2011, Raphael Kubo da Costa <kubito@gmail.com>
Copyright (c) 2006-2007, Ralf Habacker
Copyright (C) 2003 Red Hat, Inc. -->
Copyright (C) 2003,2008 Red Hat, Inc. -->
Copyright (C) 2006 Red Hat, Inc.
Copyright (C) 2005 Lennart Poettering.
Copyright (C) YEAR COPYRIGHT HOLDER
Copyright (C) 2004-2015 Free Software Foundation, Inc. This is free software
Copyright (C) 2010-2015 Free Software Foundation, Inc. This is free software
Copyright 1992-2019 Free Software Foundation, Inc.
Copyright (C) 2014 Free Software Foundation, Inc. This is free software
Copyright (C) 2011 Free Software Foundation, Inc. This config.lt script is free software
Copyright (C) 2002, 2003 Red Hat, Inc., CodeFactory AB, and others\n" This is free software
Copyright © 2015 Collabora Ltd.
Copyright © 2015 Collabora Ltd.
Copyright (C) 2003 CodeFactory AB
Copyright (C) 2006 Ralf Habacker <ralf.habacker@freenet.de>
Copyright (C) 2003, 2004, 2005 Red Hat, Inc.

Copyright (C) 2004 Imendio HB
Copyright © 2011 Nokia Corporation
Copyright (C) 1995 A. M. Kuchling
Copyright (C) 1995, A.M. Kuchling
Copyright (C) 2003 Red Hat, Inc.
Copyright (C) 2003 CodeFactory AB
Copyright (C) 2005 Novell, Inc.
Copyright (C) 2006 Ralf Habacker <ralf.habacker@freenet.de>
Copyright (C) 2006 Peter Kummel <syntheticpp@gmx.net>
Copyright (C) 2006 Christian Ehrlicher <ch.ehrlicher@gmx.de>
Copyright (C) 2005 Novell, Inc.
Copyright (C) 2003 Red Hat Inc.
Copyright (C) 2003, 2004, 2005 Red Hat, Inc.
Copyright (C) 2004, 2005 Red Hat, Inc.
Copyright © 2012-2013 Collabora Ltd.
Copyright (C) 2003 Red Hat, Inc.
Copyright (C) 2007 Ralf Habacker <ralf.habacker@freenet.de>
Copyright © 2015 Collabora Ltd.
Copyright (C) 2003-2004 Lawrence E. Rosen. All rights reserved.
Copyright (C) 1989, 1991 Free Software Foundation, Inc.
Copyright (C) year name of author Gnomovision comes with ABSOLUTELY NO WARRANTY
Copyright (C) 2003-2004 Lawrence E. Rosen. All rights reserved. Permission is hereby granted to copy and distribute this license without modification. This license may not be modified without
Copyright (C) 1989, 1991 Free Software Foundation, Inc. 51 Franklin Street, Fifth Floor, Boston, MA 02110-1301 USA
Copyright (C) year name of author Gnomovision comes with ABSOLUTELY NO WARRANTY
Copyright (c) 1991-1993 The Regents of the University of California.
Copyright (c) 1994 Sun Microsystems, Inc.
Copyright (c) 1991-1993 The Regents of the University of California.
Copyright (c) 1994 Sun Microsystems, Inc.
Copyright © 2011 Nokia Corporation
Copyright © 2014 Collabora Ltd.
Copyright (C) 2006 Red Hat, Inc.\n" This is free software
Copyright © 2006 Thiago Macieira <thiago@kde.org>
Copyright © 2011-2012 Nokia Corporation
Copyright (C) 2003-2006 Red Hat, Inc.\n"
Copyright (C) 2006 Thiago Macieira\n"
Copyright © 2011-2012 Nokia Corporation\n"
Copyright (C) 2002 Michael Meeks
Copyright (C) 2003 Red Hat, Inc.\n"
Copyright (C) 2002 Michael Meeks\n" This is free software
Copyright (C) 2006 Christian Ehrlicher <ch.ehrlicher@gmx.de>
Copyright (C) 2006-2013 Ralf Habacker <ralf.habacker@freenet.de>
Copyright (C) 2002, 2003 Red Hat, Inc.
Copyright 2004 Eric Poech
Copyright 2004 Robert Shearman
Copyright (C) 2006 Thiago Macieira <thiago@kde.org>
Copyright (C) 2003 Red Hat, Inc.\n" This is free software
Copyright (c) 2011 Maarten Bosmans <mbosmans@gmail.com>
Copyright (c) 2008 Guido U. Draheim <guidod@gmx.de>
Copyright (c) 2011 Rhys Ulerich <rhys.ulerich@gmail.com>
Copyright (c) 2014, 2015 Philip Withnall <philip@tecnocode.co.uk>
Copyright (c) 2008 John Darrington <j.darrington@elvis.murdoch.edu.au>
Copyright (c) 2015 Enrico M. Crisostomo <enrico.m.crisostomo@gmail.com>
Copyright (c) 2015 David King <amigadave@amigadave.com>
Copyright (c) 2017, 2018 Reini Urban <rurban@cpan.org>
Copyright (c) 2015 Philip Withnall <philip@tecnocode.co.uk>

LICENCE TERMS (cont.)

Copyright (c) 2014 Mike Frysinger <vapier@gentoo.org>
Copyright (C) 2002-2018 Free Software Foundation, Inc.
Copyright (C) 2001-2018 Free Software Foundation, Inc.
Copyright (C) 1997-2018 Free Software Foundation, Inc.
Copyright (C) 1999-2018 Free Software Foundation, Inc.
Copyright (C) 1996-2018 Free Software Foundation, Inc.
Copyright (C) 2003-2018 Free Software Foundation, Inc.
Copyright (C) 2009-2018 Free Software Foundation, Inc.
Copyright (C) 2006-2018 Free Software Foundation, Inc.
Copyright (C) 2004-2018 Free Software Foundation, Inc.
copyright(C) 2003, 2004, 2005 Thomas Vander Stichele <thomas at apestaart dot org>
Copyright (c) 2009 Allan Caffee <allan.caffee@gmail.com>
Copyright (c) 2009 Tom Howard <tomhoward@users.sf.net>
Copyright (c) 2012, 2016 Philip Withnall
Copyright (c) 2012 Xan Lopez
Copyright (c) 2012 Christian Persch
Copyright (c) 2012 Paolo Borelli
Copyright (c) 2012 Dan Winship
Copyright (c) 2015,2018 Bastien ROUCARIES
Copyright (c) 2008 Tom Howard <tomhoward@users.sf.net>
Copyright (C) 2008, 2009 Free Software Foundation, Inc. dnl This file is free software
Copyright (C) 1996-2001, 2003-2015 Free Software Foundation, Inc. Written by Gordon Matzigkeit, 1996
Copyright (C) 2014 Free Software Foundation, Inc. This is free software
Copyright (C) 2011 Free Software Foundation, Inc. This config.lt script is free software
Copyright (C) 2004-2005, 2007-2009, 2011-2015 Free Software Foundation, Inc. Written by Gary V. Vaughan, 2004
Copyright (C) 2004-2005, 2007-2008, 2011-2015 Free Software Foundation, Inc. Written by Gary V. Vaughan, 2004
Copyright (C) 2004, 2011-2015 Free Software Foundation, Inc. Written by Scott James Remnant, 2004
Copyright (C) 2004-2005, 2007, 2009, 2011-2015 Free Software Foundation, Inc. Written by Scott James Remnant, 2004.
Copyright © 2004 Scott James Remnant <scott@netsplit.com>.
Copyright (C) 2005, 2008, 2010-2014 Free Software Foundation, Inc. dnl This file is free software
Copyright (c) 2011 Maarten Bosmans <mbosmans@gmail.com>
Copyright (c) 2008 Guido U. Draheim <guidod@gmx.de>
Copyright (c) 2011 Rhys Ulerich <rhys.ulerich@gmail.com>
Copyright (c) 2014, 2015 Philip Withnall <philip@tecnocode.co.uk>
Copyright (c) 2008 John Darrington <j.darrington@elvis.murdoch.edu.au>
Copyright (c) 2015 Enrico M. Crisostomo <enrico.m.crisostomo@gmail.com>
Copyright (c) 2015 David King <amigadave@amigadave.com>
Copyright (c) 2017, 2018 Reini Urban <rurban@cpan.org>
Copyright (c) 2015 Philip Withnall <philip@tecnocode.co.uk>
Copyright (c) 2014 Mike Frysinger <vapier@gentoo.org>
Copyright (C) 2002-2018 Free Software Foundation, Inc.
Copyright (C) 2001-2018 Free Software Foundation, Inc.
Copyright (C) 1997-2018 Free Software Foundation, Inc.
Copyright (C) 1999-2018 Free Software Foundation, Inc.
Copyright (C) 1996-2018 Free Software Foundation, Inc.
Copyright (C) 2003-2018 Free Software Foundation, Inc.
Copyright (C) 2009-2018 Free Software Foundation, Inc.
Copyright (C) 2006-2018 Free Software Foundation, Inc.
Copyright (C) 2004-2018 Free Software Foundation, Inc.
Copyright(C) 2003, 2004, 2005 Thomas Vander Stichele <thomas at apestaart dot org>
Copyright (c) 2009 Allan Caffee <allan.caffee@gmail.com>
Copyright (c) 2009 Tom Howard <tomhoward@users.sf.net>
Copyright (c) 2012, 2016 Philip Withnall
Copyright (c) 2012 Xan Lopez
Copyright (c) 2012 Christian Persch
Copyright (c) 2012 Paolo Borelli

Copyright (c) 2012 Dan Winship
Copyright (c) 2015,2018 Bastien ROUCARIES
Copyright (c) 2008 Tom Howard <tomhoward@users.sf.net>
Copyright (C) 2008, 2009 Free Software Foundation, Inc. dnl This file is free software
Copyright (C) 1996-2001, 2003-2015 Free Software Foundation, Inc. Written by Gordon Matzigkeit, 1996
Copyright (C) 2004-2005, 2007-2009, 2011-2015 Free Software Foundation, Inc. Written by Gary V. Vaughan, 2004
Copyright (C) 2004-2005, 2007-2008, 2011-2015 Free Software Foundation, Inc. Written by Gary V. Vaughan, 2004
Copyright (C) 2004, 2011-2015 Free Software Foundation, Inc. Written by Scott James Remnant, 2004
Copyright (C) 2004-2005, 2007, 2009, 2011-2015 Free Software Foundation, Inc. Written by Scott James Remnant, 2004.
Copyright © 2004 Scott James Remnant <scott@netsplit.com>.
Copyright (C) 2005, 2008, 2010-2014 Free Software Foundation, Inc. dnl This file is free software
Copyright (C) 2012 Free Software Foundation, Inc. This configure script is free software
Copyright (C) 2012 Free Software Foundation, Inc. This config.status script is free software
Copyright © 2012 Collabora Ltd.
Copyright © 2012 Collabora Ltd.
Copyright © 2013-2015 Collabora Ltd.
Copyright © 2013-2015 Collabora Ltd.
Copyright (C) 2003, 2004 Red Hat, Inc.
Copyright © 2018 Manish Narang <manrock007@gmail.com>
Copyright © 2018 Collabora Ltd.
Copyright (C) 2002, 2003 CodeFactory AB
Copyright © 2017 Shin-ichi MORITA <shin1morita@gmail.com>
Copyright © 2017 Shin-ichi MORITA <shin1morita@gmail.com>
Copyright © 2014 Collabora Ltd.
Copyright © 2014 Collabora Ltd.
Copyright (C) 2008, Colin Walters <walters@verbum.org>
Copyright (C) 2008-2009, Benjamin Reed <rangerrick@befunk.com>
Copyright (C) 2009, Jonas Bähr <jonas.baehr@web.de>
Copyright (C) 2008, Colin Walters <walters@verbum.org>
Copyright (C) 2008-2009, Benjamin Reed <rangerrick@befunk.com>
Copyright (C) 2004,2005 Red Hat, Inc.
Copyright (c) 2015,2018 Bastien ROUCARIES
Copyright (c) 2013 Ralf Habacker, <ralf.habacker@freenet.de>
Copyright (c) 2006, Tim Beaulen <tbscope@gmail.com>
Copyright (C) 1994 X Consortium
Copyright (C) 1999-2018 Free Software Foundation, Inc. Written by Tom Tromey <tromey@cygnus.com>.
Copyright 1992-2019 Free Software Foundation, Inc.
Copyright (C) 1999-2018 Free Software Foundation, Inc.
Copyright (C) 1996-2018 Free Software Foundation, Inc. Originally written by Fran,cois Pinard <pinard@iro.umontreal.ca>, 1996.
Copyright (C) 1994-2018 Free Software Foundation, Inc.
Copyright (C) 1988 Landon Curt Noll & Ronald S. Karr
Copyright 1994 by Ian Jackson.
Copyright (C) 1995 - 1998, Ian A. Murdock <imurdock@debian.org>
Copyright (C) 1987, 1988 Ronald S. Karr and Landon Curt Noll
Copyright (C) 1996-2018 Free Software Foundation, Inc.
Copyright (C) 1992-1996, 1998-2012 Free Software Foundation, Inc.
Copyright (C) 2011 Aurelien Jarno <aurel32@debian.org>
Copyright (C) YEAR Free Software Foundation, Inc.
Copyright (C) 1996 Jeff Noxon <jeff@router.patch.net>
Copyright (C) 2014 the debianutils copyright holder
Copyright (C) 2017 Free Software Foundation, Inc.
Copyright © of Polish translation: translation of which.1 for PTM project: Przemek Borys <pborys@dione.ids.pl>, 1999.
Copyright (C) 2011 - 2012 Software in the Public Interest
Copyright (C) Helge Kreutzmann <debian@helgefjell.de>, 2011, 2012, 2017, 2018.

LICENCE TERMS (cont.)

Copyright (c) 2010 Rosetta Contributors and Canonical Ltd 2010
Copyright (C) 2010 Free Software Foundation, Inc. KURASAWA Nozomu <netabaro@debian.or.jp>, 2012.
Copyright (C) 2004-2011 Software in the Public Interest.
Copyright (c) 1990, 1993 The Regents of the University of California. All rights reserved.
Copyright 1992-2019 Free Software Foundation, Inc.
Copyright (C) 1992 Ronald S. Karr Copyleft (GNU) 1988 Landon Curt Noll & Ronald S. Karr
Copyright(C) 1988 Landon Curt Noll & Ronald S. Karr
Copyright 1996 by Jeff Noxon. More
Copyright(C) 1994 Ian Jackson.
Copyright(C) 1996 Jeff Noxon.
Copyright(C) 1996, 1997, 1998 Guy Maor
Copyright(C) 2002, 2003, 2004, 2005, 2006, 2007, 2008, 2009 Clint Adams
Copyright (C) 1998, 1999, Guy Maor
Copyright (C) 2002, Matthew Wilcox
Copyright (C) 2002, 2004, 2005, 2007, 2009 Clint Adams
Copyright (C) 2009 Manoj Srivasta
Copyright (C) 1992 Ronald S. Karr Slight modifications by Ian A. Murdock <imurdock@gnu.ai.mit.edu>
Copyright (C) 2002-2018 Free Software Foundation, Inc.
Copyright (C) 2001-2018 Free Software Foundation, Inc.
Copyright (C) 1997-2018 Free Software Foundation, Inc.
Copyright (C) 1999-2018 Free Software Foundation, Inc.
Copyright (C) 1996-2018 Free Software Foundation, Inc.
Copyright (C) 2003-2018 Free Software Foundation, Inc.
Copyright (C) 2009-2018 Free Software Foundation, Inc.
Copyright (C) 2006-2018 Free Software Foundation, Inc.
Copyright (C) 2004-2018 Free Software Foundation, Inc.
Copyright (C) 2012 Free Software Foundation, Inc.
Copyright 1996 by Jeff Noxon. More
Copyright (C) 1994 Ian Jackson.
Copyright (C) 1996 Jeff Noxon.
Copyright (C) 1996, 1997, 1998 Guy Maor
Copyright (C) 2002, 2003, 2004, 2005, 2006, 2007, 2008, 2009 Clint Adams
copyright© software livre
Copyright 1996 by Jeff Noxon. More
Copyright (C) 1994 Ian Jackson.
Copyright (C) 1996 Jeff Noxon.
Copyright (C) 1996, 1997, 1998 Guy Maor
Copyright (C) 2002, 2003, 2004, 2005, 2006, 2007, 2008, 2009 Clint Adams
COPYRIGHT© software livre
Copyright (C) 1994 Ian Jackson.
Copyright (C) 1996 Jeff Noxon.
Copyright (C) 1996, 1997, 1998 Guy Maor
Copyright (C) 2002, 2003, 2004, 2005, 2006, 2007, 2008, 2009 Clint Adams
Copyright© software livre
Copyright (C) 2015 Andreas Henriksson <andreas@fatal.se>
Copyright (C) 2011 Aurelien Jarno
Copyright (C) 2002, 2003, 2004, 2005, 2006, 2007, 2008, 2009 Clint Adams
Copyright (C) 1994 Ian Jackson.
Copyright (C) 1996 Jeff Noxon.
Copyright (C) 1996, 1997, 1998 Guy Maor
Copyright (C) 2002, 2003, 2004, 2005, 2006, 2007, 2008, 2009 Clint Adams
Copyright (C) 1996-1999 Guy Maor <maor@debian.org>
Copyright (C) 2002-2012 Clint Adams <clint@debian.org>
Copyright (C) 1994 Ian Jackson, Copyright (C) 1996 Jeff Noxon.
Copyright (C) 1996,1997,1998,1999 Guy Maor
Copyright (C) 2002-2012 Clint Adams
Copyright (C) 1994 Ian Jackson."
Copyright (C) 1996 Jeff Noxon."
Copyright (C) 1996, 1997, 1998 Guy Maor"
Copyright (C) 2002, 2003, 2004, 2005, 2006, 2007, 2008, 2009 Clint Adams
Copyright (C) 2002, 2003, 2004, 2005, 2006, 2007, 2008, 2009 Clint Adams"
Copyright (C) 1994 Ian Jackson."
Copyright (C) 1996 Jeff Noxon."
Copyright (C) 1996, 1997, 1998 Guy Maor"
Copyright (C) 2002, 2003, 2004, 2005, 2006, 2007, 2008, 2009 Clint Adams
Copyright (C) 2002, 2003, 2004, 2005, 2006, 2007, 2008, 2009 Clint Adams"
Copyright (C) 2002, 2003, 2004, 2005, 2006, 2007, 2008, 2009 Clint Adams
Copyright (C) 2002, 2003, 2004, 2005, 2006, 2007, 2008, 2009 Clint Adams
Copyright (C) 2002, 2003, 2004, 2005, 2006, 2007, 2008, 2009 Clint Adams
Copyright (C) 2002, 2003, 2004, 2005, 2006, 2007, 2008, 2009 Clint Adams
COPYRIGHT(C) 1994 Ian Jackson."
COPYRIGHT(C) 1996 Jeff Noxon."
COPYRIGHT(C) 1996, 1997, 1998 Guy Maor"
COPYRIGHT(C) 2002, 2003, 2004, 2005, 2006, 2007, 2008, 2009 Clint " Adams"
Copyright(C) 1994 Ian Jackson."
Copyright(C) 1996 Jeff Noxon."
Copyright(C) 1996, 1997, 1998 Guy Maor"
Copyright(C) 2002, 2003, 2004, 2005, 2006, 2007, 2008, 2009 Clint " Adams"
Copyright (c) 2006-2019 Roy Marples <roy@marples.name> All rights reserved;copyright notice, this list of conditions and the following disclaimer.;copyright notice, this list of conditions and the following disclaimer in the documentation and/or other materials provided with the distribution.
Copyright (c) 2006-2014 Roy Marples <roy@marples.name> All rights reserved
Copyright (c) 2005 The DragonFly Project. All rights reserved.
Copyright (c) 1999, 2016 The NetBSD Foundation, Inc. All rights reserved.
Copyright (c) 1990, 1993 The Regents of the University of California. All rights reserved.
Copyright (c) 2008, Damien Miller <djm@openbsd.org>
Copyright (c) 2001 The NetBSD Foundation, Inc. All rights reserved.
Copyright (c) 2007, 2010 The NetBSD Foundation, Inc. All rights reserved.
Copyright (c) 2006-2019 Roy Marples <roy@marples.name> All rights reserved
Copyright (c) 1991, 1993 The Regents of the University of California. All rights reserved.
Copyright (c) 2006-2019 Roy Marples <roy@marples.name>
Copyright (c) 2006-2017 Roy Marples <roy@marples.name> All rights reserved
Copyright (c) 2015 Joerg Sonnenberger <joerg@NetBSD.org>. All rights reserved.
Copyright (c) 2006-2017 Roy Marples All rights reserved
Copyright (c) 1998, 2015 Todd C. Miller <Todd.Miller@courtesan.com>
Copyright (c) 2009-2019 Roy Marples <roy@marples.name> All rights reserved
Copyright 1996 David Mazieres <dm@lcs.mit.edu>.
Copyright (c) 2016 The NetBSD Foundation, Inc. All rights reserved.
Copyright (c) 2006-2019 Roy Marples All rights reserved
Copyright 2005 Colin Percival All rights reserved.
Copyright (c) 2015-2019 Roy Marples <roy@marples.name> All rights reserved
Copyright (c) 2006-2018 Roy Marples All rights reserved
Copyright (c) 2006-2019 Roy Marples <roy@marples.name> All rights reserved.
Copyright (c) 2006-2018 Roy Marples <roy@marples.name> All rights reserved.
Copyright (c) 2006-2018 Roy Marples <roy@marples.name> All rights reserved
Copyright (c) 2016-2019 Roy Marples <roy@marples.name> All rights reserved
Copyright (c) 2006-2015 Roy Marples <roy@marples.name> All rights reserved

LICENCE TERMS (cont.)

Copyright (c) 2003 Citrus Project, All rights reserved.
Copyright (c) 2003 Citrus Project, All rights reserved.
Copyright (C) 1994 X Consortium
Copyright (C) 1996-2015 Free Software Foundation, Inc.
Copyright (C) 1999-2018 Free Software Foundation, Inc. Written by Tom Tromey <tromey@cygnus.com>.
Copyright 1992-2019 Free Software Foundation, Inc.
Copyright (C) 1999-2018 Free Software Foundation, Inc.
Copyright (C) 2004-2005, 2007, 2009, 2011-2015 Free Software Foundation, Inc. Written by Scott James Remnant, 2004.
Copyright (C) 2004, 2011-2015 Free Software Foundation, Inc. Written by Scott James Remnant, 2004
Copyright (C) 1996-2001, 2003-2015 Free Software Foundation, Inc. Written by Gordon Matzigkeit, 1996
Copyright (C) 2004-2005, 2007-2008, 2011-2015 Free Software Foundation, Inc. Written by Gary V. Vaughan, 2004
Copyright (C) 2004-2005, 2007-2009, 2011-2015 Free Software Foundation, Inc. Written by Gary V. Vaughan, 2004
Copyright (C) 1996-2018 Free Software Foundation, Inc. Originally written by Fran,cois Pinard <pinard@iro.umontreal.ca>, 1996.
Copyright (C) 1995-1997, 2000-2007, 2009-2010 by Ulrich Drepper <drepper@gnu.ai.mit.edu>
Copyright 1996-2016 Free Software Foundation, Inc. Taken from GNU libtool, 2001 Originally by Gordon Matzigkeit <gord@gnu.ai.mit.edu>, 1996
Copyright (C) 1989, 1991 Free Software Foundation, Inc.
Copyright (C) 1994-2018 Free Software Foundation, Inc.
Copyright (C) 2009-2012 Free Software Foundation, Inc.
Copyright © 2004 Scott James Remnant <scott@netsplit.com>
Copyright (C) 1996-2018 Free Software Foundation, Inc.
Copyright © 1994-1996 Ian Jackson <ijackson@chiark.greenend.org.uk>
Copyright © 1994,1995 Ian Jackson <ijackson@chiark.greenend.org.uk>
Copyright © 1995 Ian Jackson <ijackson@chiark.greenend.org.uk>
Copyright © 1996 Ian Jackson <ijackson@chiark.greenend.org.uk>
Copyright © 1995 Ian Jackson <ijackson@chiark.greenend.org.uk>
Copyright © 1995,1996 Erick Branderhorst <branderh@debian.org>.
Copyright © 1996 Ian Jackson
Copyright © 1994,1995 Ian Jackson <ijackson@chiark.greenend.org.uk>
Copyright © 1999-2001 Marcus Brinkmann <brinkmd@debian.org>
Copyright © 2007-2014 Software in the Public Interest. Peter Krefting <peter@softwolves.pp.se>, 2007, 2008, 2009, 2010, 2011, 2012, 2014.
Copyright (C) 1999 Software in the Public Interest, Inc.
Copyright © 1995-1998 Ian Jackson <ijackson@chiark.greenend.org.uk>
Copyright © 2006, 2010 Software in the Public Interest, Inc. Jordi Mallach <jordi@debian.org>, 2006, 2010. Guillem Jover <guillem@debian.org>, 2010-2011, 2014-2015, 2017, 2019.
Copyright (C) 2010 -2012 Software in the Public Interest
Copyright © 1996 Andy Guy <awpguy@acs.ucalgary.ca>
(C) Helge Kreutzmann <debian@helgefjell.de>, 2007-2019.
Copyright (C) 2007-2009 Debian French I10n team <debian-i10n-french@lists.debian.org>
Copyright (C) YEAR Dpkg Developers This file is distributed under the same license as the dpkg package. FIRST AUTHOR <EMAIL@ADDRESS>, YEAR.
Copyright © 2005-2008 Dpkg Developers
Copyright © 2001 Joey Hess <joeyh@debian.org>
Copyright (C) 1994-1996 Ian Jackson.
Copyright (C) 2004 Dpkg Developers
Copyright © 2015 Guillem Jover <guillem@debian.org>
Copyright (C) 2004 Free Software Foundation, Inc. Miguel Figueiredo <elmig@debianpt.org>, 2004-2014.
Copyright © 2009 Raphaël Hertzog <hertzog@debian.org>
Copyright (C) 2005, 2006, 2008 Software in the Public Interest, Inc.
Copyright © 1999 Roderick Schertler
Copyright (C) YEAR Dpkg Developers
Copyright © 1999-2014 Software in the Public Interest Daniel Nylander <po@danielnylander.se>, 2006. Peter Krefting <peter@softwolves.pp.se>, 1999, 2000, 2001, 2002, 2003, 2004, 2005, 2006, 2007, 2008, 2009, 2010, 2011, 2012, 2014.
Copyright (C) 2012 dpkg_dselect & nedenstående oversættere.Claus Hindsgaul <claus.hindsgaul@gmail.com>, 2002, 2004, 2005, 2006. reviewed by Ole Laursen <olau@hardworking.dk>, 2002. Joe Hansen <joedalton2@yahoo.dk
Copyright © 2006-2015 Guillem Jover <guillem@debian.org>
Copyright (C) 1999 Michael Sobolev
Copyright (C) 2000, 2001, 2002, 2003, 2004 Free Software Foundation, Inc. Lele Gaifax <lele@seldati.it>, 2000, 2001, 2002, 2003, 2004.
Copyright (C) 2009, 2010, 2012, 2013, 2014 Free Software Foundation Inc. This file is distributed under the same license as the dpkg package. Felipe Castro <fefcas@gmail.com>, 2009, 2010, 2012, 2013, 2014.
Copyright © 2004-2012 Dpkg Developers
Copyright (C) 2014 Software in the Public Interest, Inc. Mert Dirik <mertdirik@gmail.com>, 2014.
Copyright (C) 2003 Software in the Public Interest, Inc. Debian Indonesia L10N Team <debian-l10n-id@gurame.fisika.ui.ac.id>, 2004. Translator: Arief S Fitrianto <arief@gurame.fisika.ui.ac.id>, 2005-2006 Parlin Imanuel <parlin_i@yahoo
Copyright © 2004 Dpkg Developers This file is distributed under the same license as the dpkg package.
Copyrights: Hiweed Leng <hiweed@163.com>, 2004. Kov Chai <tchaikov@gmail.com>, 2005,2006,2007 Ming Hua <minghua@rice.edu>, 2006. Carlos Z.F. Liu <carlosliu@users.sourceforge.net>, 2004,2006. Anthony Wong <ypwong@debian.org.hk>, 2007. Deng Xiyue <manphiz-guest@users.aliases.debian.org>, 20
Copyright (C) 2007 Free Software Foundation, Inc. Ivar Smolin <okul at linux ee>, 2007.
Copyright (C) 1995 Ian Jackson.
Copyright © 2001, 2002, 2003, 2004, 2005, 2006, 2010 Software in the Public Interest, Inc. Antoni Bella <bella5@teletel.es>, 2001, 2002. Jordi Mallach <jordi@debian.org>, 2002, 2003, 2004, 2005, 2006, 2010. Guillem Jover <guillem@debian.org>, 2010, 2012, 2014-2015, 2017, 2019.
Copyright (C) 2004 Free Software Foundation, Inc.
Copyright © 1999-2010 Software in the Public Interest. This file is distributed under the same license as the dpkg package.
Copyright (C) 2005 Software in the Public Interest, Inc.
Copyright © 2004 Dpkg Developers. Safir Šećerović <sapphire@linux.org.ba>, 2004.
Copyright © 2006 Dpkg Developers
Copyright © 2000 Software in the Public Interest. Hartmut Koptein <koptein@debian.org>, Apr 2000. Erich Schubert <debian@vitavonni.de>, March 2001. Michael Piefel <piefel@debian.org>, 2001, 2002, 2003, 2004, 2005. Florian Ernst <florian@uni-hd.de>, 2004. Sven Joachim <svenjoac@gmx.de>
Copyright © 1999-2014 Software in the Public Interest Daniel Nylander <po@danielnylander.se>, 2006, 2008. Peter Krefting <peter@softwolves.pp.se>, 1999, 2000, 2001, 2002, 2003, 2004, 2005, 2006, 2007, 2008, 2009, 2010, 2011, 2012, 2014.
Copyright (C) 1994-1996 Ian Jackson.
Copyright (C) 2014 dpkg og nedenstående oversættere.Claus Hindsgaul <claus_h@image.dk>, 2002, 2004, 2005, 2006. reviewed by Ole Laursen <olau@hardworking.dk>, 2002. Claus Hindsgaul <claus.hindsgaul@gmail.com>, 2006, 2007
Copyright (C) 1994,1995,1996 Ian Jackson <ijackson@chiark.greenend.org.uk>
Copyright (C) 1997 Christophe Le Bars <clebars@debian.org>.
Copyright © 2003-2005 Dpkg Developers This file is distributed under the same license as the dpkg package.
Konstantinos Margaritis <markos@debian.org>, 2003. George Papamichelakis <george@step.gr>, 2004. George Papamichelakis <debian-i10n-greek@lists.debian.org>, 2004. Greek Translation T
Copyright © 2006-2007 Dpkg Developers This file is distributed under the same license as the dpkg package. Kinley Tshering <gasepkuenden2k3@hotmail.com>, 2006. Tshewang Norbu <bumthap2006@hotmail.com>, 2006-2007.
Copyright (C) 2000-2011, 2012, 2013, 2014, 2017, 2018 Free Software Foundation, Inc.
Copyright (C) 2008,2011 Dpkg Developers. Bart Cornelis <cobaco@skolelinux.no>, 2008. Jeroen Schot <schot@a-eskwadraat.nl>, 2011. Frans Spiesschaert <Frans.Spiesschaert@yucom.be>, 2014, 2015.
Copyright © 1999, 2000 Software in the Public Interest. Thiago Jung Bauermann <jungmann@cwmatrix.com.br>, 1999. Carlos Henrique Santos Laviola <claviola@brfree.com.br>, 2000.
Copyright (C) 2005 Eric Pareja.
Copyright © 2009 Guillem Jover <guillem@debian.org>
Copyright (C) 1992-1996, 1998-2012 Free Software Foundation, Inc.
Copyright (C) 2004, 2005, 2006, 2007, 2008, 2009, 2010 Free Software Foundation, Inc.
Copyright (C) 2006, 2007 Free Software Foundation, Inc. Ivar Smolin <okul at linux ee>, 2006, 2007.
Copyright (C) 2010-2018 Free Software Foundation, Inc. Written by Peter Rosin <peda@lysator.liu.se>.

LICENCE TERMS (cont.)

Copyright (C) 1999 Software in the Public Interest, Inc.
Copyright © 2001-2006, 2008-2010, 2012, 2014-2015 Software in the Public Interest, Inc. Antoni Bella <bella5@teleline.es>, 2001-2002. Jordi Mallach <jordi@debian.org>, 2002-2006, 2008-2010, 2015. Jordà Polo <jorda@ettin.org>, 2006. Guillem Jover <guillem@debian.org>, 2006, 2009-2010, 2012
Copyright (C) 2007-2014 Software in the Public Interest, Inc. This file is distributed under the same license as the dpkg package. Theppiak Karoonboonyanan <thep@debian.org>, 2007-2014.
Copyright © 2006 Canonical Ltd, and Rosetta Contributors 2006 This file is distributed under the same license as the dpkg package. Erdal Ronahi <erdal.ronahi@gmail.com>, 2006-2007.
Copyright © 1999-2010 Software in the Public Interest.
Copyright (C) 1995 Ian Jackson.
Copyright (C) YEAR Dpkg Developers This file is distributed under the same license as the dpkg package. FIRST AUTHOR <EMAIL@ADDRESS>, YEAR.
Copyright © 2004 Dpkg Developers. Safir Šećerović <sapphire@linux.org.ba>, 2004.
Copyright © 2019 Dpkg Developers. Hartmut Koptein <koptein@debian.org>, Apr 2000. Erich Schubert <debian@vitavonni.de>, March 2001. Michael Piefel <piefel@debian.org>, 2001-2005. Florian Ernst <florian@uni-hd.de>, 2004. Sven Joachim <svenjoac@gmx.de>, 2006-2019. Holger Wansing <linux@wa
Copyright (C) 2009 Software in the Public Interest, Inc. Marcos Alvarez Costales <marcos.alvarez.costales@gmail.com>, 2009.
Copyright © 2005 Scott James Remnant <scott@netsplit.com>
Copyright © 1995-2003, 2005-2006 Free Software Foundation, Inc.
Copyright (C) 2004-2014, 2016 Free Software Foundation, Inc.
Copyright © 2010-2014 Guillem Jover <guillem@debian.org>
Copyright © 2004 Scott James Remnant <scott@netsplit.com>.
Copyright (C) 2006 Software in the Public Interest, Inc. Attila <sas@321>, 2005. KELEMEN Gabor <kelemeng@gnome> & SZERVÁC, Attila <sas@321> 2006.
Copyright © 2010 Guillem Jover <guillem@debian.org>
Copyright (C) 1987,88,89,90,91,92,93,94,96,97 Free Software Foundation, Inc.
Copyright (C) 1988-1994, 1996-1999,2003,2004,2005,2006 Free Software Foundation, Inc. This file is part of the GNU C Library.
Copyright (C) 2005, 2006 Free Software Foundation, Inc. Written by Simon Josefsson.
Copyright (C) 1987, 88, 89, 90, 91, 92, 93, 94, 95, 96, 97 Free Software Foundation, Inc.
Copyright © 2003-2008 Dpkg Developers
Copyright © 2014 Guillem Jover <guillem@debian.org>
Copyright (c) 2007 Rosetta Contributors and Canonical Ltd 2007. Gintautas Miliauskas <gintas@akl.lt>, 2008. Andrius Kokiančiks <napalm@mintis.lt>, 2008.
Copyright (C) 1995-1998, 2000-2002, 2004-2006 Free Software Foundation, Inc.
Copyright (C) 1988, 1989, 1990, 1991, 1992, 1993, 1994, 1996, 1997, 1998, 1999, 2000, 2001, 2002, 2003, 2004, 2005, 2006 Free Software Foundation, Inc.
Copyright © 2011 Guillem Jover <guillem@debian.org>
Copyright © 2018 Guillem Jover <guillem@debian.org>
Copyright (C) 1989,90,91,92,93,94,96,97 Free Software Foundation, Inc.
Copyright © 1994-2016 Dpkg Developers. Frans Spiesschaert <Frans.Spiesschaert@yucom.be>, 2015, 2016, 2017, 2018, 2019.
Copyright © 2009-2019 Guillem Jover <guillem@debian.org>
Copyright © 2009, 2010 Guillem Jover <guillem@debian.org>
Copyright © 2007 Canonical Ltd Written by Ian Jackson <ijackson@chiark.greenend.org.uk>
Copyright © 1995,1996 Ian Jackson <ijackson@chiark.greenend.org.uk>
Copyright (C) 2005 Eric Pareja This file is distributed under the same license as the package dpkg. Eric Pareja, 2005
Copyright © 2011-2014 Guillem Jover <guillem@debian.org>
Copyright © 1999, 2000 Wichert Akkerman <wakkerma@debian.org>
Copyright © 2010, 2012, 2015 Guillem Jover <guillem@debian.org>
Copyright © 2010-2011, 2014-2015 Guillem Jover <guillem@debian.org>
Copyright © 1995, 1996 Ian Jackson <ijackson@chiark.greenend.org.uk>
Copyright © 2015-2016 Guillem Jover <guillem@debian.org>
Copyright © 2009-2010 Guillem Jover <guillem@debian.org>
Copyright © 2013 Guillem Jover <guillem@debian.org>
Copyright © 2008-2012 Guillem Jover <guillem@debian.org>

Copyright © 2008-2014 Guillem Jover <guillem@debian.org>
Copyright © 2005 Roderick Schertler <roderick@argon.org>
Copyright © 1996 Michael Shields <shields@crosslink.net>
Copyright © 2000-2001 Wichert Akkerman <wakkerma@debian.org>
Copyright © 2009 Romain Francoise <rfrancoise@debian.org>
Copyright © 1995-1996 Ian Jackson <ijackson@chiark.greenend.org.uk>
Copyright © 2008, 2013-2015 Guillem Jover <guillem@debian.org>
Copyright © 2008-2011 Guillem Jover <guillem@debian.org>
Copyright © 1997-1998 Charles Briscoe-Smith
Copyright © 1995 Raul Miller
Copyright © 2009-2012 Guillem Jover <guillem@debian.org>
Copyright © 2009-2010 Raphaël Hertzog <hertzog@debian.org>
Copyright © 1995 Bruce Perens
Copyright © 2005 Marcus Brinkmann <brinkmd@debian.org>
Copyright © 2009 Raphaël Hertzog <hertzog@debian.org>
Copyright © 2012-2013 Guillem Jover <guillem@debian.org>
Copyright © 1995 Juho Vuori <javuori@cc.helsinki.fi>
Copyright © 2016 Guillem Jover <guillem@debian.org>
Copyright © 2007-2011 Raphaël Hertzog <hertzog@debian.org>
Copyright © 2011 Linaro Limited
Copyright © 1996-1998 Ian Jackson and Christian Schwarz
Copyright © 2001 Wichert Akkerman <wakkerma@debian.org>
Copyright © 1995-1996 Erick Branderhorst
Copyright © 2008-2010 Guillem Jover <guillem@debian.org>
Copyright © 2007 Canonical, Ltd. written by Ian Jackson <ijackson@chiark.greenend.org.uk>
Copyright © 2000 Wichert Akkerman <wakkerma@debian.org>
Copyright © 1995, 2008 Ian Jackson <ijackson@chiark.greenend.org.uk>
Copyright © 2010-2012 Guillem Jover <guillem@debian.org>
Copyright © 2008-2012, 2015 Guillem Jover <guillem@debian.org>
Copyright © 2003 Daniel Silverstone <dsilvers@digital-scurf.org>
Copyright © 2009-2011 Guillem Jover <guillem@debian.org>
Copyright © 2009-2011, 2013-2015 Guillem Jover <guillem@debian.org>
Copyright © 2009-2014 Guillem Jover <guillem@debian.org>
Copyright © 2016-2017 Guillem Jover <guillem@debian.org>
Copyright © 2012 Guillem Jover <guillem@debian.org>
Copyright © 1996 Juho Vuori <javuori@cc.helsinki.fi>
Copyright © 2009-2010,2012-2014 Guillem Jover <guillem@debian.org>
Copyright © 1996-1998 Ian Jackson and Christian Schwarz for parts of the text reused from the Debian Policy
Copyright © 2008-2015 Guillem Jover <guillem@debian.org>
Copyright © 2010,2012 Guillem Jover <guillem@debian.org>
Copyright © 1995-1996 Ian Jackson <ian@chiark.chu.cam.ac.uk>
Copyright © 2007-2012 Raphaël Hertzog <hertzog@debian.org>
Copyright © 2010-2012 Raphaël Hertzog <hertzog@debian.org>
Copyright © 2009, 2014 Guillem Jover <guillem@debian.org>
Copyright © 2017 Guillem Jover <guillem@debian.org>
Copyright © 1995-1996 Ian Jackson
Copyright © 2009-2011, 2014-2015 Guillem Jover <guillem@debian.org>
Copyright © 2010-2011 Raphaël Hertzog <hertzog@debian.org>
Copyright © 2013-2016 Guillem Jover <guillem@debian.org>
Copyright © 1999 Klee Dienes <klee@mit.edu>
Copyright © 2010 Oxan van Leeuwen <oxan@oxanvanleeuwen.nl>
Copyright © 2002 Wichert Akkerman <wakkerma@debian.org>
Copyright © 2009,2012 Guillem Jover <guillem@debian.org>
Copyright © 2009-2015 Guillem Jover <guillem@debian.org>
Copyright © 1995 Raul Miller, Ian Jackson, Ian Murdock
Copyright © 2011 Matt Kraai <kraai@ftbfs.org>
Copyright © 2012-2014 Guillem Jover <guillem@debian.org>

LICENCE TERMS (cont.)

Copyright © 1997-1999 Ian Jackson <ijackson@chiark.greenend.org.uk>
Copyright © 2004 Changwoo Ryu <cwryu@debian.org>
Copyright © 2009,2011-2012 Guillem Jover <guillem@debian.org>
Copyright © 2007 Canonical Ltd written by Ian Jackson <ijackson@chiark.greenend.org.uk>
Copyright © 1994, 1995 Ian Jackson <ijackson@chiark.greenend.org.uk>
Copyright © 2004-2005 Scott James Remnant <scott@netsplit.com>
Copyright © 2016 Guillem Jover <guillem@debian.org>
Copyright © 2016 Guillem Jover <guillem@debian.org>
Copyright © 2001 Wichert Akkerman <wakkerma@debian.org>
Copyright © 2007 Canonical Ltd Written by Ian Jackson <ijackson@chiark.greenend.org.uk>
Copyright © 2011, 2018 Guillem Jover <guillem@debian.org>
Copyright © 1994-1995 Ian Jackson <ijackson@chiark.greenend.org.uk>
Copyright © 2011-2015 Guillem Jover <guillem@debian.org>
Copyright © 2013-2015 Guillem Jover <guillem@debian.org>
Copyright © 2008-2015 Guillem Jover <guillem@debian.org>
Copyright © 2009-2010 Raphaël Hertzog <hertzog@debian.org>
Copyright © 2005 Scott James Remnant <scott@netsplit.com>
Copyright © 2009-2012 Guillem Jover <guillem@debian.org>
Copyrights: Zhou Mo <cdluminate@gmail.com>, 2014.
Copyright 1999-2014 Software in the Public Interest Peter Krefting <peter@softwolves.pp.se>, 1999, 2000, 2001, 2002, 2003, 2004, 2005, 2006, 2007, 2008, 2009, 2010, 2011, 2012, 2014.
Copyright (C) 2006 Free Software Foundation, Inc. Yuri Kozlov <kozlov.y@gmail.com>, 2006.
Copyright © 2007, 2011-2015 Guillem Jover <guillem@debian.org>
Copyright © Colin Watson <cjwatson@debian.org>
Copyright © 2009-2010 Modestas Vainius <modax@debian.org>
Copyright © 2007 Raphaël Hertzog <hertzog@debian.org>
Copyright (C) 2012 Free Software Foundation, Inc. Beatrice Torracca <beatrice@libero.it>, 2012, 2013, 2014. Hugh Hartmann <hhartmann@libero.it>, 2000-2012. in base a .po di traduzioni di dpkg, dselect e aptitude half inst
Copyright © 2007-2010 Raphaël Hertzog <hertzog@debian.org>
Copyright © 2002 Adam Heath <doogie@debian.org>
Copyright © 2006 Frank Lichtenheld <djpig@debian.org>
Copyright © 2011 Raphaël Hertzog <hertzog@debian.org>
Copyright © 2007, 2016 Raphaël Hertzog <hertzog@debian.org>
Copyright © 2014-2015 Guillem Jover <guillem@debian.org>
Copyright © 1998 Richard Braakman
Copyright © 2005, 2007 Frank Lichtenheld <frank@lichtenheld.de>
Copyright © 2008 Ian Jackson <ijackson@chiark.greenend.org.uk>
Copyright © 2009-2011 Raphaël Hertzog <hertzog@debian.org>
Copyright © 2008-2010 Raphaël Hertzog <hertzog@debian.org>
Copyright © 2008-2010 Raphaël Hertzog <hertzog@debian.org>
Copyright © 2000 Joey Hess <joeyh@debian.org>
Copyright © 2007 Frank Lichtenheld <djpig@debian.org>
Copyright (C) 2010 - 2012 Software in the Public Interest
Copyright © 2007-2009 Raphaël Hertzog <hertzog@debian.org>
Copyright © 2008-2009 Raphaël Hertzog <hertzog@debian.org>
Copyright © 2010-2011 Raphaël Hertzog <hertzog@debian.org>
Copyright © 2010 Raphaël Hertzog <hertzog@debian.org>
Copyright © 2006-2009, 2012-2015 Guillem Jover <guillem@debian.org>
Copyright © 2008-2011 Raphaël Hertzog <hertzog@debian.org>
Copyright © 2007 Colin Watson <cjwatson@debian.org>
Copyright © 2008-2012 Raphaël Hertzog <hertzog@debian.org>
Copyright © 2007,2010 Joey Hess <joeyh@debian.org>.
Copyright © 2008 Raphaël Hertzog <hertzog@debian.org>
(C) Helge Kreutzmann <debian@helgefjell.de>, 2004, 2006-2019.
Copyright © 2008 Raphaël Hertzog <hertzog@debian.org>
Copyright © 2008-2010, 2012-2015 Guillem Jover <guillem@debian.org>
Copyright © 2006 Dpkg Developpes SZERVÁC Attila <sas@321.hu>, 2006.

Copyright © 2008 Frank Lichtenheld <djpig@debian.org>
Copyright © 2008-2009 Raphaël Hertzog <hertzog@debian.org>
Copyright (C) 2006 Free Software Foundation, Inc. KISE Hiroshi <kise@fuyuneko.jp>, 2006 - 2010. TAKAHASHI Motonobu <monyoy@monyoy.com>, 2011 - 2013.
Copyright © 2007-2009 Raphaël Hertzog <hertzog@debian.org>
Copyright © 2010 Raphaël Hertzog <hertzog@debian.org>
Copyright © 2007-2009,2012-2013 Guillem Jover <guillem@debian.org>
Copyright © 2007 Raphaël Hertzog
Copyright © 1994-2016 Dpkg Developers .Frans Spiesschaert <Frans.Spiesschaert@yucom.be>, 2016, 2017, 2018, 2019.
Copyright © 2016 Dpkg Developers Andre Luis Lopes <andrelop@debian.org>, 2008.
copyright by a pointer Bumped Standards to 3.6.1.1 (changes checked)
Copyright © 1995 Ian Jackson
Copyright © 2012-2015 Guillem Jover <guillem@debian.org>
Copyright © 2000, 2001 Wichert Akkerman <wakkerma@debian.org>
Copyright © 2007-2015 Guillem Jover <guillem@debian.org>
Copyright © 2007, 2008 Tollef Fog Heen <tfheen@err.no>
Copyright © 2007 Canonical Ltd. Written by Ian Jackson <ijackson@chiark.greenend.org.uk>
Copyright © 2009, 2013-2014 Guillem Jover <guillem@debian.org>
Copyright (C) 2004-2015 Free Software Foundation, Inc.
Copyright (C) 2010-2015 Free Software Foundation, Inc.
Copyright 1992-2019 Free Software Foundation, Inc.
Copyright (C) 2014 Free Software Foundation, Inc.
Copyright (C) 2011 Free Software Foundation, Inc.
Copyright (C) 2012 Free Software Foundation, Inc.
Copyright © 2006-2012 Guillem Jover <guillem@debian.org>
Copyright © 1994 Ian Murdock <imurdock@debian.org>
Copyright © 1994 Matt Welsh <mdw@sunsite.unc.edu>
Copyright © 1994 Carl Streeter <streeter@cae.wisc.edu>
Copyright © 1994-1999, 2008 Ian Jackson <ijackson@chiark.greenend.org.uk>
Copyright © 1995 Bruce Perens <bruce@pixar.com>
Copyright © 1995-1996 Erick Branderhorst <branderhorst@heel.fgg.eur.nl>
Copyright © 1996 Michael Shields <shields@crosslink.net>
Copyright © 1996 Klee Dienes <klee@debian.org>
Copyright © 1996 Kim-Minh Kaplan <kkaplan@cdfhp3.in2p3.fr>
Copyright © 1996-1998 Miquel van Smoorenburg <miquels@cistron.nl>
Copyright © 1997-1998 Charles Briscoe-Smith <cpbs@debian.org>
Copyright © 1997-1998 Juho Vuori <javuori@cc.helsinki.fi>
Copyright © 1998 Koichi Sekido <sekido@mbox.kyoto-inet.or.jp>
Copyright © 1998 Jim Van Zandt <jrv@vanzandt.mv.com>
Copyright © 1998 Juan Cespedes <cespedes@debian.org>
Copyright © 1998 Nils Rennebarth <nils@debian.org>
Copyright © 1998 Heiko Schlittermann <hs@schlittermann.de>
Copyright © 1998-1999, 2001, 2003, 2006 Martin Schulze <joey@infodrom.org>
Copyright © 1999 Roderick Shertler <roderick@argon.org>
Copyright © 1999 Ben Collins <bcollins@debian.org>
Copyright © 1999 Richard Kettlewell <rjk@sphere.greenend.org.uk>
Copyright © 1999-2001 Marcus Brinkmann <brinkmd@debian.org>
Copyright © 1999-2002 Wichert Akkerman <wakkerma@debian.org>
Copyright © 2001, 2007, 2010 Joey Hess <joeyh@debian.org>
Copyright © 2004-2005, 2007-2008, 2010 Canonical Ltd.
Copyright © 2004-2005 Scott James Remnant <scott@netsplit.com>
Copyright © 2006-2008 Frank Lichtenheld <djpig@debian.org>
Copyright © 2006-2015 Guillem Jover <guillem@debian.org>
Copyright © 2007-2012 Raphaël Hertzog <hertzog@debian.org>
Copyright © 2007 Nicolas François <nicolas.francois@centraliens.net>
Copyright © 2007 Don Armstrong <don@donarmstrong.com>

LICENCE TERMS (cont.)

Copyright © 2007 Colin Watson <cjwatson@debian.org>
Copyright © 2007, 2008 Tollef Fog Heen <tfheen@err.no>
Copyright © 2008 Zack Weinberg <zackw@panix.com>
Copyright © 2008 Pierre Habouzit <madcoder@debian.org>
Copyright © 2009 Romain Françoise <rfrancoise@debian.org>
Copyright © 2009-2010 Modestas Vainius <modax@debian.org>
Copyright © 2009-2011 Kees Cook <kees@debian.org>
Copyright © 1987-2006 Free Software Foundation, Inc.
Copyright © 1996 Andy Guy <awpguy@acs.ualgary.ca>
Copyright © 1998 Martin Schulze <joey@infodrom.org>
Copyright © 1999-2001, 2005-2006, 2009 Raphaël Hertzog <hertzog@debian.org>
Copyright © 2000 Joey Hess <joeyh@debian.org>
Copyright © 2007, 2009-2010, 2012-2015 Guillem Jover <guillem@debian.org>
Copyright © 1999 Marek Michalkiewicz <marekm@i17linuxb.ists.pwr.wroc.pl>
Copyright © 1999 Christian Schwarz <schwarz@monet.m.isar.de>
Copyright © 1999 Klee Dienes <klee@debian.org>
Copyright © 2000-2003 Adam Heath <doogie@debian.org>
Copyright © 2001 Sontri Tomo Huynh <huynh.29@osu.edu>
Copyright © 2001 Andreas Schuldei <andreas@schuldei.org>
Copyright © 2001 Ian Jackson <ijackson@chiark.greenend.org.uk>
Copyright © 2004-2005 Scott James Remnant <keybuk@debian.org>
Copyright © 2006-2014 Guillem Jover <guillem@debian.org>
Copyright © 2008 Samuel Thibault <samuel.thibault@ens-lyon.org>
Copyright © 2008 Andreas Pahlsson <andreas.pahlsson@xcerion.com>
Copyright © 2009 Chris Coulson <chrisccoulson@googlemail.com>
Copyright © 2012 Carsten Hey <carsten@debian.org>
Copyright © 2014 Nir Soffer <nirs@hyperms.com>
Copyright © 1993 Colin Plumb
Copyright © 1994 Ian Murdock <imurdock@debian.org>
Copyright © 1994 Matt Welsh <mdw@sunsite.unc.edu>
Copyright © 1994 Carl Streeter <streeter@cae.wisc.edu>
Copyright © 1994-1999, 2008 Ian Jackson <ijackson@chiark.greenend.org.uk>
Copyright © 1995 Bruce Perens <bruce@pixar.com>
Copyright © 1995-1996 Erick Branderhorst <branderhorst@heel.fgg.eur.nl>
Copyright © 1996 Michael Shields <shields@crosslink.net>
Copyright © 1996 Klee Dienes <klee@debian.org>
Copyright © 1996 Kim-Minh Kaplan <kkaplan@cdfhp3.in2p3.fr>
Copyright © 1996-1998 Miquel van Smoorenburg <miquels@cistron.nl>
Copyright © 1997-1998 Charles Briscoe-Smith <cpbs@debian.org>
Copyright © 1997-1998 Juho Vuori <javuori@cc.helsinki.fi>
Copyright © 1998 Koichi Sekido <sekido@mbox.kyoto-inet.or.jp>
Copyright © 1998 Jim Van Zandt <jrv@vanzandt.mv.com>
Copyright © 1998 Juan Cespedes <cespedes@debian.org>
Copyright © 1998 Nils Rennebarth <nils@debian.org>
Copyright © 1998 Heiko Schlittermann <hs@schlittermann.de>
Copyright © 1998-1999, 2001, 2003, 2006 Martin Schulze <joey@infodrom.org>
Copyright © 1999 Roderick Shertler <roderick@argon.org>
Copyright © 1999 Ben Collins <bcollins@debian.org>
Copyright © 1999 Richard Kettlewell <rjk@sfera.greenend.org.uk>
Copyright © 1999-2001 Marcus Brinkmann <brinkmd@debian.org>
Copyright © 1999-2002 Wichert Akkerman <wakkerma@debian.org>
Copyright © 2001, 2007, 2010 Joey Hess <joeyh@debian.org>
Copyright © 2004-2005, 2007-2008, 2010 Canonical Ltd.
Copyright © 2004-2005 Scott James Remnant <scott@netsplit.com>
Copyright © 2006-2008 Frank Lichtenheld <djpig@debian.org>
Copyright © 2006-2015 Guillem Jover <guillem@debian.org>
Copyright © 2007-2012 Raphaël Hertzog <hertzog@debian.org>

Copyright © 2007 Nicolas François <nicolas.francois@centraliens.net>
Copyright © 2007 Don Armstrong <don@donarmstrong.com>
Copyright © 2007 Colin Watson <cjwatson@debian.org>
Copyright © 2007, 2008 Tollef Fog Heen <tfheen@err.no>
Copyright © 2008 Zack Weinberg <zackw@panix.com>
Copyright © 2008 Pierre Habouzit <madcoder@debian.org>
Copyright © 2009 Romain Françoise <rfrancoise@debian.org>
Copyright © 2009-2010 Modestas Vainius <modax@debian.org>
Copyright © 2009-2011 Kees Cook <kees@debian.org>
Copyright © 1987-2006 Free Software Foundation, Inc.
Copyright © 1996 Andy Guy <awpguy@acs.ualgary.ca>
Copyright © 1998 Martin Schulze <joey@infodrom.org>
Copyright © 1999-2001, 2005-2006, 2009 Raphaël Hertzog <hertzog@debian.org>
Copyright © 2000 Joey Hess <joeyh@debian.org>
Copyright © 2007, 2009-2010, 2012-2015 Guillem Jover <guillem@debian.org>
Copyright © 1999 Marek Michalkiewicz <marekm@i17linuxb.ists.pwr.wroc.pl>
Copyright © 1999 Christian Schwarz <schwarz@monet.m.isar.de>
Copyright © 1999 Klee Dienes <klee@debian.org>
Copyright © 2000-2003 Adam Heath <doogie@debian.org>
Copyright © 2001 Sontri Tomo Huynh <huynh.29@osu.edu>
Copyright © 2001 Andreas Schuldei <andreas@schuldei.org>
Copyright © 2001 Ian Jackson <ijackson@chiark.greenend.org.uk>
Copyright © 2004-2005 Scott James Remnant <keybuk@debian.org>
Copyright © 2006-2014 Guillem Jover <guillem@debian.org>
Copyright © 2008 Samuel Thibault <samuel.thibault@ens-lyon.org>
Copyright © 2008 Andreas Pahlsson <andreas.pahlsson@xcerion.com>
Copyright © 2009 Chris Coulson <chrisccoulson@googlemail.com>
Copyright © 2012 Carsten Hey <carsten@debian.org>
Copyright © 2014 Nir Soffer <nirs@hyperms.com>
Copyright © 1993 Colin Plumb
Copyright (C) 2002-2018 Free Software Foundation, Inc.
Copyright (C) 2011-2018 Free Software Foundation, Inc.
Copyright (C) 2001-2018 Free Software Foundation, Inc.
Copyright (C) 1997-2018 Free Software Foundation, Inc.
Copyright (C) 1999-2018 Free Software Foundation, Inc.
Copyright (C) 1996-2018 Free Software Foundation, Inc.
Copyright (C) 2003-2018 Free Software Foundation, Inc.
Copyright (C) 2009-2018 Free Software Foundation, Inc.
Copyright (C) 2006-2018 Free Software Foundation, Inc.
Copyright (C) 2004-2018 Free Software Foundation, Inc.
Copyright (C) 1995-2014, 2016 Free Software Foundation, Inc.
Copyright (C) 2000-2002, 2007-2014, 2016 Free Software Foundation, Inc.
Copyright (C) 1996-2003, 2009-2016 Free Software Foundation, Inc.
Copyright (C) 2001-2016 Free Software Foundation, Inc.
Copyright (C) 2001-2005, 2008-2016 Free Software Foundation, Inc.
Copyright (C) 1995-2003, 2005-2006, 2008-2014, 2016 Free Software dnl Foundation, Inc.
Copyright © 2004 Scott James Remnant <scott@netsplit.com>.
Copyright © 2012-2015 Dan Nicholson <dbn.lists@gmail.com>
Copyright (C) 1996-2003, 2005, 2008-2016 Free Software Foundation, Inc.
Copyright © 2005 Scott James Remnant <scott@netsplit.com>
Copyright © 2006-2009 Guillem Jover <guillem@debian.org>
Copyright © 2010-2014 Guillem Jover <guillem@debian.org>
Copyright © 2004 Scott James Remnant <scott@netsplit.com>
Copyright © 2006, 2009-2011, 2013-2016 Guillem Jover <guillem@debian.org>
Copyright © 2010 Guillem Jover <guillem@debian.org>
Copyright © 2008-2009, 2015 Guillem Jover <guillem@debian.org>
Copyright © 2006, 2009-2012, 2014-2015 Guillem Jover <guillem@debian.org>

LICENCE TERMS (cont.)

Copyright © 2010, 2014, 2016 Guillem Jover <guillem@debian.org>
Copyright © 2007 Frank Lichtenheld <djpig@debian.org>
Copyright © 2007, 2009, 2011 Guillem Jover <guillem@debian.org>
Copyright © 2009-2011 Guillem Jover <guillem@debian.org>
Copyright © 1995-2003, 2005-2006 Free Software Foundation, Inc.
Copyright © 2009 Yuri Vasilevski <yvasilev@gentoo.org>
Copyright (C) 2004-2014, 2016 Free Software Foundation, Inc.
Copyright (C) 1996-2001, 2003-2015 Free Software Foundation, Inc. Written by Gordon Matzigkeit, 1996
Copyright (C) 2014 Free Software Foundation, Inc.
Copyright (C) 2011 Free Software Foundation, Inc.
Copyright (C) 2004-2005, 2007-2009, 2011-2015 Free Software Foundation, Inc. Written by Gary V. Vaughan, 2004
Copyright (C) 2004-2005, 2007-2008, 2011-2015 Free Software Foundation, Inc. Written by Gary V. Vaughan, 2004
Copyright (C) 2004, 2011-2015 Free Software Foundation, Inc. Written by Scott James Remnant, 2004
Copyright (C) 2004-2005, 2007, 2009, 2011-2015 Free Software Foundation, Inc. Written by Scott James Remnant, 2004.
Copyright (C) 2002-2018 Free Software Foundation, Inc.
Copyright (C) 2011-2018 Free Software Foundation, Inc.
Copyright (C) 2001-2018 Free Software Foundation, Inc.
Copyright (C) 1997-2018 Free Software Foundation, Inc.
Copyright (C) 1999-2018 Free Software Foundation, Inc.
Copyright (C) 1996-2018 Free Software Foundation, Inc.
Copyright (C) 2003-2018 Free Software Foundation, Inc.
Copyright (C) 2009-2018 Free Software Foundation, Inc.
Copyright (C) 2006-2018 Free Software Foundation, Inc.
Copyright (C) 2004-2018 Free Software Foundation, Inc.
Copyright (C) 1995-2014, 2016 Free Software Foundation, Inc.
Copyright (C) 2000-2002, 2007-2014, 2016 Free Software Foundation, Inc.
Copyright (C) 1996-2003, 2009-2016 Free Software Foundation, Inc.
Copyright (C) 2001-2016 Free Software Foundation, Inc.
Copyright (C) 2001-2005, 2008-2016 Free Software Foundation, Inc.
Copyright (C) 1995-2003, 2005-2006, 2008-2014, 2016 Free Software dnl Foundation, Inc.
Copyright © 2004 Scott James Remnant <scott@netsplit.com>.
Copyright © 2012-2015 Dan Nicholson <dnl.lists@gmail.com> dnl dnl This program is free software
Copyright (C) 1996-2003, 2005, 2008-2016 Free Software Foundation, Inc.
Copyright © 2005 Scott James Remnant <scott@netsplit.com>
Copyright © 2006-2009 Guillem Jover <guillem@debian.org>
Copyright © 2010-2014 Guillem Jover <guillem@debian.org>
Copyright © 2004 Scott James Remnant <scott@netsplit.com>
Copyright © 2006, 2009-2011, 2013-2016 Guillem Jover <guillem@debian.org>
Copyright © 2010 Guillem Jover <guillem@debian.org>
Copyright © 2008-2009,2015 Guillem Jover <guillem@debian.org>
Copyright © 2006, 2009-2012, 2014-2015 Guillem Jover <guillem@debian.org>
Copyright © 2010, 2014, 2016 Guillem Jover <guillem@debian.org>
Copyright © 2007 Frank Lichtenheld <djpig@debian.org>
Copyright © 2007, 2009, 2011 Guillem Jover <guillem@debian.org>
Copyright © 2009-2011 Guillem Jover <guillem@debian.org>
Copyright © 1995-2003, 2005-2006 Free Software Foundation, Inc.
Copyright © 2009 Yuri Vasilevski <yvasilev@gentoo.org>
Copyright (C) 2004-2014, 2016 Free Software Foundation, Inc.
Copyright (C) 1996-2001, 2003-2015 Free Software Foundation, Inc. Written by Gordon Matzigkeit, 1996
Copyright (C) 2004-2005, 2007-2009, 2011-2015 Free Software Foundation, Inc. Written by Gary V. Vaughan, 2004
Copyright (C) 2004-2005, 2007-2008, 2011-2015 Free Software Foundation, Inc. Written by Gary V. Vaughan, 2004
Copyright (C) 2004, 2011-2015 Free Software Foundation, Inc. Written by Scott James Remnant, 2004
Copyright (C) 2004-2005, 2007, 2009, 2011-2015 Free Software Foundation, Inc. Written by Scott James Remnant, 2004.
Copyright © 2000,2001 Wichert Akkerman <wakkerma@debian.org>
Copyright (C) 1994-1996 Ian Jackson.

Copyright (C) 2000,2001 Wichert Akkerman.
Copyright © 2007-2014 Guillem Jover <guillem@debian.org>
Copyright © 2001 Wichert Akkerman <wakkerma@debian.org>
Copyright © 2008-2014 Guillem Jover <guillem@debian.org>
Copyright © 1997 Klee Dienes <klee@debian.org>
Copyright © 1999-2003 Wichert Akkerman <wakkerma@debian.org>
Copyright © 2005 Brendan O'Dea <bod@debian.org>
Copyright © 2006-2009,2012 Guillem Jover <guillem@debian.org>
Copyright © 2008-2011 Raphaël Hertzog <hertzog@debian.org>
Copyright © 2006-2010, 2012-2015 Guillem Jover <guillem@debian.org>
Copyright © 2000 Wichert Akkerman
Copyright © 2006-2010, 2012-2015 Guillem Jover <guillem@debian.org>
Copyright © 2007 Frank Lichtenheld
Copyright © 2000,2001 Wichert Akkerman
Copyright © 2006-2014 Guillem Jover <guillem@debian.org>
Copyright © 2006-2015 Guillem Jover <guillem@debian.org>
Copyright © 2007-2013 Guillem Jover <guillem@debian.org>
Copyright © 2000,2001 Wichert Akkerman <wakkerma@debian.org>
Copyright (C) 1999-2001 Marcus Brinkmann <brinkmd@debian.org>.
Copyright (C) 2004-2005 Scott James Remnant <scott@netsplit.com>.
Copyright © 1999-2001 Marcus Brinkmann <brinkmd@debian.org>.
Copyright © 2004-2005 Scott James Remnant <scott@netsplit.com>.
Copyright (C) 2010-2011 Raphael Hertzog <hertzog@debian.org>.
Copyright © 2010-2011 Raphael Hertzog <hertzog@debian.org>.
Copyright (C) 1996 Ian Jackson.
Copyright (C) 2000 Wichert Akkerman
Copyright (C) 2007 Frank Lichtenheld
Copyright © 1996 Ian Jackson.
Copyright © 2000 Wichert Akkerman.
Copyright © 2007 Frank Lichtenheld.
Copyright (C) 1996 Ian Jackson.
Copyright © 1996 Ian Jackson.
Copyright (C) 2000,2001 Wichert Akkerman.
Copyright © 2000,2001 Wichert Akkerman.
Copyright (C) 2000,2002 Wichert Akkerman.
Copyright © 2000,2002 Wichert Akkerman.
Copyright (C) 2007 Raphael Hertzog.
Copyright © 2007 Raphael Hertzog.
Copyright (C) 2009-2010 Raphael Hertzog.
Copyright © 2009-2010 Raphael Hertzog.
Copyright (C) 2001 Wichert Akkerman
Copyright © 2001 Wichert Akkerman
Copyright (C) 2000 Wichert Akkerman.
Copyright (C) 2006 Frank Lichtenheld.
Copyright © 2006 Frank Lichtenheld.Copyright © 2007 Raphael Hertzog.
Copyright (C) 1996 Ian Jackson
Copyright (C) 1997 Klee Dienes
Copyright (C) 2008 Raphael Hertzog
Copyright © 1996 Ian Jackson
Copyright © 1997 Klee Dienes
Copyright © 2008 Raphael Hertzog
Copyright (C) 2005,2007 Frank Lichtenheld.
Copyright © 2005,2007 Frank Lichtenheld.
Copyright (C) 1996 Ian Jackson and Klee Dienes.
Copyright © 1996 Ian Jackson and Klee Dienes.
Copyright (C) 1999-2001 Marcus Brinkmann <brinkmd@debian.org>.
Copyright (C) 2004-2005 Scott James Remnant <scott@netsplit.com>.

Copyright (C) 2000-2002 Wichert Akkerman.
 Copyright (C) 2000 Wichert Akkerman.
 Copyright (C) 1994,1995 Ian Jackson.
 Copyright (C) 1994,1995 Ian Jackson.
 Copyright (C) 1996 Kim-Minh Kaplan.
 Copyright (C) 1996 Kim-Minh Kaplan.
 Copyright(C) 1995 Ian Jackson
 Copyright(C) 2000,2001 Wichert Akkerman
 Copyright(C) 2010 Guillem Jover
 Copyright(C) 2000, 2001 Wichert Akkerman
 Copyright(C) 2006-2009 Guillem Jover
 Copyright(C) 2009-2010 Raphael Hertzog
 Copyright(C) 2000,2001 Wichert Akkerman
 Copyright © 2000, 2001 Wichert akkerman.
 Copyright (C) 1995 Ian Jackson.
 Copyright (C) 2000,2001 Wichert Akkerman.
 Copyright (C) 2010 Guillem Jover.
 Copyright (C) 2010 Guillem Jover.
 Copyright (C) 2000, 2001 Wichert Akkerman.
 Copyright (C) 2006-2009 Guillem Jover.
 Copyright (C) 2000-2002 Wichert Akkerman.
 Copyright (C) 2009-2010 Raphael Hertzog.
 Copyright (C) 2000 Wichert Akkerman.
 Copyright (C) 1994,1995 Ian Jackson.
 Copyright (C) 1994,1995 Ian Jackson.
 Copyright (C) 1996 Kim-Minh Kaplan.
 Copyright (C) 1996 Kim-Minh Kaplan.
 Copyright (C) 1996 Kim-Minh Kaplan.
 Copyright © 2000,2001 Wichert Akkerman.
 Copyright© nam 1994-1996 Ian Jackson.
 Copyright (C) 1996 Kim-Minh Kaplan.
 Copyright © 1995 Ian Jackson.
 Copyright © 2010 Guillem Jover.
 Copyright © 2000, 2001 Wichert Akkerman.
 Copyright © 2006-2009 Guillem Jover.
 Copyright © 2009-2010 Raphael Hertzog.
 Copyright © 2000 Wichert Akkerman."
 Copyright © 1994,1995 Ian Jackson."
 Copyright © 1996 Kim-Minh Kaplan."
 Copyright(C) 2000,2001 Wichert Akkerman.
 Copyright (C) 1995,1996 Erick Branderhorst <branderhorst@heel.fgg.eur.nl>
 Copyright (C) 1996 Miquel van Smoorenburg <miquels@cistron.nl>
 Copyright (C) 1996 Kim-Minh Kaplan <kkaplan@cdfhp3.in2p3.fr>
 Copyright (C) 1996 Michael Shields <shields@crosslink.net>
 Copyright (C) 1995 Bruce Perens <bruce@pixar.com>
 Copyright (C) 1994 Carl Streeter <streeter@cae.wisc.edu>
 Copyright (C) 1994 Matt Welsh <mdw@sunsite.unc.edu>
 Copyright (C) 1994 Ian Murdock <imurdock@debian.org> Parts written by Colin Plumb and Branko Lankester in 1993.
 Copyright (C) 1998 Masato Taruishi <taru@debian.or.jp>
 Copyright (C) 1999-2004 Keita Maehara <maehara@debian.org>
 Copyright (C) 2004-2014 Kenshi Muto <kmuto@debian.org>
 Copyright (C) 2016 Takuma Yamada <tyamada@takumayamada.com>
 Copyright (C) 2000 Jerome Marant <jerome.marant@free.fr>
 Copyright (C) 2000, 2001, 2002 Martin Quinson <Martin.Quinson@tuxfamily.org>
 Copyright (C) 2005-2009 Christian Perrier <bubulle@debian.org>
 Copyright (C) 2000,2001 Wichert Akkerman.

copyright© Luís Lopes <andrelop@ig.com.br>, 2002.
 copyright© Luís Lopes <andrelop@debian.org>, 2004.
 copyright© Luís Lopes <andrelop@debian.org>, 2005. Felipe Augusto van de Wiel (faw) <faw@debian.org>, 2008.
 Copyright© Luís Lopes <andrelop@ig.com.br>, 2002.
 Copyright© Luís Lopes <andrelop@debian.org>, 2004.
 Copyright© Luís Lopes <andrelop@debian.org>, 2005. Felipe Augusto van de Wiel (faw) <faw@debian.org>, 2008.
 Copyright © 2006, 2008-2015 Guillem Jover <guillem@debian.org>
 Copyright (C) 2012 Free Software Foundation, Inc.
 Copyright (C) 2012 Free Software Foundation, Inc.
 Copyright (C) 2012 Free Software Foundation, Inc.
 Copyright (C) 2012 Free Software Foundation, Inc.
 Copyright (C) 2012 Free Software Foundation, Inc.
 Copyright (C) 2012 Free Software Foundation, Inc.
 Copyright (C) 2014 Free Software Foundation, Inc.
 Copyright (C) 2012 Free Software Foundation, Inc.
 Copyright (C) 2012 Free Software Foundation, Inc.
 Copyright (C) 2012 Free Software Foundation, Inc.
 Copyright(C) 1995 Ian Jackson.
 Copyright(C) 2010 Guillem Jover.
 Copyright(C) 2000, 2001 Wichert Akkerman.
 Copyright(C) 2006-2009 Guillem Jover.
 Copyright(C) 2000-2002 Wichert Akkerman.
 Copyright(C) 2009-2010 Raphael Hertzog.
 Copyright(C) 2000,2001 Wichert Akkerman."
 Copyright(C) 2000-2002 Wichert Akkerman."
 Copyright(C) 2000 Wichert Akkerman."
 Copyright(C) 1994,1995 Ian Jackson."
 Copyright(C) 1996 Kim-Minh Kaplan."
 Copyright (C) 2000 Wichert Akkerman."
 Copyright © 2000-2002 Wichert Akkerman <wakkerma@debian.org>
 Copyright © 2006-2017 Guillem Jover <guillem@debian.org>
 Copyright © 2009-2010 Raphaël Hertzog <hertzog@debian.org>
 copyright(C) 1995 Ian Jackson.
 copyright(C) 2000,2001 Wichert Akkerman.
 copyright(C) 2010 Guillem Jover.
 copyright(C) 2000, 2001 Wichert Akkerman.
 copyright(C) 2006-2009 Guillem Jover.
 copyright(C) 1994-1996 Ian Jackson.
 copyright(C) 2000-2002 Wichert Akkerman.
 copyright(C) 2009-2010 Raphael Hertzog.
 copyright(C) 2000,2001 Wichert Akkerman."
 copyright(C) 2000 Wichert Akkerman."
 copyright(C) 1994,1995 Ian Jackson."
 copyright(C) 1996 Kim-Minh Kaplan."
 Copyright(C) 2009-2010 Raphael Hertzog.
 Copyright(C) 1996 Kim-Minh Kaplan."
 Copyright © 2008-2012 Guillem Jover <guillem@debian.org>
 Copyright © 2008-2015 Guillem Jover <guillem@debian.org>
 Copyright (C) 2000-2002 Wichert Akkerman.
 Copyright © 2009-2011 Guillem Jover <guillem@debian.org>
 Copyright © 2007, 2009, 2011 Guillem Jover <guillem@debian.org>
 Copyright © 2008-2009,2015 Guillem Jover <guillem@debian.org>
 Copyright © 2010 Guillem Jover <guillem@debian.org>
 Copyright © 2006-2009 Guillem Jover <guillem@debian.org>
 Copyright © 2006, 2009-2011, 2013-2016 Guillem Jover <guillem@debian.org>
 Copyright © 2010, 2014, 2016 Guillem Jover <guillem@debian.org>
 Copyright © 2006, 2009-2012, 2014-2015 Guillem Jover <guillem@debian.org>
 Copyright (C) 2004-2015 Kenshi Muto <kmuto@debian.org>

LICENCE TERMS (cont.)

Copyright (C) 2016 Takuma Yamada <tyamada@takumayamada.com>
Copyright © 2008, 2009 Guillem Jover <guillem@debian.org>
Copyright (C) 2000 Jerome Marant <jerome.marant@free.fr>
Copyright (C) 2005-2009 Debian French I10n team <debian-i10n-french@lists.debian.org>
Copyright (C) 1994-1996 Ian Jackson.
Copyright (C) 996 Kim-Minh Kaplan
Copyright (C) 996 Kim-Minh Kaplan"
copyright© Luis Lopes <andreloup@debian.org>, 2005.
copyright© Luis Lopes <andreloup@debian.org>, 2006. Felipe Augusto van de Wiel <faw@debian.org>, 2008.
Copyright © 2000, 2001 Wichert Akkerman <wakkerma@debian.org>
Copyright © 2009-2015 Guillem Jover <guillem@debian.org>
Copyright © 2000, 2001 Wichert Akkerman <wakkerma@debian.org>
Copyright © 2008-2014 Guillem Jover <guillem@debian.org>
Copyright © 2009 Canonical Ltd.
Copyright © 2006-2013, 2015 Guillem Jover <guillem@debian.org>
Copyright © 2009-2014 Guillem Jover <guillem@debian.org>
Copyright © 2009-2012, 2015 Guillem Jover <guillem@debian.org>
Copyright © 2006 Frank Lichtenheld <djpig@debian.org>
Copyright © 2009 Raphaël Hertzog <hertzog@debian.org>
Copyright © 2008 Zack Weinberg <zackw@panix.com>
Copyright © 2009-2011, 2013, 2015 Guillem Jover <guillem@debian.org>
Copyright © 2009 Guillem Jover <guillem@debian.org>
Copyright © 2006, 2012-2013, 2015 Guillem Jover <guillem@debian.org>
Copyright © 2007-2008 Raphaël Hertzog <hertzog@debian.org>
Copyright © 2001 Wichert Akkerman <wichert@debian.org>
Copyright © 2011, 2014 Raphaël Hertzog <hertzog@debian.org>
Copyright © 2010 Raphaël Hertzog <hertzog@debian.org>
Copyright © 2011-2014 Guillem Jover <guillem@debian.org>
Copyright © 2003 Adam Heath <doogie@debian.org>
Copyright © 2009-2011 Raphaël Hertzog <hertzog@debian.org>
Copyright © 1995-1996 Ian Jackson <ijackson@chiark.greenend.org.uk>
Copyright © 2000 Wichert Akkerman <wakkerma@debian.org>
Copyright © 2009-2014, 2017 Guillem Jover <guillem@debian.org>
Copyright © 2011 Guillem Jover <guillem@debian.org>
Copyright © 2009-2012 Raphaël Hertzog <hertzog@debian.org>
Copyright © 2008-2011 Guillem Jover <guillem@debian.org>
Copyright © 2007, 2009, 2011-2014 Guillem Jover <guillem@debian.org>
Copyright © 2007-2013, 2015 Guillem Jover <guillem@debian.org>
Copyright © 2011-2014 Guillem Jover <guillem@debian.org>
Copyright © 2008-2010 Raphaël Hertzog <hertzog@debian.org>
Copyright © 2007-2011 Raphaël Hertzog <hertzog@debian.org>
Copyright © 2011-2013, 2015 Guillem Jover <guillem@debian.org>
Copyright © 2000 Josip Rodin
Copyright © 2001 Joost Kooij
Copyright © 2010-2015 Guillem Jover <guillem@debian.org>
Copyright © 2009-2010 Modestas Vainius <modestas@vainius.eu>
Copyright © 2012-2015 Guillem Jover <guillem@debian.org>
Copyright © 2010 Russ Allbery <rra@debian.org>
Copyright © 2015 Guillem Jover <guillem@debian.org>
Copyright © 2011 Raphaël Hertzog <hertzog@debian.org>
Copyright © 2015-2016 Guillem Jover <guillem@debian.org>
Copyright © 1998, 2001 Manoj Srivastava <srivasta@debian.org>
Copyright © 2001 Julian Gilbey <jdg@debian.org>
Copyright © 2003 Josip Rodin <joy@debian.org>
Copyright © 2008, 2010 Russ Allbery <rra@debian.org>
Copyright © 2010 Charles Plessy <plessy@debian.org>
Copyright © 2014 Bill Allombert <ballombe@debian.org>

Copyright © 2015-2017 Guillem Jover <guillem@debian.org>
Copyright © 2007-2013, 2015 Guillem Jover <guillem@debian.org>
Copyright © 2009 Canonical Ltd.
Copyright © 1999 Jim Van Zandt <jrv@vanzandt.mv.com>
Copyright © 1999-2003 Wichert Akkerman <wakkerma@debian.org>
Copyright © 2002 Josip Rodin
Copyright © 2006-2016 Guillem Jover <guillem@debian.org>
Copyright © 2007-2008 Ian Jackson <ijackson@chiark.greenend.org.uk>
Copyright © 2008-2011 Raphaël Hertzog <hertzog@debian.org>
Copyright © 1999 Jim Van Zandt <jrv@vanzandt.mv.com>
Copyright © 2002 Josip Rodin
Copyright © 2007-2008 Ian Jackson <ijackson@chiark.greenend.org.uk>
Copyright © 2008-2011 Raphaël Hertzog <hertzog@debian.org>
Copyright © 2006-2007 Frank Lichtenheld <djpig@debian.org>
Copyright © 2010 Joey Hess <joeyh@debian.org>
Copyright © 2009-2011 Raphaël Hertzog <hertzog@debian.org>
Copyright © 2011, 2013, 2015 Guillem Jover <guillem@debian.org>
Copyright © 2008-2010 Raphaël Hertzog <hertzog@debian.org>
Copyright © 2015 Jérémy Bobbio <lunar@debian.org>
Copyright © 2011, 2013-2015 Guillem Jover <guillem@debian.org>
Copyright © 1999 Wichert Akkerman <wakkerma@debian.org>
Copyright © 2011-2015 Guillem Jover <guillem@debian.org>
Copyright © 1996 Ian Jackson <ijackson@chiark.greenend.org.uk>
Copyright © 2006-2017 Guillem Jover <guillem@debian.org>
Copyright © 2007-2008 Frank Lichtenheld <djpig@debian.org>
Copyright © 2008-2015 Guillem Jover <guillem@debian.org>
Copyright © 2008-2012 Raphaël Hertzog <hertzog@debian.org>
Copyright © 2011 Kees Cook <kees@debian.org>
Copyright © 2006-2009,2012-2015 Guillem Jover <guillem@debian.org>
Copyright © 2000-2001 Wichert Akkerman <wakkerma@debian.org>
Copyright © 2002-2003 Adam Heath <doogie@debian.org>
Copyright © 2004 Scott James Remnant <keybuk@debian.org>
Copyright © 2008-2016, 2018 Guillem Jover <guillem@debian.org>
Copyright © 2009, 2013, 2015 Guillem Jover <guillem@debian.org>
Copyright © 2007-2011, 2013-2015 Guillem Jover <guillem@debian.org>
Copyright © 2007-2013, 2015-2018 Guillem Jover <guillem@debian.org>
Copyright © 2006, 2011-2015 Guillem Jover <guillem@debian.org>
Copyright © 2012-2013 Guillem Jover <guillem@debian.org>
Copyright © 2009 Raphaël Hertzog <hertzog@debian.org>
Copyright © 2009-2011, 2013, 2015 Guillem Jover <guillem@debian.org>
Copyright © 2007-2008 Raphaël Hertzog <hertzog@debian.org>
Copyright © 2008-2016 Guillem Jover <guillem@debian.org>
Copyright © 2011, 2014 Raphaël Hertzog <hertzog@debian.org>
Copyright © 2006,2008-2014 Guillem Jover <guillem@debian.org>
Copyright © 2009-2012 Raphaël Hertzog <hertzog@debian.org>
Copyright © 2000,2002 Wichert Akkerman <wichert@deephackmode.org>
Copyright © 2008-2013 Guillem Jover <guillem@debian.org>
Copyright © 2011-2013, 2015 Guillem Jover <guillem@debian.org>
Copyright © 2010-2015 Guillem Jover <guillem@debian.org>
Copyright © 2012-2015 Guillem Jover <guillem@debian.org>
Copyright © 2005 Scott James Remnant
Copyright © 2015 Guillem Jover <guillem@debian.org>
Copyright © 2015-2016 Guillem Jover <guillem@debian.org>
Copyright © 2015-2017 Guillem Jover <guillem@debian.org>
Copyright © 2000,2001 Wichert Akkerman <wichert@debian.org>
Copyright © 2010 Joey Hess <joeyh@debian.org>
Copyright © 2011, 2013, 2015 Guillem Jover <guillem@debian.org>

LICENCE TERMS (cont.)

Copyright © 2007-2011, 2013-2017 Guillem Jover <guillem@debian.org>
Copyright © 2015 Jérémy Bobbio <lunar@debian.org>
Copyright © 2011, 2013-2015 Guillem Jover <guillem@debian.org>
Copyright © 2011-2015 Guillem Jover <guillem@debian.org>
Copyright © 2008-2012 Raphaël Hertzog <hertzog@debian.org>
Copyright © 2009-2010 Raphaël Hertzog <hertzog@debian.org>
Copyright © 2008-2016, 2018 Guillem Jover <guillem@debian.org>
Copyright © 2011 Guillem Jover <guillem@debian.org>
Copyright © 2007-2013, 2015-2018 Guillem Jover <guillem@debian.org>
Copyright © 2010 Raphaël Hertzog <hertzog@debian.org>
Copyright © 2008 Joey Hess <joeyh@debian.org>
Copyright © 2005 Scott James Remnant (original implementation on www.dpkg.org)
Copyright © Ian Jackson <ijackson@chiark.greenend.org.uk>
Copyright © 2007 Don Armstrong <don@donarmstrong.com>.
Copyright © 2010, 2012-2015 Guillem Jover <guillem@debian.org>
Copyright © 2009-2010 Modestas Vainius <modax@debian.org>
Copyright © 2007-2009,2012-2015,2017-2018 Guillem Jover <guillem@debian.org>
Copyright © 2007,2012 Guillem Jover <guillem@debian.org>
Copyright © 2012 Guillem Jover <guillem@debian.org>
Copyright © 2007-2008, 2012-2015 Guillem Jover <guillem@debian.org>
Copyright © 1999 Darren Benham
Copyright © 2000 Sean 'Shaleh' Perry
Copyright © 2004 Frank Lichtenheld
Copyright © 2006 Russ Allbery
Copyright © 2007-2009 Raphaël Hertzog <hertzog@debian.org>
Copyright © 2008-2009,2012-2014 Guillem Jover <guillem@debian.org>
Copyright © 2012-2017 Guillem Jover <guillem@debian.org>
Copyright © 2012-2017 Guillem Jover <guillem@debian.org>
Copyright © 2008 Canonical, Ltd. written by Colin Watson <cjwatson@ubuntu.com>
Copyright © 2008 James Westby <jw+debian@jameswestby.net>
Copyright © 2009, 2011-2017 Guillem Jover <guillem@debian.org>
Copyright © 2009-2011 Kees Cook <kees@debian.org>
Copyright © 2007-2008 Canonical, Ltd.
Copyright © 2008-2009, 2012-2014 Guillem Jover <guillem@debian.org>
Copyright © 2012-2014 Guillem Jover <guillem@debian.org>
Copyright © 2007, 2009-2010, 2012-2017 Guillem Jover <guillem@debian.org>
Copyright © 2007, 2009-2010, 2012-2017 Guillem Jover <guillem@debian.org>
Copyright © 2010, 2013-2016 Guillem Jover <guillem@debian.org>
Copyright © 2008 Frank Lichtenheld <djpig@debian.org>
Copyright © 2008-2010, 2012-2015 Guillem Jover <guillem@debian.org>
Copyright © 2008, 2012-2017 Guillem Jover <guillem@debian.org>
Copyright © 2007-2010 Raphaël Hertzog <hertzog@debian.org>
Copyright © 2008, 2012-2015 Guillem Jover <guillem@debian.org>
Copyright © 2007 Joey Hess <joeyh@debian.org>.
Copyright © 2008 Frank Lichtenheld <djpig@debian.org>
copyright(C) Florian Rehnisch <eixman@gmx.de>, 2007.
copyright(C) Sven Joachim <svenjoac@gmx.de>, 2008.
Copyright(C) Florian Rehnisch <eixman@gmx.de>, 2007.
Copyright(C) Sven Joachim <svenjoac@gmx.de>, 2008.
Copyright © 2008-2018 Guillem Jover <guillem@debian.org>
Copyright © 2008, 2012-2015 Guillem Jover <guillem@debian.org>
Copyright © 2011 Linaro Limited
Copyright © 2009, 2012-2015 Guillem Jover <guillem@debian.org>
Copyright © 2005 Frank Lichtenheld <frank@lichtenheld.de>
Copyright © 2012-2017 Guillem Jover <guillem@debian.org>
Copyright © 2010-2013 Guillem Jover <guillem@debian.org>
Copyright © 2007 Raphaël Hertzog <hertzog@debian.org>

Copyright © 2000,2002 Wichert Akkerman
Copyright © 2006 Frank Lichtenheld
Copyright © 2006-2010,2012-2015 Guillem Jover <guillem@debian.org>
Copyright © 2007, 2016 Raphaël Hertzog <hertzog@debian.org>
Copyright © 2010 Canonical Ltd. written by Martin Pitt <martin.pitt@canonical.com>
Copyright © 1999, 2002 Wichert Akkerman <wichert@deephackmode.org>
Copyright © 2000, 2001 Wichert Akkerman
Copyright © 2006-2015, 2017-2018 Guillem Jover <guillem@debian.org>
Copyright © 2006, 2008-2016 Guillem Jover <guillem@debian.org>
Copyright © 2006, 2008-2019 Guillem Jover <guillem@debian.org>
Copyright © 2006-2019 Guillem Jover <guillem@debian.org>
Copyright © 2008, 2010 Guillem Jover <guillem@debian.org>
Copyright © 2006, 2008-2015 Guillem Jover <guillem@debian.org>
Copyright © 2006, 2008-2016 Guillem Jover <guillem@debian.org>
Copyright © 2008, 2010, 2012-2014 Guillem Jover <guillem@debian.org>
Copyright © 2008-2013, 2015 Guillem Jover <guillem@debian.org>
Copyright 1992-2019 Free Software Foundation, Inc.
Copyright (C) 1995-1997, 2000-2007, 2009-2010 by Ulrich Drepper <drepper@gnu.ai.mit.edu>
Copyright 1996-2016 Free Software Foundation, Inc. Taken from GNU libtool, 2001 Originally by Gordon Matzigkeit <gord@gnu.ai.mit.edu>, 1996
Copyright (c) 2006, 2008 Junio C Hamano
Copyright (C) 1995-1999, 2000-2001, 2003 Free Software Foundation, Inc. Written by Ulrich Drepper <drepper@gnu.org>, 1995.

Copyright (C) 1999 by Andries Brouwer
Copyright (C) 1994, 1995, 2000 Theodore Ts'o.
Copyright (C) 1993, 1994, 1995, 1996, 1997 Theodore Ts'o.
Copyright (C) 1993, 1994, 1994, 1996 Theodore Ts'o.
Copyright (C) 1995,1996,1997,1998,1999,2000 Theodore Ts'o.
Copyright (C) 2000 Theodore Ts'o.
Copyright (C) 1997, 1998, 1999, 2000, 2001, 2002, 2003, 2004, 2005, 2006, 2007, 2008, 2009, 2010, 2011, 2012, 2013, 2014 by Theodore Ts'o
Copyright 2001 by Theodore Ts'o. All Rights Reserved.
Copyright (C) 1993, 1994 Remy Card <card@masi.ibp.fr>
Copyright 1999 Andreas Dilger (adilger@enel.ucalgary.ca)
Copyright 2003 by Theodore Ts'o.
Copyright (C) 2004,2005 Theodore Ts'o <tytso@mit.edu>
Copyright (c) 2003,2004 Cluster File Systems, Inc, info@clusterfs.com Written by Alex Tomas <alex@clusterfs.com>
Copyright (C) 1992, 1993, 1994 Remy Card <card@masi.ibp.fr>
Copyright (C) 2018 Oracle. All Rights Reserved.
Copyright (C) 1995, 2000-2003 Software Foundation, Inc.
Copyright 2017 The Android Open Source Project
Copyright 1997 by Theodore Ts'o
Copyright (C) 1997 Theodore Ts'o.
Copyright (C) 2013 by Theodore Ts'o
Copyright 1988 by the Student Information Processing Board of the Massachusetts Institute of Technology.
Copyright 2008 by Theodore Ts'o. All Rights Reserved.
Copyright (C) 1993, 1994, 1995, 1996, 1997, 1998, 1999, 2000, 2001, 2002, 2003, 2004, 2005 by Theodore Ts'o.
Copyright 1987, 1988 by MIT Student Information Processing Board
Copyright (C) 1996, 1997 Theodore Ts'o.
Copyright (C) 1994, 1995, 1996, 1997 Theodore Ts'o.
Copyright (C) 1993, 1994, 1997 Theodore Ts'o.
Copyright (C) 1993, 1994, 1994, 1995, 1996, 1997 Theodore Ts'o.
Copyright (C) 1993, 1994, 1995, 1996 Theodore Ts'o.
Copyright (C) 2002 Theodore Ts'o.
Copyright 2003, 2004 by Theodore Ts'o.
Copyright (C) 1993, 1994 Theodore Ts'o.

LICENCE TERMS (cont.)

Copyright (C) 2007, 2008 Theodore Ts'o.
Copyright 2000 Andreas Dilger (adilger@turbolinux.com)
Copyright (C) 1996, 1997 Theodore Ts'o.
Copyright (C) 2008 Theodore Tso (msgids)
Copyright (C) 1989, 1991 Free Software Foundation, Inc.
Copyright (C) 2010 Theodore Ts'o.
Copyright (C) 2002 Andreas Dilger
Copyright (c) 1997 Mark Habersack
Copyright (C) 1993, 1994, 1995, 1996, 1997, 1998, 1999, 2000, 2001, 2002 by Theodore Ts'o.
Copyright (C) 1995-1999, 2000-2003 Free Software Foundation, Inc. Written by Ulrich Drepper <drepper@cygnus.com>, 1995.
Copyright (C) 1993 Remy Card (card@masi.ibp.fr)
Copyright (C) 2001 Andreas Dilger
Copyright 1987 by MIT Student Information Processing Board
Copyright (C) 2009 NEC Software Tohoku, Ltd.
Copyright (C) 1995 Gadi Oxman
Copyright (C) 1999 Theodore Ts'o <tytso@mit.edu>
Copyright (C) 2003 Free Software Foundation, Inc.
Copyright (C) 2007 by Theodore Ts'o.
Copyright (C) 2000, 2001, 2003 Theodore Ts'o
Copyright 1987, 1988, 1989 by MIT Student Information Processing Board
Copyright (C) 1995-1999, 2000-2003 Free Software Foundation, Inc. Contributed by Ulrich Drepper <drepper@gnu.ai.mit.edu>
Copyright (c) 2001 Daniel Phillips
Copyright (C) 2012 Theodore Ts'o. This file may be redistributed under the terms of the GNU Public License.
Copyright (C) 2014 Oracle.
Copyright (C) 2000 Andreas Dilger
Copyright (C) 1995 Gadi Oxman
Copyright (C) 1998, 1999 Theodore Ts'o.
Copyright (C) 1995-1997, 2000-2003 Free Software Foundation, Inc.
Copyright (C) 2018 Collabora Ltd.
Copyright (C) 1994 Theodore Ts'o.
Copyright (c) 2014 SGI. All rights reserved.
Copyright 1997 by Theodore Ts'o.
Copyright (C) 1995-1999, 2000-2003 Free Software Foundation, Inc.
Copyright (C) 2007 Theodore Ts'o.
Copyright (C) 1993, 1994, 1995 Theodore Ts'o.
Copyright Theodore Ts'o, 1996-1999.
Copyright (C) 1993, 1994, 1994, 1995 Theodore Ts'o.
Copyright (C) 1999-2000, 2002-2003 Free Software Foundation, Inc.
Copyright (C) 1995, 1995 Theodore Ts'o.
Copyright 2003 by MIT Student Information Processing Board
Copyright (C) 1991, 1992 Free Software Foundation, Inc. Written April 2, 1991 by John Gilmore of Cygnus Support. Based on mcheck.c by Mike Haertel.
Copyright © 2016 Theodore Tso (msgids) This file is distributed under the same license as the e2fsprogs package. Lauri Nurmi <lanurmi@iki.fi>, 2007, 2015-2016.
Copyright (C) 2001 Theodore Ts'o.
Copyright (C) 2000-2003 Free Software Foundation, Inc. Written by Ulrich Drepper <drepper@cygnus.com>, 2000.
Copyright (C) 1995-1999, 2000-2004 Free Software Foundation, Inc.
Copyright (C) 2007 The Android Open Source Project
(C) 1999 Andrea Arcangeli <andrea@suse.de>
Copyright (C) 1995-1999, 2000-2003 Free Software Foundation, Inc.
Copyright (C) 2004 Sam Hocevar <sam@hocevar.net>
Copyright (C) 2001 by Theodore Ts'o.
(c) 1997 Yann Dirson
Copyright 1996, 1997 by Theodore Ts'o
Copyright 1988, Student Information Processing Board of the Massachusetts Institute of Technology.
Copyright (C) 2019 Theodore Tso (msgids) This file is distributed under the same license as the e2fsprogs package.
Copyright (C) 1992, 1993 Remy Card <card@masi.ibp.fr>
Copyright (C) 2006 by Theodore Ts'o.
Copyright (C) 1996-2001,2003 Free Software Foundation, Inc.
Copyright (C) 1999, 2002-2003 Free Software Foundation, Inc.
Copyright (C) 1996 Theodore Ts'o.
Copyright (C) 2003 Free Software Foundation, Inc. Written by Bruno Haible <bruno@clisp.org>, 2003.
Copyright (c) 1988 Regents of the University of California. All rights reserved.
Copyright (C) 2002 Theodore Ts'o;(c)
Copyright (C) 1993, 1994, 1995, 1996, 1997, 1998, 1999, 2000, 2001, 2002, 2003, 2004, 2005, 2006, 2007, 2008, 2009, 2010, 2011, 2012, 2013, 2014, 2015, 2016, 2017, 2018, 2019 by Theodore Ts'o
Copyright (C) 2001 by Andreas Dilger
Copyright (C) 2002, 2003, 2004, 2005, 2006, 2007, 2008, 2009, 2010, 2011, 2012, 2013, 2014, 2015, 2016, 2017, 2018, 2019 Theodore Tso (msgids). Jakub Bogusz <qboosh@pld-linux.org>, 2002-2018.
Copyright (C) 2000, 2001, 2002, 2003, 2004 by Theodore Ts'o.
Copyright 1993, 1994, 1995 by Theodore Ts'o. All Rights Reserved.
Copyright (C) 1992, 1993, 1994 Remy Card <card@masi.ibp.fr>
Copyright (C) 1994, 1995 Theodore Ts'o.
Copyright 1986, 1987, 1988 by MIT Information Systems
Copyright (C) 1993, 1994, 1995, 1996, 1997, 1998, 1999, 2000, 2001, This file is distributed under the same license as the e2fsprogs package. 2002, 2003, 2004, 2005, 2006, 2007, 2008, 2009, 2010 by Theodore Ts'o. Theodore Ts'o <tytso@mit.edu>, 2010. Gabor Kelemen
Copyright (C) 1993 Theodore Ts'o.
Copyright 1997 Ben Gertzfeld.
Copyright (C) 1992, 1993, 1994, 1995 Remy Card (card@masi.ibp.fr) Laboratoire MASI
Copyright (C) 2002 Theodore Ts'o.
Copyright (C) Andries Brouwer
Copyright (c) 1988 Massachusetts Institute of Technology, Student Information Processing Board. All rights reserved.
Copyright IBM Corporation, 2007 Author Aneesh Kumar K.V <aneesh.kumar@linux.vnet.ibm.com>
Copyright (C) 2001-2002 Free Software Foundation, Inc.
Copyright 1999-2000 Red Hat Software --- All Rights Reserved
Copyright 2001 Andreas Dilger (adilger@turbolinux.com)
Copyright (c) 2003 Theodore Ts'o
Copyright (C) 1995, 1995 Theodore Ts'o.
Copyright 1987, 1988, 1989 Massachusetts Institute of Technology Student Information Processing Board)
Copyright (C) 2014 Robert Yang <liezhi.yang@windriver.com>
Copyright (C) 1992, 1993, 1994 Remy Card <card@masi.ibp.fr> Laboratoire MASI
Copyright 1987 by the Student Information Processing Board of the Massachusetts Institute of Technology
Copyright (C) 1999, Andreas Dilger and Theodore Ts'o
Copyright 1997, 2000, by Theodore Ts'o.
Copyright (C) 2006 Theodore Ts'o <tytso@mit.edu>
Copyright 2014 Google Inc. All Rights Reserved.
Copyright 1998-2000, Theodore Ts'o.
Copyright 2007 by Theodore Ts'o. All Rights Reserved.
Copyright (C) 1992-1996, 1998-2012 Free Software Foundation, Inc.
Copyright (C) 2008 Theodore Ts'o.
Copyright (C) 1994, 1995, 1996, 1997, 1998, 1999, 2000, 2001, 2002, 2003, 2004, 2005 by Theodore Ts'o.
Copyright 1987, 1988 by the Student Information Processing Board of the Massachusetts Institute of Technology
Copyright (C) 1992, 1993, 1994 Remy Card <card@masi.ibp.fr> Laboratoire MASI, Institut Blaise Pascal Universite Pierre et Marie Curie (Paris VI)
Copyright (C) 2007, 2008 Theodore Tso (msgids) David Planella Molas <david.planella@gmail.com>
Copyright (C) 2001 Theodore Ts'o (tytso@mit.edu)
Copyright (C) 2000-2001, 2003 Free Software Foundation, Inc. Written by Ulrich Drepper <drepper@cygnus.com>, 2000.
Copyright (C) 2002 Theodore Ts'o <tytso@mit.edu>
Copyright (C) 1993, 1994, 1995, 1996, 1997, 1998, 1999, 2000, 2001, 2002, 2003, 2004, 2005, 2006, 2007, 2008, 2009, 2010, 2011, 2012 by Theodore Ts'o This file is distributed under the same license as the e2fsprogs package.

LICENCE TERMS (cont.)

Theodore Ts'o <tytso@mit.edu>, 2012. Joe Hansen <jloedalto@mit.edu>
Copyright (c) 2005 Ben Gardner <bgardner@wabtec.com>
Copyright 1987 by the Student Information Processing Board of the Massachusetts Institute of Technology
Copyright 1987, 1988, 1989 by MIT
Copyright (C) 1997 Kaz Kylheku <kaz@ashi.footprints.net>
Copyright 1988 by the Massachusetts Institute of Technology.
Copyright (C) 1997 Theodore Ts'o. This file may be redistributed under the terms of the GNU Public License.
Copyright (C) 1997, 1998 by Theodore Ts'o and PowerQuest, Inc.
Copyright (C) 1989,90,91,92,93,94,96,97 Free Software Foundation, Inc. This file is part of the GNU C Library.
(C) 1999 Andrea Arcangeli <andrea@suse.de>;(C) 2002 David Woodhouse <dwmw2@infradead.org>
Copyright 1995, 1996, 1997, 1998, 1999, 2000 by Theodore Ts'o.
Copyright 2004 by Theodore Ts'o.
Copyright (C) 1998 Theodore Ts'o
Copyright (C) 2014 Theodore Tso (msgids)
Copyright (C) 1993, 1994 Theodore Ts'o.
Copyright 2000 by Theodore Ts'o.
Copyright (C) 2014 Oracle.
Copyright (C) 1993, 1994, 1995, 1996, 1997, 1998, 1999, 2000, 2001, 2013 by Theodore Ts'o
Copyright (C) 2007 Theodore Tso (msgids)
Copyright (c) 2003 by Theodore Ts'o
Copyright 1987, 1988, 1989 by Massachusetts Institute of Technology
Copyright 1999 by Theodore Ts'o.
Copyright (C) 1996 by Theodore Ts'o.
(C) 2000 Andreas Gruenbacher, <a.gruenbacher@computer.org>
Copyright (C) 1993, 1994, 1995, 1996, 1997, 1998, 1999 Theodore Ts'o.
Copyright (C) Andrew Tridgell 1999-2004
Copyright (C) 1995, 1996, 1997 Theodore Ts'o <tytso@mit.edu>
Copyright (C) 1996 Theodore Tso (msgids) This file is distributed under the same license as the e2fsprogs package.
Copyright (C) 1994, 1995, 1996 Theodore Ts'o.
Copyright (C) 2006 Cluster File Systems, Inc.
Copyright (C) 2002-2003 Free Software Foundation, Inc.
Copyright (C) 2011 Theodore Ts'o.
Copyright (C) 2010 Red Hat, Inc., Lukas Czerner <lczerner@redhat.com>
Copyright (C) 1995, 1996 Theodore Ts'o.
Copyright (C) 2000 by Theodore Ts'o.
Copyright (C) 2011 Whamcloud, Inc.
Copyright (C) 2006 by Theodore Ts'o
Copyright (C) 1985, 1986, 1988 Richard M. Stallman
Copyright (C) 1993, 1994, 1995 Theodore Ts'o.
Copyright (C) 1996-2015 Free Software Foundation, Inc.
Copyright (C) 2013 Theodore Ts'o.
Copyright (C) 1996, 1997, 1998 Theodore Ts'o.
Copyright (C) 2000 Stephen C. Tweedie
Copyright (C) 1997 by Theodore Ts'o.
Copyright (C) 2008 Red Hat, Inc. All rights reserved. Written by Eric Sandeen <sandeen@redhat.com>
Copyright (c) 2014 SGI.
Copyright (c) 2012, Intel Corporation. All Rights Reserved.
Copyright 1987,1988 Massachusetts Institute of Technology
Copyright (C) 2001, 2003 Theodore Y. Ts'o
Copyright 1996-2014 Free Software Foundation, Inc. Taken from GNU libtool, 2001 Originally by Gordon Matzigkeit <gord@gnu.ai.mit.edu>, 1996
Copyright 2000, International Business Machines Corporation and others. All Rights Reserved.
Copyright (C) 1995-1998, 2000-2003 Free Software Foundation, Inc.
Copyright 2000 Red Hat corp --- All Rights Reserved
Copyright (C) 1994 Theodore Ts'o.
Copyright (C) 2000 Free Software Foundation, Inc.
Copyright (c) 2017 Oracle. All Rights Reserved.

Copyright 2014 by Oracle, Inc.
copyright (C) 2007 Cluster File Systems, Inc
Copyright (C) 1993, 1994, 1995, 1996 Theodore Ts'o.
Copyright 2000, 2001 by Theodore Ts'o.
Copyright 1997, 1998 by Theodore Ts'o.
Copyright (C) 2012 Zheng Liu <wenqing.lz@taobao.com>
Copyright 1998 Carnegie Mellon University
Copyright (C) 1996, 1997, 1998, 1999 Theodore Ts'o.
Copyright IBM Corporation, 2007 Author Jose R. Santos <jrs@us.ibm.com>
Copyright (c) 1994 Ulrich Windl ALte Regensburger Strasse 11a D-93149 Nittenau, Germany Ulrich.Windl@rz.uni-regensburg.de> SELF=`basename \$0` AWKFILE=/tmp/\${SELF}.awk TEMPFILE=/tmp/\${SELF}.tmp echo 'BEGIN { print "B"
Copyright (C) 1994, 1995, 1996, 2003 Theodore Ts'o.
Copyright (C) 2003 Free Software Foundation, Inc. Written by Bruno Haible <bruno@clisp.org>, 2003.
Copyright 1997 by Theodore Ts'o. All Rights Reserved.
Copyright (C) 2000-2003 Free Software Foundation, Inc.
Copyright (C) 1994, 1995, 1996, 1997, 1998, 1999, 2000, 2001 Theodore Ts'o. This file may be redistributed under the terms of the GNU Public License.
Copyright (C) Andrew Tridgell 1999-2005
Copyright (C) 2001 Andreas Gruenbacher, <a.gruenbacher@computer.org>
copyright abandoned. Code was subsequently included in the kernel, thus was re-licensed under the GNU GPL v2.
Copyright (c) 1993, 1994, 1995, 1996, 1997, 1998, 1999, 2000, 2001, 2002, 2003, 2004, 2005, 2006, 2007, 2008, 2009, 2010, 2011, 2012, 2013, 2014, 2015, 2016, 2017, 2018 by Theodore Ts'o This file is distributed under the same license as the e2fsprogs package. Theodore Ts'o
Copyright 2006 by Theodore Ts'o. All Rights Reserved. This file may be copied under the terms of the GNU Public License.
Copyright (C) 2009 Sun Microsystems, Inc.
Copyright (C) 1995, 1996, 1997, 1998 Free Software Foundation, Inc.
Copyright (C) 2011 Theodore Ts'o. This file may be redistributed under the terms of the GNU Public License.
Copyright (C) 2004 Theodore Ts'o.
Copyright © 2014 Theodore Tso (msgids)
Copyright (C) 1995, 1997, 2000-2003 Free Software Foundation, Inc.
Copyright (C) 2000-2001, 2003 Free Software Foundation, Inc. Written by Ulrich Drepper <drepper@cygnus.com>, 2000.
Copyright 2003 by Theodore Ts'o. All Rights Reserved. This file may be copied under the terms of the GNU Public License.
Copyright (C) 2007 Theodore Ts'o.
Copyright (C) Andrew Tridgell 2005
Copyright (C) 1989, 1991 Free Software Foundation, Inc. 51 Franklin Street, Fifth Floor, Boston, MA 02110-1301 USA Everyone is permitted to copy and distribute verbatim copies of this license document, but changing it is not allowed.
Copyright (C) 1995, 1997-1998, 2000-2003 Free Software Foundation, Inc.
Copyright 1995, 1996, 1997, 1998, 1999, 2000, 2001, 2002, 2003, 2004, 2005, 2006, 2007, 2008, 2009, 2010 by Theodore Ts'o. This file may be redistributed under the GNU Public License v2.
Copyright 1987, 1988 by MIT Student Information Processing Board.
Copyright (c) 2007 Theodore Ts'o
Copyright (C) 2001 Andreas Dilger
Copyright (C) 2016 The Android Open Source Project
Copyright (C) 2001, 2003 Theodore Ts'o.
Copyright (C) 1995,1996,1997,1998,1999,2000,2008 Theodore Ts'o.
Copyright (C) 1997, 1998, 2001, 2003, 2005 by Theodore Ts'o.
(c) The contribution was provided directly to me by some other;(c) and I have not modified it.
Copyright (C) 2005 by Theodore Ts'o.
Copyright 2007, 2008, 2009.
Copyright (C) Andrew Tridgell 1999-2000
Copyright (c) 1988 Massachusetts Institute of Technology, Student Information Processing Board.
Copyright (c) 1997 by Theodore Ts'o.

LICENCE TERMS (cont.)

Copyright 1998-2000 Red Hat, Inc --- All Rights Reserved
Copyright (C) 1993, 1994, 1995, 1996, 1997 Theodore Ts'o
Copyright (c) 1994-2008 Carnegie Mellon University. All rights reserved.
Copyright (c) 2000 Silicon Graphics, Inc. All Rights Reserved.
Copyright (C) 1995, 1997, 2000-2002, 2004 Free Software Foundation, Inc.
Copyright (C) 2001 Theodore Ts'o. This file may be redistributed under the terms of the GNU Public License.
Copyright (c) 2014 Google, Inc.
Copyright (C) 2004, 2013 2014 Theodore Tso (msgids)
Copyright (C) 2000-2004 Free Software Foundation, Inc.
Copyright (C) 2008 Theodore Tso (msgids)
Copyright (C) 2001 Red Hat, Inc.
Copyright Oracle, 2014 Author Darrick J. Wong <darrick.wong@oracle.com>
Copyright 1999 Andreas Dilger (adilger@enel.ucalgary.ca)
Copyright (C) 1996-1999, 2000-2003 Free Software Foundation, Inc. Contributed by Ulrich Drepper <drepper@cygnus.com>, 1996.
Copyright 1996 by Theodore Ts'o
Copyright (C) 1995, 1996, 2002 Theodore Ts'o.
Copyright (C) 1995-1999, 2000-2001, 2003 Free Software Foundation, Inc.
Copyright (C) 1985, 1986, 1988, 1990, 1991, 1992, 1993, 1994, 1995, 1996, 1997, 1998, 1999, 2000, 2001, 2002, 2003, 2004, 2005, 2006 Free Software Foundation, Inc.
Copyright (C) 2014 Theodore Ts'o. This file may be redistributed under the terms of the GNU Public License.
Copyright 2014, Oracle, Inc.
Copyright (C) 2005, 2006 by Theodore Ts'o.
Copyright © 2003, 2005, 2006, 2008, 2009, 2010, 2011, 2012, 2014, 2016, 2017, 2018, 2019 Theodore Tso (msgids)
Copyright (C) 2000-2003 Free Software Foundation, Inc.
Copyright 1987, 1988, 1989 Massachusetts Institute of Technology Student Information Processing Board
Copyright (C) 1995-1998, 2000-2001, 2003 Free Software Foundation, Inc. Contributed by Ulrich Drepper <drepper@gnu.ai.mit.edu>, 1995.
Copyright (c) 2003-2007 Theodore Ts'o <tytso@mit.edu>
Copyright (c) 2003-2006 Theodore Ts'o <tytso@mit.edu>
(C) Copyright 2003, 2004, 2008 by Theodore Ts'o.
Copyright 2015, Google, Inc.
Copyright (C) 1996-2018 Free Software Foundation, Inc.
Copyright (C) 2003 Theodore Ts'o.
Copyright 1990, 1991, 1992 Free Software Foundation, Inc. Written May 1989 by Mike Haertel.
Copyright (C) 2014 Theodore Tso (msgids)
Copyright (C) 2008, 2009, 2015, 2018, 2019 Theodore Tso (msgids) This file is distributed under the same license as the e2fsprogs package. Sharuzzaman Ahmat Raslan <sharuzzaman@gmail.com>, 2008, 2009, 2015, 2018, 2019.
Copyright (C) 1999, 2000, 2003 by Theodore Ts'o
Copyright (C) 2001 by Andreas Dilger
Copyright (C) 2004 Kay Sievers <kay.sievers@vrfy.org>
Copyright @copyright{} 1997, 1998, 1999, 2000, 2001, 2002, 2003, 2004, 2005, 2006, 2007, 2008, 2009, 2010, 2011, 2012, 2013, 2014 Theodore Ts'o
Copyright 1995, 1996, 1997, 1998, 1999 by Theodore Ts'o
Copyright 1999 by David Beattie
Copyright 1995, 1996, 1997, 1998, 1999 by Theodore Ts'o
Copyright 1999 by David Beattie
Copyright (C) 1999, 2000, 2003, 2004 by Theodore Ts'o
Copyright (C) 1999, 2000, 2003, 2004 by Theodore Ts'o
Copyright (C) 2003 Theodore Ts'o
Copyright (C) 1995 Gadi Oxman\n")
Copyright (C) 2001 Andreas Dilger
Copyright (c) 2002 Theodore Ts'o.
Copyright (C) 2000 Theodore Ts'o
Copyright (C) 1999 Red Hat Software
Copyright 1995, 1996, 1997, 1998, 1999, 2000 by Theodore Ts'o.
Copyright (C) 1991, 1992 Linus Torvalds

Copyright (C) 1999, 2000, 2001, 2002, 2003 Theodore Ts'o
Copyright (C) 1992, 1993, 1994, 1995 Remy Card (card@masi.ibp.fr) Laboratoire MASI - Institut Blaise Pascal
Universite Pierre et Marie Curie (Paris VI)
Copyright (C) 1991, 1992 Linus Torvalds
Copyright (C) 1992, 1993, 1994, 1995 Remy Card (card@masi.ibp.fr) Laboratoire MASI - Institut Blaise Pascal
Universite Pierre et Marie Curie (Paris VI)
Copyright (C) 2003 VMware, Inc.
Copyright (c) 2008 John Darrington <j.darrington@elvis.murdoch.edu.au>
Copyright (c) 2018 Nicholas Clark <nicholas.clark@gmail.com>
Copyright (c) 2008 John Darrington <j.darrington@elvis.murdoch.edu.au>
Copyright (c) 2018 Nicholas Clark <nicholas.clark@gmail.com>
Copyright 1995, 1996, 1997 by Theodore Ts'o.
Copyright (C) 1999, 2001 by Andries Brouwer
Copyright (C) 1999, 2000, 2003 by Theodore Ts'o
Copyright (C) 2012 Free Software Foundation, Inc.
Copyright (C) 1995, 1996, 1997 Theodore Ts'o <tytso@mit.edu>
Copyright (C) 1987, 1988 Student Information Processing Board of the Massachusetts Institute of Technology.
Copyright @copyright{} 1987, 1988 by the Student Information Processing Board of the Massachusetts Institute of Technology.
Copyright (C) 1987, 1988 Student Information Processing Board of the Massachusetts Institute of Technology.
Copyright @copyright{} 1987, 1988 by the Student Information Processing Board of the Massachusetts Institute of Technology.
Copyright (C) 1999, 2000 by Theodore Ts'o
Copyright (c) 1997, 1998, 2001 Kungliga Tekniska Högskolan Royal Institute of Technology, Stockholm, Sweden). All rights reserved.
Copyright (c) 1997, 1998, 2001 Kungliga Tekniska Högskolan Royal Institute of Technology, Stockholm, Sweden). All rights reserved.
Copyright (C) 2001 by Andreas Dilger
Copyright (C) 2006, 2007 by Andreas Dilger <adilger@clusterfs.com>
Copyright (C) 1986 Richard M. Stallman"
Copyright (C) 1986 Richard M. Stallman"
Copyright (C) 1998 Andrey Shedel (andreys@ns.cr.cyco.com)
Copyright (C) 2004-2015 Free Software Foundation, Inc. This is free software
Copyright (C) 2010-2015 Free Software Foundation, Inc. This is free software
Copyright (c) 2003-2005 Silicon Graphics, Inc.
Copyright (c) 2018 Collabora Ltd. All rights reserved.
Copyright (C) 2002 Andreas Dilger.
Copyright 1998 by Theodore Ts'o and PowerQuest, Inc. All rights reserved.
Copyright 1998 by Theodore Ts'o and PowerQuest, Inc. All rights reserved.
Copyright (C) Jeremy Allison 2000-2006
Copyright (C) Paul 'Rusty' Russell 2000
Copyright (C) 2002 Theodore Ts'o.
Copyright © 2014 Free Software Foundation, Inc.
Copyright (C) 1984, 1989, 1990, 2000, 2001, 2002 Free Software Foundation, Inc.
Copyright (C) Andrew Tridgell 1999-2005
Copyright (C) 1991 Free Software Foundation, Inc. 51 Franklin Street, Fifth Floor, Boston, MA 02110-1301 USA
Everyone is permitted to copy and distribute verbatim copies of this license document, but changing it is not allowed.
Copyright (C) 1991 Free Software Foundation, Inc. 51 Franklin Street, Fifth Floor, Boston, MA 02110-1301 USA
Everyone is permitted to copy and distribute verbatim copies of this license document, but changing it is not allowed.
Copyright (C) 1985-2005 by the Massachusetts Institute of Technology.
Copyright (C) 1985-2005 by the Massachusetts Institute of Technology.
Copyright (C) Paul 'Rusty' Russell 2000
Copyright (C) Jeremy Allison 2000
Copyright (C) Andrew Esh 2001
Copyright (c) 1997 Mark Habersack
Copyright (C) 1995 Gadi Oxman. Para>
Copyright (C) 1995 Gadi Oxman. Para>

LICENCE TERMS (cont.)

Copyright (C) 1992, 1993, 1994 Remy Card (card@masi.ibp.fr) Laboratoire MASI - Institut Blaise Pascal Universite Pierre et Marie Curie (Paris VI)
Copyright © 1996 Free Software Foundation, Inc. Michel Robitaille <robitail@IRO.UMontreal.CA>, traducteur depuis/ since 1996. Samuel Thibault <samuel.thibault@ens-lyon.org>, 2006-2018.
Copyright (C) 1994 Theodore Ts'o
Copyright (C) 1999, 2000, 2001, 2002, 2003, 2004 by Theodore Ts'o
Copyright (C) 1999, 2000, 2001, 2002, 2003, 2004, 2005, 2006, 2007 by Theodore Ts'o
Copyright (C) 1999, 2000, 2001, 2002, 2003, 2004, 2005, 2006, 2007 by Theodore Ts'o
Copyright 1987, 1988, 1989 by the Massachusetts Institute of Technology"
Copyright 1987, 1988, 1989 by the Massachusetts Institute of Technology"
Copyright (c) 1997-2003 Yann Dirson <dirson@debian.org>
Copyright (c) 2001 Alcove <http://www.alcove.com/>
Copyright (c) 1997 Klee Dienes
Copyright (c) 1995-1996 Michael Nonweiler <mnr20@cam.ac.uk>
Copyright (c) 1993, 1994, 1995, 1996, 1997, 1998, 1999, 2000, 2001, 2002, 2003, 2004, 2005, 2006, 2007, 2008 by Theodore Ts'o
Copyright 1987 by the Student Information Processing Board of the Massachusetts Institute of Technology
Copyright (c) 1997-2003 Yann Dirson <dirson@debian.org>
Copyright (c) 2001 Alcove <http://www.alcove.com/>
Copyright (c) 1997 Klee Dienes
Copyright (c) 1995-1996 Michael Nonweiler <mnr20@cam.ac.uk>
Copyright (c) 1993, 1994, 1995, 1996, 1997, 1998, 1999, 2000, 2001, 2002, 2003, 2004, 2005, 2006, 2007, 2008 by Theodore Ts'o
Copyright 1987 by the Student Information Processing Board of the Massachusetts Institute of Technology
Copyright (c) 1993, 1994, 1995, 1996, 1997, 1998, 1999, 2000, 2001, 2002, 2003, 2004, 2005, 2006, 2007, 2008 by Theodore Ts'o
Copyright (C) 2000-2002, 2006, 2008-2014, 2016 Free Software Foundation, dnl Inc.
Copyright 2012-2016 Free Software Foundation, Inc.
Copyright (C) 2006, 2009-2016 Free Software Foundation, Inc.
Copyright (C) 1995-2014, 2016 Free Software Foundation, Inc.
Copyright (C) 2000-2002, 2004, 2008, 2010-2016 Free Software Foundation, dnl Inc.
Copyright (C) 2000-2002, 2007-2014, 2016 Free Software Foundation, Inc.
Copyright (C) 2002, 2007-2008, 2010-2016 Free Software Foundation, Inc.
Copyright (C) 2004-2014, 2016 Free Software Foundation, Inc.
Copyright (C) 2002-2005, 2008-2016 Free Software Foundation, Inc.
Copyright (C) 1997-2002, 2006, 2008-2016 Free Software Foundation, Inc.
Copyright (C) 1997-2004, 2006, 2008-2016 Free Software Foundation, Inc.
Copyright (C) 1995-2002, 2004-2005, 2008-2014, 2016 Free Software dnl Foundation, Inc.
Copyright (C) 1996-2003, 2009-2016 Free Software Foundation, Inc.
Copyright (C) 2001-2016 Free Software Foundation, Inc.
Copyright (C) 2001-2005, 2008-2016 Free Software Foundation, Inc.
Copyright (C) 2005-2016 Free Software Foundation, Inc.
Copyright (C) 1999-2007, 2009-2016 Free Software Foundation, Inc.
Copyright (C) 1995-2003, 2005-2006, 2008-2014, 2016 Free Software dnl Foundation, Inc.
Copyright © 2004 Scott James Remnant <scott@netsplit.com>.
Copyright © 2012-2015 Dan Nicholson <dbn.lists@gmail.com>
Copyright (C) 2003, 2007, 2009-2016 Free Software Foundation, Inc.
Copyright (C) 1996-2003, 2005, 2008-2016 Free Software Foundation, Inc.
Copyright (C) 2003, 2005-2006, 2008-2016 Free Software Foundation, Inc.
Copyright (C) 1997-2004, 2007-2016 Free Software Foundation, Inc.
Copyright (C) 2005, 2008, 2010-2016 Free Software Foundation, Inc.
Copyright (C) 2002-2003, 2008-2016 Free Software Foundation, Inc.
Copyright (C) 2003, 2007-2016 Free Software Foundation, Inc.
Copyright (C) 2003-2004, 2008-2016 Free Software Foundation, Inc.
Copyright (C) 2000-2002, 2006, 2008-2014, 2016 Free Software Foundation, dnl Inc.
Copyright 2012-2016 Free Software Foundation, Inc.
Copyright (C) 2006, 2009-2016 Free Software Foundation, Inc.

Copyright (C) 1995-2014, 2016 Free Software Foundation, Inc.
Copyright (C) 2000-2002, 2004, 2008, 2010-2016 Free Software Foundation, dnl Inc.
Copyright (C) 2000-2002, 2007-2014, 2016 Free Software Foundation, Inc.
Copyright (C) 2002, 2007-2008, 2010-2016 Free Software Foundation, Inc.
Copyright (C) 2004-2014, 2016 Free Software Foundation, Inc.
Copyright (C) 2002-2005, 2008-2016 Free Software Foundation, Inc.
Copyright (C) 1997-2002, 2006, 2008-2016 Free Software Foundation, Inc.
Copyright (C) 1997-2004, 2006, 2008-2016 Free Software Foundation, Inc.
Copyright (C) 1995-2002, 2004-2005, 2008-2014, 2016 Free Software dnl Foundation, Inc.
Copyright (C) 1996-2003, 2009-2016 Free Software Foundation, Inc.
Copyright (C) 2001-2016 Free Software Foundation, Inc.
Copyright (C) 2001-2005, 2008-2016 Free Software Foundation, Inc.
Copyright (C) 2005-2016 Free Software Foundation, Inc.
Copyright (C) 1999-2007, 2009-2016 Free Software Foundation, Inc.
Copyright (C) 1995-2003, 2005-2006, 2008-2014, 2016 Free Software dnl Foundation, Inc.
Copyright © 2004 Scott James Remnant <scott@netsplit.com>.
Copyright © 2012-2015 Dan Nicholson <dbn.lists@gmail.com>
Copyright (C) 2003, 2007, 2009-2016 Free Software Foundation, Inc.
Copyright (C) 1996-2003, 2005, 2008-2016 Free Software Foundation, Inc.
Copyright (C) 2003, 2005-2006, 2008-2016 Free Software Foundation, Inc.
Copyright (C) 1997-2004, 2007-2016 Free Software Foundation, Inc.
Copyright (C) 2005, 2008, 2010-2016 Free Software Foundation, Inc.
Copyright (C) 2002-2003, 2008-2016 Free Software Foundation, Inc.
Copyright (C) 2003, 2007-2016 Free Software Foundation, Inc.
Copyright (C) 2003-2004, 2008-2016 Free Software Foundation, Inc.
Copyright (C) 1994 X Consortium
Copyright (C) 1996-2015 Free Software Foundation, Inc. This is free software
Copyright (C) 1999-2018 Free Software Foundation, Inc. Written by Tom Tromey <tromey@cygnus.com>.
Copyright 1992-2019 Free Software Foundation, Inc.
Copyright (C) 1999-2018 Free Software Foundation, Inc.
Copyright (C) 2004-2005, 2007, 2009, 2011-2015 Free Software Foundation, Inc. Written by Scott James Remnant, 2004.
Copyright (C) 2004, 2011-2015 Free Software Foundation, Inc. Written by Scott James Remnant, 2004
Copyright (C) 1996-2001, 2003-2015 Free Software Foundation, Inc. Written by Gordon Matzigkeit, 1996
Copyright (C) 2004-2005, 2007-2008, 2011-2015 Free Software Foundation, Inc. Written by Gary V. Vaughan, 2004
Copyright (C) 2004-2005, 2007-2009, 2011-2015 Free Software Foundation, Inc. Written by Gary V. Vaughan, 2004
Copyright (C) 1996-2018 Free Software Foundation, Inc. Originally written by Fran.cois Pinard <pinard@iro.umontreal.ca>, 1996.
Copyright (C) 2011-2018 Free Software Foundation, Inc.
Copyright (C) 2010-2018 Free Software Foundation, Inc. Written by Peter Rosin <peda@lysator.liu.se>.
Copyright (c) 2019 Expat development team Licensed under the MIT license:
Copyright (c) 1998-2000 Thai Open Source Software Center Ltd and Clark Cooper
Copyright (c) 2017 Expat development team Licensed under the MIT license:
Copyright (c) 1997-2000 Thai Open Source Software Center Ltd
Copyright (C) 1996-2018 Free Software Foundation, Inc.
Copyright (C) 1994-2018 Free Software Foundation, Inc.
Copyright (C) 1992-1996, 1998-2012 Free Software Foundation, Inc.
Copyright (C) 2017 Expat development team Licensed under the MIT license
© Gutiérrez de la Concha Pedro Monreal Gonzalez Rhodri James Rolf Ade Stephen Groat and Core Infrastructure Initiative
Copyright 1999,2000 Clark Cooper <coopercc@netheaven.com> All rights reserved.
Copyright (C) 2011 Free Software Foundation, Inc. This config.lt script is free software; the Free Software Foundation gives unlimited permission to copy, distribute and modify it."
copyright> year>2001</year> holder>&dhusername
Copyright (C) 2019 Expat development team REM Licensed under the MIT license: REM REM Permission is hereby granted, free of charge, to any person obtaining REM a copy of this software and associated documentation files (the REM "Software"), to deal in the Software without restrict

LICENCE TERMS (cont.)

Copyright=Copyright © 1998-2017 Thai Open Source Software Center, Clark Cooper, and the Expat maintainers
AppPublisher=The Expat Developers AppPublisherURL=http://www.libexpat.org/ AppSupportURL=http://www.libexpat.org/
AppUpdatesURL=http://www.libexpat.org/ UninstallDisplayName=Expat XML Parser {#
Copyright (c) 2008 Guido U. Draheim <guidod@gmx.de>
Copyright (c) 2011 Maarten Bosmans <mkbosmans@gmail.com>
Copyright (c) 2014 Mike Frysinger <vapier@gentoo.org>
Copyright (c) 2018 The Expat Authors.
Copyright (C) 2004-2015 Free Software Foundation, Inc. This is free software
Copyright (C) 2010-2015 Free Software Foundation, Inc. This is free software
Copyright 1992-2019 Free Software Foundation, Inc.
Copyright (C) 2014 Free Software Foundation, Inc. This is free software
Copyright (C) 2011 Free Software Foundation, Inc. This config.lt script is free software
Copyright (c) 2001-2017 Expat maintainers
Copyright (c) 2000-2017 Expat development team Licensed under the MIT license:
Copyright (C) 2002-2018 Free Software Foundation, Inc.
Copyright (C) 2011-2018 Free Software Foundation, Inc.
Copyright (C) 2001-2018 Free Software Foundation, Inc.
Copyright (C) 1997-2018 Free Software Foundation, Inc.
Copyright (C) 1999-2018 Free Software Foundation, Inc.
Copyright (C) 1996-2018 Free Software Foundation, Inc.
Copyright (C) 2003-2018 Free Software Foundation, Inc.
Copyright (C) 2009-2018 Free Software Foundation, Inc.
Copyright (C) 2006-2018 Free Software Foundation, Inc.
Copyright (C) 2004-2018 Free Software Foundation, Inc.
Copyright (C) 1996-2001, 2003-2015 Free Software Foundation, Inc. Written by Gordon Matzigkeit, 1996
Copyright (C) 2004-2005, 2007-2009, 2011-2015 Free Software Foundation, Inc. Written by Gary V. Vaughan, 2004
Copyright (C) 2004-2005, 2007-2008, 2011-2015 Free Software Foundation, Inc. Written by Gary V. Vaughan, 2004
Copyright (C) 2004, 2011-2015 Free Software Foundation, Inc. Written by Scott James Remnant, 2004
Copyright (C) 2004-2005, 2007, 2009, 2011-2015 Free Software Foundation, Inc. Written by Scott James Remnant, 2004.
Copyright (c) 2017 Expat development team Licensed under the MIT license:
Copyright (C) 2012 Free Software Foundation, Inc. This configure script is free software
Copyright (C) 2012 Free Software Foundation, Inc. This config.status script is free software
copyright 2010, Patrick Spendrin <ps_ml@gmx.de>
Copyright (c) 2011 Maarten Bosmans <mkbosmans@gmail.com>
Copyright (c) 2011 Maarten Bosmans <mkbosmans@gmail.com>
Copyright (C) 1995-2002 Free Software Foundation, Inc.; Copyright (C) 2001-2003, 2004 Red Hat, Inc.; Copyright (C) 2004-2013 Free Software Foundation, Inc.
Copyright (C) 1997-1999, 2000-2001 Tim Janik and Red Hat, Inc.
Copyright (C) 2001 Red Hat, Inc.
Copyright (c) 2006-2008 Diego Pettenò <flameeyes@gmail.com>
Copyright (C) 2018 Endless Mobile, Inc.
Copyright (C) 2000-2001 Red Hat, Inc.
Copyright © 2010 Codethink Limited
Copyright", "Copyright 1998-2011 Tim Janik, Red Hat, Inc.
Copyright (C) 2016 Red Hat, Inc.
Copyright © 2011 Canonical Ltd.
Copyright (C) 1998-1999, 2000-2001 Tim Janik and Red Hat, Inc.
Copyright (C) 2000-2001 Red Hat, Inc.
Copyright (C) 2010 Collabora, Ltd.
Copyright © 2013 Lars Uebernickel
Copyright (C) 2010 Intel Corp.
Copyright (C) 2008 Red Hat, Inc.
Copyright (C) 2006-2007 Red Hat, Inc.
Copyright 2010, 2013 Red Hat, Inc.
Copyright 2015 Lars Uebernickel
Copyright (C) 2000 Red Hat, Inc.

Copyright 2016 Red Hat, Inc.
Copyright 2018, Red Hat, Inc.
Copyright (C) 2003 Red Hat, Inc.
Copyright 2015 Red Hat, Inc.
Copyright © 2018 Endless Mobile, Inc.
Copyright (C) 2009 Red Hat, Inc.
Copyright (C) 2008-2010 Red Hat, Inc.
Copyright (C) 2008 Imendio AB Authors: Tim Janik
Copyright (C) 2001, 2003 Red Hat, Inc.
Copyright (C) 2005 Imendio AB
Copyright (C) 2006-2009 Red Hat, Inc.
Copyright © 2009 Codethink Limited
Copyright 2012 Red Hat, Inc.
Copyright 2011 Red Hat, Inc.
Copyright (C) 2018 Arthur Demchenkov
Copyright (c) 2015 Remko Tronçon (https://el-tramo.be) Copied from https://github.com/remko/pycotap/
Copyright (C) 2018 Canonical Ltd Authors: Marco Trevisan <marco@ubuntu.com>
Copyright (C) 2009 Benjamin Otte <otte@gnome.org>
Copyright 2015 Collabora Ltd.
Copyright (C) 2010 Red Hat, Inc.
Copyright (C) 1997-1999, 2000-2001 Tim Janik and Red Hat, Inc.
Copyright (C) 2010 Collabora, Ltd.
Copyright (C) 2008 Christian Kellner, Samuel Cormier-Iijima
Copyright © 2012, 2013 Red Hat, Inc.
Copyright © 2009, 2010 Codethink Limited
Copyright © 2013 Canonical Limited
Copyright (C) 2014 Patrick Griffis
Copyright © 2009 Codethink Limited
Copyright (C) 2012 Red Hat, Inc.
Copyright © 2008, 2009 codethink
Copyright (C) 2011 Collabora, Ltd.
Copyright © 2010 Red Hat, Inc.
Copyright 2014-2018 Jan-Michael Brummer <jan.brummer@tabos.org>
Copyright (C) 2011 Red Hat, Inc.
Copyright (C) 2008 Clemens N. Buss <cebuzz@gmail.com>
Copyright © 2015 Canonical Limited
Copyright (C) 2006-2010 Red Hat, Inc.
Copyright (C) 2006 John McCutchan
Copyright (C) 2006 John McCutchan <john@johnmccutchan.com>
Copyright (C) 2005 John McCutchan
Copyright (C) 2005 John McCutchan
Copyright (C) 2006-2007 Red Hat, Inc.
Copyright (C) 2007 John McCutchan
Copyright (C) 1995-1997 Peter Mattis, Spencer Kimball and Josh MacDonald
Copyright", "Copyright 1995-2011 Peter Mattis, Spencer Kimball, Josh MacDonald, Sebastian Wilhelmi and others.
Copyright (C) 2006 John McCutchan
Copyright (C) 2010 Collabora Ltd.
Copyright (C) 2008-2011 Red Hat, Inc.
Copyright © 2010 Red Hat, Inc.
Copyright 2014 Red Hat, Inc.
Copyright © 2009, 2010 Codethink Limited
Copyright (C) 2015 glib's COPYRIGHT HOLDER.GunChleoc <fios@foramnagaidhlig.net>, 2015, 2018.
Copyright (C) 2012 Swecha telugu localisation Team <localization@swecha.net>
Copyright © 2010 Codethink Limited
Copyright (C) 2003 Free Software Foundation, Inc. Raphael Finkel <raphael@cs.uky.edu>, 2003.
Copyright (C) 2003 Red Hat, Inc.
Copyright (C) 2001 - 2010 Free Software Foundation, Inc.

LICENCE TERMS (cont.)

Copyright (C) 2004 Red Hat, Inc.
Copyright (C) YEAR THE PACKAGE'S COPYRIGHT HOLDER.
Copyright (C) 2005 Matthias Clasen <mclasen@redhat.com>
Copyright (C) 2003-2012 Free Software Foundation, Inc.
Copyright (C) 2001-2003, 2005, 2007, 2008 Free Software Foundation, Inc.
Copyright (C) 2001, 2004 Free Software Foundation, Inc.
Copyright (C) 2009, 2010 Free Software Foundation, Inc. He Qiangqiang <carton@263.net>, 2001. Funda Wang <fundawang@linux.net.cn>, 2004, 2005. yetist <yetist@gmail.com>, 2007. Deng Xiyue <manphiz@gmail.com>, 2008, 2009.
Copyright (C) 1995 Free Software Foundation, Inc. Ulrich Drepper <drepper@gnu.ai.mit.edu>, 1995.
Copyright (C) 2003,2004 Red Hat, Inc.
Copyright (C) YEAR THE PACKAGE'S COPYRIGHT HOLDER This file is distributed under the same license as the PACKAGE package.
Copyright (C) 2008, 2010 Collabora, Ltd.
Copyright (C) 2006-2008 Red Hat, Inc.
Copyright © 2008, 2009 Codethink Limited
Copyright © 2001, 2002, 2003, 2004, 2005, 2006, 2007, 2008, 2009, 2010, 2011, 2012, 2013, 2014 glib Distributed under the same licence as the glib package Duarte Loreto <happyguy_pt@hotmail.com>, 2001, 2002, 2003, 2004, 2005, 2006, 2007, 2008, 2009, 2010, 2011, 2012, 2013, 2014.
Copyright (C) 2006 The GNOME Foundation
Copyright (C) 2001, 2002, 2004, 2005, 2008, 2011-2013 Free Software Foundation, Inc.
Copyright (c) 2011, 2012 Dmitry Matveev <me@dmitrymatveev.co.uk>
Copyright (C) 2002 This file is distributed under the same license as the glib package.
Copyright (C) YEAR THE PACKAGE'S COPYRIGHT HOLDER
Copyright (C) 2001, 2006, 2007, 2009 Free Software Foundation, Inc.
Copyright (C) 2002, 2004, 2005, 2006 Sharif FarsiWeb, Inc.
Copyright (C) 2013 glib's COPYRIGHT HOLDER This file is distributed under the same license as the glib package.
Copyright © 2001-2019 Free Software Foundation, Inc.
Copyright © 2008 Christian Kellner, Samuel Cormier-Iijima;© 2009 codethink
Copyright (C) 2001-2018 Free Software Foundation, Inc.
Copyright (C) 2001 Free Software Foundation, Inc.
Copyright (C) 2010 Red Hat, Inc.
Copyright (C) 2001-2004 Free Software Foundation, Inc.
Copyright (C) 2005 THE PACKAGE'S COPYRIGHT HOLDER.
Copyright @ 2006, Free software foundation, Inc. Mindu Dorji.
Copyright (C) 1998-2002, 2004, 2006, 2008, 2010 Free Software Foundation, Inc.
Copyright (C) 2002, 2003, 2004, 2005, 2006, 2007, 2008, 2009, 2010, 2011, 2012, 2013, 2014, 2015 Free Software Foundation, Inc.
Copyright © 2016 GNOME i18n Project for Vietnamese.
Copyright (C) YEAR THE PACKAGE'S COPYRIGHT HOLDER. Jyotshna Shrestha <shresthajyo@hotmail.com>, 2005. Ganesh Ghimire <gghimire@gmail.com>, 2005. Shiva Pokharel <pokharelshiva@hotmail.com>, 2005. Kapil Timilsina <lipak21@gmail.com>, 2005. Jaydeep Bhusal <zaydeep@hotmail.com>, 2005. Shyam
Copyright (C) YEAR THE PACKAGE'S COPYRIGHT HOLDER. Sanlig Badral <badral@chinggis.com>, 2003. Sanlig Badral <Badral@openmn.org>, 2004.
Copyright (C) Croatia team Translators: Denis Lackovic <delacko@fly.srk.fer.hr>, Robert Sedak <robert.sedak@sk.t-com.hr>
Copyright © 2010 Collabora Ltd.
Copyright (C) 2004-2011 Free Software Foundation, Inc.
Copyright © 2010 Red Hat, Inc.
Copyright (C) 2005 THE glib's COPYRIGHT HOLDER
Copyright © 2012 Red Hat, Inc
Copyright (C) 2015 Chun-wei Fan
Copyright (C) 2007 THE glib.HEAD'S COPYRIGHT HOLDER Alaksandar Navicki <zolak@lacinka.org>, 2007.
Copyright (C) 2008-2010 Red Hat, Inc.
Copyright (C) 2002, 2005, 2006 Free Software Foundation, Inc.
Copyright (C) 2010 Christian Kellner
Copyright © 2002-2019 the glib authors.

Copyright © 2009 Free Software Foundation, Inc.
Copyright (C) 2002 Free Software Foundation, Inc. Ge'ez Frontier Foundation <locales@geez.org>, 2002.
Copyright (C) 2010. This file is distributed under the same license as the GLib package.
Copyright © 2008 Christian Kellner, Samuel Cormier-Iijima
Copyright (C) 2003 Free Software Foundation, Inc. This file is distributed under the same license as the glib package.
Copyright (C) YEAR THE PACKAGE'S COPYRIGHT HOLDER This file is distributed under the same license as the PACKAGE package. Gheyret Kenji <gheyret@yahoo.com>, 2010. Sahran <sahran.ug@gmail.com>, 2010. Zeper <zeper@msn.com>, 2010.
Copyright © 2001, 2002, 2003, 2004, 2005, 2006 Free Software Foundation, Inc.
Copyright (C) 2008 Red Hat, Inc.
Copyright (C) 2002, 2003, 2004, 2005, 2006, 2007, 2008, 2009, 2010, 2011 the author(s) of glib.
Copyright (C) 2005-2016 Free Software Foundation, Inc. This file is distributed under the same license as the glib package. Theppitak Karoonboonyanan <theppitak@gmail.com>, 2005-2010, 2013-2014. Akom Chotiphantawanon <knight2000@gmail.com>, 2015-2016.
Copyright (C) 2001,2002,2003, 2006, 2007, 2008 Free Software Foundation, Inc.
Copyright © 2018 Endless Mobile, Inc.
Copyright (C) 2010 glib's COPYRIGHT HOLDER This file is distributed under the same license as the glib package. Nils-Christoph Fiedler <fiedler@medienkompanie.de>, 2010.
Copyright (C) YEAR THE PACKAGE'S COPYRIGHT HOLDER. Erdal Ronahi <erdal.ronahi@gmail.com, pckurd@hotmail.com>, 2005.
Copyright (C) 2002-2011 Free Software Foundation, Inc. This file is distributed under the same license as the glib package.
Copyright (C) 2001, 2004, 2005, 2006, 2007, 2008 Free Software Foundation, Inc
Copyright (C) 2017 Collabora Inc.
Copyright (C) 2001-2003, 2005 Free Software Foundation, Inc. Kjartan Maraas <kmaraas@gnome.org>, 2001-2018. Terance Edward Sola <terance@lyse.net>, 2005. Torstein Adolf Winterseth <kvikende@fsfe.org>, 2010.
Copyright (C) 2001, 2005, 2006, 2007, 2008, 2009 Free Software Foundation, Inc. Proxecto Trasno
Copyright (C) 2001-2015 Free Software Foundation, Inc. This file is distributed under the same license as the glib package. Yannig Marchegay (Kokoyaya) <yannig@marchegay.org>, 2007.;© definit"
Copyright (C) 2006 THE PACKAGE'S COPYRIGHT HOLDER. Meir Kriheli <meirk@microsoft.co.il>, 2002. Gil 'Dolfin' Osher <dolfin@rpg.org.il>, 2002. Gil Osher <dolfin@rpg.org.il>, 2004. Yaron Shahrabani <sh.yaron@gmail.com>, 2010. Yosef Or Boczko <yoseforb@gnome.org>, 2014.
Copyright © 2016 Red Hat, Inc.
Copyright (C) 1995, 1996, 1997 by Ulrich Drepper <drepper@gnu.ai.mit.edu>
Copyright (C) YEAR THE PACKAGE'S COPYRIGHT HOLDER, 2004. Kenan Hadziavdić <kenanh@frisurf.no>, 2004.
Copyright (C) 2001-2004, 2007 Free Software Foundation, Inc. Christian Meyer <chrisime@gnome.org>, 2001, 2002. Christian Neumair <chris@gnome-de.org>, 2002-2004. Hendrik Richter <hendrikr@gnome.org>, 2004-2009. Hendrik Brandt <heb@gnome-de.org>, 2004. Andre Klapper <ak-47@gmx.net>,
Copyright (C) 2002-2006 Free Software Foundation, Inc. This file is distributed under the same license as the glib package.
Copyright (C) 2017 glib's COPYRIGHT HOLDER This file is distributed under the same license as the glib package. Fabio Tomat <f.t.public@gmail.com>, 2017.
Copyright © 2006 Ubuntu Georgian Translators. This file is distributed under the same license as the GLIB package.
Copyright (C) 2010 HZ This file is distributed under the same license as the glib package. Baurzhan Muftakhidinov <baurthefirst@gmail.com>, 2010-2016.
Copyright (C) 2004, 2006, 2007, 2008, 2009, Free Software Foundation, Inc. This file is distributed under the same license as the glib.glib-2-4 package. Id: or.po.v 1.37 2006/08/16 00:43:58 matthiasc Exp \$
Copyright (C) 2005 Free Software Foundation, Inc.
Copyright (C) 2005, 2006, 2007, 2008, 2009, 2010, 2011, 2012, 2013, 2014, 2015, 2016, 2017, 2018, 2019. Free Software Foundation, Inc. This file is distributed under the same license as the glib package.
Copyright © 2008, 2009 Codethink Limited
Copyright (C) Free Software Foundation, 2002.
Copyright (C) 2005 Canonical Ltd. This file is distributed under the same license as the glib package. Translation by Canonical Ltd <translations@canonical.com> with thanks to Translation World CC in South Africa, 2005.
Copyright © 2001, 2002, 2003, 2004, 2005, 2006 Free Software Foundation, Inc.
Copyright (C) YEAR THE PACKAGE'S COPYRIGHT HOLDER This file is distributed under the same license as the

LICENCE TERMS (cont.)

PACKAGE package. Victor Ibragimov <victor.ibragimov@gmail.com>, 2013.
Copyright (C) 2002, 2005, 2006, 2007, 2009 Free Software Foundation, Inc.
Copyright (C) 2001-2012 glib's COPYRIGHT HOLDER Takayuki KUSANO <AE5T-KSN@asahi-net.or.jp>, 2001-2002, 2009-2010. KAMAGASAKO Masatoshi <emerald@gnome.gr.jp>, 2003. Takeshi AIHANA <takeshi.aihana@gmail.com>, 2004-2009. Ryoichi INAGAKI <ryo1@bc.wakwak.com>, 2004. Takayuki KUSANO <AE5T-KSN@asahi-net.or.jp>
Copyright (C) 2001-2019 Free Software Foundation, Inc.
Copyright © 2010 Collabora, Ltd
Copyright (C) 2002, 2004, 2006, 2009 Free Software Foundation, Inc. Simos Xenitellis <simos@hellug.gr>, 2002. Kostas Papadimas <pkst@gmx.net>, 2002. Kostas Papadimas <pkst@gnome.org>, 2004, 2006. Jennie Petoumenou <epetoumenou@gmail.com>, 2009. Fotis Tsamis <ftsamis@gmail.com>, 2009. Mic
Copyright (C) 2004-2005 Adam Weinberger <adamw@gnome.org> This file is distributed under the same licence as the glib package. Adam Weinberger <adamw@gnome.org>, 2004, 2005.
Copyright (C) 2010, Karo Mkrtchyan Karo Mkrtchyan <020113@mail.ru>
Copyright (C) YEAR THE PACKAGE'S COPYRIGHT HOLDER This file is distributed under the same license as the Glib package. Zabeeh Khan <zabeehkan@gmail.com>, 2008.
Copyright © 2011 Canonical Limited
Copyright © 2003-2005, 2007, 2008, 2010 Free Software Foundation, Inc. This file is distributed under the same license as the glib package.
Copyright (C) 2003-2008 Free Software Foundation, Inc. This file is distributed under the same license as the glib package. Laurent Dhima <laurenti@alblinux.net>, 2003-2008.
Copyright © 2011 Red Hat, Inc
Copyright (C) 2010 glib's COPYRIGHT HOLDER This file is distributed under the same license as the glib package. F Wolff <friedel@translate.org.za>, 2010, 2011.
Copyright (C) 2005 This file is distributed under the same license as the glib package. Eric Pareja <xenos@upm.edu.ph>, 2005.
Copyright (C) 2004 glib's COPYRIGHT HOLDER
Copyright (C) 2008-2011 Red Hat, Inc.
Copyright (C) 2008-2018 Red Hat, Inc.
Copyright (C) 2002 Free Software Foundation, Inc.
Copyright (C) 1998 Tim Janik
Copyright (C) 1995-1997 Peter Mattis, Spencer Kimball and Josh MacDonald
Copyright (C) 2000 Tor Lillqvist
Copyright 2012 Red Hat, Inc
Copyright (C) 2018 Red Hat, Inc.
Copyright", "Copyright 2006-2011 Red Hat, Inc. and others.
Copyright (C) 1998, 1999 Tom Tromey
Copyright (C) 2001, James Henstridge
Copyright (C) 2013 Red Hat, Inc. Copy and pasted from accumulator.c and modified.
Copyright (C) 2005 Red Hat, Inc.
Copyright (C) 2006 Behdad Esfahbod
Copyright (C) 2007 Tim Janik
Copyright (C) 2006 Stefan Westerfeld
Copyright (C) 2005 Matthias Clasen
Copyright (C) 2007 Francois Gouget
Copyright (C) 2005 Tim Janik
Copyright (C) 1998, 1999, 2000 Tim Janik and Red Hat, Inc.
Copyright 2000 Red Hat, Inc.
Copyright © 2014 Canonical Limited
Copyright 2001,2005 Red Hat, Inc.
Copyright © 2008 Ryan Lortie
Copyright 2000 Red Hat, Inc. g_execvpe implementation based on GNU libc execvp:
Copyright (C) 1995-1997, 2002 Peter Mattis, Red Hat, Inc.
Copyright 2018 Emmanuele Bassi
Copyright (C) 2007 Imendio AB Authors: Tim Janik
Copyright (C) 2004 Sharif FarsiWeb, Inc
Copyright (C) 2001 Behdad Esfahbod.

Copyright (C) 1998-2000 Red Hat, Inc.
Copyright (C) 1999, 2000 Scott Wimer
Copyright 2004 Red Hat, Inc.
Copyright © 2010 Novell, Inc.
Copyright 2016 Endless Mobile, Inc.
Copyright 2018 Collabora Ltd.
Copyright 2017 Red Hat, Inc.
Copyright © 2007, 2008 Ryan Lortie
Copyright (C) 1995-1997, 1999 Peter Mattis, Red Hat, Inc.
Copyright © 2008 codethink
Copyright (C) 1995-1998 Peter Mattis, Spencer Kimball and Josh MacDonald
Copyright (C) 2000-2017 Julian Seward. All rights reserved.
Copyright (C) 1999 Tom Tromey
Copyright (C) 2008 Christian Kellner, Samuel Cormier-Iijima
Copyright © 2015 Patrick Griffis
Copyright (C) 2000 Free Software Foundation, Inc.
Copyright (C) 2000-2001 Free Software Foundation, Inc.
Copyright (C) 2000-2003 Free Software Foundation, Inc. This file is part of the GNU CHARSET Library.
Copyright (C) 2003 Free Software Foundation, Inc. This file is part of the GNU CHARSET Library.
Copyright (C) 2000-2006 Free Software Foundation, Inc.
Copyright (C) 2000-2002, 2004 Free Software Foundation, Inc.
Copyright (C) 2000-2004, 2006 Free Software Foundation, Inc.
Copyright (C) 2000-2002 Free Software Foundation, Inc.
Copyright (C) 2012 Colin Walters <walters@verbum.org>
Copyright (C) 2003 Matthias Clasen
Copyright (C) 1999, 2002-2016 Free Software Foundation, Inc.
Copyright (C) 2002-2004, 2007-2016 Free Software Foundation, Inc.
Copyright (C) 2005-2006, 2009-2016 Free Software Foundation, Inc.
Copyright (C) 1999-2000, 2002-2003, 2006-2016 Free Software Foundation, Inc.
Copyright (C) 1999, 2002-2003, 2005, 2007, 2010-2016 Free Software Foundation, Inc.
Copyright (C) 1999, 2002-2003, 2005-2007, 2009-2016 Free Software Foundation, Inc.
Copyright (C) 1999, 2002-2003, 2006-2007, 2011-2016 Free Software Foundation, Inc.
Copyright (C) 2003, 2008-2016 Free Software Foundation, Inc.
Copyright (C) 1999, 2002, 2006, 2009-2016 Free Software Foundation, Inc.
Copyright (C) 2004 Anders Carlsson <andersca@gnome.org>
Copyright © 2014 NICE s.r.l.
Copyright (C) 2003 Sebastian Wilhelm
Copyright 2005 Matthias Clasen
Copyright 2004 Tor Lillqvist
Copyright (C) 2002, 2003, 2004, 2005, 2006, 2007 Soeren Sandmann (sandmann@daimi.au.dk)
Copyright (C) 2015 Red Hat, Inc.
Copyright (C) 2006-2007 Red Hat, Inc. 2009 Benjamin Otte
Copyright 2011-2018 Red Hat, Inc.
Copyright (C) 2006 Alexander Larsson <alexl@redhat.com>
Copyright (C) 2011 Red Hat, Inc Author: Matthias Clasen
Copyright (C) 1991, 1992, 1996, 1997, 1999, 2004 Free Software Foundation, Inc.
Copyright 2015 Lars Uebornickel
Copyright 2000 Red Hat, Inc.
Copyright (C) 2013 Red Hat, Inc Author: Matthias Clasen
Copyright (C) 2007 Imendio AB Authors: Tim Janik, Sven Herzberg
Copyright (C) 2009 Red Hat, Inc. Authors: Alexander Larsson <alexl@redhat.com>
Copyright (C) 2013-2015, 2017 Red Hat, Inc.;© Lureau <marcandre.lureau@redhat.com>
Copyright (C) 2008 Red Hat, Inc. Authors: Tomas Bzatek <tbzatek@redhat.com>
Copyright (C) 2011 Collabora Ltd.
Copyright 2011, 2013 Red Hat, Inc.
Copyright (C) 1999, 2003 Red Hat Software
Copyright (C) 2008 Red Hat, Inc

Copyright (C) 2008 Red Hat, Inc. Author: Matthias Clasen
Copyright (C) 2018 Igalia S.L.
Copyright (C) 2010-2012 Collabora Ltd. Authors: Xavier Claessens <xclasse@gmail.com> Mike Ruprecht <mike.ruprecht@collabora.co.uk>
Copyright (C) 2011 Stef Walter <stefw@collabora.co.uk>
Copyright (C) 2012 Collabora Ltd. <http://www.collabora.co.uk/>
Copyright (C) Matthew Waters <matthew@centricular.com>.
Copyright (C) 1995-1998 Peter Mattis, Spencer Kimball and Josh MacDonald
Copyright (C) 2008-2018 Red Hat, Inc.
Copyright (C) 2011 Red Hat, Inc.
Copyright (C) 2007 Emmanuele Bassi <ebassi@gnome.org>
Copyright (C) 2007 Emmanuele Bassi <ebassi@gnome.org>
Copyright (C) 2007 Sven Herzberg
Copyright (C) 2008-2009 Red Hat, Inc.
Copyright (C) 2009-2010 Christian Hergert <chris@dronelabs.com>
Copyright (C) 2008-2013 Red Hat, Inc.
Copyright © 2006-2010 Red Hat, Inc.
Copyright © 2008-2010 Red Hat, Inc.
Copyright 2004 Tor Lillqvist
Copyright © 2011 Ryan Lortie
Copyright (C) 1999, 2000 Tom Tromey
Copyright (C) 2012 Red Hat, Inc Author: Matthias Clasen
Copyright 2012-2019 Red Hat, Inc.
Copyright", "Copyright 1995-2011 Peter Mattis, Spencer Kimball, Josh MacDonald and others.
Copyright © 2012 Collabora Ltd.
Copyright (C) 2000-2003 Tim Janik
Copyright (c) 1997-2012 University of Cambridge
Copyright © 2009 Ryan Lortie
Copyright © 2017 Endless Mobile, Inc.
Copyright (C) 2018-2019 Patrick Griffis, James Westman
Copyright (C) 2005-2006 Emmanuele Bassi
Copyright (C) 2012 Red Hat Inc.
Copyright 2000, 2003 Red Hat, Inc.
Copyright (C) 2013 Collabora, Ltd.
Copyright Red Hat Inc., 2000 Authors: Havoc Pennington <hp@redhat.com>, Owen Taylor <otaylor@redhat.com>
Copyright (C) 2018 Collabora Inc.
Copyright © 2015 Collabora Ltd.
Copyright (C) 2013 Red Hat, Inc.
Copyright (C) 2010 Collabora Ltd. Authors: Xavier Claessens <xclasse@gmail.com>
Copyright (C) 2008 Red Hat, Inc. Authors: Matthias Clasen <mclasen@redhat.com>
Copyright © 2009-10 Sam Thursfield
Copyright © 2011 William Hua
Copyright 2018 Red Hat, Inc.
Copyright (C) 2013 Collabora Ltd.
Copyright © 2012,2013 Colin Walters <walters@verbum.org>
Copyright 2013 Red Hat, Inc.
Copyright 2011 Red Hat, Inc
Copyright © 2010 Collabora, Ltd.
Copyright 2011 Collabora Ltd.
Copyright (C) 2010 Sven Herzberg
Copyright (C) 2010 Mikhail Zabaluev <mikhail.zabaluev@gmail.com>
Copyright (C) 2007 Patrick Hulin
Copyright © 2008 Ryan Lortie
Copyright (C) 2013-2015, 2017 Red Hat, Inc.
Copyright (C) 2001 Matthias Clasen <matthiasc@poet.de>
Copyright (C) 2005 - 2006, Marco Barisione <marco@barisione.org>
Copyright (C) 2009,2010 Red Hat, Inc.

Copyright (C) 2009-2010 Christian Hergert <chris@dronelabs.com>
Copyright 2018 Collabora Ltd.
Copyright 2015 Canonical Limited
Copyright © 2011 Nokia Corporation
Copyright © 2012 Red Hat, Inc.
Copyright (C) 1991, 1999 Free Software Foundation, Inc.
Copyright (C) 1998, 2000 Tim Janik
Copyright © 2007 Ryan Lortie
Copyright", "Copyright 1998-2011 Tim Janik and others.
Copyright (C) 2007 Openismus GmbH Authors: Matthias Hasselmann
Copyright (C) 1998, 2000 Tim Janik
Copyright (C) 1995-1998, 2000, 2001 Free Software Foundation, Inc.
Copyright (C) 2005 Red Hat
Copyright (C) 2003 Noah Levitt
Copyright (C) 2005 Alexander Larsson <alexl@redhat.com>
Copyright 2004 Red Hat, Inc.
Copyright (c) 2006-2008 xine project
Copyright (c) 2012 Lucas De Marchi <lucas.de.marchi@gmail.com>
Copyright (C) 2005 Imendio AB
Copyright 2015 Ryan Lortie
Copyright (C) 2010 Christian Persch
Copyright (C) 2014 Red Hat, Inc.
Copyright© Lureau <marcandre.lureau@redhat.com>
Copyright © 2012, 2013 Canonical Limited
Copyright © 2010 Red Hat, Inc.
Copyright © 2009 Red Hat, Inc
Copyright © 2009 Red Hat, Inc
Copyright © 2018 Igalia S.L.
Copyright (c) 1997-2006 University of Cambridge.
Copyright (c) 1997-2006 University of Cambridge.
Copyright © 2015 Canonical Limited
Copyright (C) 2007 Sebastian Dröge.
Copyright 1998 Sebastian Wilhelm
Copyright (C) 2009 Codethink Limited
Copyright © 2015 Collabora, Ltd.
Copyright © 2011 Canonical Limited
Copyright (C) 2003 Jonathan Blandford <jrb@alum.mit.edu>
Copyright (C) 200 Matthias Clasen <mclasen@redhat.com>
Copyright (C) 2004 Matthias Clasen <mclasen@redhat.com>
Copyright (C) 2003,2004 Jonathan Blandford <jrb@alum.mit.edu>
Copyright (C) 2008 Nokia Corporation. All rights reserved.
Copyright © 2009 Red Hat, Inc.
Copyright (C) 2016, 2017, 2018, 2019 Free Software Foundation, Inc. Christopher R. Gabriel <cgabriel@pluto.linux.it> 2002.
Copyright (C) 2008 Hans Breuer
Copyright (C) 2012 Collabora Ltd. <http://www.collabora.co.uk/>
Copyright (C) 2007—2011 The GNOME Project.
Copyright © 2009 Codethink Limited
Copyright (C) 2018 Igalia S.L.
Copyright (C) 2004, 2005 Miloslav Trmac <mitr@volny.cz>.
Copyright (C) 2006 Lukas Novotny <lukasnov@cvs.gnome.org>.
Copyright (C) 2007 Jürg Billeter
Copyright © 2010 Novell, Inc.
Copyright © 2009 Codethink Limited
Copyright (C) 2010, 2011, 2012, 2013, 2015 Free Software Foundation, Inc.
Copyright (C) 2016 Free Software Foundation, Inc. Borislav Aleksandrov <B.Aleksandrov@cnsys.bg>, 2002.
Alexander Shopov <ash@kambanaria.org>, 2002, 2005, 2006, 2007, 2008, 2009, 2010, 2011. Alexander Shopov

LICENCE TERMS (cont.)

<ash@kambanaria.org>, 2012, 2013, 2015, 2016. Damyan Ivanov <dam+gnome@ktnx.net>, 201
Copyright (C) 2018 Ifigo Martinez <inigomartinez@gmail.com>
Copyright (C) 2001 Red Hat Software
Copyright © 2007 Ryan Lortie
Copyright (C) 2003, Red Hat, Inc.
Copyright (C) 2008 Novell, Inc.
Copyright (C) 2014 Chun-wei Fan
Copyright (C) 2006-2007 Red Hat, Inc.
Copyright (C) 2007 Tim Janik
Copyright (C) 2015 Chun-wei Fan
Copyright (C) 1995-1999,2000,2001 Free Software Foundation, Inc. Written by Ulrich Drepper <drepper@cygnus.com>, 1995.
Copyright © 2010 Codethink Limited
Copyright 1991, 92, 95, 96, 97, 98, 99 Free Software Foundation, Inc.
Copyright (C) 2001,2002,2004 Behdad Esfahbod
Copyright 1998-2001 Sebastian Wilhelm
Copyright 2001 Hans Breuer
Copyright 2001 Hans Breuer
Copyright 2004 Tor Lillqvist
Copyright (C) 2004, Matthias Clasen <mclasen@redhat.com>
Copyright (C) 2005 - 2007, Marco Barisione <marco@barisione.org>
Copyright 2009-2010 Collabora Ltd.
Copyright 2009 Nokia Corporation
Copyright (C) 1998 Tim Janik
Copyright © 2009, 2010 Codethink Limited
Copyright (C) 2000 Sebastian Wilhelm
Copyright 1998 Owen Taylor
Copyright 1998 Owen Taylor
Copyright 2008 Red Hat, Inc.
Copyright (C) 1994, 1996, 1997 Free Software Foundation, Inc.
Copyright (C) 2000 Red Hat, Inc.
Copyright (C) 2009 Codethink Limited
Copyright (C) 2000-2003 Ximian Inc.
Copyright (C) 2000 Eazel, Inc.
Copyright (C) 1995-1997 Peter Mattis, Spencer Kimball and Josh MacDonald
Copyright (C) 1992,95-97,99,2000,01,02,04,07 Free Software Foundation, Inc. Written by Mike Haertel, September 1988.
Copyright 2003 Tor Lillqvist
Copyright (C) 2004 Anders Carlsson <andersca@gnome.org>
Copyright (C) 2011 Nokia Corporation
Copyright (C) 1998-1999 Tor Lillqvist
Copyright (C) 1995, 1996, 1997, 1998 Free Software Foundation, Inc.
Copyright (C) 1995, A.M. Kuchling
Copyright (C) 2006 Dave Benson Released under the terms of the GNU Lesser General Public License
Copyright (C) 1995, A.M. Kuchling
Copyright (C) 2006 Dave Benson Released under the terms of the GNU Lesser General Public License
Copyright (C) 1997, 1998 Tim Janik
Copyright © 2011 Nokia Corporation
Copyright 2000, 2005 Red Hat, Inc.
Copyright 2000 Red Hat, Inc.
Copyright (c) 2010-2012
Copyright (c) 2010-2012
Copyright 2007, 2008 Ryan Lortie <desrt@desrt.ca>
Copyright (C) 1999-2000, 2002-2003 Free Software Foundation, Inc.
Copyright (C) 2010 Thiago Santos <thiago.sousa.santos@collabora.co.uk>
Copyright (C) 2010 Emmanuele Bassi <ebassi@linux.intel.com>
Copyright © 2010 Codethink Limited

Copyright © 2018 Tomasz Mićsko
Copyright (C) 2008 by Claus Tondering. E-mail: claus@tondering.dk.
Copyright (C) 1991,92,94,95,96,97,98,99,2000,01,02 Free Software Foundation, Inc.
Copyright© 2008 codethink
Copyright © 2012,2013 Canonical Limited
Copyright © 2009 codethink
Copyright (C) 1999 The Free Software Foundation
Copyright (C) 2007 Imendio AB Authors: Tim Janik
Copyright (C) 2011 Google, Inc.
Copyright (C) 2010 Red Hat, Inc.
Copyright © 2012-2013 Canonical Limited
Copyright 2007, 2008 Ryan Lortie <
Copyright 2007, 2008 Ryan Lortie <desrt@desrt.ca>
Copyright (C) 1998 Tor Lillqvist
Copyright (C) 2001 Dan Winship
Copyright © 2011 Collabora Ltd.
Copyright (C) 2007 Red Hat Inc.
Copyright (C) 2007 Red Hat Inc.
Copyright (C) 1995-1998, 2000, 2001 Free Software Foundation, Inc. This is free software
Copyright 1998 Owen Taylor and Tor Lillqvist
Copyright 1999-2000 Tor Lillqvist and Craig Setera
Copyright 2001-2003 Andrew Lanoix
Copyright © 2010 Christian Persch
Copyright 2000 Tor Lillqvist
Copyright (C) 1991,92,93,94,95,96,97,98,99 Free Software Foundation, Inc.
Copyright (C) 1991,92,93,94,95,96,97,98,99 Free Software Foundation, Inc.
Copyright (C) 1994 X Consortium
Copyright 1992-2019 Free Software Foundation, Inc.
Copyright (C) 1989, 1991 Free Software Foundation, Inc.
Copyright (c) 2006, 2008 Junio C Hamano
Copyright (C) 1991, 1999 Free Software Foundation, Inc.
Copyright (C) 1992-2019 Free Software Foundation, Inc.
Copyright (C) 2015-2019 Free Software Foundation, Inc.
Copyright (C) 1991-2019 Free Software Foundation, Inc.
Copyright (C) 2019 Free Software Foundation, Inc.
Copyright (C) 1995-2019 Free Software Foundation, Inc.
Copyright (C) 1997-2019 Free Software Foundation, Inc.
Copyright (C) 2013-2019 Free Software Foundation, Inc.
Copyright (C) 1996-2019 Free Software Foundation, Inc.
Copyright (C) 1996-2019 Free Software Foundation, Inc.
Copyright (C) 2003-2019 Free Software Foundation, Inc.
Copyright (C) 2006-2019 Free Software Foundation, Inc.
Copyright (C) 1996-2019 Free Software Foundation, Inc.
Copyright (C) 2016-2019 Free Software Foundation, Inc.
Copyright (C) 2003-2019 Free Software Foundation, Inc.
Copyright (C) 1996-2019 Free Software Foundation, Inc.
Copyright (C) 1994-2019 Free Software Foundation, Inc.
Copyright (C) 2012-2019 Free Software Foundation, Inc.
Copyright (C) 2001-2019 Free Software Foundation, Inc.
Copyright (C) 2017-2019 Free Software Foundation, Inc.
Copyright (C) 2013-2019 Free Software Foundation, Inc.
Copyright (C) 2012-2019 Free Software Foundation, Inc. Contributed by David S. Miller <davem@davemloft.net>, 2012.
Copyright (C) 2014-2019 Free Software Foundation, Inc.
Copyright (C) 2006-2019 Free Software Foundation, Inc. Contributed by Jakub Jelinek <jakub@redhat.com>, 2006.
Copyright (C) 2013-2019 Free Software Foundation, Inc. Contributed by David S. Miller <davem@davemloft.net>, 2013.

LICENCE TERMS (cont.)

Copyright (C) 2011-2019 Free Software Foundation, Inc.
Copyright (C) 2012-2019 Free Software Foundation, Inc.
Copyright (C) 2005-2019 Free Software Foundation, Inc.
Copyright (C) 2002-2019 Free Software Foundation, Inc. Contributed by Ulrich Drepper <drepper@redhat.com>, 2002.
Copyright (C) 1997-2019 Free Software Foundation, Inc.
Copyright (C) 1996-2019 Free Software Foundation, Inc. Written by Miles Bader <miles@gnu.ai.mit.edu>.
Copyright (C) 1995-2019 Free Software Foundation, Inc. Written by Miles Bader <miles@gnu.ai.mit.edu>.
Copyright (C) 2003-2019 Free Software Foundation, Inc.
Copyright (C) 2007-2019 Free Software Foundation, Inc. Contributed by Jakub Jelinek <jakub@redhat.com>, 2007.
Copyright (C) 1997-2019 Free Software Foundation, Inc. Written by Miles Bader <miles@gnu.ai.mit.edu>.
Copyright (C) 1997-2019 Free Software Foundation, Inc. Contributed by Miguel de Icaza
Copyright (C) 2000-2019 Free Software Foundation, Inc. Contributed by Jakub Jelinek <jakub@redhat.com>, 2000.
Copyright (C) 2018-2019 Free Software Foundation, Inc.
Copyright (C) 2002-2019 Free Software Foundation, Inc.
Copyright (C) 1996-2019 Free Software Foundation, Inc. Contributed by Ulrich Drepper <drepper@cygnus.com>, 1996.
Copyright (C) 1988, 1997-2019 Free Software Foundation, Inc.
Copyright (C) 2004-2019 Free Software Foundation, Inc.
Copyright (C) 1995-2019 Free Software Foundation, Inc.
Copyright (C) 2007-2019 Free Software Foundation, Inc.
Copyright (C) 2013-2019 Free Software Foundation, Inc.
Copyright (C) 2000-2019 Free Software Foundation, Inc.
Copyright (C) 1999-2019 Free Software Foundation, Inc.
Copyright (C) 2009-2019 Free Software Foundation, Inc.
Copyright (C) 1998-2019 Free Software Foundation, Inc.
Copyright (C) 2010 Free Software Foundation, Inc.
Copyright (C) 1997-2019 Free Software Foundation, Inc. Contributed by Robert Bihlmeyer <robbe@orcus.priv.at>.
Copyright (C) 2010-2019 Free Software Foundation, Inc.
Copyright (C) 1993-2019 Free Software Foundation, Inc. Contributed by Ulrich Drepper <drepper@gnu.ai.mit.edu>, 1993.
Copyright (C) 2005-2019 Free Software Foundation, Inc. Contributed by Ulrich Drepper <drepper@cygnus.com>, 1998.
Copyright (C) 2010-2019 Free Software Foundation, Inc. Contributed by Luis Machado <luisgpm@br.ibm.com>.
Copyright (C) 1995-2019 Free Software Foundation, Inc. Contributed by Bernd Schmidt <crux@Pool.Informatik.RWTH-Aachen.DE>, 1997.
Copyright (C) 2001-2019 Free Software Foundation, Inc.
Copyright (C) 1992-2019 Free Software Foundation, Inc.
Copyright (c) 1991, 1993 The Regents of the University of California. All rights reserved.
Copyright 1995-2019 Free Software Foundation, Inc.
Copyright (c) 1982, 1986, 1988, 1993 The Regents of the University of California. All rights reserved.
Copyright (c) 1980, 1993 The Regents of the University of California. All rights reserved.
Copyright (c) 1985, 1993 The Regents of the University of California. All rights reserved.
Copyright (c) 1987, 1993 The Regents of the University of California. All rights reserved.
Copyright (c) 1989, 1993 The Regents of the University of California. All rights reserved.
Copyright (C) 1993-2019 Free Software Foundation, Inc. Contributed by Ulrich Drepper <drepper@gnu.ai.mit.edu>
Copyright (c) 1983, 1988, 1993 The Regents of the University of California. All rights reserved.
Copyright (c) 1990, 1993 The Regents of the University of California. All rights reserved.
Copyright (c) 1988, 1993 The Regents of the University of California. All rights reserved.
Copyright (C) 1990-2019 Free Software Foundation, Inc.
Copyright (C) 1993-2019 Free Software Foundation, Inc.
Copyright (C) 1991-2019 Free Software Foundation, Inc. Contributed by Torbjorn Granlund (tege@sics.se).
Copyright (C) 2017-2019 Free Software Foundation, Inc.
Copyright (C) 2017-2019 Free Software Foundation, Inc.
Copyright (C) 2018 Free Software Foundation, Inc.
Copyright (C) 2010-2019 Free Software Foundation, Inc. Contributed by Michael Brutman <brutman@us.ibm.com>.
Copyright (C) 1998-2019 Free Software Foundation, Inc. Contributed by Ulrich Drepper <drepper@cygnus.com>, 1998.
Copyright (C) 2000-2019 Free Software Foundation, Inc. Contributed by Ulrich Drepper <drepper@cygnus.com>, 2000.
Copyright (C) 1985, 1989-2019 Free Software Foundation, Inc.
Copyright (C) 1989-2019 Free Software Foundation, Inc.
Copyright (C) 1991-2019 Free Software Foundation, Inc.
Copyright (C) 2000-2019 Free Software Foundation, Inc. Contributes by Ulrich Drepper <drepper@redhat.com>.
Copyright (C) 2001-2019 Free Software Foundation, Inc. Contributed by Ulrich Drepper <drepper@redhat.com>, 2001.
Copyright (C) 1987-2019 Free Software Foundation, Inc.
Copyright (C) 2002-2019 Free Software Foundation, Inc. Contributed by Isamu Hasegawa <isamu@yamato.ibm.com>.
Copyright (C) 2001-2019 Free Software Foundation, Inc. Contributed by Jakub Jelinek <jakub@redhat.com>, 2001.
Copyright (C) 2002-2019 Free Software Foundation, Inc. Contributed by Jakub Jelinek <jakub@redhat.com>, 2002.
Copyright (C) 2004-2019 Free Software Foundation, Inc. Contributed by Jakub Jelinek <jakub@redhat.com>, 2004.
Copyright (C) 2009-2019 Free Software Foundation, Inc. Contributed by Paolo Bonzini <pbonzini@redhat.com>, 2009.
Copyright (C) 1997-2019 Free Software Foundation, Inc. Contributed by Ulrich Drepper <drepper@cygnus.com>, 1997.
Copyright (C) 1992-2019 Free Software Foundation, Inc.
Copyright (C) 2002-2019 Free Software Foundation, Inc. Contributed by Stepan Kasal <kasal@math.cas.cz>, 2002.
Copyright 1992, 1993, 1994, 1997 Henry Spencer. All rights reserved.
Copyright 1995 by Tom Lord
Copyright (C) 1992-2019 Free Software Foundation, Inc. Written by David J. MacKenzie.
Copyright (C) 2002-2019 Free Software Foundation, Inc. Contributed by Isamu Hasegawa <isamu@yamato.ibm.com>, 2002.
Copyright (C) 2002-2019 Free Software Foundation, Inc. Contributed by Ulrich Drepper <drepper@redhat.com>, 2001.
Copyright (C) 2000-2019 Free Software Foundation, Inc. Contributed by Ulrich Drepper <drepper@redhat.com>, 2000.
Copyright (C) 2012-2019 Free Software Foundation, Inc. Contributed by Stanislav Brabec <sbrabec@suse.cz>, 2012.
Copyright (c) 1997-2003 University of Cambridge
Copyright (C) 2004-2019 Free Software Foundation, Inc. Contributed by Ulrich Drepper <drepper@redhat.com>, 2004.
Copyright (C) 1997-2019 Free Software Foundation, Inc. Contributed by Tim Waugh <tim@cyberelk.demon.co.uk>.
Copyright 2016-2019 Free Software Foundation, Inc.
Copyright (C) 2002-2019 Free Software Foundation, Inc. Contributed by Aldy Hernandez <aldyh@redhat.com>, 2002.
Copyright (C) 1991-2019 Free Software Foundation, Inc.
Copyright (C) 2002-2019 Free Software Foundation, Inc. Contributed by Aldy Hernandez <aldyh@redhat.com>, 2002, 2010.
Copyright (C) 1991 Regents of the University of California. All rights reserved.
Copyright (C) 1996-2019 Free Software Foundation, Inc. Contributed by Ulrich Drepper <drepper@redhat.com>, 1996.
Copyright (C) 1996-2019 Free Software Foundation, Inc. Contributed by Ulrich Drepper, <drepper@gnu.org>.
Copyright (C) 1996-2019 Free Software Foundation, Inc. Contributed by Ulrich Drepper, <drepper@gnu.ai.mit.edu>.
Copyright (C) 1997-2019 Free Software Foundation, Inc. Contributed by Thorsten Kukuk <kukuk@uni-paderborn.de>, 1997.
Copyright (c) 1997-2019 Free Software Foundation, Inc. Contributed by Thorsten Kukuk <kukuk@vt.uni-paderborn.de>, 1997.
Copyright (C) 2017-2019 Free Software Foundation, Inc.
Copyright (C) 1991-2019 Free Software Foundation, Inc. Contributed by Torbjorn Granlund (tege@sics.se). Updated for POWER6 by Steven Munroe (sjmunroe@us.ibm.com).
Copyright (c) 1997-2019 Free Software Foundation, Inc. Contributed by Thorsten Kukuk <kukuk@suse.de>, 1997.
Copyright (C) 1996-2019 Free Software Foundation, Inc. Contributed by Thorsten Kukuk <kukuk@suse.de>, 1996.

LICENCE TERMS (cont.)

Copyright (C) 1996-2019 Free Software Foundation, Inc. Contributed by Thorsten Kukuk <kukuk@vt.uni-paderborn.de>, 1996.

Copyright (C) 1998-2019 Free Software Foundation, Inc. Contributed by Thorsten Kukuk <kukuk@suse.de>, 1998.

Copyright (C) 1997-2019 Free Software Foundation, Inc. Contributed by Thorsten Kukuk <kukuk@vt.uni-paderborn.de>, 1997.

Copyright (c) 2017-2019 Free Software Foundation, Inc.

Copyright (C) 2011-2019 Free Software Foundation, Inc. Contributed by Adhemerval Zanella <azanella@br.ibm.com>, 2011

Copyright (c) 2010, Oracle America, Inc.

Copyright (C) 1997-2019 Free Software Foundation, Inc. Contributed by Thorsten Kukuk <kukuk@suse.de>, 1997.

Copyright (C) 2000-2019 Free Software Foundation, Inc. Contributed by Geoffrey Keating <geoffk@geoffk.org>, 2000.

Copyright (C) 2001-2019 Free Software Foundation, Inc. Contributed by Ryan S. Arnold <rsa@us.ibm.com> Sean Curry <spcurry@us.ibm.com>

Copyright (C) 1989, 1992-2019 Free Software Foundation, Inc.

Copyright (c) 1998-2019 Free Software Foundation, Inc. Contributed by Thorsten Kukuk <kukuk@suse.de>, 1998.

Copyright (C) 1992-2019 Free Software Foundation, Inc. Contributed by Brendan Kehoe (brendan@zen.org).

Copyright (C) 2006-2019 Free Software Foundation, Inc. Contributed by Ulrich Drepper <drepper@redhat.com>, 2006.

Copyright (C) 1993-2019 Free Software Foundation, Inc. Contributed by David Mosberger (davidm@cs.arizona.edu).

Copyright (C) 1993-2019 Free Software Foundation, Inc. Contributed by Brendan Kehoe (brendan@zen.org).

Copyright (C) 2008-2019 Free Software Foundation, Inc.

Copyright (C) 1992-2019 Free Software Foundation, Inc. Contributed by Alexandre Oliva <aoliva@redhat.com>.

Copyright (C) 1999-2019 Free Software Foundation, Inc. Contributed by Andreas Jaeger <aj@suse.de>.

Copyright (C) 1998-2019 Free Software Foundation, Inc. Contributed by Zack Weinberg <zack@rabi.phys.columbia.edu>, 1998.

Copyright (C) 1994-2019 Free Software Foundation, Inc.

Copyright (C) 1995-2019 Free Software Foundation, Inc. Contributed by Ulrich Drepper <drepper@gnu.ai.mit.edu>, August 1995.

Copyright (C) 2000-2019 Free Software Foundation, Inc. Contributed by Maciej W. Rozycki <macro@ds2.pg.gda.pl>, 2000.

Copyright (C) 1993-2019 Free Software Foundation, Inc.

Copyright (C) 2011-2019 Free Software Foundation, Inc.

Copyright (C) 1996-2019 Free Software Foundation, Inc.

Copyright (C) 2009-2019 Free Software Foundation, Inc.

Copyright (C) 1998-2019 Free Software Foundation, Inc.

Copyright (C) 2005-2019 Free Software Foundation, Inc.

Copyright (C) 2007-2019 Free Software Foundation, Inc.

Copyright (C) 1999-2019 Free Software Foundation, Inc.

Copyright (C) 2002-2019 Free Software Foundation, Inc.

Copyright (C) 2001-2019 Free Software Foundation, Inc. Contributed by Ulrich Drepper <drepper@cygnus.com>, 2001.

Copyright (C) 2018-2019 Free Software Foundation, Inc.

Copyright (C) 2000-2019 Free Software Foundation, Inc. Contributed by Andreas Jaeger <aj@suse.de>, 2000.

Copyright (C) 2019 Free Software Foundation, Inc.

Copyright (C) 1992-2019 Free Software Foundation, Inc. Contributed by David Mosberger.

Copyright (C) 1992-2019 Free Software Foundation, Inc.

Copyright (C) 1992-2019 Free Software Foundation, Inc. Contributed by Ulrich Drepper, <drepper@gnu.ai.mit.edu>, August 1995.

Copyright (C) 1993-2019 Free Software Foundation, Inc. Contributed by David Mosberger <davidm@azstarnet.com>, 1995.

Copyright (C) 2001-2019 Free Software Foundation, Inc. Contributed by Ulrich Drepper <drepper@redhat.com>, 2001

Copyright (C) 1998-2019 Free Software Foundation, Inc. Contributed by Richard Henderson <rth@cygnus.com>, 1998

Copyright (C) 1991-2019 Free Software Foundation, Inc.

Copyright (C) 1996-2019 Free Software Foundation, Inc. Contributed by David Mosberger <davidm@azstarnet.com>.

Copyright (C) 1996-2019 Free Software Foundation, Inc. Contributed by Richard Henderson <rth@tamu.edu>, 1996.

Copyright (C) 1996-2019 Free Software Foundation, Inc. Contributed by David Mosberger <davidm@azstarnet.com>, 1996.

Copyright (C) 2001-2019 Free Software Foundation, Inc. Contributed by Andreas Schwab <schwab@suse.de>.

Copyright (C) 1999-2019 Free Software Foundation, Inc. Contributed by Andreas Schwab <schwab@suse.de>

Copyright (C) 1993-2019 Free Software Foundation, Inc. Contributed by Brendan Kehoe <brendan@zen.org>, 1993.

Copyright (C) 1996-2019 Free Software Foundation, Inc. Contributed by Jens Schweikhardt <schweikh@noc.dfn.de>, 1996.

Copyright (C) 1993-2019 Free Software Foundation, Inc. Contributed by David Mosberger (davidm@azstarnet.com).

Copyright (C) 2017-2019 Free Software Foundation, Inc. Contributed by Chris Metcalf <cmetcalf@tilera.com>, 2011.

Copyright (C) 2009-2019 Free Software Foundation, Inc. Contributed by Ulrich Drepper <drepper@redhat.com>, 2009.

Copyright (C) 1997-2019 Free Software Foundation, Inc. Contributed by Ulrich Drepper <drepper@cygnus.com>, 1997.

Copyright (C) 1999-2019 Free Software Foundation, Inc. Contributed by Andreas Jaeger <aj@suse.de>, 1999.

Copyright (C) 2005-2019 Free Software Foundation, Inc. Contributed by Jakub Jelinek <jakub@redhat.com>, 2005.

Copyright (C) 1995-2019 Free Software Foundation, Inc.

Copyright (C) 2009-2019 Free Software Foundation, Inc. Contributed by Maciej W. Rozycki <macro@codesourcery.com>.

Copyright (C) 2000-2019 Free Software Foundation, Inc. Contributed by Maciej W. Rozycki <macro@ds2.pg.gda.pl>, 2000.

Copyright (C) 2002-2019 Free Software Foundation, Inc.

Copyright (C) 2016-2019 Free Software Foundation, Inc.

Copyright (C) 1999-2019 Free Software Foundation, Inc. Contributed by Alexandre Oliva <aoliva@redhat.com>

Copyright (C) 1996-2019 Free Software Foundation, Inc. Contributed by Ralf Baechle <ralf@linux-mips.org>, 1996.

Copyright (C) 1992-2019 Free Software Foundation, Inc. Written by Mike Haertel, September 1988.

Copyright (C) 1995-2019 Free Software Foundation, Inc. Contributed by Ulrich Drepper <drepper@gnu.org>, 1995.

Copyright 2003-2019 Free Software Foundation, Inc.

Copyright (C) 1995-2019 Free Software Foundation, Inc. Contributed by Ulrich Drepper <drepper@gnu.org>, August 1995.

Copyright (C) 1991-2019 Free Software Foundation, Inc. Written by Douglas C. Schmidt (schmidt@ics.uci.edu).

Copyright (C) 1995-2019 Free Software Foundation, Inc. Contributed by Ulrich Drepper <drepper@gnu.ai.mit.edu>, 1995.

Copyright (C) 1998-2019 Free Software Foundation, Inc. Contributed by Phil Blundell, based on the Alpha version by David Mosberger.

Copyright (C) 2001-2019 Free Software Foundation, Inc. Contributed by Philip Blundell <philb@gnu.org>, 2001.

Copyright (C) 1998-2019 Free Software Foundation, Inc. Contributed by Philip Blundell <pb@nexus.co.uk>, 1998.

Copyright (C) 2001-2019 Free Software Foundation, Inc. Contributed by Ulrich Drepper <drepper@redhat.com>, 2001.

Copyright (C) 1992-2019 Free Software Foundation, Inc. Contributed by Ulrich Drepper, <drepper@gnu.ai.mit.edu>, August 1995. ARM changes by Philip Blundell, <pjb27@cam.ac.uk>, May 1997.

Copyright (C) 2015-2019 Free Software Foundation, Inc.

Copyright (C) 1999-2019 Free Software Foundation, Inc. Contributed by Philip Blundell <philb@gnu.org>.

Copyright (C) 1999-2019 Free Software Foundation, Inc. Contributed by Philip Blundell <philb@gnu.org>, 1999.

Copyright (C) 1999-2019 Free Software Foundation, Inc. Contributed by Andreas Jaeger <aj@suse.de>, 1999 and Jakub Jelinek <jakub@redhat.com>, 1999.

Copyright (C) 1996-2019 Free Software Foundation, Inc. Contributed by Pat Beirne <patb@corelcomputer.com>

Copyright (C) 1996-2019 Free Software Foundation, Inc. Contributed by Ulrich Drepper <drepper@cygnus.com> and Jochen Hein <Jochen.Hein@informatik.TU-Clausthal.de>, 1996.

Copyright (C) 1991-2019 Free Software Foundation, Inc. Its master source is NOT part of the C library, however. The master source lives in the GNU MP Library.

LICENCE TERMS (cont.)

Copyright (C) 1993-2019 Free Software Foundation, Inc.
Copyright (C) 2000-2019 Free Software Foundation, Inc. Contributed by Ulrich Drepper <drepper@cygnus.com>.
Copyright (C) 1999-2019 Free Software Foundation, Inc.
Copyright (C) 1993-2019 Free Software Foundation, Inc. Written by Per Bothner <bothner@cygnus.com>.
Copyright (C) 1998-2019 Free Software Foundation, Inc. Contributed by Ulrich Drepper <drepper@cygnus.com>, 1998.
Copyright (C) 2000-2019 Free Software Foundation, Inc. Contributed by David Mosberger-Tang <davidm@hpl.hp.com>
Copyright (C) 1996-2019 Free Software Foundation, Inc. Contributed by Jes Sorensen <jes@linuxcare.com>, July 2000
Copyright (C) 1999-2019 Free Software Foundation, Inc. Contributed by David Mosberger-Tang <davidm@hpl.hp.com>.
Copyright (C) 1993-2019 Free Software Foundation, Inc.
Copyright (C) 2003-2019 Free Software Foundation, Inc. Contributed by Jakub Jelinek <jakub@redhat.com>.
Copyright (C) 1999-2019 Free Software Foundation, Inc. Contributed by David Mosberger-Tang <davidm@hpl.hp.com>.
Copyright (C) 2000-2019 Free Software Foundation, Inc. Contributed by Hanno Mueller, kontakt@hanno.de, 2000.
Copyright (C) 1999-2019 Free Software Foundation, Inc. Contributed by David Mosberger-Tang <davidm@hpl.hp.com>
Copyright (C) 2001-2019 Free Software Foundation, Inc. Contributed by David Mosberger-Tang <davidm@hpl.hp.com>.
Copyright (C) 1999-2019 Free Software Foundation, Inc. Written by Jes Sorensen, <Jes.Sorensen@cern.ch>, April 1999. Based on code originally written by David Mosberger-Tang
Copyright (C) 1999-2019 Free Software Foundation, Inc. Contributed by Jes Sorensen <Jes.Sorensen@cern.ch>.
Copyright (C) 1999-2019 Free Software Foundation, Inc. Contributed by David Mosberger <davidm@hpl.hp.com>
Copyright (C) 2004-2019 Free Software Foundation, Inc. Contributed by David Mosberger-Tang <davidm@hpl.hp.com>.
Copyright (C) 1999-2019 Free Software Foundation, Inc. Written by Stephane Eranian <eranian@hpl.hp.com> and Jes Sorensen, <Jes.Sorensen@cern.ch>, April 1999.
Copyright (C) 1997-2019 Free Software Foundation, Inc. Linux/IA64 specific sigprocmask Written by Jes Sorensen, <Jes.Sorensen@cern.ch>, April 1999.
Copyright (C) 2018 Free Software Foundation. Copying and distribution of this file, with or without modification,
Copyright (C) 1995-2019 Free Software Foundation, Inc.
Copyright (C) 2003-2019 Free Software Foundation, Inc. Contributed by Ulrich Drepper <drepper@redhat.com>, 2003.
Copyright (C) 2002-2019 Free Software Foundation, Inc. Contributed by Andreas Jaeger <aj@suse.de>, 2002.
Copyright (C) 1998-2019 Free Software Foundation, Inc.
Copyright (C) 1997-2019 Free Software Foundation, Inc. Written by Jes Sorensen, <Jes.Sorensen@cern.ch>, April 1999.
Copyright (C) 1998-2019 Free Software Foundation, Inc. Contributed by Mark Kettner <kettner@phys.uva.nl>, 1998.
Copyright (C) 1991-2019 Free Software Foundation, Inc. Written by Per Bothner <bothner@cygnus.com>.
Copyright (C) 2011-2019 Free Software Foundation, Inc. Contributed by Ulrich Drepper <drepper@gmain.com>, 2003.
Copyright (C) 1998-2019 Free Software Foundation, Inc. Written by Per Bothner <bothner@cygnus.com>.
Copyright (c) 1991,1990,1989,1988,1987 Carnegie Mellon University All Rights Reserved.
Copyright (c) 1991,1990,1989, 1995 Carnegie Mellon University All Rights Reserved.
Copyright (c) 1991,1990,1989 Carnegie Mellon University All Rights Reserved.
Copyright (C) 1992-2019 Free Software Foundation, Inc. Contributed by Ulrich Drepper, <drepper@gnu.org>, August 1995.
Copyright (C) 1999-2019 Free Software Foundation, Inc. Contributed by Andreas Schwab <schwab@gnu.org>.
Copyright (C) 1999-2019 Free Software Foundation, Inc. Contributed by Andreas Jaeger <aj@suse.de>, 1999 and Jakub Jelinek <jakub@redhat.com>, 2000.
Copyright (C) 1996-2019 Free Software Foundation, Inc. Contributed by Richard Henderson (rth@tamu.edu)
Copyright (c) 1991,1990 Carnegie Mellon University All Rights Reserved.
Copyright (c) 1992 Carnegie Mellon University All Rights Reserved.
Copyright (C) 2011-2019 Free Software Foundation, Inc. Contributed by Ulrich Drepper <drepper@gmail.com>, 2011.
Copyright (C) 1999-2019 Free Software Foundation, Inc. Contributed by Ulrich Drepper, <drepper@cygnus.com>, August 1999. Linux/PA-RISC changes by Philipp Rumpf, <prumpf@tux.org>, March 2000.
Copyright (C) 2008-2019 Free Software Foundation, Inc. Contributed by Helge Deller <deller@gmx.de>, 2008.
Copyright (C) 1996-2019 Free Software Foundation, Inc. Contributed by David Huggins-Daines <dhd@debian.org>, 2000. Based on the Alpha version by Richard Henderson <rth@tamu.edu>, 1996.
Copyright (C) 2003-2019 Free Software Foundation, Inc. Contributed by Carlos O'Donell <carlos@baldric.uwo.ca>, 2005.
Copyright (C) 1993 by Sun Microsystems, Inc. All rights reserved.
Copyright (C) 1997-2019 Free Software Foundation, Inc. Based on an algorithm by Stephen L. Moshier <moshier@world.std.com>. Contributed by Ulrich Drepper <drepper@cygnus.com>, 1997.
Copyright (C) 2005-2019 Free Software Foundation, Inc. Contributed by Richard Henderson <rth@redhat.com>, 2005.
Copyright (c) 1982, 1986, 1993 The Regents of the University of California. All rights reserved.
Copyright (C) 1992-2019 Free Software Foundation, Inc. Contributed by Ulrich Drepper, <drepper@gnu.ai.mit.edu>, August 1995. Changed by Kaz Kojima, <kkojima@rr.iij4u.or.jp>.
Copyright (C) 2011-2019 Free Software Foundation, Inc. Contributed by Chris Metcalf <cmetcalf@tilera.com>, 2011.
Copyright (C) 2016-2019 Free Software Foundation, Inc. Contributed by Marek Polacek <polacek@redhat.com>, 2012.
Copyright (C) 1997-2019 Free Software Foundation, Inc.
Copyright (C) 2000-2019 Free Software Foundation, Inc.
Copyright (C) 2003-2019 Free Software Foundation, Inc. Contributed by Andreas Jaeger <aj@suse.de>, 2003.
Copyright (C) 1997-2019 Free Software Foundation, Inc. Contributed by Geoffrey Keating <Geoff.Keating@anu.edu.au>, 1997.
Copyright (C) 1999-2019 Free Software Foundation, Inc. Contributed by Jakub Jelinek <jakub@redhat.com>, 1999.
Copyright (C) 1998-2019 Free Software Foundation, Inc. Contributed by Joe Keane <jgk@jgk.org>.
Copyright (C) 1995-2019 Free Software Foundation, Inc. Contributed by Ulrich Drepper <drepper@cygnus.com>, August 1995.
Copyright (C) 2005-2019 Free Software Foundation, Inc. Contributed by Chris Metcalf <cmetcalf@tilera.com>, 2011.
Copyright (C) 2016-2019 Free Software Foundation, Inc. Contributed by Chris Metcalf <cmetcalf@tilera.com>, 2011.
Copyright (C) 2008-2019 Free Software Foundation, Inc. Contributed by Andrew Jenner <andrew@codesourcery.com>, 2008.
Copyright (C) 2001-2019 Free Software Foundation, Inc. Contributed by Jakub Jelinek <jakub@redhat.com> and Ulrich Drepper <drepper@redhat.com>, 2001.
Copyright (C) 2010-2019 Free Software Foundation, Inc. Contributed by Andreas Schwab <schwab@redhat.com>, 2010.
Copyright (C) 1999-2019 Free Software Foundation, Inc. Contributed by Jakub Jelinek <jj@ultra.linux.cz>, 1999.
Copyright (C) 1997-2019 Free Software Foundation, Inc. Contributed by Richard Henderson (rth@tamu.edu).
Copyright (C) 1997-2019 Free Software Foundation, Inc. Contributed by Miguel de Icaza <miguel@nuclecu.unam.mx> and Jakub Jelinek <jj@ultra.linux.cz>.
Copyright (C) 2001-2019 Free Software Foundation, Inc. Contributed by Jakub Jelinek <jakub@redhat.com>.
Copyright (C) 1997-2019 Free Software Foundation, Inc. Contributed by Miguel de Icaza <miguel@gnu.ai.mit.edu>, 1997.
Copyright (C) 1995-2019 Free Software Foundation, Inc. Contributed by Miguel de Icaza (miguel@nuclecu.unam.mx)
Copyright (C) 1997-2019 Free Software Foundation, Inc. Contributed by Miguel de Icaza <miguel@gnu.ai.mit.edu>, January 1997.
Copyright (C) 2008-2019 Free Software Foundation, Inc. Contributed by David S. Miller <davem@davemloft.net>, 2008.
Copyright (C) 1997-2019 Free Software Foundation, Inc. Contributed by Miguel de Icaza <miguel@nuclecu.unam.mx>, 1997.
Copyright (C) 1996-2019 Free Software Foundation, Inc. Contributed by Richard Henderson (rth@tamu.edu).
Copyright (C) 1999-2019 Free Software Foundation, Inc. Contributed by Andreas Schwab <schwab@suse.de> and Jakub Jelinek <jj@ultra.linux.cz>

LICENCE TERMS (cont.)

Copyright (C) 1997-2019 Free Software Foundation, Inc. Contributed by Andreas Jaeger <aj@suse.de> and Ulrich Drepper <drepper@cygnus.com>, 1997.
Copyright (C) 2008-2019 Free Software Foundation, Inc. Contributed by Andreas Jaeger <aj@suse.de>, 2005.
Copyright (C) 2019i Free Software Foundation, Inc.
Copyright (C) 2012-2019 Free Software Foundation, Inc. Contributed by Marek Polacek <polacek@redhat.com>, 2012.
Copyright (C) 2005-2019 Free Software Foundation, Inc. Contributed by Andreas Jaeger <aj@suse.de>, 2005.
Copyright (C) 2003-2019 Free Software Foundation, Inc. Contributed by Martin Schwidefsky <schwidefsky@de.ibm.com>, 2003.
Copyright (C) 2001-2019 Free Software Foundation, Inc. Contributed by Martin Schwidefsky (schwidefsky@de.ibm.com).
Copyright (C) 2000-2019 Free Software Foundation, Inc. Contributed by Martin Schwidefsky (schwidefsky@de.ibm.com).
Copyright (C) 2006-2019 Free Software Foundation, Inc. Contributed by Martin Schwidefsky <schwidefsky@de.ibm.com>, 2006.
Copyright (C) 2001-2019 Free Software Foundation, Inc. Contributed by Martin Schwidefsky (schwidefsky@de.ibm.com).
Copyright (C) 2009-2019 Free Software Foundation, Inc. Contributed by Jakub Jelinek <jakub@redhat.com>.
Copyright (C) 2002-2019 Free Software Foundation, Inc. Contributed by Martin Schwidefsky (schwidefsky@de.ibm.com).
Copyright (C) 2000-2019 Free Software Foundation, Inc. Contributed by Denis Joseph Barrow (djarrow@de.ibm.com).
Copyright (C) 2008-2019 Free Software Foundation, Inc. Contributed by Andreas Krebbel <Andreas.Krebbel@de.ibm.com>.
Copyright (C) 2000-2019 Free Software Foundation, Inc. Contributed by Martin Schwidefsky (schwidefsky@de.ibm.com).
Copyright (C) 1992-1996, 1998-2012 Free Software Foundation, Inc.
Copyright (C) 2007-2019 Free Software Foundation, Inc. Contributed by Uros Bizjak (ubizjak@gmail.com).
Copyright (C) 1997-2019 Free Software Foundation, Inc. Contributed by Richard Henderson (rth@cygnus.com), Jakub Jelinek (jj@ultra.linux.cz), David S. Miller (davem@redhat.com) and Peter Maydell (pmaydell@chiark.greenend.org.uk).
Copyright (C) 2006-2019 Free Software Foundation, Inc. Contributed by Joseph Myers (joseph@codesourcery.com).
Copyright (C) 1997-2019 Free Software Foundation, Inc. Contributed by Uros Bizjak (ubizjak@gmail.com).
Copyright (C) 1997-2019 Free Software Foundation, Inc. Contributed by Richard Henderson (rth@cygnus.com), Jakub Jelinek (jj@ultra.linux.cz) and Peter Maydell (pmaydell@chiark.greenend.org.uk).
Copyright (C) 1999-2019 Free Software Foundation, Inc. Contributed by Jakub Jelinek (jj@ultra.linux.cz).
Copyright (C) 1989, 1991-2019 Free Software Foundation, Inc.
Copyright (C) 1999-2019 Free Software Foundation, Inc. Contributed by Andreas Jaeger <aj@arthur.rhein-neckar.de>, 1999.
Copyright (C) 2004-2019 Free Software Foundation, Inc. Contributed by Ulrich Drepper <drepper@cygnus.com>, 2004.
Copyright (C) 1998-2019 Free Software Foundation, Inc. Contributed by Thorsten Kukuk <kukuk@uni-paderborn.de>, 1998.
Copyright (C) 2004-2019 Free Software Foundation, Inc. Contributed by Matthew Rickard <mjricka@epoch.ncsc.mil>, 2004.
Copyright (c) 1998-2019 Free Software Foundation, Inc. Contributed by Thorsten Kukuk <kukuk@vt.uni-paderborn.de>, 1998.
Copyright (C) 2000-2019 Free Software Foundation, Inc. Contributed by Andreas Schwab <schwab@suse.de>.
Copyright (C) 1998-2019 Free Software Foundation, Inc. Contributed by Andreas Schwab <schwab@gnu.org>.
Copyright (c) 1998-2019 Free Software Foundation, Inc. Contributed by Ulrich Drepper <drepper@cygnus.com>, 1998.
Copyright (C) 1996-2019 Free Software Foundation, Inc. Written by Andreas Schwab, <schwab@issan.informatik.uni-dortmund.de>, December 1995.
Copyright (C) 2010-2019 Free Software Foundation, Inc. Contributed by Maxim Kuvyrkov <maxim@codesourcery.com>, 2010.
Copyright (C) 2007-2019 Free Software Foundation, Inc. Contributed by Ulrich Drepper <drepper@redhat.com>,

2007.
Copyright (C) 2007-2019 Free Software Foundation, Inc. Contributed by Ulrich Drepper <drepper@drepper.com>, 2007.
Copyright (C) 1998-2019 Free Software Foundation, Inc. Contributed by Andreas Schwab <schwab@issan.informatik.uni-dortmund.de>, 1998.
Copyright (C) 1996-2019 Free Software Foundation, Inc. Contributed by Andreas Schwab (schwab@issan.informatik.uni-dortmund.de)
Copyright (C) 2003-2019 Free Software Foundation, Inc. Contributed by Andreas Schwab <schwab@suse.de>
Copyright (c) 1998-2019 Free Software Foundation, Inc. Contributed by Thorsten Kukuk <kukuk@suse.de>, 1998.
Copyright (C) 2008-2019 Free Software Foundation, Inc. Contributed by Ulrich Drepper <drepper@redhat.com>, 2008.
Copyright (C) 1999-2019 Free Software Foundation, Inc. Contributed by Ulrich Drepper <drepper@cygnus.com>, 1999.
Copyright (C) 1999-2019 Free Software Foundation, Inc. Contributed by Ulrich Drepper <drepper@gnu.org>, 1999.
Copyright (C) 1999-2019 Free Software Foundation, Inc. Written by Jakub Jelinek <jakub@redhat.com>, 1999.
Copyright (C) 1999-2019 Free Software Foundation, Inc. Contributed by Ulrich Drepper <drepper@cygnus.com>, 1999.
Copyright (C) 1996-2019 Free Software Foundation, Inc. Contributed by Ulrich Drepper <drepper@gnu.org>, 1996.
Copyright (C) 1997-2019 Free Software Foundation, Inc.
Copyright (c) 1989 Carnegie Mellon University.
Copyright (C) 2005-2019 Free Software Foundation, Inc. Contributed by Ulrich Drepper <drepper@redhat.com>, 2005.
Copyright (C) 1996-2019 Free Software Foundation, Inc. Contributed by Ulrich Drepper, <drepper@gnu.ai.mit.edu>
Copyright (C) 2004-2019 Free Software Foundation, Inc. Contribute by Ulrich Drepper <drepper@redhat.com>, 2004.
Copyright (C) 2000-2019 Free Software Foundation, Inc. Contributed by Kaz Kylheku <kaz@ashi.footprints.net>.
Copyright (C) 1999-2019 Free Software Foundation, Inc. Contributed by Ulrich Drepper <drepper@gnu.org>, 1999.
Copyright (C) 1996-2019 Free Software Foundation, Inc. Contributed by Ulrich Drepper <drepper@gnu.ai.mit.edu>, 1996.
Copyright (C) 1992-2019 Free Software Foundation, Inc.
Copyright (C) 2001-2019 Free Software Foundation, Inc. Contributed by Martin Schwidefsky <schwidefsky@de.ibm.com>.
Copyright (C) 2001-2019 Free Software Foundation, Inc. Contributed by Martin Schwidefsky (schwidefsky@de.ibm.com).
Copyright (C) 2001-2019 Free Software Foundation, Inc. Contributed by Martin Schwidefsky (schwidefsky@de.ibm.com).
Copyright (C) 2000-2019 Free Software Foundation, Inc. Contributed by Martin Schwidefsky <schwidefsky@de.ibm.com>.
Copyright (C) 2000-2019 Free Software Foundation, Inc. Contributed by Carl Pederson & Martin Schwidefsky.
Copyright (C) 2000-2019 Free Software Foundation, Inc. Contributed by Martin Schwidefsky (schwidefsky@de.ibm.com).
Copyright (C) 2000-2019 Free Software Foundation, Inc. Contributed by Martin Schwidefsky (schwidefsky@de.ibm.com).
Copyright (C) 2000-2019 Free Software Foundation, Inc. Contributed by Martin Schwidefsky (schwidefsky@de.ibm.com).
Copyright (C) 2000-2019 Free Software Foundation, Inc. Contributed by Martin Schwidefsky (schwidefsky@de.ibm.com).
Copyright (C) 1997-2019 Free Software Foundation, Inc. Contributed by Mark Kettenis <kettenis@phys.uva.nl>, 1997.
Copyright (C) 1993-2019 Free Software Foundation, Inc. Contributed by Paul Eggert <eggert@twinsun.com>.
Copyright 2016-2019 Free Software Foundation, Inc. Contributed by Paul Eggert <eggert@cs.ucla.edu>.
Copyright (C) 2001-2019 Free Software Foundation, Inc. Contributed by Martin Schwidefsky (schwidefsky@de.ibm.com).
Copyright (C) 1996-2019 Free Software Foundation, Inc. Contributed by Ulrich Drepper <drepper@gnu.ai.mit.edu>, 1995.
Copyright (C) 2004-2019 Free Software Foundation, Inc. Contributed by Martin Schwidefsky <schwidefsky@de.ibm.com>.
Copyright (C) 2000-2019 Free Software Foundation, Inc. Contributed by Denis Joseph Barrow <djarrow@de.ibm.com>.

LICENCE TERMS (cont.)

Copyright (C) 2000-2019 Free Software Foundation, Inc. Contributed by Denis Joseph Barrow (djbarrow@de.ibm.com).

Copyright (C) 2000-2019 Free Software Foundation, Inc. Contributed by Denis Joseph Barrow (djbarrow@de.ibm.com) and Martin Schwidefsky (schwidefsky@de.ibm.com).

Copyright (C) 2000-2019 Free Software Foundation, Inc. Contributed by Denis Joseph Barrow (djbarrow@de.ibm.com) and Martin Schwidefsky (schwidefsky@de.ibm.com).

Copyright (C) 2010-2019 Free Software Foundation, Inc. Contributed by Jakub Jelinek <jakub@redhat.com>, 2010.

Copyright (C) 1995-2019 Free Software Foundation, Inc. Contributed by Ulrich Drepper, <drepper@gnu.ai.mit.edu>

Copyright (C) 1993-2019 Free Software Foundation, Inc. Contributed by Olaf Flebbe.

Copyright (C) 2008-2019 Free Software Foundation, Inc.

Copyright (C) 2002-2019 Free Software Foundation, Inc. Contributed by Ulrich Drepper <drepper@gnu.org>, 2002.

Copyright (C) 1918-2019 Free Software Foundation, Inc.

Copyright (C) 2003-2019 Free Software Foundation, Inc. Contributed by Ulrich Drepper <drepper@cygnus.com>, 2003.

Copyright (C) 2016-2019 Free Software Foundation, Inc.

Copyright (C) 2012-2019 Free Software Foundation, Inc.

Copyright (c) 2010, 2012, Oracle America, Inc.

Copyright (c) 2010, 2011, Oracle America, Inc.

Copyright (C) 1992 Eric Young

Copyright (C) 2002-2019 Free Software Foundation, Inc. Contributed by Ulrich Drepper <drepper@redhat.com>, 2002.

Copyright (C) 2005-2019 Free Software Foundation, Inc. Contributed by Ulrich Drepper <drepper@gnu.org>.

Copyright (C) 2012-2019 Free Software Foundation, Inc. Contributed by Kees Cook <keescook@chromium.org>, 2012.

Copyright (C) 1997-2019 Free Software Foundation, Inc. Contributed by Ulrich Drepper <drepper@cygnus.com>, 1997. Based on a proposal by Larry McVoy <lm@sgi.com>.

Copyright (C) 1991-2019 Free Software Foundation, Inc. Contributed by Torbjorn Granlund (tege@sics.se).

Copyright (C) 2003-2019 Free Software Foundation, Inc. Contributed by Andreas Schwab <schwab@suse.de>, 2003.

Copyright (C) 1995-2019 Free Software Foundation, Inc.

Copyright (C) 1997-2019 Free Software Foundation, Inc. Contributed by Andreas Schwab <schwab@issan.informatik.uni-dortmund.de>.

Copyright (C) 1997-2019 Free Software Foundation, Inc. Contributed by Andreas Schwab <schwab@issan.informatik.uni-dortmund.de>

Copyright (C) 2000-2019 Free Software Foundation, Inc. Contributed by Ulrich Drepper <drepper@gnu.org>, 2000.

Copyright (C) 1994-2019 Free Software Foundation, Inc. Contributed by Torbjorn Granlund <tege@matematik.su.se> and Ulrich Drepper <drepper@gnu.org>.

Copyright (C) 1997-2019 Free Software Foundation, Inc. Contributed by Ulrich Drepper <drepper@cygnus.com>, 1997. Fixed for m68k by Andreas Schwab <schwab@suse.de>.

Copyright (C) 2006-2019 Free Software Foundation, Inc.

Copyright (C) 2012-2019 Free Software Foundation, Inc. Contributed by Marek Polacek <polacek@redhat.com>, 2012.

Copyright (C) 2000-2019 Free Software Foundation, Inc. Contributed by Andreas Schwab <schwab@suse.de>, 2000.

Copyright (C) 1998-2019 Free Software Foundation, Inc. Contributed by Andreas Jaeger <aj@suse.de>, 1998.

Copyright (C) 2011-2019 Free Software Foundation, Inc. Contributed by Ulrich Drepper <drepper@gmail.com>.

Copyright (C) 1997-2019 Free Software Foundation, Inc. Contributed by H.J. Lu <hjl@gnu.ai.mit.edu>, 1997.

Copyright (C) 1996-2019 Free Software Foundation, Inc. Contributed by Ulrich Drepper <drepper@cygnus.com>, 1996.

Copyright (C) 1994-2019 Free Software Foundation, Inc.

Copyright (C) 2004-2019 Free Software Foundation, Inc. Contributed by David Mosberger <davidm@hpl.hp.com>, 2004.

Copyright (C) 2011-2019 Free Software Foundation, Inc. Contributed by Ulrich Drepper <drepper@gmail.com>, 2011.

Copyright (C) 1999-2019 Free Software Foundation, Inc. Contributed by Zack Weinberg <zack@rabi.columbia.edu>, 1999.

Copyright (C) 1997-2019 Free Software Foundation, Inc. Contributed by Ulrich Drepper <drepper@cygnus.com>.

1997. Based on the BSD mcount implementation.

Copyright (C) 1999-2019 Free Software Foundation, Inc. Contributed by Andreas Jaeger <aj@suse.de>, 1999.

Copyright (C) 2011-2019 Free Software Foundation, Inc. and is also part of gnulib. Patches to this file should be submitted to both projects.

Copyright (C) 2005-2019 Free Software Foundation, Inc. Contributed by Alexandre Oliva <aoliva@redhat.com>

Copyright (C) 2011-2019 Free Software Foundation, Inc.

Copyright (C) 1998-2019 Free Software Foundation, Inc. Contributed by Ulrich Drepper <drepper@cygnus.com>, 1997.

Copyright (C) 2004-2019 Free Software Foundation, Inc.

Copyright (C) 2018 Free Software Foundation, Inc.

Copyright (C) 2014-2019 Free Software Foundation, Inc.

Copyright (C) 2001-2019 Free Software Foundation, Inc.

Copyright (C) 2003-2019 Free Software Foundation, Inc.

Copyright (C) 2000-2019 Free Software Foundation, Inc. Contributed by David Mosberger (davidm@cs.arizona.edu). EV67 optimized by Rick Gorton <rick.gorton@alpha-processor.com>.

Copyright (C) 2000-2019 Free Software Foundation, Inc. Contributed by Richard Henderson <rth@tam.u.edu>, 1996. EV67 optimized by Rick Gorton <rick.gorton@alpha-processor.com>.

Copyright (C) 2000-2019 Free Software Foundation, Inc. Contributed by Richard Henderson (rth@redhat.com)

Copyright (C) 2000-2019 Free Software Foundation, Inc. Contributed by Richard Henderson <rth@redhat.com>.

Copyright (C) 2000-2019 Free Software Foundation, Inc.

Copyright (C) 1996-2019 Free Software Foundation, Inc. Contributed by Richard Henderson <rth@tam.u.edu>.

Copyright (C) 1996-2019 Free Software Foundation, Inc. Contributed by David Mosberger (davidm@cs.arizona.edu).

Copyright (C) 2004-2019 Free Software Foundation, Inc. Contributed by Richard Henderson (rth@cygnus.com), Jakub Jelinek (jj@ultra.linux.cz) and David S. Miller (davem@redhat.com).

Copyright (C) 2008-2019 Free Software Foundation, Inc. Contributed by Aurelien Jarno <aurelien@aurel32.net>, 2008.

Copyright (C) 2001-2019 Free Software Foundation, Inc. Contributed by Richard Henderson <rth@redhat.com>, 2001.

Copyright (C) 1995-2019 Free Software Foundation, Inc. Written by Miles Bader <miles@gnu.ai.mit.edu>

Copyright (C) 1996-2019 Free Software Foundation, Inc. Contributed by Richard Henderson (rth@tam.u.edu)

Copyright (C) 1993-2019 Free Software Foundation, Inc. Contributed by Richard Henderson <rth@tam.u.edu>

Copyright (C) 2000-2019 Free Software Foundation, Inc.

Copyright (C) 2000-2019 Free Software Foundation, Inc. Contributed by Richard Henderson (rth@tam.u.edu) EV6 optimized by Rick Gorton <rick.gorton@alpha-processor.com>.

Copyright (C) 1998-2019 Free Software Foundation, Inc. Written by Ulrich Drepper <drepper@cygnus.com>, 1998.

Copyright (C) 2003-2019 Free Software Foundation, Inc. Contributed by Richard Henderson <rth@twiddle.net>, 2003.

Copyright (C) 2002-2019 Free Software Foundation, Inc.

Copyright (C) 1997-2019 Free Software Foundation, Inc. Contributed by Andreas Jaeger <aj@arthur.rhein-neckar.de>, 1997.

Copyright (C) 1995-2019 Free Software Foundation, Inc. Contributed by David Mosberger (davidm@cs.arizona.edu).

Copyright (C) 1996-2019 Free Software Foundation, Inc. Written by Ulrich Drepper <drepper@cygnus.com>, October 1996

Copyright (C) 2001-2019 Free Software Foundation, Inc. Contributed by Wolfram Gloger <wg@malloc.de>, 2001.

Copyright (C) 1997-2019 Free Software Foundation, Inc. Contributed by Ulrich Drepper <drepper@gnu.org>, 1997. Based on the mtrace.awk script.

Copyright (C) 2000-2019 Free Software Foundation, Inc. Contributed by Richard Henderson.

Copyright (C) 1997-2019 Free Software Foundation, Inc. Contributed by Richard Henderson <rth@tam.u.edu>, 1997

Copyright (C) 1996-2019 Free Software Foundation, Inc. Contributed by Olaf Flebbe.

Copyright (C) 1990-2019 Free Software Foundation, Inc. Written May 1989 by Mike Haertel.

Copyright (C) 1988-2019 Free Software Foundation, Inc.

Copyright (C) 2000-2019 Free Software Foundation, Inc. Contributed by Ulrich Drepper <drepper@redhat.com>.

Copyright (C) 1997-2019 Free Software Foundation, Inc. Contributed by Richard Henderson <rth@tam.u.edu>, 1997.

Copyright (C) 1996-2019 Free Software Foundation, Inc. Contributed by Wolfram Gloger <wg@malloc.de> and Doug Lea <dl@cs.oswego.edu>, 2001.

Copyright (c) 2000-2019 Free Software Foundation, Inc.

LICENCE TERMS (cont.)

Copyright (C) 1991-2019 Free Software Foundation, Inc. Written April 2, 1991 by John Gilmore of Cygnus Support. Based on mcheck.c by Mike Haertel.

Copyright (C) 2004-2019 Free Software Foundation, Inc. Contributed by Richard Henderson <rth@twiddle.net>

Copyright (C) 2007-2019 Free Software Foundation, Inc. Contributed by Robert Millan <rmh@gnu.org>.

Copyright (C) 1996-2019 Free Software Foundation, Inc. Contributed by Kazumoto Kojima <kkojima@info.kanagawa-u.ac.jp>.

Copyright ©copyriht{} 1991, 1999 Free Software Foundation, Inc. 51 Franklin Street, Fifth Floor, Boston, MA 02110-1301, USA

Copyright (C) 1996-2019 Free Software Foundation, Inc. Contributed by Olaf Flebbe and Ralf Baechle.

Copyright (C) 1997-2019 Free Software Foundation, Inc. Contributed by Ralf Baechle <ralf@gnu.org>.

Copyright 2014-2019 Free Software Foundation, Inc.

Copyright 1985, 1986, 1988, 1990-2018 Free Software Foundation, Inc.

Copyright ©copyriht 1993--2019 Free Software Foundation, Inc.

Copyright ©copyriht{ 2000, 2001, 2002, 2007, 2008 Free Software Foundation, Inc.

Copyright (C) 1996-2019 Free Software Foundation, Inc. Contributed by Brendan Kehoe (brendan@zen.org).

Copyright (C) 1994-2019 Free Software Foundation, Inc. Contributed by Ralf Baechle <ralf@gnu.org>.

Copyright (C) 1996-2019 Free Software Foundation, Inc. Contributed by Ralf Baechle <ralf@gnu.org>.

Copyright (C) 2000-2019 Free Software Foundation, Inc. Contributed by Andreas Jaeger <aj@suse.de>.

Copyright (C) 1998-2019 Free Software Foundation, Inc. Contributed by Andreas Jaeger <aj@arthur.rhein-neckar.de>, 1998.

Copyright (C) 2002-2019 Free Software Foundation, Inc. Contributed by Hartvig Ekner <hartvige@mips.com>, 2002.

Copyright (C) 2017-2019 Free Software Foundation, Inc. Contributed by Rical Jasan <ricaljasan@pacific.net>, 2017.

Copyright (C) 1998-2019 Free Software Foundation, Inc. Contributed by Hartvig Ekner <hartvige@mips.com>, 2002.

Copyright (C) 2008-2019 Free Software Foundation, Inc. Contributed by Kazu Hirata <kazu@codesourcery.com>, 2008.

Copyright (C) 1998-2019 Free Software Foundation, Inc. Code contributed by Matthew Wilcox <willy@odie.barnet.ac.uk>

Copyright (C) 2001-2019 Free Software Foundation, Inc. Contributed by Bruno Haible <haible@clisp.cons.org>, 2001.

Copyright (C) 1995-2019 Free Software Foundation, Inc. This file is derived from the file libgettext.h in the GNU gettext package.

Copyright (C) 2005-2019 Free Software Foundation, Inc. Contributed by Bruno Haible <bruno@clisp.org>, 2005.

Copyright (C) 1995-2019 Free Software Foundation, Inc. Contributed by Ulrich Drepper <drepper@gnu.ai.mit.edu>, 1995.

Copyright (C) 2000-2019 Free Software Foundation, Inc. Contributed by Thorsten Kukuk <kukuk@suse.de> and Andreas Jaeger <aj@suse.de>, 2000.

Copyright (C) 2008-2019 Free Software Foundation, Inc. Contributed by Jakub Jelinek <jakub@redhat.com>, 2008.

Copyright (C) 2000-2019 Free Software Foundation, Inc. Written by Ulrich Drepper <drepper@cygnus.com>, 2000.

Copyright (C) 1995-2019 Free Software Foundation, Inc. Written by Ulrich Drepper <drepper@cygnus.com>, 1995.

Copyright (C) 2011-2019 Free Software Foundation, Inc. Code contributed by Dave Gilbert <david.gilbert@linaro.org>

Copyright (C) 1995-2019 Free Software Foundation, Inc. Written by Ulrich Drepper <drepper@gnu.org>, 1995.

Copyright (C) 2001-2019 Free Software Foundation, Inc. Contributed by Bruno Haible <bruno@clisp.org>, 2001, 2005.

Copyright (C) 2004-2019 Free Software Foundation, Inc. Contributed by GOTO Masanori <gotom@debian.or.jp>, 2004

Copyright (C) 1998-2019 Free Software Foundation, Inc. Contributed by Philip Blundell <philb@gnu.org>

Copyright (C) 2001-2019 Free Software Foundation, Inc. Contributed by Philip Blundell <philb@gnu.org>, 2001

Copyright (C) 2000-2019 Free Software Foundation, Inc. Written by Ulrich Drepper <drepper@redhat.com>, 2000.

Copyright (C) 2000-2019 Free Software Foundation, Inc. Contributed by Ulrich Drepper <drepper@redhat.com>, 2000.

Copyright (C) 2003-2019 Free Software Foundation, Inc. Contributed by Paul Brook

Copyright (C) 1996-2019 Free Software Foundation, Inc. Contributed by Jochen Hein <jochen.hein@delphi.central.de>, 1997.

Copyright (C) 2000-2019 Free Software Foundation, Inc. Contributed by Bruno Haible <haible@ilog.fr>.

Copyright (C) 2000-2019 Free Software Foundation, Inc. Contributed by Dan Pop for Itanium <Dan.Pop@cern.ch>.

Copyright (C) 2000-2019 Free Software Foundation, Inc. Contributed by Dan Pop <Dan.Pop@cern.ch>.

Copyright (C) 1999-2019 Free Software Foundation, Inc. Written by Jes Sorensen, <Jes.Sorensen@cern.ch>, April 1999.

Copyright (C) 2000-2019 Free Software Foundation, Inc. Contributed by Dan Pop <Dan.Pop@cern.ch> and Jakub Jelinek <jakub@redhat.com>.

Copyright (C) 2000-2019 Free Software Foundation, Inc. Contributed by Dan Pop <Dan.Pop@cern.ch>

Copyright (C) 2000-2019 Free Software Foundation, Inc. Contributed by David Mosberger <davidm@hpl.hp.com>

Copyright (c) 2002 Intel Corporation All rights reserved.

Copyright (c) 2000 - 2003, Intel Corporation All rights reserved.

Copyright (c) 2002 - 2005, Intel Corporation All rights reserved.

Copyright (c) 2000 - 2005, Intel Corporation All rights reserved.

Copyright (c) 2000, 2001, Intel Corporation All rights reserved.

Copyright (c) 2000 - 2004, Intel Corporation All rights reserved.

Copyright (C) 2000, 2001, Intel Corporation All rights reserved.

Copyright (c) 2001 - 2004, Intel Corporation All rights reserved.

Copyright (c) 2000-2002, Intel Corporation All rights reserved.

Copyright (c) 2001 - 2005, Intel Corporation All rights reserved.

Copyright (C) 1997-2019 Free Software Foundation, Inc. Contributed by Christian Boissat <Christian.Boissat@cern.ch>, 1999

Copyright (c) 2001 - 2003, Intel Corporation All rights reserved.

copyright interest in the locale data contained in this file

Copyright (C) 1997-2019 Free Software Foundation, Inc. Contributed by Jes Sorensen <Jes.Sorensen@cern.ch>, 2000.

Copyright (C) 1999-2019 Free Software Foundation, Inc. Contributed by Christian Boissat <Christian.Boissat@cern.ch>, 1999.

Copyright (C) 1997-2019 Free Software Foundation, Inc. Contributed by Jes Sorensen <Jes.Sorensen@cern.ch>, 2000

Copyright (C) 2000-2019 Free Software Foundation, Inc. Contributed by Jes Sorensen <jes@linuxcare.com>, October 2000.

Copyright (c) 2000 - 2003 Intel Corporation All rights reserved.

Copyright (C) 1997-2019 Free Software Foundation, Inc. Contributed by Christian Boissat <Christian.Boissat@cern.ch>, 1999.

Copyright (c) 2002 - 2003, Intel Corporation All rights reserved.

Copyright (c) 2000 - 2002, Intel Corporation All rights reserved.

Copyright (C) 2000-2019 Free Software Foundation, Inc. Contributed by Jes Sorensen <Jes.Sorensen@cern.ch>, 2000.

Copyright (C) 1997-2019 Free Software Foundation, Inc. Contributed by Christian Boissat <Christian.Boissat@cern.ch>, 1999 and Jes Sorensen <Jes.Sorensen@cern.ch>, 2000

Copyright (C) 1993-2019 Free Software Foundation, Inc. Contributed by Brendan Kehoe (brendan@cygnus.com).

Copyright (C) 1997-2019 Free Software Foundation, Inc. Contributed by Zack Weinberg <zack@rabi.phys.columbia.edu>, 1997.

Copyright (C) 1997-2019 Free Software Foundation, Inc. Contributed by Philip Blundell <spb27@cam.ac.uk>, 1997.

Copyright (C) 2001-2019 Free Software Foundation, Inc. Contributed by David Mosberger-Tang <davidm@hpl.hp.com>.

Copyright (C) 1993,1991,1990 Carnegie Mellon University All Rights Reserved.

Copyright (C) 2000-2019 Free Software Foundation, Inc. Contributed by Bruno Haible <haible@clisp.cons.org>, 2000.

Copyright (C) 2014-2019 Free Software Foundation, Inc.

Copyright © 1991-2013 Unicode, Inc. All rights reserved.

Copyright (C) 2014-2019 Free Software Foundation, Inc.

Copyright (C) 1998-2019 Free Software Foundation, Inc. Contributed by Jochen Hein <jochen.hein@delphi.central.de>.

Copyright (C) 2003-2019 Free Software Foundation, Inc. Contributed by Petter Reinholdtsen <pere@hungry.com>, 2003 Based on code by Jochen Hein <jochen.hein@delphi.central.de>, 1997.

Copyright (C) 2003-2019 Free Software Foundation, Inc. Contributed by Petter Reinholdtsen <pere@hungry.com>.

LICENCE TERMS (cont.)

2003

Copyright (C) 1999-2019 Free Software Foundation, Inc. Contributed by Ulrich Drepper <drepper@cygnus.com>.
Copyright (C) 1998-2019 Free Software Foundation, Inc.
Copyright (C) 1998-2019 Free Software Foundation, Inc. Contributed by Andreas Jaeger, <aj@arthur.rhein-neckar.de>, 1998.
Copyright (C) 1999-2019 Free Software Foundation, Inc. Based on quad-precision code by Jakub Jelinek <jj@ultra.linux.cz>
Copyright (C) 1995-2019 Free Software Foundation, Inc. Contributed by Ulrich Drepper <drepper@gnu.org>, 1995.
Copyright (C) 1995-2019 Free Software Foundation, Inc. Contributed by Ulrich Drepper <drepper@cygnus.com>, 1995.
Copyright (C) 1996-2019 Free Software Foundation, Inc. Written by Ulrich Drepper, <drepper@cygnus.com>.
Copyright (C) 1995-2019 Free Software Foundation, Inc. Contributed by Ulrich Drepper <drepper@cygnus.com>, 1995.
Copyright (C) 2014 Free Software Foundation, Inc.
Copyright (C) 2007 Free Software Foundation, Inc.
Copyright (C) 2000, 2002, 2005, 2007-2008, 2011 Free Software Foundation, Inc.
Copyright (C) 1996, 1998, 2000, 2001, 2002, 2003, 2004, 2007, 2008, 2009, 2011, 2013, 2014, 2015 Free Software Foundation, Inc. Bang Jun-Young <bangji@nownuri.net>, 1996-97. Changwoo Ryu <cwryu@debian.org>, 2000-2004, 2007-2009, 2011, 2013-2015, 2017-2018.
Copyright (C) 1998-2001, 2002, 2003, 2004 Free Software Foundation, Inc. Marcel Telka <marcel@telka.sk>, 2002, 2003, 2004. Stanislav Meduna <stano@meduna.org>, 1998-2001.
Copyright © 1996, 1998, 2001, 2002, 2003, 2006, 2008, 2009, 2011, 2012, 2013, 2014, 2015, 2016, 2017, 2018, 2019 Free Software Foundation, Inc.
Copyright (C) 1996, 2009 Free Software Foundation, Inc.
Copyright (C) 2013 Free Software Foundation, Inc.
Copyright (C) 2005, 2009 Free Software Foundation, Inc.
Copyright (C) 1999, 2010, 2011 Free Software Foundation, Inc.
Copyright © 2015 Free Software Foundation, Inc. Clytie Siddall <clytie@riverland.net.au>, 2008-2010. Trần Ngọc Quân <vnwildman@gmail.com>, 2012-2014, 2015, 2016, 2017, 2018.
Copyright © 2002, 2012, 2019 Free Software Foundation, Inc.
Copyright (C) 2008 Free Software Foundation, Inc. Arif E. Nugroho <arif_endro@yahoo.com>, 2008, 2009.
Copyright (C) 2011 Free Software Foundation, Inc.
Copyright (C) 2012 Free Software Foundation, Inc. Nik Kalach <nik.kalach@inbox.ru>, 2012, 2013.
Copyright (C) 1996, 1997, 1998, 1999, 2002, 2003, 2004, 2005, 2006, 2007, 2009, 2010, 2011, 2012, 2013, 2014, 2015, 2017, 2018, 2019 Free Software Foundation, Inc. Paweł Krawczyk <krawietz@ceti.pl>, 1996-1999. Jakub Bogusz
Copyright © 2009 Free Software Foundation, Inc. Lauri Nurmi <lanurmi@iki.fi>, 2002, 2003, 2009. Thanks to: Timo Laine <tila at surfeu.fi> for suggestions
Copyright (C) 1998, 1999, 2000, 2001, 2002, 2003, 2004, 2006, 2007, 2009, 2011, 2012, 2013, 2015 Free Software Foundation, Inc. Ivan Vilata i Balaguer <ivan@selidor.net>, 1998, 1999, 2000, 2001, 2002, 2003, 2004, 2006, 2007, 2008
Copyright (C) 1997 Free Software Foundation, Inc. Vladimir Michl <Vladimir.Michl@seznam.cz>, 1997. Petr Písar <petr.pisar@atlas.cz>, 2007, 2009, 2011, 2012, 2013, 2014, 2015. Petr Písar <petr.pisar@atlas.cz>, 2017, 2018, 2019
Copyright (C) 1996, 1997, 1998, 2001, 2002, 2003, 2004, 2011, 2013 Free Software Foundation, Inc. Enrique Melero Gómez <melero@eurolands.com>, 1996, 1997. Santiago Vila Doncel <sanvila@unex.es>, 1997, 1998, 2001, 2002, 2003
Copyright (C) 1996 Free Software Foundation, Inc.
Copyright (C) 1999, 2000, 2002 Free Software Foundation, Inc. Jacobo Tarrío <jtarrío@trasno.net>, 1999, 2000, 2002.
Copyright © 1996, 2017 Free Software Foundation, Inc. Karl Eichwalder <ke@suse.de>, 2002. Jochen Hein <jochen@jochen.org>, 1996-2019.
Copyright (C) 2013, 2014, 2015, 2016 Free Software Foundation, Inc.
Copyright (C) YEAR Free Software Foundation, Inc.
Copyright (C) 2005 Free Software Foundation, Inc. Steve Murphy <murf@e-tools.com>, 2005. Steve performed initial rough translation from compendium built from translations provided by the following translators: Philibert Ndandali <ndandali@yahoo.fr>, 2005. Viateur MUGENZI <muvia1@yahoo.fr>,
Copyright (C) 2003, 2009 Free Software Foundation, Inc.

Copyright (C) 2002, 2003 Free Software Foundation, Inc. Ales Nyakhaychyk <nab@mail.by>, 2002, 2003. Viktor Siarheichyk <vics@eq.by>, 2014, 2016, 2017, 2018, 2019.
Copyright (C) 2007, 2008, 2009 Free Software Foundation, Inc.
Copyright (C) 1996, 2000, 2004, 2010, 2011 Free Software Foundation, Inc. GOTO Masanori <gotom@debian.or.jp>, 2000-2004. Yasuaki Taniguchi <yasuakit@gmail.com>, 2010, 2011.
Copyright © 2004, 2008, 2009 Free Software Foundation, Inc. Michel Robitaille <robitail@IRO.U.Montreal.CA>, traducteur depuis/since 1996.
Copyright (C) 1998, 1999, 2000, 2001 Free Software Foundation, Inc. Nikos Mavroyanopoulos <nnav@hellug.gr>, 1999, 2000. Simos Xenitellis <S.Xenitellis@rhbnc.ac.uk>, 1999, 2000, 2001.
Copyright (C) 2008 Free Software Foundation, Inc.
Copyright (C) 2019 Free Software Foundation, Inc.
Copyright © 2019 Free Software Foundation, Inc. Fabio Dorival Victorelli <fabio@conectiva.com.br>, 1998. Márcio Macedo <marciom@conectiva.com.br>, 1998. Arnaldo Carvalho de Mello <acme@conectiva.com.br>, 1998. Sandro N
Copyright (C) 2000 Free Software Foundation, Inc. Robert Brady <rwb197@ecs.soton.ac.uk>, 2000.
Copyright (C) 1997-2019 Free Software Foundation, Inc.
Copyright (C) 2014-2019 Free Software Foundation, Inc. Contributed by Aurelien Jarno <aurelien@aurel32.net>, 2014.
Copyright (C) 1998-2019 Free Software Foundation, Inc. Contributed by C. Scott Ananian <cananian@alumni.princeton.edu>, 1998.
Copyright (C) 2001-2019 Free Software Foundation, Inc. Contributed by Andreas Jaeger <aj@suse.de>.
Copyright (C) 2011-2019 Free Software Foundation, Inc. Contributed by Intel Corporation.
Copyright (C) 1996-2019 Free Software Foundation, Inc. Contributed by Ulrich Drepper <drepper@cygnus.com> and Paul Janzen <pcj@primenet.com>, 1996.
Copyright (C) 2010-2019 Free Software Foundation, Inc. Contributed by Intel Corporation.
Copyright (C) 2003-2019 Free Software Foundation, Inc. Contributed by Ulrich Drepper <drepper@redhat.com>, 2003.
Copyright (C) 2009-2019 Free Software Foundation, Inc. Contributed by Intel Corporation.
Copyright (C) 2008-2019 Free Software Foundation, Inc. Contributed by Ulrich Drepper <drepper@redhat.com>.
Copyright (C) 2011-2018 Free Software Foundation, Inc. Contributed by Intel Corporation.
Copyright (C) 2004-2019 Free Software Foundation, Inc. Contributed by Jakub Jelinek <jaku@redhat.com>, 2004.
Copyright (C) 2002-2019 Free Software Foundation, Inc. Contributed by Roland McGrath <roland@redhat.com>, 2002.
Copyright (C) 2005-2019 Free Software Foundation, Inc. Contributed by Ulrich Drepper <drepper@redhat.com>, 2005.
Copyright (C) 2001-2019 Free Software Foundation, Inc. Contributed by Andreas Jaeger <aj@suse.de>, 2001.
Copyright (C) 1991-2019 Free Software Foundation, Inc. Contributed by Ulrich Drepper <drepper@cygnus.com>.
Copyright (C) 2003-2019 Free Software Foundation, Inc. Contributed by Ulrich Drepper <drepper@redhat.com>, 2002.
Copyright (C) 2003-2019 Free Software Foundation, Inc.
Copyright (C) 2003-2019 Free Software Foundation, Inc. Contributed by Ulrich Drepper <drepper@redhat.com> and Richard Henderson <rth@redhat.com>, 2003.
Copyright (C) 1994-2019 Free Software Foundation, Inc. Contributed by Ulrich Drepper <drepper@gnu.ai.mit.edu>. Bug fixes by Alan Modra <Alan@SPRI.Levels.UniSA.Edu.Au>. Adopted for x86-64 by Andreas Jaeger <aj@suse.de>.
Copyright (C) 1999-2019 Free Software Foundation, Inc.
Copyright (C) 2003-2019 Free Software Foundation, Inc. Contributed by Bao Duong <bduong@progress.com>, 2003.
Copyright (C) 2002-2019 Free Software Foundation, Inc. Contributed by Andreas Jaeger <aj@suse.de>.
Copyright (C) 2011-2019 Free Software Foundation, Inc. Contributed by Ulrich Drepper <drepper@gmail.com>, 2011.
Copyright (C) 2000-2019 Free Software Foundation, Inc. Contributed by Ulrich Drepper <drepper@redhat.com>, 2000.
Copyright (C) 2009-2019 Free Software Foundation, Inc. Contributed by Ulrich Drepper <drepper@redha.com>, 2009.
Copyright (C) 2002-2019 Free Software Foundation, Inc. Contributed by Andreas Jaeger <aj@suse.de>, 2002.
Copyright (C) 2013-2019 Free Software Foundation, Inc. Contributed by Mike Frysinger <vapier@gentoo.org>

LICENCE TERMS (cont.)

Copyright (C) 2000-2019 Free Software Foundation, Inc. Contributed by Volkmar Sieh <vs@caldera.de> and Andreas Jaeger <aj@suse.de>.

Copyright (C) 1999-2019 Free Software Foundation, Inc. Contributed by Ulrich Drepper <drepper@cygnus.com>, 1999.

Copyright (C) 2010 Free Software Foundation, Inc.

Copyright (C) 2020 Free Software Foundation, Inc.

Copyright (C) 2006 Free Software Foundation, Inc.

Copyright (c) 1983, 1993 The Regents of the University of California. All rights reserved.

Copyright (c) 1983, 1989, 1993 The Regents of the University of California. All rights reserved.

Copyright (c) 1985, 1993, 1994 The Regents of the University of California. All rights reserved.

Copyright (C) 1997-2019 Free Software Foundation, Inc. Contributed by Philip Blundell <Philip.Blundell@pobox.com>.

Copyright (C) 1998-2019 Free Software Foundation, Inc. Contributed by Ulrich Drepper <drepper@cygnus.com>, 1998.

Copyright (C) 2003-2019 Free Software Foundation, Inc. Contributed by Ulrich Drepper <drepper@cygnus.com>, 2003.

Copyright (C) 1998 WIDE Project. All rights reserved.

Copyright (C) 1991-2019 Free Software Foundation, Inc. Contributed by Ulrich Drepper <drepper@gnu.ai.mit.edu>.

Copyright (C) 1994-2019 Free Software Foundation, Inc. Contributed by Ulrich Drepper <drepper@gnu.ai.mit.edu> Some optimisations by Alan Modra <Alan@SPRI.Levels.UniSA.Edu.Au>

Copyright (C) 1995-2019 Free Software Foundation, Inc. Contributed by Ulrich Drepper, <drepper@gnu.ai.mit.edu>.

Copyright (c) 1982, 1986, 1990, 1993 The Regents of the University of California. All rights reserved.

Copyright (C) 1996-2019 Free Software Foundation, Inc. Contributed by Torbjorn Granlund, <tege@matematik.su.se>

Copyright (C) 1994-2019 Free Software Foundation, Inc. Contributed by Torbjorn Granlund (tege@sics.se).

Copyright (C) 1994-2019 Free Software Foundation, Inc. Contributed by Ulrich Drepper <drepper@gnu.ai.mit.edu>

Copyright (C) 1994-2019 Free Software Foundation, Inc. Contributed by Ulrich Drepper <drepper@gnu.ai.mit.edu>

Copyright (C) 1994-2019 Free Software Foundation, Inc. Contributed by Ulrich Drepper <drepper@gnu.ai.mit.edu>

Copyright (C) 1999-2019 Free Software Foundation, Inc. Contributed by Alexandre Oliva <aoliva@redhat.com>

Copyright (C) 1994-2019 Free Software Foundation, Inc. Contributed by Ulrich Drepper (drepper@gnu.ai.mit.edu).

Copyright (C) 1994-2019 Free Software Foundation, Inc. Contributed by Ulrich Drepper <drepper@gnu.org>

Copyright (C) 2005-2019 Free Software Foundation, Inc. Contributed by Masahide Washizawa <washi@jp.ibm.com>, 2005.

Copyright (C) 2000-2019 Free Software Foundation, Inc. Contributed by Masahide Washizawa <washi@yamato.ibm.co.jp>, 2000.

Copyright (C) 1997-2019 Free Software Foundation, Inc. Contributed by Dirk Alboth <dirka@uni-paderborn.de> and Ulrich Drepper <drepper@cygnus.com>, 1997.

Copyright (C) 2001-2019 Free Software Foundation, Inc. Contributed by Masahide Washizawa <washi@jp.ibm.com>, 2001.

Copyright (C) 1996-2019 Free Software Foundation, Inc. Contributed by Ulrich Drepper <drepper@cygnus.com>, 1996. Based on code by John C. Bowman <bowman@ipp-garching.mpg.de>. Corrections by H.J. Lu (hjl@gnu.ai.mit.edu), 1997.

Copyright (C) 2002-2019 Free Software Foundation, Inc. Contributed by Bruno Haible <bruno@clisp.org>, 2002.

Copyright (C) 2000-2019 Free Software Foundation, Inc. Contributed by Masahide Washizawa <washi@jp.ibm.com>, 2000.

Copyright (C) 2005-2019 Free Software Foundation, Inc. Contributed by Jiro SEKIBA <sekiba@jp.ibm.com>, 2005.

Copyright (C) 2007-2019 Free Software Foundation, Inc. Contributed by Ulrich Drepper <drepper@redhat.com>, 20077.

Copyright (C) 1997-2019 Free Software Foundation, Inc. Contributed by Ulrich Drepper <drepper@cygnus.com>, 1997. Modified for Big5-HKSCS by Roger So <spacehunt@e-fever.org>, 2000.

Copyright (C) 1998-2019 Free Software Foundation, Inc. Contributed by Jungshik Shin <jshin@pantheon.yale.edu> and Ulrich Drepper <drepper@cygnus.com>, 1998.

Copyright (C) 1997-2019 Free Software Foundation, Inc. Contributed by Ulrich Drepper <drepper@cygnus.com>, 1997, Samuel Thibault <samuel.thibault@ens-lyon.org>, 2005.

Copyright (C) 1994-2019 Free Software Foundation, Inc. Contributed by Ulrich Drepper <drepper@ipd.info.uni-karlsruhe.de>. Optimised a little by Alan Modra <Alan@SPRI.Levels.UniSA.Edu.Au>

Copyright (C) 1998-2019 Free Software Foundation, Inc. Contributed by Ulrich Drepper <drepper@cygnus.com>,

1998, and Bruno Haible <bruno@clisp.org>, 2002.

Copyright (C) 2000-2019 Free Software Foundation, Inc. Contributed by David Huggins-Daines (dhd@debian.org)

Copyright (C) 1998-2019 Free Software Foundation, Inc. Contributed by Ulrich Drepper <drepper@cygnus.com>, 1998, and Bruno Haible <haible@clisp.cons.org>, 2001.

Copyright (C) 1995-2019 Free Software Foundation, Inc. Contributed by David Huggins-Daines <dhd@debian.org>

Copyright (C) 1999-2019 Free Software Foundation, Inc. Contributed by Ulrich Drepper, <drepper@cygnus.com>, August 1999.

Copyright (C) 1999-2019 Free Software Foundation, Inc. Contributed by Sean Chen <seanc@turbolinux.com.cn>, 1999.

Copyright (C) 2002-2019 Free Software Foundation, Inc. Contributed by Randolph Chung

Copyright (C) 1998-2019 Free Software Foundation, Inc. Contributed by Jungshik Shin <jshin@pantheon.yale.edu>, 1998.

Copyright (C) 2006-2019 Free Software Foundation, Inc. Contributed by Samuel Thibault <samuel.thibault@ens-lyon.org>, 2006.

Copyright (C) 2000-2019 Free Software Foundation, Inc. Contributed by David Huggins-Daines <dhd@debian.org>

Copyright (C) 2000-2019 Free Software Foundation, Inc. Contributed by David Huggins-Daines <dhd@debian.org>, 2000

Copyright (C) 1997-2019 Free Software Foundation, Inc. Contributed by David Huggins-Daines <dhd@debian.org>

Copyright (C) 1997-2019 Free Software Foundation, Inc. Contributed by David Huggins-Daines <dhd@debian.org>, 2000 Based on the m68k version by Andreas Schwab <schwab@suse.de>

Copyright (C) 1997-2019 Free Software Foundation, Inc. Contributed by David Huggins-Daines <dhd@debian.org>, 2000

Copyright (C) 1999-2019 Free Software Foundation, Inc. Contributed by Kazumoto Kojima <kkojima@rr.ij4u.or.jp> Optimized by Toshiyasu Morita <toshiyasu.morita@hsa.hitachi.com>

Copyright (C) 2006-2019 Free Software Foundation, Inc. Contributed by Alexander Shopov <ash@contact.bg>, 2006.

Copyright (C) 1999-2019 Free Software Foundation, Inc. Contributed by Kazumoto Kojima <kkojima@rr.ij4u.or.jp>

Copyright (C) 1997-2019 Free Software Foundation, Inc. Contributed by Nobuhiro Iwamatsu <iwamatsu@nigauri.org>, 2012.

Copyright (C) 2012-2019 Free Software Foundation, Inc. Contributed by Nobuhiro Iwamatsu <iwamatsu@nigauri.org>, 2012.

Copyright (C) 2001-2019 Free Software Foundation, Inc. Contributed by NIIBE Yutaka <gniibe@m17n.org>

Copyright (C) 1997-2019 Free Software Foundation, Inc. Contributed by MORIYAMA Masayuki <msyk@mtg.biglobe.ne.jp>, 2003.

Copyright (C) 1998-2019 Free Software Foundation, Inc. Contributed by MORIYAMA Masayuki <msyk@mtg.biglobe.ne.jp>, 2003.

Copyright (C) 1999-2019 Free Software Foundation, Inc. Contributed by Sean Chen <sean.chen@turbolinux.com>, 1999.

Copyright (C) 2011-2019 Free Software Foundation, Inc. Contributed by Ryan S. Arnold <rsa@us.ibm.com>, 2011.

Copyright (C) 1992-2019 Free Software Foundation, Inc. Contributed by Gary Funck (gary@intrepid.com). Derived from the DWARF 1 implementation written by Ron Guilmette (rfg@monkeys.com).

Copyright (C) 2016-2019 Free Software Foundation, Inc.

Copyright (C) 1997-2019 Free Software Foundation, Inc. Contributed by Jason Merrill <jason@cygnus.com>.

Copyright (C) 2001-2019 Free Software Foundation, Inc. Contributed by Jakub Jelinek <jakub@redhat.com>.

Copyright (C) 2004-2019 Free Software Foundation, Inc. Contributed by Jakub Jelinek <jakub@redhat.com>, 2004

Copyright (c) 2004 by Internet Systems Consortium, Inc.

Copyright (c) 1983, 1989 The Regents of the University of California. All rights reserved.

Copyright (C) 1996-2019 Free Software Foundation, Inc. Extended from original form by Ulrich Drepper <drepper@cygnus.com>, 1996.

Copyright (c) 1996-1999 by Internet Software Consortium.

Copyright++ 1985, 1988, 1993

Copyright (c) 1985 The Regents of the University of California. All rights reserved.

Copyright (c) 1983, 1987, 1989 The Regents of the University of California. All rights reserved.

Copyright (c) 1996, 1999 by Internet Software Consortium.

Copyright (c) 2004 by Internet Systems Consortium, Inc.

Copyright (c) 1996-1999 by Internet Software Consortium.

Copyright (C) 1991-2019 Free Software Foundation, Inc. Based on strlen implementation by Torbjorn Granlund

LICENCE TERMS (cont.)

(tege@sics.se), with help from Dan Sahlin (dan@sics.se) and commentary by Jim Blandy (jimb@ai.mit.edu); adaptation to memchr suggested by
Copyright (C) 1999-2019 Free Software Foundation, Inc. Written by Jakub Jelinek <jakub@redhat.com>, 1999. Added wcsncmp support by Liubov Dmitrieva <liubov.dmitrieva@gmail.com>, 2011.
Copyright (C) 1995-2019 Free Software Foundation, Inc. Written by Miles Bader <miles@gnu.org>
Copyright (C) 1995-2019 Free Software Foundation, Inc. Written by Ulrich Drepper <drepper@cygnus.com>, 1995.
Copyright (C) 1994-2019 Free Software Foundation, Inc. Contributed by Joel Sherrill (jsherrill@redstone-emh2.army.mil), On-Line Applications Research Corporation.
Copyright (C) 1990-2019 Free Software Foundation, Inc. Contributed by Torbjorn Granlund (tege@sics.se).
Copyright (C) 1999-2019 Free Software Foundation, Inc. Written by Jakub Jelinek <jakub@redhat.com>, 1999. Added wcsrchr support by Liubov Dmitrieva <liubov.dmitrieva@gmail.com>, 2011.
Copyright (C) 1997-2019 Free Software Foundation, Inc. Contributed by Jean-François Bignolles <bignolle@ecoledoc.ibp.fr>, 1997.
Copyright (C) 2008-2019 Free Software Foundation, Inc. Written by Neal H. Walfield <neal@gnu.org>.
Copyright (C) 1996-2019 Free Software Foundation, Inc. Contributed by Ulrich Drepper <drepper@cygnus.com>, 1996.;(c) c define CHAR char define MEMSET memset define STRLEN strlen define STRNLEN strnlen define STRCHR strchr define STRRCHR strrchr define STRCPY strcpy define STRNCPY strncpy define MEMCMP memcmp define STPCPY stpcpy define STPNCPY stpncpy define MEMPCP mempcp
Copyright (C) 2010-2019 Free Software Foundation, Inc. Written by Ulrich Drepper <drepper@redhat.com>, 2010.
Copyright (C) 2008-2019 Free Software Foundation, Inc. Written by Ulrich Drepper <drepper@redhat.com>, 2008.
Copyright (C) 1991-2019 Free Software Foundation, Inc. Contributed by Jakub Jelinek <jakub@redhat.com>.
Copyright (C) 1995-2019 Free Software Foundation, Inc. Written by Ulrich Drepper <drepper@gnu.org>, 1995.
Copyright (C) 2013-2019 Free Software Foundation, Inc. Written by Jakub Jelinek <jakub@redhat.com>, 1999.
Copyright (C) 1999-2019 Free Software Foundation, Inc. Written by Jakub Jelinek <jakub@redhat.com>, 1999. Added wmemcmp support by Liubov Dmitrieva <liubov.dmitrieva@gmail.com>, 2011.
Copyright (C) 1999-2019 Free Software Foundation, Inc. Written by Jakub Jelinek <jakub@redhat.com>, 1999. Added wcsncpy support by Liubov Dmitrieva <liubov.dmitrieva@gmail.com>, 2011
Copyright (C) 2006-2019 Free Software Foundation, Inc. Contributed by Jakub Jelinek <jakub@cygnus.com>, 2006.
Copyright (C) 2011-2019 Free Software Foundation, Inc. Contributed by Intel Corporation.
Copyright (C) 1991-2019 Free Software Foundation, Inc. Based on strlen implementation by Torbjorn Granlund (tege@sics.se), with help from Dan Sahlin (dan@sics.se) and bug fix and commentary by Jim Blandy (jimb@ai.mit.edu); adaptation to strchr s
Copyright (C) 1999-2019 Free Software Foundation, Inc. Written by Jakub Jelinek <jakub@redhat.com>, 1999. Added wcslen support by Liubov Dmitrieva <liubov.dmitrieva@gmail.com>, 2011
Copyright (C) 1997-2019 Free Software Foundation, Inc. Contributed by Ulrich Drepper <drepper@cygnus.com>, 1997 and Jakub Jelinek <jj@ultra.linux.cz>.
Copyright (C) 1999-2019 Free Software Foundation, Inc. Contributed by Jakub Jelinek <jj@ultra.linux.cz>
Copyright (C) 1997-2019 Free Software Foundation, Inc. Written by Miles Bader <miles@gnu.ai.mit.edu>
Copyright 1984, 1991 by Stephen L. Moshier Adapted for glibc October, 2001.
Copyright 2001 by Stephen L. Moshier <moshier@na-net.ornl.gov>
Copyright (C) 2008-2019 Free Software Foundation, Inc. Contributed by Jakub Jelinek <jj@ultra.linux.cz>
Copyright 2001 by Stephen L. Moshier (moshier@na-net.ornl.gov).
Copyright (C) 1991-2019 Free Software Foundation, Inc. Written by Torbjorn Granlund (tege@sics.se), with help from Dan Sahlin (dan@sics.se); commentary by Jim Blandy (jimb@ai.mit.edu).
Copyright (C) 1994-2019 Free Software Foundation, Inc.
Copyright (C) 1999-2019 Free Software Foundation, Inc. Written by Jakub Jelinek <jakub@redhat.com>, 1999. Added wcschr support by Liubov Dmitrieva <liubov.dmitrieva@gmail.com>, 2011
Copyright 2001 by Stephen L. Moshier
Copyright (C) 1993, 2011 by Sun Microsystems, Inc. All rights reserved.
Copyright (C) 1993 by Sun Microsystems, Inc. All rights reserved.
Copyright (C) 1994-2019 Free Software Foundation, Inc. Written by Ulrich Drepper <drepper@gnu.ai.mit.edu>, October 1994.
Copyright (C) 1997-2019 Free Software Foundation, Inc. Contributed by Ulrich Drepper <drepper@cygnus.com>, 1997 and Jakub Jelinek <jj@ultra.linux.cz>, 1999.
Copyright (C) 1997-2019 Free Software Foundation, Inc. Contributed by Ulrich Drepper <drepper@cygnus.com>, 1997 and Jakub Jelinek <jj@ultra.linux.cz>, 1999.

Copyright (C) 1995-2019 Free Software Foundation, Inc. Contributed by Ulrich Drepper, <drepper@gnu.org>.
Copyright (C) 1999-2019 Free Software Foundation, Inc. Contributed by Jakub Jelinek <jj@ultra.linux.cz> Partly based on double-precision code by Geoffrey Keating <geoffk@ozemail.com.au>
Copyright 1984, 1991 by Stephen L. Moshier Adapted for glibc November, 2001
Copyright 2001 by Stephen L. Moshier (moshier@na-net.ornl.gov).
Copyright (C) 1999-2019 Free Software Foundation, Inc. Written by Ulrich Drepper, <drepper@cygnus.com>.
Copyright (C) 1999-2019 Free Software Foundation, Inc. Contributed by Ulrich Drepper <drepper@redhat.com>, 1999.
Copyright (C) 2002-2019 Free Software Foundation, Inc. Contributed by Ulrich Drepper <drepper@cygnus.com>, 2002.
Copyright (c) 1983, 1992, 1993 The Regents of the University of California. All rights reserved.
Copyright (C) 2011-2019 Free Software Foundation, Inc. Contributed by David Flaherty <flaherty@linux.vnet.ibm.com>.
Copyright (C) 1996-2019 Free Software Foundation, Inc. Contributed by David Mosberger <davidm@cs.arizona.edu>.
Copyright (c) 1982, 1986, 1992, 1993 The Regents of the University of California. All rights reserved.
Copyright (c) 1983, 1992, 1993, 2011 The Regents of the University of California. All rights reserved.
Copyright (C) 1992-2019 Free Software Foundation, Inc. See the end for copying conditions.
Copyright (C) 2016-2019 Free Software Foundation, Inc.
Copyright (C) 2018-2019 Free Software Foundation, Inc.
Copyright (C) 2011-2019 Free Software Foundation, Inc. Contributed by Ulrich Drepper <drepper@cygnus.com>, 2011.
Copyright (C) 2018-2019 Free Software Foundation, Inc.
Copyright (C) 1999-2019 Free Software Foundation, Inc. Based on quad-precision cosine by Jakub Jelinek <jj@ultra.linux.cz>
Copyright (C) 1999-2019 Free Software Foundation, Inc. Based on quad-precision tables by Jakub Jelinek <jj@ultra.linux.cz>
Copyright (C) 1999-2019 Free Software Foundation, Inc. Based on quad-precision sine by Jakub Jelinek <jj@ultra.linux.cz>
Copyright (C) 2008-2019 Free Software Foundation, Inc. Contributed by David S. Miller <davem@davemloft.net>, 2008
Copyright (C) 1996-2019 Free Software Foundation, Inc. Contributed by David S. Miller (davem@caip.rutgers.edu) and Jakub Jelinek (jakub@redhat.com).
Copyright (C) 1998-2019 Free Software Foundation, Inc. Contributed by Jan Vondrak <jvon4518@ss1000.ms.mff.cuni.cz>, Jakub Jelinek <jj@ultra.linux.cz>, and David S. Miller <davem@davemloft.net>.
Copyright (C) 1997-2019 Free Software Foundation, Inc. Contributed by Richard Henderson (rth@cygnus.com), Jakub Jelinek (jj@ultra.linux.cz) and David S. Miller (davem@redhat.com).
Copyright (C) 1997-2019 Free Software Foundation, Inc. Contributed by Jakub Jelinek (jj@ultra.linux.cz).
Copyright (C) 2010-2019 Free Software Foundation, Inc. Contributed by David S. Miller (davem@davemloft.net)
Copyright (C) 2006-2019 Free Software Foundation, Inc. Contributed by David S. Miller (davem@davemloft.net)
Copyright (C) 2001-2019 Free Software Foundation, Inc. Contributed by David S. Miller (davem@redhat.com)
Copyright (C) 2012-2019 Free Software Foundation, Inc. Contributed by David S. Miller (davem@davemloft.net)
Copyright (C) 2007-2019 Free Software Foundation, Inc. Contributed by David S. Miller (davem@davemloft.net)
Copyright (C) 1998-2019 Free Software Foundation, Inc. Contributed by Jan Vondrak <jvon4518@ss1000.ms.mff.cuni.cz> and Jakub Jelinek <jj@ultra.linux.cz>.
Copyright (C) 1997-2019 Free Software Foundation, Inc. Contributed by Jan Vondrak <jvon4518@ss1000.ms.mff.cuni.cz> and Jakub Jelinek <jj@ultra.linux.cz>.
Copyright (C) 1998-2019 Free Software Foundation, Inc. Contributed by Jakub Jelinek <jj@ultra.linux.cz> and Jan Vondrak <jvon4518@ss1000.ms.mff.cuni.cz>.
Copyright (C) 1999-2019 Free Software Foundation, Inc. Contributed by Jakub Jelinek <jj@ultra.linux.cz>. This version is developed using the same algorithm as the fast C version which carries the following introduction: Based on strlen implement
Copyright (C) 1998-2019 Free Software Foundation, Inc. Contributed by Jan Vondrak <jvon4518@ss1000.ms.mff.cuni.cz> and Jakub Jelinek <jj@ultra.linux.cz>. This version is developed using the same algorithm as the fast C version whi
Copyright (C) 2005-2019 Free Software Foundation, Inc. Contributed by David S. Miller <davem@davemloft.net>, 2005.

LICENCE TERMS (cont.)

Copyright (C) 1996-2019 Free Software Foundation, Inc. Contributed by David S. Miller (davem@caip.rutgers.edu) and Jakub Jelinek (jj@ultra.linux.cz).
Copyright (C) 2011-2019 Free Software Foundation, Inc. Contributed by David S. Miller <davem@davemloft.net>
Copyright (C) 1996-2019 Free Software Foundation, Inc. Contributed by David S. Miller <davem@caip.rutgers.edu>, Eddie C. Dost <ecd@skynet.be> and Jakub Jelinek <jj@ultra.linux.cz>.
Copyright (C) 1996-2019 Free Software Foundation, Inc. Contributed by Jakub Jelinek <jj@ultra.linux.cz> and David S. Miller <davem@davemloft.net>.
Copyright 1992-2019 Free Software Foundation, Inc.
Copyright (C) 1993 by Digital Equipment Corporation.
Copyright (c) 1996-1999 by Internet Software Consortium.
Copyright (c) 2010, Oracle America, Inc.
Copyright (C) 1991,1990,1989 Carnegie Mellon University All Rights Reserved.
Copyright (c) 2000, Intel Corporation
copyright(C) by Craig Metz and are distributed under the following license:
Copyright (C) 1992 Eric Young Collected from libdes and modified for SECURE RPC by Martin Kuck 1994
Copyright (C) 1998 WIDE Project. All rights reserved.
Copyright 1995 by Tom Lord
Copyright 1992, 1993, 1994, 1997 Henry Spencer. All rights reserved.
Copyright (c) 1997-2003 University of Cambridge
Copyright (C) 1993 by Sun Microsystems, Inc. All rights reserved.
Copyright 2001 by Stephen L. Moshier <moshier@na-net.ornl.gov>
Copyright (C) 1993 by Digital Equipment Corporation.
Copyright (c) 1996-1999 by Internet Software Consortium.
Copyright (c) 2010, Oracle America, Inc.
Copyright (C) 1991,1990,1989 Carnegie Mellon University All Rights Reserved.
Copyright (c) 2000, Intel Corporation
Copyright(C) by Craig Metz and are distributed under the following license:
Copyright (C) 1992 Eric Young Collected from libdes and modified for SECURE RPC by Martin Kuck 1994
Copyright (C) 1998 WIDE Project. All rights reserved.
Copyright 1995 by Tom Lord
Copyright 1992, 1993, 1994, 1997 Henry Spencer. All rights reserved.
Copyright (c) 1997-2003 University of Cambridge
Copyright (C) 1993 by Sun Microsystems, Inc. All rights reserved.
Copyright 2001 by Stephen L. Moshier <moshier@na-net.ornl.gov>
Copyright (c) 1989, 1993 The Regents of the University of California. All rights reserved.
Copyright (c) 1989, 1993 The Regents of the University of California. All rights reserved.
Copyright (c) 1990, 1993, 1994 The Regents of the University of California. All rights reserved.
Copyright (c) 1990, 1993, 1994 The Regents of the University of California. All rights reserved.
Copyright (c) 1990 Regents of the University of California. All rights reserved.
Copyright (c) 1990 Regents of the University of California. All rights reserved.
Copyright (C) 1983 Regents of the University of California. All rights reserved.
Copyright (C) 1983 Regents of the University of California. All rights reserved.
Copyright (C) 1995, 1999 by Ralf Baechle
Copyright (C) 1995, 1999 Ralf Baechle
Copyright (C) 1995, 1999 Silicon Graphics
Copyright (C) 1990 The Regents of the University of California. All rights reserved.
Copyright (C) 1990 The Regents of the University of California. All rights reserved.
copyright. Rewritten by Roland McGrath
Copyright (c) 1991,1990 Carnegie Mellon University All Rights Reserved.
copyright. Rewritten by Roland McGrath (FSF) 93/12/06
Copyright (c) 1991,1990 Carnegie Mellon University All Rights Reserved.
Copyright (c) 1982, 1986 Regents of the University of California. All rights reserved.
Copyright (c) 1982, 1986 Regents of the University of California. All rights reserved.
copyright(c) UNIX System Laboratories, Inc.
Copyright (c) 1982, 1986, 1993 The Regents of the University of California. All rights reserved.
Copyright (c) 1982, 1986, 1993 The Regents of the University of California. All rights reserved.
Copyright (C) 2012 Free Software Foundation, Inc.

Copyright (C) 2012 Free Software Foundation, Inc.
Copyright (C) 2019 Free Software Foundation, Inc.
Copyright (C) 1987, Sun Microsystems, Inc.
Copyright (C) 1987, Sun Microsystems, Inc.
Copyright (C) 1987 Sun Microsystems, Inc.
Copyright (C) 1987 Sun Microsystems, Inc.
Copyright (c) 1990, 1991 Sun Microsystems, Inc.
Copyright (c) 1990, 1991 Sun Microsystems, Inc.
Copyright (C) 2012-2019 Free Software Foundation, Inc.
Copyright (C) 2012-2019 Free Software Foundation, Inc.
Copyright (C) 2012-2019 Free Software Foundation, Inc.
Copyright (C) 2011 Free Software Foundation, Inc.
Copyright 1996 by Craig Metz, All Rights Reserved. */
Copyright 1996 by Craig Metz, All Rights Reserved. */
Copyright (C) 1982, 1986, 1988 Regents of the University of California. All rights reserved.
Copyright (C) 1982, 1986, 1988 Regents of the University of California. All rights reserved.
Copyright (c) 1982, 1986, 1989 The Regents of the University of California. All rights reserved.
Copyright (c) 1982, 1986, 1989 The Regents of the University of California. All rights reserved.
Copyright ©Free Software Foundation, Inc.
Copyright (C) 2006 Free Software Foundation, Inc.
Copyright(C) 2006 Free Software Foundation, Inc.
Copyright (C) 1982, 1986 Regents of the University of California. All rights reserved.
Copyright (C) 1982, 1986 Regents of the University of California. All rights reserved.
Copyright (C) 2010 Free Software Foundation, Inc.
Copyright (C) 2010 Free Software Foundation, Inc.
Copyright (c) 1988 Stephen Deering.
Copyright (c) 1992, 1993 The Regents of the University of California. All rights reserved.
Copyright (c) 1988 Stephen Deering.
Copyright (c) 1992, 1993 The Regents of the University of California. All rights reserved.
Copyright (C) 2013-2019 Free Software Foundation, Inc.
Copyright (C) 2013-2019 Free Software Foundation, Inc.
Copyright (c) 1983, 1993, 1994 The Regents of the University of California. All rights reserved.
Copyright (c) 1983, 1993, 1994 The Regents of the University of California. All rights reserved.
Copyright (c) 1996,1999 by Internet Software Consortium.
Copyright (c) 1995-1999 by Internet Software Consortium.
Copyright (c) 1993 by Digital Equipment Corporation.
Copyright (c) 1996-1999 by Internet Software Consortium.
Copyright (c) 1993 by Digital Equipment Corporation.
Copyright (c) 1996-1999 by Internet Software Consortium.
Copyright (c) 2004 by Internet Systems Consortium, Inc.
Copyright (c) 2004 by Internet Systems Consortium, Inc.
Copyright (c) 1985, 1989, 1993 The Regents of the University of California. All rights reserved.
Copyright (c) 1985, 1989, 1993 The Regents of the University of California. All rights reserved.
Copyright++ 1985, 1988, 1993
Copyright (c) 1985, 1988, 1993 The Regents of the University of California. All rights reserved.
Copyright++ 1985, 1988, 1993
Copyright (c) 1985, 1988, 1993 The Regents of the University of California. All rights reserved.
Copyright (c) 1993 Carlos Leandro and Rui Salgueiro Dep.
Copyright (c) 1983, 1993 The Regents of the University of California. All rights reserved.
Copyright (c) 1993 Carlos Leandro and Rui Salgueiro Dep.
Copyright (c) 1983, 1993 The Regents of the University of California. All rights reserved.
Copyright (c) 1999 by Internet Software Consortium.
Copyright (c) 1985, 1993 The Regents of the University of California. All rights reserved.
Copyright (c) 1985, 1993 The Regents of the University of California. All rights reserved.
Copyright (c) 1995 by International Business Machines, Inc.
Copyright (c) 1995 by International Business Machines, Inc.
Copyright (c) 1983, 1990, 1993 The Regents of the University of California. All rights reserved.

LICENCE TERMS (cont.)

Copyright (c) 1983, 1990, 1993 The Regents of the University of California. All rights reserved.
Copyright (c) 1995,1999 by Internet Software Consortium.
Copyright (C) 2001 Stephen L. Moshier <moshier@na-net.ornl.gov> and are incorporated herein by permission of the author. The author reserves the right to distribute this material elsewhere under different copying permissions.
Copyright (C) 2001 Stephen L. Moshier <moshier@na-net.ornl.gov> and are incorporated herein by permission of the author. The author reserves the right to distribute this material elsewhere under different copying permissions.
Copyright (C) 1993 by Sun Microsystems, Inc. All rights reserved.
Copyright (C) 1992-2019 Free Software Foundation, Inc.
Copyright (C) 1992-2019 Free Software Foundation, Inc.
Copyright (C) 1993 by Sun Microsystems, Inc. All rights reserved.
Copyright (C) 1994 X Consortium

Copyright (C) 1999-2018 Free Software Foundation, Inc. Written by Tom Tromeey <tromeey@cygnus.com>.
Copyright 1992-2019 Free Software Foundation, Inc.
Copyright (C) 1996-2018 Free Software Foundation, Inc. Originally written by Fran.cois Pinard <pinard@iro.umontreal.ca>, 1996.
Copyright (C) 2011-2018 Free Software Foundation, Inc.
Copyright (C) 1989, 1991 Free Software Foundation, Inc.
Copyright (C) 2007 Free Software Foundation, Inc.
Copyright (C) 1994-1996, 1999-2002, 2004-2016 Free Software Foundation, Inc.
Copyright (C) 1996-2018 Free Software Foundation, Inc.
Copyright 2010-2012 Free Software Foundation, Inc.
Copyright 2000 Free Software Foundation, Inc.
Copyright 2012, 2013, 2015 Free Software Foundation, Inc.
Copyright 1993-1995, 2000, 2001, 2003, 2004 Free Software Foundation, Inc.
Copyright 1993-1995, 1999-2002, 2004, 2012, 2015 Free Software Foundation, Inc.
Copyright 1993-1996, 2000-2002, 2004, 2005, 2012 Free Software Foundation, Inc.
Copyright 2003, 2005, 2007, 2011, 2012, 2015 Free Software Foundation, dnl Inc.
Copyright 1993, 1994, 1996, 2000-2002, 2004, 2005, 2010, 2012 Free Software Foundation, Inc.
Copyright 2009-2012, 2014 Free Software Foundation, Inc.
Copyright 2009, 2014, 2015 Free Software Foundation, Inc.
Copyright 2011 Free Software Foundation, Inc.
Copyright 2001, 2002, 2004 Free Software Foundation, Inc.
Copyright 2008, 2011, 2012 Free Software Foundation, Inc.
Copyright 1993-1995, 2000, 2001, 2004 Free Software Foundation, Inc.
Copyright 2008, 2009, 2011, 2012 Free Software Foundation, Inc.
Copyright 2001 Free Software Foundation, Inc.
Copyright 2011, 2012 Free Software Foundation, Inc.
Copyright 1996, 1999, 2001, 2002, 2004, 2005 Free Software Foundation, Inc.
Copyright 1991, 1993, 1994, 2000-2012, 2014 Free Software Foundation, Inc.
Copyright 2001, 2002, 2014 Free Software Foundation, Inc.
Copyright 2006, 2010-2012 Free Software Foundation, Inc.
Copyright 1993, 1994, 1996, 2000, 2001, 2004, 2005, 2012 Free Software Foundation, Inc.
Copyright 2004, 2008, 2013 Free Software Foundation, Inc.
Copyright 1996, 2000-2002, 2005 Free Software Foundation, Inc.
Copyright 2001, 2002, 2014-2015 Free Software Foundation, Inc.
Copyright 2008, 2012 Free Software Foundation, Inc.
Copyright 1996, 1998-2002 Free Software Foundation, Inc.
Copyright 2013 Free Software Foundation, Inc.
Copyright 2001-2004 Free Software Foundation, Inc.
Copyright 2009-2012 Free Software Foundation, Inc.
Copyright 1993-1995, 1999, 2001, 2002, 2015 Free Software Foundation, Inc.
Copyright 2003, 2005, 2007, 2011-2013, 2015 Free Software Foundation, Inc.
Copyright 1993-1997, 2000-2003, 2005, 2007, 2008, 2011, 2013 Free Software Foundation, Inc.
Copyright 1993-1995, 2000, 2001 Free Software Foundation, Inc.
Copyright 2011-2013 Free Software Foundation, Inc.
Copyright 1993, 1995, 1996, 2001, 2002, 2008, 2009, 2012 Free Software Foundation, Inc.

Copyright 2003-2005, 2007, 2008, 2011-2013 Free Software Foundation, Inc.
Copyright 2001, 2004, 2012 Free Software Foundation, Inc.
Copyright 2003-2005, 2007, 2008, 2012, 2013 Free Software Foundation, Inc.
Copyright 2012 Free Software Foundation, Inc.
Copyright 1993, 1994, 1996, 2001, 2005 Free Software Foundation, Inc.
Copyright 1993, 1994, 1996, 2000, 2001, 2005 Free Software Foundation, Inc.
Copyright 2001, 2002, 2013, 2014 Free Software Foundation, Inc.
Copyright 1993-1996, 2001, 2003, 2004 Free Software Foundation, Inc.
Copyright 1996, 2001-2004 Free Software Foundation, Inc.
Copyright 1991, 1993, 1994, 2000-2010, 2012, 2014, 2015 Free Software Foundation, Inc.
Copyright 1995, 1996, 2000, 2001, 2004 Free Software Foundation, Inc.
Copyright 2003-2005, 2007, 2008, 2010-2012 Free Software Foundation, Inc.
Copyright 1993, 1994, 1996, 2000, 2001 Free Software Foundation, Inc.
Copyright 2008, 2011-2013 Free Software Foundation, Inc.
Copyright 1993, 1994, 1996, 2001, 2015 Free Software Foundation, Inc.
Copyright 2001, 2002 Free Software Foundation, Inc.
Copyright 2007, 2011 Free Software Foundation, Inc.
Copyright (C) 1994-2018 Free Software Foundation, Inc.
Copyright 1993-1997, 2000-2003, 2005, 2006, 2011, 2015 Free Software Foundation, Inc.
Copyright 1993-1995, 2001 Free Software Foundation, Inc.
Copyright 1998, 1999, 2001, 2012, 2015 Free Software Foundation, Inc.
Copyright 2012, 2013 Free Software Foundation, Inc.
Copyright 2003, 2005, 2009, 2011, 2012 Free Software Foundation, Inc.
Copyright 1995, 1996, 2001-2003 Free Software Foundation, Inc.
Copyright 2003-2005, 2007, 2008, 2011, 2012 Free Software Foundation, Inc.
Copyright 1993, 1994, 1996, 2000, 2001, 2004, 2005, 2015 Free Software Foundation, Inc.
Copyright 1993, 1994, 1996, 2000-2002, 2004 Free Software Foundation, Inc.
Copyright 1993, 1994, 1996, 2001 Free Software Foundation, Inc.
Copyright 1993-1995, 2001, 2004 Free Software Foundation, Inc.
Copyright 2009, 2015 Free Software Foundation, Inc.
Copyright 1993-1995, 2000, 2001, 2003, 2004, 2012 Free Software Foundation, Inc.
Copyright 1996, 2000, 2001 Free Software Foundation, Inc.
Copyright 2004, 2005, 2007, 2010-2012 Free Software Foundation, Inc.
Copyright 2007, 2008, 2010, 2014 Free Software Foundation, Inc.
Copyright 2004-2006, 2011, 2012 Free Software Foundation, Inc.
Copyright 2008, 2011, 2012 Free Software Foundation, Inc.
Copyright 1993-1996, 2001, 2002, 2005, 2014 Free Software Foundation, Inc.
Copyright 1993-1995, 2001, 2002, 2004 Free Software Foundation, Inc.
Copyright 1993, 1994, 1996, 2000-2002, 2004, 2005, 2012 Free Software Foundation, Inc.
Copyright 1996, 2001, 2004, 2005 Free Software Foundation, Inc.
Copyright 1996, 2001 Free Software Foundation, Inc.
Copyright 2001, 2003 Free Software Foundation, Inc.
Copyright 1993-1995, 2000-2002, 2004, 2012 Free Software Foundation, Inc.
Copyright 1991, 1993, 1994, 2000-2010, 2012 Free Software Foundation, Inc.
Copyright 1999-2002 Free Software Foundation, Inc.
Copyright 2000-2002, 2004, 2005, 2007, 2009-2012 Free Software Foundation, dnl Inc.
Copyright 1993, 1994, 1996, 2001, 2003, 2004 Free Software Foundation, Inc.
Copyright 1997, 1998, 2000, 2001, 2013 Free Software Foundation, Inc.
Copyright 2003, 2004, 2009, 2011-2015 Free Software Foundation, Inc.
Copyright 1993-1996, 1999-2002, 2004, 2005, 2011, 2014 Free Software Foundation, Inc.
Copyright 2003, 2009 Free Software Foundation, Inc.
Copyright 1996, 2001, 2004 Free Software Foundation, Inc.
Copyright 1991, 1993, 1994, 2000-2003, 2009, 2011 Free Software Foundation, Inc.
Copyright 1996, 1997, 2001, 2002, 2005, 2011 Free Software Foundation, Inc.
Copyright 2003, 2009, 2011-2014, 2016 Free Software Foundation, Inc.
Copyright 2015 Free Software Foundation, Inc.
Copyright 1991, 1996, 1999, 2000, 2007 Free Software Foundation, Inc.

LICENCE TERMS (cont.)

Copyright 1991, 1993, 1994, 1999-2004, 2008-2011 Free Software Foundation, Inc.
Copyright 2002, 2004, 2009, 2010 Free Software Foundation, Inc.
Copyright 2002, 2005 Free Software Foundation, Inc.
Copyright 2003, 2005, 2007 Free Software Foundation, Inc.
Copyright (C) 1994-1996, 1999-2002 Free Software Foundation, Inc.
Copyright 2000-2002, 2005, 2006 Free Software Foundation, Inc.
Copyright 1991, 1993, 1994, 2000-2002, 2012 Free Software Foundation, Inc.
Copyright 2008 Free Software Foundation, Inc.
Copyright 2000, 2002, 2003 Free Software Foundation, Inc.
Copyright 2000-2002, 2004 Free Software Foundation, Inc.
Copyright 2000, 2002, 2005 Free Software Foundation, Inc.
Copyright 2007, 2008, 2012 Free Software Foundation, Inc.
Copyright 1999-2003, 2005, 2006, 2008-2015 Free Software Foundation, Inc.
Copyright 1995, 1998, 2000, 2002-2005 Free Software Foundation, Inc.
Copyright 1991, 1993, 1994, 1999-2004, 2008-2010, 2014, 2015 Free Software Foundation, Inc.
Copyright 1999-2003, 2005, 2006, 2008-2012 Free Software Foundation, Inc.
Copyright 2002, 2003, 2005 Free Software Foundation, Inc.
Copyright 2000, 2005 Free Software Foundation, Inc.
Copyright 2002, 2005, 2007 Free Software Foundation, Inc.
Copyright 2002, 2003, 2005, 2006 Free Software Foundation, Inc.
Copyright 2000-2003, 2005-2011 Free Software Foundation, Inc.
Copyright 1999-2006, 2008-2015 Free Software Foundation, Inc.
Copyright 1999, 2000, 2005 Free Software Foundation, Inc.
Copyright 1995, 1998, 2000, 2002-2005, 2010 Free Software Foundation, Inc.
Copyright 1999, 2000, 2003-2005 Free Software Foundation, Inc.
Copyright 2002, 2003, 2005-2007, 2012 Free Software Foundation, Inc.
Copyright 2000, 2003 Free Software Foundation, Inc.
Copyright 1999-2004, 2010-2012 Free Software Foundation, Inc.
Copyright 1995, 1997, 1998, 2000, 2002, 2005 Free Software Foundation, dnl Inc.
Copyright 1991, 1993, 1994, 1999-2004, 2008-2011, 2014 Free Software Foundation, Inc.
Copyright 1995, 1997, 1998, 2000-2003, 2005 Free Software Foundation, Inc.
Copyright 1991, 1993, 1994, 2000, 2006, 2008-2010, 2012 Free Software Foundation, Inc.
Copyright (C) 2000 Free Software Foundation, Inc.
Copyright 1996, 2000 Free Software Foundation, Inc.
Copyright 2002, 2010 Free Software Foundation, Inc.
Copyright 1991, 2000, 2001 Free Software Foundation, Inc.
Copyright 1999-2004 Free Software Foundation, Inc.
Copyright 1991, 1993, 1994, 1996, 2000-2002, 2004 Free Software Foundation, Inc.
Copyright 1999, 2000 Free Software Foundation, Inc.
Copyright 2008, 2010, 2011 Free Software Foundation, Inc.
Copyright 1991, 1993, 1994, 1996, 2000-2004 Free Software Foundation, Inc.
Copyright 2002-2004 Free Software Foundation, Inc.
Copyright 1995, 2000, 2011 Free Software Foundation, Inc.
Copyright 1999, 2000, 2002, 2003, 2005 Free Software Foundation, Inc.
Copyright 2002-2004, 2012, 2014 Free Software Foundation, Inc.
Copyright 1995, 1997, 2000, 2011 Free Software Foundation, Inc.
Copyright 2003, 2013 Free Software Foundation, Inc.
Copyright 2001, 2003 Free Software Foundation, Inc.
Copyright 1991-1994, 1996, 1997, 2000-2005, 2008, 2010, 2011, 2015 Free Software Foundation, Inc.
Copyright 2006, 2007, 2009, 2010 Free Software Foundation, Inc.
Copyright 2006, 2007, 2009 Free Software Foundation, Inc.
Copyright 2007, 2009 Free Software Foundation, Inc.
Copyright 2006, 2009, 2011, 2012 Free Software Foundation, Inc.
Copyright 1992-1994, 1996, 2000, 2002, 2008, 2009, 2011, 2013 Free Software Foundation, Inc.
Copyright 1996, 1998, 2000-2004, 2008, 2012 Free Software Foundation, Inc.
Copyright 1991, 1993, 1994, 1996, 1998-2000, 2002, 2003 Free Software Foundation, Inc.
Copyright 1993-1996, 1999-2002 Free Software Foundation, Inc.

Copyright 1996, 1999-2002, 2006, 2012 Free Software Foundation, Inc.
Copyright 1996, 1999-2001 Free Software Foundation, Inc.
Copyright 2005-2007, 2009, 2010 Free Software Foundation, Inc.
Copyright 1996 Free Software Foundation, Inc.
Copyright 1991-1994, 1996, 1997, 1999-2005, 2007-2009, 2011-2016 Free Software Foundation, Inc.
Copyright 2009, 2010, 2012 Free Software Foundation, Inc.
Copyright 1991-1997, 1999-2016 Free Software Foundation, Inc.
Copyright 2011-2015 Free Software Foundation, Inc.
Copyright 2009, 2010, 2012, 2014 Free Software Foundation, Inc.
Copyright 2009, 2012 Free Software Foundation, Inc.
Copyright 2012, Free Software Foundation, Inc.
Copyright 2006, 2007, 2009, 2012 Free Software Foundation, Inc.
Copyright 2001, 2002, 2004, 2011, 2012, 2014, 2016 Free Software Foundation, Inc.
Copyright 1991, 1993, 1994, 1999, 2000, 2002, 2007-2009, 2012 Free Software Foundation, Inc.
Copyright 2001-2003, 2005, 2013 Free Software Foundation, Inc.
Copyright 2009, 2011, 2012 Free Software Foundation, Inc.
Copyright 2011, 2012, 2014, 2016 Free Software Foundation, Inc.
Copyright 2000-2003, 2008 Free Software Foundation, Inc.
Copyright 2000-2004 Free Software Foundation, Inc.
Copyright 2011, 2016 Free Software Foundation, Inc.
Copyright 2002, 2005, 2009-2012, 2015 Free Software Foundation, Inc.
Copyright 2012, 2014, Free Software Foundation, Inc.
Copyright 1991, 1993, 1994, 1996, 2000-2002 Free Software Foundation, Inc.
Copyright 2009, 2010 Free Software Foundation, Inc.
Copyright 2006-2008, 2010, 2012 Free Software Foundation, Inc.
Copyright 2000-2002, 2012, 2013 Free Software Foundation, Inc.
Copyright 2003-2005, 2008, 2011, 2012 Free Software Foundation, Inc.
Copyright 2011, Free Software Foundation, Inc.
Copyright 1993-1996, 1999-2002, 2011 Free Software Foundation, Inc.
Copyright 2011, 2013, Free Software Foundation, Inc.
Copyright (C) 2000-2002, 2004, 2008, 2009, 2012 Free Software Foundation, Inc.
Copyright 2012, 2014, 2016, Free Software Foundation, Inc.
Copyright 2013, 2014, Free Software Foundation, Inc.
Copyright 2007-2009, 2011-2014 Free Software Foundation, Inc.
Copyright 1996, 1999-2002, 2009, 2012 Free Software Foundation, Inc.
Copyright 2000-2003, 2005, 2009 Free Software Foundation, Inc.
Copyright 2006-2008, 2013 Free Software Foundation, Inc.
Copyright 2013, 2014 Free Software Foundation, Inc.
Copyright 2013-2015, Free Software Foundation, Inc.
Copyright 1985, 1986, 1988, 1990, 1991, 1992, 1993, 1994, 1995, 1996, 1997, 1998, 1999, 2000, 2001, 2002, 2003, 2004, 2005, 2006, 2007, 2008, 2009, 2010, 2011, 2012, 2013, 2014, 2015, 2016, 2017, 2018 Free Software Foundation, Inc.
Copyright 2000-2003, 2005-2007, 2009 Free Software Foundation, Inc.
Copyright 2001, 2002, 2012, 2014 Free Software Foundation, Inc.
Copyright 2009, 2010, 2012, 2015 Free Software Foundation, Inc.
Copyright 2013, 2016 Free Software Foundation, Inc.
Copyright 1991-1994, 1996, 2000-2002, 2004, 2006-2008, 2012, 2013 Free Software Foundation, Inc.
Copyright 2006, 2007, 2009-2011 Free Software Foundation, Inc.
Copyright (C) 1995-2018 Free Software Foundation, Inc.
Copyright 2006-2010, 2013 Free Software Foundation, Inc.
Copyright 1997, 2000-2002, 2005, 2009 Free Software Foundation, Inc.
Copyright 1991, 1993, 1994, 1996, 1997, 1999-2003, 2005-2007, 2009, 2010, 2012, 2014 Free Software Foundation, Inc.
Copyright 1999-2001, 2006 Free Software Foundation, Inc.
Copyright 2012, 2016 Free Software Foundation, Inc.
Copyright 2009, 2010, 2012, 2013 Free Software Foundation, Inc.
Copyright 1993-1997, 1999-2002, 2005 Free Software Foundation, Inc.

LICENCE TERMS (cont.)

Copyright 2012-2014, 2016 Free Software Foundation, Inc.
Copyright 1991, 1993, 1994, 1996-2003, 2005, 2008, 2009 Free Software Foundation, Inc.
Copyright 2003, 2004, 2007, 2009, 2010, 2012 Free Software Foundation, Inc.
Copyright 2006-2008, 2012, 2014 Free Software Foundation, Inc.
Copyright 2002, 2011-2015 Free Software Foundation, Inc.
Copyright 2009, 2012-2014 Free Software Foundation, Inc.
Copyright 2001, 2004 Free Software Foundation, Inc.
Copyright 1991, 1993, 1994, 2000-2002, 2004, 2005 Free Software Foundation, Inc.
Copyright 2004, 2005, 2009, 2010, 2012, 2015 Free Software Foundation, Inc.
Copyright 2000-2003, 2005, 2013 Free Software Foundation, Inc.
Copyright 1999-2002, 2004, 2005, 2008, 2010, 2012, 2015 Free Software Foundation, Inc.
Copyright 2006-2010, 2012, 2014 Free Software Foundation, Inc.
Copyright 2000-2002, 2004 Free Software Foundation, Inc.
Copyright 1991, 1993-1995, 2001, 2002, 2011, 2012 Free Software Foundation, Inc.
Copyright 1998-2010, 2012, 2013 Free Software Foundation, Inc.
Copyright (C) 2000-2002, 2004, 2008, 2012 Free Software Foundation, Inc.
Copyright 1995, 1997-2003, 2005, 2009, 2012, 2015 Free Software Foundation, Inc.
Copyright 2006-2008, 2012 Free Software Foundation, Inc.
Copyright 2007-2009, 2012, 2015 Free Software Foundation, Inc.
Copyright 2008-2011, 2013 Free Software Foundation, Inc.
Copyright 2001, 2003, 2004 Free Software Foundation, Inc.
Copyright 2001-2004 Free Software Foundation, Inc.
Copyright 2001-2003, 2015 Free Software Foundation, Inc.
Copyright 2005, 2006, 2009, 2011, 2012 Free Software Foundation, Inc.
Copyright 2003-2005, 2008, 2012 Free Software Foundation, Inc.
Copyright 1991-1994, 1996, 2000-2002, 2004, 2006-2008, 2011, 2012 Free Software Foundation, Inc.
Copyright 2001, 2009 Free Software Foundation, Inc.
Copyright 2003-2005, 2008, 2009 Free Software Foundation, Inc.
Copyright (C) 1984, 1989-1990, 2000-2013 Free Software Foundation, Inc.
Copyright 2004, 2005, 2009, 2010, 2012 Free Software Foundation, Inc.
Copyright (C) 1984, 1989-1990, 2000-2013 Free Software Foundation, Inc.
Copyright 1999, 2000, 2002, 2005, 2012 Free Software Foundation, Inc.
Copyright 2005-2007, 2009, 2010, 2012 Free Software Foundation, Inc.
Copyright 1997, 1999-2002, 2005, 2008, 2012, 2015 Free Software Foundation, Inc.
Copyright 1991, 1993, 1994, 2000 Free Software Foundation, Inc.
Copyright (C) 2007, 2009, 2010, 2012, 2015 Free Software Foundation, Inc.
Copyright 2007-2012 Free Software Foundation, Inc.
Copyright 1991, 1993, 1994, 1996, 1997, 2000-2002, 2005, 2012 Free Software Foundation, Inc.
Copyright 2001, 2002, 2006, 2012 Free Software Foundation, Inc.
Copyright 1991-1994, 1996, 1997, 2000-2002 Free Software Foundation, Inc.
Copyright 1992-1994, 1996, 2000-2002, 2004, 2012 Free Software Foundation, Inc.
Copyright 1991, 1993-2016 Free Software Foundation, Inc.
Copyright 2002, 2014 Free Software Foundation, Inc.
Copyright 2000-2004, 2006, 2008, 2009 Free Software Foundation, Inc.
Copyright 1999-2002, 2010 Free Software Foundation, Inc.
Copyright 2000-2006, 2008-2011 Free Software Foundation, Inc.
Copyright 1994, 1996, 2001, 2002, 2004 Free Software Foundation, Inc.
Copyright 2006, 2007, 2009, 2014 Free Software Foundation, Inc.
Copyright @copyright{} 2000-2002, 2007, 2008 Free Software Foundation, Inc.
Copyright 1994, 1996, 2000-2002, 2005, 2011, 2012 Free Software Foundation, Inc.
Copyright 1991, 1993-2016 Free Software Foundation, Inc.
Copyright 1991, 1993, 1994, 1996, 1998-2000, 2002, 2003, 2013 Free Software Foundation, Inc.
Copyright 1996, 1999-2001, 2009 Free Software Foundation, Inc.
Copyright 1996, 1998, 2000-2005, 2008, 2009, 2012 Free Software Foundation, Inc.
Copyright 1996, 2001, 2004, 2014 Free Software Foundation, Inc.
Copyright 2001, 2003, 2003, 2005 Free Software Foundation, Inc.
Copyright 1996, 1998, 2000-2004, 2008, 2011 Free Software Foundation, Inc.

Copyright 1996, 1999-2004, 2015 Free Software Foundation, Inc.
Copyright 1992, 1994, 1996, 2000, 2011, 2012 Free Software Foundation, Inc.
Copyright 2004, 2015 Free Software Foundation, Inc.
Copyright 2000, 2001, 2004, 2015 Free Software Foundation, Inc.
Copyright 2005-2007, 2009, 2010, 2013 Free Software Foundation, Inc.
Copyright 1992-1994, 1996, 2000, 2002, 2009 Free Software Foundation, Inc.
Copyright 2004 Free Software Foundation, Inc.
Copyright 1992-1994, 1996, 2000, 2002, 2004 Free Software Foundation, Inc.
Copyright 1996, 2000-2002, 2012 Free Software Foundation, Inc.
Copyright 2007-2009, 2011, 2013 Free Software Foundation, Inc.
Copyright 1996, 1998, 2000-2004, 2008, 2010 Free Software Foundation, Inc.
Copyright 2001, 2014 Free Software Foundation, Inc.
Copyright 2004, 2012 Free Software Foundation, Inc.
Copyright 2008-2010, 2013 Free Software Foundation, Inc.
Copyright 1991, 1993, 1994, 1996, 2000-2002, 2009 Free Software Foundation, Inc.
Copyright 1996, 2000, 2001, 2003 Free Software Foundation, Inc.
Copyright 2001, 2002, 2005, 2009 Free Software Foundation, Inc.
Copyright 2013, 2015 Free Software Foundation, Inc.
Copyright 1996, 2000, 2001, 2008 Free Software Foundation, Inc.
Copyright 2001, 2002, 2011, 2014 Free Software Foundation, Inc.
Copyright 1994, 1996, 2000, 2001, 2009, 2012 Free Software Foundation, Inc.
Copyright 2006-2010 Free Software Foundation, Inc.
Copyright 1996, 1998, 2000-2005, 2008, 2009 Free Software Foundation, Inc.
Copyright 2000-2004, 2013 Free Software Foundation, Inc.
Copyright (C) 2007, 2009, 2010, 2012, 2014-2015 Free Software Foundation, Inc.
Copyright 2000, 2003, 2004, 2006, 2007, 2010 Free Software Foundation, Inc.
Copyright 2000, 2003, 2004, 2006, 2007, 2010, 2013 Free Software Foundation, Inc.
Copyright 1991-1994, 1996, 2000-2002 Free Software Foundation, Inc.
Copyright 1996-2009, 2011-2014 Free Software Foundation, Inc.
Copyright (C) 2004-2007, 2009, 2012 Free Software Foundation, Inc.
Copyright 2000-2003, 2014 Free Software Foundation, Inc.
Copyright 1991, 1993-1998, 2000-2005, 2008, 2010, 2012 Free Software Foundation, Inc.
Copyright 2000, 2001, 2004, 2007 Free Software Foundation, Inc.
Copyright 2003-2005, 2008, 2010, 2011 Free Software Foundation, Inc.
Copyright 2000, 2003, 2010, 2013 Free Software Foundation, Inc.
Copyright (C) 2000, 2002, 2004, 2015 Free Software Foundation, Inc.
Copyright 2006-2010, 2012 Free Software Foundation, Inc.
Copyright 2001, 2002, 2005, 2009, 2014 Free Software Foundation, Inc.
Copyright 2003, 2005 Free Software Foundation, Inc.
Copyright 2005-2007, 2009, 2010 Free Software Foundation, Inc.
Copyright 1996, 1998, 2000-2004, 2008, 2010, 2011 Free Software Foundation, Inc.
Copyright 1991-1994, 1996, 1997, 2000-2005, 2008, 2010, 2011 Free Software Foundation, Inc.
Copyright 2002, 2011 Free Software Foundation, Inc.
Copyright 2011-2014 Free Software Foundation, Inc.
Copyright 2008, 2011, 2012, 2014 Free Software Foundation, Inc.
Copyright 2000-2006, 2008, 2009, 2011, 2012 Free Software Foundation, Inc.
Copyright 1996-2002, 2004, 2006-2008 Free Software Foundation, Inc.
Copyright 2012-2014 Free Software Foundation, Inc.
Copyright 1996, 1998-2001, 2004, 2007, 2009, 2011 Free Software Foundation, Inc.
Copyright 1996-1998, 2000, 2001, 2007, 2009 Free Software Foundation, Inc.
Copyright 1996, 1998, 2000, 2001, 2007 Free Software Foundation, Inc.
Copyright 1996-2004, 2009, 2011 Free Software Foundation, Inc.
Copyright 1996-2004, 2009 Free Software Foundation, Inc.
Copyright 1999-2001, 2004, 2009, 2011 Free Software Foundation, Inc.
Copyright 1991, 1993, 1994, 1996, 2000, 2001, 2009, 2015 Free Software Foundation, Inc.
Copyright 2008-2010, 2014 Free Software Foundation, Inc.
Copyright 2001-2003, 2005 Free Software Foundation, Inc.

Copyright 2007, 2011, 2012, 2014 Free Software Foundation, Inc.
Copyright 1992, 1994, 1996, 1999, 2000, 2002 Free Software Foundation, dnl Inc.
Copyright 1996, 1999-2001, 2003 Free Software Foundation, Inc.
Copyright 1996, 2001, 2002, 2006 Free Software Foundation, Inc.
Copyright 2000, 2002-2004, 2013 Free Software Foundation, Inc.
Copyright 1992, 1994-1996, 1999, 2000, 2002 Free Software Foundation, Inc.
Copyright 2007, 2008, 2013 Free Software Foundation, Inc.
Copyright 1991, 1993, 1994, 1999-2002, 2004, 2005, 2008-2010, 2014 Free Software Foundation, Inc.
Copyright 2000-2002, 2014 Free Software Foundation, Inc.
Copyright 2004, 2005, 2009 Free Software Foundation, Inc.
Copyright 2000, 2003-2005, 2008 Free Software Foundation, Inc.
Copyright 2001, 2002, 2014, 2015 Free Software Foundation, Inc.
Copyright 2002, 2005, 2006 Free Software Foundation, Inc.
Copyright 1991, 1993, 1994, 1999-2002, 2004, 2009, 2010 Free Software Foundation, Inc.
Copyright 2002, 2006 Free Software Foundation, Inc.
Copyright 1996, 1998-2000, 2002 Free Software Foundation, Inc.
Copyright 1992, 1994, 1996, 1999-2002 Free Software Foundation, Inc.
Copyright 1991, 1993, 1994, 2000-2002 Free Software Foundation, Inc.
Copyright 2000, 2001, 2003-2005, 2011 Free Software Foundation, Inc.
Copyright 2000, 2003, 2005 Free Software Foundation, Inc.
Copyright 1992, 1994-1996, 1999-2002 Free Software Foundation, Inc.
Copyright 1994, 1995, 2000, 2009 Free Software Foundation, Inc.
Copyright 2003, 2004, 2011-2013, 2015 Free Software Foundation, Inc.
Copyright 1991, 1993, 1994, 1999-2002, 2004, 2005, 2009 Free Software Foundation, Inc.
Copyright 2003, 2009, 2011 Free Software Foundation, Inc.
Copyright 1994, 1995, 2000, 2003, 2009 Free Software Foundation, Inc.
Copyright 1991, 1993, 1994, 2000-2003, 2011 Free Software Foundation, Inc.
Copyright 1996, 2000-2003, 2007, 2011, 2013 Free Software Foundation, Inc.
Copyright 2003, 2012, 2014 Free Software Foundation, Inc.
Copyright 1997, 2000, 2002 Free Software Foundation, Inc.
Copyright 1995, 1999, 2000, 2005, 2011 Free Software Foundation, Inc.
Copyright 1996, 1999 Free Software Foundation, Inc.
Copyright 1998, 2000, 2001, 2003, 2012 Free Software Foundation, Inc.
Copyright 1999, 2000, 2002, 2005 Free Software Foundation, Inc.
Copyright 2002, 2012, 2015 Free Software Foundation, Inc.
Copyright 2003, 2012, 2013 Free Software Foundation, Inc.
Copyright 2001, 2012, 2013 Free Software Foundation, Inc.
Copyright 1991, 1993, 1994, 2000-2004, 2009, 2010 Free Software Foundation, Inc.
Copyright 2000-2003, 2007 Free Software Foundation, Inc.
Copyright 1997, 2000, 2001, 2012 Free Software Foundation, Inc.
Copyright 2000-2002, 2004, 2014 Free Software Foundation, Inc.
Copyright 1999-2003, 2007, 2010, 2012, 2014 Free Software Foundation, Inc.
Copyright 1996-2002 Free Software Foundation, Inc.
Copyright 1991, 1993, 1994, 2000-2002, 2011 Free Software Foundation, Inc.
Copyright 1992, 1994, 1996, 2000, 2002 Free Software Foundation, Inc.
Copyright 2000-2002 Free Software Foundation, Inc.
Copyright 1995, 2000, 2002 Free Software Foundation, Inc.
Copyright 1991, 1993, 1994, 1999-2002 Free Software Foundation, Inc.
Copyright 1991, 1993, 1994, 1999-2003, 2009, 2010, 2012-2015 Free Software Foundation, Inc.
Copyright 1999, 2002 Free Software Foundation, Inc.
Copyright 1991, 1993, 1994, 1999-2003, 2009, 2010, 2012, 2015 Free Software Foundation, Inc.
Copyright 1992, 1994, 1999-2001 Free Software Foundation, Inc.
Copyright 1992, 1994-1996, 1999-2001, 2005 Free Software Foundation, Inc.
Copyright 1992-1994, 2000 Free Software Foundation, Inc.
Copyright 1998, 2000, 2001, 2003 Free Software Foundation, Inc.
Copyright 2001, 2012 Free Software Foundation, Inc.
Copyright 1991, 1993, 1994, 1999-2002, 2004, 2009-2011, 2014 Free Software Foundation, Inc.

Copyright 2001, 2009, 2011, 2012 Free Software Foundation, Inc.
Copyright 2002, 2004, 2005 Free Software Foundation, Inc.
Copyright 1993, 1994, 1996, 2000 Free Software Foundation, Inc.
Copyright 2000-2004, 2006, 2007 Free Software Foundation, Inc.
Copyright 2000-2005 Free Software Foundation, Inc.
Copyright 1992-1995, 2000 Free Software Foundation, Inc.
Copyright 2002, 2011, 2013 Free Software Foundation, Inc.
Copyright 2003-2005, 2010, 2013 Free Software Foundation, Inc.
Copyright 2000-2005, 2009-2011, 2014, 2015 Free Software Foundation, Inc.
Copyright 2003-2005, 2010 Free Software Foundation, Inc.
Copyright 2003-2005, 2010, 2011 Free Software Foundation, Inc.
Copyright 2004, 2011 Free Software Foundation, Inc.
Copyright 2000, 2002, 2004 Free Software Foundation, Inc.
Copyright 2004, 2005, 2011 Free Software Foundation, Inc.
Copyright 1997, 2000, 2012 Free Software Foundation, Inc.
Copyright 2000-2005, 2010 Free Software Foundation, Inc.
Copyright 1996, 1999-2003 Free Software Foundation, Inc.
Copyright 2002-2005, 2012, 2013, 2015 Free Software Foundation, Inc.
Copyright 1992, 1994, 1996, 1999-2003, 2005 Free Software Foundation, Inc.
Copyright 2000-2005, 2007 Free Software Foundation, Inc.
Copyright 1992, 1994, 1996, 1999-2002, 2011 Free Software Foundation, Inc.
Copyright 1999-2006, 2011 Free Software Foundation, Inc.
Copyright 2004, 2005, 2007-2012, 2014 Free Software Foundation, Inc.
Copyright 1992, 1994, 1996, 2000, 2012 Free Software Foundation, Inc.
Copyright 2003-2005, 2007, 2008, 2012 Free Software Foundation, Inc.
Copyright 2003, 2004, 2006, 2008 Free Software Foundation, Inc.
Copyright 1999-2001, 2012 Free Software Foundation, Inc.
Copyright 2004, 2007-2009, 2011-2013 Free Software Foundation, Inc.
Copyright 2006, 2011, 2012 Free Software Foundation, Inc.
Copyright 1999, 2000, 2012 Free Software Foundation, Inc.
Copyright 2007, 2008, 2010-2012 Free Software Foundation, Inc.
Copyright 2003, 2005-2007, 2011, 2012 Free Software Foundation, Inc.
Copyright 2003, 2005, 2007, 2008, 2012 Free Software Foundation, Inc.
Copyright 1991, 1993, 1994, 2000-2010, 2014 Free Software Foundation, Inc.
Copyright 2000-2002, 2004, 2005, 2007, 2010-2012 Free Software Foundation, dnl Inc.
Copyright 2003, 2005, 2007, 2008, 2010, 2012 Free Software Foundation, dnl Inc.
Copyright 2001, 2002, 2011 Free Software Foundation, Inc.
Copyright 1996, 1999-2016 Free Software Foundation, Inc.
Copyright 2001, 2002, 2004-2006, 2009, 2011, 2012 Free Software dnl Foundation, Inc.
Copyright 2001-2003, 2009 Free Software Foundation, Inc.
Copyright (C) 2004-2015 Free Software Foundation, Inc.
Copyright (C) 2010-2015 Free Software Foundation, Inc.
Copyright 1992-2019 Free Software Foundation, Inc.
Copyright 1996, 1998-2002 Free Software Foundation, Inc.
Copyright 1992-2015 Free Software Foundation, Inc.
Copyright (C) 2007-2015 Free Software Foundation, Inc.
Copyright (C) 2002-2018 Free Software Foundation, Inc.
Copyright (C) 2001-2018 Free Software Foundation, Inc.
Copyright (C) 1997-2018 Free Software Foundation, Inc.
Copyright (C) 1996-2018 Free Software Foundation, Inc.
Copyright (C) 2003-2018 Free Software Foundation, Inc.
Copyright (C) 1998-2018 Free Software Foundation, Inc.
Copyright (C) 1999-2018 Free Software Foundation, Inc.
Copyright (C) 2009-2018 Free Software Foundation, Inc.
Copyright (C) 2006-2018 Free Software Foundation, Inc.
Copyright (C) 2004-2018 Free Software Foundation, Inc.
Copyright (C) 1996-2001, 2003-2015 Free Software Foundation, Inc. Written by Gordon Matzigkeit, 1996

LICENCE TERMS (cont.)

Copyright (C) 2014 Free Software Foundation, Inc.
Copyright (C) 2011 Free Software Foundation, Inc.
Copyright (C) 2004-2005, 2007-2009, 2011-2015 Free Software Foundation, Inc. Written by Gary V. Vaughan, 2004
Copyright (C) 2004-2005, 2007-2008, 2011-2015 Free Software Foundation, Inc. Written by Gary V. Vaughan, 2004
Copyright (C) 2004, 2011-2015 Free Software Foundation, Inc. Written by Scott James Remnant, 2004
Copyright (C) 2004-2005, 2007, 2009, 2011-2015 Free Software Foundation, Inc. Written by Scott James Remnant, 2004.
Copyright (C) 1992-1996, 1998-2012 Free Software Foundation, Inc.
Copyright (C) 2012 Free Software Foundation, Inc.
Copyright 1996-2016 Free Software Foundation, Inc.
Copyright (C) 2012 Free Software Foundation, Inc. This config.status script is free software
Copyright 1991, 1993, 1994, 1996, 1997, 1999-2004, 2006-2009, 2011-2016 Free Software Foundation, Inc.
Copyright 2001, 2002, 2010 Free Software Foundation, Inc.
Copyright 1996, 1998-2003, 2012 Free Software Foundation, Inc.
Copyright 1996-2016 Free Software Foundation, Inc.
Copyright 2000-2003, 2005-2011 Free Software Foundation, Inc.
Copyright 1996, 1998-2002, 2005, 2011, 2013 Free Software Foundation, Inc.
Copyright 2001-2003, 2012 Free Software Foundation, Inc.
Copyright 2001-2004 Free Software Foundation, Inc.
Copyright 2001-2004 Free Software Foundation, Inc.
Copyright 2000-2002 Free Software Foundation, Inc.
Copyright 2000-2004 Free Software Foundation, Inc.
Copyright 2000-2002, 2012 Free Software Foundation, Inc.
Copyright 1991, 1993-2016 Free Software Foundation, Inc.
Copyright 1991, 1993-2016 Free Software Foundation, Inc.
Copyright © 2000-2002, 2007, 2008 Free Software Foundation, Inc.
Copyright © 2000-2002, 2007, 2008 Free Software Foundation, Inc.
Copyright 2003 Free Software Foundation, Inc.
Copyright 1996, 1999-2004, 2015 Free Software Foundation, Inc.
Copyright 2001, 2002 Free Software Foundation, Inc.
Copyright 2000-2004, 2013 Free Software Foundation, Inc.
Copyright 2000-2003 Free Software Foundation, Inc.
Copyright 1996, 1997, 1999-2003, 2009, 2012 Free Software Foundation, Inc.
Copyright 1996, 1999-2002, 2012, 2015 Free Software Foundation, Inc.
Copyright 2001-2003, 2009-2014 Free Software Foundation, Inc.
Copyright 1996, 1998, 2000-2002 Free Software Foundation, Inc.
Copyright (C) 1994 X Consortium

Copyright (C) 1999-2018 Free Software Foundation, Inc. Written by Tom Tromey <tromey@cygnus.com>.
Copyright 1992-2019 Free Software Foundation, Inc.
Copyright (C) 1999-2018 Free Software Foundation, Inc.
Copyright (C) 2004-2005, 2007, 2009, 2011-2015 Free Software Foundation, Inc. Written by Scott James Remnant, 2004.
Copyright (C) 2004, 2011-2015 Free Software Foundation, Inc. Written by Scott James Remnant, 2004
Copyright (C) 1996-2001, 2003-2015 Free Software Foundation, Inc. Written by Gordon Matzigeit, 1996
Copyright (C) 2004-2005, 2007-2008, 2011-2015 Free Software Foundation, Inc. Written by Gary V. Vaughan, 2004
Copyright (C) 2004-2005, 2007-2009, 2011-2015 Free Software Foundation, Inc. Written by Gary V. Vaughan, 2004
Copyright (C) 1996-2018 Free Software Foundation, Inc. Originally written by Fran.cois Pinard <pinard@iro.umontreal.ca>, 1996.
Copyright (C) 2011-2018 Free Software Foundation, Inc.
Copyright (C) 1995-1997, 2000-2007, 2009-2010 by Ulrich Drepper <drepper@gnu.ai.mit.edu>
Copyright 1996-2016 Free Software Foundation, Inc.
Copyright (C) 1994-1996, 1999-2002, 2004-2016 Free Software Foundation, Inc.
Copyright (c) 2012, 2016 Philip Withnall
Copyright (c) 2009 Tom Howard <tomhoward@users.sf.net>
Copyright (c) 2009 Allan Caffee <allan.caffee@gmail.com>
Copyright (c) 2008 Tom Howard <tomhoward@users.sf.net>

Copyright (C) 2010-2018 Free Software Foundation, Inc. Written by Peter Rosin <peda@lysator.liu.se>.
Copyright (C) 1991, 1999 Free Software Foundation, Inc.
Copyright (C) 2003 James Henstridge 2007-2017 Stefan Sauer
Copyright (C) 1996-2018 Free Software Foundation, Inc.
Copyright 1985, 1986, 1988, 1990, 1991, 1992, 1993, 1994, 1995, 1996, 1997, 1998, 1999, 2000, 2001, 2002, 2003, 2004, 2005, 2006, 2007, 2008, 2009, 2010, 2011, 2012, 2013, 2014, 2015, 2016, 2017, 2018 Free Software Foundation, Inc.
Copyright (C) 1995-2018 Free Software Foundation, Inc. written by Ulrich Drepper <drepper@gnu.ai.mit.edu>, June 1995
Copyright (C) 2000-2012 Free Software Foundation, Inc.
Copyright (C) 1996-2018 Free Software Foundation, Inc.
Copyright (C) 2002-2012 Free Software Foundation, Inc.
Copyright (C) 1994-2018 Free Software Foundation, Inc.
Copyright (C) 2004-2012 Free Software Foundation, Inc.
Copyright (C) 2001-2020 Free Software Foundation, Inc.
Copyright (C) 1992-1996, 1998-2012 Free Software Foundation, Inc.
Copyright (C) 1991, 1993, 1996-1997, 1999-2000, 2003-2004, 2006, 2008-2020 Free Software Foundation, Inc.
Copyright (C) 2017-2020 Free Software Foundation, Inc.
Copyright 2011-2020 Free Software Foundation, Inc.
Copyright (C) 1999, 2002, 2006-2007, 2009-2020 Free Software Foundation, Inc.
Copyright (C) 1999, 2002-2020 Free Software Foundation, Inc.
Copyright (C) 2003-2020 Free Software Foundation, Inc.
Copyright (C) 2011-2020 Free Software Foundation, Inc.
Copyright @copyright{} 2001-2012, 2014, 2016, 2019 Free Software Foundation, Inc.
Copyright (C) 1998-1999, 2005-2006, 2009-2020 Free Software Foundation, Inc.
Copyright (C) 2005-2007, 2009-2020 Free Software Foundation, Inc.
Copyright (C) 2007-2020 Free Software Foundation, Inc.
Copyright (C) 1990-2000, 2003-2004, 2006-2020 Free Software Foundation, Inc.
Copyright (C) 2005-2006, 2009-2020 Free Software Foundation, Inc. Written by Simon Josefsson.
Copyright (C) 2004, 2006-2020 Free Software Foundation, Inc. Written by Simon Josefsson and Yoann Vandoorselaere <yoann@prelude-ids.org>.
Copyright (C) 1997-2020 Free Software Foundation, Inc.
Copyright (C) 2005-2020 Free Software Foundation, Inc.
Copyright (C) 2002-2004, 2007-2020 Free Software Foundation, Inc.
Copyright (C) 1995, 2001-2004, 2006-2020 Free Software Foundation, Inc.
Copyright (C) 1998-1999, 2001, 2003, 2009-2020 Free Software Foundation, Inc. Written by Jim Meyering <meyering@ascend.com>, 1998.
Copyright (C) 2002-2020 Free Software Foundation, Inc.
Copyright (C) 2007, 2009-2020 Free Software Foundation, Inc. Written by Bruno Haible <bruno@clisp.org>, 2007.
Copyright (C) 2001-2020 Free Software Foundation, Inc. Copyright (C) 2001-2020 Nikos Mavrogiannopoulos
Copyright (C) 2007, 2009-2020 Free Software Foundation, Inc.
Copyright (C) 1998-2004, 2006-2007, 2009-2020 Free Software Foundation, Inc.
Copyright (C) 2009-2020 Free Software Foundation, Inc.
Copyright 2016-2020 Free Software Foundation, Inc.
Copyright (C) 2011-2020 Free Software Foundation, Inc. Written by Bruno Haible <bruno@clisp.org>, 2011.
Copyright (C) 1991-1994, 1996-1998, 2000, 2004, 2007-2020 Free Software Foundation, Inc.
Copyright @copyright{} 2000, 2001, 2002, 2007, 2008 Free Software Foundation, Inc.
Copyright (C) 2005-2006, 2009-2020 Free Software Foundation, Inc.
Copyright (C) 2008-2012 Free Software Foundation, Inc.
Copyright (C) 2001-2020 Free Software Foundation, Inc.
Copyright (C) 2005-2006, 2008-2020 Free Software Foundation, Inc.
Copyright (C) 1992-2020 Free Software Foundation, Inc.
Copyright (C) 2008-2020 Free Software Foundation, Inc.
Copyright (C) 1995-1996, 2001-2020 Free Software Foundation, Inc.
Copyright (C) 2006, 2009-2020 Free Software Foundation, Inc. Written by Simon Josefsson.
Copyright (C) 2007-2008, 2010-2020 Free Software Foundation, Inc.
Copyright (C) 2005-2007, 2009-2020 Free Software Foundation, Inc. Written by Simon Josefsson.

LICENCE TERMS (cont.)

Copyright (C) 1999-2000, 2002-2003, 2006-2020 Free Software Foundation, Inc.
Copyright (C) 2003, 2006-2007, 2010-2020 Free Software Foundation, Inc.
Copyright (C) 2005-2006, 2008-2020 Free Software Foundation, Inc.
Copyright (C) 2004, 2006-2020 Free Software Foundation, Inc. Written by Simon Josefsson and Paul Eggert.
Copyright (C) 2005-2012 Free Software Foundation, Inc.
Copyright (C) 1999, 2002-2003, 2005, 2007, 2010-2020 Free Software Foundation, Inc.
Copyright (C) 2001-2003, 2006-2020 Free Software Foundation, Inc. Written by Bruno Haible <haible@clisp.cons.org>, 2001.
Copyright (c) 2016 Wrymouth Innovation Ltd
Copyright (C) 1995, 1999, 2001-2004, 2006-2020 Free Software Foundation, Inc.
Copyright (C) 2001-2003, 2005-2007, 2009-2020 Free Software Foundation, Inc.
Copyright (C) 1991, 1996-1998, 2002-2004, 2006-2007, 2009-2020 Free Software Foundation, Inc.
Copyright (C) 2011-2012 Free Software Foundation, Inc.
Copyright (C) 2001-2012 Free Software Foundation, Inc.
Copyright (C) 1995-1996, 2001, 2003, 2005, 2009-2020 Free Software Foundation, Inc.
Copyright (C) 2004, 2007-2020 Free Software Foundation, Inc.
Copyright (C) 2011-2012 Free Software Foundation, Inc.
Copyright (C) 1999, 2002-2003, 2005-2007, 2009-2020 Free Software Foundation, Inc.
Copyright (C) 2006, 2008-2020 Free Software Foundation, Inc.
Copyright (C) 2004-2012 Free Software Foundation, Inc.
Copyright (C) 1995-1998, 2000-2002, 2004-2006, 2009-2020 Free Software Foundation, Inc.
Copyright (C) 2012 Free Software Foundation, Inc.
Copyright (C) 2005, 2007, 2009-2020 Free Software Foundation, Inc.
Copyright (c) 2002, 2003, 2004, 2005, 2006, 2007, 2008, 2009 Simon Josefsson added -texinfo
Copyright (C) 2012-2020 Free Software Foundation, Inc.
Copyright (C) 2006, 2009-2020 Free Software Foundation, Inc. Written by Simon Josefsson and Bruno Haible.
Copyright (C) 2010-2020 Free Software Foundation, Inc.
Copyright (C) 1999, 2002-2003, 2006-2007, 2011-2020 Free Software Foundation, Inc.
Copyright (C) 2008-2020 Free Software Foundation, Inc. Written by Simon Josefsson.
Copyright (C) 1994, 1996-1998, 2001, 2003, 2005-2020 Free Software Foundation, Inc.
Copyright (C) 1997-1998, 2006-2007, 2009-2020 Free Software Foundation, Inc.
Copyright (C) 1996-1998, 2001-2003, 2005-2007, 2009-2020 Free Software Foundation, Inc.
Copyright (C) 2001-2020 Free Software Foundation, Inc. Copyright (C) 2001-2020 Nikos Mavrogiannopoulos
Copyright (C) 2005, 2007, 2009-2020 Free Software Foundation, Inc. Written by Oskar Liljeblad <oskar@osk.mine.nu>, 2005.
Copyright (C) 2007-2012 Free Software Foundation, Inc.
Copyright (C) 2005-2020 Free Software Foundation, Inc. Written by Simon Josefsson.
Copyright (C) 1994-2018 Free Software Foundation, Inc.
Copyright (C) 1992, 1999, 2001, 2003, 2005, 2009-2020 Free Software Foundation, Inc.
Copyright (C) 2001-2002, 2004-2020 Free Software Foundation, Inc. Written by Paul Eggert, Bruno Haible, Sam Steingold, Peter Burwood.
Copyright 2017-2020 Free Software Foundation, Inc.
Copyright (C) 1995, 1998, 2001, 2003, 2005, 2009-2020 Free Software Foundation, Inc.
Copyright (C) 1999, 2002, 2006-2020 Free Software Foundation, Inc.
Copyright (C) 2003, 2008-2020 Free Software Foundation, Inc.
Copyright (C) 1999-2000, 2002, 2004-2020 Free Software Foundation, Inc.
Copyright (C) 1992, 1995-2002, 2005-2020 Free Software Foundation, Inc.
Copyright (C) 2003, 2006-2007, 2009-2020 Free Software Foundation, Inc. Written by Bruno Haible <bruno@clisp.org>, 2003, 2018.
Copyright (C) 1992, 1995-2003, 2005-2020 Free Software Foundation, Inc.
Copyright (C) 2006-2007, 2009-2020 Free Software Foundation, Inc.
Copyright (C) 2004, 2009-2020 Free Software Foundation, Inc.
Copyright 2009-2020 Free Software Foundation, Inc.
Copyright (C) 2006-2020 Free Software Foundation, Inc.
Copyright (C) 2018-2020 Free Software Foundation, Inc.
Copyright (C) 2000-2001, 2004-2006, 2009-2020 Free Software Foundation, Inc.
Copyright (C) 2001, 2003, 2006, 2009-2020 Free Software Foundation, Inc.
Copyright (C) 2008-2020 Free Software Foundation, Inc. Written by Bruno Haible <bruno@clisp.org>, 2008.
Copyright (C) 2019-2020 Free Software Foundation, Inc.
Copyright (C) 2005, 2007, 2009-2020 Free Software Foundation, Inc. Written by Jim Meyering.
Copyright (C) 2001, 2003, 2005, 2008-2020 Free Software Foundation, Inc.
Copyright (C) 2009-2020 Free Software Foundation, Inc.
Copyright (C) 2008-2020 Free Software Foundation, Inc. Written by Eric Blake <ebb9@byu.net>, 2008.
Copyright (C) 2006, 2009-2020 Free Software Foundation, Inc.
Copyright (C) 2007-2020 Free Software Foundation, Inc. Written by Bruno Haible <bruno@clisp.org>, 2007.
Copyright (C) 2003-2007, 2009-2020 Free Software Foundation, Inc. Written by Bruno Haible <bruno@clisp.org>, 2003.
Copyright (C) 2009-2020 Free Software Foundation, Inc. Written by Jim Meyering
Copyright (C) 2005, 2007-2020 Free Software Foundation, Inc.
Copyright (C) 2002-2007, 2009-2020 Free Software Foundation, Inc.
Copyright (C) 2001, 2003, 2009-2020 Free Software Foundation, Inc.
Copyright (C) 2002-2003, 2005-2006, 2009-2020 Free Software Foundation, Inc.
Copyright (C) 2009, 2011-2020 Free Software Foundation, Inc.
Copyright (C) 2011-2020 Free Software Foundation, Inc.
Copyright 2008-2020 Free Software Foundation, Inc.
Copyright (C) 2008-2020 Free Software Foundation, Inc. Written by Bruno Haible and Simon Josefsson.
Copyright (C) 1992-2020 Free Software Foundation, Inc.
Copyright (C) 2001, 2006, 2008-2020 Free Software Foundation, Inc.
Copyright (C) 1995-2020 Free Software Foundation, Inc.
Copyright (C) 2008-2020 Free Software Foundation, Inc.
Copyright (C) 2001-2004, 2007-2020 Free Software Foundation, Inc.
Copyright (C) 2009-2020 Free Software Foundation, Inc. Written by Bruno Haible <bruno@clisp.org>, 2009.
Copyright (C) 2008-2020 Free Software Foundation, Inc. Written by Eric Blake and Bruno Haible
Copyright (C) 1991, 1994, 1997-1998, 2000, 2003-2020 Free Software Foundation, Inc.
Copyright (C) 2003-2012 Free Software Foundation, Inc.
Copyright (C) 2005, 2009-2020 Free Software Foundation, Inc.
Copyright (C) 1991, 2004-2006, 2009-2020 Free Software Foundation, Inc.
Copyright (C) 1997-2006, 2008-2020 Free Software Foundation, Inc.
Copyright (C) 2001-2006, 2009-2020 Free Software Foundation, Inc.
Copyright (C) 1999, 2004-2007, 2009-2020 Free Software Foundation, Inc.
Copyright (C) 2006-2007, 2010-2020 Free Software Foundation, Inc. Written by Simon Josefsson
Copyright (C) 2006-2020 Free Software Foundation, Inc. Written by Bruno Haible <bruno@clisp.org>, 2006.
Copyright 2013-2020 Free Software Foundation, Inc.
Copyright (C) 2006-2020 Free Software Foundation, Inc. Written by Paul Eggert, Bruno Haible, Derek Price.
Copyright (C) 1999, 2002, 2006, 2009-2020 Free Software Foundation, Inc.
Copyright (C) 1991, 1996-1999, 2001, 2004, 2007, 2009-2020 Free Software Foundation, Inc.
Copyright (C) 2000-2003, 2006, 2008-2020 Free Software Foundation, Inc.
Copyright (C) 2008-2020 Free Software Foundation, Inc. Written by Eric Blake <ebb9@byu.net>, 2008.
Copyright (C) 1998-1999, 2005-2007, 2009-2020 Free Software Foundation, Inc.
Copyright (C) 1997, 2003-2004, 2006-2007, 2009-2020 Free Software Foundation, Inc.
Copyright (C) 2003 James Henstridge 2004-2007 Damon Chaplin 2007-2017 Stefan Sauer
Copyright (C) 2007-2020 Free Software Foundation, Inc.
Copyright 2003-2020 Free Software Foundation, Inc.
Copyright 1996-2020 Free Software Foundation, Inc. Taken from GNU libtool, 2001 Originally by Gordon Matzigkeit <gord@gnu.ai.mit.edu>, 1996
Copyright (C) 2006-2020 Free Software Foundation, Inc.
Copyright (C) 2006-2012 Free Software Foundation, Inc.
Copyright (C) 2003, 2005-2020 Free Software Foundation, Inc.
Copyright (C) 2001-2002, 2006-2020 Free Software Foundation, Inc.
Copyright (C) 2002-2004, 2006-2007, 2009-2020 Free Software Foundation, Inc. dnl Inc.
Copyright (C) 2001, 2003-2007, 2009-2020 Free Software Foundation, Inc.
Copyright (C) 2006-2007, 2009-2020 Free Software Foundation, Inc.
Copyright (C) 2002-2003, 2005-2020 Free Software Foundation, Inc.
Copyright (C) 2006-2020 Free Software Foundation, Inc.

LICENCE TERMS (cont.)

Copyright (C) 2007, 2009-2020 Free Software Foundation, Inc.
Copyright (C) 2010-2020 Free Software Foundation, Inc.
Copyright (C) 2003-2004, 2006-2007, 2009-2020 Free Software Foundation, dnl Inc.
Copyright (C) 2005, 2007, 2009-2020 Free Software Foundation, Inc.
Copyright (C) 2009-2020 Free Software Foundation, Inc.
Copyright (C) 2002-2020 Free Software Foundation, Inc.
Copyright (C) 2005-2020 Free Software Foundation, Inc.
Copyright (C) 2002, 2007-2020 Free Software Foundation, Inc.
Copyright (C) 2002-2006, 2009-2020 Free Software Foundation, Inc.
Copyright (C) 1997-2001, 2003-2020 Free Software Foundation, Inc.
Copyright 1992-1996, 1998-2020 Free Software Foundation, Inc.
Copyright (C) 2011-2020 Free Software Foundation, Inc.
Copyright (C) 2002-2004, 2006-2020 Free Software Foundation, Inc.
Copyright © 2004 Scott James Remnant <scott@netsplit.com>.
Copyright (C) 2003, 2007-2020 Free Software Foundation, Inc.
Copyright (C) 2005-2007, 2009-2020 Free Software Foundation, Inc.
Copyright (C) 2002-2003, 2008-2020 Free Software Foundation, Inc.
Copyright 2016-2020 Free Software Foundation, Inc.
Copyright (C) 1997-2004, 2006, 2008-2020 Free Software Foundation, Inc.
Copyright (C) 2007-2020 Free Software Foundation, Inc.
Copyright (C) 1997-2002, 2006, 2008-2020 Free Software Foundation, Inc.
Copyright (C) 2020 Free Software Foundation, Inc.
Copyright (C) 2006, 2009-2020 Free Software Foundation, Inc.
Copyright (C) 2000-2001, 2003-2007, 2009-2020 Free Software Foundation, Inc.
Copyright (C) 2002, 2005-2020 Free Software Foundation, Inc.
Copyright (C) 2017-2020 Free Software Foundation, Inc.
Copyright (C) 2005, 2008, 2010-2020 Free Software Foundation, Inc.
Copyright (C) 1998,2001, 2006, 2010, 2012, 2013, 2014 Free Software Foundation, Inc.
Copyright (C) 2001-2003, 2006, 2010-2020 Free Software Foundation, Inc.
Copyright (C) 2004-2014, 2016, 2019-2020 Free Software Foundation, Inc.
Copyright (C) 1999-2001, 2003-2020 Free Software Foundation, Inc.
Copyright (C) 2012-2020 Free Software Foundation, Inc.
Copyright (C) 2003-2004, 2008-2020 Free Software Foundation, Inc.
Copyright (C) 2003, 2006-2020 Free Software Foundation, Inc.
Copyright (C) 2002-2004, 2007-2020 Free Software Foundation, Inc.
Copyright 2013-2020 Free Software Foundation, Inc.
Copyright (C) 2019-2020 Free Software Foundation, Inc.
Copyright (C) 2002-2003, 2005-2007, 2009-2020 Free Software Foundation, dnl Inc.
Copyright (C) 1998-1999, 2001, 2003, 2005-2007, 2009-2020 Free Software Foundation, Inc.
Copyright (C) 2004, 2006, 2008-2020 Free Software Foundation, Inc.
Copyright (C) 2001-2020 Free Software Foundation, Inc.
Copyright (C) 2000-2001, 2003-2007, 2009-2020 Free Software Foundation, Inc.
Copyright (C) 1997-2004, 2006-2007, 2009-2020 Free Software Foundation, dnl Inc.
Copyright (C) 2001-2003, 2005, 2007, 2009-2020 Free Software Foundation, Inc.
Copyright (C) 2002, 2005, 2007, 2009-2020 Free Software Foundation, Inc.
Copyright (c) 2008 John Darrington <j.darrington@elvis.murdoch.edu.au>
Copyright (C) 2003, 2009-2020 Free Software Foundation, Inc.
Copyright (C) 2000-2002, 2006, 2008-2014, 2016, 2019-2020 Free Software dnl Foundation, Inc.
Copyright (C) 2006, 2008-2020 Free Software Foundation, Inc.
Copyright (C) 2002-2004, 2009-2020 Free Software Foundation, Inc.
Copyright (C) 2002-2003, 2005-2006, 2009-2020 Free Software Foundation, dnl Inc.
Copyright (C) 2004, 2006, 2009-2020 Free Software Foundation, Inc.
Copyright (C) 2001-2004, 2006-2020 Free Software Foundation, Inc.
Copyright 2011-2020 Free Software Foundation, Inc.
Copyright (C) 2005-2007, 2009-2020 Free Software Foundation, Inc. dnl
Copyright (C) 2015-2020 Free Software Foundation, Inc.
Copyright (C) 2007-2008, 2010-2020 Free Software Foundation, Inc.

Copyright (C) 2005-2006, 2008-2020 Free Software Foundation, Inc.
Copyright 2012-2020 Free Software Foundation, Inc.
Copyright (C) 2002-2003, 2006-2007, 2009-2020 Free Software Foundation, dnl Inc.
Copyright (C) 2003, 2005-2006, 2008-2020 Free Software Foundation, Inc.
Copyright (C) 2004-2006, 2009-2020 Free Software Foundation, Inc.
Copyright (C) 2005, 2009-2020 Free Software Foundation, Inc.
Copyright (C) 1995-2002, 2004-2005, 2008-2014, 2016, 2019-2020 Free dnl Software Foundation, Inc.
Copyright 2017-2020 Free Software Foundation, Inc.
Copyright (C) 2002, 2004-2005, 2007, 2009-2020 Free Software Foundation, dnl Inc.
Copyright (C) 1998-2003, 2005-2007, 2009-2020 Free Software Foundation, dnl Inc.
Copyright (C) 2008-2012 Free Software Foundation, Inc.
Copyright (C) 2000-2016 Free Software Foundation, Inc.
Copyright (C) 2002-2014 Free Software Foundation, Inc.
Copyright (C) 2002-2010, 2012 Free Software Foundation, Inc.
Copyright (C) 2000-2014 Free Software Foundation, Inc.
Copyright (C) 2000-2016 Free Software Foundation, Inc.
Copyright (C) 2002-2016 Free Software Foundation, Inc.
Copyright (C) 2010-2016 Free Software Foundation, Inc.
Copyright (C) 2001-2012 Free Software Foundation, Inc.
Copyright (C) 2002-2016 Free Software Foundation, Inc.
Copyright (C) 2010-2012 Free Software Foundation, Inc.
Copyright (C) 2009-2012 Free Software Foundation, Inc.
Copyright (C) 2013 Red Hat
Copyright (C) 2010-2014 Free Software Foundation, Inc.
Copyright (C) 2017-2018 Red Hat, Inc.
Copyright (c) 2009, Ben Hoyt All rights reserved.
Copyright (C) 2014 Red Hat
Copyright (C) 2017 Red Hat, Inc.
Copyright (C) 2004-2015 Free Software Foundation, Inc.
Copyright (C) 2009-2013 Free Software Foundation, Inc.
Copyright (C) 2016 Red Hat, Inc.
Copyright (C) 2002-2012 Free Software Foundation, Inc.
Copyright (C) 2015-2016 Red Hat, Inc.
Copyright (C) 2001-2016 Free Software Foundation, Inc.
Copyright (C) 2000-2012 Free Software Foundation, Inc.
Copyright © 2012 Free Software Foundation.
Copyright (C) 2009-2012 Free Software Foundation, Inc.
Copyright (C) 2011-2019 Free Software Foundation, Inc.
Copyright (C) 2017-2019 Red Hat, Inc.
Copyright (C) 2018 Red Hat, Inc.
Copyright (C) 2002, 2006-2007, 2009-2020 Free Software Foundation, Inc. Written by Bruno Haible <bruno@clisp.org>, 2002.
Copyright (C) 2001-2002, 2006-2007, 2009-2020 Free Software Foundation, Inc. Written by Bruno Haible <bruno@clisp.org>, 2001.
Copyright (C) 2002, 2005-2006, 2009-2020 Free Software Foundation, Inc. Written by Bruno Haible <bruno@clisp.org>, 2002.
Copyright (C) 1999-2002, 2006-2007, 2009-2020 Free Software Foundation, Inc. Written by Bruno Haible <bruno@clisp.org>, 2001.
Copyright (C) 1999, 2002, 2006, 2009-2020 Free Software Foundation, Inc. Written by Bruno Haible <bruno@clisp.org>, 2002.
Copyright (C) 2002, 2006, 2009-2020 Free Software Foundation, Inc. Written by Bruno Haible <bruno@clisp.org>, 2002.
Copyright (C) 2001-2002, 2005-2020 Free Software Foundation, Inc.
Copyright (C) 2002, 2005-2006, 2009-2020 Free Software Foundation, Inc.
Copyright (C) 2002, 2006-2007, 2011-2020 Free Software Foundation, Inc. Written by Bruno Haible <bruno@clisp.org>, 2002.
Copyright (C) 2002, 2006-2007, 2011-2020 Free Software Foundation, Inc. Written by Bruno Haible <bruno@clisp.org>, 2002.

LICENCE TERMS (cont.)

org>, 2011.
Copyright (C) 2000-2002, 2005-2007, 2009-2020 Free Software Foundation, Inc. Written by Bruno Haible <bruno@clisp.org>, 2000-2002.
Copyright (C) 2002, 2005-2020 Free Software Foundation, Inc.
Copyright (C) 2009 Free Software Foundation, Inc.
Copyright (C) 2002, 2006, 2009, 2011-2020 Free Software Foundation, Inc. Written by Bruno Haible <bruno@clisp.org>, 2009.
Copyright (C) 2001-2003, 2009-2020 Free Software Foundation, Inc. Written by Bruno Haible <bruno@clisp.org>, 2009.
Copyright (C) 2001-2002, 2009-2020 Free Software Foundation, Inc. Written by Bruno Haible <bruno@clisp.org>, 2009.
Copyright (C) 2019 Red Hat, Inc.
Copyright (C) 2013, 2014 Red Hat
Copyright (C) 2013 Niels Möller
Copyright (C) 2002 Niels Möller
Copyright (C) 2013-2018 Red Hat
Copyright (C) 2013 Red Hat
Copyright (C) 2017 Red Hat
Copyright (C) 2015 Dmitry Eremin-Solenikov
Copyright (C) 2012 Nikos Mavrogiannopoulos, Niels Möller
Copyright (C) 2016 Dmitry Eremin-Solenikov
Copyright: 2015, 2016 Dmitry Eremin-Solenikov <dbaryshkov@gmail.com>
Copyright (C) 2015 Dmitry Eremin-Solenikov
Copyright (C) 2013-2015 Dmitry Eremin-Solenikov
Copyright (C) 2002, 2014 Niels Möller
Copyright: 2015-2015 Dmitry Eremin-Solenikov <dbaryshkov@gmail.com>
Copyright (C) 2001 Niels Möller
Copyright (C) 2010 Niels Möller
Copyright (C) 2013 Niels Möller
Copyright (C) 2013, 2014 Niels Möller
Copyright (C) 2012 Nikos Mavrogiannopoulos, Niels Möller
Copyright (C) 2015 Dmitry Eremin-Solenikov
Copyright (C) 2001, 2002 Niels Möller
Copyright (C) 2018 Dmitry Eremin-Solenikov
Copyright: 2009-2012 Aleksey Kravchenko <rhash.admin@gmail.com>
Copyright (C) 2013 Joachim Strömbergson
Copyright (C) 2014, 2015 Niels Möller
Copyright (C) 2014 Niels Möller
Copyright (C) 2014 Niels Möller
Copyright (C) 2015, 2017 Dmitry Eremin-Solenikov
Copyright (C) Stefan Metzmacher 2012
Copyright (C) 2013-2017 Red Hat
Copyright (C) 2014, 2019 Niels Möller
Copyright (C) 2012 Niels Möller
Copyright (C) 2019 Niels Möller
Copyright (C) 2017 Daiki Ueno
Copyright (C) 2015 Niels Möller
Copyright (C) 2013, 2014, 2017 Niels Möller
Copyright (C) 2010-2012 Free Software Foundation, Inc.
Copyright (C) 2015 Red Hat, Inc.
Copyright (c) 2000, 2001 Markus Friedl. All rights reserved.
Copyright (C) 2001-2015 Free Software Foundation, Inc.
Copyright (C) 2007-2016 Free Software Foundation, Inc.
Copyright (C) 2003-2016 Free Software Foundation, Inc.
Copyright (C) 2003-2012 Free Software Foundation, Inc.
Copyright (C) 2014-2016 Free Software Foundation, Inc.
Copyright (C) 2015-2016 Nikos Mavrogiannopoulos

Copyright (C) 2003-2014 Free Software Foundation, Inc.
Copyright (C) 2014-2016 Free Software Foundation
Copyright (C) 2003-2014 Free Software Foundation, Inc.
Copyright (C) 2012-2014 Free Software Foundation, Inc.
Copyright (C) 2016 Red Hat
Copyright (C) 2003-2016 Free Software Foundation, Inc.
Copyright (C) 2011-2012 Free Software Foundation, Inc. Author: Simon Josefsson
Copyright (C) 2003-2015 Free Software Foundation, Inc.
Copyright (C) 2013-2016 Nikos Mavrogiannopoulos
Copyright (C) 2003-2018 Free Software Foundation, Inc.
Copyright (C) 2011-2016 Free Software Foundation, Inc.
Copyright (C) 2015 Nikos Mavrogiannopoulos
Copyright (C) 2017 Tim Rühse
Copyright (C) 2018 Free Software Foundation, Inc.
Copyright (C) 2017 - 2018 ARPA2 project
Copyright (C) 2001-2018 Free Software Foundation, Inc.
Copyright (C) 2000-2013 Free Software Foundation, Inc.
Copyright © 2014 Red Hat, Inc.
Copyright (C) 2002-2015 Free Software Foundation, Inc.
Copyright © 2014 Nikos Mavrogiannopoulos
Copyright (C) 2016 Free Software Foundation, Inc.
Copyright © 2014-2016 Red Hat, Inc.
Copyright (C) 2017-2018 Free Software Foundation, Inc.
Copyright (C) 2017 Free Software Foundation, Inc.
Copyright (C) 2001-2014 Free Software Foundation, Inc.
Copyright (C) 2000-2018 Free Software Foundation, Inc.
Copyright (C) 2005-2015 Free Software Foundation, Inc.
Copyright (C) 2014 Red Hat, Inc.
Copyright (C) 2014 Free Software Foundation, Inc.
Copyright (C) 2006-2012 Free Software Foundation, Inc.
Copyright (C) 2016, 2017 Red Hat, Inc.
Copyright (C) 2010-2014 Free Software Foundation, Inc.
Copyright (C) 2005-2012 Free Software Foundation, Inc.
Copyright (C) 2000, 2001, 2002, 2003, 2004, 2005, 2007, 2009, 2010 Free Software Foundation, Inc.
Copyright (C) 2000, 2001, 2002, 2003, 2004, 2005, 2007, 2008, 2010 Free Software Foundation, Inc.
Copyright (c) 2011-2016, Andy Polyakov <appro@openssl.org> All rights reserved.
Copyright (C) 2008-2016 Free Software Foundation, Inc.
Copyright (C) 2014-2016 Red Hat, Inc.
Copyright (C) 2009-2010, 2012 Free Software Foundation, Inc.
Copyright (c) 2011-2013, Andy Polyakov <appro@openssl.org> All rights reserved.
Copyright (C) 2008, 2010-2012 Free Software Foundation, Inc.
Copyright (C) 2011-2018 Free Software Foundation, Inc.
Copyright (c) 2006-2012, CRYPTOGAMS by <appro@openssl.org> All rights reserved.
Copyright (C) 2014-2015 Red Hat, Inc.
Copyright (C) 2012-2017 Free Software Foundation, Inc.
Copyright (C) 2017 Nikos Mavrogiannopoulos
Copyright (C) 2012 INRIA Paris-Rocquencourt
Copyright (C) 2013-2018 Nikos Mavrogiannopoulos
Copyright (C) 2012,2013 Free Software Foundation, Inc.
Copyright (C) 2016 - 2018 ARPA2 project
Copyright (C) 2012 Free Software Foundation, Inc.
Copyright (C) 2013 Nikos Mavrogiannopoulos
Copyright (C) 2018 ARPA2 project
Copyright (C) 2012 Free Software Foundation
Copyright (C) 2013 Nikos Mavrogiannopoulos
Copyright (C) 2009-2018 Free Software Foundation, Inc.
Copyright (C) 2014-2017 Red Hat, Inc.

LICENCE TERMS (cont.)

Copyright 2006-2012 Free Software Foundation, Inc.
Copyright (C) 2016-2018 Red Hat, Inc.
copyrights for 2020
Copyright (C) 2010-2016 Free Software Foundation, Inc.
Copyright (C) 2006-2016 Free Software Foundation, Inc.
Copyright (C) 2014 Nikos Mavrogiannopoulos
Copyright (C) 2015 Nikos Mavrogiannopoulos
Copyright (C) 2016 Red Hat, Inc. Inc.
Copyright (C) 2004-2006, 2010, 2012 Free Software Foundation, Inc.
Copyright (C) 2014-2018 Nikos Mavrogiannopoulos
Copyright (C) 2004-2006, 2008, 2010, 2012 Free Software Foundation, Inc.
Copyright (C) 2006, 2008, 2010, 2012 Free Software Foundation, Inc.
Copyright (C) 2019 Nikos Mavrogiannopoulos
Copyright (C) 2007-2008, 2010, 2012 Free Software Foundation, Inc.
Copyright (C) 2018 Dmitry Eremin-Solenikov
Copyright (C) 2016 Nikos Mavrogiannopoulos
Copyright (C) 2016-2017 Free Software Foundation, Inc.
Copyright (C) 2006-2008, 2010, 2012 Free Software Foundation, Inc.
Copyright (C) 2014-2018 Nikos Mavrogiannopoulos
Copyright (C) 2000-2012, 2016, 2019 Free Software Foundation, Inc.
Copyright (C) 2007-2012, 2014, 2015, 2016, 2019 Free Software Foundation, Inc.
Copyright (C) 2007-2010, 2012 Free Software Foundation, Inc.
Copyright (C) 2011-2012, 2016 Free Software Foundation, Inc.
Copyright (C) 2007-2012, 2014 Free Software Foundation, Inc.
Copyright (C) 2007-2012, 2014, 2019 Free Software Foundation, Inc.
Copyright (C) 2007-2012, 2016, 2019 Free Software Foundation, Inc.
Copyright (C) 2007-2013, 2016 Free Software Foundation, Inc.
Copyright (C) 2019 Free Software Foundation, Inc.
Copyright (C) 2007-2012, 2019 Free Software Foundation, Inc.
Copyright (C) 2004-2006, 2010, 2012 Free Software Foundation, Inc.
Copyright (C) 2007-2014, 2016 Free Software Foundation, Inc.
Copyright (C) 2007-2012, 2014, 2016 Free Software Foundation, Inc.
Copyright (C) 2004-2006, 2008-2010, 2012 Free Software Foundation, Inc.
Copyright (C) 2007, 2010-2012 Free Software Foundation, Inc.
Copyright (C) 2007-2008, 2010-2012 Free Software Foundation, Inc.
Copyright (C) 2017 Karl Tarbe
Copyright (C) 2007-2014, 2016, 2019 Free Software Foundation, Inc.
Copyright (C) 2015-2019 Red Hat, Inc.
Copyright (C) 2013, 2019 Free Software Foundation, Inc. Felipe Castro <fefcas@gmail.com>, 2013, 2019.
Copyright (C) 2009 Free Software Foundation, Inc. Tao Wei <weitao1979@gmail.com>, 2008. Aron Xu <happyaron.xu@gmail.com>, 2009. Tianze Wang <zwpjwzt@126.com>, 2015. Mingye Wang <arthur200126@gmail.com>, 2015.
Copyright (C) 2015 Red Hat, Inc.
Copyright © 2007, 2008, 2009, 2011, 2012, 2017 Free Software Foundation, Inc. Daniel Nylander <po@danielnylander.se>, 2006, 2007, 2008, 2009, 2011, 2012. Anders Jonsson <anders.jonsson@norsjovallen.se>, 2017.
Copyright (C) 2011 Free Software Foundation, Inc.
Copyright (C) 2010, 2011, 2012, 2013, 2019 Free Software Foundation, Inc. Sergio Zanchetta <primes2h@ubuntu.com>, 2010, 2011, 2012. Milo Casagrande <milo@milo.name>, 2013, 2019.
Copyright © 2013 Free Software Foundation, Inc. Clytie Siddall <clytie@riverland.net.au>, 2008-2010. Trần Ngọc Quân <vnwildman@gmail.com>, 2012-2013.
Copyright (C) 2006, 2007, 2008, 2009, 2011, 2012, 2013 Free Software Foundation, Inc. Jakub Bogusz <qboosh@pld-linux.org>, 2006-2019.
Copyright © 2011, 2012, 2013 Free Software Foundation, Inc. Jorma Karvonen <karvonen.jorma@gmail.com>, 2011-2013.
Copyright (C) 2009 Free Software Foundation, Inc. Petr Písař <petr.pisar@atlas.cz>, 2009, 2011, 2012, 2013, 2019.
Copyright (C) 2018 Free Software Foundation, Inc. Francisco Javier Serrador <fserrador@gmail.com>, 2018.

Copyright (C) 2006 Free Software Foundation, Inc. Jens Seidel <jensseidel@users.sf.net>, 2006. Michael Piefel <piefel@informatik.hu-berlin.de>, 2006. Mario Blättermann <mario.blaettermann@gmail.com>, 2012, 2013. Roland
Copyright © 2016 Free Software Foundation, Inc.
Copyright (C) 2008 Free Software Foundation, Inc.
Copyright (C) 2006-2010, 2012 Free Software Foundation, Inc.
Copyright (C) 2006, 2007, 2008, 2015, 2019, 2020 Free Software Foundation, Inc. Sharuzzaman Ahmat Raslan <sharuzzaman@gmail.com>, 2006, 2007, 2008, 2015, 2019, 2020.
Copyright (C) 2013 Free Software Foundation, Inc. This file is distributed under the same license as the libgnutls package.
Copyright (C) 2019 Free Software Foundation, Inc. Rafael Fontenelle <rafaelff@gnome.org>, 2018, 2019.
Copyright © copyright{} 2001-2020 Free Software Foundation, Inc.
Copyright (C) 2007 Free Software Foundation, Inc.
Copyright (C) 2001-2012, 2014, 2016, 2019 Free Software Foundation, Inc.
Copyright (C) 2001-2020 Free Software Foundation, Inc. \\ Copyright (C) 2001-2020 Nikos Mavrogiannopoulos
Copyright (C) 2014-2016 Nikos Mavrogiannopoulos
Copyright (C) 2000-2012, 2019 Free Software Foundation, Inc.
Copyright (C) 2012-2013 Free Software Foundation, Inc.
Copyright (C) 2016-2017 Red Hat, Inc.
Copyright (C) 2018 IBM Corporation
Copyright (C) 2019 Tim Rühse
Copyright (C) 2016 Red Hat, Inc.
Copyright (C) 2006-2012 Free Software Foundation, Inc. Author: Simon Josefsson, Howard Chu
Copyright (C) 2015-2017 Red Hat, Inc.
Copyright (C) 2013-2015 Nikos Mavrogiannopoulos
Copyright (C) 2016-2019 Tim Kosse
Copyright (C) 2019 Red Hat
Copyright (C) 2006, 2008, 2010, 2012 Free Software Foundation, Inc.
Copyright (C) 2015-2018 Red Hat, Inc.
Copyright (C) 2017-2020 Red Hat, Inc.
Copyright (C) 2015-2017 Nikos Mavrogiannopoulos
Copyright (C) 2012-2018 Free Software Foundation, Inc.
Copyright (C) 2016 Red Hat, Inc.
Copyright (C) 2016-2018 Red Hat, Inc.
Copyright (C) 2014 Nikos Mavrogiannopoulos, Andreas Schultz
Copyright (C) 2012-2016 Sean Buckheister
Copyright (C) 2008-2014 Free Software Foundation, Inc.
Copyright (C) 2017 Red Hat
Copyright (C) 2019 Canonical, Ltd.
Copyright (C) 2009-2012 Free Software Foundation, Inc. Author: Simon Josefsson
Copyright (c) 2005 WiSeKey
Copyright (C) 2004-2016 Free Software Foundation, Inc.
Copyright (C) 2004-2016 Free Software Foundation, Inc.
Copyright (C) 2010, 2012 Free Software Foundation, Inc.
Copyright (C) 2016 Nikos Mavrogiannopoulos
Copyright (C) 2018 Nikos Mavrogiannopoulos
Copyright (C) 2014 Nikos Mavrogiannopoulos
Copyright (C) 2019 Tom Vrancken (dev@tomvrancken.nl)
Copyright (C) 2018 Hugo Beauzée-Luyssen
Copyright (C) 2016 Thomas Klute
Copyright (C) 2017 Thomas Klute
Copyright 2011-2016 The Pkcs11Interop Project
Copyright (C) 2016 Tim Kosse
Copyright (C) 2020 Red Hat, Inc.
Copyright (C) 2019 Daiki Ueno
Copyright (C) 2015, 2019 Red Hat, Inc.
Copyright (C) 2008-2014 Free Software Foundation, Inc.
Copyright (C) 2017 Red Hat Inc.

LICENCE TERMS (cont.)

Copyright (C) 2008, 2010, 2012 Free Software Foundation, Inc.
Copyright (C) 2016 Attila Molnar
Copyright (C) 2018 Red Hat, Inc
Copyright(c) 2017 Tim RUEHSEN
Copyright(c) 2017 Free Software Foundation, Inc.
Copyright 2016 Nikos Mavrogiannopoulos
Copyright 2016 Google Inc.
Copyright 2017 Red Hat, Inc.
Copyright 2016 Google Inc.
Copyright (C) 2017 Nikos Mavrogiannopoulos
Copyright (C) 2020 Dmitry Baryshkov
Copyright (C) 2001, 2003, 2006-2020 Free Software Foundation, Inc.
Copyright (C) 2012 KU Leuven
Copyright (C) 2012 KU Leuven
Copyright (C) 2012-2014 Free Software Foundation, Inc.
Copyright (C) 2000-2012 Free Software Foundation, Inc. Author: Nikos Mavrogiannopoulos
Copyright (C) 2000, 2002, 2004-2005, 2007, 2009-2020 Free Software Foundation, Inc.
Copyright 2015-2020 Free Software Foundation, Inc.
Copyright (C) 2002, 2004, 2008-2020 Free Software Foundation, Inc.
Copyright (C) 1993-2020 Free Software Foundation, Inc. Contributed by Paul Eggert <eggert@twinsun.com>.
Copyright (C) 1992-2001, 2003-2007, 2009-2020 Free Software Foundation, Inc.
Copyright (C) 1991-2020 Free Software Foundation, Inc.
Copyright (C) 1999-2000, 2002-2020 Free Software Foundation, Inc.
Copyright (C) 1997, 2001-2002, 2004-2006, 2008-2020 Free Software Foundation, Inc. Contributed by Philip Blundell <pjb27@cam.ac.uk>, 1997.
Copyright 2016-2020 Free Software Foundation, Inc. Contributed by Paul Eggert <eggert@cs.ucla.edu>.
Copyright (C) 2008, 2010-2020 Free Software Foundation, Inc.
Copyright (C) 2003, 2007, 2009-2020 Free Software Foundation, Inc.
Copyright (C) 1996-1997, 1999-2007, 2009-2020 Free Software Foundation, Inc.
Copyright (C) 2002-2006, 2008-2020 Free Software Foundation, Inc.
Copyright (C) 2004-2020 Free Software Foundation, Inc.
Copyright (C) 2002, 2005, 2009-2020 Free Software Foundation, Inc.
Copyright (C) 2015-2020 Free Software Foundation, Inc.
Copyright (C) 2002, 2004-2006, 2009-2020 Free Software Foundation, Inc.
Copyright (C) 2002, 2009-2020 Free Software Foundation, Inc.
Copyright (C) 1994-2020 Free Software Foundation, Inc.
Copyright (C) 1997, 2001-2002, 2004-2020 Free Software Foundation, Inc. Contributed by Simon Josefsson <simon@josefsson.org>.
Copyright (C) 2001-2004, 2006, 2009-2020 Free Software Foundation, Inc. Written by Bruno Haible <bruno@clisp.org>, 2001.
Copyright (C) 1995, 1997-1998, 2003-2004, 2007, 2009-2020 Free Software Foundation, Inc.
Copyright (C) 2002, 2004-2007, 2009-2020 Free Software Foundation, Inc.
Copyright (C) 2001-2003, 2005-2020 Free Software Foundation, Inc. Written by Bruno Haible <bruno@clisp.org>, 2001.
Copyright (C) 1984, 1989-1990, 2000-2015, 2018-2019 Free Software Foundation, Inc.
Copyright (C) 2004-2014 Free Software Foundation, Inc.
Copyright (C) 2011-2014 Free Software Foundation, Inc.
Copyright (C) 2001,2002 Paul Sheer
Copyright (C) 2012 Lucas Fisher
Copyright (C) 1992-2015 by Bruce Korb.
Copyright (C) 1992-2018 by Bruce Korb - all rights reserved
Copyright (C) 2011-2018 Bruce Korb, all rights reserved. . It is licensed for use, modification and redistribution under the terms of the Modified (3 clause) Berkeley Software Distribution License <http://www.xfree86.org/3.3.6/COPYRIGHT2.html>
Copyright (C) 2001-2018 Free Software Foundation, Inc.
Copyright (C) 1992-2015 by Bruce Korb - all rights reserved Everyone is permitted to copy and distribute verbatim copies of this license document, but changing it is not allowed.

Copyright (C) 1992-2018 by Bruce Korb
Copyright (C) 1992-2017 by Bruce Korb - all rights reserved
Copyright (C) 2008-2018 Free Software Foundation, Inc. Written by Bruce Korb <bkorb@gnu.org>, 2008.
Copyright (C) 1992-2015 by Bruce Korb - all rights reserved Everyone is permitted to copy and distribute verbatim copies of this license document, but changing it is not allowed.
Copyright 2012-2018 Free Software Foundation, Inc.
Copyright (C) 2005-2018 by Bruce Korb - all rights reserved
Copyright 2012-2018 Free Software Foundation, Inc.
Copyright (C) 1992-2018 by Bruce Korb - all rights reserved
Copyright (C) 1995-1998, 2000-2002, 2004-2006, 2009-2018 Free Software Foundation, Inc.
Copyright (C) 1992-2018 by Bruce Korb - all rights reserved
Copyright (C) 1992-2015 by Bruce Korb - all rights reserved
Copyright (C) 2004-2015 Free Software Foundation, Inc.
Copyright (C) 2010-2015 Free Software Foundation, Inc.
Copyright 1992-2019 Free Software Foundation, Inc.
Copyright (C) 2014 Free Software Foundation, Inc.
Copyright (C) 2011 Free Software Foundation, Inc.
Copyright (c) 2012 Xan Lopez
Copyright (c) 2012 Christian Persch
Copyright (c) 2012 Paolo Borelli
Copyright (c) 2012 Dan Winship
Copyright (c) 2015,2018 Bastien ROUCARIES
Copyright (c) 2009 Allan Caffee <allan.caffee@gmail.com>
Copyright (c) 2009 Allan Caffee <allan.caffee@gmail.com>
Copyright (C) 2002-2018 Free Software Foundation, Inc.
Copyright (C) 2011-2018 Free Software Foundation, Inc.
Copyright (C) 2001-2018 Free Software Foundation, Inc.
Copyright (C) 1997-2018 Free Software Foundation, Inc.
Copyright (C) 1999-2018 Free Software Foundation, Inc.
Copyright (C) 1996-2018 Free Software Foundation, Inc.
Copyright (C) 2003-2018 Free Software Foundation, Inc.
Copyright (C) 2009-2018 Free Software Foundation, Inc.
Copyright (C) 2006-2018 Free Software Foundation, Inc.
Copyright (C) 2004-2018 Free Software Foundation, Inc.
Copyright (C) 1995-2014, 2016 Free Software Foundation, Inc.
Copyright (C) 2000-2002, 2007-2014, 2016 Free Software Foundation, Inc.
Copyright (C) 1996-2003, 2009-2016 Free Software Foundation, Inc.
Copyright (C) 2001-2016 Free Software Foundation, Inc.
Copyright (C) 2001-2005, 2008-2016 Free Software Foundation, Inc.
Copyright (C) 1995-2003, 2005-2006, 2008-2014, 2016 Free Software dnl Foundation, Inc.
Copyright © 2004 Scott James Remnant <scott@netsplit.com>.
Copyright © 2012-2015 Dan Nicholson <dbn.lists@gmail.com>
copyright either version 2 of the License, or dnl (at your option)
Copyright (C) 1996-2003, 2005, 2008-2016 Free Software Foundation, Inc.
Copyright (C) 2009-2020 Free Software Foundation, Inc.
Copyright 2017-2020 Free Software Foundation, Inc.
Copyright (C) 2006-2020 Free Software Foundation, Inc.
Copyright (C) 2002-2004, 2006-2007, 2009-2020 Free Software Foundation, dnl Inc.
Copyright (C) 2006, 2008-2020 Free Software Foundation, Inc.
Copyright (c) 2009 Tom Howard <tomhoward@users.sf.net>
Copyright (c) 2008 John Darrington <j.darrington@elvis.murdoch.edu.au>
Copyright (c) 2015 Enrico M. Crisostomo <enrico.m.crisostomo@gmail.com>
Copyright (c) 2012, 2016 Philip Withnall
Copyright (c) 2012 Xan Lopez
Copyright (c) 2012 Christian Persch
Copyright (c) 2012 Paolo Borelli
Copyright (c) 2012 Dan Winship

LICENCE TERMS (cont.)

Copyright (c) 2015,2018 Bastien ROUCARIES
Copyright (c) 2008 Tom Howard <tomhoward@users.sf.net>
Copyright 2016-2020 Free Software Foundation, Inc.
Copyright (C) 2005, 2007, 2009-2020 Free Software Foundation, Inc.
Copyright (C) 2008-2020 Free Software Foundation, Inc.
Copyright (C) 2000-2002, 2006, 2008-2014, 2016, 2019-2020 Free Software dnl Foundation, Inc.
Copyright (C) 2002, 2005, 2007, 2009-2020 Free Software Foundation, Inc.
Copyright (C) 2003, 2009-2020 Free Software Foundation, Inc.
Copyright (C) 2001-2004, 2006-2020 Free Software Foundation, Inc.
Copyright (C) 2004, 2006, 2008-2020 Free Software Foundation, Inc.
Copyright (C) 2007-2008, 2010-2020 Free Software Foundation, Inc.
Copyright (C) 2003, 2006-2020 Free Software Foundation, Inc.
Copyright 2012-2020 Free Software Foundation, Inc.
Copyright (C) 2006, 2009-2020 Free Software Foundation, Inc.
Copyright (C) 2006-2007, 2009-2020 Free Software Foundation, Inc.
Copyright (C) 2011-2020 Free Software Foundation, Inc.
Copyright (C) 2007, 2009-2020 Free Software Foundation, Inc.
Copyright (C) 2007-2020 Free Software Foundation, Inc.
Copyright (C) 2000-2001, 2003-2007, 2009-2020 Free Software Foundation, Inc.
Copyright (C) 2001, 2003-2007, 2009-2020 Free Software Foundation, Inc.
Copyright (C) 2005-2007, 2009-2020 Free Software Foundation, Inc. dnl
Copyright (C) 1998-2003, 2005-2007, 2009-2020 Free Software Foundation, dnl Inc.
Copyright (C) 2002, 2004-2005, 2007, 2009-2020 Free Software Foundation, dnl Inc.
Copyright (C) 2001-2003, 2005, 2007, 2009-2020 Free Software Foundation, Inc.
Copyright (C) 2002-2020 Free Software Foundation, Inc.
Copyright (C) 2000-2012 Free Software Foundation, Inc.
Copyright (C) 2005-2006, 2008-2020 Free Software Foundation, Inc.
Copyright (C) 2015-2020 Free Software Foundation, Inc.
Copyright (C) 2004-2014, 2016, 2019-2020 Free Software Foundation, Inc.
Copyright (C) 1997-2004, 2006-2007, 2009-2020 Free Software Foundation, dnl Inc.
Copyright (C) 2004-2006, 2009-2020 Free Software Foundation, Inc.
Copyright (C) 1997-2002, 2006, 2008-2020 Free Software Foundation, Inc.
Copyright (C) 1997-2004, 2006, 2008-2020 Free Software Foundation, Inc.
Copyright 1992-1996, 1998-2020 Free Software Foundation, Inc.
Copyright (C) 1995-2002, 2004-2005, 2008-2014, 2016, 2019-2020 Free dnl Software Foundation, Inc.
Copyright (C) 1996-2001, 2003-2015 Free Software Foundation, Inc. Written by Gordon Matzigkeit, 1996
Copyright (C) 2014 Free Software Foundation, Inc.
Copyright (C) 2011 Free Software Foundation, Inc.
Copyright (C) 2003, 2005-2020 Free Software Foundation, Inc.
Copyright (C) 2017-2020 Free Software Foundation, Inc.
Copyright (C) 2005-2020 Free Software Foundation, Inc.
Copyright (C) 1997-2001, 2003-2020 Free Software Foundation, Inc.
Copyright (C) 2004-2005, 2007-2009, 2011-2015 Free Software Foundation, Inc. Written by Gary V. Vaughan, 2004
Copyright (C) 2004-2005, 2007-2008, 2011-2015 Free Software Foundation, Inc. Written by Gary V. Vaughan, 2004
Copyright (C) 2004, 2011-2015 Free Software Foundation, Inc. Written by Scott James Remnant, 2004
Copyright (C) 2004-2005, 2007, 2009, 2011-2015 Free Software Foundation, Inc. Written by Scott James Remnant, 2004.
Copyright (C) 2003-2004, 2006-2007, 2009-2020 Free Software Foundation, dnl Inc.
Copyright (C) 2002-2004, 2009-2020 Free Software Foundation, Inc.
Copyright (C) 2002-2004, 2007-2020 Free Software Foundation, Inc.
Copyright (C) 2005, 2009-2020 Free Software Foundation, Inc.
Copyright (C) 1999-2001, 2003-2020 Free Software Foundation, Inc.
Copyright (C) 2012-2020 Free Software Foundation, Inc.
Copyright (C) 2002-2003, 2005-2006, 2009-2020 Free Software Foundation, dnl Inc.
Copyright (C) 2010-2020 Free Software Foundation, Inc.
Copyright (C) 2003, 2007-2020 Free Software Foundation, Inc.
Copyright (C) 2019-2020 Free Software Foundation, Inc.

Copyright (C) 2002-2020 Free Software Foundation, Inc.
Copyright (C) 2002-2006, 2009-2020 Free Software Foundation, Inc.
Copyright 2013-2020 Free Software Foundation, Inc.
Copyright (C) 2001-2002, 2006-2020 Free Software Foundation, Inc.
Copyright (C) 2003, 2005-2006, 2008-2020 Free Software Foundation, Inc.
Copyright (C) 2005-2007, 2009-2020 Free Software Foundation, Inc.
Copyright (C) 2004, 2006, 2009-2020 Free Software Foundation, Inc.
Copyright (C) 2001-2003, 2006, 2010-2020 Free Software Foundation, Inc.
Copyright (C) 1998-1999, 2001, 2003, 2005-2007, 2009-2020 Free Software Foundation, Inc.
Copyright (C) 2009-2020 Free Software Foundation, Inc.
Copyright 2011-2020 Free Software Foundation, Inc.
Copyright (C) 2001-2020 Free Software Foundation, Inc.
Copyright (C) 2002, 2005-2020 Free Software Foundation, Inc.
Copyright (C) 2002, 2007-2020 Free Software Foundation, Inc.
Copyright (C) 2002-2003, 2005-2020 Free Software Foundation, Inc.
Copyright (C) 2002-2003, 2005-2007, 2009-2020 Free Software Foundation, dnl Inc.
Copyright (C) 2000-2001, 2003-2007, 2009-2020 Free Software Foundation, Inc.
Copyright (C) 2002-2004, 2006-2020 Free Software Foundation, Inc.
Copyright (C) 2002-2003, 2006-2007, 2009-2020 Free Software Foundation, dnl Inc.
Copyright (C) 2005, 2008, 2010-2020 Free Software Foundation, Inc.
Copyright (C) 2002-2003, 2008-2020 Free Software Foundation, Inc.
Copyright (C) 2003-2004, 2008-2020 Free Software Foundation, Inc.
Copyright (C) 2020 Free Software Foundation, Inc.
Copyright (C) 2003 James Henstridge 2007-2017 Stefan Sauer
Copyright (C) 2002-2018 Free Software Foundation, Inc.
Copyright (C) 2011-2018 Free Software Foundation, Inc.
Copyright (C) 2001-2018 Free Software Foundation, Inc.
Copyright (C) 1997-2018 Free Software Foundation, Inc.
Copyright (C) 1999-2018 Free Software Foundation, Inc.
Copyright (C) 1996-2018 Free Software Foundation, Inc.
Copyright (C) 2003-2018 Free Software Foundation, Inc.
Copyright (C) 2009-2018 Free Software Foundation, Inc.
Copyright (C) 2006-2018 Free Software Foundation, Inc.
Copyright (C) 2004-2018 Free Software Foundation, Inc.
Copyright (C) 1995-2014, 2016 Free Software Foundation, Inc.
Copyright (C) 2000-2002, 2007-2014, 2016 Free Software Foundation, Inc.
Copyright (C) 1996-2003, 2009-2016 Free Software Foundation, Inc.
Copyright (C) 2001-2016 Free Software Foundation, Inc.
Copyright (C) 2001-2005, 2008-2016 Free Software Foundation, Inc.
Copyright (C) 1995-2003, 2005-2006, 2008-2014, 2016 Free Software dnl Foundation, Inc.
Copyright © 2004 Scott James Remnant <scott@netsplit.com>.
Copyright © 2012-2015 Dan Nicholson <dbn.lists@gmail.com> dnl
Copyright (C) 1996-2003, 2005, 2008-2016 Free Software Foundation, Inc.
Copyright (C) 2009-2020 Free Software Foundation, Inc.
Copyright 2017-2020 Free Software Foundation, Inc.
Copyright (C) 2006-2020 Free Software Foundation, Inc.
Copyright (C) 2002-2004, 2006-2007, 2009-2020 Free Software Foundation, dnl Inc.
Copyright (C) 2006, 2008-2020 Free Software Foundation, Inc.
Copyright (c) 2009 Tom Howard <tomhoward@users.sf.net>
Copyright (c) 2008 John Darrington <j.darrington@elvis.murdoch.edu.au>
Copyright (c) 2015 Enrico M. Crisostomo <enrico.m.crisostomo@gmail.com>
Copyright (c) 2012, 2016 Philip Withnall
Copyright (c) 2015,2018 Bastien ROUCARIES
Copyright (c) 2008 Tom Howard <tomhoward@users.sf.net>
Copyright 2016-2020 Free Software Foundation, Inc.
Copyright (C) 2005, 2007, 2009-2020 Free Software Foundation, Inc.
Copyright (C) 2008-2020 Free Software Foundation, Inc.

LICENCE TERMS (cont.)

Copyright (C) 2000-2002, 2006, 2008-2014, 2016, 2019-2020 Free Software dnl Foundation, Inc.
Copyright (C) 2002, 2005, 2007, 2009-2020 Free Software Foundation, Inc.
Copyright (C) 2003, 2009-2020 Free Software Foundation, Inc.
Copyright (C) 2001-2004, 2006-2020 Free Software Foundation, Inc.
Copyright (C) 2004, 2006, 2008-2020 Free Software Foundation, Inc.
Copyright (C) 2007-2008, 2010-2020 Free Software Foundation, Inc.
Copyright (C) 2003, 2006-2020 Free Software Foundation, Inc.
Copyright 2012-2020 Free Software Foundation, Inc.
Copyright (C) 2006, 2009-2020 Free Software Foundation, Inc.
Copyright (C) 2006-2007, 2009-2020 Free Software Foundation, Inc.
Copyright (C) 2011-2020 Free Software Foundation, Inc.
Copyright (C) 2007, 2009-2020 Free Software Foundation, Inc.
Copyright (C) 2007-2020 Free Software Foundation, Inc.
Copyright (C) 2000-2001, 2003-2007, 2009-2020 Free Software Foundation, Inc.
Copyright (C) 2001, 2003-2007, 2009-2020 Free Software Foundation, Inc.
Copyright (C) 2005-2007, 2009-2020 Free Software Foundation, Inc. dnl
Copyright (C) 1998-2003, 2005-2007, 2009-2020 Free Software Foundation, dnl Inc. dnl
Copyright (C) 2002, 2004-2005, 2007, 2009-2020 Free Software Foundation, dnl Inc.
Copyright (C) 2001-2003, 2005, 2007, 2009-2020 Free Software Foundation, Inc.
Copyright (C) 2002-2020 Free Software Foundation, Inc.
Copyright (C) 2000-2012 Free Software Foundation, Inc.
Copyright (C) 2005-2006, 2008-2020 Free Software Foundation, Inc.
Copyright (C) 2015-2020 Free Software Foundation, Inc.
Copyright (C) 2004-2014, 2016, 2019-2020 Free Software Foundation, Inc.
Copyright (C) 1997-2004, 2006-2007, 2009-2020 Free Software Foundation, dnl Inc.
Copyright (C) 2004-2006, 2009-2020 Free Software Foundation, Inc.
Copyright (C) 1997-2002, 2006, 2008-2020 Free Software Foundation, Inc.
Copyright (C) 1997-2004, 2006, 2008-2020 Free Software Foundation, Inc.
Copyright 1992-1996, 1998-2020 Free Software Foundation, Inc.
Copyright (C) 1995-2002, 2004-2005, 2008-2014, 2016, 2019-2020 Free dnl Software Foundation, Inc.
Copyright (C) 1996-2001, 2003-2015 Free Software Foundation, Inc. Written by Gordon Matzigkeit, 1996
Copyright (C) 2003, 2005-2020 Free Software Foundation, Inc.
Copyright (C) 2017-2020 Free Software Foundation, Inc.
Copyright (C) 2005-2020 Free Software Foundation, Inc.
Copyright (C) 1997-2001, 2003-2020 Free Software Foundation, Inc.
Copyright (C) 2004-2005, 2007-2009, 2011-2015 Free Software Foundation, Inc. Written by Gary V. Vaughan, 2004
Copyright (C) 2004-2005, 2007-2008, 2011-2015 Free Software Foundation, Inc. Written by Gary V. Vaughan, 2004
Copyright (C) 2004, 2011-2015 Free Software Foundation, Inc. Written by Scott James Remnant, 2004
Copyright (C) 2004-2005, 2007, 2009, 2011-2015 Free Software Foundation, Inc. Written by Scott James Remnant, 2004.
Copyright (C) 2003-2004, 2006-2007, 2009-2020 Free Software Foundation, dnl Inc.
Copyright (C) 2002-2004, 2009-2020 Free Software Foundation, Inc.
Copyright (C) 2002-2004, 2007-2020 Free Software Foundation, Inc.
Copyright (C) 2005, 2009-2020 Free Software Foundation, Inc.
Copyright (C) 1999-2001, 2003-2020 Free Software Foundation, Inc.
Copyright (C) 2012-2020 Free Software Foundation, Inc.
Copyright (C) 2002-2003, 2005-2006, 2009-2020 Free Software Foundation, dnl Inc.
Copyright (C) 2010-2020 Free Software Foundation, Inc.
Copyright (C) 2003, 2007-2020 Free Software Foundation, Inc.
Copyright (C) 2019-2020 Free Software Foundation, Inc.
Copyright (C) 2002-2020 Free Software Foundation, Inc.
Copyright (C) 2002-2006, 2009-2020 Free Software Foundation, Inc.
Copyright 2013-2020 Free Software Foundation, Inc.
Copyright (C) 2001-2002, 2006-2020 Free Software Foundation, Inc.
Copyright (C) 2003, 2005-2006, 2008-2020 Free Software Foundation, Inc.
Copyright (C) 2005-2007, 2009-2020 Free Software Foundation, Inc.
Copyright (C) 2004, 2006, 2009-2020 Free Software Foundation, Inc.

Copyright (C) 2001-2003, 2006, 2010-2020 Free Software Foundation, Inc.
Copyright (C) 1998-1999, 2001, 2003, 2005-2007, 2009-2020 Free Software Foundation, Inc.
Copyright (C) 2009-2020 Free Software Foundation, Inc.
Copyright 2011-2020 Free Software Foundation, Inc.
Copyright (C) 2001-2020 Free Software Foundation, Inc.
Copyright (C) 2002, 2005-2020 Free Software Foundation, Inc.
Copyright (C) 2002, 2007-2020 Free Software Foundation, Inc.
Copyright (C) 2002-2003, 2005-2020 Free Software Foundation, Inc.
Copyright (C) 2002-2003, 2005-2007, 2009-2020 Free Software Foundation, dnl Inc.
Copyright (C) 2000-2001, 2003-2007, 2009-2020 Free Software Foundation, Inc.
Copyright (C) 2002-2004, 2006-2020 Free Software Foundation, Inc.
Copyright (C) 2002-2003, 2006-2007, 2009-2020 Free Software Foundation, dnl Inc.
Copyright (C) 2005, 2008, 2010-2020 Free Software Foundation, Inc.
Copyright (C) 2002-2003, 2008-2020 Free Software Foundation, Inc.
Copyright (C) 2003-2004, 2008-2020 Free Software Foundation, Inc.
Copyright (C) 2020 Free Software Foundation, Inc.
Copyright (C) 2003 James Henstridge 2007-2017 Stefan Sauer
Copyright (C) 2002-2012 Free Software Foundation, Inc.
Copyright (c) 2002 Andrew McDonald <andrew@mcdonald.org.uk>
Copyright (C) 2012 Free Software Foundation, Inc.
Copyright (C) 2012 Free Software Foundation, Inc.
Copyright (C) 2012 Free Software Foundation, Inc.
Copyright (C) 2001-2020 Nikos Mavrogiannopoulos
copyright 2001-2020 Free Software Foundation, Inc.
copyright 2001-2020 Nikos Mavrogiannopoulos
Copyright (C) 2001-2020 Nikos Mavrogiannopoulos
Copyright 2001-2020 Free Software Foundation, Inc.
Copyright 2001-2020 Nikos Mavrogiannopoulos
Copyright 2000, 2001, 2002, 2007, 2008 Free Software Foundation, Inc.
Copyright (C) 2003 James Henstridge 2004-2007 Damon Chaplin 2007-2017 Stefan Sauer
Copyright (c) 1996-1999 by Internet Software Consortium.
Copyright (C) 2000-2012, 2019 Free Software Foundation, Inc.
Copyright (C) 2005-2012 Free Software Foundation, Inc.
Copyright (C) 2002-2020 Free Software Foundation, Inc.
Copyright (C) 2013 Nikos Mavrogiannopoulos
Copyright (C) 2001-2012 Free Software Foundation, Inc.
Copyright (c) 1996,1999 by Internet Software Consortium.
Copyright (c) 2001, 2002, 2013 Nikos Mavrogiannopoulos added -tex, -pkg-site
Copyright (c) 1998 Michael Zucchi
Copyright (c) 2013 Adam Sampson made highlighting not depend on hash order, for Perl 5.18
copyright section with the given notice after a preamble. Use, e.g., '2002, 2003 Simon Josefsson'.
Copyright (c) 2001, 2002, 2013 Nikos Mavrogiannopoulos added -tex, -pkg-site
Copyright (c) 1998 Michael Zucchi
Copyright (c) 2013 Adam Sampson made highlighting not depend on hash order, for Perl 5.18
copyright section with the given notice after a preamble. Use, e.g., '2002, 2003 Simon Josefsson'.
Copyright (c) 2001, 2002, 2013 Nikos Mavrogiannopoulos added -tex, -pkg-site
Copyright (c) 1998 Michael Zucchi
Copyright (c) 2013 Adam Sampson
Copyright (C) 2001-2020 Free Software Foundation, Inc. Copyright (C) 2001-2020 Nikos Mavrogiannopoulos
Copyright (C) 2007-2012 Free Software Foundation, Inc.
Copyright 2001-2020 Free Software Foundation, Inc.
Copyright (C) 2000-2019 Free Software Foundation
Copyright (C) 2000-2019 Free Software Foundation
copyright "2001-\$(YEAR) Free Software Foundation, Inc.
Copyright (c) 2007, 2008 Free Software Foundation, Inc.
Copyright 2020 Free Software Foundation, Inc.
Copyright (C) \$year Free Software Foundation, Inc.

LICENCE TERMS (cont.)

Copyright (C) 2000-2012 Free Software Foundation, Inc.
Copyright (C) 2000-2020 Free Software Foundation, and others all rights reserved.
Copyright (C) 2000-2020 Free Software Foundation, and others all rights reserved.
Copyright (C) 2000-2019 Free Software Foundation, and others all rights reserved.
Copyright (C) 2000-2019 Free Software Foundation, and others all rights reserved.
Copyright (C) 2017 Red Hat, Inc.
Copyright (C) 2002-2010, 2012 Free Software Foundation, Inc.
Copyright (C) 2016 Red Hat, Inc.
Copyright (C) 2014-2016 Nikos Mavrogiannopoulos
Copyright (C) 2015-2018 Red Hat, Inc.
Copyright (C) 2008 Joe Orton <joe@manyfish.co.uk>
Copyright (C) 2013 Nikos Mavrogiannopoulos
Copyright (C) 2014-2017 Red Hat
Copyright (C) 2016 Red Hat
Copyright (C) 2016 Dmitry Eremin-Solenikov
Copyright (C) 2015-2019 Red Hat, Inc.
Copyright (C) 2016-2017 Red Hat, Inc.
Copyright (C) 2011-2012 Free Software Foundation, Inc.
Copyright (C) 2015-2016 Red Hat, Inc.
Copyright © 2008-2012 Intel Corporation.
Copyright © 2015-2016 Red Hat, Inc.
Copyright (C) 2019 Red Hat, Inc.
Copyright (C) 2003-2012 Free Software Foundation, Inc.
Copyright (C) 2003-2012 Free Software Foundation, Inc.
Copyright (C) 2013 Red Hat
Copyright (C) 2014 Red Hat
Copyright (C) 2008 Free Software Foundation, Inc.
Copyright (C) 1995-2017 Free Software Foundation, Inc.
Copyright (C) 2013, 2014 Niels Möller
Copyright: 2009-2012 Aleksey Kravchenko <rhash.admin@gmail.com>
Copyright (C) 2013 Niels Möller
Copyright (C) 2012 Nikos Mavrogiannopoulos, Niels Möller
Copyright (C) 2012 Simon Josefsson
Copyright (C) 2014 Niels Möller
Copyright (C) 2012, 2014 Niels Möller
Copyright (C) 2013 Joachim Strömbergson
Copyright (C) 2012 Simon Josefsson
Copyright (C) 2012 Simon Josefsson, Niels Möller
Copyright (C) 2001, 2011 Niels Möller
Copyright (C) Jeremy Allison 2012
Copyright (C) Michael Adam 2012
Copyright (C) 2017, Red Hat Inc.
Copyright (C) 2001 Niels Möller
Copyright (C) 2017 Daiki Ueno
Copyright (C) 2004-2012 Free Software Foundation, Inc.
Copyright (C) 2000, 2001, 2008 Niels Möller
Copyright (C) 2013-2017 Nikos Mavrogiannopoulos
Copyright (C) 2014 Red Hat, Inc.
Copyright (C) 2015-2016 Red Hat, Inc.
Copyright (c) 2008 Alexander von Gernler. All rights reserved.
Copyright (c) 2008 Alexander von Gernler. All rights reserved.
Copyright (C) 2012-2015 Nikos Mavrogiannopoulos
Copyright (C) 2015 Nikos Mavrogiannopoulos
Copyright (C) 2014-2017 Red Hat
Copyright (C) 2014-2016 Nikos Mavrogiannopoulos
Copyright (C) 2013-2017 Red Hat
Copyright (C) 2015-2017 Red Hat, Inc.

Copyright (C) 2012 Nikos Mavrogiannopoulos
Copyright (C) 2014-2016 Red Hat, Inc.
Copyright (C) 2012-2016 Nikos Mavrogiannopoulos
Copyright (C) 2014 Nikos Mavrogiannopoulos
Copyright (C) 2003-2012 Free Software Foundation, Inc.
Copyright (C) 2014-2016 Red Hat
Copyright (C) 2002 Andrew McDonald
Copyright (C) 2015 Red Hat, Inc.
Copyright (C) 2018 Red Hat, Inc.
Copyright (C) 2016, 2017 Red Hat, Inc.
Copyright (C) 2017-2018 Red Hat, Inc.
Copyright (C) 2014-2015 Nikos Mavrogiannopoulos
Copyright © 2015-2016 Dyalog Ltd.
Copyright (C) 2008, Joe Orton <joe@manyfish.co.uk>
Copyright (C) 2012-2018 Nikos Mavrogiannopoulos
Copyright (C) 2015 Nikos Mavrogiannopoulos, Inc.
Copyright (C) 2016-2018 Red Hat, Inc.
Copyright (C) 2011 Bardenheuer GmbH, Munich and Bundesdruckerei GmbH, Berlin
Copyright (C) 2013 Frank Morgner
Copyright (C) 2016-2019 Red Hat, Inc.
Copyright (C) 2013 Frank Morgner <morgner@informatik.hu-berlin.de>
Copyright (C) 2001 Niels Moeller
Copyright (C) 2000-2020 Free Software Foundation, and others all rights reserved.
Copyright (C) 2004-2006, 2010, 2012 Free Software Foundation, Inc.
Copyright (C) 2007-2008, 2010, 2012 Free Software Foundation, Inc.
Copyright (C) 2007-2012, 2016, 2019 Free Software Foundation, Inc.
Copyright (C) 2007-2014, 2016 Free Software Foundation, Inc.
Copyright (C) 2000, 2001, 2002, 2003, 2004 Nikos Mavrogiannopoulos
Copyright (C) 2000, 2001, 2002, 2003, 2004 Nikos Mavrogiannopoulos
Copyright @copyright{} 2001-2020 Nikos Mavrogiannopoulos
copyright 2001-2012, 2014, 2016, 2019 Free Software Foundation, Inc.
Copyright 2001-2012, 2014, 2016, 2019 Free Software Foundation, Inc.
Copyright (C) 2001-2012, 2014, 2016, 2019 Free Software Foundation, Inc.
Copyright (C) 2000, 2001, 2002, 2007, 2008 Free Software Foundation, Inc.
Copyright (C) 2001-2012, 2014, 2016, 2019 Free Software Foundation, Inc.
Copyright (C) 2000, 2001, 2002, 2007, 2008 Free Software Foundation, Inc.
Copyright (C) 2013 Adam Sampson <ats@offog.org>
Copyright (C) 2013-2016 Nikos Mavrogiannopoulos
Copyright (C) 2013 Adam Sampson <ats@offog.org>
Copyright (C) 2013-2017 Nikos Mavrogiannopoulos
Copyright (C) 2019 Nikos Mavrogiannopoulos
Copyright (C) 2016 Guillaume Roguez
Copyright (c) 1996 Marc Stevens, Arjen K. Lenstra, Benne de Weger
Copyright (c) 1996 Marc Stevens, Arjen K. Lenstra,=20 Benne de Weger
Copyright (c) 1996 Marc Stevens, Arjen K. Lenstra, Benne de Weger
Copyright (c) 1996 Marc Stevens, Arjen K. Lenstra,=20 Benne de Weger
Copyright (C) 2016, Red Hat, Inc.
Copyright (C) 2016 Nikos Mavrogiannopoulos
Copyright (C) 2020 Red Hat, Inc.
Copyright (C) 2017-2019 Red Hat, Inc.
Copyright (C) 2012 Nikos Mavrogiannopoulos
Copyright (C) 2010, 2012 Free Software Foundation, Inc.
Copyright (C) 2012-2015 Nikos Mavrogiannopoulos
Copyright (C) 2017 Red Hat
Copyright (C) 2019 Free Software Foundation, Inc.
Copyright (C) 2018 Dmitry Eremin-Solenikov
Copyright (C) 2018 Dmitry Eremin-Solenikov

LICENCE TERMS (cont.)

Copyright (C) 2017 Nikos Mavrogiannopoulos
Copyright (C) 2013-2016 Nikos Mavrogiannopoulos
Copyright 2017 Red Hat, Inc.
Copyright (C) 2019 Tom Vrancken (dev@tomvrancken.nl)
Copyright (C) 2012 KU Leuven
Copyright (C) 2013 Christian Grothoff
Copyright (C) 2000-2020 Free Software Foundation, and others, all rights reserved.
Copyright (psktool_opt_strs+0) define zLicenseDescrip (psktool_opt_strs+283)
Copyright (C) 2000-2020 Free Software Foundation, and others, all rights reserved
Copyright (C) 1999-2017 by Bruce Korb - all rights reserved
Copyright (C) 2000-2020 Free Software Foundation, and others, all rights reserved.
Copyright (C) 1999-2017 by Bruce Korb - all rights reserved
Copyright (C) 1999-2000, 2002-2020 Free Software Foundation, Inc.
Copyright (C) 2013,2014 Nikos Mavrogiannopoulos
Copyright (C) 2001,2002 Paul Sheer
Copyright (C) 2016-2018 Red Hat, Inc.
Copyright (C) 2002,2003 Nikos Mavrogiannopoulos
Copyright (C) 2013-2014 Nikos Mavrogiannopoulos
Copyright (C) 1992-2018 by Bruce Korb - all rights reserved
Copyright (C) 1992-2018 by Bruce Korb - all rights reserved
Copyright (C) by Bruce Korb - all rights reserved
Copyright (C) by Bruce Korb - all rights reserved
Copyright (C) by Bruce Korb - all rights reserved
Copyright (C) 1999-2018 Bruce Korb, all rights reserved.
Copyright (C) 1999-2018 Bruce Korb, all rights reserved.
Copyright (C) 1999-2018 Bruce Korb, all rights reserved.
Copyright (C) 2013-2019 Nikos Mavrogiannopoulos See the end for copying conditions.
copyright© Klitzing.
Copyright (C) 2013-2019 Nikos Mavrogiannopoulos See the end for copying conditions.
Copyright© Klitzing.
Copyright (C) 1994 X Consortium
Copyright (C) 1996-2015 Free Software Foundation, Inc.
Copyright (C) 1999-2018 Free Software Foundation, Inc. Written by Tom Tromeey <tromeey@cygnus.com>.
Copyright 1992-2019 Free Software Foundation, Inc.
Copyright (C) 1999-2018 Free Software Foundation, Inc.
Copyright (C) 2004-2005, 2007, 2009, 2011-2015 Free Software Foundation, Inc. Written by Scott James Remnant, 2004.
Copyright (C) 2004, 2011-2015 Free Software Foundation, Inc. Written by Scott James Remnant, 2004
Copyright (C) 1996-2001, 2003-2015 Free Software Foundation, Inc. Written by Gordon Matzigeit, 1996
Copyright (C) 2004-2005, 2007-2008, 2011-2015 Free Software Foundation, Inc. Written by Gary V. Vaughan, 2004
Copyright (C) 2004-2005, 2007-2009, 2011-2015 Free Software Foundation, Inc. Written by Gary V. Vaughan, 2004
Copyright (c) 2006-2007 Diego Petten <flameeyes@gmail.com>
Copyright (C) 1996-2018 Free Software Foundation, Inc. Originally written by Fran,cois Pinard <pinard@iro.umontreal.ca>, 1996.
Copyright (C) 1989, 1991 Free Software Foundation, Inc.
Copyright (c) 2006, 2008 Junio C Hamano
Copyright (c) 2012, Freescale Semiconductor, Inc. All rights reserved.
Copyright (C) 1992-1996, 1998-2012 Free Software Foundation, Inc.
Copyright (C) 1994-2018 Free Software Foundation, Inc.
Copyright (C) 2011 Free Software Foundation, Inc.
Copyright (C) 1996-2018 Free Software Foundation, Inc.
Copyright (C) 2004-2015 Free Software Foundation, Inc.
Copyright (C) 2010-2015 Free Software Foundation, Inc.
Copyright 1992-2019 Free Software Foundation, Inc.
Copyright (C) 2014 Free Software Foundation, Inc.
Copyright (C) 2011 Free Software Foundation, Inc.
Copyright (c) 2006-2007 xine project

Copyright either version 2, or (at your option) dnl any later version.
Copyright (C) 2012 Free Software Foundation, Inc.
Copyright (C) 2002-2018 Free Software Foundation, Inc.
Copyright (C) 2001-2018 Free Software Foundation, Inc.
Copyright (C) 1997-2018 Free Software Foundation, Inc.
Copyright (C) 1999-2018 Free Software Foundation, Inc.
Copyright (C) 1996-2018 Free Software Foundation, Inc.
Copyright (C) 2003-2018 Free Software Foundation, Inc.
Copyright (C) 2009-2018 Free Software Foundation, Inc.
Copyright (C) 2006-2018 Free Software Foundation, Inc.
Copyright (C) 2004-2018 Free Software Foundation, Inc.
Copyright © 2004 Scott James Remnant <scott@netsplit.com>.
Copyright © 2012-2015 Dan Nicholson <dbn.lists@gmail.com>
Copyright (c) 2006-2007 Diego Petten <flameeyes@gmail.com>
Copyright (C) 1996-2001, 2003-2015 Free Software Foundation, Inc. Written by Gordon Matzigeit, 1996
Copyright (C) 2004-2005, 2007-2009, 2011-2015 Free Software Foundation, Inc. Written by Gary V. Vaughan, 2004
Copyright (C) 2004-2005, 2007-2008, 2011-2015 Free Software Foundation, Inc. Written by Gary V. Vaughan, 2004
Copyright (C) 2004, 2011-2015 Free Software Foundation, Inc. Written by Scott James Remnant, 2004
Copyright (C) 2004-2005, 2007, 2009, 2011-2015 Free Software Foundation, Inc. Written by Scott James Remnant, 2004.
Copyright (C) 1994 X Consortium
Copyright (C) 1996-2015 Free Software Foundation, Inc.
Copyright (C) 1999-2018 Free Software Foundation, Inc. Written by Tom Tromeey <tromeey@cygnus.com>.
Copyright 1992-2019 Free Software Foundation, Inc.
Copyright (C) 1999-2018 Free Software Foundation, Inc.
Copyright (C) 2004-2005, 2007, 2009, 2011-2015 Free Software Foundation, Inc. Written by Scott James Remnant, 2004.
Copyright (C) 2004, 2011-2015 Free Software Foundation, Inc. Written by Scott James Remnant, 2004
Copyright (C) 1996-2001, 2003-2015 Free Software Foundation, Inc. Written by Gordon Matzigeit, 1996
Copyright (C) 2004-2005, 2007-2008, 2011-2015 Free Software Foundation, Inc. Written by Gary V. Vaughan, 2004
Copyright (C) 2004-2005, 2007-2009, 2011-2015 Free Software Foundation, Inc. Written by Gary V. Vaughan, 2004
Copyright (C) 1996-2018 Free Software Foundation, Inc. Originally written by Fran,cois Pinard <pinard@iro.umontreal.ca>, 1996.
Copyright (C) 1989, 1991 Free Software Foundation, Inc.
Copyright (C) 2010-2018 Free Software Foundation, Inc. Written by Peter Rosin <peda@lysator.liu.se>.
Copyright (C) 1996-2018 Free Software Foundation, Inc.
Copyright (c) 2011 Patrick McHardy <kaber@trash.net>
Copyright (C) 2007 BalaBit IT Ltd.
Copyright (c) 2010-2013 Patrick McHardy <kaber@trash.net>
Copyright (C) 1996-2018 Free Software Foundation, Inc.
(C) 2000 by Harald Welte <laforge@gnumonks.org>
Copyright (C) 2006 Red Hat, Inc., James Morris <jmorris@redhat.com>
Copyright (C) 1992-1996, 1998-2012 Free Software Foundation, Inc.
Copyright (c) 2000-2001 Netfilter Core Team
(C) 2001 Marc Boucher (marc@mbsi.ca).
Copyright (c) 2000 Netfilter Core Team
Copyright © CC Computer Consultants GmbH, 2007 Contact: Jan Engelhardt <jengelh@computerghmbh.de>
Copyright (c) 2012-2013 Patrick McHardy <kaber@trash.net>
Copyright (C) 1994-2018 Free Software Foundation, Inc.
Copyright (c) 2000-2001 Netfilter Core Team
(C) 2003-2004 by Harald Welte <laforge@netfilter.org>;© Eychemne <rv@wallfire.org>
(C) 2013 by Pablo Neira Ayuso <pablo@netfilter.org>;(C) 2013 by Giuseppe Longo <giuseppelng@gmail.com>
(C) 2014 by Giuseppe Longo <giuseppelng@gmail.com>
(C) 2002,2004 MARA Systems AB <http://www.marasystems.com> by Henrik Nordstrom <hno@marasystems.com>
(C) 2000-2002 by the netfilter coreteam <coreteam@netfilter.org>; Paul 'Rusty' Russell <rusty@rustcorp.com.au>
Marc Boucher <marc+nf@mbsi.ca> James Morris <jmorris@intercode.com.au> Harald Welte <laforge@gnumonks.org> Jozsef Kadlecik <kadlec@blackhole.kf

LICENCE TERMS (cont.)

(C) 2002 by Don Cohen <don-netf@isis.cs3-inc.com>
(C) 2012-2013 by Pablo Neira Ayuso <pablo@netfilter.org>
(C) 2012-2013 by Pablo Neira Ayuso <pablo@netfilter.org>;(C) 2013 by Tomasz Bursztyka <tomasz.bursztyka@linux.intel.com>
Copyright © CC Computer Consultants GmbH, 2007 Contact: Jan Engelhardt <jengelh@medozas.de>
Copyright (c) 2003-2013 Patrick McHardy <kaber@trash.net>
Copyright © Martin F. Krafft <madduck@madduck.net>
Copyright (c) 2007 Sven Schnelle <svens@bitebene.org>
(C) Copyright 2018, Arturo Borrero Gonzalez <arturo@netfilter.org>
(C) 2002 by Harald Welte <laforge@gnumonks.org>
(C) 2012 by Pablo Neira Ayuso <pablo@netfilter.org>
Copyright (c) 2006-2013 Patrick McHardy <kaber@trash.net>
(C) 2000-2002 by Harald Welte <laforge@gnumonks.org> based on previous code from Rusty Russell <rusty@linuxcare.com.au>
(C) 2002 by Harald Welte <laforge@netfilter.org>;(C) 2011 by Patrick McHardy <kaber@trash.net>
(C) 2012-2014 by Pablo Neira Ayuso <pablo@netfilter.org>;(C) 2013 by Tomasz Bursztyka <tomasz.bursztyka@linux.intel.com>
Copyright (c) 2008-2013 Patrick McHardy <kaber@trash.net>
(C) 2003 by Harald Welte <laforge@gnumonks.org>
(C) 2014 by Pablo Neira Ayuso <pablo@netfilter.org>;(c) 2014 by Pablo Neira Ayuso <pablo@netfilter.org>
copyright by Martin F. Krafft. PP This manual page was written by Martin F. Krafft <madduck@madduck.net>
Copyright Google, Inc.
(C) 1999 by Paul 'Rusty' Russell <rusty@rustcorp.com.au> and;(C) 2000-2002 by Harald Welte <laforge@gnumonks.org>
Copyright (C) 2010 Nokia Corporation. All rights reserved.
(C) 2010-2011, Thomas Graf <tgraf@redhat.com>;(C) 2010-2011, Red Hat, Inc.
(C) 2011 by Pablo Neira Ayuso <pablo@netfilter.org>;(C) 2011 by Intra2Net AG <http://www.intra2net.com>
Copyright © CC Computer Consultants GmbH, 2007 - 2008 Jan Engelhardt <jengelh@computergmbh.de>
Copyright (c) 2005-2013 Patrick McHardy <kaber@trash.net>
(C) 2002 by Harald Welte <laforge@gnumonks.org>;(C) 2010 by Red Hat, Inc Author: Michael S. Tsirkin <mst@redhat.com>
(C) 2000-2002 by the netfilter coreteam <coreteam@netfilter.org>; Paul 'Rusty' Russell <rusty@rustcorp.com.au>
Marc Boucher <marc+nf@mbsi.ca> James Morris <jmorris@intercode.com.au> Harald Welte <laforge@gnumonks.org>
Jozsef Kadlecsek <kadlec@blackhole.kfki.hu>
(C) 2006 Ufo Mechanic <azez@ufomechanic.net>;(C) 2000-2002 by Harald Welte <laforge@gnumonks.org> based on previous code from Rusty Russell <rusty@linuxcare.com.au>
(C) 2012 by Hans Schillstrom <hans.schillstrom@ericsson.com>;(C) 2012 by Pablo Neira Ayuso <pablo@netfilter.org>
Copyright (C) 2000-2002 Joakim Axelsson <gozem@linux.nu> Patrick Schaaf <bof@bof.de> Martin Josefsson <gandalf@wlug.westbo.se>
Copyright (C) 1999 Paul 'Rusty' Russell & Michael J. Neuling
(C) 1999 by Paul 'Rusty' Russell <rusty@rustcorp.com.au> and;(C) 2000-2002 by Harald Welte <laforge@gnumonks.org>;(C) 2012 by Pablo Neira Ayuso <pablo@netfilter.org>
Copyright 2006 UfoMechanic Author: azez@ufomechanic.net
(C) Copyright 2016-2017, Arturo Borrero Gonzalez <arturo@netfilter.org>
(C) 2009 by Pablo Neira Ayuso <pablo@netfilter.org>
(C) 2000 by Harald Welte <laforge@gnumonks.org>
(C) 2000 James Morris
(C) 2000 by Harald Welte <laforge@netfilter.org>
(C) Copyright 2000-2003 by Michal Zalewski <lcamtuf@coredump.cx>;(C) Copyright 2003 by Mike Frantzen <frantzen@w4g.org>
(C) 2000-2002 by Harald Welte <laforge@gnumonks.org>
Copyright (c) 2005 Evgeniy Polyakov <johnpol@2ka.mxt.ru>
Copyright (c) 2003+ Evgeniy Polyakov <johnpol@2ka.mxt.ru>
Copyright (c) 2013 Patrick McHardy <kaber@trash.net>
Copyright (C) 2004, 2010 Nokia Corporation Written by Timo Teras <ext-timo.teras@nokia.com>
(C) 2002 Harald Welte <laforge@gnumonks.org>;(C) 2000 by Matthew G. Marsh <mgm@paktronix.com>

Copyright (C) 2011 Free Software Foundation, Inc.
(C) 2005 Harald Welte <laforge@netfilter.org>
(C) 2002 Harald Welte <laforge@gnumonks.org>
(C) 2002 Harald Welte <laforge@netfilter.org>
(C) 2010-2011 Thomas Graf <tgraf@redhat.com>;(C) 2010-2011 Red Hat, Inc.
Copyright (C) 2002,2004 MARA Systems AB <http://www.marasystems.com> by Henrik Nordstrom <hno@marasystems.com>
Copyright (c) 2009 Mike Frysinger <vapier@gentoo.org>
(C) 2002 by Harald Welte <laforge@gnumonks.org>;(C) 2010 Red Hat Inc Author: Michael S. Tsirkin <mst@redhat.com>
(C) 1999 Paul ``Rusty" Russell - Placed under the GNU GPL (See COPYING for details.);(C) 2000-2004 by the Netfilter Core Team <coreteam@netfilter.org>
(C) 2001 Marc Boucher (marc@mbsi.ca).
Copyright © Jan Engelhardt, 2011
(C) 2000-2006 by the netfilter coreteam <coreteam@netfilter.org>:
Copyright (C) 2000 Emmanuel Roger <winfield@freegates.be>
(C) 2005 by Harald Welte <laforge@netfilter.org>
Copyright (c) 2000 Marc Boucher
Copyright © CC Computer Consultants GmbH, 2007 Contact: <jengelh@computergmbh.de>
© Eychenne <rv@wallfire.org>
(C) 2008 Adam Nielsen <a.nielsen@shikadi.net>
(C) 2004, Bart De Schuymer <bdschuym@pandora.be>
Copyright (C) 2002-2008 BalaBit IT Ltd.
(C) 2000 Jozsef Kadlecsek <kadlec@blackhole.kfki.hu>
Copyright (c) 2003+ Evgeniy Polyakov <zbr@ioremap.net>
Copyright (C)2006 USAGI/WIDE Project
(C) 2000- 2002 by Matthew G. Marsh <mgm@paktronix.com>, Harald Welte <laforge@gnumonks.org>
Copyright © Sebastian Claßen <sebastian.classen[at]freenet.ag>, 2007 Jan Engelhardt <jengelh[at]medozas.de>, 2007 - 2010
Copyright (C) 2004-2015 Free Software Foundation, Inc.
Copyright (C) 2010-2015 Free Software Foundation, Inc.
Copyright 1992-2019 Free Software Foundation, Inc.
Copyright (C) 2014 Free Software Foundation, Inc.
Copyright (C) 2011 Free Software Foundation, Inc.
Copyright (C) 2002-2018 Free Software Foundation, Inc.
Copyright (C) 2011-2018 Free Software Foundation, Inc.
Copyright (C) 2001-2018 Free Software Foundation, Inc.
Copyright (C) 1997-2018 Free Software Foundation, Inc.
Copyright (C) 1999-2018 Free Software Foundation, Inc.
Copyright (C) 1996-2018 Free Software Foundation, Inc.
Copyright (C) 2003-2018 Free Software Foundation, Inc.
Copyright (C) 1998-2018 Free Software Foundation, Inc.
Copyright (C) 2009-2018 Free Software Foundation, Inc.
Copyright (C) 2006-2018 Free Software Foundation, Inc.
Copyright (C) 2004-2018 Free Software Foundation, Inc.
Copyright © 2004 Scott James Remnant <scott@netsplit.com>.
Copyright © 2012-2015 Dan Nicholson <dbn.lists@gmail.com>
Copyright (c) 2009 Mike Frysinger <vapier@gentoo.org>
Copyright (c) 2009 Steven G. Johnson <stevenj@alum.mit.edu>
Copyright (c) 2009 Matteo Frigo
Copyright (C) 1996-2001, 2003-2015 Free Software Foundation, Inc. Written by Gordon Matzigkeit, 1996
Copyright (C) 2014 Free Software Foundation, Inc.
Copyright (C) 2011 Free Software Foundation, Inc.
Copyright (C) 2004-2005, 2007-2009, 2011-2015 Free Software Foundation, Inc. Written by Gary V. Vaughan, 2004
Copyright (C) 2004-2005, 2007-2008, 2011-2015 Free Software Foundation, Inc. Written by Gary V. Vaughan, 2004
Copyright (C) 2004, 2011-2015 Free Software Foundation, Inc. Written by Scott James Remnant, 2004
Copyright (C) 2004-2005, 2007, 2009, 2011-2015 Free Software Foundation, Inc. Written by Scott James Remnant,

LICENCE TERMS (cont.)

2004.

Copyright (C) 2002-2018 Free Software Foundation, Inc.
Copyright (C) 2011-2018 Free Software Foundation, Inc.
Copyright (C) 2001-2018 Free Software Foundation, Inc.
Copyright (C) 1997-2018 Free Software Foundation, Inc.
Copyright (C) 1999-2018 Free Software Foundation, Inc.
Copyright (C) 1996-2018 Free Software Foundation, Inc.
Copyright (C) 2003-2018 Free Software Foundation, Inc.
Copyright (C) 1998-2018 Free Software Foundation, Inc.
Copyright (C) 2009-2018 Free Software Foundation, Inc.
Copyright (C) 2006-2018 Free Software Foundation, Inc.
Copyright (C) 2004-2018 Free Software Foundation, Inc.
Copyright © 2004 Scott James Remnant <scott@netsplit.com>.
Copyright © 2012-2015 Dan Nicholson <dbn.lists@gmail.com>
Copyright either version 2 of the License, or dnl (at your option)
Copyright (c) 2009 Mike Frysinger <vapier@gentoo.org>
Copyright (c) 2009 Steven G. Johnson <stevenj@alum.mit.edu>
Copyright (c) 2009 Matteo Frigo
Copyright (C) 1996-2001, 2003-2015 Free Software Foundation, Inc. Written by Gordon Matzigkeit, 1996
Copyright (C) 2004-2005, 2007-2009, 2011-2015 Free Software Foundation, Inc. Written by Gary V. Vaughan, 2004
Copyright (C) 2004-2005, 2007-2008, 2011-2015 Free Software Foundation, Inc. Written by Gary V. Vaughan, 2004
Copyright (C) 2004, 2011-2015 Free Software Foundation, Inc. Written by Scott James Remnant, 2004
Copyright (C) 2004-2005, 2007, 2009, 2011-2015 Free Software Foundation, Inc. Written by Scott James Remnant, 2004.
Copyright (C) 2012 Free Software Foundation, Inc.
Copyright (C) 2012 Free Software Foundation, Inc.
Copyright (c) 2000-2001 Netfilter Core Team.
Copyright (c) 2000-2001 Netfilter Core Team.
Copyright © CC Computer Consultants GmbH, 2007 - 2008 Jan Engelhardt <jengelh@computergmbh.de>
Copyright (c) 2000-2001 Netfilter Core Team.
Copyright © CC Computer Consultants GmbH, 2007 Contact: <jengelh@computergmbh.de>
Copyright © CC Computer Consultants GmbH, 2007 Jan Engelhardt <jengelh@computergmbh.de>
Copyright (C) 2003-2010 Jozsef Kadlecsek <kadlec@blackhole.kfki.hu>
Copyright (C) 2003-2011 Jozsef Kadlecsek <kadlec@blackhole.kfki.hu>
"Copyright (c) 2007, 2008 Johannes Berg; Copyright (c) 2007 Andy Lutomirski; Copyright (c) 2007 Mike Kershaw; Copyright (c) 2008-2009 Luis R. Rodriguez"
Copyright 2006-2010 Johannes Berg <johannes@sipsolutions.net>
Copyright (C) 2004, 2007 The Linux Foundation and its contributors.
"Copyright 2007, 2008 Johannes Berg <johannes@sipsolutions.net>"
Copyright 2008 Michael Wu <flamingice@sourmilk.net>
Copyright 2008 Luis Carlos Cobo <luisca@cozybit.com>
Copyright 2008 Michael Buesch <m@bues.ch>
Copyright 2008, 2009 Luis R. Rodriguez <lrodriguez@atheros.com>
Copyright 2008 Jouni Malinen <jouni.malinen@atheros.com>
Copyright 2008 Colin McCabe <colin@cozybit.com>
"Copyright 2015-2017 Intel Deutschland GmbH"
Copyright (C) 2018-2019 Intel Corporation
Copyright (C) 1994 X Consortium
Copyright (C) 1996-2015 Free Software Foundation, Inc. This is free software
Copyright (C) 1999-2018 Free Software Foundation, Inc. Written by Tom Tromeey <tromeey@cygnus.com>.
Copyright 1992-2019 Free Software Foundation, Inc.
Copyright (C) 1999-2018 Free Software Foundation, Inc.
Copyright (C) 2004-2005, 2007, 2009, 2011-2015 Free Software Foundation, Inc. Written by Scott James Remnant, 2004.
Copyright (C) 2004, 2011-2015 Free Software Foundation, Inc. Written by Scott James Remnant, 2004
Copyright (C) 1996-2001, 2003-2015 Free Software Foundation, Inc. Written by Gordon Matzigkeit, 1996
Copyright (C) 2004-2005, 2007-2008, 2011-2015 Free Software Foundation, Inc. Written by Gary V. Vaughan, 2004

Copyright (C) 2004-2005, 2007-2009, 2011-2015 Free Software Foundation, Inc. Written by Gary V. Vaughan, 2004
Copyright (C) 1996-2018 Free Software Foundation, Inc. Originally written by Fran.cois Pinard <pinard@iro.umontreal.ca>, 1996.
Copyright (C) 2011-2018 Free Software Foundation, Inc.
Copyright (C) 1995-1997, 2000-2007, 2009-2010 by Ulrich Drepper <drepper@gnu.ai.mit.edu>
Copyright 1996-2016 Free Software Foundation, Inc. Taken from GNU libtool, 2001 Originally by Gordon Matzigkeit <gord@gnu.ai.mit.edu>, 1996
Copyright (C) 1994-1996, 1999-2002, 2004-2016 Free Software Foundation, Inc.
Copyright (C) 2010-2018 Free Software Foundation, Inc. Written by Peter Rosin <peda@lysator.liu.se>.
Copyright (C) 1992 Rickard E. Faith.
Copyright (C) 1996-2018 Free Software Foundation, Inc.
(c) copyright by Jan Kasprzak (kas@ics.muni.cz) You can distribute this file under the terms of GNU General Public License (GPL). See the file COPYING.
(c) copyright by Jan Ondrej (ondrej@salstar.shadow.sk) You can distribute this file under the terms of GNU General Public License (GPL). See the file COPYING.
Copyright (c) 2007 Jochen Kuhnle <jochenk@users.sourceforge.net>
Copyright (C) 1992-1996, 1998-2012 Free Software Foundation, Inc.
Copyright (c) 1997, 1998 Guylhem Aznar <guylhem@oeil.qc.ca>
Copyright (C) 1994-2018 Free Software Foundation, Inc.
Copyright 1996-2003 Free Software Foundation, Inc. Taken from GNU libtool, 2001 Originally by Gordon Matzigkeit <gord@gnu.ai.mit.edu>, 1996
Copyright (C) 1996-2018 Free Software Foundation, Inc.
Copyright (c) 2006-2008 Diego Petten <flameeyes@gmail.com>
Copyright (c) 1995-1998 S.u.S.E. GmbH Fuerth, Germany.
Copyright (C) 1994, 1995, 1996, 1997, 1998, 1999, 2000, 2001, 2002, 2003, 2004, 2005, 2006, 2007, 2008, 2009, 2010, 2011 Free Software Foundation, Inc. This Makefile.in is free software; the Free Software Foundation gives unlimited permission to copy and/or distribute it, with or without m
Copyright (C) Nilgün Belma Bugüner Nilgün Belma Bugüner <nilgun@superonline.com>, 2002
Copyright (c) 2009 John Resig Dual licensed under the MIT and GPL licenses. <http://docs.jquery.com/License>
Copyright 2003 Alastair McKinstry <mckinstry@computer.org>
Copyright (C) 1993 Eugene G. Crosser br crosser@pccross.msk.su>
(c) 2001 Bernhard Rosenkränzer <bero@arklinux.org>
Copyright 1992, 1994 Rickard E. Faith (faith@cs.unc.edu) May be distributed under the GNU General Public License Updated Wed Jun 22 21:09:43 1994, faith@cs.unc.edu
Copyright (C) 2010, 2011, 2012, 2014, 2016 Free Software Foundation, Inc. Alexey Gladkov <gladkov.alexey@gmail.com>, 2010. Felipe Castro <fefcas@gmail.com>, 2010, 2011, 2012, 2014, 2016.
Copyright (C) 2002 Nils Naumann;(C) 2008 Michael Schutte This file is distributed under the same license as the kbd package. Jarod Wang <jarodwang.cn@gmail.com>, 2008. Mingye Wang <arthur200126@gmail.com>, 2015.
Copyright (C) 2003 Free Software Foundation This file is distributed under the same license as the PACKAGE package. Lefteris Dimitroulakis <edimitro@tee.gr>, 2003.
Copyright (C) 2010 Alexey Gladkov <gladkov.alexey@gmail.com>
Copyright (C) 2010 Alexey Gladkov <gladkov.alexey@gmail.com> . Sergio Zanchetta <primes2h@ubuntu.com>, 2010, 2011
Copyright © 2015 Free Software Foundation, Inc.
Copyright (C) 2008 Arif E. Nugroho <arif_endro@yahoo.com>. Arif E. Nugroho <arif_endro@yahoo.com>, 2008, 2009, 2010.
Copyright (C) 2002 Nils Naumann;(C) 2008 Michael Schutte . Nils Naumann <naumann@epost.de>, 2002, 2004. Michael Schutte <m.schutte.jr@gmail.com>, 2008, 2009, 2011. Mario Blättermann <mario.blaettermann@gmail.com>, 2014-2016.
Copyright (C) 2012-2013 Alexey Gladkov <gladkov.alexey@gmail.com>
Copyright (C) 2014 Alexey Gladkov <gladkov.alexey@gmail.com>
Copyright (C) 1984, 1989-1990, 2000-2015 Free Software Foundation, Inc.
Copyright (C) 1993 Risto Kankkunen.
Copyright (C) 1999 Andries E. Brouwer derived from sources that were
Copyright (C) 2002 Dmitry V. Levin <ldv@altlinux.org>
Copyright (C) 1994-1998 Michael K. Johnson <johnsonm@redhat.com>
Copyright (C) 1997-1998 Juan Cespedes <cespedes@debian.org>

LICENCE TERMS (cont.)

Copyright (C) 2002, 2005 Dmitry V. Levin <ldv@altlinux.org>
Copyright 1996 Derrick J Brashear.
Copyright 1994 Roman Hodek
Copyright (C) 1996 Dominik Kubla, <dominik@debian.org>
Copyright (C) 2011 Vitezslav Crhonek, <vcrhonek@redhat.com>
Copyright (C) 2004-2015 Free Software Foundation, Inc. This is free software
Copyright (C) 2010-2015 Free Software Foundation, Inc. This is free software
Copyright 1992-2019 Free Software Foundation, Inc.
Copyright (C) 2014 Free Software Foundation, Inc. This is free software
Copyright (C) 2011 Free Software Foundation, Inc. This config.lt script is free software
Copyright (C) 1993 Risto Kankkunen.
Copyright (C) 1993 Eugene G. Crosser.
Copyright (C) 1994 H. Peter Anvin.
Copyright (C) 1994-1999 Andries E. Brouwer.
Copyright (C) 1994 by Jon Tombs <jon@gtex02.us.es> portions also authors: Andries E. Brouwer <aeb@cwil.nl>
Joshua Spoerri <josh@cooper.edu> Chuck Martin <cmartin@bigfoot.com> Alexey Gladkov <gladkov.alexey@gmail.com>
Copyright (C) 2011 Alexey Gladkov.
Copyright (C) 2011 Alexey Gladkov,
Copyright (C) 2011 Canonical Ltd. Authors: Seth Forshee <seth.forshee@canonical.com> Dustin Kirkland <kirkland@canonical.com>
Copyright (C) 1994-1998 Michael K. Johnson <johnsonm@redhat.com>
Copyright (C) 2002-2006 Dmitry V. Levin <ldv@altlinux.org>
Copyright (C) 2002-2018 Free Software Foundation, Inc.
Copyright (C) 2011-2018 Free Software Foundation, Inc.
Copyright (C) 2001-2018 Free Software Foundation, Inc.
Copyright (C) 1997-2018 Free Software Foundation, Inc.
Copyright (C) 1999-2018 Free Software Foundation, Inc.
Copyright (C) 1996-2018 Free Software Foundation, Inc.
Copyright (C) 2003-2018 Free Software Foundation, Inc.
Copyright (C) 2009-2018 Free Software Foundation, Inc.
Copyright (C) 2006-2018 Free Software Foundation, Inc.
Copyright (C) 2004-2018 Free Software Foundation, Inc.
Copyright (C) 1995-2014, 2016 Free Software Foundation, Inc. dnl This file is free software
Copyright (C) 2000-2002, 2007-2014, 2016 Free Software Foundation, Inc. dnl This file is free software
Copyright (C) 2004-2014, 2016 Free Software Foundation, Inc. dnl This file is free software
Copyright (C) 1996-2003, 2009-2016 Free Software Foundation, Inc. dnl This file is free software
Copyright (C) 2001-2016 Free Software Foundation, Inc. dnl This file is free software
Copyright (C) 2001-2005, 2008-2016 Free Software Foundation, Inc. dnl This file is free software
Copyright (C) 1995-2003, 2005-2006, 2008-2014, 2016 Free Software dnl Foundation, Inc. dnl This file is free software
Copyright © 2004 Scott James Remnant <scott@netsplit.com>.
Copyright © 2012-2015 Dan Nicholson <dbn.lists@gmail.com> dnl This program is free software
Copyright (C) 1996-2003, 2005, 2008-2016 Free Software Foundation, Inc. dnl This file is free software
Copyright (c) 2006-2008 Diego Petten <flameeyes@gmail.com>
Copyright (c) 2006-2008 xine project dnl dnl This program is free software
Copyright (C) 1996-2001, 2003-2015 Free Software Foundation, Inc. Written by Gordon Matzigkeit, 1996
Copyright (C) 2014 Free Software Foundation, Inc. This is free software
Copyright (C) 2011 Free Software Foundation, Inc. This config.lt script is free software
Copyright (C) 2004-2005, 2007-2009, 2011-2015 Free Software Foundation, Inc. Written by Gary V. Vaughan, 2004
Copyright (C) 2004-2005, 2007-2008, 2011-2015 Free Software Foundation, Inc. Written by Gary V. Vaughan, 2004
Copyright (C) 2004, 2011-2015 Free Software Foundation, Inc. Written by Scott James Remnant, 2004
Copyright (C) 2004-2005, 2007, 2009, 2011-2015 Free Software Foundation, Inc. Written by Scott James Remnant, 2004.
Copyright (C) 2002-2018 Free Software Foundation, Inc.
Copyright (C) 2011-2018 Free Software Foundation, Inc.
Copyright (C) 2001-2018 Free Software Foundation, Inc.

Copyright (C) 1997-2018 Free Software Foundation, Inc.
Copyright (C) 1999-2018 Free Software Foundation, Inc.
Copyright (C) 1996-2018 Free Software Foundation, Inc.
Copyright (C) 2003-2018 Free Software Foundation, Inc.
Copyright (C) 2009-2018 Free Software Foundation, Inc.
Copyright (C) 2006-2018 Free Software Foundation, Inc.
Copyright (C) 2004-2018 Free Software Foundation, Inc.
Copyright (C) 1995-2014, 2016 Free Software Foundation, Inc.
Copyright (C) 2000-2002, 2007-2014, 2016 Free Software Foundation, Inc.
Copyright (C) 2004-2014, 2016 Free Software Foundation, Inc.
Copyright (C) 1996-2003, 2009-2016 Free Software Foundation, Inc.
Copyright (C) 2001-2016 Free Software Foundation, Inc.
Copyright (C) 2001-2005, 2008-2016 Free Software Foundation, Inc.
Copyright (C) 1995-2003, 2005-2006, 2008-2014, 2016 Free Software dnl Foundation, Inc.
Copyright © 2004 Scott James Remnant <scott@netsplit.com>.
Copyright © 2012-2015 Dan Nicholson <dbn.lists@gmail.com>
Copyright (C) 1996-2003, 2005, 2008-2016 Free Software Foundation, Inc.
Copyright (c) 2006-2008 Diego Petten <flameeyes@gmail.com>
Copyright (c) 2006-2008 xine project dnl dnl This program is free software
Copyright (C) 1996-2001, 2003-2015 Free Software Foundation, Inc. Written by Gordon Matzigkeit, 1996
Copyright (C) 2004-2005, 2007-2009, 2011-2015 Free Software Foundation, Inc. Written by Gary V. Vaughan, 2004
Copyright (C) 2004-2005, 2007-2008, 2011-2015 Free Software Foundation, Inc. Written by Gary V. Vaughan, 2004
Copyright (C) 2004, 2011-2015 Free Software Foundation, Inc. Written by Scott James Remnant, 2004
Copyright (C) 2004-2005, 2007, 2009, 2011-2015 Free Software Foundation, Inc. Written by Scott James Remnant, 2004.
Copyright (C) 2012 Free Software Foundation, Inc. This config.status script is free software
Copyright (C) 2012 Free Software Foundation, Inc. This configure script is free software
Copyright (C) 2012 Free Software Foundation, Inc. This config.status script is free software
Copyright (c) 1997 Pierre-Charles David <pcdavid @ club-internet.fr>
Copyright (c) 1997 Pierre-Charles David <pcdavid @ club-internet.fr>
Copyright (c) 1993-2001 by Andries Brouwer.
Copyright (C) 2006 Dimitar Toshkov Zhekov. Report bugs to <jimmy@is-vn.bg>
Copyright (C) 1994-2007 Andries E. Brouwer.
Copyright (C) 2007-2013 Alexey Gladkov <gladkov.alexey@gmail.com>
Copyright (C) 2007-2012 Alexey Gladkov <gladkov.alexey@gmail.com>
Copyright (C) 1994 H. Peter Anvin
Copyright (C) 2002, 2005 Dmitry V. Levin <ldv@altlinux.org>
Copyright (C) 2002, 2004, 2006 Dmitry V. Levin <ldv@altlinux.org>
Copyright (C) 2002, 2005, 2013 Dmitry V. Levin <ldv@altlinux.org>
Copyright (C) 2002, 2004, 2005 Dmitry V. Levin <ldv@altlinux.org>
Copyright (c) 2006, 2008 Junio C Hamano
Copyright (c) 2016 Chen-Yu Tsai. All rights reserved.
Copyright (C) 2008 Matt Fleming <matt@console-pimps.org>
Copyright IBM Corp. 2019 Author(s): Joerg Schmidbauer (jschmidb@de.ibm.com)
Copyright (c) 2016 IBM Corporation.
Copyright(C) 1995 Linus Torvalds
Copyright: (C) 2013 Petr Strnad. URL: http://coccinelle.lip6.fr/
Copyright 2009 - 2010 DENX Software Engineering. Anatolij Gustschin <agust@denx.de>
Copyright (C) 2005-2010,2012 Freescale Semiconductor, Inc.
Copyright (c) 2013 Jiri Pirko <jiri@resnulli.us>
Copyright (c) 2017 Microchip Technology
Copyright (C) 2010 Marvell International Ltd. Sachin Sanap <ssanap@marvell.com> Zhangfei Gao <zgao6@marvell.com> Philip Rakity <prakity@marvell.com> Mark Brown <markb@marvell.com>
Copyright (c) 2018 MediaTek Inc. Author: Shunli Wang <shunli.wang@mediatek.com>
Copyright (C) 2008,2009, Steven Rostedt <srostedt@redhat.com>
Copyright (c) 2011-2014 Samsung Electronics Co., Ltd. http://www.samsung.com;(c) 2008 Simtec Electronics
Copyright (c) 2010 Mika Westerberg

LICENCE TERMS (cont.)

Copyright (C) 2011 Thomas Chou <thomas@wytron.com.tw>
Copyright (C) 2011, 2013 Renesas Solutions Corp.
Copyright (C) 2017 Linus Walleij <linus.walleij@linaro.org>
Copyright (C) 2010 Texas Instruments, Inc.
(c) 2005 Chris Pascoe <c.pascoe@itee.uq.edu.au>
Copyright (c) 2000-2008 The Regents of the University of Michigan. All rights reserved.
Copyright (C) 2008 Felix Fietkau <nbd@openwrt.org>
Copyright 2012 DENX Software Engineering, GmbH.
Copyright (c) Trond Myklebust
Copyright © 2011, Picochip.
Copyright (c) 2011 The Chromium OS Authors. All rights reserved.:(C) Copyright 2007 Gerald Van Baren, Custom IDEAS, vanbaren@cideas.com Based on code written by: Pantelis Antoniou <pantelis.antoniou@gmail.com> and Matthew McClintock <msm@freescale.com>
Copyright (c) 2007 SUSE Linux Products GmbH
Copyright (C) 1998 Randy Gobbel.
(C) Copyright 2001, Lineo Inc. (www.lineo.com)
Copyright(c) 2007 - 2009 Intel Corporation. All rights reserved.
Copyright (C) 2014-2015 Renesas Electronics Corporation
Copyright (C) 2008 Advanced Micro Devices, Inc.
Copyright (C) 2019 Linaro Ltd <ard.biesheuvel@linaro.org>
(C) 2001 Red Hat, Inc.
Copyright (c) 1998 Daniel Pirkl <daniel.pirkl@email.cz> Charles University, Faculty of Mathematics and Physics
Copyright (C) 1996 Adrian Rodriguez (adrian@franklins-tower.rutgers.edu) Laboratory for Computer Science Research Computing Facility Rutgers, The State University of New Jersey
Copyright (c) 2004 Cisco Systems, Inc.
Copyright (C) 2010,2012 Freescale Semiconductor, Inc. All rights reserved.
Copyright (C) 2008-2011 Freescale Semiconductor, Inc. All rights reserved.
Copyright (c) 2009 Wolfgang Grandegger <wg@grandegger.com>
Copyright (C) 2018 Masami Hiramatsu <mhiramat@kernel.org>
Copyright (C) 2005 ARM Ltd
Copyright IBM Corp. 2018 Auxtrace support for s390 CPU-Measurement Sampling Facility
Copyright (C) 2001,...,2009 Davide Libenzi
Copyright 2020 NXP Semiconductors.
Copyright (C) 2008-2009 Ksplice, Inc. Author: Tim Abbott <tabbott@ksplice.com>
Copyright 2005 Dan Williams and Red Hat, Inc.
Copyright © 2000-2010 David Woodhouse <dwmw2@infradead.org>
Copyright (C) 2017 KUNBUS GmbH
Copyright(c) 2005-2006 Chris Humbert
Copyright (C) 2007 Magnus Damm
Copyright (c) 2001-2014 Anton Altaparmakov and Tuxera Inc.
Copyright (C) 2007-2015 STMicroelectronics Ltd
Copyright (C) 2017 Analog Devices Inc.
Copyright (C) 1996 David S. Miller (davem@davemloft.net)
Copyright(c) 2018 Intel Corporation.
Copyright 2015 Armadeus Systems
Copyright (C) 2013-2015 Altera Corporation
Copyright (c) 2016-2018, The Linux Foundation. All rights reserved.
Copyright 2010-2012 Solarflare Communications Inc.
Copyright (c) 2011 Heiko Stuebner <heiko@sntech.de>
Copyright (c) 2015-2018, Intel Corporation.
Copyright 2004-2005 Red Hat, Inc.
Copyright (C) 1997 Eddie C. Dost (ecd@skynet.be)
Copyright (C) 2016-2017 Texas Instruments Inc.
Copyright (c) 2004-2005, Keir Fraser
Copyright (C) 2017-18 Texas Instruments Incorporated - http://www.ti.com/
Copyright (c) 2004-2011 Atheros Communications Inc.
Copyright (C) 2010 ALPHAPROJECT Co.,Ltd.
Copyright (C) 2016 Freescale Semiconductor, Inc.
Copyright (C) 2010-2012 - NVIDIA, Inc.
(C) Copyright 1998 Linus Torvalds
Copyright (C) 2001 convergence integrated media GmbH
Copyright (C) 2010-2011 Jaiganesh Narayanan <jnarayanan@atheros.com>
Copyright (C) 2009 Samsung Electronics Minkyu Kang <mk7.kang@samsung.com>
Copyright (c) 2008 Nuovation System Designs, LLC Grant Erickson <gerickson@nuovations.com>
Copyright (C) 1999, 2000 Tim Waugh <tim@cyberelk.demon.co.uk>
Copyright 2013 Daniel Borkmann <borkmann@redhat.com>
Copyright (C) 2000-2001 Qualcomm Incorporated
Copyright (c) 1998,1999 by Takashi Iwai
Copyright (C) 2013 Samsung Electronics Co., Ltd. Author: Sylwester Nawrocki <s.nawrocki@samsung.com>
Copyright (C) 2006 Silicon Graphics, Inc., Christoph Lameter
Copyright (C) 2013 Regents of the University of California
Copyright 2006 Dave Airlie <airlied@linux.ie>
Copyright (c) 2018 Rockchip Electronics Co. Ltd.
Copyright (c) 2016 Thomas Graf <tgraf@tgraf.ch>
Copyright (C) 2013 Citrix Systems R&D Ltd.
Copyright 2014 - Hans de Goede <hdegoede@redhat.com>
Copyright (C) 2007 - 2010 Paul Mundt
Copyright (C) 2004-2006 Hyok S. Choi (hyok.choi@samsung.com)
Copyright 2002,2003 by Andi Kleen, SuSE Labs
Copyright (c) 2016, Linaro Ltd.
Copyright (C) 2006 Intel Corporation Inaky Perez-Gonzalez <inaky.perez-gonzalez@intel.com>
Copyright (c) 2014 Samsung Electronics Co., Ltd
Copyright (C) 2002 Daniel Vecino Castel <dvecino@able.es>
(C) 2005 Red Hat;(C) 2009-2010 Bartlomiej Zolnierkiewicz
Copyright (c) 2019, Linaro Ltd.
Copyright (C) 2014-2015 IT University of Copenhagen Initial release: Matias Bjorling <mb@lightnvm.io>
COPYRIGHT (c) 2008 The Regents of the University of Michigan ALL RIGHTS RESERVED
Copyright (C) 2010 Google, Inc.:(C) 2005 Nokia Corporation
Copyright (C) 2017 Hans de Goede <hdegoede@redhat.com>
Copyright (c) 2001-2006 Anton Altaparmakov
(C) 1997 Thomas Schoebel-Theuer, with heavy changes by Linus Torvalds
Copyright (C) 1994, 1996 Free Software Foundation, Inc.
Copyright (C) 2014 Gaël PORTAY <g.portay@overkiz.com>
Copyright (C) 2018 Exceet Electronics GmbH
Copyright (C) 2008 MaxLinear
Copyright (C) 2004 Embedded Edge, LLC <dan@embeddededge.com>
Copyright (C) 1998-2008 Novell/SUSE
Copyright (C) 2008 Freescale Semiconductor, Inc. All rights reserved.
Copyright (C) 2009-2010 Laurent Pinchart (laurent.pinchart@ideasonboard.com)
(c) 1999 David Huggins-Daines <dhd@debian.org>:(c) 1998 Gerd Knorr <kraxel@cs.tu-berlin.de>
Copyright (C) 2013 Noralf Trønnes
Copyright (c) 2013, Carlo Caione <carlo.caione@gmail.com>
Copyright (C) 2014-2016 Ricardo Ribalda, Qtechnology A/S
Copyright (C) 2016 - ARM Ltd. Author: Andre Przywara <andre.przywara@arm.com>
Copyright 2007 Oyvind Repvik
Copyright (C) 2013 Texas Instruments Incorporated - http://www.ti.com/ Author: Rajendra Nayak <mayak@ti.com>
Copyright (C) 2016 Mathieu Desnoyers <mathieu.desnoyers@efficios.com>
Copyright (c) Vaisala Oyj. All rights reserved.
Copyright 2017 IBM Corp.
Copyright © 2016-2018 Intel Corporation
"Copyright 2008-2009 Henrik Rydberg <rydberg@euromail.se>"
Copyright (c) 2017 Mellanox Technologies Inc. All rights reserved.
Copyright (C) 1998-2003 Paul Mackerras & Ben. Herrenschildt
Copyright (C) 2009 Jon Smirl, Digispeaker Author: Jon Smirl <jonsmirl@gmail.com>

LICENCE TERMS (cont.)

Copyright (C) 2011-2012 Texas Instruments Incorporated - <http://www.ti.com/> Author: J Keerthy <j-keerthy@ti.com>
Author: Moiz Sonasath <m-sonasath@ti.com> Couple of fixes, DT and MFD adaptation: Eduardo Valentin <eduardo.valentin@ti.com>
Copyright (C) 2012 Dialog Semiconductor Ltd.
"Copyright: (C) 2000, 2001 MontaVista Software Inc."
Copyright (c) 2016,2017 Daniel Mack
Copyright (C) 2010 Pengutronix, Marc Kleine-Budde <kernel@pengutronix.de>
Copyright 2013 Emilio López <emilio@elopez.com.ar>
Copyright (C) Fuzhou Rockchip Electronics Co.Ltd Zheng Yang <zhengyang@rock-chips.com> Yakir Yang <ykk@rock-chips.com>
Copyright (C) 2001 - 2007 Jeff Dike (jdike@{addtoit,linux.intel}.com)
Copyright (c) 2016 Heiko Stuebner <heiko@sntech.de>
Copyright (C) 2009 Paul Mundt
Copyright (c) 2020 Oracle Author: Matthew Wilcox <willy@infradead.org>
Copyright (c) 1995-2006, 2014, Ericsson AB
Copyright (c) 2007 by Silicon Motion, Inc. (SMI)
Copyright (c) 2015 Sabrina Dubroca <sd@queasysnail.net>
Copyright (c) 2008 Marvell Semiconductor
Copyright (C) 2018 MIPS Tech, LLC Author: Matt Redfearn <matt.redfearn@mips.com>
Copyright (C) 2001 Mark Langsdorf (mark.langsdorf@amd.com) based on sc520cdp.c by Sysgo Real-Time Solutions GmbH
Copyright (C) 2019 Topic Embedded Products Author: Mike Looijmans <mike.looijmans@topic.nl>
Copyright (c) 2012 Ondrej Zary
Copyright (c) 2012, 2017-2018, The Linux Foundation. All rights reserved.
Copyright 2019, Michael Ellerman, IBM Corp.
(C) 2007 Hans J. Koch <hjk@hansjoch.de>;(C) 2008 Manuel Traut <manut@linutronix.de>
Copyright (c) 2016 Linaro Limited.
"Copyright (C) 2001-2002 Greg Kroah-Hartman (greg@kroah.com)"
Copyright (C) 2009, 2012 Texas Instruments
Copyright (C) 2006 by Ralf Baechle (ralf@linux-mips.org)
Copyright 2014 Toradex AG
Copyright (C) 2010-2012 Synopsys, Inc. (www.synopsys.com)
Copyright (c) 2016, 2017 Andreas Klinger <ak@it-klinger.de>
Copyright (c) 2017 Covalent IO, Inc. <http://covalent.io>
Copyright 2015 Freescale, Inc. Tang Yuantian <Yuantian.Tang@freescale.com>
Copyright © 2008-2015 Intel Corporation
Copyright (c) 2006-2007, 2011-2012 Freescale Semiconductor, Inc.
Copyright (C) 2015 Topic Embedded Products
Copyright 1999 SuSE GmbH Nuernberg (Philipp Rumpf, prumpf@tux.org)
Copyright 2010,2011 Intel Corp. Author: Huang Ying <ying.huang@intel.com>
Copyright 2014 Cirrus Logic, Inc.
Copyright (c) Andrew Tridgell 1997-1998. Modified by Steve French (sfrench@us.ibm.com) 2002
Copyright (C) 2015
Copyright (C) 2001 - 2005 Tensilica Inc.
Copyright 1998-2008 VIA Technologies, Inc. All Rights Reserved.
Copyright (C) 2001 Dave Engebretsen IBM Corporation
Copyright (C) 2001 Russell King, All rights reserved.
Copyright (C) 2000, 2003 Brent Baccala <baccala@freesoft.org>
Copyright (C) 2017 Google, Inc. Author: Benson Leung <bleung@chromium.org>
Copyright (C) 2012 Avionic Design GmbH
Copyright (c) 2009 Tobias Lorenz <tobias.lorenz@gmx.net>
Copyright (C) 2018 Linus Wallej <linus.wallej@linaro.org> Includes portions of code from the firmware uploader by:
Copyright (C) 2014-15, Intel Corporation. Author:Rafal Redzimski <rafal.f.redzimski@intel.com> Jeeja KP <jeeja.kp@intel.com>
Copyright (C) 2013,2014 Fred Richter <frichter@hauppauge.com> based on lgdt3305.[ch] by Michael Krufky
Copyright (c) 2004 Topspin Communications. All rights reserved.
Copyright (C) 1996, Linus Torvalds

(C) Copyright IBM Corp. 2005;(C) Copyright 2006 TOSHIBA CORPORATION
Copyright 2009 Freescale Semiconductor, Inc. All Rights Reserved.
Copyright (C) 2017 NXP
Copyright (c) 2009 Intel Corporation
Copyright (C) 2015 Mans Rullgard <mans@mansr.com> SMP86xx/SMP87xx Watchdog driver
Copyright (c) by George Talusan <gstalusan@uwaterloo.ca> <http://www.undergrad.math.uwaterloo.ca/~gstalusa>
Copyright (C) 2000 Deep Blue Solutions Ltd
Copyright (C) 2008-2009 Michal Simek <monstr@monstr.eu>
Copyright 2013 Analog Devices Inc. Author: Lars-Peter Clausen <lars@metafoo.de>
Copyright (c) 2008 Ryan Mallon
Copyright IBM Corp. 2008
Copyright (C) 2007 PA Semi, Inc;(c) MontaVista Software, Inc.
Copyright (C) 2013 - 2014 Hans de Goede <hdegoede@redhat.com>
Copyright (C) 2009 Cory Maccarrone <darkstar6262@gmail.com>
Copyright 2004, 2007, 2008 Wolfson Microelectronics PLC. Author: Mark Brown <broonie@opensource.wolfsonmicro.com>
Copyright (c) 2017, Intel Corporation.
Copyright (C) 2017 Synopsys
Copyright (c) 2007 Freescale Semiconductor, Inc.
Copyright (c) 2013, Intel Corporation.
Copyright (C) 2014 Glider bvba
Copyright 2004-2005 AMD Author: AMD
Copyright (C) 2016 Lino Sanfilippo <LinoSanfilippo@gmx.de>
Copyright (C) 2005, 2009, 2010, 2011 Texas Instruments Incorporated Author: Thomas Charleux (thomas.charleux@jaluna.com)
Copyright(c) FUJITSU Limited 2008.
Copyright (C) 1995 - 1999 Ralf Baechle
Copyright (C) 2013, Intel Corporation Authors: Lan Tianyu <tianyu.lan@intel.com>
Copyright (C) STMicroelectronics 2019 Authors: Gabriel Fernandez <gabriel.fernandez@st.com> Pascal Paillet <p.paillet@st.com>.
Copyright (C) 2013 Vayavya Labs Pvt Ltd
Copyright (C) 2008-2011 Nokia Corporation
(C) COPYRIGHT 2014-2018 ARM Limited. All rights reserved.
Copyright (c) 2019 Kuninori Morimoto <kuninori.morimoto.gx@renesas.com>
Copyright (C) 1998-2009 Texas Instruments. All rights reserved.
Copyright (c) 2003 Ian Molton <spyro@f2s.com>
Copyright (c) 2005 Martin Langer <martin-langer@gmx.de>, Stefano Brivio <stefano.brivio@polimi.it> Michael Buesch <m@bues.ch> Danny van Dyk <kugelfang@gentoo.org> Andreas Jaggi <andreas.jaggi@waterwave.ch>
Copyright (C) 2012 David Gibson, IBM Corporation.
Copyright (c) 2007 Cisco Systems. All rights reserved.
Copyright (C) 1995, 2007 David S. Miller (davem@davemloft.net)
Copyright (C) 2001-2003 Sistina Software (UK) Limited.
Copyright (C) 2013 Altera Corporation
Copyright (C) 2018 Jacopo Mondi <jacopo+renesas@jmondi.org>
(c) 2004 Andrew de Quincey
Copyright (c) 2014 The Chromium OS Authors
Copyright (C) 2003 David S. Miller (davem@redhat.com)
Copyright (C) 2003 Nokia Corporation Written by Timo Teräs <ext-timo.teras@nokia.com>
Copyright (C) 2003 BULL SA.
Copyright (c) 2000-2002,2005 Silicon Graphics, Inc.
Copyright (c) 2016 BayLibre, Inc. Author: Neil Armstrong <narmstrong@baylibre.com>
Copyright 2012 Red Hat
Copyright (C) 2009-2010 Renesas Solutions Corp.
Copyright (C) 2005 Miloslav Trmac <mitr@volny.cz>
Copyright (C) 1994-2002 Russell King
Copyright IBM Corp. 2002, 2012
Copyright (c) 2017, National Instruments Corp.

LICENCE TERMS (cont.)

Copyright (C) 2018 Engicam S.r.l.
(C) 2008 Anatolij Gustschin <agust@denx.de> DENX Software Engineering
Copyright 2014 Freescale Semiconductor Inc.
Copyright (C) 2006 by Hans Edgington <hans@edgington.nl> *
Copyright 2007-2012 Siemens AG
Copyright (C) 2007,2008 Jonathan Woithe <jwoithe@just42.net>
Copyright (C) 1992 - 1997, 2000 Silicon Graphics, Inc.
Copyright (C) 2007-2010 Gabor Juhos <juhosg@openwrt.org>
Copyright 2016-2017 Lothar Waßmann <LW@KARO-electronics.de>
Copyright 2013 Hauke Mehrkens <hauke@hauke-m.de>
Copyright Jonathan Naylor G4KLX (g4klx@g4klx.demon.co.uk)
Copyright Intel Corporation (C) 2017.
Copyright 2003 Pavel Machek <pavel@suse.cz>
(c) 2007 Mauro Carvalho Chehab, <mchehab@kernel.org>
Copyright (c) 2018 Samsung Electronics Co., Ltd. <http://www.samsung.com/>
Copyright (C) 2015 Imagination Technologies Author: Paul Burton <paul.burton@mips.com>
Copyright (c) 2008,2009,2010 Katalix Systems Ltd
Copyright (C) 2009-2011 Gabor Juhos <juhosg@openwrt.org>
Copyright (C) 2013 Magnus Damm
Copyright (C) 2018 Microchip Technology Inc.
Copyright (C) 2014 Texas Instruments Ltd
Copyright (C) 2017 Western Digital Corporation or its affiliates.
Copyright (C) 2018 Renesas Electronics Corporation
Copyright 2015 Linaro.
Copyright (C) 1995, 96, 97, 98, 99, 2000 by Ralf Baechle
Copyright (c) 1999-2008 LSI Corporation <mailto:DL-MPTFusionLinux@lsi.com>
Copyright (C) 2006,2007 Red Hat, Inc., Ingo Molnar <mingo@redhat.com>
Copyright (C) 2000 Deep Blue Solutions Ltd.
Copyright (C) 2015-2018 Alban Bedel <albeu@free.fr>
(c) Copyright 2002-2010, Ralink Technology, Inc.
Copyright (C) 2014 Dan Streetman
Copyright 2000 (c) Hewlett Packard
Copyright (C) 2005 by Latchesar Ionkov <lcho@ionkov.net>
Copyright 2000-2001 ATMEL Corporation.
Copyright (c) 2010-2015, 2018, The Linux Foundation. All rights reserved.
Copyright (C) 2002, 2003 - Tom Zanussi (zanussi@us.ibm.com), IBM Corp
Copyright 2012 Peter Meerwald <pmeerw@pmeerw.net>
Copyright 2009 Ben Skeggs
Copyright 2018 Google, Inc
Copyright (C) 2015 Endless Mobile, Inc. Author: Carlo Caione <carlo@endlessm.com>
Copyright (C) 2006-2007 Charles Spirakis <bezaur@gmail.com>
Copyright (C) 2010-2013 ST-Ericsson AB Mian Yousaf Kaukab <mian.yousaf.kaukab@stericsson.com> Avinash Kumar <avinash.kumar@stericsson.com> Thirupathi Chippakurthy <thirupathi.chippakurthy@stericsson.com>
Copyright (C) 2007 Hans Verkuil (hverkuil@xs4all.nl)
Copyright (C) 1995 David S. Miller (davem@caip.rutgers.edu)
Copyright (c) 2004-2008 Richard Purdie
Copyright 2017 IBM Corp.
Copyright (C) 2017 Hari Bathini, IBM Corporation
Copyright (C) 2000-2002 Inside Out Networks, All rights reserved.
Copyright (c) 2014, Ericsson AB All rights reserved.
Copyright (C) 2012 egnite GmbH <info@egnite.de>
Copyright (c) 2014 Measurement-Specialties
Copyright (c) 2014 Mahesh Bandewar <maheshb@google.com>
Copyright 2010-2011 Calxeda, Inc.
Copyright (C) 2013 Cavium, Inc
Copyright © 2001-2007 Red Hat, Inc. and others
Copyright (c) 1999-2003 Vojtech Pavlik <vojtech@suse.cz>

Copyright 2009-2011 Freescale Semiconductor, Inc.
Copyright (C) 1999 Richard Zidlicky
Copyright (C) 2014 Imagination Technologies Ltd
Copyright 2005 John Lenz <lenz@cs.wisc.edu> Maintainer: Pavel Machek <pavel@ucw.cz> (unless John wants to :-)
Copyright (C) 2005 John Lenz <lenz@cs.wisc.edu>
Copyright © 2001-2007 Red Hat, Inc.
Copyright (C) 2006, 2007 Ian Armstrong <ian@iarmst.demon.co.uk>
Copyright (C) 2001 Paul Diefenbaugh <paul.s.diefenbaugh@intel.com>
Copyright (c) 2013 Patrick McHardy <kaber@trash.net>
Copyright (C) 2017, STMicroelectronics - All Rights Reserved Authors: Arnaud Pouliquen <arnaud.pouliquen@st.com> Olivier Moysan <olivier.moysan@st.com>
Copyright (C) 2011 Dmitry Eremin-Solenikov
Copyright (c) 2017-2018 Hans de Goede <hdegoede@redhat.com>
Copyright 2013 Emilio López
Copyright (C) 2010, ARM Ltd., Will Deacon <will.deacon@arm.com>
Copyright (C) 2014 Antoine Ténart <antoine.tenart@free-electrons.com>
Copyright (c) 2017 BayLibre, SAS Author: Neil Armstrong <narmstrong@baylibre.com>
Copyright (c) 2004 Randy Dunlap
Copyright (c) 2010-2012 Freescale Semiconductor, Inc.
Copyright (C) 1999 Russell King
Copyright (C) NEC Electronics Corporation 2005-2006
Copyright (C) 2012 Fusion-io All rights reserved.
Copyright (c) 2008 Emcraft Systems. Sergei Poselenov, <sposelenov@emcraft.com>
Copyright (C) 2009 Nokia Corporation
(C) 1999-2001 Paul 'Rusty' Russell;(C) 2002-2005 Netfilter Core Team <coreteam@netfilter.org>
Copyright 2010 Marvell International Ltd. Haojian Zhuang <haojian.zhuang@marvell.com>
(C) Copyright 2007-2011 Reuimilla Technology Co., Ltd.:(C) Copyright 2007-2011 Aaron Maoye <leafy.myeh@reuimillatech.com>;(C) Copyright 2013-2014 O2S GmbH <www.o2s.ch>;(C) Copyright 2013-2014 David Lanzendörfer <david.lanzendoerfer@o2s.ch>;(C) Copyright 2013-2014 Hans de Goede <hdegoede@redhat.com>;(C) Copyright 2017 Sootech SA
Copyright 2012-2017 Solarflare Communications Inc.
Copyright (C) 2002 Atom Create Engineering Co., Ltd.
Copyright (C) 1997-1999 Russell King
Copyright 2004 Antonino A. Daplas <adaplas @pol.net>
Copyright (C) 2001-5, B2C2 inc.
Copyright 1999 Precision Insight, Inc., Cedar Park, Texas.
Copyright (c) 2014 Shuah Khan <shuahkh@osg.samsung.com>
Copyright (c) 2016 MediaTek Inc. Author: Ryder Lee <ryder.lee@mediatek.com>
Copyright (C) 2008, Moxa Inc.
Copyright (C) 2015-2016 Nexvision Author: Charles-Antoine Couret <charles-antoine.couret@nexvision.fr>
Copyright 2014 Google Inc. Author: willemb@google.com (Willem de Bruijn)
Copyright (C) 2013, Applied Micro Circuits Corporation
Copyright (C) 2008-2009 Gabor Juhos <juhosg@openwrt.org>
Copyright (c) 2013-2015 Qualcomm Atheros, Inc.
Copyright 2011-2016 Google Inc.
Copyright: |copy| 2018 Intel Corporation
Copyright (c) 2016 Parrot S.A.
Copyright (C) 2001-2004 Aurelien Jarno <aurelien@aurel32.net> Ported to Linux 2.6 by Aurelien Jarno <aurelien@aurel32.net> with the help of Jean Delvare <jdelvare@suse.de>
Copyright (C) 2011 Sascha Hauer <s.hauer@pengutronix.de>
Copyright (C) 2008 by Jaya Kumar
Copyright (C) 2018 Icenowy Zheng <icenowy@aosc.io>
Copyright (c) 2001 by Jay Schulist <jschlst@samba.org>
Copyright (C) 1995, 96, 97, 98, 99, 2001 by Ralf Baechle
Copyright(c) 2005 - 2014 Intel Corporation. All rights reserved.
Copyright (c) 2009, 2014 Samsung Electronics <http://www.samsung.com/>

LICENCE TERMS (cont.)

Copyright (C) 2015 Sakari Ailus
Copyright (c) 2013 Dmitry Kasatkin <d.kasatkin@samsung.com>
Copyright (C) 2007-2013 ST-Ericsson
(C) Copyright 2009 Intel Corporation
(c) 1998-2002 Petr Vandrovec <vandrove@vc.cvut.cz>
Copyright 2004-2006 Simtec Electronics
(c) Copyright 2004 Hewlett-Packard Development Company, L.P. Bjorn Helgaas <bjorn.helgaas@hp.com>
Copyright (C) 2012 Rafael J. Wysocki <rjw@sisk.pl>
Copyright (c) 2013 Tomasz Figa <tomasz.figa@gmail.com>
Copyright (c) 2017 Fuzhou Rockchip Electronics Co., Ltd
Copyright (C) 2009 Texas Instruments
Copyright 2012 Anatolij Gustschin <agust@denx.de>
(C) 2001, 2002, 2003, 2004 Rusty Russell
Copyright (C) 2011 Renesas Solutions Corp. Kuninori Morimoto <kuninori.morimoto.gx@renesas.com>
Copyright 2009 Paul Mackerras, IBM Corporation.
Copyright: (C) 2012-2013 Linaro Limited
Copyright (c) 2006 Wolfson Microelectronics PLC. Graeme Gregory graeme.gregory@wolfsonmicro.com linux@wolfsonmicro.com
Copyright (C) 2002, 2008 David S. Miller <davem@davemloft.net>
Copyright (C) 2008 Magnus Damm
Copyright (C) 1994-96 Marc ZYNGIER zygier@ufr-info-p7.ibp.fr> or maz@gloups.fdn.fr>
Copyright (C) 2016 Cristina-Gabriela Moraru <cristina.moraru09@gmail.com>
Copyright (C) 2014-2017 Texas Instruments Incorporated - http://www.ti.com/
Copyright (C) 1996 David S. Miller (dm@sgi.com)
Copyright (C) 2009 Texas Instruments Incorporated - http://www.ti.com/
Copyright (c) 2007, 2009, 2010 QLogic Corporation. All rights reserved.
Copyright (c) 2010 Simon Wood <simon@mungewell.org>
Copyright (C) 2002 David McCullough
Copyright (c) 2006-2008 Daniel Mack, Karsten Wiese
Copyright 2008 by Steven Rostedt, Red Hat, Inc inspired by Andi Kleen's thunk_64.S)
Copyright (c) 2007 Patrick McHardy <kaber@trash.net>
Copyright 2013 Ondrej Zary
Copyright (C) STMicroelectronics 2018 Author: Pascal Paillet <p.paillet@st.com> for STMicroelectronics.
Copyright (C) 2017 PHYTEC Messtechnik GmbH Author: Wadim Egorov <w.egorov@phytec.de>
Copyright 2011 Red Hat, Inc. All rights reserved.
Copyright (C) 2012 Canonical Ltd
Copyright (C) 2012-2014 Samsung Electronics Co., Ltd.
Copyright (C) 2011 Intel Corporation. All rights reserved.
Copyright (c) 2014 Mediatek Inc. Author: Shunli Wang <shunli.wang@mediatek.com> Yingjoe Chen <yingjoe.chen@mediatek.com>
Copyright (c) 2002-2007 Xilinx Inc.
Copyright 2004 IDT Inc. (rischelp@idt.com)
"Copyright (C) 2012 Renesas Solutions Corp.:(c) container_of(c, struct tpu_device, chip)"
Copyright 1999 Philipp Rumpf (prumpf@tux.org)
"Copyright (C) 2016 ARM Ltd. Author: James Morse <james.morse@arm.com>"
(C) 2007 Hans J. Koch <hjk@hansjkoch.de>;(C) 2005 Benedikt Spranger <b.spranger@linutronix.de>
Copyright (c) 2006 Dave Airlie <airlied@linux.ie>
Copyright (C) 2009 Atsushi Nemoto <anemo@mba.ocn.ne.jp>
Copyright 2017, Matt Brown, IBM Corp.
Copyright (c) 2014-2016 Broadcom Corporation
Copyright 2006 Ben Dooks <ben-linux@fluff.org>
Copyright (c) 2014, Steffen Trumtrar <s.trumtrar@pengutronix.de>
Copyright (C) 2007 Bluewater Systems Ltd Author: Ryan Mallon
Copyright (C) 2016 Renesas Electronics Corporation
Copyright IBM Corp. 2000, 2006
Copyright (c) 2010 Andres Salomon <dilinger@queued.net>
Copyright (c) 2003-2008 QLogic Corporation

Copyright 2008 DENX Software Engineering, Stefan Roese <sr@denx.de>
Copyright 2012 Michael Ellerman, IBM Corporation.
Copyright (c) 2011,2012 Intel Corp.
Copyright © 2006-2007 Intel Corporation
Copyright: (C) 2009, 2010 Nicolas Palix, DIKU.
Copyright (C) STMicroelectronics SA 2019 Authors: Mickael Guene <mickael.guene@st.com> for STMicroelectronics.
Copyright (C) 2014-2015 Intel Corp Author: Jeeja KP <jeeja.kp@intel.com>
(C) Copyright Al Viro 2002,2003
Copyright (C) 2001,.....,2006 Davide Libenzi
Copyright (C) 2006 Samsung Electronics Kyungmin Park <kyungmin.park@samsung.com>
Copyright (C) 2004 Microtronix Datacom Ltd
Copyright** |copy| 2009-2016 : LinuxTV Developers
Copyright (C) 2002 James Simmons
Copyright 2017 Peter Meerwald-Stadler <pmeerw@pmeerw.net>
Copyright (C) 1995, 1996, 2001 Ralf Baechle
Copyright (C) 2013, 2015 Altera Corporation
Copyright (c) 2014 H Hartley Sweeten <hsweeten@visionengravers.com>
Copyright (C) 2012 ST Microelectronics Ltd. Shiraz Hashim <shiraz.linux.kernel@gmail.com>
Copyright IBM Corp. 2000
Copyright (C) 2012 Russell King;(c) container_of(c, struct armada_crtc, crtc)
Copyright (C) Shailabh Nagar, IBM Corp. 2006;(C) Balbir Singh, IBM Corp. 2006
Copyright (C) 2001 - 2015 Intel Corp. Author: Andy Grover <andrew.grover@intel.com> Author: Paul Diefenbaugh <paul.s.diefenbaugh@intel.com> Author: Rafael J. Wysocki <rafael.j.wysocki@intel.com>
Copyright (C) 2005 by Eric Van Hensbergen <ericvh@gmail.com>
Copyright 2013 Markus Pargmann <mpa@pengutronix.de>, Pengutronix
Copyright 2016 Freescale Semiconductor, Inc.
Copyright 1997 by Carsten Paeth (calle@calle.in-berlin.de)
Copyright (C) 1991, 1992, 1995 Linus Torvalds
(C) 2003 by Sampsa Ranta <sampsa@netsonic.fi>
Copyright(c) 2016 - 2017 Intel Corporation.
Copyright 2009-2011 VMware, Inc., Palo Alto, CA., USA
Copyright 2013,2014 IBM Corp.
Copyright (c) 2014 Raspberry Pi (Trading) Ltd. All rights reserved.
Copyright 2007 Andrea Merello <andrea.merello@gmail.com>
Copyright (C) 2007 Domen Puncer, Telargo, Inc.
Copyright(c) 2009 - 2014 Intel Corporation. All rights reserved.
(C) Copyright 2016-2018 - Mathieu Desnoyers <mathieu.desnoyers@efficios.com>;(C) Copyright 2016-2018 - Boqun Feng <boqun.feng@gmail.com>
Copyright (C) ST-Ericsson AB 2010 Author: Daniel Martensson / Daniel.Martensson@stericsson.com License terms: GNU General Public License (GPL), version 2.
Copyright 1997-2000, 2008 Pavel Machek <pavel@ucw.cz>
Copyright (C) 2003-2004 David Brownell
Copyright (C) 2006 by Paolo Giarrusso - modified from glibc' execvp.c.
Copyright 2007 Benjamin Herrenschmidt, IBM Corp. benh@kernel.crashing.org>
Copyright (C) 2013-2016 Freescale Semiconductor, Inc.
Copyright (c) 2017 MediaTek Inc. Author: Chen Zhong <chen.zhong@mediatek.com> Sean Wang <sean.wang@mediatek.com>
Copyright 2009 Janusz Krzysztofik <jkrzysz@tis.icnet.pl>
Copyright (c) 2000-2005 Anton Altaparmakov
Copyright (C) 2009, Kay Sievers <kay.sievers@vrfy.org>
Copyright (C) 2009 Rafael J. Wysocki <rjw@sisk.pl>
Copyright (C) 2007-2009 ST-Ericsson AB AB3100 core access functions Author: Linus Walleij <linus.walleij@stericsson.com>
Copyright IBM Corp. 2007 Author(s): Michael Holzheu <holzheu@de.ibm.com>
Copyright (C) ARM Limited
Copyright (C) 2004 - 2013 by Tensilica Inc.

LICENCE TERMS (cont.)

Copyright (C) 2009-2013 Texas Instruments Inc. Nishant Kamat <nskamat@ti.com> Balaji T K <balajitk@ti.com>
Graeme Gregory <gg@slimlogic.co.uk> Girish S Ghongdemath <girishsg@ti.com> Ambresh K <ambresh@ti.com>
Oleksandr Kozaruk <oleksandr.kozaruk@ti.com>
Copyright 2001, STMicroelectronics, Inc. Contact: steve.miller@st.com
Copyright (C) 1999-2004 Silicon Graphics, Inc. All Rights Reserved.
Copyright IBM Corp. 2015 Author(s): Gerald Schaefer <gerald.schaefer@de.ibm.com>
Copyright (C) 2014, 2016 Antony Pavlov <antonypavlov@gmail.com>
Copyright (C) 2018-2019 Microchip Technology Inc.
Copyright (C) 2013 Linaro Limited
Copyright (C) 2001 Ben. Herrenschmidt (benh@kernel.crashing.org)
Copyright (c) 2016 Hans de Goede <hdegoede@redhat.com>
Copyright (C) 1999-2002 Ralph Metzler Marcus Metzler for convergence integrated media GmbH
Copyright (C) 2011 Samsung Electronics Co., Ltd. MyungJoo Ham <myungjoo.ham@samsung.com>
Copyright (C) 2008 Yoshinori Sato
Copyright (c) 2015 Cumulus Networks. All rights reserved.
Copyright (C) 2000, 2001 Paolo Alberelli
Copyright (C) 2008-2011 Rafael J. Wysocki <rjw@sisk.pl>, Novell Inc.
Copyright (C) 2011 Robert Jarzmik
(C) Copyright Steven King <sfking@fdwdc.com>
Copyright IBM Corp. 2002, 2010
Copyright 2011 Heiko Stuebner <heiko@sntech.de>
Copyright (C) 2015 Texas Instruments Incorporated - http://www.ti.com
Copyright 2004-2007, 2010-2015 Freescale Semiconductor, Inc.
(C) Copyright 2007 Texas Instruments Karthik Dasu <karthik-dp@ti.com>;(C) Copyright 2004 Texas Instruments,
<www.ti.com> Richard Woodruff <r-woodruff2@ti.com>
Copyright (C) 2006-2012 Nobuhiro Iwamatsu
Copyright (C) 1992 Krishna Balasubramanian
(c) 2003-2006 Advanced Micro Devices, Inc.
Copyright (C) 1997-2003 Russell King
Copyright (C) 2003-2014 STMicroelectronics (R&D) Limited
Copyright (C) 2002 Laurent Canet <canetl@esiee.fr>
Copyright © 2008 Intel Corporation
Copyright(c) 2017 Broadcom. All rights reserved.
Copyright (C) 2015 ARM Ltd. All Rights Reserved
Copyright (C) 2010, 2011 Texas Instruments. Contributed by: Mark Salter <msalter@redhat.com>
Copyright 2017 Toradex AG
Copyright (c) 2017 Amlogic, Inc. All rights reserved.
Copyright 2013 Wind River Systems Inc.
Copyright (C) 2000, 2001 Broadcom Corporation
Copyright (C) 2007 Atmel Corporation
Copyright (C) 1992,1993,1994,1997,1999 Australia. E-mail billm@melbpc.org.au |
Copyright (C) 1997, 1998 Richard Henderson
Copyright (C) 1998,99 Takashi Iwai <tiwai@suse.de>, Jaroslav Kysela <perex@perex.cz>
Copyright (C) 2018 Topic Embedded Products Author: Mike Looijmans <mike.looijmans@topic.nl>
Copyright (c) 2019 Bootlin
Copyright (C) 2003-2004 Alex Woods <linux-dvb@giblets.org> IR support by Peter Beutner <p.beutner@gmx.net>
Copyright (C) 2008-2009 Akamai Technologies, Inc. Portions by Hitoshi Mitake <h.mitake@gmail.com>.
Copyright (c) 2006,2007 Daniel Mack, Tim Ruetz
Copyright (C) 2010-2011 Jonas Bonn <jonas@southpole.se>
Copyright (C) Ericsson AB 2007-2008
Copyright © 2008 David Woodhouse <dwmw2@infradead.org>
Copyright (C) 2011 - 2014 Xilinx
Copyright (c) 2015 Neil Armstrong
Copyright 2008 - 2016 Freescale Semiconductor Inc.
Copyright 2013-2017 Pervasive Displays, Inc.
Copyright 2012 - 2015 Freescale Semiconductor Inc.
Copyright (C) 1999-2005 Hewlett Packard Co Stephane Eranian <eranian@hpl.hp.com> David Mosberger-Tang

<davidm@hpl.hp.com>
Copyright (C) 2010 Texas Instruments Incorporated - http://www.ti.com/ Sumit Semwal
Copyright(c) 2003 - 2011 Intel Corporation. All rights reserved.
Copyright (C) Jean-Francois Moine (http://moinejf.free.fr)
Copyright © 2012 NetCommWireless Iwo Mergler <iwo.Mergler@netcommwireless.com.au>
Copyright (C) 2000 Kazumoto Kojima
(C) Copyright 2000, 2001 Wolfgang Denk, DENX Software Engineering, wd@denx.de.
Copyright 2015 - Steven Rostedt, Red Hat Inc.
Copyright (C) 2004 by Thomas Rathbone, HP Labs
Copyright (C) 2008 Red Hat, Inc. All rights reserved.
Copyright (C) 1993 Linus Torvalds Support of BIGMEM added by Gerhard Wichert, Siemens AG, July 1999 SMP-
safe vmalloc/vfree/ioremap, Tigran Aivazian <tigran@veritas.com>, May 2000 Major rework to support vmap/
vunmap, Christoph Hellwig, SGI, August 2002 Numa awareness, Christoph Lamet
(c) 2013 ST Microelectronics
Copyright (C) 2009 Intel Corporation, Yu Zhao <yu.zhao@intel.com>
Copyright (C) 1991, 1992 Linus Torvalds
Copyright (C) 1998-2002 Andre Hedrick <andre@linux-ide.org>
Copyright (C) 2002 - 2009 Paul Mundt
Copyright (C) 2014 Marvell Semiconductor
Copyright (C) 2006-2010 Texas Instruments Inc
Copyright 2012 Texas Instruments Inc.
Copyright (C) 2015 Atmel, 2015 Alexandre Belloni <alexandre.Belloni@free-electrons.com>
Copyright (c) 2017 Marek Szyproski
Copyright (C) 2010-2011 Texas Instruments, Inc.
Copyright IBM Corporation 2001, 2005, 2006
(C) 2002 by gaoyonghong MODULE_AUTHOR ("gaoyonghong"); MODULE_DESCRIPTION ("Rsltek 8139D PCI
Fast Ethernet Adapter driver"); Both are almost identical and seem to be based on pci-skeleton.c
Copyright (C) 2002 Intel Corporation.
Copyright (c) 2005 Nick Sillik <n.sillik@temple.edu>
Copyright (C) 2008 Red Hat, Inc., Eric Paris <eparis@redhat.com>
Copyright (C) 1995 Linus Torvalds;(c) 1995-2004 Russell King
Copyright (C) 2013-2018 Texas Instruments Incorporated - http://www.ti.com/ Dave Gerlach, Vaibhav Bedia
Copyright 2000-2020 Broadcom Inc. All rights reserved.
Copyright 2012 Markus Pargmann, Pengutronix
Copyright (C) 2000-2004 Russell King
Copyright (C) 2013 IBM Corp. All rights reserved. Author: Alexey Kardashevskiy <aik@ozlabs.ru>
Copyright 2009 John F. Reiser <jreiser@BitWagon.com>. All rights reserved.
Copyright (C) 2005 David S. Miller <davem@davemloft.net>
Copyright 2017-2018 Cadence
Copyright 2016-2017 Lukasz Majewski, DENX Software Engineering, lukma@denx.de
Copyright (C) 2012 Samsung Electronics Co.Ltd Authors: YoungJun Cho <yj44.cho@samsung.com> Eunchul Kim
<chulspro.kim@samsung.com>
Copyright © 2002, Greg Ungerer (gerg@snapgear.com)
Copyright IBM Corp. 2008, 2012 Author(s): Peter Oberparleiter <peter.oberparleiter@de.ibm.com>
Copyright (C) International Business Machines Corp., 2004, 2008
Copyright 2010 PMC-Sierra, Inc, derived from irq_cpu.c
Copyright (C) 2004 Antonino Daplas <adaplas @pol.net>
Copyright (C) 2004 - 2010 Ivo van Doorn <lvDoorn@gmail.com> http://rt2x00.serialmonkey.com>
Copyright (c) 2015, 2017 Oracle. All rights reserved.
Copyright (c) 2004 MIPS Inc Author: chris@mips.com
Copyright (c) 2012 Samsung Electronics Co., Ltd. Author: Jingoo Han <jg1.han@samsung.com>
Copyright (C) 2010 John Crispin <john@phrozen.org>
Copyright 2016 - Stefan Mavrodiev <stefan.mavrodiev@gmail.com> Olimex LTD. <support@olimex.com>
Copyright 2008-2012 Freescale Semiconductor, Inc.
Copyright 2013 Freescale Semiconductor, Inc.
Copyright 2010 Wolfram Sang <w.sang@pengutronix.de>
Copyright (c) 2010-2013 Micrel, Inc.

LICENCE TERMS (cont.)

Copyright (C) 2012 - Virtual Open Systems and Columbia University Authors: Rusty Russell <rusty@rustcorp.com.au> Christoffer Dall <c.dall@virtualopensystems.com>
Copyright 1998 by Egbert Eich <Egbert.Eich@Physik.TU-Darmstadt.DE>
Copyright (C) 2015-2017 Texas Instruments Incorporated - <http://www.ti.com/> Nishanth Menon
Copyright (c) 2014-2016 Andrew Lutomirski
Copyright (C) 2012 - 2014 Xilinx
Copyright (C) 2006 Antti Palosaari <crope@iki.fi>
Copyright (C) 2014 STMicroelectronics Ltd Author: Giuseppe Cavallaro <peppe.cavallaro@st.com> Contributors: Peter Griffin <peter.griffin@linaro.org>
Copyright (C) 2004,2019 Greg Kroah-Hartman <greg@kroah.com>
Copyright IBM Corporation, 2013 Author Aneesh Kumar K.V <aneesh.kumar@linux.vnet.ibm.com>
Copyright (c) 2010 Cavium Networks, Inc.
Copyright (C) 2014 Sensirion AG, Switzerland Author: Johannes Winkelmann <johannes.winkelmann@sensirion.com>
Copyright 2000 ATI Technologies Inc., Markham, Ontario, and VA Linux Systems Inc., Fremont, California.
Copyright 2007, Domen Puncer <domen.puncer@telargo.com>
(C) 2005 Harald Welte <laforge@gnunomks.org>;(C) 2005 Patrick McHardy <kaber@trash.net>;(C) 2005-2006 Netfilter Core Team <coreteam@netfilter.org>;(C) 2005 USAGI/WIDE Project <<http://www.linux-ipv6.org>>
Copyright (C) 2006 bplan GmbH
Copyright Joern Engel <joern@lazybastard.org> Inspired by Linus Torvalds Original idea maybe from Keith Owens s390 port and big speedup by Arnd Bergmann <arnd@bergmann-dalldorf.de> Mips port by Juan Quintela <quintela@mandrakesoft.com> IA64 port via Andreas Dilger Arm port by Holger Schu
Copyright (C) 2015-2016, Microchip Technology Germany II GmbH & Co. KG
copyright 1989 Regents of the University of California. endif ifdef CONFIG_SLIP_SMART printk(KERN_INFO "SLIP linefill/keepalive option. endif
Copyright (C) 1993 Linus Torvalds
Copyright (c) 2004-2008 Simtec Electronics <http://armlinux.simtec.co.uk> Ben Dooks <ben@simtec.co.uk>
Copyright (C) 2005 - 2008 Tensilica, Inc.
Copyright 2016 VMware, Inc., Palo Alto, CA., USA
Copyright (C) 2000, 2001, 2002, 2003 David S. Miller (davem@redhat.com);(C) 2001,2002,2003 Benjamin Herrenschmidt (benh@kernel.crashing.org);(C) 2004,2005 Benjamin Herrenschmidt, IBM Corp.;(C) 2004 by Eric Lemoine (eric.lemoine@gmail.com)
(C) Copyright IBM 2014
Copyright (C) 2009-2010 Texas Instruments Incorporated. Nishanth Menon Romit Dasgupta Kevin Hilman
Copyright (C) 2011 Tobias Klausner <tklausner@distanz.ch>
Copyright 2015 Google Inc. Author: Anatol Pomozov <anatol.pomozov@chromium.org>
Copyright (C) 2010 Malcolm Priestley (tvboxspy@gmail.com);(C) Leagueme (Shenzhen) MicroElectronics Co., Ltd.
Copyright (C) 2000 Linus Torvalds. 2000 Transmeta Corp.
Copyright (C) 1997-2012 AudioScience Inc. <support@audioscience.com>;(C) Copyright AudioScience Inc. 1996-2009
"Copyright (C) 2001-2002 Andre Hedrick <andre@linux-ide.org>;(C) Copyright 2002 Red Hat Inc"
Copyright ♦ 2008-2018 Intel Corporation
Copyright (C) 2009, Steven Rostedt <srostedt@redhat.com>
Copyright (C) 2015 - 2016 ZTE Corporation.
Copyright 2008 Michael Ellerman, IBM Corporation.
Copyright 2010 Eric Bénard, Eukréa Electromatique <eric@eukrea.com>
Copyright (C) 2009 Devin Heitmueller <dheitmueller@linuxtv.org>
Copyright 2012 - 2015 Freescale Semiconductor, Inc.
Copyright (c) 2002,2003 Oliver Kurth
Copyright(c) 2018 Ira Weiny, Intel Corporation
Copyright 2010 PMC-Sierra, Inc.
Copyright 2002 Integrated Device Technology, Inc. All rights reserved.
Copyright (C) 2016-2017 Dmitry Osipenko <digetx@gmail.com>
(c) 2015 - Jeff Layton <jeff.layton@primarydata.com>
Copyright (C) 2000-2008 Krzysztof Halasa <khc@pm.waw.pl>
Copyright (C) 2017 The Linux Foundation. All rights reserved.
Copyright (c) 2015 Neil Armstrong <narmstrong@baylibre.com>

Copyright 2013 Cisco Systems, Inc. and/or its affiliates.
Copyright (C) 2002,2003 Jun Nakajima <jun.nakajima@intel.com>
Copyright (C) 2000,2002 David A. Schleef <ds@schleef.org>
Copyright (C) 2000 Philipp Rumpf <prumpf@tux.org>
Copyright 2012 Sascha Hauer <s.hauer@pengutronix.de>, Pengutronix
Copyright (C) 2010, Novell, Inc. Author : K. Y. Srinivasan <ksrinivasan@novell.com>
Copyright (C) 2005 Embedded Alley Solutions, Inc
Copyright 2016 Gateworks Corporation
Copyright IBM Corp. 2019 Author(s): Harald Freudenberger <freude@linux.ibm.com> Ingo Franzki <ifranzki@linux.ibm.com>
Copyright 1994-97 Roman Hodek <Roman.Hodek@informatik.uni-erlangen.de>
Copyright (c) 2010 Broadcom Corporation
Copyright (C) 2018, Advanced Micro Devices, Inc.
Copyright(c) 2005 Samsung Electronics Kyungmin Park <kyungmin.park@samsung.com>
Copyright (c) 2004 Jouni Malinen <j@w1.fi>
Copyright (C) 2017 Linaro Limited Author: AKASHI Takahiro <takahiro.akashi@linaro.org>
Copyright (C) 2008 IBM Corporation
Copyright (C) 2005 Hewlett-Packard Development Company, L.P.
Copyright (c) 2011-2017 Qualcomm Atheros, Inc.
Copyright (c) 2017, Collabora Ltd.
Copyright (C) 1996 Larry Ewing (lewing@isc.tamu.edu)
(C) Copyright 1999 Linus Torvalds;(C) Copyright 1999-2002 Johannes Erdfelt, johannes@erdfelt.com;(C) Copyright 1999 Randy Dunlap;(C) Copyright 1999 Georg Acher, acher@in.tum.de;(C) Copyright 1999 Deti Fliegl, deti@fliegl.de;(C) Copyright 1999 Thomas Sailer, sailer@ife.ee.ethz.ch;(C) Copyright 2004 Alan Stern, stern@rowland.harvard.edu
Copyright 2001 MontaVista Software Inc. Author: MontaVista Software, Inc. ahennesy@mvista.com
Copyright (c) 2017 MediaTek Inc. Author: Chenglin Xu <chenglin.xu@mediatek.com>
Copyright (C) 2007-2008 Hewlett-Packard Development Company, L.P. Alex Chiang <achiang@hp.com>
Copyright (c) by Tugrul Galatali <galatal@stuy.edu>, Jaroslav Kysela <perex@perex.cz> Based on card-4232.c by Jaroslav Kysela <perex@perex.cz>
Copyright (C) 2009 Janos Laube <janos.dev@gmail.com>
Copyright (C) 2014-15, Intel Corporation.
Copyright (C) 1996-2001 Russell King.
Copyright © 2006 Red Hat, Inc. All Rights Reserved. Written by David Howells (dhowells@redhat.com)
(C) 2005 Red Hat Inc
Copyright (C) 2001 Andrea Arcangeli <andrea@suse.de> SuSE
Copyright 2015 Sjarhei Siamashka <sjarhei.siamashka@gmail.com>
Copyright 2013 Rostislav Lisovy <lisovy@gmail.com>, PiKRON s.r.o.
Copyright (C) 2010-2011 Lund Engineering Contact: Gil Lund <gwlund@lundeng.com> Author: Martin Hostettler <martin@neutronstar.dyndns.org>
Copyright (C) 2012 Roland Stigge
Copyright (C) 2016 MELFAS Inc.
Copyright (C) 2013 Renesas Solutions Corp.
Copyright Tomi Manninen OH2BNS (oh2bns@sral.fi)
Copyright (c) 1999 Andreas Gal
Copyright 2018 Toradex AG
Copyright (C) 2005-2008 Cavium Networks, Inc
Copyright (c) by Jaroslav Kysela <perex@perex.cz> Routines for control of 16-bit SoundBlaster cards and clones
"Copyright 2009 Johannes Berg <johannes@sipsolutions.net>"
Copyright (c) 2011 Chelsio Communications. All rights reserved.
Copyright 2014 Chen-Yu Tsai <wens@csie.org>
Copyright (C) 2008-2009 DENX Software Engineering.
Copyright (C) 2014 Andreas Noever <andreas.noever@gmail.com>
Copyright (c) 2015-2016, The Linux Foundation. All rights reserved.
Copyright (C) 2012 Google, Inc.
Copyright (C) 2012 Calxeda, Inc.
Copyright (C) 2014, 2015 Intel Corporation

LICENCE TERMS (cont.)

(C) Copyright 2008 Intel Corporation Author: Arjan van de Ven <arjan@linux.intel.com>
Copyright (C) 2013-2014 Renesas Solutions Corp.
Copyright (c) 2010-2015 Samsung Electronics Co., Ltd. http://www.samsung.com
Copyright 2002,2003 Yoichi Yuasa <yuasa@linux-mips.org>
Copyright (C) 2015, Samsung Electronics Co., Ltd. Author: Jacek Anaszewski <j.anaszewski@samsung.com>
Copyright (C) 2007, Intel Corp. Huang Ying <ying.huang@intel.com>
Copyright (c) 2006-2007 Silicon Graphics, Inc.
Copyright (C) 2010 Tobias Klauser <tklauser@distanz.ch>
Copyright (C) 2009-2010 Mauro Carvalho Chehab
Copyright (C) 2009 Arjan van de Ven <arjan@linux.intel.com>
Copyright (C) 2002 Stephen Rothwell, IBM Corporation
Copyright (C) 2017 Linaro Ltd. Author: Linus Walleij <linus.walleij@linaro.org>
Copyright (C) 2010 Devin Heitmueller <dheitmueller@kernellabs.com>
Copyright (c) 2019 Facebook include <linux/bpf.h> include "bpf_helpers.h" define barrier() __asm__ __volatile__("" : : "memory")
Copyright (C) 1993-1997 Michael Beck
Copyright (C) 2016 Chris Zhong <zyw@rock-chips.com>
Copyright (c) 2018, Mahesh Bandewar <maheshb@google.com>
Copyright (C) 2013, 2018 Intel Corporation Author: Bin Gao <bin.gao@intel.com>
Copyright (C) 2015 Karol Kosik <karo9@interia.eu> 2015 Samsung Electronics Author: Igor Kotrasinski <i.kotrasinsk@samsung.com>
(c) Copyright 2002-2005 Alex Williamson;(c) Copyright 2002-2003 Grant Grundler;(c) Copyright 2002-2005 Hewlett-Packard Company;(c) 2000 Grant Grundler (from parisc I/O MMU code);(c) 1999 Dave S. Miller (from spar64 I/O MMU code)
Copyright (C) 2017 The Chromium OS Authors <chromium-os-dev@chromium.org>
Copyright (c) 2007 Kevin Lo <kevlo@kevlo.org>
Copyright (c) 2013 Minchan Kim <minchan@kernel.org>
Copyright (C) 2018 Cadence Design Systems.
Copyright 2016 Nuvoton Technology Corp. Author: David Lin <ctlin0@nuvoton.com>
Copyright (C) 2004 Keith M Wesolowski (wesolows@foobazco.org);(C) David S. Miller.
Copyright (C) 2011 Renesas Solutions Corp.
Copyright 2003-2004, Instant802 Networks, Inc.
Copyright (c) 2014 Imagination Technologies Ltd. Leonid Yegoshin <Leonid.Yegoshin@imgtec.com> Author: Markos Chandras <markos.chandras@imgtec.com>
(C) Copyright 1997 Alain Malek Alain.Malek@cryogen.com)
Copyright (c) Jean-Luc Cooke <jlcooke@certaintkey.com>
Copyright (C) 1997-2003 Erez Zadok
(c) 1995,1996 Grant R. Guenther, grant@torque.net,
Copyright (C) 2009 NXP Semiconductors
Copyright (C) 2005 Paul Mundt
Copyright (C) 2014 Renesas Electronics Europe Ltd
Copyright (c) 2002 James Morris <jmorris@intercode.com.au>
Copyright (c) 1999-2004 Silicon Graphics, Inc. All Rights Reserved.
Copyright (C) 2000 Inside Out Networks, All rights reserved.
Copyright (C) 2002 Niibe Yutaka
Copyright (C) 2016 Joao Pinto <jpinto@synopsys.com>
Copyright (C) IBM Corporation, 2008-2011 Authors: Srikar Dronamraju Jim Keniston
Copyright (C) 2013-2014 Renesas Electronics Europe Ltd. Author: Guennadi Liakhovetski <g.liakhovetski@gmx.de>
Copyright (c) 2009 IBM Corporation Author: Mimi Zohar <zohar@us.ibm.com>
Copyright (C) 2014-2016 Intel Corporation.
Copyright (C) 2012 Samsung Electronics Co., Ltd. Author: Jingoo Han <jg1.han@samsung.com>
Copyright (C) 2017 - 2018 Sebastian Reichel <sre@kernel.org>
Copyright 1996-1999 Thomas Bogendoerfer
Copyright (C) 2002-2003 Andreas Gruenbacher <agruen@suse.de>
Copyright (C) 2013 ARM Ltd. All Rights Reserved
Copyright (C) 1999, 2000, 2001 by Michael Engel <engel@unix-ag.org> and Karsten Merker <merker@linuxtag.org>
Copyright IBM Corporation, 2016

Copyright (c) 2016 Chen-Yu Tsai
Copyright (c) 2006, Ian Campbell
Copyright (C) 2002, 2014 Maciej W. Rozycki
Copyright Intel Corporation (C) 2017. All Rights Reserved
Copyright (C) 2005-2007 Pierre Ossman, All Rights Reserved.
Copyright (C) 2011 Sascha Hauer, Pengutronix
(C) Copyright 2000-2001, Greg Ungerer (gerg@snapgear.com);(C) Copyright 2001-2002, SnapGear (www.snapgear.com)
Copyright (C) 2009 Matt Fleming
Copyright (c) 2014, The Linux Foundation. All rights reserved.
Copyright 2007 IBM Corp. Benjamin Herrenschmidt <benh@kernel.crashing.org>
Copyright (c) 2004 - 2013 Broadcom Corporation
Copyright (C) 2008 Sebastian Haas (initial chardev implementation)
Copyright 2002 Andy Grover <andrew.grover@intel.com>
Copyright (c) 2005-2011 Atheros Communications Inc.
Copyright 2018, Paul Cercueil <paul@crapouillou.net>
Copyright 2006 (c) MontaVista Software, Inc.
Copyright (C) 1998-2000 InnoSys Incorporated. All Rights Reserved
Copyright (C) 2008 Harald Welte <laforge@gnufish.org>
Copyright 2015 Cirrus Logic Inc
Copyright IBM Corp. 2006,2014 Author(s): Martin Schwidfsky (schwidfsky@de.ibm.com), Gerald Schaefer (gerald.schaefer@de.ibm.com)
Copyright (C) 2006 Hewlett-Packard Co Alex Williamson <alex.williamson@hp.com>
Copyright (C) 2006 Takashi YOSHII <takasi-y@ops.dti.ne.jp>
Copyright (c) 2016 Samsung Electronics Co., Ltd. Author : Chanwoo Choi <cw00.choi@samsung.com>
Copyright (c) 2001-3 Patrick Mochel
Copyright (C) 2019 MediaTek Inc. Author: Stanley Chu <stanley.chu@mediatek.com>
Copyright (C) Intel Corporation 2017
Copyright (C) 2004 FUJITSU LIMITED
Copyright (C) 2007 Andrew Murray <amurray@mpc-data.co.uk>
Copyright (C) 2005-2009 Texas Instruments, Inc.
Copyright (C) 2008 by Eric Van Hensbergen <ericvh@gmail.com>
Copyright (C) 2003 Russell King, All Rights Reserved.
Copyright(C) 2007-2011 STMicroelectronics Ltd
Copyright (c) 2000 RP Internet (www.rpi.net.au).
(C) Copyright 2005 Greg Kroah-Hartman <gregkh@suse.de>
"Copyright (C) 2005 Media Lab Inc. <ito@mlb.co.jp>"
Copyright (C) 2011-2012 Texas Instruments Incorporated
Copyright (c) 2006, Michael Wu <flamingice@sourmilk.net>
Copyright (C) 2018 Gao Xiang <gaoxiang25@huawei.com>
Copyright (C) 2011-2013 Freescale Semiconductor, Inc.
Copyright(c) 2019 Intel Corporation.
Copyright (C) 2013 Broadcom Corporation.
Copyright (C) 2005,2006 Dominik Brodowski <linux@dominikbrodowski.net>
"Copyright (C) 2014 Texas Instruments Incorporated Authors: Sandeep Nair <sandeep_n@ti.com> Sandeep Paulraj <s-paulraj@ti.com> Wingman Kwok <w-kwok2@ti.com>"
Copyright 2008-2011 Freescale Semiconductor, Inc.
Copyright 2019 Jonathan Neuschäfer
Copyright (C) 2016 Freescale Semiconductor, Inc. All rights reserved.
Copyright (C) 2018 Logic PD, Inc - http://www.logicpd.com/
Copyright (C) 1992, 1994, 1995, 2000 Free Software Foundation, Inc.
Copyright (C) 1997 Jakub Jelinek (jj@sunsite.mff.cuni.cz)
Copyright (C) 1995-1998 Mark Lord
Copyright (C) 2011 IBM Corporation
Copyright (C) International Business Machines Corp., 2002, 2011 Author(s): Steve French (sfrench@us.ibm.com), Pavel Shilovsky ((pshilovsky@samba.org) 2012
Copyright (C) 2014 Azael Avalos <coproscefalo@gmail.com>

LICENCE TERMS (cont.)

Copyright (C) 2014-2015 Pali Rohár <pali.rohar@gmail.com>
Copyright (C) 2016 Samsung Electronics Chanwoo Choi <cw00.choi@samsung.com>
Copyright (C) 2017 Jacopo Mondi <jacopo+renesas@jmondi.org>
Copyright 1997.
Copyright (C) 2009 ST Microelectronics
Copyright (C) 2011, Texas Instruments, Inc.
Copyright (c) 2013-2018, Mellanox Technologies inc. All rights reserved.
Copyright (C) 2011-2013 Pali Rohár <pali.rohar@gmail.com>
Copyright (C) 2008 Pengutronix
Copyright (C) 2017 Linus Walleij <linus.walleij@linaro.org> Derived from drivers/drm/gpu/panel/panel-samsung-ld9040.c
Copyright (C) 2015 Intel Corp Author: Fang, Yang A <yang.a.fang@intel.com> N,Harshapriya <harshapriya.n@intel.com>
Copyright (C) 2007 - 2009 Hans de Goede <hdegoede@redhat.com>
Copyright (C) 1997 Andrew Main <zefram@fysh.org>
Copyright (C) 2015-2019 Zodiac Inflight Innovations
(c) 2004 Olivier Gournet <ogournet@anavia.com> & Andrew de Quincey <adq_dvb@lidskialf.net>
Copyright (c) 2006, Intel Corporation.
Copyright (C) 2010 - 2015 UNISYS CORPORATION All rights reserved.
Copyright (C) 2001,2002,2004 Broadcom Corporation
Copyright (C) 2017 Jelle van der Waa <jelle@vdwaa.nl>
Copyright 1998--1999 Red Hat corp --- All Rights Reserved
Copyright 2009, 2010, Christian Lamparter <chunkeey@googlemail.com>
Copyright (C) 2008 David Daney
Copyright (C) 2006 Dominik Kuhlen Based on Inbp21 driver
Copyright (C) 2006 Cavium Networks Cache error handler
Copyright 2007-11 Advanced Micro Devices, Inc.
Copyright © 2014-2016 Red Hat, Inc. All Rights Reserved.
Copyright (C) 2007, 2008 David S. Miller (davem@davemloft.net)
Copyright (C) 2007-2009 Michal Simek <monstr@monstr.eu>
Copyright (C) 2007 Atmel Corporation.
Copyright (c) 2010 CompuLab Ltd
Copyright (C) 1994 - 1999, 2000, 03, 04 Ralf Baechle
Copyright (c) 2001, 2002 M. R. Brown <mrbrown@0xd6.org>
Copyright Stephan Mueller <smueller@chronox.de>, 2015 - 2019
Copyright (c) 2005-2007 Stefano Brivio <stefano.brivio@polimi.it>
Copyright (c) 2010, Applied Micro Circuits Corporation Author: Tirumala R Marri <tmarri@apm.com>
Copyright (C) 2006 Silicon Motion Technology Corp. Authors: Ge Wang, gewang@siliconmotion.com Boyod boyod.yang@siliconmotion.com.cn
Copyright(c) 2008 - 2011 Intel Corporation. All rights reserved.
Copyright (c) 2012 Guenter Roeck <linux@roeck-us.net>
Copyright (C) 2010 One Laptop per Child
Copyright 2009-2016 VMware, Inc., Palo Alto, CA., USA
Copyright (C) 2016-2017 EPAM Systems Inc.
Copyright(c) 2007 - 2014 Intel Corporation. All rights reserved.
Copyright (C) 2011-2016 Freescale Semiconductor, Inc. All Rights Reserved.
Copyright (C) 2013 Alexander Shiyan <shc_work@mail.ru>
Copyright (C) 1996, 2007 David S. Miller (davem@davemloft.net)
Copyright (C) 2008 James Bottomley <James.Bottomley@HansenPartnership.com>
Copyright 2008 - 2013 Xilinx, Inc.
Copyright (C) 2010 Texas Instruments Incorporated. Thara Gopinath
Copyright 2008 Simtec Electronics, Ben Dooks <ben@simtec.co.uk> <ben-linux@fluff.org>
Copyright (C) 2014, Cavium Inc.
(C) 2008 Wolfson Microelectronics PLC.
Copyright (C) 2009 Ilya Yanok, Emcraft Systems Ltd, <yanok@emcraft.com>
Copyright (C) 2000 James Simmons (jsimmons@linux-fbdev.org)
Copyright (C) 2000 Silicon Graphics, Inc. Written by Ulf Carlsson (ulfc@engr.sgi.com)
Copyright IBM Corp. 2012, 2014
Copyright (C) 2017 Socionext Inc.
Copyright (C) 2006 Atmel Corporation;(c) will trigger that first erratum in some cases.
Copyright (c) 2009 Orex Computed Radiography Baruch Siach <baruch@tkos.co.il>
Copyright 2016 Maxime Ripard
Copyright (C) 2012 MIPS Technologies, Inc.
Copyright (C) 2005-2006 TL Sudheendran
Copyright 2007-2008 Pierre Ossman
Copyright (C) 2012 - ARM Ltd Author: Marc Zyngier <marc.zyngier@arm.com>
Copyright 2008 Tensilica Inc. remark Read the file COPYING
Copyright (C) 2001 Russell King, All Rights Reserved.
Copyright (C) 2001 IBM.
Copyright (C) 2013-2017 Oracle Corporation
Copyright (C) 2001-2003 Hewlett-Packard Co Stephane Eranian <eranian@hpl.hp.com>
Copyright (C) 2003 Ben. Herrenschmidt (benh@kernel.crashing.org)
(C) 2002 by Harald Welte <laforge@gnumonks.org>
Copyright (C) 2001, 2002 Jeff Dike (jdike@karaya.com)
Copyright (c) 2015-2016 Quantenna Communications
Copyright (C) 2002, Linus Torvalds.
Copyright 2011 Broadcom Corporation. All rights reserved.
Copyright (c) 2016 Randy Li <ayaka@soulik.info>
Copyright (C) 2009-2010 Samsung Electronics Kyungmin Park <kyungmin.park@samsung.com> Marek Szymowski <m.szymowski@samsung.com>
Copyright 2015 Realtek Semiconductor Corp.
Copyright 2011 Freescale Semiconductor, Inc. All Rights Reserved.
Copyright 2015, Anshuman Khandual, IBM Corporation.
Copyright (C) 2012 DENX Software Engineering Anatolij Gustschin <agust@denx.de>
Copyright (C) 1995, 1996, 2007 David S. Miller (davem@davemloft.net)
Copyright (c) 2011-2017, The Linux Foundation
Copyright (C) 2012 Renesas Electronics Europe Ltd
Copyright (C) 2010 Michael Neuling IBM Corporation
Copyright (C) 2008 Antoine Jacquet <royale@zerezo.com> http://royale.zerezo.com/dtv5100/
Copyright (C) 2007-2010 Advanced Micro Devices, Inc. Author: Joerg Roedel <joerg.roedel@amd.com> Leo Duran <leo.duran@amd.com>
Copyright (c) 2012, 2013 Intel Corporation. All rights reserved.
Copyright (c) 2011-2014 Samsung Electronics Co., Ltd. http://www.samsung.com/
Copyright (C) 2015 Linaro
Copyright © 2008 Traverse Technologies
Copyright IBM Corp. 2017
Copyright (C) 1991, 1992, 1996 Linus Torvalds
Copyright 1995 Roger C. Pao
(C) 1999-2001 James Morris <jmorros@intercode.com.au>
Copyright (C) 2018 Renesas Electronics Corp.
Copyright (C) 2001, 2002 Andy Grover <andrew.grover@intel.com>
Copyright (c) Intel Corp. 2007. All Rights Reserved.
Copyright (c) 2006 Freescale Semiconductor, Inc.
Copyright (c) 2018 Mellanox Technologies
Copyright (C) 2017 Moxa Inc. - https://www.moxa.com/
Copyright (C) 2017-2018 Etnaviv Project
Copyright (C) 2016-2019 Cirrus Logic, Inc. and Cirrus Logic International Semiconductor Ltd.
Copyright (c) 2008 Magnus Damm;(c) 2007 Mauro Carvalho Chehab, <mchehab@kernel.org>
Copyright (c) 2004 Patrick McHardy <kaber@trash.net>;(C) 2007 Laszlo Attila Toth <panther@balabit.hu>
Copyright (C) 2001,2002 Networks Associates Technology, Inc.
Copyright © 2011 Tony Breeds IBM Corporation
Copyright (C) 2002 Intersil Americas Inc.
Copyright 2017 Broadcom
Copyright (C) 2019 Amarula Solutions B.V. Author: Jagan Teki <jagan@amarulasolutions.com>

LICENCE TERMS (cont.)

Copyright (c) 2017 Microsemi Corporation
Copyright (C) 2014-15 Synopsys, Inc. (www.synopsys.com)
"(c) 1999 Andreas Gal <gal@cs.uni-magdeburg.de>;(c) 2000-2001 Vojtech Pavlik <vojtech@ucw.cz>;(c) 2007-2009 Jiri Kosina"
Copyright (C) 2004 - 2005, Milton D Miller II, IBM Corporation
Copyright 2008 Openmoko Inc.
Copyright (C) 2014 ARM Ltd.
Copyright (C) 2008, 2009 PMC Sierra Inc.
Copyright (C) Matthijs Kooijman <matthijs@stdn.nl>
Copyright 2016-2018 Vladimir Zapolskiy <vz@mleia.com>
Copyright 2019, IBM Corporation
Copyright (C) 2005 Kontron Canada
Copyright (C) 2015 Anton Ivanov (aivanov@{brocade.com,kot-begemot.co.uk})
Copyright (C) 1995, 2003 by Ralf Baechle
Copyright (c) 2006-2007 Philipp Zabel
Copyright (C) 2014 Citrix Systems R&D Ltd.
Copyright IBM Corp. 2008, 2015
Copyright (C) 2018 Martin Ayotte <martinayotte@gmail.com>
Copyright (C) 2010-2011 Nokia Corporation
Copyright 2017, Anshuman Khandual, IBM Corp.
Copyright (C) 2012 Intel Corporation.
Copyright: [copy] 2010-2011 Rafael J. Wysocki <rjw@sisk.pl>, Novell Inc.
Copyright (C) 2008 Renaud CERRATO r.cerrato@til-technologies.fr
Copyright (C) 2001, 2002 Paul Diefenbaugh <paul.s.diefenbaugh@intel.com>
Copyright (C) 2002 Hewlett-Packard Co David Mosberger-Tang <davidm@hpl.hp.com>
Copyright (C) 2009 Red Hat, Inc. All Rights Reserved. Written by David Howells (dhowells@redhat.com)
Copyright (C) 2018 Red Hat, Inc.
Copyright (C) 2001 Jeff Dike (jdike@karaya.com)
(C) 2010,2011 Thomas Renninger <trenn@suse.de>, Novell Inc
Copyright (c) 1996-2006, 2013-2016, Ericsson AB
Copyright (C) 2017 NXP. All Rights Reserved.
Copyright 2014-2016 Google Inc.
Copyright (c) 2008 Neil Horman <nhorman@tuxdriver.com>
Copyright (C) 2011-2012 CERN (www.cern.ch) Author: Samuel Iglesias Gonsalvez <siglesias@igalia.com>
Copyright (c) 2017-2018 Western Digital Corporation or its affiliates.
Copyright (C) 2009 Marc Zyngier <maz@misterjones.org>
Copyright 2013 Philipp Zabel, Pengutronix
Copyright (c) 2011 Logitech
Copyright IBM Corp. 2016, 2018
Copyright (C) 2011 Texas Instruments, Inc. Santosh Shilimkar <santosh.shilimkar@ti.com>
Copyright (C) 2002 David McCullough <davidm@snapgear.com>
Copyright (c) 2007 Rodolfo Giometti <giometti@linux.it>
Copyright © 2010-2015 Broadcom Corporation
Copyright 2006 Freescale Semiconductor Inc.
Copyright (C) 2008 Intel Corporation <linux-wimax@intel.com> Inaky Perez-Gonzalez <inaky.perez-gonzalez@intel.com>
Copyright (c) 2010-2013, NVIDIA Corporation. All rights reserved.
Copyright (C) 2013, Sylvester Nawrocki <sylvester.nawrocki@gmail.com>
Copyright (C) 2017 Marvell Author: Miquel RAYNAL <miquel.raynal@free-electrons.com>
Copyright (C) 2013 Texas Instruments Incorporated - URL: http://coccinelle.lip6.fr/ Options: --include-headers
Copyright (C) ST-Ericsson AB 2012 Author: Sjur Brandeland <sjur.brandeland@stericsson.com>
(C) 2006 by Patrick McHardy <kaber@trash.net>;(C) 2004 by Bart De Schuymer <bdschuyem@pandora.be>
Copyright (C) 2016 Google, Inc
Copyright (C) 2003-2010 PEAK System-Technik GmbH
Copyright (C) 2015, 2016 Imagination Technologies Ltd.
Copyright (C) 2007 Imre Kaloz <kaloz@openwrt.org>
Copyright (C) 2004,2005,2009 Simtec Electronics Ben Dooks <ben@simtec.co.uk>

Copyright 2018 NXP. Dong Aisheng <aisheng.dong@nxp.com>
Copyright (C) 2017-2018 Broadcom. All Rights Reserved.
Copyright (C) 2012 ARM Limited Author: Will Deacon <will.deacon@arm.com>
Copyright (C) 2017 Horms Solutions Ltd., Simon Horman
Copyright (c) 2010-2012 by Nibble Max <nibble.max@gmail.com>
Copyright (C) 2017 Intel Corporation. All rights reserved.
Copyright 2009 Freescale Semiconductor Inc.
Copyright (C) 1994, 1995, 1996, 1997, 2000, 2001 by Ralf Baechle
Copyright (C) 2012 Laurent Pinchart <laurent.pinchart@ideasonboard.com>
Copyright (C) 2010-2013 Texas Instruments Incorporated - http://www.ti.com
Copyright (C) 1996-2000 Thomas Sailer (sailer@ife.ee.ethz.ch)
Copyright 2004-2009 Simtec Electronics Ben Dooks <ben@simtec.co.uk>
Copyright (C) 2000 Qlogic Corporation www.qlogic.com
Copyright (c) 2008 Atheros Communications Inc.
Copyright (C) 2000 Jeff Dike (jdike@karaya.com)
Copyright (C) 2005, 2006 Tensilica Inc.
Copyright (c) 2003 Stephen Hemminger <shemminger@osdl.org>
Copyright (C) 2011 Samsung Electronics Co.Ltd Author: Jinguo Han <jg1.han@samsung.com> Author: Joonyoung Shim <jy0922.shim@samsung.com>
Copyright (C) 1995, 96, 99, 2001, 06 Ralf Baechle
Copyright (C) 2016-2018 Vladimir Zapolskiy <vz@mleia.com>
Copyright 2015 Advanced Micro Devices, Inc.
Copyright (C) 1999, 2000, 01, 03, 06 Ralf Baechle
Copyright (c) 2010 Gregoire Baron <baronchon@n7mm.org>
Copyright 2015 Gridpoint
Copyright (C) 1996-1997 Paul H. Hargrove;(C) 2003 Ardis Technologies <roman@ardistech.com>
Copyright (c) 2000-2003 Silicon Graphics, Inc. All Rights Reserved.
Copyright IBM Corp. 1999, 2016
Copyright (c) 2002 Mark D. Stuebaker <mduxy123@yahoo.com> With assistance from Trent Piepho <xzyzy@speakeasy.org>
Copyright (C) 2004 Antonio Mancuso <antonio.mancuso@digitaltelevision.it> Amauri Celani <acelani@esegi.net>
Copyright 2006 Tungsten Graphics Inc., Bismarck, ND., USA. All rights reserved.
Copyright (C) 2002-2005 Julien Lerouge, 2003-2006 Karol Kozimor
Copyright (C) 2011 ST-Ericsson SA Written on behalf of Linaro for ST-Ericsson Based on bits of regulator core, gpio core and clk core
Copyright (C) 2004-2005 Sylvain Munaut <tnt@246tnt.com>
Copyright (C) 2007,2008 Freescale Semiconductor, Inc.
Copyright (c) 2014 - 2018 Google, Inc
Copyright 1993, Drew Eckhardt Visionary Computing Unix and Linux consulting and custom programming) drew@colorado.edu 1 (303) 440-4894;(c) 1994,1995,1996, Kevin Lentin K.Lentin@cs.monash.edu.au;(c) 1996, Ingmar Baumgart ingmar@gonzo.schwaben.de;(c) 1997, Ronald van Cuijlenborg ronald.van.cuijlenborg@tip.nl or nutty@dds.nl
Copyright (C) 1995 - 1998 by Andreas Busse and Ralf Baechle
Copyright (C) 2015-2019 Renesas Electronics Corporation
Copyright IBM Corporation, 2015 Author Aneesh Kumar K.V <aneesh.kumar@linux.ibm.com>
Copyright 1993-1999 NVIDIA, Corporation. All rights reserved.
Copyright (c) 2019, The Linux Foundation. All rights reserved.
Copyright (c) 2005 Henk Vergonet <Henk.Vergonet@gmail.com>
Copyright(c) 2008 - 2014 Intel Corporation. All rights reserved.
Copyright 2005 Simtec Electronics Ben Dooks <ben@simtec.co.uk>
(c) 1996 Hans-Joachim Widmaier - Rewritten;(C) 1993 Ray Burr - Modified for Amiga FFS filesystem.:(C) 1992 Eric Youngdale Modified for ISO 9660 filesystem.:(C) 1991 Linus Torvalds - minix filesystem
Copyright (c) 2019 HiSilicon Limited.
Copyright (C) 2010-2013 Freescale Semiconductor, Inc. All Rights Reserved.
(C) 2011 - 2014 Srivatsa S. Bhat <srivatsa.bhat@linux.vnet.ibm.com>
Copyright (C) 1995-1997 Paul H. Hargrove
Copyright (C) 2010, 2011 Ericsson AB.

LICENCE TERMS (cont.)

Copyright (C) 2006, 2007 Martin Michlmayr <tbm@cyrius.com>
Copyright (C) 2005-2018 Andes Technology Corporation
Copyright (c) StreamUnlimited GmbH 2013 Marek Belisko <marek.belisko@streamunlimited.com>
Copyright (c) 2013, Sony Mobile Communications AB.
Copyright(c) 2019 Björn Töpel <bjorn.topel@gmail.com>
(C) 2000-2002 by Harald Welte <laforge@gnumonks.org> based on RR's ip_contrack_ftp.c;(C) 2006-2012 Patrick McHardy <kaber@trash.net>
Copyright (c) 2016, Linaro Ltd
Copyright (C) 1996 by Erik Stahlman
Copyright (c) by Paul Barton-Davis <pbdb@op.net>
Copyright 2018 Advanced Micro Devices, Inc.
Copyright (c) 2001-2003 Patrick Mochel <mochel@osdl.org>
Copyright (c) 2004 Mellanox Technologies Ltd. All rights reserved.
Copyright (C) 2014 Renesas Electronics Corporation
Copyright 2016 - Lee Jones <lee.jones@linaro.org>
Copyright (C) 2006, Intel Corp. All rights reserved.
Copyright (C) Fuzhou Rockchip Electronics Co.Ltd Author: Sandy Huang <hjc@rock-chips.com>
Copyright (c) 2015, Applied Micro Circuits Corporation Author: Feng Kan <fkan@apm.com> Loc Ho <lho@apm.com>
Copyright (C) 2001 by Andreas Gruenbacher <a.gruenbacher@computer.org>
Copyright © 2008 Intel Corporation 2014 Red Hat Inc.
Copyright 2016-17 IBM Corp.
Copyright (C) 2009 Hewlett-Packard Development Company, L.P.
Copyright (c) 2008,2009 NEC Software Tohoku, Ltd. Written by Takashi Sato <t-sato@yk.jp.nec.com> Akira Fujita <a-fujita@rs.jp.nec.com>
Copyright (c) 2019 Facebook define STACK_MAX_LEN 100 include "pyperf.h"
Copyright 2008 (c) Intel Corporation Jesse Barnes <jbarnes@virtuousgeek.org>
Copyright (C) 2009 Texas Instruments, Inc
Copyright (C) 2016 Martin Blumenstingl <martin.blumenstingl@googlemail.com>
Copyright 2017 Google, Inc
Copyright (c) 2016 Samsung Electronics Co., Ltd
Copyright (c) 2016 Microsemi Corporation
Copyright (c) 2012 - 2019 Intel Corporation. All rights reserved.
Copyright (c) 2006-2011 Freescale Semiconductor, Inc.
Copyright (C) 2013 Philipp Zabel
"Copyright (c) 2007-2009 Jiri Kosina"
Copyright (C) 2008 Riku Voipio <riku.voipio@mivial.fi>
Copyright STMicroelectronics, 2007.
(C) Copyright 2017-2018 - Mathieu Desnoyers <mathieu.desnoyers@efficios.com>
Copyright IBM Corp. 2010
Copyright (C) 2012 Texas Instruments Incorporated - <http://www.ti.com/> Contact: Eduardo Valentin <eduardo.valentin@ti.com>
(c) GE Intelligent Platforms Embedded Systems, Inc.
Copyright (c) 2015 MediaTek Inc. Author: Koro Chen <koro.chen@mediatek.com>
Copyright (c) 2008 Dmitry Eremin-Solenikov
Copyright (C) 1999 Eric A. Thomas
Copyright (c) 2012 Intel Corporation
Copyright (c) 2003+ Evgeniy Polyakov <zbr@ioremap.net>
Copyright (C) 2011-2014 NVIDIA CORPORATION. All rights reserved.
Copyright (c) 2018 Samsung Electronics Co., Ltd. <http://www.samsung.com>
Copyright (C) 1999, 2003 Hewlett-Packard Co David Mosberger-Tang <davidm@hpl.hp.com>
Copyright © 2014 Jussi Kivilinna <jussi.kivilinna@mbnet.fi>
Copyright (C) 2006, 8D Technologies inc.
Copyright 1994-2000 Paul Mackerras.
Copyright IBM Corp. 2015 Author(s): Peter Oberparleiter <oberpar@linux.vnet.ibm.com>
Copyright (C) 2009 Martin Fuzzzey <mfuzzzey@gmail.com>
Copyright (c) 2001-2002, SSH Communications Security Corp and Jouni Malinen j@w1.fi>

Copyright (C) 2013 IBM
Copyright 2014 Cisco Systems, Inc. and/or its affiliates. All rights reserved.
Copyright (C) 2007 kavol
Copyright (c) 2003-2019, Intel Corporation. All rights reserved. Intel Management Engine Interface (Intel MEI) Linux driver
Copyright(c) 2017 Intel Deutschland GmbH
(C) Copyright 2007-2008 Xilinx, Inc.:(C) Copyright 2007-2009 Michal Simek
Copyright (C) 2007 Intel Corporation Inaky Perez-Gonzalez <inaky.perez-gonzalez@intel.com>
(C) Copyright 1999 Roman Weissgaerber <weissg@vienna.at>;(C) Copyright 2000-2002 David Brownell <dbrownell@users.sourceforge.net>;(C) Copyright 1999 Linus Torvalds];(C) Copyright 1999 Gregory P. Smith]
(C) 2003 Bruno Ducrot;(C) 2004 Dominik Brodowski <linux@dominikbrodowski.de>
Copyright (c) by Jaroslav Kysela <perex@perex.cz>,
Copyright (c) 2013 NVIDIA CORPORATION. All rights reserved.
Copyright (c) 2017-2018 Ondrej Mosnacek <omosnacek@gmail.com>
Copyright 1994 Roman Hodek <Roman.Hodek@informatik.uni-erlangen.de>
Copyright (c) 2011, NVIDIA CORPORATION. All rights reserved.
(c) Copyright 2001 Scott Jennings <linuxdrivers@oro.net> 9/27 - 2001 [Initial release]
Copyright (C) 2016 ARM
Copyright(c) 2014 Intel Corporation.
Copyright 2013 Canonical Ltd.
Copyright (c) 2002-2004 by Karsten Wiese
Copyright (C) 2016, Mario Lange <mario_lange@gmx.net>
Copyright 2007 David Gibson, IBM Corporation.
Copyright (C) 2002 by Concurrent Computer Corporation
Copyright (C) 2007-2009 ST-Ericsson AB Real Time Clock interface for ST-Ericsson AB COH 901 331 RTC. Author: Linus Walleij <linus.walleij@stericsson.com> Based on rtc-pl031.c by Deepak Saxena <dsaxena@plexity.net>
Copyright (C) 1998-2005 Hewlett-Packard Co David Mosberger-Tang <davidm@hpl.hp.com>
Copyright (C) 2008-2011 Texas Instruments, Inc.
Copyright (C) 2011 Malcolm Priestley (tvboxspy@gmail.com)
Copyright 2005 Mentor Graphics Corporation
Copyright (C) 2017 Finn Thain
Copyright (c) 2011 Mircea Gherzan <mgherzan@gmail.com>
Copyright (C) 2016 Allied Telesis Labs
Copyright (c) 2015, Primary Data, Inc. All rights reserved.
Copyright (C) 2011 Texas Instruments, Inc.
Copyright (c) by Jaroslav Kysela <perex@perex.cz>
Copyright (c) 2004-2009 Reyk Floeter <reyk@openbsd.org>
Copyright (C) IBM Corp. 2006
Copyright (C) 2018 Bootlin Mylène Josserand <mylene.josserand@bootlin.com>
Copyright (C) ST-Ericsson AB 2010 Author: Daniel Martensson
Copyright (C) 2012 MIPS Technologies, Inc. All rights reserved.
Copyright 1999 by M. Steinkopf
Copyright (c) 2008 Bernhard Weirich <bernhard.weirich@riedel.net>
Copyright (C) 1999 Silicon Graphics, Inc. (Jeffrey Newquist)
Copyright 2010 Yong Shen <yong.shen@linaro.org>
Copyright (C) 2008 Kim B. Heino
Copyright (C) 2006 Paul Mundt
Copyright © 2011 Intel Corporation
Copyright (C) 2012 - Virtual Open Systems and Columbia University Authors: Rusty Russell <rusty@rustcorp.au>
Christoffer Dall <c.dall@virtualopensystems.com>
Copyright (C) 1995-2001 by Russell King
(C) Copyright 2016 Valentin Longchamp, Keymile AG, valentin.longchamp@keymile.com
Copyright (C) 2004 Adam Litke (agl@us.ibm.com)
Copyright (c) by Jaroslav Kysela <perex@perex.cz>, Hannu Savolainen 1993-1996, Rob Hooff
Copyright (C) 2009-2013 VMware, Inc. All rights reserved.
Copyright (C) 2019, Intel Corporation Author: Mika Westerberg <mika.westerberg@linux.intel.com>
Copyright(c) 1999 - 2008 Intel Corporation.

LICENCE TERMS (cont.)

Copyright (C) 2012 ARM Ltd.
Copyright (C) 1995-1999 Gary Thomas, Paul Mackerras, Cort Dougan.
Copyright (C) 2005 Lothar Wassmann <LW@KARO-electronics.de>
Copyright (C) 2009 Ming Lei <ming.lei@canonical.com>
Copyright (C) 2009-2012 Konstantin Dimitrov <kosio.dimitrov@gmail.com>
Copyright (c) 2016 Rockchip Electronics Co. Ltd. Author: Xing Zheng <zhengxing@rock-chips.com>
(c) UCB 1986-1988 for the purposes of compatibility only.
Copyright (C) 2007 Lemote Inc. & Institute of Computing Technology Author: Fuxin Zhang, zhangfx@lemote.com
Copyright (c) 2011-2016 Advanced Micro Devices, Inc. Author: Andreas Herrmann <herrmann.der.user@googlemail.com>
Copyright (C) 2014 Dell Inc <mario_limonciello@dell.com>
Copyright (c) 2001-2004 by David Brownell
Copyright 2015 Gábor Nyers
Copyright 2014 Realtek Microelectronics
Copyright (c) 2012 Dialog Semiconductor
Copyright (c) 2014 Chelsio, Inc. All rights reserved.
Copyright (c) 2012 Google, Inc
Copyright (C) 1994,1995 Australia. E-mail billm@jacobi.maths.monash.edu.au |
Copyright 2003-2006 Red Hat, Inc. All rights reserved.
Copyright (c) 2019 Linaro Ltd
Copyright 2003-2004 Red Hat Inc., Durham, North Carolina. All Rights Reserved.
Copyright (C) 1995 Jay Estabrook
Copyright (C) 2018 Linaro Ltd
Copyright (c) 2019, Intel Corporation. Author: Andy Shevchenko <andriy.shevchenko@linux.intel.com>
Copyright (C) 2006, 07 MIPS Technologies, Inc. written by Ralf Baechle (ralf@linux-mips.org) written by Ralf Baechle <ralf@linux-mips.org>
Copyright (C) 1999 Steve Ratcliffe
Copyright (c) 2011-2014 PLUMgrid, http://plumgrid.com
Copyright (c) 2001,2002 Christer Weinigel <wingel@nano-system.com>
(C) 1997 Linus Torvalds;(C) 1999 Andrea Arcangeli <andrea@suse.de> (dynamic inode allocation)
Copyright (c) 2012-2016 Pablo Neira Ayuso <pablo@netfilter.org>
Copyright 2012 Matt Evans & Michael Neuling, IBM Corporation.
Copyright (C) 1999 Brad Boyer (flar@pants.nu);(C) 2003 Ardis Technologies <roman@ardistech.com>
Copyright (c) 2012-2013, Wind River Systems
Copyright 2015 Lawrence Yu <lyu@micile.com>
Copyright (c) 2011 Logitech (c)
Copyright 1997-1998 Transmeta Corporation -- All Rights Reserved
Copyright (c) 2014, Intel Corporation All rights reserved.
Copyright (C) 2002 ARM Ltd. All Rights Reserved
Copyright (C) 2015 Atmel, 2015 Ludovic Desroches <ludovic.desroches@atmel.com>
(c) 2004 Andrew de Quincey <adq_dvb@lidskialf.net>
Copyright 2008-2009 Freescale Semiconductor, Inc. All Rights Reserved. Author: Alan Carvalho de Assis <acassis@gmail.com>
Copyright 2010 One Laptop Per Child
Copyright (C) 2001 Ivan Martinez <ivanmr@altavista.com>
Copyright © 2011-2018 VMware, Inc., Palo Alto, CA., USA All Rights Reserved.
Copyright (c) 2016 Rockchip Electronics Co. Ltd. Author: Shawn Lin <shawn.lin@rock-chips.com>
Copyright (C) 2005 Patrick Boettcher (patrick.boettcher@posteo.de)
Copyright (C) 2007,2008 Freescale Semiconductor, Inc. All rights reserved.
Copyright (C) Russell King
Copyright (C) 2009, Wind River Systems Inc Implemented by fredrik.markstrom@gmail.com and ivarholmqvist@gmail.com
Copyright (c) 2016, Linaro Limited Author: Linus Walleij <linus.walleij@linaro.org>
Copyright (c) 2008-2009 Marvell Semiconductor
Copyright (C) 2006,2008 David Brownell
Copyright (c) 2008 Intel Corporation Author: Matthew Wilcox <willy@linux.intel.com>
Copyright (C) 2001-2012 GUAN Xue-tao
Copyright (C) 1996, 2000 by Ralf Baechle
Copyright (C) 2015 Intel Corporation Mian Yousaf Kaukab <yousaf.kaukab@intel.com>
Copyright (C) 2007 Craig W. Nadler <craig@nadler.us>
Copyright (C) 2001 Dave Engebretsen, IBM Corporation
Copyright (c) by Jaroslav Kysela <perex@perex.cz> Abramo Bagnara <abramo@alsa-project.org> Cirrus Logic, Inc. Routines for control of Cirrus Logic CS461x chips
Copyright (c) 2007-2008 Claudio Nieder
Copyright 2015 Carnegie Mellon University
Copyright (C) 2013 - Rodolfo Giometti <giometti@linux.it> HCE Engineering
Copyright (C) 1994, 95, 96, 97, 98, 99, 2003, 06 by Ralf Baechle
Copyright (C) 2008 Kyle McMartin <kyle@mcmartin.ca>
Copyright (C) 2008 Hewlett-Packard Development Company, L.P. David Altobelli <david.altobelli@hp.com>
Copyright 2002-2005, Instant802 Networks, Inc.
Copyright (C) 1997, 2007, 2008 David S. Miller (davem@davemloft.net)
Copyright (c) 1994-2001 by Jaroslav Kysela <perex@perex.cz>
Copyright (C) 2016 Alison Schofield <amsfield22@gmail.com>
Copyright(c) 2012 - 2014 Intel Corporation. All rights reserved.
Copyright (c) 2003-2017 QLogic Corporation
Copyright (C) 2018 Netronome Systems, Inc.
Copyright 2012 Freescale Semiconductor Inc.
Copyright (c) 1999 Vojtech Pavlik <vojtech@suse.cz>
Copyright (C) 2011 Antonio Ospite <ospite@studenti.unina.it>
Copyright (c) MontaVista Software, Inc. 2008.
Copyright (c) 2011, Creative Technology Ltd.
Copyright 2015-2016 Freescale Semiconductor Inc.
Copyright (C) 1999-2002 Hewlett-Packard Co Stephane Eranian <eranian@hpl.hp.com> David Mosberger-Tang <davidm@hpl.hp.com>
Copyright (C) 2015 Alexander Sverdlin
Copyright (C) 2000,2001 David A. Schleaf <ds@schleaf.org>
Copyright(c) 2016 - 2019 Intel Corporation.
Copyright IBM Corp 2003, 2010 Author(s): Martin Schwidefsky <schwidefsky@de.ibm.com>,
Copyright (C) 1996-2001 Paul Mackerras (paulus@cs.anu.edu.au) Ben. Herrenschmidt (benh@kernel.crashing.org)
Copyright (C) 2019 Yangtao Li <tiny.windzz@gmail.com>
(C) Copyright 1995 by Geert Uytterhoeven <geert@linux-m68k.org>;(C) Copyright 1995 by Geert Uytterhoeven, Peter De Schrijver
Copyright (C) 2011-2015 John Crispin <blogic@phrozen.org>
Copyright © 2016 IBM Corporation
Copyright (c) 2010 Mauro Carvalho Chehab <mchehab@kernel.org>
Copyright (C) 2001 Thomas Bogendoerfer <tsbogend@parisc-linux.org>
Copyright 2014 Ideas on Board Oy
"Copyright (C) 1998-2003 Hewlett-Packard Co David Mosberger-Tang <davidm@hpl.hp.com> 04/11/17 Ashok Raj <ashok.raj@intel.com> Added CPU Hotplug Support"
(C) 1997-1998 Caldera, Inc.:(C) 1999-2001 Torben Mathiasen
Copyright(c) 2007 - 2018 Intel Corporation.
Copyright (C) 2018 Intel Corporation
Copyright (C) 2018 - 2019 Texas Instruments Incorporated - http://www.ti.com/ Author: Kishon Vijay Abraham I <kishon@ti.com>
Copyright (C) 2019 Martin Kaiser <martin@kaiser.cx>
Copyright 2014 Roy Spliet
Copyright (C) 2015 EMC Corporation. All Rights Reserved.
Copyright (C) 2015 - Linaro Ltd
Copyright (c) 2010, Applied Micro Circuits Corporation Author: Rupjyoti Sarmah <rsarmah@apm.com>
Copyright (C) 2010 by Ondrej Zary some parts inspired by the cxacru driver
Copyright (C) 2000-2002 Mark Lord <mlord@pobox.com> May be copied or modified under the terms of the GNU General Public License
Copyright (c) Freescale Semicondutor, Inc. 2006, 2011. Shlomi Gridish <gridish@freescale.com> Jerry Huang <Chang-Ming.Huang@freescale.com>

LICENCE TERMS (cont.)

Copyright (C) 2007 Wolfgang Grandegger <wg@grandegger.com>
(C) Copyright 2012, Steven King <sfking@fdwdc.com>
Copyright (C) 2012 Samsung Electronics Co., Ltd.
Copyright (c) 2012-2013 Dongjin Kim (tobetter@gmail.com)
Copyright (C) 2001 Lennert Buytenhek (buytenh@gnu.org)
Copyright (C) 2012 Vista Silicon Javier Martin <javier.martin@vista-silicon.com>
Copyright (C) 2013, 2014 Linaro Ltd.
Copyright (C) 2015 Atmel, 2015 Nicolas Ferre <nicolas.ferre@atmel.com>
Copyright (c) 2005 Keir Fraser
Copyright (C) 2014 STMicroelectronics Limited. Author: Peter Griffin <peter.griffin@linaro.org>
Copyright (C) 2015 Glider bvba
Copyright (C) 2016-2017 Cogent Embedded Inc.
Copyright (C) 2015-2018 Matt Ranostay Author: Matt Ranostay <matt.ranostay@konsulko.com>
Copyright (c) 2016 SUMOMO Computer Association https://www.sumomo.mobi Randy Li <ayaka@soulik.info>
Copyright (C) 1998, 1999, 2001-2002, 2004 Hewlett-Packard Co David Mosberger-Tang <davidm@hpl.hp.com>
Copyright 2002 by Andreas Eversberg (jolly@eversberg.eu)
Copyright (c) 2000-2002 Helge Deller, Matthew Wilcox
Copyright (C) 1992 by Linus Torvalds
Copyright (c) 2018 Texas Instruments MMC IOdelay values for TI's DRA76x and AM576x SoCs. Author: Sekhar Nori <nsekhar@ti.com>
Copyright (c) 2018, The Linux Foundation
Copyright 2016 Jonathan Cameron <jic23@kernel.org>
Copyright IBM Corp. 2008, 2012 Author(s): Cornelia Huck <cornelia.huck@de.ibm.com>
Copyright (C) 2009 Alexander Gordeev <lasaine@lvk.cs.msu.su>
Copyright (C) 1997 Richard Günther
Copyright 1999 Silicon Integrated System Corporation References
Copyright (C) 2003 Sistina Software
Copyright (C) 2018, Tianjin KYLIN Information Technology Co., Ltd.
Copyright (C) 2004, 2012 Freescale Semiconductor, Inc All rights reserved.
Copyright (C) 2016, ARM Ltd. Written by: Juri Lelli, ARM Ltd.
Copyright IBM Corp. 2002, 2017
Copyright (C) 2018 Microchip Technology
Copyright 2003 PathScale, Inc.
Copyright (C) 2008 Marvell International Ltd. All rights reserved.
Copyright (C) 2011 - CompuLab, Ltd. Author: Mike Rapoport <mike@compulab.co.il>
Copyright (c) 2012 Intel Corporation Author: Liu, Jinsong <jinsong.liu@intel.com> Author: Jiang, Yunhong <yunhong.jiang@intel.com> Author: Ke, Liping <liping.ke@intel.com>
Copyright (C) 1998 Ingo Molnar
Copyright (C) 2013 Huawei Ltd. Author: Jiang Liu <liuj97@gmail.com>
(c) UCB 1986-1988 Portions taken from the KA9Q/NOS (v2.00m PA0GRI) source. Ross Biro Fred N. van Kempen, <waltje@uWalt.NL.Mugnet.ORG> Florian La Roche, Jonathan Hayes <layes@loran.com> Arnaldo Carvalho de Melo <acme@conectiva.com.br> ARPHRD_HWX25
Copyright (C) 1994, 95, 96, 2003 by Ralf Baechle DECStation modifications by Paul M. Antoine, 1996
Copyright (c) 2017-2019 Mauro Carvalho Chehab <mchehab@kernel.org>
Copyright (C) 2011-12 Wolfram Sang, Pengutronix
Copyright (C) 2006 <davem@davemloft.net>
Copyright (C) 2015 Red Hat. All rights reserved.
Copyright (C) 2006, 2007, 2008 Kevin Lloyd <klloyd@sierrawireless.com>,
Copyright 2002 Yoichi Yuasa <yuasa@linux-mips.org>
Copyright (C) 2017, Topic Embedded Products
Copyright (C) 2004-2006 Red Hat, Inc., Ingo Molnar <mingo@redhat.com>
Copyright(c) 2013 - 2014, 2019 Intel Corporation. All rights reserved.
Copyright (c) 2007 Daniel Mack friendly supported by NI.
Copyright (C) 1992 Dana L. How
Copyright (C) 1997, 2006 David S. Miller (davem@davemloft.net)
Copyright (C) 2016 Asahi Kasei Microdevices Corporation
Copyright (C) 1995, 2001 Compaq Computer Corporation

Copyright (C) 2007 Davide Libenzi <davidel@xmailserver.org>
Copyright (C) 2007 Ralf Baechle (ralf@linux-mips.org)
Copyright (c) 2018 Synopsys, Inc. and/or its affiliates. stmmac HW Interface Handling
Copyright (c) 2016 Oracle and/or its affiliates. All rights reserved. Author: Khalid Aziz (khalid.aziz@oracle.com)
Copyright (c) 2013 by Mauro Carvalho Chehab
Copyright (C) 2016-2017 Oracle Corporation
Copyright (c) 2019 David Ahern <dsahern@gmail.com>. All rights reserved.
Copyright (c) 2005 Arnaud Patard <arnaud.patard@rtp-net.org>
Copyright (C) 2010 Digital Devices GmbH
Copyright (C) 2005 Intel Corp Venkatesh Pallipadi <venkatesh.pallipadi@intel.com>
Copyright (C) 2003-2008 Alan Stern
Copyright (C) 05/1998 Peter Maydell <pmaydell@chiark.greenend.org.uk>
Copyright (C) 2007 Marvell International Ltd. 2008-02-28: Yong Yao <yaoyong@marvell.com> initial version
Copyright 2016 Elettra-Sincrotrone Trieste S.C.p.A.
Copyright (C) 2015 Goldelico GmbH
Copyright (C) 1998-2000 by Microgate Corporation
(C) Copyright IBM 2005
Copyright (C) 2009-2012 ST Microelectronics Rajeev Kumar <rajeev-dlh.kumar@st.com> Viresh Kumar <vireshk@kernel.org>
Copyright (c) 2017 BayLibre SAS Author: Neil Armstrong <narmstrong@baylibre.com>
Copyright (C) 2018 MediaTek Inc. Author: Zhiyong Tao <zhiyong.tao@mediatek.com>
Copyright 2008 Kristoffer Ericson <kristoffer.ericson@gmail.com> this driver is based on leds-spitz.c by Richard Purdie.
Copyright (C) 2011-2012 Texas Instruments
Copyright (C) 2019 Helge Deller <deller@gmx.de>
Copyright (C) 2018 Spreadtrum Communications Inc.
Copyright (C) 2016 Laurent Pinchart <laurent.pinchart@ideasonboard.com>
Copyright 2007-2010 VMware, Inc., Palo Alto, CA., USA
Copyright (C) 2002 Sistina Software (UK) Limited.
Copyright (C) 2018 EETS GmbH - http://www.eets.ch/
Copyright (C) 2009-2010 Guennadi Liakhovetski <g.liakhovetski@gmx.de>
Copyright 31 August 2008 James Bottomley
Copyright (C) 2014-2016 Freescale Semiconductor, Inc. All Rights Reserved.
(c) Copyright 2018 Hewlett Packard Enterprise Development LP Thomas Mingarelli <thomas.mingarelli@hpe.com>
Copyright (c) 2000 by Takashi Iwai <tiwai@suse.de>
Copyright (c) 1996, 1997 David A. van Leeuwen.
Copyright (C) 2017-2018 Laurent Pinchart
Copyright (c) 2014 Actions Semi Inc.
Copyright 2011-2016 by Emese Revfy <re.emese@gmail.com> v2, or (at your option) v3
Copyright 2017-2018 NXP .
Copyright 1997 by Carsten Paeth <calle@calle.de>
Copyright (C) IBM Corporation, 2004
Copyright(c) 2018 Intel Corporation. All rights reserved. Author: Liam Girdwood <liam.r.girdwood@linux.intel.com>
Keyon Jie <yang.jie@linux.intel.com>
Copyright IBM Corp. 2009, 2016
Copyright (C) 1998-2001 David A. Schleef <ds@schleef.org>
Copyright (c) 2002 Petko Manolov (petkan@users.sourceforge.net)
Copyright (C) 1995 - 2000, 2001 by Ralf Baechle
Copyright (C) 2010-2011 Pixcir, Inc.
Copyright (C) 2018 Stefan Agner <stefan@agner.ch>
Copyright (c) 2012 Netapp, Inc. All rights reserved.
(c) 2007 Gerd Hoffmann <kraxel@suse.de>
Copyright (C) 2010, 2012 Texas Instruments, Inc.
Copyright(c) 2016 Intel Corporation.
Copyright IBM Corporation, 2011
Copyright (C) Harald Geyer <harald@ccbib.org> based on sun50i-a64-olinuxino.dts by Jagan Teki <jteki@openedev.com>

LICENCE TERMS (cont.)

Copyright (c) 2003-2005 Silicon Graphics, Inc. All Rights Reserved.
Copyright (C) 2019 STMicroelectronics Author(s): Amelie Delaunay <amelie.delaunay@st.com>.
Copyright (c) 2001 Eric Brower (ebrower@usa.net)
Copyright (C) 2002 - 2014, Areca Technology Corporation All rights reserved
Copyright (C) 2005 MIPS Technologies, Inc. All rights reserved.
Copyright (c) 2017 Icenowy Zheng <icenowy@aosc.io>
Copyright (C) 2001
Copyright (c) 2013 Texas Instruments Inc.
Copyright (c) 2016-2017, NVIDIA CORPORATION. All rights reserved
Copyright (C) 2019 Cadence Design Systems Inc.
Copyright (c) 2000-2004 by David Brownell
Copyright (C) 2014 Marvell International Ltd.
Copyright (c) 2017 MediaTek Inc. Author: Ryder Lee <ryder.lee@mediatek.com>
Copyright (c) 2014-2017, The Linux Foundation. All rights reserved.
Copyright (c) 2017 Christoph Hellwig.
Copyright 2011 Fenghua Yu <fenghua.yu@intel.com>
Copyright (C) 2012 ARM Limited
Copyright (C) 2014 Paratronic S.A.
Copyright (c) <2017> HiSilicon Technologies Co., Ltd. <http://www.hisilicon.com>
Copyright 2010 Texas Instruments Inc.
Copyright (C) 2008,2009 Intel Corporation Author: Patrick Ohly <patrick.ohly@intel.com>
Copyright (C) 2016 Texas Instruments Incorporated - <http://www.ti.com/> Keerthy <j-keerthy@ti.com>
Copyright (C) 2011 James Nuss <jamesnuss@nanometrics.ca>
Copyright 2008 Samsung Electronics. Author: Ryu Euiyoul ryu.real@gmail.com
Copyright (c) 2004, 2005, Voltaire, Inc. All rights reserved.
Copyright (C) 2006 Jaya Kumar Based on Toshiba ACPI by John Belmonte and ASUS ACPI This work was sponsored by CIS(M) Sdn Bhd.
copyright (c) 2006 IBM Corporation Authored by: Mike D. Day <ncmike@us.ibm.com>
Copyright (C) 2012 Atmel, 2012 Hong Xu <hong.xu@atmel.com>
(c) 1998 Martin Mares <mj@ucw.cz>;(c) 1999 Asit Mallick <asit.k.mallick@intel.com>;(c) 1999 Don Dugger <don.dugger@intel.com>
Copyright (C) 2009 Lemote Inc. Author: Hu Hongbing <huhb@lemote.com> Wu Zhangjin <wuzhangjin@gmail.com>
Copyright (C) 2006 Jon Grierson <jd@renko.co.uk>
Copyright (c) 2011 Florian Westphal <fw@stlren.de>
Copyright 1996, 1997 David S. Miller (davem@caip.rutgers.edu)
Copyright (c) 2015 Tom Herbert <tom@herbertland.com>
Copyright © 2006-2011 Intel Corporation
Copyright 2014 Freescale Semiconductor, Inc.
Copyright (c) 2008 Doug Thompson www.softwarebitmaker.com Licensed and distributed under the GPL
Copyright 2012 ST Microelectronics (Alessandro Rubini)
Copyright (C) 2013 Shaohua Li <shli@kernel.org>
Copyright 2004 Linus Torvalds
Copyright 2008-2009 DENX Software Engineering, Stefan Roese <sr@denx.de>
Copyright 2016 Icenowy Zheng <icenowy@aosc.io>
Copyright (C) 2001-2005 PPC 64 Team, IBM Corp
Copyright (C) 2004 Paul Mackerras, IBM Corp.
Copyright IBM Corp. 2003, 2013 Author(s): Michael Holzheu
Copyright(c) 2003 - 2014 Intel Corporation. All rights reserved.
Copyright (C) 1997,1998,1999 Free Software Foundation, Inc. Contributed by Richard Henderson (rth@cygnus.com), Jakub Jelinek (jakub@redhat.com) and David S. Miller (davem@redhat.com).
Copyright (C) 1999,2000 Philipp Rumpf
Copyright(c) 2009 Realtek Semiconductor Corp. All rights reserved.
Copyright (C) 2015, Marvell International Ltd.
Copyright (C) 2012 Renesas Solutions Corp.
Copyright © 2008 Ingo Molnar
Copyright (c) 2008-2015 Chelsio Communications, Inc.
Copyright (c) 2004 Jaroslav Kysela <perex@perex.cz> 2008 Pavel Hofman <dustin@seznam.cz>
Copyright IBM Corporation 2008
Copyright (C) 2005, PMC-Sierra, Inc. All rights reserved. Author: Andrew Hughes, Andrew_Hughes@pmc-sierra.com
Copyright IBM Corporation, 2007 Josh Boyer <jwboyer@linux.vnet.ibm.com>
Copyright (c) 2008-2010, Dave Chinner All Rights Reserved.
Copyright © 2002 Robert Kaiser <rkaizer@sysgo.de>
Copyright (c) 2004-2007 Reyk Floeter <reyk@openbsd.org>
Copyright (C) 2004, 2005 Oracle. All rights reserved.
Copyright (C) 2016 InforceComputing Author: Vinay Simha BN <simhavcs@gmail.com>
Copyright (C) 2010 Magnus Damm
Copyright (C) 2010 Texas Instruments Author: Felipe Balbi <balbi@ti.com>
Copyright (C) 2002 Jeff Dike (jdike@karaya.com)
Copyright (C) 2009 Ivo van Doorn <lvdoorn@gmail.com>
Copyright 2013-2014 Freescale Semiconductor, Inc.
Copyright (C) 2001 NxtWave Communications, Inc.
Copyright (C) 2000 Chen-Yuan Wu <gwu@esoft.com>
Copyright (C) 2004 PathScale, Inc
Copyright © 2013 Patrik Jakobsson
Copyright (C) 2010, Tobias Klauser <tklauser@distanz.ch>
Copyright (C) 2001 WireX Communications, Inc <chris@wirex.com>
Copyright IBM Corp. 2002, 2008 Author(s): Arnd Bergmann (arndb@de.ibm.com) Cornelia Huck (cornelia.huck@de.ibm.com) Martin Schwidefsky (schwidefsky@de.ibm.com)
Copyright (C) 2008-2009 Red Hat, Inc. All rights reserved.
(c) 1998 David Campbell
Copyright (C) 1995, 96, 97, 98, 99, 2003, 05 Ralf Baechele
Copyright (c) 2019, Jeffrey Hugo
Copyright (c) 1996 John Shifflett, GeoLog Consulting john@geolog.com jshiffle@netcom.com
(C) Copyright 1995 - 1997 Marco van Wieringen - ELM Consultancy B.V.
Copyright (c) 2015-2017 Daniel Borkmann
Copyright (C) 2005 Stephen Street / StreetFire Sound Labs
Copyright (c) 2019 Alexey Dobriyan <adobriyan@gmail.com>
Copyright 2010 Anton Vorontsov <cbouatmailru@gmail.com>
Copyright (C) 2011 Jean-François Moine (<http://moinejf.free.fr>)
Copyright(c) 2015 Intel Corporation.
Copyright (C) 2013 ISEE 2007 SL - <http://www.isee.biz>
Copyright (C) 1992 - 1997, 1999, 2000 Silicon Graphics, Inc.
Copyright 2017 Boundary Devices, Inc.
Copyright (C) 2011, Intel Corporation
Copyright 2008-2016 Freescale Semiconductor Inc.
Copyright (c) 2007 Wind River Systems, Inc.
Copyright (c) 2007-2008 Tungsten Graphics, Inc., Cedar Park, TX., USA,
Copyright (C) 2011-2016 Freescale Semiconductor, Inc.
(c) 2004 Jelle Foks <jelle@foks.us>
Copyright IBM Corp. 2006, 2019 Author(s): Cornelia Huck <cornelia.huck@de.ibm.com> Martin Schwidefsky <schwidefsky@de.ibm.com> Ralph Wuerthner <rwuerthn@de.ibm.com> Felix Beck <felix.beck@de.ibm.com> Holger Dengler <hd@linux.vnet.ibm.com>
Copyright (C) 1996, 1997, 2000, 2012 David S. Miller (davem@redhat.com)
Copyright (C) 2014 Atmel
Copyright (C) 2006 Rudolf Marek <r.marek@assembler.cz>
(c) Copyright 2008-2011 Alan Cox <alan@lxorguk.ukuu.org.uk>, All Rights Reserved.;(c) Copyright 2008-2011 Wim Van Sebroeck <wim@iguana.be>.
Copyright (C) 2006 TOPTICA Photonics AG.
Copyright (c) 2010-2011 EIA Electronics
Copyright (C) Overkiz SAS 2012
(C) 2003 Andreas Gruenbacher <agruen@suse.de>
"Copyright 2003 Ben. Herrenschmidt <benh@kernel.crashing.org>"
Copyright (C) 2005 Patrick Mochel
Copyright (C) 2014-2019 Renesas Electronics Corporation

LICENCE TERMS (cont.)

Copyright (c) 2017, Microchip Technology Inc. 2016 Nicolas Ferre <nicolas.ferre@atmel.com> 2017 Cristian Birsan <cristian.birsan@microchip.com> 2017 Claudiu Beznea <claudiu.beznea@microchip.com>
Copyright (C) 2010 Malcolm Priestley
Copyright (c) 2016 MediaTek Inc. Author: Garlic Tseng <garlic.tseng@mediatek.com> Ryder Lee <ryder.lee@mediatek.com>
Copyright (c) 2012 Linutronix GmbH
Copyright (c) 2015 - 2016 Stefan Schmidt <stefan@datenfreihafen.org>
Copyright (c) 2003 by Clemens Ladisch <clemens@ladisch.de> All rights reserved.
Copyright 2015, Sam Bobroff, IBM Corp.
Copyright 2008-2009 Freescale Semiconductor Inc.
Copyright (C) 2007-2009 ST-Ericsson Support functions for handling lli for dma Author: Per Friden <per.friden@stericsson.com>
(c) Benjamin Herrenschmidt <benh@kernel.crashing.org>, IBM Corp.,
Copyright 2011 Jonathan Corbet corbet@lwn.net
Copyright (C) 1999, 2000 Niibe Yutaka & Kaz Kojima
Copyright (C) 2010 Nokia Corporation Author: Matti J. Aaltonen <matti.j.aaltonen@nokia.com>
(c) 2003 Gerd Knorr <kxrel@bytesex.org> [SuSE Labs]
Copyright (C) 2003 - 2008 Nokia Corporation Author: Juha Yrjölä <juha.yrjola@nokia.com> DMA channel linking for 1610 by Samuel Ortiz <samuel.ortiz@nokia.com> Graphics DMA and LCD DMA graphics tranformations by Imre Deak <imre.deak@nokia.com>
Copyright (C) 2003 Sistina Software Limited.
Copyright (C) 2003-5, 2007 Red Hat, Inc. All Rights Reserved. Written by David Howells (dhowells@redhat.com)
Copyright (C) 2009 Hans Verkuil (hverkuil@xs4all.nl)
Copyright (c) 2002, 2003, 2004, 2005, 2006, 2007, 2008, 2009, 2010 Phillip Lougher <phillip@squashfs.org.uk>
Copyright (c) 2005 Pete Zaitcev <zaitcev@redhat.com>
Copyright (c) 2009 by Tilman Schmidt <tilman@imap.cc>.
"Copyright (C) 2016 Intel Corp Authors: Sailaja Bandarupalli <sailaja.bandarupalli@intel.com> Ramesh Babu K V <ramesh.babu@intel.com> Vaibhav Agarwal <vaibhav.agarwal@intel.com> Jerome Anand <jerome.anand@intel.com> Aravind Siddappaji <aravindx.siddappaji@intel.com>"
Copyright (C) ST-Ericsson SA 2010 Author: Shujuan Chen (shujuan.chen@stericsson.com)
Copyright (C) 2006 Advanced Micro Devices, Inc.
Copyright (C) 2015, Marcelo Ricardo Leitner <marcelo.leitner@gmail.com>
Copyright (C) 2013 Xilinx Inc.
Copyright (c) 2008, 2009 Tim Blechmann <tim@klingt.org>
Copyright (C) 2002 Greg Kroah-Hartman (greg@kroah.com)
Copyright (C) 2003-2011 PEAK System-Technik GmbH
Copyright (C) 2011, 2013, NVIDIA Corporation
Copyright(c) 2013 - 2014 Intel Corporation. All rights reserved.
Copyright (C) 2019 Nathan Huckleberry
Copyright (C) 2012 Sean Young <sean@mess.org>
Copyright (c) 2019, Mellanox Technologies. All rights reserved.
Copyright (C) 1997 Geert Uytterhoeven
Copyright (c) 2007 Philipp Zabel <philipp.zabel@gmail.com>
Copyright (c) 2017-2018 MediaTek Inc. Author: John Crispin <john@phrozen.org> Sean Wang <sean.wang@mediatek.com>
Copyright (C) 2004 Andrew de Quincey
Copyright (c) 2003 Takashi Iwai <tiwai@suse.de>
Copyright (C) 2014-2018 The Linux Foundation. All rights reserved.
Copyright (c) 2017, Mellanox Technologies inc. All rights reserved.
Copyright 2013-2017 Lothar Waßmann <LW@KARO-electronics.de>
Copyright (C) 2016 ARM Ltd. based on the Allwinner H3 dtsi:
Copyright (C) 1999 Zach Brown (with obvious credit due Ingo)
Copyright (c) 2011, 2012 Patrick McHardy <kaber@trash.net>
Copyright (C) 2002-2003 Fabrizio Gennari <fabrizio.gennari@philips.com>
Copyright (c) 2014 Mellanox Technologies. All rights reserved.
Copyright (C) 2007-2010 Freescale Semiconductor, Inc. All rights reserved.
Copyright (C) 2004 Russell King

Copyright (C) 2010 Secret Lab Technologies Ltd.
Copyright 2008 DENX Software Engineering GmbH Heiko Schocher <hs@denx.de>
Copyright Hans de Goede <hdegoede@redhat.com> for Red Hat, Inc. 2013 - 2016
(C) Copyright 2000 Linuxcare, Inc.;(C) Copyright 2000 Linuxcare Canada, Inc.;(C) Copyright 2000 Martin K. Petersen <mkip@linuxcare.com>;(C) Copyright 2000 Alex deVries <alex@onefishtwo.ca>;(C) Copyright 2001 John Marvin <jsm fc hp com>;(C) Copyright 2003 Grant Grundler <grundler@parisc-linux.org>;(C) Copyright 2005 Kyle McMartin <kyle@parisc-linux.org>;(C) Copyright 2006 Helge Deller <deller@gmx.de>
Copyright 1999 Red Hat Software --- All Rights Reserved
Copyright (C) Intuitive Aerial AB Written by Marten Svanfeldt, marten@intuitiveaerial.com
Copyright (C) 2006, 07 by Ralf Baechle (ralf@linux-mips.org)
(C) 2007 www.softwarebitmaker.com
Copyright (C) 2013 ams AG
Copyright (C) 2006-2012 Robert Gerlach <khnz@gmx.de>
Copyright (C) 1998-2003, 2005 Hewlett-Packard Co David Mosberger-Tang <davidm@hpl.hp.com>
Copyright (C) 2010--2012 Nokia Corporation Contact: Sakari Ailus <sakari.ailus@iki.fi>
Copyright (C) 1999-2003 Andre Hedrick <andre@linux-ide.org>
Copyright (C) 1999 kaz Kojima
Copyright (c) 2003-2004, Jouni Malinen <j@w1.fi>
Copyright 2001 VA Linux Systems, Inc.,
Copyright(c) 2011 Texas Instruments, Inc.
Copyright (C) 2008 Janne Grunau (j@jannau.net)
Copyright (C) 2005 Mike Christie. All rights reserved.
Copyright (C) 2019 ARM Ltd.
Copyright (C) 2013 - 2017 Linaro Ltd <ard.biesheuvel@linaro.org>
Copyright (c) 2016 Baylibre SAS. Author: Michael Turquette <mturquette@baylibre.com>
Copyright (C) 2017 Free Electrons
Copyright (C) 1996-2000 Vojtech Pavlik
Copyright (C) 2014-2015 Altera Corporation <www.altera.com>
Copyright (C) 1995, 96, 99, 2001 Ralf Baechle <ralf@linux-mips.org>
Copyright 1993 by Hamish Macdonald
Copyright (C) 1998,2001-2005 Pavel Machek <pavel@ucw.cz>
(C) Copyright 2009, Steven King <sfking@fdwdc.com>
Copyright (C) 2007,2008 SMC
Copyright 2010 Promwad Innovation Company Yauhen Kharuzhy <yauhen.kharuzhy@promwad.com>
Copyright (c) 1999-2005 Joerg Heckenbach <joerg@heckenbach-aw.de>
Copyright (c) 2001 by Stefan Eilers, Hansjoerg Lipp <hjlipp@web.de>, Tilman Schmidt <tilman@imap.cc>.
Copyright (C) 2016 Akinobu Mita <akinobu.mita@gmail.com>
Copyright (C) 1994, 1995, 1996, 1999 by Ralf Baechle
Copyright (C) 2016-2018 Zodiac Inflight Innovations
Copyright IBM Corp. 1999, 2001
Copyright (C) 2010 Marc Zyngier <maz@misterjones.org>
Copyright (C) 2014 Freescale Semiconductor, Inc.
Copyright (C) 2011 Nokia Corporation and/or its subsidiary(-ies).
(c) 2005 Daniel Drake <dstd@gentoo.org>
Copyright IBM Corp. 2003, 2007 Author(s): Thomas Spatzier Jan Glauber (jan.glauber@de.ibm.com)
(C) Copyright 1999 Roman Weissgaerber <weissg@vienna.at>;(C) Copyright 2000-2002 David Brownell <dbrownell@users.sourceforge.net>;(C) Copyright 2002 Hewlett-Packard Company;(C) Copyright 2006 Sylvain Munaut <int@246tnt.com>
Copyright (c) 2011-2012, NVIDIA Corporation.
Copyright (C) 1998 Eddie C. Dost (ecd@skynet.be)
Copyright (C) 2002 Intrinsic Software Inc.
Copyright (c) 2011 Samsung Electronics Co., Ltd. Authors: Inki Dae <inki.dae@samsung.com> Joonyoung Shim <jy0922.shim@samsung.com> Seung-Woo Kim <sw0312.kim@samsung.com>
Copyright (C) 2010-2012 Advanced Micro Devices, Inc. Author: Joerg Roedel <jroedel@suse.de>
Copyright (c) by Jaroslav Kysela <perex@perex.cz>, Takashi Iwai <tiwai@suse.de>
Copyright (c) 2019 Linaro, Ltd. <ard.biesheuvel@linaro.org>
Copyright 2007, Olof Johansson, PA Semi

LICENCE TERMS (cont.)

Copyright (C) 1994 by Hamish Macdonald
Copyright (C) 2013 Pengutronix Author: Markus Pargmann <mpa@pengutronix.de>
Copyright (C) 2004, 2005 IBM, John Stultz (johnstul@us.ibm.com)
Copyright: [copy] 2018 Intel Corporation Author: Sakari Ailus <sakari.ailus@linux.intel.com>
Copyright (C) 2010 Texas Instruments Author: Hemanth V <hemanthv@ti.com>
Copyright: (C) 2009 MontaVista Software, Inc., <source@mvista.com>
Copyright 2012 Ondrej Zary <linux@rainbow-software.org> based on radio-aimslab.c by M. Kirkwood and radio-sf16fmi.c by M. Kirkwood and Petr Vandrovec
Copyright (C) 2015 International Business Machines Inc.
Copyright (C) 1996 Russell King.
Copyright (C) 1996 David S. Miller (davem@caip.rutgers.edu)
(c) 2015 ST Microelectronics
Copyright (C) 2002 Pete Zaitcev <zaitcev@yahoo.com>
Copyright (C) ST-Ericsson SA 2012 Author: Johan Gardsmark <johan.gardsmark@stericsson.com> for ST-Ericsson.
(C) COPYRIGHT 2016 ARM Limited. All rights reserved. Author: Brian Starkey <brian.starkey@arm.com>
Copyright (c) 2000, 2003 Silicon Graphics, Inc. All rights reserved.
Copyright (C) 2000-2001 by Harald Welte <laforge@gnumonks.org>
Copyright (C) 1996, 98, 99, 2000, 01 Ralf Baechle
Copyright (C) 2010 John Crispin <blogic@phrozen.org>
Copyright (c) 2007-2008 Claudio Nieder <private@claudio.ch>
Copyright (C) 2010, Oracle. All rights reserved.
Copyright (C) 2016 Cavium Inc. Authors: Jan Glauber <jglauber@cavium.com>
Copyright (C) 2007, 2008 Rusty Russell IBM Corporation
Copyright (C) 2002 Stuart Menefy
Copyright 2016, Anton Blanchard, Michael Ellerman, IBM Corp.
Copyright (C) 1997, 1999, 2008 David S. Miller (davem@davemloft.net)
Copyright 2015 Freescale Semiconductor Inc.
Copyright (C) 1992 Linus Torvalds
Copyright (C) 2019 Texas Instruments Incorporated
Copyright (C) 1999-2008, Greg Ungerer (gerg@snapgear.com)
Copyright (C) 2013 Jonas Jensen <jonas.jensen@gmail.com>
Copyright (C) 2014 Samsung Electronics Co., Ltd. Author: Vivek Gautam <gautam.vivek@samsung.com>
Copyright (C) 1995, 1996, 1997, 1998, 1999, 2000, 2003 by Comtrol, Inc.
Copyright (C) 2003 Sean McGoogan (Sean.McGoogan@superh.com)
Copyright (C) 2017 Red Hat, Inc.
Copyright (C) 2017 Renesas Electronics Corporation
Copyright (c) 2017 Bastien Nocera <hadess@hadess.net>
Copyright (C) 2015 - 2016 Cavium, Inc.
Copyright 2005 Freescale Semiconductor, Inc
Copyright (C) 2003 Takashi Kusuda <kusuda-takashi@hitachi-ul.co.jp>
Copyright (c) 2016 Anders K. Pedersen <akp@cohaesio.com>
Copyright (C) 2016, Intel Corporation Author: Irina Tirdea <irina.tirdea@intel.com>
Copyright (C) 2012, ARM Ltd. Author: Will Deacon <will.deacon@arm.com>
Copyright (c) 2018 Melvin Vermeeren
Copyright (C) 2014-2015 Ralph Metzler <rjkm@metzlerbros.de> Marcus Metzler <mocm@metzlerbros.de>
developed for Digital Devices GmbH
Copyright (c) International Business Machines Corp., 2007 Author(s): Steve French (sfrench@us.ibm.com)
Copyright 2010 Wolfson Microelectronics. PLC.
Copyright (c) 2014 Intel Corp
Copyright (C) Christoph Hellwig, 2001-2002
Copyright IBM Corp. 2012, 2019 Author(s): Hendrik Brueckner <brueckner@linux.ibm.com>
Copyright (C) 2007 Christian Pellegrin
Copyright (C) 2015 Huawei Futurewei Technologies.
Copyright (C) 2009 Erik Andr n
Copyright (c) 2011 Mellanox Technologies. All rights reserved.
Copyright 2008 Embedded Alley Solutions, Inc.
Copyright 2012-14 Advanced Micro Devices, Inc.

(C) 2005 Red Hat Inc Alan Cox <alan@lxorguk.ukuu.org.uk>
Copyright (C) 2008 Intel Corp. Shaohua Li <shaohua.li@intel.com>
Copyright (C) 2011-2012 Texas Instruments Inc.
Copyright (c) 2004 Simtec Electronics Ben Dooks <ben@simtec.co.uk>;(c) 2002 Monta Vista Software Inc;(c) 2001
Copyright (C) 2008 Maxime Bizon <mbizon@freebox.fr>
Copyright 2013, Michael Ellerman, IBM Corporation.
Copyright (C) 1998-2006 Michael Hunold <michael@mihu.de>
Copyright (c) 2004-2014 Broadcom Corporation
Copyright (C) 2008 International Business Machines Corp. Author(s): Michael A. Halcrow <mhalcrow@us.ibm.com>
Copyright (C) 2012 Guenter Roeck <linux@roeck-us.net>
Copyright (C) 2013 Samsung Electronics Co., Ltd. Author: Jacek Anaszewski <j.anaszewski@samsung.com>
Copyright (c) 2004, 2005, 2006 Voltaire, Inc. All rights reserved.
Copyright (c) 2018 Lightbits Labs. All rights reserved.
Copyright (C) 2010 Texas Instruments Incorporated - http://www.ti.com Author: Hema HK <hemahk@ti.com>
Copyright (C) 1993, 1994, 1995, 1996, 1997 Free Software Foundation, Inc. Contributed by Paul Eggert (eggert@twinsun.com).
Copyright 2011-2015 Hauke Mehrtens <hauke@hauke-m.de>
Copyright (C) 2012 Hitachi, Ltd. Created by Yoshihiro Yunomae <yoshihiro.yunomae.ez@hitachi.com> Masami Hiramatsu <masami.hiramatsu.pt@hitachi.com>
Copyright (C) 2008 Nokia Corporation Jouni Hogander
Copyright (c) 2015 - Savoir-faire Linux
Copyright (C) 2017 Synopsys.
Copyright (c) 2003-2006, 2013, Ericsson AB
Copyright (c) 2009 Marton Balint <cus@fazekas.hu>
Copyright 2000,2001,2002 Red Hat.
Copyright (c) 2013 Red Hat, Inc. All Rights Reserved.
Copyright (c) 2015 secunet Security Networks AG
Copyright 2014-2015, Qualcomm Atheros, Inc.
Copyright (C) 2002,2003 Frank Mori Hess <fmhess@users.sourceforge.net>
(C) 2000 Red Hat. GPL'd. See JEDEC (http://www.jedec.org/) standard JESD21C (section 3.5) for the standard this probe goes back to.
Copyright (C) 2006 Nicolas VIVIEN
Copyright (C) 2003 Deep Blue Solutions, Ltd, All Rights Reserved.
Copyright (C) 2008 Bluewater Systems Ltd Author: Ryan Mallon
Copyright (C) 2007-2008 Arjan Opmeer <arjan@opmeer.net>
Copyright (C) 2014 Philipp Zabel
Copyright (C) 1991, 1992, 1995 Linus Torvalds;(C) 1994-2001 Russell King
Copyright 2012-2019 Analog Devices Inc.
Copyright (C) 2006, 2007 Florian Fainelli <florian@openwrt.org>
Copyright (C) 2003 Christoph Hellwig (hch@lst.de)
Copyright 2008 IBM Corporation
Copyright 2005 Openedhand Ltd.
Copyright (c) 2017 Hisilicon Limited.
Copyright (c) 2008 Lukasz Lubojanski <lukasz@lubojanski.info>
Copyright (C) 1999-2018 Tigran Aivazian <aivazian.tigran@gmail.com>
Copyright (c) 2013-2014 ARM Ltd.
Copyright 2006 PathScale, Inc. All Rights Reserved.
Copyright (C) 2001,2003 Greg Kroah-Hartman (greg@kroah.com)
Copyright (C) 2004 Fujitsu Siemens Computers GmbH Author: Bodo Stroesser <bstroesser@fujitsu-siemens.com>
Copyright (C) 2005 Kirk Lapray <kirk_lapray@bigfoot.com>
Copyright IBM Corp. 2003, 2012 Virtual CPU timer
Copyright (C) 2009. SUSE Linux Products GmbH. All rights reserved.
Copyright (C) 1996, 1999 by Ralf Baechle
Copyright 2008 Intel Corporation.
Copyright 2011 Freescale Semiconductor Inc.
Copyright (c) 2019 Synopsys,
Copyright (c) 2015 Andy Lutomirski

LICENCE TERMS (cont.)

Copyright (c) 2015 Pengutronix, Steffen Trumtrar <kernel@pengutronix.de>
Copyright 1996, 1997, 1998 Hans Reiser, see reiserfs/README for licensing and copyright details
Copyright (C) 2005, Intel Corporation.
Copyright (C) 1998 Dave Perks <dperks@ibm.net>
Copyright (C) 2008, 2013 Red Hat, Inc. All Rights Reserved. Written by David Howells (dhowells@redhat.com)
(C) 1996-1998 by Thomas Sailer, HB9JNX/AE4WA
Copyright (C) 2008-2017 Andes Technology Corporation;(c) MontaVista Software, LLC.
Copyright (C) 2001 Russell King;(C) 2003 Venkatesh Pallipadi <venkatesh.pallipadi@intel.com>. Jun Nakajima <jun.nakajima@intel.com>;(C) 2009 Alexander Clouter <alex@digriz.org.uk>
Copyright (C) 2012 Red Hat, Inc.
Copyright (C) 2008, 2009, 2010 Paxton Smith, Matthew Safar, Rory Filer linux@sierrawireless.com>
Copyright (c) 1997 Justin T. Gibbs.
Copyright (c) 2005, Nguyen Anh Quynh <aquynh@gmail.com>
Copyright 2014 Skyworks Solutions Inc. Author : Gyungoh Yoo <jack.yoo@skyworksinc.com>
Copyright (C) 2018 Microchip Technology Inc, Codrin Ciubotariu <codrin.ciubotariu@microchip.com>
Copyright (c) 2001-2005 Anton Altaparmakov
Copyright (C) 2015 Texas Instruments Incorporated - http://www.ti.com Author: Roger Quadros <rogerq@ti.com>
Copyright 2003 Vivien Chappelier <vivien.chappelier@linux-mips.org>
Copyright (C) 1998 D. Jeff Dionne <jeff@lineo.ca>,
Copyright (c) 1994-1998 Initio Corporation
Copyright (C) 1999 - 2012 Greg Kroah-Hartman (greg@kroah.com)
Copyright (C) 2010 Gabor Juhos <juhosg@openwrt.org>
Copyright (c) 2017 Amlogic, Inc. All rights reserved. Author: Xingyu Chen <xingyu.chen@amlogic.com>
Copyright (C) 2010 Marco Stornelli <marco.stornelli@gmail.com>
Copyright (c) 2010 Serge A. Zaitsev
"Copyright: (C) 2001 MontaVista Software Inc."
Copyright (c) 2012-2013 Broadcom Corporation
(C) Copyright 2005 Ian Molton <spyro@f2s.com>
Copyright (C) 2016 Adam Baker <linux@baker-net.org.uk> based on a board file driver
(C) Copyright 2002-2004, 2007 Greg Kroah-Hartman <greg@kroah.com>;(C) Copyright 2007 Novell Inc.
Copyright IBM Corporation, 2010 Author Venkateswararao Jujjuri <jvrao@linux.vnet.ibm.com>
Copyright (C) 2013-2014 Freescale Semiconductor, Inc. All Rights Reserved.
Copyright (C) 2002 Broadcom Corporation
Copyright (C) 2010 Red Hat Inc, Steven Rostedt <ststedt@redhat.com>
Copyright(c) 2015 - 2017 Intel Deutschland GmbH
Copyright (C) Linaro 2012 Author: <benjamin.gaignard@linaro.org> for ST-Ericsson.
Copyright (C) 2004 Steven J. Hill
Copyright (c) 1998 - 2002 Frodo Looijaard <frodol@dds.nl>, Philip Edelbrock <phil@netroedge.com>, and Mark D. Studebaker mdsxyz123@yahoo.com>
Copyright (C) 2014 Hauke Mehrtens <hauke@hauke-m.de>
Copyright (c) 2016 MediaTek Inc. Author: Ming Hsiu Tsai <minghsiu.tsai@mediatek.com>
Copyright (C) 2007,2008 Hans de Goede <hdegoede@redhat.com> Preliminary tmp411 support by: Gabriel Konat, Sander Leget, Wouter Willems
Copyright (C) 1994 - 2000, 2001, 2003 Ralf Baechle
Copyright (c) 2015-2016, Integrated Device Technology Inc.
Copyright (C) 2018 Linus Walleij
Copyright (C) 2014 ST Microelectronics Pratyush Anand <pratyush.anand@gmail.com> Mohit Kumar <mohit.kumar.dhaka@gmail.com>
Copyright (c) 2014 David Herrmann <dh.herrmann@gmail.com>
Copyright (c) 2018 Amlogic, inc. Author: Yue Wang <yue.wang@amlogic.com>
Copyright (C) 2017-2019 Broadcom. All Rights Reserved.
Copyright 2009, Michael Buesch <m@bues.ch>
Copyright (C) 2012 Intel Corp
Copyright (C) 2000 Frodo Looijaard <frodol@dds.nl> Philip Edelbrock <phil@netroedge.com> Stephen Rousset <stephen.rousset@rocketlogix.com> Dan Eaton <dan.eaton@rocketlogix.com>
Copyright (C) 2014, Microsoft, Inc.
Copyright © 2014 Jussi Kivilinna <jussi.kivilinna@iki.fi>

Copyright 2011-2015 Analog Devices Inc.
"Copyright (C) 2008-14 Intel Corp Authors: Vinod Koul <vinod.koul@intel.com> Harsha Priya <priya.harsha@intel.com> Dharageswari R <dharageswari.r@intel.com> KP Jeeja <jeeja.kp@intel.com>"
Copyright (C) 2016 Renesas Electronics
Copyright (c) 2014, Sony Mobile Communications AB.
(c) 2009, Mel Gorman <mel@csn.ul.ie> SOURCE= GFPMASK=none
Copyright (C) 2005-2009 Red Hat, Inc. All rights reserved.
Copyright 2013 - 2015 Freescale Semiconductor Inc.
Copyright (C) 2012 Sylwester Nawrocki <sylwester.nawrocki@gmail.com>
Copyright (C) 2018 Phil Reid <preid@electromag.com.au>
Copyright © 2007 Anton Vorontsov <cbou@mail.ru>
(c) the combination of files containing Original Software with files containing Modifications, in each case including portions thereof.
Copyright (C) ASPEED Technology Inc.
Copyright (C) 2016-2018 Etnaviv Project
Copyright (C) 2003-2004 Venkatesh Pallipadi <venkatesh.pallipadi@intel.com>;(C) 2004 Zou Nan hai <nanhai.zou@intel.com>.
Copyright (C) 2013 Horms Solutions Ltd.
"Copyright (C) ST-Ericsson AB 2010 Author: Sjur Brendeland"
(C) Copyright 2012 Marvell International Ltd. All Rights Reserved
Copyright (c) 2018 Facebook Inc.
(C) 1996 Gordon Chaffee
(c) MontaVista Software, LLC.
Copyright (C) 2009-2010 One Laptop per Child
Copyright (c) 1997 Dan error_act (dmalek@jlc.net)
Copyright (c) 2018 BayLibre SAS. All rights reserved.
Copyright (C) 2011 Jean-Christophe PLAGNIOL-VILLARD <plagnioj@jcrosoft.com>
Copyright (c) 2006 Steven Rostedt
Copyright (c) 2006 Intel Corporation. All rights reserved.
Copyright (C) 2014 by Marcel Mol
(C) 2000,2005 by Harald Welte <laforge@netfilter.org>
(C) 1999 Stelias Computing Inc
Copyright (C) 1995, 1998, 2001, 2002 by Ralf Baechle
Copyright 2015 Endless Mobile, Inc. Author: Carlo Caione <carlo@endlessm.com>
Copyright (C) 1995 - 2000 Ralf Baechle
Copyright (C) 2005-2010 Texas Instruments.
Copyright 2013 STMicroelectronics Inc.
Copyright IBM Corp. 2002 Author(s): Cornelia Huck (cornelia.huck@de.ibm.com) Martin Schwidfsky (schwidfsky@de.ibm.com)
Copyright (C) 2017, Maarten ter Huurne <maarten@treewalker.org>
Copyright 2002 Andi Kleen, SuSE Labs
Copyright (C) 2008 Manuel Lauss <mano@roarinelk.homelinux.net>
Copyright (C) 2002-2007 Hewlett-Packard Co Contributed by David Mosberger-Tang <davidm@hpl.hp.com>
Copyright (C) 2007, 2008 Cavium Networks
Copyright (C) 2009 Atmel Corporation, Nicolas Ferre <nicolas.ferre@atmel.com>
Copyright (c) 2005 Gene Collins
Copyright 1999-2000 Red Hat Software --- All Rights Reserved
Copyright (C) 2016 Spencer E. Olson <olsonse@umich.edu>
Copyright (c) 2003-2013 LSI Corporation
Copyright (C) 2016 Noralf Trønnes
Copyright (c) 2016 Andrew Worsley amworsley@gmail.com
Copyright (C) 1997, 1999 David S. Miller (davem@redhat.com)
Copyright (C) 2016 Marvell, All Rights Reserved.
Copyright (c) 2003 Zultys Technologies. Eugene Surovegin <eugene.surovegin@zultys.com> or <ebs@ebshome.net>
Copyright (c) 2015 Red Hat Inc.
Copyright (C) 2013 H Hartley Sweeten <hsweeten@visionengravers.com>

LICENCE TERMS (cont.)

Copyright (C) 2015 Intel Corp Author: Jeeja KP <jeeja.kp@intel.com> Nilofer, Samreen <samreen.nilofer@intel.com>
Copyright (c) 2012 Samsung Electronics Co., Ltd. <http://www.samsung.com/>
Copyright IBM Corp. 2003, 2017 Author(s): Thomas Spatzier Jan Glauber Harald Freudenberger (freude@de.ibm.com) Martin Schwidefsky <schwidefsky@de.ibm.com>
Copyright (C) 2018 by Sean Young <sean@mess.org>
Copyright (C) 2003 Maciej W. Rozycki
Copyright (c) 2019 Shuah Khan <shuah@kernel.org>
Copyright (C) 2001-2002 Greg Kroah-Hartman (greg@kroah.com)
Copyright (c) 2017 Priit Laes <plaes@plaes.org>.
Copyright (C) 2007, 2008 CompuLab, Ltd. Author: Mike Rapoport <mike@compulab.co.il>
Copyright (C) 2007-2009, 2012 Texas Instruments, Inc.
Copyright (C) 2010 Willow Garage <<http://www.willowgarage.com>>
Copyright 2015-2017 Advanced Micro Devices, Inc.
(c) Copyright 2007 Hewlett-Packard Development Company, L.P. Bjorn Helgaas <bjorn.helgaas@hp.com>
Copyright (C) 2008 Nuvoton Technology Corp. Wei Song
Copyright (C) 2017 Pengutronix, Philipp Zabel <kernel@pengutronix.de>
Copyright 2017 Luxul Inc.
Copyright (c) 2004, 2005 Intel Corporation. All rights reserved.
Copyright (C) 2007 Google, Inc.
Copyright (C) 2013 Atmel Corporation
Copyright (C) 2001-2002 Will Dyson <will_dyson@pobox.com>
Copyright (c) 2008 Bull S.A.S.
Copyright (C) 2010 Vivek Goyal <vgoyal@redhat.com>
Copyright (C) 1995 Linus Torvalds
Copyright (C) 1999, 2008 David S. Miller (davem@davemloft.net)
(C) Copyright 2014, 2016 Intel Corporation Authors: Andy Shevchenko <andriy.shevchenko@linux.intel.com> Dan O'Donovan <dan@emutex.com>
Copyright (C) M'bomba Cedric Madianga 2017 Author: M'bomba Cedric Madianga <cedric.madianga@gmail.com>
Copyright (c) 2018-2019 Paulo Alcantara <palcantara@suse.de>
Copyright (C) 2011-2012 One Laptop per Child Foundation.
Copyright (C) 2017 Gateworks Corporation
Copyright (C) 2017 IBM Corporation (Michael Neuling, Andrew Donnellan)
Copyright (C) 2017 Oracle Corporation
Copyright 2017 Analog Devices Inc.
Copyright 2015-2016 Freescale Semiconductor, Inc.
Copyright (C) 2000 Niibe Yutaka
Copyright (c) 2014 Andy Lutomirski and others v2
Copyright (C) 2017 Mobica Limited
Copyright 2003, 2004, 2005, 2006, 2007 Wolfson Microelectronics PLC. Author: Liam Girdwood <lrg@slimlogic.co.uk>
(C) 2010 Luotao Fu <l.fu@pengutronix.de> All rights reserved.
Copyright (c) 2019 Mellanox Technologies
Copyright (C) 2009 Texas Instruments Inc
Copyright (c) 2012 ST Microelectronics Limited Shiraz Hashim <shiraz.linux.kernel@gmail.com>
Copyright (C) 2000 - 2019, Intel Corp.
Copyright (c) 2001 Maciej W. Rozycki
Copyright (c) 1999-2015 Tensilica Inc.
Copyright © 2017 Red Hat
Copyright (c) 2008 MtekVision Co., Ltd. Kwangwoo Lee <kwlee@mtelevision.com>
Copyright (c) 2006 Intel Corporation
Copyright (C) 1997 Martin Mares
Copyright (C) 2017 Intel Corporation Author: Heikki Krogerus <heikki.krogerus@linux.intel.com>
Copyright (C) 2010-2015 Freescale Semiconductor, Inc. All Rights Reserved.
Copyright (C) 2012 Regents of the University of California
Copyright (c) 2003-2005 Chelsio Communications. All rights reserved.
Copyright 2017 Cisco Systems, Inc. and/or its affiliates. All rights reserved.

Copyright(C) 2015-2018 Linaro Limited.
Copyright(c) 2013 - 2015 Intel Mobile Communications GmbH
Copyright (C) 2002 David S. Miller (davem@redhat.com)
Copyright 2013-15 Maxim Integrated Products
Copyright (c) 2012 Intel Corporation. All rights reserved.
Copyright 1999-2001 Jeff Garzik <jgarzik@pobox.com>
Copyright (C) 2007, 2011 Wolfgang Grandegger <wg@grandegger.com>
Copyright (C) 2007-2009, 2011-2012 Texas Instruments, Inc.
Copyright (c) 2000 The Regents of the University of Michigan. All rights reserved.
Copyright (C) 2008 Google, Inc.
Copyright (c) 2014 Collabora Ltd.
Copyright (c) 2012-2015, 2017-2018, The Linux Foundation. All rights reserved.
Copyright (c) 2014 Samsung Electronics Co., Ltd. Author: Andrey Ryabinin <a.ryabinin@samsung.com>
Copyright (C) 2000 Qlogic Corporation (www.qlogic.com)
Copyright (c) 2004 - 2009 Paul Mundt
Copyright (C) 2014, Intel Corporation Authors: Rafael J. Wysocki <rafael.j.wysocki@intel.com> Mika Westerberg <mika.westerberg@linux.intel.com>
Copyright (C) 1992,1995 Australia. E-mail billm@jacobi.maths.monash.edu.au |
Copyright 2014 Beniamino Galvani <b.galvani@gmail.com>
Copyright (C) 1999 Vladimir Gurevich <vgurevic@cisco.com> Bear & Hare Software, Inc.
Copyright (C) 2002, Rohit Seth <rohit.seth@intel.com>
(c) 2000-2002 Matthew Dharm (mdharm-usb@one-eyed-alien.net);(c) 2000 Adam J. Richter (adam@yggdrasil.com), Yggdrasil Computing, Inc.
Copyright 2008-2015 Freescale Semiconductor, Inc. All Rights Reserved.
Copyright (C) 2017 Jacopo Mondì
Copyright (C) 1992,1995 Australia. E-mail john.r.fastabend@intel.com>
Copyright (c) 2013 Ondrej Zary
Copyright (C) 2008, Intel Corp. Author: Huang Ying <ying.huang@intel.com>
Copyright (c) 2014-2015, The Linux Foundation. All rights reserved.
Copyright (c) 2006-2008 Simtec Electronics <http://armlinux.simtec.co.uk/> Ben Dooks <ben@simtec.co.uk> Vincent Sanders <vince@arm.linux.org.uk>
Copyright (c) 2018 Crane Merchandising Systems. All rights reserved.
Copyright (c) 2008 Zbynek Michl <Zbynek.Michl@seznam.cz>
Copyright (C) 2016-2017 Oracle. All rights reserved.
Copyright (C) 2008 Jean Delvare <jdelvare@suse.de>
Copyright (c) 2016 Takashi Sakamoto
Copyright (C) 2012 - 2013 Samsung Electronics Co., Ltd. Author: Sylwester Nawrocki <s.nawrocki@samsung.com>
Copyright (C) 2006 by Joachim Fritschi, <jfritschi@freenet.de> *
Copyright 2010 David Gibson <david@gibson.dropbear.id.au>, IBM Corporation.
Copyright (C) 2008-2009 Tower Technologies Written by Alessandro Zummo <a.zummo@towertech.it>
Copyright (C) 2007-2008 Texas Instruments, Inc.
(C) 1992 Eric Youngdale Modified for ISO 9660 filesystem.
Copyright (C) 2007-2008 Finn Thain
(C) Copyright IBM Corp. 2007 - Joy Latten <latten@us.ibm.com>
Copyright (C) 2009 Red Hat, Inc.
Copyright 2006 Tungsten Graphics, Inc., Bismack, ND. USA. All Rights Reserved.
Copyright 1995-1998 by Leonard N. Zubkoff <lnz@dandelion.com>
Copyright (C) 2012 Philipp Zabel, Pengutronix
Copyright (c) 2006 Ben Dooks
Copyright (C) 1998-2001 Hewlett-Packard Co David Mosberger-Tang <davidm@hpl.hp.com>
Copyright (C) 2013 Jiri Kosina
Copyright (C) 2002,2003 Intel Corp. Jun Nakajima <jun.nakajima@intel.com> Suresh Siddha <suresh.b.siddha@intel.com>
Copyright (C) 2013 DENX Software Engineering
Copyright (C) 2004 - 2007 Jeff Dike (jdike@{addtoit,linux.intel}.com)
Copyright (C) 2012 - 2014 Xilinx, Inc.
Copyright (C) 2006 - 2008 Sascha Sommer <saschasommer@freenet.de>

LICENCE TERMS (cont.)

(c) Rebel.COM, 1998,1999;(c) Philip Blundell, 2001
Copyright 2018, Christophe Leroy CS S.I. christophe.leroy@c-s.fr
Copyright (C) 2012, Texas Instruments
Copyright (c) 2016 Intel Corp., Rafael J. Wysocki <rafael.j.wysocki@intel.com>
Copyright (C) 2011 Laurent Pinchart (laurent.pinchart@ideasonboard.com)
Copyright 2008 Intel Corporation <hong.liu@intel.com>
Copyright 2011 Red Hat, Inc.
Copyright (C) 2001, 2002, MontaVista Software Inc. Author: Jun Sun, jsun@mvista.com or jsun@junsun.net
Copyright (c) International Business Machines Corp., 2006
"Copyright (C) 2008, 2005 IBM Corporation."
Copyright (C) 2018 Laird, 2018 Ben Whitten <ben.whitten@lairdtech.com>
Copyright (C) 2001 RidgeRun, Inc. Author: RidgeRun, Inc. Greg Lonnon <glonnon@ridgerun.com>
Copyright 2013 Analog Devices Inc.
Copyright (c) 2001 M. R. Brown <mrbrown@0xd6.org>
Copyright 2013 Freescale Semiconductor, Inc
Copyright(c) 2003 - 2006 Intel Corporation. All rights reserved.
Copyright (C) 2019, Google LLC.
Copyright (c) 2011-2012 Intel Corporation. All rights reserved.
Copyright (c) 2007, D G Murray
Copyright (C) 2010 Juergen Beisert, Pengutronix
Copyright IBM Corp. 2008 Author(s): Gerald Schaefer <gerald.schaefer@de.ibm.com>
Copyright (C) 2007, Greg Ungerer (gerg@snapgear.com)
Copyright (C) 2003-2005 SAN People
Copyright (C) 2004 Paul Mackerras <paulus@au.ibm.com>, IBM
Copyright (C) 2014 Romain Perier <romain.perier@gmail.com>
Copyright (C) 2017 Oracle. All Rights Reserved.
Copyright (C) 2008 Guennadi Liakhovetski, DENX Software Engineering, <lg@denx.de>
Copyright 2009 Simtec Electronics
Copyright (C) 2019 NXP
Copyright (c) 1998-2005 Vojtech Pavlik
(C) 2005 by Christian Hentschel <chentschel@arnet.com.ar> based on RR's ip_nat_ftp.c and other modules.:(C)
2007 United Security Providers;(C) 2007, 2008, 2011, 2012 Patrick McHardy <kaber@trash.net>
(C) 2007 sgi, Christoph Lameter
Copyright (C) 2007 Herbert Valerio Riedel <hvr@gnu.org>
Copyright 2014 Google, Inc
Copyright (C) 1995-2004 Russell King
Copyright (C) 2016-17, Intel Corporation.
Copyright (C) 2003, 2004, 2005 Andriy Skulysh
Copyright (C) 2000 Stuart Menefy
Copyright (C) 2002 Thomas Gleixner (tglx@linutronix.de)
Copyright (c) 2012 Marvell Technology Ltd. Yunfan Zhang <yfzhang@marvell.com>
Copyright (c) 2015 Texas Instruments Inc.
(c) 2004 Mickael Hoerd, <hoerd@clarinet.u-strasbg.fr> LSIIT Laboratory, Strasbourg, France
Copyright(c) 2008 Intel Corporation. All rights reserved.
Copyright (C) 2002 STMicroelectronics
Copyright 2011 Paul Mackerras, IBM Corp. <paulus@au1.ibm.com>
Copyright (c) 2010, 2011 Ericsson AB.
Copyright (c) 2012-2014 Andy Lutomi <luto@amacapital.net>
Copyright (C) 2008 Freescale Semiconductor Inc. John Rigby <jrigby@gmail.com> Added support for MPC5121
Copyright (C) 2011 Marvell International Ltd. All rights reserved.
Copyright (C) 2015 Mans Rullgard <mans@mansr.com>
Copyright (c) 2016, Intel Corporation. All Rights Reserved.
(c) 2008-2011 Manuel Lauss <manuel.lauss@googlemail.com>
Copyright (C) 2010 by Mauro Carvalho Chehab
Copyright (C) 2004 - 2010 Vladislav Bolkhovitin <vst@vlnb.net>
Copyright (c) 2019 Microchip Technology Inc. and its subsidiaries
Copyright (c) 2014 Intel Corporation

Copyright (c) 2012-2015,2017 Qualcomm Atheros, Inc.
(C) 2001 - 2013 Tensilica Inc.
Copyright (C) 2006 Thomas Bogendoerfer (tsbogend@alpha.franken.de)
Copyright 2007 Stephane Marchesin All Rights Reserved.
Copyright (C) 2015-19 Renesas Electronics Corporation
Copyright(c) 2006 - 2007 Atheros Corporation. All rights reserved.
Copyright (C) 2002, 2003 Oracle. All rights reserved.
Copyright (C) 2012 ST-Ericsson SA Written on behalf of Linaro for ST-Ericsson Based on bits of regulator core, gpio core and clk core
Copyright (c) 2011-2015, The Linux Foundation. All rights reserved.
Copyright (C) 2016 Sigma Designs
(c) 2001, Dave Jones. (the file handling bit);(c) 2005, Joel Schopp <jschopp@austin.ibm.com> (the ugly bit);(c) 2007,2008, Andy Whitcroft <apw@uk.ibm.com> (new conditions, test suite);(c) 2008-2010 Andy Whitcroft <apw@canonical.com>;(c) 2010-2018 Joe Perches <joe@perches.com>
Copyright (c) 2018 Facebook Inc. Author: Vijay Khemka <vijaykhemka@fb.com>
Copyright © 2008-2012 Intel Corporation
Copyright 2002-2004, Instant802 Networks, Inc.
Copyright 2011, Netlogic Microsystems.
Copyright IBM Corp. 2009 Author(s): Peter Oberparleiter <oberpar@linux.vnet.ibm.com>
Copyright (C) 2010, Laurent Pinchart <laurent.pinchart@ideasonboard.com>
Copyright (C) 1996, 97, 99, 2000, 03, 04, 06 by Ralf Baechle
Copyright (C) 2016 Renesas Electronics Corp.
Copyright (C) 1995-2005 Russell King
Copyright (C) 2015 Cyrille Pitchen <cyrille.pitchen@atmel.com>
Copyright (c) 2006, Keir Fraser <keir@xensource.com>
Copyright 2007 Wolfson Microelectronics PLC. Author: Graeme Gregory graeme.gregory@wolfsonmicro.com
Copyright (C) 2003 Oliver Endriss
(C) 2001 Clemson University and The University of Chicago
Copyright (C) 2012 Javier Martinez Canillas <javier@osg.samsung.com>
Copyright (C) 2005 IBM.
Copyright (c) David L. Mills 1993 *
Copyright (C) 2000 Russell King
Copyright (C) 2016 Krzysztof Adamski <k@japko.eu>
Copyright (c) 2018 BayLibre, SAS Author: Neil Armstrong <narmstrong@baylibre.com>
Copyright (c) 2015 Broadcom. All rights reserved.
Copyright (C) 2018, ARM
Copyright (C) 2012 Anssi Hannula <anssi.hannula@iki.fi>
Copyright (c) 2017 Melexis <cmo@melexis.com>
Copyright (c) 2000 by Abramo Bagnara <abramo@alsa-project.org>
Copyright (C) 2011 Magnus Damm
Copyright (C) 1997 - 2000, 2003 Ralf Baechle <ralf@linux-mips.org>
Copyright (c) 2016, Prodis S.L.
Copyright IBM Corp. 2000, 2009 Author(s): Hartmut Penner <hp@de.ibm.com>, Martin Schwidofsky <schwidofsky@de.ibm.com>, Christian Ehrhardt <ehrhart@de.ibm.com>,
Copyright 2011-2015 VMware, Inc., Palo Alto, CA., USA
Copyright (c) by Jaroslav Kysela <perex@perex.cz>, Takashi Iwai <tiwai@suse.de> Creative Labs, Inc.
Copyright (c) 2008 Zhang Le <r0bertz@gentoo.org>
Copyright (c) 2011-2014 Integrated Device Technology, Inc. Alexandre Bounine <alexandre.bounine@idt.com>
Copyright (c) 2015-2016 MediaTek Inc. Author: Yong Wu <yong.wu@mediatek.com>
Copyright 2004 (C) Intel Corp.
Copyright IBM Corp. 1999,2012 Author(s): Ingo Adlung (adlung@de.ibm.com) Cornelia Huck (cornelia.huck@de.ibm.com) Arnd Bergmann (arndb@de.ibm.com)
Copyright (c) 2015 Joachim Eastwood <manabian@gmail.com>
Copyright (c) 2017 Martin Blumenstingl <martin.blumenstingl@googlemail.com>.
Copyright (c) 2011 Anssi Hannula <anssi.hannula@iki.fi>
Copyright (c) 1998-1999 by Frank van de Pol <fvdpol@coil.demon.nl>
Copyright 2018, Socionext Inc. Author: Kunihiko Hayashi <hayashi.kunihiko@socionext.com>

LICENCE TERMS (cont.)

Copyright (c) 2012, NVIDIA CORPORATION. All rights reserved. Author: Laxman dewangan <ldewangan@nvidia.com>
Copyright (C) 2005 David S. Miller (davem@davemloft.net)
copyright;(C) Copyright 2006 Sven Anders, <anders@anduras.de> and Marcus Junker, <junker@anduras.de>
Copyright (C) 2007-2016 Silicon Graphics, Inc. All rights reserved.
Copyright (c) 2004-2005, Szabolcs Gyurko <szabolcs.gyurko@tit.hu>
Copyright (C) 2008 Juergen Beisert (kernel@pengutronix.de)
Copyright (C) 2011 ARM Ltd.
Copyright (C) 2017-2018 ARM Limited
Copyright (C) 2005 SAN People
Copyright 2003 NVIDIA, Corporation
Copyright 2008-11 Wolfson Microelectronics PLC. Author: Mark Brown <broonie@opensource.wolfsonmicro.com>
Copyright (c) 2019 Paulo Alcantara <palcantara@suse.de>
Copyright (C) 1995, 1996, 1997, 2000, 2001, 05 by Ralf Baechle
Copyright (c) 2010 Franco Catrin <fcatin@gmail.com>
Copyright (C) 2017 Aditya Prayoga <aditya@kobol.io>
Copyright (C) 1996, 99, 2003 by Ralf Baechle
Copyright (C) 2013 Texas Instruments Incorporated - <http://www.ti.com/> Contact: Eduardo Valentin <eduardo.valentin@ti.com> Tero Kristo <t-kristo@ti.com>
Copyright 2018,2019 NXP
Copyright 2012 Dialog Semiconductor Ltd.
Copyright (C) 2017 Arm Ltd. `ifndef __ASM_VMAP_STACK_H define __ASM_VMAP_STACK_H`
Copyright (C) 2018 Laird
(c) 2010-2012 ST Microelectronics
Copyright (C) 2012 H Hartley Sweeten <hsweeten@visionengravers.com>
Copyright (C) 2006 - 2007 Atmel Corporation
Copyright (C) 2017-2018 SiFive For SiFive's PWM IP block documentation please refer Chapter 14 of Reference Manual : <https://static.dev.sifive.com/FU540-C000-v1.0.pdf>
(C) 2002 - 2003 Dominik Brodowski <linux@brodo.de>
Copyright 2004, 2007 Wolfson Microelectronics PLC. Author: Liam Girdwood <lrg@slimlogic.co.uk>
Copyright (C) 2018 ARM Limited or its affiliates.
Copyright (C) 2000,2001,2002 Stephen Rothwell
Copyright (C) STMicroelectronics 2018 - All Rights Reserved Authors: Ludovic Barre <ludovic.barre@st.com> for STMicroelectronics. Fabien Dessenne <fabien.dessenne@st.com> for STMicroelectronics.
Copyright (C) 2007 Aurelien Jarno <aurelien@aurel32.net>
Copyright (c) 2018 Miquel RAYNAL <miquel.raynal@bootlin.com>
Copyright (C) 2016 Intel Corporation. All rights reserved
Copyright (C) 2006 Paul Mackerras, IBM Corporation <paulus@samba.org>
Copyright (C) 2001-2006,2008,2013 Greg Kroah-Hartman <greg@kroah.com>
"Copyright 2008-2011 Luis R. Rodriguez <mcgrof@qca.qualcomm.com>"
(c) 2006 Wolfson Microelectronics PLC. Graeme Gregory graeme.gregory@wolfsonmicro.com or linux@wolfsonmicro.com
Copyright (C) 1998 Geert Uytterhoeven
Copyright (C) 1994, 1995, 1996, 1998, 1999, 2002, 2003 Ralf Baechle
Copyright (C) 2012,2013 - ARM Ltd Author: Marc Zyngier <marc.zyngier@arm.com>
(C) Rusty Russell, IBM 2002
Copyright (c) 2016 Sławomir Stepien Based on: Peter Rosin's code from mcp4531.c
Copyright (c) 2000 Microsoft Corporation
Copyright (C) 2001, 2002 Frank Mori Hess
Copyright (C) 2003, 2004 Colin Leroy, Rasmus Rohde, Benjamin Herrenschmidt
Copyright (C) 2014, Benoit Masson <yahoo@perenite.com>
Copyright (C) 2004 by Al Borchers (alborchers@steinerpoint.com).
Copyright (C) 2011-2015 Freescale Semiconductor, Inc. All Rights Reserved.
Copyright © 2005-2006 Nokia Corporation
Copyright (C) 2005 - 2008 Jeff Dike <jdike@linux.intel.addtoit.com>
Copyright (C) 2004-2005 Andrey Volkov <avolkov@varma-el.com>, Varma Electronics Oy
Copyright (C) 2016-2018 Author: Matt Ranostay <matt.ranostay@konsulko.com>

Copyright (c) 2007 The University of Aberdeen, Scotland, UK
Copyright (C) 2008 Renesas Solutions Corp.
Copyright (C) 2002 Hewlett Packard
Copyright (c) 2000-2007, 2014-2017 Ericsson AB
Copyright 2009 Roderick Colenbrander
Copyright (c) 1999-2000 by Takashi Iwai <tiwai@suse.de>
Copyright (C) 2003 Hewlett-Packard Co David Mosberger-Tang <davidm@hpl.hp.com>
Copyright (C) 2013, Lars-Peter Clausen <lars@metafoo.de> GDMA4740 DMAC support
Copyright (c) 2014 Christian Gmeiner <christian.gmeiner@at> gmail.com>
Copyright (c) 2009 Bruno Prémont <bonbons@linux-vserver.org>
Copyright (c) 2005 Ian Molton
Copyright (C) 2012 Shuah Khan <shuahkhan@gmail.com>
Copyright (C) 2000-2001 Russell King
Copyright (c) 2004 Nex Vision Guillaume GOURAT <guillaume.gourat@nexvision.fr>
Copyright (C) 2016 Ondřej Jirman <megous@megous.com>
(C) Copyright IBM Deutschland Entwicklung GmbH 2007
Copyright (C) 2006, Sascha Hauer, Pengutronix
Copyright (C) 2005 by Thomas Winischhofer, Vienna, Austria
Copyright (C) 2013 Sylwester Nawrocki <sylvester.nawrocki@gmail.com>
Copyright (c) 2012 Tom Harwood
Copyright (C) 2004 - 2006 rt2x00 SourceForge Project <http://rt2x00.serialmonkey.com>
Copyright (c) 2000 Andre Hedrick <andre@linux-ide.org>
Copyright 2013 Linaro Ltd
Copyright © 2013 Jussi Kivilinna <jussi.kivilinna@mbnet.fi>
Copyright 2007 Ben. Herrenschmidt <benh@kernel.crashing.org>, IBM Corp.
Copyright 2000-2010 Broadcom Corporation
Copyright (C) 2013-2014 Marvell
Copyright (C) 1995, 1996 Russell King
Copyright (C) 2013,2019 Intel Corporation
(c) Jaroslav Kysela <perex@perex.cz>
Copyright (c) 2019 Three-Speed Logic, Inc. <gsmecher@threespeedlogic.com>
Copyright (C) 2011 taskit GmbH
Copyright (C) 2001 - 2003 Sistina Software
Copyright (c) 2000,2003 Silicon Graphics, Inc. All rights reserved.
Copyright (C) 2009-2011 Nokia Corporation
Copyright (C) 2011 STMicroelectronics Ltd
Copyright (c) 2016, Avago Technologies
Copyright 2013 Runzhen Wang, IBM Corporation.
Copyright (C) 2009 Red Hat, Inc. Author: Michael S. Tsirkin <mst@redhat.com>
Copyright IBM Corp. 1999, 2000 Author(s): Hartmut Penner (hp@de.ibm.com) Ulrich Weigand (weigand@de.ibm.com) Martin Schwidéfsky (schwidéfsky@de.ibm.com)
Copyright IBM Corp. 2009
Copyright 2007 Davud Gibson, IBM Corporation.
Copyright (c) 2013, The Linux Foundation. All rights reserved.
Copyright (C) 2006 Red Hat, Inc., Ingo Molnar <mingo@redhat.com>
Copyright (c) 2011, 2013 Stefan Kriwanek <dev@stefankriwanek.de>
(c) 1998 Phil Blundell <philb@gnu.org>
Copyright(c) 2018 Intel Corporation. All rights reserved.
Copyright IBM Corporation, 2019
Copyright (C) 2006 Yoichi Yuasa <yuasa@linux-mips.org>
Copyright (C) 2003 Sistina Software.
Copyright (C) 2002 Russell King
Copyright (c) 2014 MundoReader S.L. Author: Matthias Brugger <matthias.bgg@gmail.com>
Copyright (C) 2004 Nokia Corporation Author: Samuel Ortiz <samuel.ortiz@nokia.com>
Copyright (C) 2017 Axis Communications AB
Copyright (C) 2010 Dell Inc. Louis Davis <louis_davis@dell.com> Jim Dailey <jim_dailey@dell.com>
Copyright 2017 Realtek Semiconductor Corp. Author: Bard Liao <bardliao@realtek.com>

LICENCE TERMS (cont.)

Copyright (C) STRATO AG 2012. All rights reserved.
Copyright (C) 2006-2009 Mauro Carvalho Chehab <mchehab@kernel.org>
Copyright (c) 2013, 2018, The Linux Foundation. All rights reserved.
Copyright 2018 NXP
Copyright 2011 Realtek Semiconductor Corp. Author: Johnny Hsu <johnnyhsu@realtek.com>
Copyright (c) 2003, Intel Corporation
Copyright (C) 2007,2010 Rene Herman
Copyright (C) 2000, 2001, 2002, 2003, 2004 Broadcom Corporation
Copyright (C) 2018 BTicino
Copyright (c) 2017-present, Facebook, Inc.
Copyright (C) 2014 Renesas Solutions Corp.
Copyright (C) 2014-2015 Cogent Embedded, Inc. Author: Sergei Shtylyov <sergei.shtylyov@cogentembedded.com>
Copyright (c) 2013, NVIDIA Corporation.
Copyright (C) 1999-2001 Naval Research Laboratory
Copyright (C) 1994-1999 Russell King
Copyright 2011-2 Wolfson Microelectronics plc
Copyright 2018 NXP Author: Scott Wood <scottwood@freescale.com>
"Copyright (c) 2000 Linus Torvalds & authors"
Copyright (C) 2006 James McKenzie
Copyright 2016, Rashmica Gupta, IBM Corp.
(c) 2004, 2005 Chris Pascoe <c.pascoe@itee.uq.edu.au>;(c) 2004 Gerd Knorr <kxrael@bytesex.org> [SuSE Labs]
Copyright (c) 2009 Alberto Panizzo <maramaopercheseimorto@gmail.com> Based on Marek Vasut work in lms283gf05.h
Copyright (c) 2005 Giorgio Padrin <giorgio@mandarinlogiq.org>
Copyright (C) 2012-2014 Canonical Ltd (Maarten Lankhorst)
Copyright Novell Inc 2010
Copyright (C) 2000 Anton Blanchard (anton@linuxcare.com)
Copyright IBM Corp. 1999 Author(s): Martin Schwidefsky (schwidefsky@de.ibm.com), Christian Borntraeger (cborntra@de.ibm.com),
Copyright(c) 2017 Broadcom
Copyright (C) 2007 Stephen Hemminger <shemminger@linux-foundation.org>
Copyright (c) 2015-2017 Broadcom
Copyright (c) 2006 - 2009 Mellanox Technology Inc. All rights reserved.
Copyright(c) 2016, Analogix Semiconductor. All rights reserved.
Copyright (C) 2007-2008 Yan Burman
Copyright (c) 2012 Bryan Schumaker <bjschuma@netapp.com>
Copyright 2010 Google Inc. All Rights Reserved. Author: dlaurie@google.com (Duncan Laurie)
Copyright (C) 2000-2004 Neil Brown
Copyright (C) 2008 Hewlett-Packard Development Company, L.P. Bjorn Helgaas <bjorn.helgaas@hp.com>
Copyright (C) 2007-2011 Texas Instruments, Inc.
Copyright 2014 - 2015 Freescale Semiconductor, Inc.
(C) Copyright Linaro Limited 2015v2
Copyright (C) 2006 Ralf Baechle <ralf@linux-mips.org>
Copyright (C) 1995-1996 Gary Thomas (gdt@linuxppc.org) Rewritten by Cort Dougan (cort@fslabs.com) for PReP
Copyright (C) 2004 IDT Inc.
Copyright (C) 1996,97,98 Ralph Metzler (rjkm@thp.uni-koeln.de)
Copyright (c) 2002-2004 Johann Deneux
Copyright (C) 2000 David S. Miller (davem@redhat.com)
Copyright (C) 2010, Lars-Peter Clausen <lars@metafoo.de>
Copyright (C) 2014 Linutronix GmbH Author: John Ogness <john.ogness@linutronix.de>
Copyright (C) 2006 - 2009 Paul Mundt
Copyright (C) 2014 H. Nikolaus Schaller <hns@goldelico.com>
Copyright (C) 2018 Martin Willi
Copyright (c) 2002, 2007, 2018 Red Hat, Inc. All rights reserved.
Copyright (C) 2015 Advanced Micro Devices, Inc.
Copyright 2014 Google, Inc.
Copyright (C) 2015-2017 Renesas Electronics Corp.
Copyright(c) 2013 - 2018 Intel Corporation.
Copyright 2014 Sutajio Ko-Usagi PTE LTD
Copyright 2010, IBM Corporation. Author: K.Prasad <prasad@linux.vnet.ibm.com>
Copyright (C) 2012 - Virtual Open Systems and Columbia University
Copyright (C) 2014 Linaro Ltd <ard.biesheuvel@linaro.org>
Copyright (c) 2001-2008 The Regents of the University of Michigan. All rights reserved.
Copyright 2000 Precision Insight, Inc., Cedar Park, Texas.
Copyright (C) 2008 Sirius International (Hong Kong) Limited Timothy Lee <timothy.lee@siriushk.com>
Copyright (C) 2014 Texas Instruments
Copyright (C) 2014 LG Electronics, Inc
Copyright 2014 Elettra-Sincrotrone Trieste S.C.p.A.
Copyright (C) 2012 Open Kernel Labs <www.ok-labs.com>
Copyright 2008 IBM Corporation Author: Nathan Lynch
Copyright (c) 2007 Olivier DANET <odanet@caramail.com>
Copyright (c) 2017 MediaTek Inc. Author: Ming Huang <ming.huang@mediatek.com> Sean Wang <sean.wang@mediatek.com>
Copyright 2008-2010 Freescale Semiconductor, Inc. All Rights Reserved.
Copyright (C) 2001 Keith M Wesolowski
Copyright (C) 2001 Rusty Russell.
Copyright 2004 Motorola Inc.
Copyright (C) 1995, 1996, 1997, 2003 by Ralf Baechle
(C) Copyright 2008-2010 Intel Corporation Author: Sreedhara DS (sreedhara.ds@intel.com)
Copyright (c) 2012-2016 Mentor Graphics Inc.
Copyright (C) 2014 Linaro Ltd. Author: Rob Herring <robh@kernel.org>;(c) Copyright 2004 Hewlett-Packard Development Company, L.P. Bjorn Helgaas <bjorn.helgaas@hp.com>
Copyright (C) 2011 Arnaud Patard <arnaud.patard@rtp-net.org>
Copyright (C) 2004-2007 Texas Instruments
Copyright (c) 2016 Trond Myklebust
Copyright (C) 1998 Harald Koerfgen
Copyright (c) 2018 Broadcom Inc
Copyright (C) 2001 Massimo Dal Zotto <dz@debian.org>
Copyright 2003-2004 Red Hat Inc., Durham, North Carolina.
Copyright (c) 2007, 2017 Oracle and/or its affiliates. All rights reserved.
Copyright 2003 Wolfson Microelectronics PLC. Author: Liam Girdwood <lrg@slimlogic.co.uk>
Copyright (C) 2015 SiS, Inc.
Copyright (C) 2013 LSI
Copyright (c) 2010 Samsung Electronics Co. Ltd http://www.samsung.com/
Copyright: (C) 2007 MontaVista Software, Inc., <source@mvista.com>
Copyright (C) 2010 Red Hat, Inc., Peter Zijlstra
Copyright IBM Corp. 1999, 2009 Author(s): Original Code written by DJ Barrow <djbarrow@de.ibm.com,barrow_dj@yahoo.com> Rewritten by Frank Pavlic <fpavlic@de.ibm.com> and Martin Schwidefsky <schwidefsky@de.ibm.com>
Copyright (C) 2009-2011 Nokia Corporation Paul Walmsley
Copyright (C) 1991 Free Software Foundation, Inc. 51 Franklin St, Fifth Floor, Boston, MA 02110-1301, USA
Copyright (c) 2017, Impinj, Inc.
Copyright (C) 2015 Etnaviv Project
Copyright (C) 2010-2012 Hans de Goede <hdegoede@redhat.com>
Copyright (C) 2005 Trond Myklebust <Trond.Myklebust@netapp.com> Modified by David Howells <dhowells@redhat.com>
Copyright 2008-2010 Cisco Systems, Inc. All rights reserved.
Copyright (c) 2005 Topspin Communications. All rights reserved.
Copyright (C) 2012 Analog Device Inc. Author: Lars-Peter Clausen <lars@metafoo.de>
Copyright (c) 2015-2018 Red Hat Inc.
Copyright 2019 Linaro, Ltd, Rob Herring <robh@kernel.org>
Copyright (C) 2010 - 2013 Samsung Electronics Co., Ltd. Sylwester Nawrocki <s.nawrocki@samsung.com>
Copyright (c) 2017 Mellanox Technologies. All rights reserved.
Copyright (C) 2008 SPES Societa' Progettazione Elettronica e Software Ltd. Author: Luca Santini <luca.santini@spesonline.com>

LICENCE TERMS (cont.)

Copyright (C) 2011 Rostislav Lisovy <lisovy@gmail.com>, Czech Technical University in Prague
Copyright (C) 1996,97,98 Ralph Metzler (rjkm@thp.uni-koeln.de) Marcus Metzler (mocm@thp.uni-koeln.de)
Copyright (C) 2003-2008 Takahiro Hirofuchi
Copyright (C) 1995 David A Rusling
Copyright (c) 2014 Nokia Solutions and Networks.
Copyright 2012 Google, Inc.
Copyright (C) 2004-2006, Intel Corporation
Copyright (C) 1997-2000 Jakub Jelinek (jakub@redhat.com)
Copyright 2010-2011, 2013 Freescale Semiconductor, Inc.
"Copyright: (C) 2017 Linaro Limited"
Copyright IBM Corp. 2006, 2012 Author(s): Cornelia Huck <cornelia.huck@de.ibm.com> Martin Schwidofsky <schwidofsky@de.ibm.com> Ralph Wuethner <rwuethn@de.ibm.com> Felix Beck <felix.beck@de.ibm.com>
Holger Dengler <hd@linux.vnet.ibm.com>
Copyright 2001 MontaVista Software Inc. Author: jsun@mvista.com or jsun@junsun.net
Copyright (C) 2016, Jelle van der Waa <jelle@vdwaa.nl>
Copyright (C) 2011 Theodore Kilgore <kilgota@auburn.edu>
(C) Copyright 2009, Texas Instruments, Inc. http://www.ti.com/
Copyright (C) International Business Machines Corp., 2000-2004
Copyright (C) 2016 Linaro Author: Christoffer Dall <christoffer.dall@linaro.org>
(C) 2002 Nadia Yvette Chambers, IBM
Copyright 2018 NXP Author: Dong Aisheng <aisheng.dong@nxp.com>
Copyright 2010-2011 Freescale Semiconductor, Inc.
Copyright (C) 1998-2000 Michel Aubry
Copyright 2000 Red Hat corp --- All Rights Reserved
Copyright (C) 2017 Jagan Teki <jteki@openedev.com>
(C) by the respective authors, and License.
Copyright (c) 2016 MediaTek Inc. Author: Garlic Tseng <garlic.tseng@mediatek.com> Ir Lian <ir.lian@mediatek.com> Ryder Lee <ryder.lee@mediatek.com>
Copyright (C) 2014 Davidlohr Bueso.
Copyright (c) 2004, 2005 Topspin Communications. All rights reserved.
Copyright (C) 2005 Stelian Pop (stelian@popies.net)
"Copyright: Toby Churchill Ltd Derived from pxa2xx_mainstone.c, by Nico Pitre"
Copyright (c) 2018 Collabora Ltd.
Copyright 2012 Alexandre Pereira da Silva <aletes.xgr@gmail.com>
Copyright (C) 2004 David Gibson, IBM Corporation
Copyright (C) 1999 Stuart Menefy
Copyright (C) 2003,2004 Aurelien Alleaume <slts@free.fr>
Copyright (C) 2013 Greg Ungerer <gerg@uclinux.org>
Copyright (C) 2016 Linaro Ltd <ard.biesheuvel@linaro.org>
Copyright (C) 2007 Instituto Nokia de Tecnologia - INdT Author: Felipe Balbi <felipe.lima@indt.org.br>
Copyright (c) 2018, Mellanox Technologies All rights reserved.
Copyright (C) 2012 Chris Boot, Simon Arlott, Stephen Warren
Copyright (C) 1992 obz under the linux copyright
Copyright (c) NXP 2019
Copyright (c) 2016, The Linux Foundation. All rights reserved.
Copyright (C) 2008-2009, MontaVista Software, Inc. <source@mvista.com> Author: Bartosz Golaszewski <bgolaszewski@baylibre.com>
Copyright 2008 Pierre Ossman
Copyright 2000, 2001, 2002 Red Hat, Inc. All Rights Reserved.
Copyright (C) 2006-2008 Steven Toth <stoth@hauppauge.com>
Copyright (C) 2010, 2011 Texas Instruments Incorporated Contributed by: Mark Salter <msalter@redhat.com>
Copyright 2005-2015 Freescale Semiconductor, Inc.
Copyright (c) 2002 Johann Deneux
Copyright (C) 2000-2001,2005-2006 Toshiba Corporation;(c) MontaVista Software, Inc.
Copyright (C) 2000,2012 MIPS Technologies, Inc. All rights reserved. Authors: Carsten Langgaard <carstenl@mips.com> Steven J. Hill <sjhill@mips.com>
Copyright (c) 2001-2013 ATTO Technology, Inc. mailto:linuxdrivers@attotech.com

Copyright (C) 2013 AMS AG
Copyright (C) 2006 Juerg Haefliger <juergh@gmail.com>
Copyright (c) 2017 PINE64
Copyright (C) 1995, 1996, 1998, 2000, 2001 Free Software Foundation, Inc.
Copyright (C) 2014 NVIDIA Corporation
Copyright (c) 2018 FriendlyElec Computer Tech. Co., Ltd. http://www.friendlyarm.com)
Copyright (C) 1999, 2003-2004 Hewlett-Packard Co Stephane Eranian <eranian@hpl.hp.com>
Copyright (C) 2014 Philipp Zabel, Pengutronix
Copyright (c) 2002-2006, K Fraser
Copyright (C) 2015 He Kuang <hekuang@huawei.com>
Copyright (C) 2016 Linaro Ltd; <ard.biesheuvel@linaro.org>
Copyright (C) 2004-2009 The GameCube Linux Team
(C) 2001 by Jay Schulist <jschlst@samba.org>;(C) 2002-2006 by Harald Welte <laforge@gnumonks.org>;(C) 2003 by Patrick Mchardy <kaber@trash.net>;(C) 2005-2012 by Pablo Neira Ayuso <pablo@netfilter.org>
Copyright (C) 2012-2013 Renesas Electronics Corporation
Copyright (c) 2004-2008 Reyk Floeter <reyk@openbsd.org>
Copyright (c) 2016-2017 Fuzhou Rockchip Electronics Co., Ltd
Copyright (C) 1999,2000 Martin Lucina, Tom Zerucha
Copyright IBM Corp. 2001, 2018 Author(s): Robert Burroughs Eric Rossman (edrossma@us.ibm.com)
Copyright (C) 2012 Renesas Electronics Corporation Author: Guennadi Liakhovetski, <g.liakhovetski@gmx.de>
Copyright (c) 2018-2018 David Veenstra <davidjulianveenstra@gmail.com>
Copyright 2003 José Fonseca.
Copyright (C) 2007, 2008 Compulab, Ltd. Mike Rapoport <mike@compulab.co.il>
Copyright 2006 MontaVista Software, Inc.
Copyright (C) 2013 Kosagi http://www.kosagi.com
(c) Copyright 2002-2013 Datera, Inc.
Copyright (C) 2008 Michal Simek
Copyright (C) 2014 STMicroelectronics (R&D) Limited. Author: Peter Griffin <peter.griffin@linaro.org>
Copyright (C) 2002-2008 Novell/SUSE
Copyright (c) 2016-2018 HiSilicon Technologies Co., Ltd.
Copyright (c) 2019 Facebook define STACK_MAX_LEN 600 define NO_UNROLL clang will not unroll at all. Total program size is around 2k insns
Copyright (C) 2003-2004 Russell King, All Rights Reserved.
"Copyright (C) 2000-2006 Tigran Aivazian <aivazian.tigran@gmail.com> 2006 Shaohua Li <shaohua.li@intel.com> 2013-2016 Borislav Petkov <bp@alien8.de>"
Copyright 2013 Data Modul AG
Copyright (c) 2010-2012, NVIDIA CORPORATION. All rights reserved.
Copyright: |copy| 2009 Intel Corporation Authors: - Yu Zhao <yu.zhao@intel.com> Donald Dutile <ddutile@redhat.com>
Copyright (c) 2006-2007 Mauro Carvalho Chehab <mchehab@kernel.org>
Copyright (C) 2015-2018 Broadcom
Copyright (C) 2009 Felix Fietkau <nbd@nbd.name>
Copyright 2006 Freescale Semiconductor, Inc. Shlomi Gridish <gridish@freescale.com> Jerry Huang <Chang-Ming.Huang@freescale.com>
Copyright (C) 2019 Tejun Heo <tj@kernel.org>
Copyright 2003 Tungsten Graphics, Inc., Cedar Park, Texas. All Rights Reserved.
Copyright (C) International Business Machines Corp., 2000-2003
Copyright (C) 2004 BULL SA.
Copyright (C) 2007 Markus Brunner, Mark Jonas
Copyright (C) 1995, 1996 Olaf Kirch <okir@monad.swb.de>
Copyright (C) 2017 Icenowy Zheng <icenowy@aosc.io>
Copyright (C) 2005 Greg Kroah-Hartman <gregkh@suse.de>
Copyright (C) 2004, 2009, 2010, 2011 Texas Instruments Incorporated Author: Aurelien Jacquot <aurelien.jacquot@ti.com>
Copyright (C) 2018 Socionext Inc. Author: Masahiro Yamada <yamada.masahiro@socionext.com>
Copyright (c) 2016 Joachim Eastwood <manabian@gmail.com>
Copyright (c) 2009-2010 MontaVista Software, LLC.

LICENCE TERMS (cont.)

Copyright (C) 2006 Oliver Endriss
Copyright (C) 2007-2009 ST-Ericsson AB
Copyright(c) 2015 - 2018 Intel Corporation.
Copyright (C) 2013 STMicroelectronics (R&D) Limited.
Copyright (C) 2013 Uwe Kleine-Koenig for Pengutronix
Copyright 2016, Chris Smart, IBM Corporation.
Copyright (C) 2015 Maxime Ripard <maxime.ripard@free-electrons.com>
Copyright (c) 2013 LG Electronics, Namhyung Kim <namhyung@kernel.org>
Copyright (C) 1998 David S. Miller (davem@redhat.com)
Copyright (C) 2004 Red Hat, Inc. All rights reserved.
Copyright (C) 2012 Lemote, Inc. Author: Xiang Yu, xiangy@lemote.com Chen Huacai, chenhc@lemote.com
Copyright (c) 2004 Jocelyn Mayer 2011 Alexander Graf
Copyright 2010 Torez Smith, IBM Corporation.
Copyright (C) 2013 Linaro, Ltd.
Copyright (C) 2000-2001 Marcus Metzler & Ralph Metzler for convergence integrated media GmbH
Copyright 2007-2011 Solarflare Communications Inc.
Copyright (c) 2008-2009 Patrick McHardy <kaber@trash.net>
Copyright(c) 2005 - 2011 Intel Corporation. All rights reserved.
Copyright 2005 MontaVista Software Inc.
Copyright (C) 2011 Alexander Stein alexander.stein@system-electronic.com>
"(C) Copyright (C) 2000-2001 Hugh Blemings <hugh@blemings.org>;(C) Copyright (C) 2002 Greg Kroah-Hartman <greg@kroah.com>"
Copyright (C) 2012 Texas Instruments Incorporated - http://www.ti.com Author: Sebastian Andrzej Siewior <bigeasy@linutronix.de>
Copyright (C) 2001 RidgeRun, Inc. Author: RidgeRun, Inc. Greg Lonnon glonnon@ridgerun.com or info@ridgerun.com
Copyright (C) 2008 Rod Whitby <rod@whitby.id.au>
Copyright (C) 2014 Samsung Electronics Co.Ltd Authors: Akshu Agarwal <akshua@gmail.com> Ajay Kumar <ajaykumar.rs@samsung.com>
Copyright (C) 2014 Renesas Solutions Corp. Kuninori Morimoto <kuninori.morimoto.gx@renesas.com>
Copyright 2010 Canonical, Ltd. Author: Kees Cook <kees.cook@canonical.com>
Copyright (c) 2018, Linaro Ltd. Author: Georgi Djakov <georgi.djakov@linaro.org>
Copyright (C) 2014 Linaro Ltd. <ard.biesheuvel@linaro.org>
Copyright (C) 2013 Linaro Ltd
Copyright (c) 2015 Mellanox Technologies. All rights reserved.
Copyright (C) 2004 - 2008 Texas Instruments Inc.
Copyright (C) 2005 Ludovico Cavedon <cavedon@sss.it> Markus Rechberger <mrrechberger@gmail.com> Mauro Carvalho Chehab <mchehab@kernel.org> Sascha Sommer <saschasommer@freenet.de>
Copyright (C) 2007, David Kilroy
(C) Copyright IBM Corporation 1994, 2004 Authors: Colin DeVilbiss (devilbis@us.ibm.com) Santiago Leon (santil@us.ibm.com) Dave Boutcher (sleddog@us.ibm.com)
Copyright (C) 2014-2015 ARM Ltd.
Copyright (c) 2013-2015, NVIDIA CORPORATION. All rights reserved.
Copyright (c) 2007-2008 Bruno Randolf <bruno@thinktube.com>
Copyright (C) 2001-2015 Intel Corporation Author: 2014, 2015 Lv Zheng <lv.zheng@intel.com> 2006, 2007 Alexey Starikovskiy <alexey.y.starikovskiy@intel.com> 2006 Denis Sadykov <denis.m.sadykov@intel.com> 2004 Luming Yu <luming.yu@intel.com>
Copyright (C) 1995-2003 Mark Adler
Copyright (C) 2008-2009 Marvell Ltd.
(c) 2017 Stefano Stabellini <stefano@aporeto.com>
Copyright (C) 2003 Jens Axboe <axboe@kernel.dk>
Copyright (C) 2016 Linaro, Ltd. <ard.biesheuvel@linaro.org>
Copyright {C} 2009 <Bill.Liu@conexant.com>
Copyright (c) 1996, 2003 VIA Networking Technologies, Inc. All rights reserved.
Copyright (C) 2010-2011 ST-Ericsson
Copyright (C) 2013 Samsung Electronics Co., Ltd. Tomasz Figa <t.figa@samsung.com>
Copyright (C) 2009-2012 ST Microelectronics Viresh Kumar <vireshk@kernel.org>
(C) Copyright 2014 Christophe Vu-Brugier <cvubrugier@fastmail.fm>
Copyright (c) 2017 Facebook Inc.
"Copyright 2007 Johannes Berg <johannes@sipsolutions.net>"
Copyright Benjamin Herrenschmidt & Gavin Shan, IBM Corporation 2012.
Copyright (c) 2014, The Chromium OS Authors. All rights reserved.
Copyright (c) 2017 Dell Inc.
Copyright (C) 2001-2002 Sistina Software (UK) Limited.
Copyright (C) 2011 Samsung Electronics Ltd. http://www.samsung.com/
Copyright (C) 2002 Andreas Gruenbacher <a.gruenbacher@computer.org>
Copyright 2009 Philipp Zabel
Copyright (C) 2007 Nicolas Boichat <nicolas@boichat.ch>
Copyright (C) 2010-2014 ST Microelectronics Pratyush Anand <pratyush.anand@gmail.com> Mohit Kumar <mohit.kumar.dhaka@gmail.com>
Copyright (C) 2007
Copyright (c) 1999 Al Smith;(c) 1995,1996 Christian Vogelgsang,;(c) 1998 Mike Shaver.
Copyright (C) 1999 Niibe Yutaka
Copyright (c) 2008, Darius Augulis <augulis.darius@gmail.com>
Copyright (c) 2008 Instituto Nokia de Tecnologia - INdT Contact: Eduardo Valentin <eduardo.valentin@nokia.com>
Copyright (C) 2012-2013, Guennadi Liakhovetski <g.liakhovetski@gmx.de>
Copyright IBM Corporation, 2007 Author Aneesh Kumar K.V <aneesh.kumar@linux.vnet.ibm.com>
Copyright (c) 2010-2011, Code Aurora Forum. All rights reserved.
Copyright (C) 2010, 2011 Texas Instruments Incorporated Mark Salter <msalter@redhat.com>
(C) 2003 Hiroshi Miura <miura@da-cha.org>
Copyright (c) 2015, Ericsson AB All rights reserved.
Copyright (C) 1997-2014 AudioScience Inc. <support@audioscience.com>;(C) Copyright AudioScience Inc. 1998-2003
(C) 1999, 2000, 05, 06 Ralf Baechle (ralf@linux-mips.org);(C) 1999, 2000 Silicon Graphics, Inc.
Copyright 2008 Realtek Microelectronics Author: flove <flove@realtek.com> Ethan <eku@marvell.com>
Copyright (C) 2016 Xilinx, Inc.
Copyright (c) 2000-2001 Vojtech Pavlik
Copyright (c) 2017 Carlo Caione
Copyright (C) 1993 Greg Harp Portions of this driver are based on code contributed by Brad Peppers
Copyright (c) 2003-2018 LSI Corporation.
Copyright (c) 2015 Hisilicon Limited.
Copyright © 2014-2017 Intel Corporation
Copyright (C) 2011 Texas Instruments Incorporated - http://www.ti.com/ J Keerthy <j-keerthy@ti.com>
Copyright 2003, Jouni Malinen <jkmaline@cc.hut.fi>
Copyright (C) 2016 Fujitsu Technology Solutions GmbH, Thilo Cestonaro <thilo.cestonaro@ts.fujitsu.com>
Copyright (C) 2007-2009 ST-Ericsson AB RTC clock driver for the AB3100 Analog Baseband Chip Author: Linus Walleij <linus.walleij@stericsson.com>
Copyright (c) 2007 Jiri Kosina
Copyright (C) 1995, 1996, 1997, 1998 by Ralf Baechle
Copyright (C) 1992,1993,1994,1995,1996,1997,1999 Australia. E-mail billm@melbpc.org.au |;(c) the magnitude of the exact result (before rounding) is less than 2⁻¹⁶³⁸². d) the magnitude of the final result (after rounding) is exactly 2⁻¹⁶³⁸². e) the magnitude of the exact result would be exactly 2⁻¹⁶³⁸² if the operands were rounded to the current precision before the arithmetic
Copyright (c) 2010 Nokia Corporation Author: Dmitry Kasatkin <dmitry.kasatkin@nokia.com>
Copyright (C) 2006 Jamie Lenehan
Copyright (C) 2002 Red Hat
Copyright (C) 2016-2017 Renesas Electronics Corp.
Copyright (C) 2018 secunet Security Networks AG
Copyright (C) 1994 - 2000 Ralf Baechle
Copyright 2015 Josef Gajdusek <atx@atx.name>
Copyright (c) 2018 Politecnico di Torino define MAP_TYPE BPF_MAP_TYPE_QUEUE include "test_queue_stack_map.h"
Copyright (C) 2007-2008, 2010 Texas Instruments, Inc.
Copyright (C) 2012 NVIDIA CORPORATION. All rights reserved.

LICENCE TERMS (cont.)

Copyright (C) 2009 Oxford Semiconductor Ltd
Copyright (C) 2014-2015 Intel Corp Author: Samreen Nilofer <samreen.nilofer@intel.com> Subhransu S. Prusty <subhransu.s.prusty@intel.com>
(c) 2001, 2006 IBM Corporation.
Copyright (C) ST-Ericsson SA 2010 Author: Shujuan Chen <shujuan.chen@stericsson.com> for ST-Ericsson Author: Joakim Bech <joakim.xx.bech@stericsson.com> for ST-Ericsson Author: Berne Hebarck <berne.hebarck@stericsson.com> for ST-Ericsson. Author: Niklas Hernaeus <niklas.hernaeus@stericsson.com>
"Copyright (C) 2007-2009 Carlos Corbacho <carlos@strangeworlds.co.uk>"
Copyright (C) 2019 Peter Hong <peter_hong@fintek.com.tw>
Copyright: (C) 2012 Julia Lawall,
Copyright 2009 ShotSpotter Inc. Author: Graeme Gregory <gg@slimlogic.co.uk>
Copyright (C) 2009 Atsushi Nemoto
Copyright 2014-16 Peter Meerwald-Stadler <pmeerw@pmeerw.net>
Copyright (c) 2006-2008 Freescale Semiconductor, Inc. All rights reserved.
Copyright (C) 2004 Patrick Boettcher (patrick.boettcher@posteo.de)
Copyright (c) 2009-2010 Wind River Systems, Inc.
Copyright (C) 2001 Tensilica Inc.
(c) under GNU PUBLIC LICENSE
Copyright (c) 2014,2017 Qualcomm Atheros, Inc.
Copyright (C) 2009 Becky Bruce, Freescale Semiconductor
Copyright (C) 2010 Ricardo Martins <rasm@fe.up.pt>
Copyright (c) 2009-2012, NVIDIA Corporation. All rights reserved.
Copyright 2015-2016 by Freescale Semiconductor
Copyright 2005, 2008, 2010-2011 Freescale Semiconductor Inc.
Copyright (c) 2015 Nicira, Inc.
Copyright (c) 2012 Benjamin Tissoires <benjamin.tissoires@gmail.com>
Copyright (C) 2019 Intel Corporation.
Copyright (c) 2015, 2016, IBM Corporation
Copyright (c) by Jaroslav Kysela <perex@perex.cz> Routines for Sound Blaster mixer control
Copyright (C) 2002 Hewlett-Packard Development Group, L.P. Author: Torben Mathiasen <torben.mathiasen@hp.com>
Copyright (C) 1994, 1995, 1996 by Ralf Baechle
Copyright 2013
Copyright (C) 2013-2014 Imagination Technologies Ltd.
(C) 2002 Harald Welte <laforge@gnumonks.org>
Copyright © 2013 Alistair Popple <alistair@popple.id.au> IBM Corporation
Copyright 2009 Alberto Panizzo <maramaoperccheseimorto@gmail.com> updates in <http://alberdroid.blogspot.com/>
Copyright (C) 2018 Author: Mathieu Othacehe <m.othacehe@gmail.com>
Copyright(c) 2007 Atheros Corporation. All rights reserved.
(C) 2007 Kees Lemmens (adapted for kernel 2.6.20)
Copyright (c) Freescale Semiconductor, Inc. 2006. Shlomi Gridish <gridish@freescale.com> Jerry Huang <Chang-Ming.Huang@freescale.com>
Copyright (c) 2007 Freescale Semiconductor
Copyright (c) Cryptoapi developers.
Copyright (C) 2014 Samsung Electronics Bartlomiej Zolnierkiewicz <b.zolnierkie@samsung.com> Lukasz Majewski <l.majewski@samsung.com>
Copyright (C) 2002, 2004, 2005 Oracle. All rights reserved.
Copyright 2012 sTec, Inc.
Copyright (C) 2012 - 2018 Xilinx, Inc Author: Punnaiah Choudary Kalluri <punnaiah@xilinx.com> Author: Naga Sureshkumar Relli <nagasure@xilinx.com>
Copyright 1995 (C) David S. Miller (davem@caip.rutgers.edu)
(C) Copyright IBM 2012;(C) Copyright 2013, 2015 Linaro Limitedv2
Copyright (C) 2014 Matthias Brugger
(c) UCB 1982-1988 Ross Biro Fred N. van Kempen, <waltje@uWalt.NL.Mugnet.ORG>
Copyright 2007-2008 Extreme Engineering Solutions, Inc.
Copyright 2000 - 2001 Silicon Graphics, Inc.
Copyright (C) 2016 Christoph Fritz <chf.fritz@googlemail.com>
Copyright 2011-2019 NW Digital Radio
"Copyright IBM Corp. 2001, 2007 Authors: Peter Tiedemann (ptiedem@de.ibm.com)"
Copyright 2008 Wolfson Microelectronics
Copyright (C) 2017-2018 Hilisicon Electronics Co., Ltd. <http://www.huawei.com>
Copyright (C) 2012 Advanced Micro Devices, Inc. Author: Joerg Roedel <joerg.roedel@amd.com>
Copyright (C) 1998-2003 Hewlett-Packard Co David Mosberger-Tang <davidm@hpl.hp.com> Stephane Eranian <eranian@hpl.hp.com>
Copyright (C) 2015 Linus Walleij
Copyright (C) 2006 Sylvain Munaut <tnt@246tnt.com>
Copyright (c) 2015 MediaTek Inc. Author: Honghui Zhang <honghui.zhang@mediatek.com>
Copyright 2019 Madhavan Srinivasan, IBM Corporation.
Copyright (C) 2013 Altera Corporation Based on gpio-mpc8xxx.c
Copyright (c) 2014 MundoReader S.L. Author: Heiko Stuebner <heiko@sntech.de>
Copyright (C) 2015 Cadence Design Systems Inc.
Copyright (C) 2010 Ericsson AB.
Copyright (C) 2011 Kuninori Morimoto
Copyright (c) 2016, Fuzhou Rockchip Electronics Co., Ltd
Copyright (c) 2018 MediaTek Inc. Author: Zhiyong Tao <zhiyong.tao@mediatek.com>
Copyright (C) 2008 Mark Nelson, IBM Corp.
Copyright (C) 1995, 1996, 1997 by Ralf Baechle
(C) COPYRIGHT 2012-2013 ARM Limited. All rights reserved.
Copyright (c) 2006 Ben Dooks <ben-linux@fluff.org>
Copyright(c) 2017-18 Intel Corporation.
Copyright (C) 2016 Texas Instruments Incorporated - <http://www.ti.com/> Andrew F. Davis <afd@ti.com>
(c) 2007-2009 MSC Vertriebsges.m.b.H., Manuel Lauss <manuel.lauss@gmail.com>
Copyright (c) 2001,2002,2005 Broadcom Corporation
Copyright (C) 2016 Atmel, 2016 Nicolas Ferre <nicolas.ferre@atmel.com>
Copyright 2011 Xillybus Ltd, <http://xillybus.com>
Copyright (C) 2014 Felix Fietkau <nbd@openwrt.org>
Copyright (C) 1998 Philip Blundell <philb@gnu.org>
Copyright IBM Corp. 2018 Author(s): Hendrik Brueckner <brueckner@linux.ibm.com> Thomas Richter <tmricht@linux.ibm.com>
(C) Copyright 2013-2015 Hewlett-Packard Development Company, L.P.
Copyright (C) 2011 Atmel, 2011 Nicolas Ferre <nicolas.ferre@atmel.com> 2012 Joachim Eastwood <manabian@gmail.com>
Copyright (c) 2008 by Takashi Iwai <tiwai@suse.de>
Copyright(c) 2004-2005 Intel Corporation. All rights reserved.
Copyright (C) 1996 Free Software Foundation, Inc. Contributed by David Mosberger (davidm@cs.arizona.edu).
Copyright (c) 2005 Maciej W. Rozycki
Copyright 2012 Maxime Ripard
Copyright (C) 1989, 1991 Free Software Foundation, Inc. 59 Temple Place, Suite 330, Boston, MA 02111-1307 USA
Everyone is permitted to copy and distribute verbatim copies of this license document, but changing it is not allowed.
Copyright (C) 2010-2011 Freescale Semiconductor, Inc.
Copyright (c) 2000-2007 Silicon Graphics, Inc. All Rights Reserved.
(C) Copyright IBM Deutschland Entwicklung GmbH 2005
Copyright (C) 2018 Anup Patel <anup@brainfault.org>
Copyright (C) 1995,1996 by Paul M. Antoine, some code and definitions are by courtesy of Chris Fraser.
Copyright (C) 2009 Texas Instruments.
Copyright (c) 2017 Cavium, Inc.
Copyright (C) 2013-2015 Freescale Semiconductor, Inc.
Copyright (C) 2014 Noralf Tronnes
Copyright (C) 2019 Mohammad Rasim <mohammad.rasim96@gmail.com>
Copyright (c) 2018 Cadence Design Systems Author: Alan Douglas <adouglas@cadence.com>
Copyright (C) 2013, Seth Jennings, IBM
Copyright (c) 2013 H Hartley Sweeten <hsweeten@visionengravers.com>
Copyright (C) 2015-2018 Cirrus Logic, Inc. and Cirrus Logic International Semiconductor Ltd.
Copyright 2013 CompuLab Ltd.

LICENCE TERMS (cont.)

Copyright (C) 2018 Marek Behun <marek.behun@nic.cz>
Copyright (C) 2004-5 by Florian 'Floer' Echterler <echtler@fs.tum.de> and Andreas 'ad' Deresch <aderesch@fs.tum.de>
Copyright (C) 2009-2010 Nokia Corporation Paul Walmsley, Kevin Hilman
Copyright (C) 1993 Hamish Macdonald
Copyright (C) 2015 Joachim Eastwood <manabian@gmail.com>
Copyright(c) 2009 - 2009 Atheros Corporation. All rights reserved.
Copyright (C) 2004 Florian Schirmer <jolt@tuxbox.org>
Copyright (c) 2019 Facebook include <linux/bpf.h> include "bpf_helpers.h"
Copyright (c) 2003-2004 Fabrice Bellard
Copyright (C) 2009-2010 Nokia Corporation.
Copyright(c) 2015 Intel Corporation. All rights reserved.
Copyright (C) 2018 Felix Fietkau <nbd@nbd.name>
Copyright (C) 2009 LSI Corporation.
Copyright(c) 2016-2018 Intel Corporation. All rights reserved.
Copyright (c) 2006 Tower Technologies
Copyright (C) 1999 Convergence Integrated Media GmbH <ralph@convergence.de>
Copyright (c) 1998, 1999 Kyösti Mälkki <kmalkki@cc.hut.fi>
"Copyright (C) 1999 Mike Shaver"
Copyright (C) 2013,2018 Intel Corporation
(C) and server (S):
Copyright (c) 2013, 2014 Phillip Lougher <phillip@squashfs.org.uk>
(c) Amit S. Kale and 2003-2005 (c) MontaVista Software, Inc.
Copyright (C) 2019 Mellanox Technologies
Copyright (C) 2008 Peter Korsgaard <jacmet@sunsite.dk>
Copyright (C) Sistina Software, Inc. 1997-2003 All rights reserved.
(C) 2002-2003 Intel Corp Inaky Perez-Gonzalez <inaky.perez-gonzalez@intel.com>;(c) MontaVista Software, Inc. Daniel Walker <dwalker@mvista.com>;(C) 2005 Thomas Gleixner <tglx@linutronix.de>
Copyright (C) 1999-2009 Silicon Graphics, Inc. All rights reserved.
Copyright (C) 2003 Krzysztof Benedyczak & Michal Wronski
Copyright © 2011 NXP Semiconductors
Copyright (C) 1998-2009, 2011 Texas Instruments. All rights reserved.
Copyright 2013 Anshuman Khandual, IBM Corporation.
Copyright (C) 1996, 99 Ralf Baechle
Copyright (C) 2014 Atmel, 2014 Nicolas Ferre <nicolas.ferre@atmel.com>
Copyright (C) 2013 Marvell
Copyright (c) 2005 Martin Langer <martin-langer@gmx.de>,
Copyright (C) 2004 Texas Instruments
Copyright (C) 2004, 2005, 2006, 2008 Thiemo Seufer
Copyright (c) by Jaroslav Kysela <perex@perex.cz> Creative Labs, Inc. Routines for control of EMU10K1 chips
Copyright (C) 2009 Hans de Goede <hdegoede@redhat.com>
Copyright (c) 2011-2014 Samsung Electronics Co., Ltd. http://www.samsung.com
Copyright (C) 2007-2009 Luca Tettamanti <kronos.it@gmail.com>
Copyright 2012 Intel Corporation; author H. Peter Anvin
Copyright (C) 2005 Jeff Dike (jdike@karaya.com)
Copyright (C) 2008 Kevin D. Kissell
Copyright (C) 2014 GridPoint Author: Jon Ringle <jringle@gridpoint.com>
Copyright (C) 2002 - 2005, Areca Technology Corporation All rights reserved.
Copyright (c) 2009 Philippe Vachon <philippe@cowpig.ca>
Copyright (C) 1996, 1997, Olaf Kirch <okir@monad.swb.de>
Copyright (C) 2015 Amarula Solutions B.V.
Copyright (C) 2009 Red Hat, Inc., Ingo Molnar <mingo@redhat.com>
Copyright (C) 2010 Steven King <sfking@fdwdc.com>
Copyright (C) ST-Ericsson SA 2010 Author: shujuan.chen@stericsson.com for ST-Ericsson.
Copyright (c) 2006-2007 Oliver Bock (bock@tfh-berlin.de)
Copyright (c) 2015-2017, NVIDIA CORPORATION. All rights reserved.
Copyright (C) 2010 ST Microelectronics Rajeew Kumar <rajeewkumar.linux@gmail.com>
Copyright 2008 AMCC <tmarr@amcc.com>
Copyright 2012 Shawn Guo <shawn.guo@linaro.org>
Copyright (C) 2010-2017 Digital Devices GmbH
Copyright (C) 2018 ROHM Semiconductors gpio-bd70528.c ROHM BD70528MWV gpio driver
Copyright (C) 2013 - 2014 Texas Instruments, Inc.
Copyright(c) 2017, Intel Corporation.
Copyright (C) 2005-2007 Red Hat, Inc. All rights reserved.
Copyright (c) 2013 Chanhho Min <chanho.min@lge.com>
Copyright (c) 2008 CSE Semaphore Belgium. by Laurent Pinchart <laurentp@cse-semaphore.com>
Copyright (C) 2017 Milo Kim <woogyom.kim@gmail.com>
Copyright (C) 2018 Rockchip Electronics Co., Ltd. Jeffy Chen <jeffy.chen@rock-chips.com>
Copyright (C) 1997,1999 Jakub Jelinek (jj@ultra.linux.cz)
Copyright (C) 2015 Collabora Ltd. Author: Enric Balletbo i Serra <enric.balletbo@collabora.com>
Copyright (c) 2013 Samsung Electronics Co., Ltd. Author: Andrzej Hajda <a.hajda@samsung.com>
Copyright (c) 1998 by Frank van de Pol <fvdpol@coil.demon.nl> Jaroslav Kysela <perex@perex.cz> 2000 by Takashi Iwai <tiwai@suse.de>
Copyright (c) 2014, Applied Micro Circuits Corporation Author: Feng Kan <fkan@apm.com> Author: Hieu Le <hnle@apm.com>
Copyright (C) 2012 - 2013 Samsung Electronics Co., Ltd. Sylwester Nawrocki <s.nawrocki@samsung.com>
Copyright (C) 1999-2002, 2004 Hewlett-Packard Co Stephane Eranian <eranian@hpl.hp.com> David Mosberger-Tang <davidm@hpl.hp.com>
Copyright (C) 2008 Michael Buesch <m@bues.ch>
Copyright (C) 2017 Endless Mobile, Inc. Authors: David Yang <yangxiaohua@everest-semi.com>, Daniel Drake <drake@endlessm.com>
Copyright (c) 2005 Vojtech Pavlik
Copyright (c) 2003 Zinx Verituse <zinx@epicsol.org>
Copyright (C) 2013 Xilinx
Copyright (c) 2011 Red Hat, Inc. All Rights Reserved.
Copyright (C) 2011 matt mooney <mfm@mutateddisk.com> 2005-2008 Takahiro Hirofuchi
Copyright (C) Andrea Merello 2004-2005 <andrea.merello@gmail.com> Released under the terms of GPL (General Public Licence)
Copyright 2007-2010 Freescale Semiconductor, Inc.
Copyright 2015 Intel Deutschland GmbH
Copyright (c) 2015 Krzysztof Kozlowski
Copyright (C) 2011-2012 Synopsys (www.synopsys.com)
Copyright (C) 2011-2013 Jean-Christophe PLAGNIOL-VILLARD <plagnioj@jcrosoft.com>
Copyright (c) 2012 - 2015 UNISYS CORPORATION All rights reserved.
Copyright (C) 2004-2005 Richard Purdie <rpurdie@rpsys.net>
Copyright (c) 2003-2004, Keir Fraser & Steve Hand
Copyright 2014 Google, Inc Author: Alexandru M Stan <amstan@chromium.org>
Copyright 2013 Realtek Microelectronics Author: Bard Liao <bardliao@realtek.com>
Copyright (C) 2015, Wang Nan <wangnan0@huawei.com>
copyright);(c) MontaVista Software, Inc.
Copyright 2005, 2011-2012 Freescale Semiconductor Inc.
Copyright 2017 Google Inc
Copyright (C) 2011, Laurent Pinchart <laurent.pinchart@ideasonboard.com>
Copyright (C) 2003 Randolph Chung <tausq@debian.org>
(c) ad_user_port_key : Use the user portion of the port-key. The default keeps this empty. These are the upper 10 bits of the port-key and value ranges from 0 - 1023. Following shell code generates these 10 bits and sets it.
Copyright (C) 1997,1998 Jakub Jelinek (jj@sunsite.mff.cuni.cz)
Copyright (c) 2017 Free Electrons <maxime.ripard@free-electrons.com>
Copyright 2007 David Gibson, IBM Corporatio. Based on cuboot-83xx.c, which is:
Copyright 2008 Eric Piel
Copyright (C) 1997, 1998, 1999, 2000, 2009 Ingo Molnar, Hajnalka Szabo Moved from arch/x86/kernel/apic/io_apic.c. Jiang Liu <jiang.liu@linux.intel.com> Enable support of hierarchical irqdomains
Copyright (C) 2015 Marvell International Ltd.
Copyright (c) 2013-2014, The Linux Foundation. All rights reserved.

LICENCE TERMS (cont.)

Copyright 2013 Amarula Solutions
Copyright (c) 2002-2004, K A Fraser, B Dragovic
Copyright IBM Corp. 2001, 2012 Author(s): Robert Burroughs Eric Rossman (edrossma@us.ibm.com) Cornelia Huck <cornelia.huck@de.ibm.com>
Copyright (C) 2016 Google, inc.
Copyright (C) 2003, 06, 07 by Ralf Baechle (ralf@linux-mips.org)
Copyright (C) 2001 Russell King;(C) 2002 - 2004 Dominik Brodowski <linux@brodo.de>
Copyright (C) 1996,1997 Jakub Jelinek (jj@sunsite.mff.cuni.cz)
Copyright 2010 Ion Beam Application, Inc.
Copyright (C) 2006, 2008, 2010 Jean Delvare <jdelvare@suse.de>
Copyright (C) 2016 Feature Integration Technology Inc., (Fintek)
Copyright IBM Corp. 2019 Author(s): Hendrik Brueckner <brueckner@linux.ibm.com> Thomas Richter <tmricht@linux.ibm.com>
Copyright (c) 1991, 1993 The Regents of the University of California. All rights reserved.
Copyright (c) 2011 - 2017 Intel Corporation. All rights reserved.
Copyright IBM Corp. 2004 2005
Copyright (c) 2001 M. R. Brown <mrbrown@linuxdc.org>
Copyright (C) 2005-10 DiBcom (http://www.dibcom.fr/)
Copyright (C) 2017 Jernej Skrabec <jernejskrabec@siol.net>
Copyright (C) ST-Ericsson 2010 - 2013 Author: Martin Persson <martin.persson@stericsson.com> Hongbo Zhang <hongbo.zhang@linaro.org>
Copyright (C) 2011 Red Hat, Inc., Don Zickus <dzickus@redhat.com>
Copyright, IBM Corp. 1999-2002
Copyright (C) 2007 Tehuti Networks Ltd. All rights reserved
Copyright (c) 2014 Scott Feldman <sfeldma@gmail.com>
Copyright (C) 2011 Texas Instruments Incorporated
Copyright (C) 2000 Hewlett-Packard Co
Copyright (C) 2008 Glauber de Oliveira Costa, Red Hat Inc.
(c) Copyright 2004 Benjamin Herrenschmidt (benh@kernel.crashing.org), IBM Corp.
Copyright 2005, 2006, 2007 Freescale Semiconductor Inc.
Copyright (c) 2015 Samsung Electronics Co., Ltd. Author : Chanwoo Choi <cw00.choi@samsung.com>
Copyright(C) Timesys Corporation 2015
Copyright (c) 2015 Hans de Goede <hdegoede@redhat.com>
Copyright (C) 2014 Sergey Senozhatsky
Copyright (C) 2011 Numascale AS. All rights reserved.
Copyright(c) 2018 Intel Corporation.:(C) protects the consumer from speculatively loading the data before the producer pointer actually has been read. If we do not have this barrier, some architectures could load old data as speculative loads are not discarded as the CPU does not know there is a dependency between ->produce
Copyright (C) 1997, 98, 99, 2000, 01, 05 Ralf Baechle (ralf@linux-mips.org)
Copyright (C) 1994 - 2001, 2003 by Ralf Baechle
Copyright (c) 2017 Mariusz Bialonczyk <manio@skyboo.net>
Copyright (c) 2003 Adaptec Inc. 691 S. Milpitas Blvd., Milpitas CA 95035 USA. All rights reserved.
Copyright (c) 2015 The Linux Foundation. All rights reserved.
Copyright (C) 2006 Takashi YOSHII
Copyright (C) 2005-2006 Florian Lohoff (flo@rfc822.org)
Copyright (C) 2016-2014 Synopsys, Inc. (www.synopsys.com)
Copyright (C) 2015 Srinivas Kandagatla <srinivas.kandagatla@linaro.org>
Copyright 2014 MundoReader S.L.
Copyright (C) 2015 STMicroelectronics —All Rights Reserved
Copyright © 2006 Keith Packard
Copyright (C) 2004-2005 IBM Corp. All Rights Reserved.
Copyright (C) 1992-1997, 2000-2003 Silicon Graphics, Inc.
Copyright (c) 2011-2013 Broadcom Corporation
Copyright (C) ST-Ericsson AB 2013 Authors: Vicram Arv Dmitry Tarnyagin <dmitry.tarnyagin@lockless.no> Sjur Brendeland
Copyright (C) 1998-2001, 2003, 2005 Hewlett-Packard Co David Mosberger-Tang <davidm@hpl.hp.com> Stephane Eranian <eranian@hpl.hp.com>

Copyright (C) 2015 Marcel Holtmann <marcel@holtmann.org>
Copyright (c) 2011-2014, The Linux Foundation. All rights reserved.
Copyright (C) 2018 BayLibre, SAS Author: Neil Armstrong <narmstrong@baylibre.com>
Copyright (C) 2006-07 Tower Technologies Author: Alessandro Zummo <a.zummo@towertech.it>
Copyright (c) 2005 Andrea Bittau <a.bittau@cs.ucl.ac.uk>
Copyright (C) 2018, Jacopo Mondi <jacopo@jmondi.org>
Copyright (C) 1998-2003 Michael Hunold <michael@mihu.de>
Copyright (C) 2015 Red Hat
Copyright 2011 by Bryan Wu <bryan.wu@canonical.com>
Copyright (C) 1998-2000 Harald Koerfgen
Copyright 2009 Secret Lab Technologies Ltd. Grant Likely <grant.likely@secretlab.ca> Steven Cavanagh <scavanagh@secretlab.ca>
Copyright (c) 2006, 2007 Cisco Systems, Inc. All rights reserved.
Copyright IBM Corp. 2018 Author(s): Hendrik Brueckner <brueckner@linux.vnet.ibm.com>
Copyright (c) 2004 James Courtier-Dutton <James@superbug.demon.co.uk>
Copyright IBM Corp. 2006 Author(s): Martin Schwidefsky (schwidefsky@de.ibm.com)
Copyright (c) 2014 MediaTek Inc. Author: Xudong Chen <xudong.chen@mediatek.com>
Copyright (C) 2018 Google, Inc.
Copyright (C) 2010 Renesas Solutions Corp.
Copyright (c) 1999 IEM - Winfried Ritsch
(C) 2005 Red Hat
Copyright 2005,2006 Hebert Valerio Riedel <hvr@gnu.org>
Copyright 2019 Ondrej Zary
Copyright (C) 2004 by David Brownell
Copyright 2005,2007 Simtec Electronics
Copyright © 2006-2017 Intel Corporation
(c) mycable GmbH
Copyright (C) 1995-1996 Gary Thomas (gdt@linuxppc.org) Rewritten by Cort Dougan (cort@cs.nmt.edu) for PReP
(C) Copyright 2006-2010 PMC-Sierra Inc
Copyright 2001 MontaVista Software Inc.
Copyright (C) 2012 Alfredo J. Delaiti <alfredodelaiti@netscape.net>
Copyright (C) 2008-2012 Igor M. Liplianin (liplianin@me.by);(c) liplianin@me.by")
Copyright (C) 2007 James E.J. Bottomley James.Bottomley@HansenPartnership.com
Copyright (c) 2015 Pengutronix, Philipp Zabel <p.zabel@pengutronix.de>
Copyright 2006, Johannes Berg <johannes@sipsolutions.net>
Copyright 1992, Linus Torvalds.
Copyright (C) 2015 Christoph Junghans <ottxor@gentoo.org>
Copyright (c) 2016 Qualcomm Atheros, Inc. All rights reserved.
Copyright (C) 2005 Texas Instruments, Inc.
Copyright (C) 2009-2010 Jean-François Moine <http://moinejf.free.fr>
Copyright (C) 2007 Kristoffer Ericson <Kristoffer.Ericson@gmail.com>
Copyright (C) 2013 The IMS Company
Copyright (C) 1996, 1997 Jakub Jelinek (jj@sunsite.mff.cuni.cz)
Copyright 2014 Intel Corporation; author: H. Peter Anvin
Copyright (C) 2012 Intel Corporation Author: Yuanhan Liu <yuanhan.liu@linux.intel.com>
(C) 2012-2013 by Pablo Neira Ayuso <pablo@netfilter.org>
Copyright (C) 2011 Instituto Nokia de Tecnologia
(C) 2002 Pascal Dameme <netinet@freessurf.fr> and Marc Zyngier <mzyngier@freessurf.fr>
Copyright (c) 2016 Rockchip Electronics Co. Ltd. Author: Lin Huang <hl@rock-chips.com>
Copyright © 1999 David A. Hinds. All Rights Reserved.
Copyright (c) 2009 Pavel Machek <pavel@ucw.cz>
Copyright (c) 1999-2002 Vojtech Pavlik
Copyright 2000, 2008 MontaVista Software Inc. Author: MontaVista Software, Inc. <source@mvista.com>
Copyright (c) 2010, ST-Ericsson Author: Dmitry Tarnyagin <dmitry.tarnyagin@lockless.no>
Copyright (C) 2005, 2012 IBM Corporation
Copyright (c) 2016 BayLibre, SAS. Author: Neil Armstrong <narmstrong@baylibre.com>
Copyright IBM Corp. 2007-2010 Mel Gorman <mel@csn.ul.ie>

LICENCE TERMS (cont.)

Copyright (C) 2002-2007 Jeff Dike (jdike@{addtoit,linux.intel}.com)
Copyright (C) STRATO AG 2011. All rights reserved.
Copyright (C) 2008, 2009 Michael Krufky <mkrufky@linuxtv.org>
Copyright (C) 1996-1998 Linus Torvalds & authors (see below)
Copyright (C) 2009-2010, Philippe De Muyter <phdm@macqel.be>
Copyright (C) 1997, Olaf Kirch
Copyright 2019 Collabora Ltd
Copyright (C) 2003-2005,2008 David Brownell
Copyright (C) 2013 ams
Copyright 2005 Thomas Hellstrom. All Rights Reserved.
Copyright (C) 2011 by Jarod Wilson <jarod@redhat.com>
(c) Copyright 2000 Oleg Drokin <green@crimea.edu> Based on SoftDog driver by Alan Cox <alan@lxorguk.ukuu.org.uk>;(c) Copyright 2000 Oleg Drokin <green@crimea.edu>
Copyright (C) 2016 secunet Security Networks AG Author: Steffen Klassert <steffen.klassert@secunet.com>
Copyright (C) 2008 Kuninori Morimoto <morimoto.kuninori@renesas.com>
Copyright 1999 by Werner Cornelius (werner@isdn-development.de)
Copyright (C) 2015 Nikolay Martynov <mar.kolya@gmail.com>
Copyright (C) 1997-2014 AudioScience Inc. <support@audioscience.com>;(C) Copyright AudioScience Inc. 1998-2010
Copyright 2016 IBM Corporation.
Copyright (c) 2013, Wind River Systems All rights reserved.
Copyright (C) 2013 Intel Corporation; author Matt Fleming
Copyright (C) 2018 Stefan Wahren <stefan.wahren@i2se.com>
Copyright (C) 2003-2006, Intel Corporation
Copyright (C) 2008 Lai Jiangshan <laijs@cn.fujitsu.com>
Copyright (C) 2016 Roger Shimizu <rogershimizu@gmail.com>
Copyright (c) <2011-2014> HiSilicon Technologies Co., Ltd. <http://www.hisilicon.com>
Copyright (C) 2013 Guangliang Zhao, <luicienchao@gmail.com>
Copyright (C) 2008 Renesas Solutions
Copyright (C) 2008, 2009 PMC Sierra Inc
Copyright (C) 2009 Thomas Kunze
Copyright (C) Fuzhou Rockchip Electronics Co.Ltd Author: Chris Zhong <zyw@rock-chips.com> Ke-Ver Yang <kever.yang@rock-chips.com>
Copyright (C) 2006 FUJITA Tomonori <tomof@acm.org>
Copyright 2019 Realtek Semiconductor Corp. Author: Derek Fang <derek.fang@realtek.com>
(C) 1998-2001 Ben Fennema
Copyright (c) 2015-2016 FUJITSU LIMITED
Copyright (C) 2012,2013 Infineon Technologies
Copyright 2016 Peter Meerwald-Stadler <pmeerw@pmeerw.net>
Copyright (C) 2008-2009 WiZnet Co.,Ltd.
Copyright 2013 CSC Australia Pty. Ltd.
Copyright (c) by Jaroslav Kysela <perex@perex.cz>
Copyright (C) 2015 Cavium Inc. Author: Ganapatrao Kulkarni <gkulkarni@cavium.com>
Copyright (C) 2015 STMicroelectronics - All Rights Reserved
(C) 2007 by Hans J. Koch <hjk@hansjkoeh.de>;(C) 2008, 2009, 2010, 2011 by Marc Kleine-Budde <kernel@pengutronix.de>
Copyright (c) 2014 Jeff Layton <jlayton@primarydata.com>
Copyright (C) 2008 Erik Andr n
Copyright (C) STMicroelectronics 2018 - All Rights Reserved Author: Olivier Bideau <olivier.bideau@st.com> for STMicroelectronics.
Author: Gabriel Fernandez <gabriel.fernandez@st.com> for STMicroelectronics.
Copyright (C) 2004-2008 Silicon Graphics, Inc. All rights reserved.
Copyright 2014-2016 Freescale Semiconductor Inc.
Copyright (c) 2009 Samsung Electronics Co., Ltd. Jaswinder Singh <jassi.brar@samsung.com>
Copyright (c) 2012, Jeff Layton <jlayton@redhat.com>
Copyright (C) 2015-2016 Viresh Kumar <viresh.kumar@linaro.org>
Copyright (C) 1995-1996 Gary Thomas (gdt@linuxppc.org)
Copyright (c) 1998 Michael Zucchi, All Rights Reserved
Copyright 2001 MontaVista Software Inc. Author: MontaVista Software, Inc. ppopov@mvista.com or source@mvista.com
Copyright (c) 2015 Quantenna Communications. All rights reserved.
Copyright (C) 2005 T. Adachi <tadachi@tadachi-net.com>
Copyright(c) 2008 - 2015 Intel Corporation. All rights reserved.
Copyright (c) 2009 Dmitry Torokhov
Copyright (c) 2000,2001 Ghazlane Toumi <gtoumi@messel.emse.fr>
Copyright (C) 2009 Conexant Systems Inc. Authors <shu.lin@conexant.com>, <hiep.huynh@conexant.com> Based on Steven Toth <stoth@linuxtv.org> cx25821 driver Parts adapted/taken from Eduardo Moscoso Rubino (C) Copyright 2003-2006 Sven Anders <anders@anduras.de>
Copyright (C) 2017 Texas Instruments Inc.
(c) INTRACOM S.A. Greece.
Copyright (c) 2007 Manuel Lauss <mano@roarinelk.homelinux.net>
Copyright IBM Corp. 2004
Copyright (C) 2008-2009 USI Co., Ltd.
Copyright (c) 1999 The Puffin Group (David Kennedy and Alex deVries)
Copyright (C)2007 USAGI/WIDE Project
(c) 2008-2011 Mauro Carvalho Chehab <mchehab@kernel.org>;(c) 2008 Devin Heitmueller <devin.heitmueller@gmail.com> (c) 2008 Aidan Thornton <makosoft@googlemail.com>;(c) 2012 Frank Sch fer <fschaefer.oss@googlemail.com>;(c) 2004, 2005 Chris Pascoe <c.pascoe@itee.uq.edu.au>;(c) 2004 Gerd Knorr <kxaxel@bytesex.org>
Copyright (C) 2014 STMicroelectronics R&D Limited
Copyright (C) 2019 Logic PD, Inc.
Copyright (C) 2016, Intel Corporation. All rights reserved.
Copyright (C) 2006-2007 Nokia Corporation
Copyright (C) 2003-2004 Alex Woods <linux-dvb@giblets.org>
Copyright 1993-1999 J rgen Fischer <fischer@norbit.de> TC1550 patches by Luuk van Dijk (ldz@xs4all.nl)
Copyright 2014-2016 Freescale Semiconductor, Inc.
Copyright (c) 2015 Rockchip Electronics Co. Ltd. Author: Jeffy Chen <jeffy.chen@rock-chips.com>
Copyright (C) 2016, Broadcom
Copyright (C) 2009,2012 Andy Walls <awalls@md.metrocast.net>
Copyright (C) 1999-2007, Greg Ungerer (gerg@snapgear.com)
Copyright (C) 2011-2016 Chelsio Communications. All rights reserved.
Copyright (c) by Abramo Bagnara <abramo@alsa-project.org>
Copyright (c) 2012 Bastien Nocera <hadess@hadess.net>
Copyright (C) 2004 - 2005 MIPS Technologies, Inc. All rights reserved. Elizabeth Clarke et. al.
Copyright (C) 2016 Pengutronix
Copyright (C) 2010 Ambient Corporation
Copyright (C) 2003 Red Hat, Inc., James Morris <jmorris@redhat.com>
Copyright (c) 2013-2016, Linux Foundation. All rights reserved.
(C) 2007 aCarLab (India) Pvt. Ltd. (<http://acarlab.com>);(C) 2007 jetzbroadband (<http://jetzbroadband.com>)
Copyright IBM Corporation, 2018 Authors Suraj Jitindar Singh <sjitindarsingh@gmail.com> Paul Mackerras <paulus@ozlabs.org>
Copyright (c) 2014-2018 Nuvoton Technology corporation.
Copyright (C) 1999,2000 ARM Limited
Copyright (C) 2014 Texas Instruments Incorporated - <http://www.ti.com/> Authors: Yong Zhi Mythri pk Archit Taneja <archit@ti.com> Tomi Valkeinen <tomi.valkeinen@ti.com>
Copyright (C) 2003 MontaVista Software Inc. Author: Jun Sun, jsun@mvista.com or jsun@junsun.net
Copyright (C) 2003 Linda Xie <lxie@us.ibm.com>
(c) 2004 Simtec Electronics <http://www.simtec.co.uk/products/SWLINUX/> Ben Dooks <ben@simtec.co.uk>
(C) 2002 by Harald Welte <laforge@netfilter.org>;(C) 2010 Red Hat, Inc.
Copyright (c) 1998-1999 David Huggins-Daines.
(c) Copyright 2005 Webcon, Inc.
Copyright 2000 by Digi International
Copyright (C) 2004-7 DiBcom (<http://www.dibcom.fr/>)
Copyright (C) 1992, 1993, 1994, 1995 Remy Card (card@masi.ibp.fr)
Copyright (C) 2007 Felix Fietkau <nbd@openwrt.org>

LICENCE TERMS (cont.)

copyright 1993-1998 by Donald Becker.
Copyright (C) 2011 - NVIDIA, Inc.
Copyright (c) 2007 Ben Dooks
Copyright (C) 2014, Intel Corporation Author: Mika Westerberg <mika.westerberg@linux.intel.com> Author: Chew Kean Ho <kean.ho.chew@intel.com> Author: Chang Rebecca Swee Fun <rebecca.swee.fun.chang@intel.com> Author: Chew Chiau Ee <chiau.ee.chew@intel.com> Author: Alan Cox <alan@linux.>
Copyright, 1988-1992, Russell Nelson, Crynwr Software
Copyright (C) 2016 Simon Guo, IBM Corporation.
Copyright (c) 2014, Sony Mobile Communications Inc.
Copyright (C) 2009 Chen Liqin <liqin.chen@sunplusct.com>
Copyright (c) 2009 Secret Lab Technologies Ltd.
Copyright 2013-2015 Maxim Integrated Products
Copyright (C) 2015 Tom Zanussi <tom.zanussi@linux.intel.com>
Copyright (c) 2019 Mellanox Technologies.
Copyright (c) 2015 Jiri Pirko <jiri@resnulli.us>
Copyright (C) STMicroelectronics 2018 Author: Pascal Paillet <p.paillet@st.com>
Copyright (c) 2017, HiSilicon. All rights reserved.
Copyright (C) 2003 Atheros Communications, Inc., All Rights Reserved.
Copyright (C) 2009 Red Hat Inc, Peter Zijlstra
Copyright (C) 2004 Cavium Networks
Copyright 1991, 1992 Free Software Foundation, Inc.
Copyright (C) 2016-2018 Linaro Ltd.
Copyright © 2001-2007 Red Hat, Inc.:© 2001-2006 Red Hat, Inc.
Copyright IBM Corp. 2001, 2019 Author(s): Robert Burroughs Eric Rossman (edrossma@us.ibm.com) Cornelia Huck <cornelia.huck@de.ibm.com>
Copyright 2005 Wolfson Microelectronics PLC. Author: Liam Girdwood <lrg@slimlogic.co.uk>
Copyright (C) 1999, 2000 Kaz Kojima & Niibe Yutaka
Copyright (C) 2017 David Lechner <david@lechnology.com>
(C) COPYRIGHT 2014-2018 ARM Limited. All rights reserved.
Copyright (C) 1992,1993,1994,1996,1997,1999 | W. Metzenthien | E-mail billm@melbpc.org.au |
Copyright (c) 2013 Samsung Electronics Co., Ltd. Author: Padmavathi Venna <padma.v@samsung.com>
Copyright IBM Corp. 2012 Author(s): Jan Glauber <jang@linux.vnet.ibm.com>
Copyright (c) 2015 Andrew Lutomirski
Copyright (c) 2010 Ericsson AB.
Copyright (C) 2012-2017 Cavium Inc.
Copyright (C) 2001 Frank Mori Hess <fmhess@users.sourceforge.net>
Copyright (c) 2003, B Dragovic
Copyright 2017 Linaro Ltd.
Copyright (C) 2012 Paul Mundt
Copyright 2009-12 Wolfson Microelectronics
Copyright (C) 2002 Paul Mundt
Copyright (C) 2004 Andrew de Quincey <adq_dvb@lidskialf.net>
Copyright (c) 2018 HiSilicon Technologies Co., Ltd.
Copyright (c) 2016 Linaro Ltd.
Copyright 2017~2019 NXP
Copyright (C) 2014-2015, Freescale Semiconductor
Copyright 2019 IBM Corp. YAML 1.2
Copyright (C) 2012 Intel Corporation Author: Liu Jinsong <jinsong.liu@intel.com> Author: Jiang Yunhong <yunhong.jiang@intel.com>
Copyright (C) 1997-1999 Russell King from:
Copyright (C) 2016 Intel Corp
Copyright (C) 2002 - 2003 Dominik Brodowski <linux@brodo.de>
Copyright (C) 2006, 07 Ralf Baechle (ralf@linux-mips.org)
Copyright (C) 2015 SEI
Copyright (c) 2017 Intel Corporation.
Copyright (c) 2004 Utilitek Systems, Inc.
Copyright (C) 2006-2007 Texas Instruments.

Copyright (c) Siemens AG, 2013
(c) 2007 Manuel Lauss
Copyright (C) 2000-2001 Hewlett-Packard Co Stephane Eranian <eranian@hpl.hp.com>
Copyright (C) 2018 Jernej Skrabec <jernej.skrabec@siol.net> */
Copyright: (C) 2014 Texas Instruments, Inc.
Copyright (C) 2007 - 2009 Intel Corp
Copyright 2004,2012 Freescale Semiconductor, Inc
Copyright (C) 2001 Convergence Integrated Media GmbH
Copyright (C) 2015-2016 Freescale Semiconductor, Inc. All Rights Reserved.
Copyright (c) 2004 Amstrad Plc
Copyright (C) 2007-2008 Intel Corporation <linux-wimax@intel.com> Inaky Perez-Gonzalez <inaky.perez-gonzalez@intel.com> Yanir Lubetkin <yanirx.lubetkin@intel.com>
Copyright (C) 2009, Thomas Gleixner <tglx@linutronix.de>
Copyright 1999-2003 by Mitchell Blank Jr <mitch@sfgoth.com>
Copyright (c) 2018 MediaTek Inc. Author: Chunfeng Yun <chunfeng.yun@mediatek.com>
Copyright (c) 2008 MontaVista Software, Inc.
Copyright (C) 1992,1993,1994,1997,1999 | W. Metzenthien| E-mail billm@melbpc.org.au |
Copyright (C) 2017 Phil Reid
Copyright (c) 2018 Mellanox Technologies. All rights reserved.
Copyright (c) 2017-2018 Covalent IO
Copyright (C) 2013 ST-Ericsson SA Author: Ulf Hansson <ulf.hansson@linaro.org>
Copyright (C) 2010 Marek Vasut <marek.vasut@gmail.com> Pavel Revak <palo@bielyvlk.sk>
Copyright (C) 1997-2000 Klaus Kudielka
Copyright 2009, Oracle. All rights reserved.
Copyright 2007 Dension Audio Systems Ltd. Author: Zoltan Devai
Copyright (C) 2011 Stefan Hajnoczi <stefanha@gmail.com>
Copyright (c) 2003-2015, 2017 Cavium, Inc.
Copyright (c) 2011 Samsung Electronics Co., Ltd. Author: Jingoo Han <jg1.han@samsung.com>
Copyright 2005-2008 Analog Devices Inc.
Copyright (c) 2013 Andrew Duggan <aduggan@synaptics.com>
Copyright (c) 2012-2015, 2017, The Linux Foundation. All rights reserved.
(C) 2015 by Il Han <corone.il.han@gmail.com>
(C) 2005 by Harald Welte <laforge@netfilter.org>;(C) 2006-2012 Patrick McHardy <kaber@trash.net>;(C) 2000-2004 by Harald Welte <laforge@netfilter.org>
Copyright (C) 2009 NetUP Inc.
Copyright 2004 The Unichrome Project. All Rights Reserved.
Copyright (C) 2006-2009 Krzysztof Halasa <khc@pm.waw.pl>
Copyright (c) 2017 Jack Andersen
Copyright 2001-2005 MontaVista Software Inc.
Copyright (C) 2015 Imagination Technologies Author: Zubair Lutfullah Kakakhel <Zubair.Kakakhel@imgtec.com>
Copyright (c) 2005, 2006, 2008 Patrick McHardy <kaber@trash.net>
Copyright (C) 2004 Liu Peng Infineon IFAP DC COM CPE
Copyright 1997 M. Kirkwood
Copyright (C) 2005 Adaptec, Inc. All rights reserved.
Copyright (C) 2009 ST Microelectronics Rajeev Kumar <rajeev-dlh.kumar@st.com>
Copyright (C) 2007-2010 SMSC
Copyright (C) 2016 Linaro Ltd
Copyright (C) 2009-2011 Freescale Semiconductor. Author: Jack Lan <jack.lan@freescale.com>
Copyright (C) 2006 Lennert Buytenhek <buytenh@wantstofly.org>
Copyright (c) 2012 The Chromium OS Authors. All rights reserved.
Copyright (C) 2015-2016 Smart Energy Instruments, Inc.
Copyright (C) 2012-2014 Wolfson Microelectronics plc
Copyright (C) 2010 Marcelo Roberto Jimenez <mroberto@cpti.cetuc.puc-rio.br>
Copyright (C) 2007 MontaVista Software
Copyright (c) 2014, Applied Micro Circuits Corporation Author: Rameshwar Prasad Sahu <rsahu@apm.com> Loc Ho <lho@apm.com>
Copyright (C) 2019 Lorenzo Bianconi <lorenzo@kernel.org>

LICENCE TERMS (cont.)

Copyright (c) 2008 Michael Buesch <m@bues.ch>
Copyright (C) IBM Corporation, 2004. All rights reserved.
Copyright (C) 2016 Maxime Ripard <maxime.ripard@free-electrons.com>
Copyright © 2004 Thomas Gleixner (tglx@linutronix.de)
Copyright (c) 2017 Sebastian Reichel <sre@kernel.org>
Copyright (C) 2004- 2005 Stelian Pop <stelian@popies.net>
Copyright (c) 2000-2005 Silicon Graphics, Inc.
Copyright (C) 2015 Adafruit Industries
Copyright (C) 2003-2011 Jozsef Kadlec <kadlec@netfilter.org>
Copyright Torsten Duwe <duwe@informatik.uni-erlangen.de> 1993
Copyright 2010 Javier Martin <javier.martin@vista-silicon.com>
Copyright (c) 2016 Joel Holdsworth
Copyright (c) 1998, 1999, Rik van Riel <riel@nl.linux.org>
Copyright 2010 Steven King <sfking@fdwcd.com>
Copyright (C) 2012 Samsung Electronics
Copyright (C) 2004, Microtronix Datacom Ltd.
Copyright (C) 2009 Wolfgang Grandegger <wg@grandegger.com>
Copyright (C) 1996-1999 Russell King.
Copyright (C) 2009 by Sascha Hauer, Pengutronix
Copyright © 2005 Agere Systems Inc. All rights reserved. http://www.agere.com
Copyright (C) 2003 Georges Menie
Copyright (C) 2019 Intel Corporation. All rights reserved.
Copyright (c) 2018 NVIDIA CORPORATION. All rights reserved.
Copyright (C) 2012 Thomas Langer <thomas.langer@lantiq.com>
Copyright (C) 1996, 97, 2000, 2001 by Ralf Baechle
Copyright (C) 2014 Atmel, 2014 Nicolas Ferre <nicolas.ferre@atmel.com> 2015 Gregory CLEMENT <gregory.clement@free-electrons.com>
Copyright (C) 2009 Gabor Juhos <juhosg@openwrt.org>
"Copyright: (C) Copyright 2006 Marvell International Ltd."
Copyright (C) 2016 Lukas Wunner <lukas@wunner.de>
Copyright (c) 2012-2015 Qualcomm Atheros, Inc.
Copyright 2018 Ilia Mirkin
Copyright (C) 2001 Deep Blue Solutions Ltd.
Copyright (C) 2013,2017 Johan Hovold <johan@kernel.org>
Copyright (C) 2005-2006 Nokia Corporation
Copyright © 2018 Broadcom
Copyright (c) 2017 Nicira, Inc.
Copyright (C) 2013-2014 Linaro Ltd. Author: Jassi Brar <jassisinghbrar@gmail.com>
Copyright IBM Corp. 2002, 2006 Author(s): Martin Schwidefsky (schwidefsky@de.ibm.com)
Copyright (c) 2013-2017 Qualcomm Atheros, Inc.
Copyright 2016 NXP Semiconductors
Copyright (C) 2015-2016 Freescale Semiconductor, Inc. Author: German Rivera <German.Rivera@freescale.com>
Copyright (C) 1995-2005 Jean-loup Gailly and Mark Adler
Copyright (C) 2001 Mike Corrigan IBM Corporation
Copyright (C) 2000 MIPS Technologies, Inc. All rights reserved.
Copyright (c) 2018 Rodrigo Rivas Costa <rodrigorivascosta@gmail.com>
(c) 1995 Alan Cox, <alan@lxorguk.ukuu.org.uk> Linux Consultancy and Custom Driver Development
(C) 2003-2004 by Harald Welte <laforge@netfilter.org>
Copyright (C) 1997-1998 Russell King
Copyright (C) 1996, 2008 David S. Miller (davem@davemloft.net)
Copyright (c) 2019 SED Systems, a division of Calian Ltd.
Copyright (c) 2014,2015 AMD Corporation. Authors: Ken Xue <Ken.Xue@amd.com> Wu, Jeff <Jeff.Wu@amd.com>
Copyright 2011 ST-Ericsson AB
Copyright (C) Matt Helsley, IBM Corp. 2005 Based on cn_fork.c by Guillaume Thouvenin <guillaume.thouvenin@bull.net>
Copyright 2015 Chen-Yu Tsai
Copyright (C) 1996 X Consortium

Copyright (c) 2008 Erik Andrén
Copyright 2018, Jann Horn <jannh@google.com>
Copyright (C) 1998-2000 Hewlett-Packard Co David Mosberger-Tang <davidm@hpl.hp.com>
Copyright (C) 1996 | W. Metzenthien, 22 Parker St, Ormond, Vic 3163, Australia | E-mail billm@jacobi.maths.monash.edu.au |
Copyright (C) 2015 Altera Corporation <www.altera.com>
Copyright (C) 2003 Richard Curnow, SuperH UK Limited
Copyright 2016, Suraj Jitindar Singh, IBM Corporation.
Copyright (c) International Business Machines Corp., 2002,2007 Author(s): Steve French (sfrench@us.ibm.com)
(C) 2001-2003 Red Hat, Inc. GPL'd
Copyright (c) 2018 by Benjamin Valentin <benpicco@googlemail.com>
Copyright (C) 2014 Texas Instruments Incorporated - http://www.ti.com
Copyright (c) 2007 Julian Scheel <julian@jusst.de>
Copyright (C) 2019 Synopsys Author: Eugeny Paltsev <Eugeny.Paltsev@synopsys.com>
Copyright 2009 Wolfson Microelectronics. PLC.
Copyright IBM Corp. 2016,2019
Copyright (C) 2000 Andrey Panin <pazke@donpac.ru>
Copyright (C) 2013-2019 Freescale Semiconductor, Inc.
Copyright (c) 2006-2008 Freescale Semiconductor, Inc. Author: Scott Wood <scottwood@freescale.com>
Copyright (C) 2003-2006 Kristian Hoegsberg <krh@bitplanet.net>
"Copyright 2006-2010 Johannes Berg <johannes@sipsolutions.net>"
Copyright (C) 2005-2007 Micronas
Copyright (c) 2003 Peter Osterlund <petero2@telia.com>
Copyright (C) 2017 Allied Telesis Labs
Copyright 2015 Hans de Goede <hdegoede@redhat.com>
Copyright 2013 Freescale Semiconductor Inc.
Copyright 2017-2018 Jacopo Mondi <jacopo+renesas@jmondi.org>
Copyright (C) 2007 Jeff Dike (jdike@linux.intel,addtoit).com)
Copyright (c) 2011 Zhao Zhang <zhzhl555@gmail.com>
(C) Copyright 2009, Greg Ungerer <gerg@snapgear.com>
Copyright (C) 1994 Wolfgang Stanglmeier
Copyright (C) 2016 Fuzhou Rockchip Electronics Co., Ltd
Copyright (C) 2016 Uwe Kleine-König <uwe@kleine-koenig.org>
Copyright (C) 2015 MediaTek Inc.
(C) 1994 Linus Torvalds
Copyright(c) 2019 Intel Corporation
Copyright (c) 2014 NVIDIA CORPORATION. All rights reserved.
Copyright (C) 2005-2006 Intel Corporation Reinette Chatre <reinette.chatre@intel.com>
Copyright 2014 Iain Paton <ipaton0@gmail.com>
Copyright (c) 2014 Hannes Reinecke, SUSE Linux GmbH
Copyright (C) 2014 Sebastian Reichel <sre@kernel.org>
Copyright (C) 2005 John McCutchan
Copyright (c) 2005, 2006 Andrea Bittau <a.bittau@cs.ucl.ac.uk>
Copyright 2001 Benjamin Herrenschmidt (benh@kernel.crashing.org)
Copyright (c) 2014, Adam Baker <linux@baker-net.org.uk>
Copyright (C) 1994, 1996, 1998, 2000 Free Software Foundation, Inc.
(C) Copyright 1999, Rob Scott (rscott@mtrob.ml.org)
Copyright (C) ST-Ericsson AB 2010 Author: Daniel Martensson / daniel.martensson@stericsson.com Dmitry Tarnyagin / dmitry.tarnyagin@stericsson.com
Copyright (c) 2006-2008 Nick Kossifidis <mickflemm@gmail.com>
Copyright (C) 2011-2012 Red Hat, Inc.
Copyright (c) 2017, Intel Corporation. Author: Andi Kleen
Copyright (c) 2014 Patrick McHardy <kaber@trash.net>
Copyright (c) 2003 Silicon Graphics, Inc. All rights reserved.
Copyright (C) 2019, Red Hat Inc, Arnaldo Carvalho de Melo <acme@redhat.com>
(c) 2000 Compaq Computer Corporation. (Author: Jamey Hicks);(c) 2009 Dmitry Artamonow <mad_soft@inbox.ru>
(c) 2001,02 Gerd Knorr <kralex@bytesex.org> [SuSE Labs]

LICENCE TERMS (cont.)

Copyright (C) 1996, 1997, 1998, 2003 by Ralf Baechle
Copyright (C) 2014 Hisilicon Ltd.
Copyright (c) 2015 Endless Mobile, Inc. Author: Carlo Caione <carlo@endlessm.com>
Copyright (C) 2017 Amllogic, Inc. All rights reserved
Copyright (C) 2008, 2009 Adam Baker and Theodore Kilgore
Copyright (C) 2018 ARM Limited
Copyright (C) 2005 Zymeta Corporation - Michael Downey (downey@zymeta.com)
Copyright (c) 2003+ Evgeniy Polyakov <johnpol@2ka.mxt.ru>
Copyright (C) 2010 Alexey Charkov <alchark@gmail.com>
Copyright (C) 2013 Texas Instruments, Inc. Santosh Shilimkar <santosh.shilimkar@ti.com>
Copyright (C) 1998-2000 Russell King, Dave Gilbert.
Copyright 2015, 2019 Google LLC
Copyright (C) 2007 by Latchesar Ionkov <lucho@ionkov.net>
Copyright 2013-2014 Hauke Mehrtens <hauke@hauke-m.de>
Copyright (C) 2014 Uwe Kleine-Koenig for Pengutronix
Copyright (C) 2016 Oracle and/or its affiliates. All rights reserved. Author: Khalid Aziz (khalid.aziz@oracle.com)
Copyright 2013 Analog Devices Inc. Author: Lars-Peter Clauen <lars@metafoo.de>
Copyright (C) ST-Ericsson SA 2010 Author: Shujuan Chen <shujuan.chen@stericsson.com> for ST-Ericsson.
Author: Joakim Bech <joakim.xx.bech@stericsson.com> for ST-Ericsson. Author: Berne Hebarck <berne.hebarck@stericsson.com> for ST-Ericsson. Author: Niklas Hernaesus <niklas.hernaesus@sterics
Copyright (C) 2001 Brad Boyer (flar@allandria.com)
Copyright (C) 2017 Facebook Author: Roman Gushchin <guro@fb.com>
Copyright (c) 2003-2013 Broadcom Corporation All Rights Reserved
Copyright (c) by Jaroslav Kysela <perex@perex.cz>, Creative Labs, Inc. Definitions for EMU10K1 (SB Live!)
chips;(c) 2003 - Rear Left */;(c) 2003 - Rear Right */ define EXTOUT_ACENTER 0x11 /* Analog Center */ define
EXTOUT_ALFE 0x12 /* Analog LFE */
Copyright 2013 Intel Corporation All Rights Reserved.
Copyright (C) 2005 - 2009 Paul Mundt
Copyright 2012 Panasonic Corporation
(C) 1999-2001 Paul 'Rusty' Russell;(C) 2002-2004 Netfilter Core Team <coreteam@netfilter.org>;(C) 2006-2012
Patrick McHardy <kaber@trash.net>
Copyright (C) 2018 Renesas Electronics
Copyright (C) by Paul Barton-Davis 1998-1999
Copyright (c) 1994 - 1997, 99, 2000, 06, 07 Ralf Baechle (ralf@linux-mips.org)
Copyright (C) 2004, 2005 Martin Habets (mhabets@users.sourceforge.net)
Copyright (C) 2001-2004 Greg Kroah-Hartman (greg@kroah.com)
Copyright IBM Corp. 2002, 2003 Author(s): Arnd Bergmann (arndb@de.ibm.com) Martin Schwidefsky (schwidefsky@
de.ibm.com)
Copyright (c) 2008, 2009 open80211s Ltd. Authors: Luis Carlos Cobo <luisca@cozybit.com> Javier Cardona
<javier@cozybit.com>
Copyright (C) 2005-2011 Red Hat, Inc. All rights reserved.
Copyright (C) 2008, Volker Weiss <dev@tintuc.de>
Copyright (C) 2005, Pavel Roskin. See main.c for license.
Copyright (C) 2015 Niklas Söderlund
Copyright (C) 1999, 2000 Thomas Sailer (sailer@ife.ee.ethz.ch)
Copyright (C) 1992, 1998-2006 Linus Torvalds, Ingo Molnar
Copyright (C) 2017 - 2018 Hauke Mehrtens <hauke@hauke-m.de>
Copyright (C) 2012, LG Electronics, Namhyung Kim <namhyung.kim@lge.com>
Copyright (C) 2007-2017 Cavium, Inc.
Copyright (C) 2005-6 DiBcom, SA
Copyright (C) 2000-2002 Joakim Axelsson <gozem@linux.nu> Patrick Schaaf <bof@bof.de> Martin Josefsson
<gandalf@wlug.westbo.se>
Copyright (C) 2003 Russell King
Copyright (c) 2010, Citrix
Copyright (C) 2007, Nadi Sarrar
Copyright (C) Fuzhou Rockchip Electronics Co.Ltd Author: Mark Yao <mark.yao@rock-chips.com> Sandy Huang
<hjc@rock-chips.com>

Copyright (C) 2006 Intel Co Fenghua Yu <fenghua.yu@intel.com>
Copyright (C) 2007-2012 ST-Ericsson AB ST DDC I2C master mode driver, used in e.g. U300 series platforms.
Author: Linus Walleij <linus.walleij@stericsson.com> Author: Jonas Aberg <jonas.aberg@stericsson.com>
Copyright (C) 2015-2016 Texas Instruments Incorporated - http://www.ti.com/ Andrew F. Davis <afd@ti.com> Suman
Anna <afd@ti.com>
Copyright (C) 2011 Texas Instruments, Inc. Tero Kristo <t-kristo@ti.com>
Copyright (C) 2017-2018, Intel Corporation
Copyright (C) 1995, 1996, 1997 Paul M. Antoine and Harald Koerfgen
Copyright (c) 2013-2014 ARM Ltd
Copyright (c) 2007-2011 Nicira Networks.
Copyright IBM Corp. 1999 Author(s): Martin Schwidefsky <schwidefsky@de.ibm.com>
Copyright (C) 2012-2014 John McMaster <JohnDMcMaster@gmail.com>
Copyright (c) 2009 Mauro Carvalho Chehab <mchehab@kernel.org>
Copyright 2010 Wolfson Microelectronics PLC.
Copyright (c) 2007-2009 Philipp Zabel <philipp.zabel@gmail.com>
(C) Copyright 2007 Gerald Van Baren, Custom IDEAS, vanbaren@cideas.com
Copyright (C) 2011 Hans Verkuil <hverkuil@xs4all.nl>
Copyright (c) 2000 Linus Torvalds. 2000 Transmeta Corp. 2000-2001 Christoph Rohland 2000-2001 SAP AG 2002
Red Hat Inc.
Copyright (C) 2012 Russell King Derived in part from arch/arm/mach-sa1100/dma.c,
Copyright (C) 2001 - 2003 Jeff Dike (jdike@addtoit.com)
Copyright (c) 2008-2010, 2013 Dave Chinner All Rights Reserved.
Copyright (C) 2002 Ralf Baechle (ralf@linux-mips.org)
Copyright (c) 2011 Extreme Engineering Solution, Inc. Author: Aaron Sierra <asierra@xes-inc.com>
Copyright (C) 2013 Facebook. All rights reserved.
Copyright (c) 2011-2015, 2017, The Linux Foundation. All rights reserved.
Copyright (c) 2003-2014 Cavium Inc.
Copyright (C) 2017-2018 Broadcom. All Rights Reserved.
Copyright 2015 Intel Corporation
Copyright (C) 2015 Chen-Yu Tsai
Copyright (C) 2009 by Jan Weitzel Phytec Messtechnik GmbH <armlinux@phytec.de>
Copyright (C) 1995 by Ralf Baechle
Copyright 2009 Sony Corporation
Copyright (C) 2013, Arnaud EBALARD <arno@natisbad.org>
Copyright (C) 2012-2014 Marvell
Copyright (C) 2016 Synopsys Inc.
Copyright (c) 1996-1999 Distributed Processing Technology Corporation All rights reserved.
Copyright 2013 Aleksandr Kravchenko <x0199363@ti.com>;(c) Peter Meerwald <pmeerw@pmeerw.net>
Copyright (C) 2007, Red Hat, Inc., Ingo Molnar <mingo@redhat.com>
Copyright (C) 2003 Deep Blue Solutions Ltd
Copyright © 2001-2010 David Woodhouse <dwmw2@infradead.org>
Copyright (C) 2014 - STMicroelectronics Inc.
Copyright (C) 1996 David S. Miller
Copyright (C) 2011-2013 Gabor Juhos <juhosg@openwrt.org>
Copyright (C) 2013 Stefani Seibold <stefani@seibold.net>
Copyright 2006 IBM Corporation IUCV protocol stack for Linux on zSeries Version 1.0 Author(s): Jennifer Hunt
<jenhunt@us.ibm.com>
Copyright 2009 Simtec Electronics Ben Dooks <ben@simtec.co.uk> http://armlinux.simtec.co.uk/
Copyright (c) 2003-2006, 2015-2016 Ericsson AB
Copyright (c) 2011 by Jarod Wilson <jarod@redhat.com> based heavily on the work of Stephen Cox, with additional
help from RedRat Ltd.
Copyright (C) 1998-1999, Stephen Tweedie and Bill Hawes
Copyright (c) 2008 Marek Vasut <marek.vasut@gmail.com>
Copyright (C) 2010, Applied Micro Circuits Corporation Victor Gallardo (vgallardo@apm.com)
Copyright (c) 2018 Brian Masney <masneyb@onstation.org>
Copyright (C) 2012 Sascha Hauer, Pengutronix
Copyright (C) 2018 Paul Cercueil Author: Paul Cercueil <paul@crapouillou.net>

LICENCE TERMS (cont.)

Copyright (C)2004 USAGI/WIDE Project
Copyright (C) ST-Ericsson SA 2010 Author: Naveen Kumar G <naveen.gaddipati@stericsson.com> for ST-Ericsson
Copyright (C) 2014 Red Hat, Inc. All rights reserved. Author: Alex Williamson <alex.williamson@redhat.com>
Copyright (C) 2017 Hisilicon Limited Author: Shaokun Zhang <zhangshaokun@hisilicon.com> Anurup M <anurup.m@huawei.com>
Copyright** [copy] 2001-2016 : LinuxTV Developers
Copyright (c) 2012-2016 Zhang, Keguang <keguang.zhang@gmail.com>
Copyright (C) 1999 Walt Drummond <drummond@valinux.com>
Copyright (C) 2006-2008, Uri Shkolnik
(C) Copyright 2003-2007, Greg Ungerer <gerg@snapgear.com>;(C) Copyright 2008, Thomas Chou <thomas@wytron.com.tw>;(C) Copyright 2010, Tobias Klauser <tklauser@distanz.ch>
Copyright (C) 2000, 2001, 2004 MIPS Technologies, Inc.
Copyright (C) 2013 Texas Instruments Incorporated - <http://www.ti.com> Author: Sourav Poddar <sourav.poddar@ti.com>
Copyright (C) 2013 Antti Palosaari <crope@iki.fi>;(C) 1999-2004 Nemosoft Unv.:(C) 2004-2006 Luc Saillard (luc@saillard.org);(C) 2011 Hans de Goede <hdegoede@redhat.com>
Copyright (C) 2006 Qumranet, Inc.
Copyright (c) 2000-2002 Silicon Graphics, Inc. All Rights Reserved.
Copyright (C) 2005, IBM Corp.
Copyright (C) 2015 ARM Ltd.:(c) readl_relaxed(c) define gic_write_lpir(v, c) writel_relaxed(lower_32_bits(v), c)
Copyright (C) 2004 Saito.K & Jeanne(ksaito@interface.co.jp)
Copyright (C) 1998 Thomas Bogendoerfer
Copyright (c) 2008 Renesas Solutions Corp.
Copyright Yaegashi Takeshi, 2001 Adrian McMenamin, 2008 - 2009
Copyright (c) 2003-2004, Keir Fraser
Copyright (C) 2010-2014 Intel Corp Author: Vinod Koul <vinod.koul@intel.com>
Copyright (C) 2017 ARM Limited
(C) Copyright 2008 Stefano Babic, DENX Software Engineering, sbabic@denx.de.
Copyright (C) 2008 Secret Lab Technologies Ltd.
(c) MontaVista Software, Inc.
Copyright 2013 Lucas Stach, Pengutronix <l.stach@pengutronix.de>
Copyright (c) 2012-2014, NVIDIA CORPORATION. All rights reserved.
Copyright (C) 1985 MIPS Computer Systems, Inc.
Copyright (C) 1994 Martin Schaller
Copyright (c) 2014, Applied Micro Circuits Corporation Authors: Iyappan Subramanian <isubramanian@apm.com>
(C) INESC 1998
Copyright (c) 2014-2018, The Linux Foundation. All rights reserved.
Copyright (c) 2010-2014 Samsung Electronics Co., Ltd. <http://www.samsung.com>
Copyright (C) 2010 Compulab Ltd. Author: Mike Rapoport <mike@compulab.co.il>
Copyright (C) 2017 MOXA Inc. - <https://www.moxa.com/>
Copyright (C) 2010-2011 Freescale Semiconductor.
Copyright (C) 2003-2009 Jean Delvare <jdelvare@suse.de>
Copyright (C) 2009 MontaVista Software, Inc. <source@mvista.com>
Copyright (c) 2010-2014 Freescale Semiconductor, Inc.
Copyright (c) 1997 by Procom Technology, Inc. 2001, 2002 by Arnaldo Carvalho de Melo <acme@conectiva.com.br>
Copyright 2007 Michael Buesch <m@bues.ch>
Copyright (C) 2015 STMicroelectronics Pvt. Ltd. All rights reserved.
Copyright (C) 2004 Pengutronix
Copyright (c) 2000 - 2014 Intel Corporation
Copyright (C) 2004 Anton Blanchard <anton@au.ibm.com>, IBM PPC 32 oprofile support: (based on PPC 64 support)
Copyright (C) 2006 Michael Hanselmann (linux-kernel@hansmi.ch)
Copyright (c) 2009 Samsung Electronics Co. Ltd Author: Jaswinder Singh <jassisinghbrar@gmail.com> based upon I2S drivers by Ben Dooks.
Copyright (C) 2004 Nokia Corporation Written by Tony Lindgren <tony@atomide.com> Major cleanups by Juha Yrjölä <juha.yrjola@nokia.com>
Copyright (C) 2003 David Gibson, IBM Corporation.

Copyright (C) Fuzhou Rockchip Electronics Co.Ltd Author: Sandy Huang <hjc@rock-chips.com> Mark Yao <mark.yao@rock-chips.com>
Copyright (C) 2009-2010 by Mauro Carvalho Chehab
Copyright (C) 2005, Marcel Selhorst <tpmdd@selhorst.net> Sirrix AG - security technologies <tpmdd@sirrix.com> and Applied Data Security Group, Ruhr-University Bochum, Germany Project-Homepage: <http://www.trust.rub.de/projects/linux-device-driver-infineon-tpm/>
Copyright (C) 2013-2016 Altera Corporation, All Rights Reserved.
Copyright (C) 2005 Nokia Corporation Written by Tony Lindgren <tony@atomide.com>
Copyright (c) 2006 Damien Bergamini <dami.bergamini@free.fr>
Copyright(c) 1999 - 2006 Intel Corporation. */
Copyright (C) 2010 ST-Ericsson SA
Copyright [copy] 2013 Andrey Smirnov <andrew.smirnov@gmail.com>
Copyright (c) 2016 Mauro Carvalho Chehab <mchehab@kernel.org>
Copyright (c) 2005, 2006 Michael Buesch <m@bues.ch>
Copyright (C) 2011 Samsung Electronics Co., Ltd. MyungJoo.Ham <myungjoo.ham@samsung.com>
Copyright (c) 2016-2017 Lucas Stach, Pengutronix
Copyright IBM Corp. 2017 Author(s): Claudio Imbrenda <imbrenda@linux.vnet.ibm.com>
Copyright Altera Corporation (C) 2012-2014. All rights reserved.
Copyright (c) 2002-2003, Jouni Malinen <jkmaline@cc.hut.fi>
Copyright (c) 2017 Rockchip Electronics Co. Ltd. Author: Elaine <zhangqing@rock-chips.com>
Copyright 2012 Maxime Ripard <maxime.ripard@free-electrons.com>
(c) 2010 Nikolaus Voss, Weinmann Medical GmbH
Copyright (C) 2001 REINER SCT Author: Matthias Bruestle
Copyright (C) 2007 Jens Axboe <jens.axboe@oracle.com>
Copyright(c) 2011-2015 Intel Corporation. All rights reserved.
(C) Copyright IBM 2003, 2004, 2005, 2012;(C) Copyright Linaro Limited 2015v2
(C) Copyright David Brownell 2000-2002
Copyright (C) 2013 John Crispin <blogic@openwrt.org>
Copyright (c) 2008 guiming zhao <gmzhuo@gmail.com>
Copyright (C) 2011-2012 - NVIDIA, Inc.
Copyright (C) 2005 Michel Xhaard <mxhaard@magic.fr>
Copyright (c) 2003 Simtec Electronics Ben Dooks <ben@simtec.co.uk>
Copyright (C) 2012 AK signal Brno a.s. 2012 Jiri Prchal <jiri.prchal@aksignal.cz>
(c) 2009 Arnaldo Carvalho de Melo <acme@redhat.com>
Copyright (C) 2015, Andrew Andrianov <andrew@ncrmnt.org>
Copyright (C) 2015 The Linux Foundation
(c) Copyright 1999 Grant Grundler;(c) Copyright 1999 Hewlett-Packard Company
Copyright (C) 2015 Amlogic, Inc. All rights reserved.
Copyright (c) 2010-2012 Broadcom. All rights reserved.
Copyright IBM Corp. 1999, 2012 Author(s): Denis Joseph Barrow, Martin Schwidfsky <schwidfsky@de.ibm.com>, Heiko Carstens <heiko.carstens@de.ibm.com>;(c) 1995 Alan Cox, CymruNET Ltd <alan@cymru.net>;(c) 1998 Ingo Molnar
Copyright (c) 2008 Intel Corporation Jesse Barnes <jesse.barnes@intel.com>
Copyright (C) 2012 Greg Kroah-Hartman (gregkh@linuxfoundation.org)
Copyright (c) 2007, 2008, 2009 QLogic Corporation. All rights reserved.
Copyright (C) 2010-2011 Neil Brown
Copyright (C) 1991, 1992, 1993, 1997, 2004 Free Software Foundation, Inc. Contributed by Torbjorn Granlund (tege@sics.se).
Copyright (C) 2005 Ilya A. Volynets-Evenbakh
Copyright IBM Corp. 1999 Author(s): Martin Schwidfsky (schwidfsky@de.ibm.com)
Copyright (C) 2014 Christoph Fritz <chf.fritz@googlemail.com>
Copyright(c) 1999-2000 Grant Erickson <grant@lcse.umn.edu>
Copyright 2003,2004 Andi Kleen, SuSE Labs.:(C) Copyright 2005 Christoph Lameter, Silicon Graphics, Inc.
(C) 1991 Linus Torvalds - minix filesystem 1992, 1993, 1994 Eric Youngdale Modified for ISO 9660 filesystem. 1994 Eberhard Mönkeberg - multi session handling. 1995 Mark Dobie - allow mounting of some weird VideoCDs and PhotoCDs. 1997 Gordon Chaffee - Joliet CDs 19
Copyright (c) 2007 Simtec Electronics <http://armlinux.simtec.co.uk/> Ben Dooks <ben@simtec.co.uk>

LICENCE TERMS (cont.)

Copyright 2018 Realtek Semiconductor Corp. Author: Bard Liao <bardliao@realtek.com>
Copyright (C) 2013 Red Hat, Inc. All rights reserved. Author: Alex Williamson <alex.williamson@redhat.com>
Copyright (c) 1999-2001 Motorola, Inc.
Copyright (c) 2015-2017, The Linux Foundation. All rights reserved.
Copyright (C) 2005 Simtec Electronics Ben Dooks <ben@simtec.co.uk>
Copyright (c) 2007-2009 Oliver Neukum
Copyright (C) Alan Cox GW4PTS (alan@lxorguk.ukuu.org.uk)
Copyright (C) 2014-19 Wolfram Sang <wsa@sang-engineering.com>
Copyright (C) 2016 James Pettigrew <james@innovum.com.au>
Copyright © 2008 Keith Packard <keithp@keithp.com>
Copyright 2009 Alessandro Rubini
Copyright (c) 2013 Heiko Stuebner <heiko@sntech.de>
Copyright (C) 2010 Lars-Peter Clausen <lars@metafoo.de>
Copyright (c) 2008 Emcraft Systems Sergei Poselenov <sposelenov@emcraft.com>
Copyright (c) 2008, FUJITSU Limited
Copyright (c) 2015, Linaro Ltd., written by Grant Likely.
Copyright (C) 2012-2016 Alexander Shiyon <shc_work@mail.ru>
Copyright (c) 2017 Hans de Goede <hdegoede@redhat.com>
Copyright 2009 Larry Finger <Larry.Finger@lwfinger.net>
Copyright (c) 2010 Pengutronix e.K. Author: Wolfram Sang <kernel@pengutronix.de>
Copyright (C) 1992 Ross Biro
Copyright (c) 2009,2018 Daniel Mack <daniel@zonque.org>
Copyright (C) 2017 Luxul Inc.
Copyright (C) 2013 Avionic Design GmbH
Copyright (C) 2010 Google, Inc.
(C) 2012 Pablo Neira Ayuso <pablo@netfilter.org>
Copyright (C) 2013 Joachim Eastwood <manabian@gmail.com>
Copyright 2012 Lucas Stach <dev@lynxeye.de>
Copyright (c) 2000 The Regents of the University of Michigan
Copyright (C) 2014 Red Hat, Inc., Johannes Weiner
Copyright 2016 Ezequiel Garcia <ezequiel@vanguardiasur.com.ar>
Copyright (C) 2007 Semihalf Marian Balakowicz <m8@semihalf.com>
Copyright (c) 2005 Voltaire Inc. All rights reserved.
Copyright (C) 2015 Jablotron s.r.o. -- http://www.jablotron.com/ Author: Rostislav Lisovy <lisovy@jablotron.cz>
Copyright (C) 1998, 1999 Frodo Looijaard <frodol@dds.nl> and Kyosti Malkki <kmalkki@cc.hut.fi>
(C) 1995 Linus Torvalds
Copyright (c) 2010 Cisco Systems, Inc.
Copyright 2015 Samuel Pitosiet
(c) 1999 Alpha Processor, Inc.
Copyright (C) 2009 Samsung Electronics Ltd. Jaswinder Singh <jassi.brar@samsung.com>
Copyright (C) 1998-1999 Russell King.
Copyright (c) 2014-2018 The Linux Foundation. All rights reserved.
Copyright (C) 2008-2009 MontaVista Software Inc.
Copyright (C) 2014 Maxime Ripard Maxime Ripard <maxime.ripard@free-electrons.com>
Copyright © 2012-2013 Jussi Kivilinna <jussi.kivilinna@mbnet.fi>
Copyright (C) 1996-2000 Russell King
Copyright (c) 2004 Takashi Iwai <tiwai@suse.de>
Copyright 2016 Amazon.com, Inc. or its affiliates. All Rights Reserved.
Copyright (C) 2014 Linaro Ltd. Author: Anup Patel <anup.patel@linaro.org>
Copyright (C) 2001 - 2003 Tensilica Inc.
Copyright 2016 HUAWEI TECHNOLOGIES CO., LTD.
"Copyright (C) 2016 Intel Corp Authors: Sailaja Bandurupalli <sailaja.bandurupalli@intel.com> Ramesh Babu K V <ramesh.babu@intel.com> Vaibhav Agarwal <vaibhav.agarwal@intel.com> Jerome Anand <jerome.anand@intel.com>"
Copyright (C) 2016 Mauro Carvalho Chehab <mchehab@kernel.org>
Copyright(c) 2009 Intel Corporation
Copyright (C) Hitachi Ltd., 2012

Copyright (C) 2003 Thomas Charbonnel (thomas@undata.org)
Copyright (c) 2016-2017, Mellanox Technologies. All rights reserved.
(C) 2001,2002,2006 by Jan-Benedict Glaw <jbglaw@lug-owl.de>
Copyright(c) 2017 IBM Corporation. All rights reserved.
Copyright 1995-2003 Kai Makisara.
(C) 2006 Tim Small
Copyright by Andreas Eversberg (jolly@eversberg.eu) based on different decoders such as ISDN4Linux
Copyright 2011 Christian König. All Rights Reserved.
(c) 2009 Manuel Lauss <manuel.lauss@googlemail.com>
Copyright (C) 2009 Daniel Mack <daniel@caiaq.de>
Copyright (C) IBM Corporation 2017
Copyright (C) 2008 Takashi Iwai
Copyright (C) 2010 ST Micro Electronics, Deepak Sikri <deepak.sikri@st.com>
Copyright (C) 2005 Ben. Herrenschmidt (benh@kernel.crashing.org)
(C) Copyright IBM Corp. 2005-2008
Copyright IBM Corp. 2004, 2013 Author(s): Arnd Bergmann (arndb@de.ibm.com) Philipp Hachtmann (phacht@de.ibm.com)
Copyright (C) 1991, 1992, 1999 Linus Torvalds
Copyright 2015 Stefan Roese <sr@denx.de>
Copyright (C) 2010 Samsung Electronics Co.Ltd Author: Joonyoung Shim <jy0922.shim@samsung.com> Author: Donghwa Lee <dh09.lee@samsung.com>
Copyright (C) 2013 Google, Inc.
Copyright (c) 2014 Sebastian Reichel <sre@kernel.org>
Copyright (c) 2008 Anssi Hannula <anssi.hannula@gmail.com>
Copyright (c) 2019 Facebook
Copyright (C) 2011 Intel Corporation
Copyright (c) 1998-1999 David Huggins-Daines / Roman Zippel.
Copyright (c) 2000-2006 Silicon Graphics, Inc.
Copyright (C) 2010-2011 Texas Instruments Incorporated - http://www.ti.com/ Authors: Yong Zhi Mythri pk <mythripk@ti.com>
Copyright 2006 Analog Devices Inc.
Copyright 2019 Cadence
Copyright (c) 2005 Samsung Electronics Kyungmin Park <kyungmin.park@samsung.com>
Copyright 2015 Nouveau project
Copyright (C) 2008 Lyrtech inc
Copyright (C) 2002, 2005 MIPS Technologies, Inc. All rights reserved. Authors: Carsten Langgaard <carstenl@mips.com> Maciej W. Rozycki <macro@mips.com>
Copyright (c) 2016 Christoph Hellwig.
Copyright (C) 2017-2018 Willy Tarreau <w@1wt.eu>
Copyright (C) 2017 ARM Limited or its affiliates. Written by Gilad Ben-Yossef <gilad@benyossef.com>
Copyright 2015, Michael Neuling, IBM Corp. Original: Michael Neuling 19/7/2013 Edited: Rashmica Gupta 01/12/2015
Copyright (C) 2004 Antonino Daplas <adaplas@pol.net> All Rights Reserved
Copyright (C) 1999-2004, Greg Ungerer (gerg@snapgear.com)
Copyright (C) 2018 Vladimir Zapolskiy <vz@mleia.com>
Copyright 2016 Realtek Microelectronics Author: Jack Yu <jack.yu@realtek.com>
(C) Copyright 2001 Linus Torvalds
Copyright (C) 2008 Qumranet, Inc.
Copyright (C) 2019 Genesys Logic, Inc.
Copyright (C) 1995-2004 Mark Adler
Copyright IBM Corp. 1999, 2013
Copyright (c) 1998 - 2001 Frodo Looijaard <frodol@dds.nl>, Philip Edelbrock <phil@netroedge.com>, and Mark Studebaker <mduxyz123@yahoo.com>
Copyright 2008-2009: Marvell Corporation, all rights reserved.
Copyright (C) 2005 Tower Technologies Author: Alessandro Zummo <a.zummo@towertech.it>
Copyright (C) 2006 Dennis Munsie <dmunsie@cecropia.com>
Copyright (c) 1999-2000 Vojtech Pavlik

LICENCE TERMS (cont.)

Copyright (c) 2015 Texas Instruments Incorporated
Copyright 2018 Icenowy Zheng <icenowy@aosc.io>
Copyright (c) 2012 Jussi Kivilinna <jussi.kivilinna@mbnet.fi>
Copyright (C) 2017-2018 MediaTek Inc.
Copyright 2013 Intel Corporation; author Matt Fleming
Copyright (c) 2001-2013 ATTO Technology, Inc. mailto:linuxdrivers@attotech.com)mpt3sas/mpt3sas_trigger_diag.
Copyright (C) 1999-2007, Greg Ungerer <gerg@snapgear.com>
Copyright (c) 2009 Don Prince <dhprince.devel@yahoo.co.uk>
Copyright (C) 2006 Frank Mori Hess <fmhess@users.sourceforge.net>
Copyright (C) 1994-2000 Algorithmics Ltd.
Copyright (C) 2004 Texas Instruments, Inc.
(C) Copyright Linaro 2014v2
Copyright (C) 1998, 1999, 2003 by Ralf Baechle
Copyright (C) 2003-2008 Yoichi Yuasa <yuasa@linux-mips.org>
Copyright (C) 2017-2019 Netronome Systems, Inc. */
(C) Copyright 2009 Intel Corporation Author: Arjan van de Ven <arjan@linux.intel.com>
Copyright (c) 2012 - 2014 Xilinx, Inc.
Copyright (C) 1999-2006 Tensilica Inc.
Copyright (c) 2000-2004 Jaroslav Kysela <perex@perex.cz>, Takashi Iwai <tiwai@suse.de>
Copyright © 2016-2017 Broadcom
Copyright (c) 2007-2008 Joern Engel <joern@purestorage.com> Bits and pieces stolen from Peter Zijlstra's code, which is
Copyright (C) 2013 ST-Ericsson SA Written on behalf of Linaro for ST-Ericsson
Copyright Micro Memory INC 2001. All rights reserved.
Copyright (C) 2009 Ivan Kokshaysky
Copyright (C) 2013, 2014 Synopsys, Inc. (www.synopsys.com)
Copyright © 2000 Nicolas Pitre <nico@fluxnic.net>
copyright messages:;(c) Copyright 1996 Alan Cox <alan@lxorguk.ukuu.org.uk>, All Rights Reserved.:(c) Copyright 1995 Alan Cox <alan@lxorguk.ukuu.org.uk>
Copyright (C) 1999 by Michael Engel <engel@unix-ag.org> and Karsten Merker <merker@guug.de>
Copyright (c) 2000-2006, 2018, Ericsson AB
Copyright (C) 2010 Red Hat, Inc. All rights reserved.
Copyright 2004 Simtec Electronics Ben Dooks <ben@simtec.co.uk>
Copyright 2016 Marek Vasut <marek.vasut@gmail.com>
Copyright (C) 2004 Fujitsu Siemens Computers GmbH
Copyright(c) 2013 - 2019 Intel Corporation. */
(C) Copyright 2009 Intel Corporation Author: Jacob Pan (jacob.jun.pan@intel.com) Feng Tang (feng.tang@intel.com)
Copyright (C) 2008 - 2012 Tensilica, Inc.
Copyright (c) 2010 Sergei Kolzun <x0r@dv-life.ru>
(c) Copyright Hewlett-Packard Development Company, L.P., 2007, 2008
Copyright (C) 2000 Thomas Sailer (sailer@ife.ee.ethz.ch)
Copyright (C) 2006, 2014, Intel Corp. Author: Kristen Carlson Accardi <kristen.c.accardi@intel.com> Rafael J. Wysocki <rafael.j.wysocki@intel.com>
Copyright (c) 2016 PLUMgrid
Copyright (C) 1995-1997 Jan "Yenya" Kasprzak <kas@fi.muni.cz>
Copyright 2019, Gustavo Romero, Michael Neuling, IBM Corp.
Copyright (C) 2017-2018 Bartosz Golaszewski <brgl@bgdev.pl>
Copyright (C) 2005-2009, Uri Shkolnik, Anatoly Greenblat
Copyright (c) 2001-2007 Anton Altaparmakov
Copyright (c) 2011, Google, Inc.
(c) Copyright 2002 Guido Guenther <agx@sigxcpu.org>, All Rights Reserved.
Copyright (c) 2009, Intel Corporation.
Copyright (C) 2007-2009, Florian Fainelli <florian@openwrt.org>
Copyright IBM Corp. 1999, 2012 Author(s): Denis Joseph Barrow, Martin Schwidefsky <schwidefsky@de.ibm.com>, Heiko Carstens <heiko.carstens@de.ibm.com>,
COPYRIGHT(C) 2014 VERISILICON
Copyright (C) 2009 Wolfram Sang, Pengutronix e.K.

Copyright (C) 2013 Noralf Tronnes */
Copyright (C) 1997 Paul Mackerras (paulus@samba.org)
Copyright (c) 2017 Paul Cercueil <paul@crapouillou.net>
Copyright (c) 2003-2012 Cavium Inc.
Copyright (C) 1997-2012 AudioScience Inc. <support@audioscience.com>;(C) Copyright AudioScience Inc. 1997-2003
Copyright (C) 2011 ST-Ericsson SA.
Copyright 2015-2016 Analog Devices Inc. Author: Paul Cercueil <paul.cercueil@analog.com>
Copyright 2005-2207 PMC-Sierra, Inc.
Copyright (C) 2011-2013 Xilinx
Copyright 2019 Ilia Mirkin
Copyright (c) 2015, Red Hat, Inc.
"Copyright (C) 2008-14 Intel Corporation Authors: Vinod Koul <vinod.koul@intel.com> Harsha Priya <priya.harsha@intel.com> Dharageswari R <dharageswari.r@intel.com> KP Jeeja <jeeja.kp@intel.com>"
(C) Carnegie Mellon University;(C) 1996, Peter J. Braam;(C) 1997 Carnegie Mellon University
Copyright (c) 2017-2018, Mellanox Technologies inc. All rights reserved.
Copyright (c) 2013, Stephen Warren
Copyright (C) 2012 Renesas Corporation
Copyright (c) 2014-2015 Qualcomm Atheros, Inc.
Copyright IBM Corp. 2007, 2016 Author(s): Martin Schwidefsky <schwidefsky@de.ibm.com>
Copyright (c) 2016, BayLibre, SAS. All rights reserved. Author: Neil Armstrong <narmstrong@baylibre.com>
copyrights (c) 1994 by Michael Hipp (hippm@informatik.uni-tuebingen.de)
Copyright (c) 2012 Red Hat, Inc. Author(s): Jeff Layton <jlayton@redhat.com>
Copyright (c) 2008-2009 Michael Buesch <m@bues.ch>
Copyright (C) 2009 Thomas Gleixner <tglx@linutronix.de>
Copyright (c) 1999-2000 Takashi Iwai <tiwai@suse.de>
Copyright (C) 1999-2003 Hewlett-Packard Co David Mosberger-Tang <davidm@hpl.hp.com>
Copyright (c) 2000-2008 LSI Corporation. All rights reserved.
Copyright (C) 2018, Linaro Ltd.
Copyright (C) 2002-2003 Deep Blue Solutions Ltd, all rights reserved.
Copyright 2007-2008 Paul Mackerras, IBM Corp.
Copyright (C) 2016, Florian Fainelli <f.fainelli@gmail.com>
Copyright (c) 2002 The Regents of the University of Michigan. All rights reserved.
(C) Copyright IBM Corp. 2002, 2004
(c) 2009, Tom Zanussi <tzanussi@gmail.com>
Copyright (C) 2005 Martin Vaughan
Copyright (C) 2009 Mauro Carvalho Chehab <mchehab@kernel.org>
copyright : (C) 2000 by Adaptec
Copyright (c) 2007-2009, MontaVista Software, Inc. <source@mvista.com> Derived from code that was:
Copyright (c) 2008-2009 Cisco Systems, Inc. All rights reserved.
Copyright 2013 Boundary Devices, Inc.
Copyright 2008 Ian Molton <spyro@f2s.com>
Copyright (C) 2002 Jungo Software Technologies.
Copyright (C) 2001 Arcom Control System Ltd
Copyright 2006 Sony Corp.
Copyright (C) 2001-2010 GUAN Xue-tao
Copyright 2017 ATMEL
Copyright (C) 2001-2007 Tensilica Inc.
(c) 1999-2002 Matthew Dharm (mdharm-usb@one-eyed-alien.net);(c) 2000 David L. Brown, Jr. (usb-storage@davidb.org);(c) 2000 Stephen J. Gowdy (SGowdy@lbl.gov);(c) 2002 Alan Stern <stern@rowland.org>;(c) 1999 Michael Gee (michael@linuxspecific.com)
Copyright (C) 1998 D. Jeff Dionne <jeff@lineo.ca>, Kenneth Albanowski <kjahds@kjahds.com>,
Copyright (C) 2006 Kristian Kielhofner <kris@krisk.org>
Copyright (C) 2003 Krzysztof Halasa <khc@pm.waw.pl>
Copyright (C) 1996 Peter J. Braam <braam@maths.ox.ac.uk> and Michael Callahan <callahan@maths.ox.ac.uk>
Copyright (C) 2014 IBM Corp. */ Santiago Leon (santi_leon@yahoo.com) */ Thomas Falcon (tfalcon@linux.vnet.ibm.com) */ John Allen (jallen@linux.vnet.ibm.com)

LICENCE TERMS (cont.)

Copyright (C) 2016 Chen-Yu Tsai <wens@csie.org>
Copyright (C) 2014 Magnus Damm
Copyright IBM Corp. 2001, 2002 Author(s): Carsten Otte <cotte@de.ibm.com> Michael Holzheu <holzheu@de.ibm.com> Tuan Ngo-Anh <ngoanh@de.ibm.com> Martin Schwidofsky <schwidofsky@de.ibm.com> Stefan Bader <shbader@de.ibm.com>
Copyright (C) 2014 by Wolfram Sang, Sang Engineering <wsa@sang-engineering.com>
Copyright (c) 2013 Alex Ling <kasimling@gmail.com>
Copyright (c) 2010 SMSC
Copyright (c) 2016, Applied Micro Circuits Corporation Author: Hoan Tran <hotran@apm.com> Tai Nguyen <ttnghuyen@apm.com>
Copyright (C) 1996, 1999 Silcon Graphics, Inc.
Copyright 2018 Tempo Semiconductor, Inc. Author: Steven Eckhoff <steven.eckhoff.opensource@gmail.com>
Copyright (C) 2009, Jiejing Zhang <kzjeef@gmail.com>
Copyright 2012 Advanced Micro Devices, Inc.
Copyright (C) 2019 Marek Vasut <marex@denx.de>
(C) 2007 Martin K. Petersen <mkp@mkp.net>;(C) 2011 Bartlomiej Zolnierkiewicz
Copyright (C) 2010 Frederic Weisbecker <fweisbec@gmail.com>
Copyright 2006, 2008, 2011-2012 Freescale Semiconductor Inc.
Copyright (C) 2003 Keith M Wesolowski
Copyright (c) 2013 by Evgeny Plehov <Evgeny.Plehov@ukr.net>
Copyright (c) 2002-2005 Sam Leffler, Ermo Consulting
Copyright (c) 2017-2018, The Linux foundation. All rights reserved.
Copyright 2019 Arm Limited Author: Andrew Murray <Andrew.Murray@arm.com>
Copyright (c) 2017 SKIDATA AG
Copyright (C) 2011 Paul Gortmaker.
Copyright (c) 2009, 2018 Oracle and/or its affiliates. All rights reserved.
Copyright (C) 2014, 2017-2018 Author: Matt Ranostay <matt.ranostay@konsulko.com>
Copyright (c) 2013 Mariusz Bialonczyk <manio@skyboo.net>
Copyright © 2016 Collabora Ltd.
Copyright (C) 2010-2017 Digital Devices GmbH Ralph Metzler <rmetzler@digitaldevices.de>
Copyright (c) 2017-2018 Covalent IO, Inc. http://covalent.io
Copyright (c) 2014 Raspberry Pi (Trading) Ltd. All rights reserved.
Copyright (C) 2011 Nokia Corporation
Copyright (C) 1999,2000 MIPS Technologies, Inc. All rights reserved.
Copyright (c) 2011-2015 Synaptics Incorporated
(c) Copyright 2003-2013 Datera, Inc.
Copyright (C) 2011 AppearTV AS
Copyright (C) 2009 David Brownell
Copyright (C) 2016 Ruslan Bilovol <ruslan.bilovol@gmail.com>
Copyright (C) 2003-2006 Simtec Electronics Ben Dooks <ben@simtec.co.uk>
Copyright (C) 2009 SUSE Linux Products GmbH. All rights reserved.
Copyright (C) 2005 <bradlch@hotmail.com>
Copyright (c) 1993, 2000 Joerg Reuter DL1BKE;(c) 1993 Guido ten Dolle PE1NNZ
Copyright (C) 2002-2003 Romain Lievin <roms@tilp.info>
Copyright (C) 2006, Red Hat, Inc., Ingo Molnar
Copyright (C) 2000 Franz Sirl.
Copyright (C) 2002-2006 Kristian Høgsberg
Copyright (C) 2019 Red Hat Inc. All Rights Reserved
Copyright (C) 2012 Samsung Electronics SangYoung Son <hello.son@samsung.com>
Copyright © 2010 ST Microelectronics Shiraz Hashim <shiraz.linux.kernel@gmail.com>
Copyright (C) ST-Ericsson SA 2007-2010 Author: Per Forlin <per.forlin@stericsson.com> for ST-Ericsson Author: Jonas Aaberg <jonas.aaberg@stericsson.com> for ST-Ericsson
Copyright (C) 2009 Janusz Krzysztofik
Copyright (C) 2014 Texas Instruments Inc.
Copyright (C) 2013 Citrix Systems R&D Ltd.
Copyright 2016 United Western Technologies.
Copyright (C) 2001 Sistina Software (UK) Limited
Copyright (c) 2015 MediaTek Inc. Author: Biao Huang <biao.huang@mediatek.com>
Copyright (C) 2008 Brandon Philips <brandon@ifup.org>
Copyright (c) 2003 James Morris <jmorris@intercode.com.au>
Copyright 2001-2002 MontaVista Software Inc.
Copyright (C) 2011 - 2012 Intel Corporation. All rights reserved.
(c) 2014, Sasha Levin <sasha.levin@oracle.com>
Copyright (c) 2014 Lukasz Majewski <l.majewski@samsung.com>
Copyright (c) 2014 Peter Meerwald <pmeerw@pmeerw.net>
Copyright (C) 2018 Hans de Goede <hdegoede@redhat.com>
Copyright (C) 2000, 2001 Keith M Wesolowski
Copyright (C) 2003 Paul Mundt <lethal@linux-sh.org>
Copyright (C) 2018 STMicroelectronics Author(s): Amelie Delaunay <amelie.delaunay@st.com>.
Copyright 2009 Peter Korsgaard <jacmet@sunsite.dk>
Copyright (c) 2011 Samsung Electronics Co., Ltd.
Copyright (c) 2003 Gerd Knorr
Copyright (C) 2003, 07 Ralf Baechle
Copyright 2010-2 Wolfson Microelectronics plc
Copyright (c) 2004-2007 Voltaire, Inc. All rights reserved.
Copyright (C) 1995-1999 Madge Networks Ltd.
Copyright (C) 2009 Sunplus Core Technology Co., Ltd. Lennox Wu <lennox.wu@sunplusct.com> Chen Liqin <liqin.chen@sunplusct.com>
Copyright (C) 2017-2019 Broadcom. All Rights Reserved.
Copyright (C) 1997 Olaf Kirch <okir@monad.swb.de>
Copyright (c) 2017 Google Inc. Author: Wei-Ning Huang <wnhuang@google.com>
Copyright (C) 2000 Harald Koerfgen
Copyright (c) Siemens AG, 2016-2018
Copyright (C) 2012-2013 Hisilicon Ltd.
(C) 1999-2003 Nemosoft Unv.:(C) 2004-2006 Luc Saillard (luc@saillard.org);(C) 2011 Hans de Goede <hdegoede@redhat.com>
Copyright IBM Corp. 2001, 2009 Author(s): Stefan Bader <shbader@de.ibm.com> Michael Holzheu <holzheu@de.ibm.com> Martin Schwidofsky <schwidofsky@de.ibm.com>;(C) 2001,2006 IBM Corporation")
Copyright (c) 2002 Red Hat, Inc. All rights reserved.
(c) 2013 Digital Devices GmbH Germany. All rights reserved
Copyright (C) 2001-2005 Russell King
Copyright (c) by Jaroslav Kysela <perex@perex.cz> Creative Labs, Inc. Lee Revell <lrrevell@joe-job.com>
Copyright (C) 2002-2005 - Tom Zanussi (zanussi@us.ibm.com), IBM Corp
Copyright © 2009-2015 Broadcom Corporation
Copyright 2012 Shiraz Hashim <shiraz.linux.kernel@gmail.com>
Copyright (c) 2013 Jens Kuske <jenskuske@gmail.com>
Copyright 2009 AbsoluteValue Systems <solomon@linux-wlan.com>
Copyright (c) 2002-3 Patrick Mochel
Copyright (C) 2016 Gateworks Corporation, Inc. All Rights Reserved.
Copyright (C) 2004-2007 Cavium Networks
Copyright (c) 2015 Motorola Mobility
Copyright (c) 2004 Topspin Corporation. All rights reserved.
Copyright (c) 2000-2008 LSI Corporation. All rights reserved. *
Copyright (C) 2011 Freescale Semiconductor, Inc.
Copyright (C) 2006, 2007, 2009 Rusty Russell, IBM Corporation
Copyright (c) 2006 Michael Buesch <m@buesch.ch>
Copyright (C) 1998-2002 by Jes Sorensen, <jes@wildopensource.com>.
Copyright © 2007 David Airlie
Copyright (C) 2014 ST Microelectronics Pratyush Anand <pratyush.anand@gmail.com>
Copyright (c) 2016, Collabora Ltd.
Copyright (C) 2012 Texas Instruments, Inc. Thara Gopinath <thara@ti.com>
(c) Copyright © 2003-2006, Marvell International Ltd. All Rights Reserved
Copyright 2018 Luxul Inc.
Copyright (C) 1995-99 Simon G. Vogl With some changes from Kyösti Mälkki <kmalkki@cc.hut.fi> and even Frodo

LICENCE TERMS (cont.)

Looijaard <frodol@dds.nl>
"Copyright: 2007 Metrologic Instruments. All rights reserved."
Copyright (c) 2017-2019 Cirrus Logic, Inc. and Cirrus Logic International Semiconductor Ltd.
Copyright (C) 2001 Rusty Russell, 2002 Rusty Russell IBM.
Copyright 2008 Guennadi Liakhovetski, DENX Software Engineering, <lg@denx.de>
Copyright (C) 2014 Intel Corp
Copyright (c) 2007 Tan Swee Heng <thesweeheng@gmail.com>
Copyright 2016, Michael Ellerman, IBM Corp.
Copyright (C) 2018 Etnaviv Project
(c) Copyright 2005 Google Inc., All Rights Reserved.;(c) Copyright 2000 kernel concepts <nils@kernelconcepts.de>, All Rights Reserved. <http://www.kernelconcepts.de>
Copyright (C) 1999 Silicon Graphics, Inc.
Copyright (c) 2011 Wolfson Microelectronics, plc
Copyright (C) 2006 Benjamin Herrenschmidt <benh@kernel.crashing.org> IBM, Corp.:(C) Copyright 2007-2008 TOSHIBA CORPORATION
Copyright (C) 2007 Antti Palosaari <crope@iki.fi>
Copyright (C) 2000-2001 Deep Blue Solutions
Copyright (c) 2008 Takashi Iwai <tiwai@suse.de>
Copyright (C) 2005 Nokia Corporation
Copyright (c) 2019, Netronome Systems, Inc.
Copyright (C) 2008 Yoshinori Sato Based on arch/sh/kernel/cpu/sh2/entry.S
(c) 2000 Gerd Knorr <kraxel@bytesex.org> Nov 2002: Martin Bene <martin.bene@icomedias.com>: (C) CC Computer Consultants GmbH, 2007;(C) 1999 Rusty Russell (rusty@rustcorp.com.au).
Copyright (C) 2008-2009 Texas Instruments, Inc.
Copyright 2013 Ilia Mirkin
Copyright (C) 2018 Marcus Folkesson <marcus.folkesson@gmail.com>
Copyright (c) 2015, Integrated Device Technology Inc.
Copyright (c) 2013 Intel Corporation. Len Brown <len.brown@intel.com>
Copyright 2011 Roland Stigge <stigge@antcom.de>
Copyright(c) 2008 - 2010 Realtek Corporation. All rights reserved.
Copyright (C) 1999, 2001 Hewlett-Packard Co Stephane Eranian <eranian@hpl.hp.com>
Copyright (c) 2012 Analog Devices, Inc. Author: Lars-Peter Clausen <lars@metafoo.de>
Copyright (C) 2010 ST Microelectronics Viresh Kumar <vireshk@kernel.org>
Copyright (c) 2017 Takashi Sakamoto
Copyright 2007 Jon Loeliger, Freescale Semiconductor, Inc.
Copyright (C) 2009-2010, Lars-Peter Clausen <lars@metafoo.de>
Copyright: [copy] 1995--1999 Martin Mares, <mj@ucw.cz>
Copyright (C) 2006 - 2007 Paul Mundt
Copyright (C) 2015 Renesas Electronics Corporation
Copyright: 2011 Raumfeld GmbH Author: Johannes Stezenbach <js@sig21.net>
Copyright (c) 2016 BayLibre, SAS. Author: Kevin Hilman <khilman@baylibre.com>
Copyright (C) 2015 Texas Instruments Incorporated - <http://www.ti.com/> Author: Jyri Sarha <jsarha@ti.com>
Copyright (c) 2013 Samsung Electronics Co., Ltd. Author: Tarek Dakhran <t.dakhran@samsung.com>
Copyright (C) 2008 Sascha Hauer <s.hauer@pengutronix.de>
"Copyright (c) 1999 Michael Gee <michael@linuxspecific.com>"
Copyright (c) 2001 The Regents of the University of Michigan. All rights reserved.
Copyright (c) 2005 Dirk Opfer
Copyright (C) 1996,1997 Pekka Pietikinen
Copyright (c) 2001 Cliff Brake <cbrake@accelent.com>
(C) Copyright 1999 Randy Dunlap.:(C) Copyright 1999,2000 Thomas Sailer <sailer@ife.ee.ethz.ch>. proc file per device);(C) Copyright 1999 Deti Filegl (new USB architecture)
"Copyright (c) 2006 Jiri Benc <jbenc@suse.cz>"
Copyright (c) 2001, 2002 M. R. Brown <mrbrown@linuxdc.org>
Copyright (C) 2015 Endless Mobile, Inc.
(C) Copyright 1996 Linus Torvalds;(C) Copyright 2002 Red Hat Inc, All Rights Reserved
Copyright (C) 2011 Pengutronix Uwe Kleine-Koenig <u.kleine-koenig@pengutronix.de>
Copyright (C) 2009 Bluewater Systems Ltd Author: Ryan Mallon

Copyright 2011-2012 Freescale Semiconductor, Inc.
Copyright (c) 2010 Rising Tide Systems
Copyright (c) 2011 Jarod Wilson <jarod@redhat.com>
"Copyright 2003-2005 Devicescape Software, Inc."
(C) 1998-2001 Ben Fennema;(C) 1999 Stelias Computing Inc
Copyright (C) 2009, 2010 Red Hat Inc, Steven Rostedt <srstedt@redhat.com>
Copyright: (C) 2013 Julia Lawall, INRIA/LIP6. URL: <http://coccinelle.lip6.fr/>
Copyright (C) 1998, 2001, 03, 07 by Ralf Baechle (ralf@linux-mips.org)
Copyright (C) 2011-2017, Red Hat Inc, Arnaldo Carvalho de Melo <acme@redhat.com>
Copyright 1998-2000 Red Hat, Inc --- All Rights Reserved
Copyright (C) 2004 by Jan-Benedict Glaw <jbglaw@lug-owl.de>;(C) by Vojtech Pavlik
Copyright (c) 2016 Icenowy Zheng <icenowy@aosc.xyz>
Copyright (C) 2010,2011 Google, Inc.
Copyright (C) STMicroelectronics SA 2015 Authors: Yannick Fertre <yannick.fertre@st.com> Hugues Fruchet <hugues.fruchet@st.com>
Copyright 2009 Red Hat, Inc.
Copyright IBM Corp 2000, 2011 Author(s): Holger Smolinski <Holger.Smolinski@de.ibm.com>, Denis Joseph Barrow,
Copyright (c) 2011 Samsung Electronics Co., Ltd. <http://www.samsung.com>
Copyright © 2015 IBM Corporation
(C) 1999-2001 Marc Boucher <marc@mbsi.ca>
Copyright (c) 2016 Fuzhou Rockchip Electronics Co., Ltd
Copyright (C) 2004 Ulf Eklund <ivtv@eklund.to>
Copyright 2009-2015 Freescale Semiconductor, Inc. and others
Copyright (C) 2017 IBM Corp.
Copyright (C) 1996, 1997, 1998, 1999, 2000, 03, 04 by Ralf Baechle
Copyright 2004 Oprofile Authors
Copyright (C) 2006 Steven Toth <stoth@linuxtv.com>
Copyright (c) 2014-2016 Jiri Pirkko <jiri@mellanox.com>
Copyright (C) 2004 Benjamin Herrenschmidt, IBM Corp. benh@kernel.crashing.org
(C) 2013 James Chapman <jchapman@katalix.com>
Copyright (C) 2005 Andrew de Quincey <adq_dvb@lidskialf.net>
Copyright (C) 2006-2007 Riku Voipio
Copyright (c) 2019 Oracle. All Rights Reserved.
Copyright (C) 2014-2017 Phytect Messtechnik GmbH Author: Wadim Egorov <w.egorov@phytec.de> Teresa Remmet <t.remmet@phytec.de>
Copyright (C) 2001 Lennert Buytenhek (buytenh@gnu.org) and James Leu (jleu@mindspring.net).
Copyright (C) 2006 Ralf Baechle (ralf@linux-mips.org)
Copyright (c) 2009 SoftwareBitMaker.
Copyright (C) 2014-15 Intel Corp Author: Jeeja KP <jeeja.kp@intel.com>
Copyright (C) 1994,1996,1998 David S. Miller (davem@caip.rutgers.edu)
Copyright (c) 2013-2014 Samsung Electronics Co., Ltd. <http://www.samsung.com>
Copyright (C) 2006 Andrey Volkov <avolkov@varma-el.com>
Copyright (c) 2015, Christoph Hellwig.
Copyright (C) 2014 Atmel Corporation.
Copyright (c) 2013-2019, VeriSilicon Inc.
Copyright (C) 2010-2011 Canonical Ltd <jeremy.kerr@canonical.com>
Copyright (C) 2007-2008, Advanced Micro Devices, Inc.
Copyright IBM Corp. 2013 Author(s): Ralf Hoppe (rhoppe@de.ibm.com)
Copyright (c) 2009-2011, Intel Corporation.
Copyright (C) 2002-2004 Rohit Seth <rohit.seth@intel.com>
Copyright (C) 2006 Calin A. Cuiianu <calin@ajvar.org>
Copyright (C) 2011 Nokia Corporation Author: Matti Aaltonen <matti.j.aaltonen@nokia.com>
Copyright 2011-2012 Calxeda, Inc.
Copyright 2012 Red Hat, Inc <mjg@redhat.com>
Copyright (C) 2006 Polycom, Inc.
Copyright 2014, Jason Cooper <jason@lakedaemon.net>

LICENCE TERMS (cont.)

Copyright (c) 2009-2011, Code Aurora Forum. All rights reserved.
(c) 2001 Micro Solutions Inc.
Copyright (c) 2014-2015 Takashi Sakamoto
Copyright (C) 2001, 2002, 2003 Broadcom Corporation
Copyright (C) 2010-2011 Hans de Goede <hdegoede@redhat.com>;(C) Copyright 1999-2000 Peter Pregler;(C)
Copyright 1999-2000 Scott J. Bertin;(C) Copyright 1999-2000 Johannes Erdfelt <johannes@erdfelt.com>;(C)
Copyright 2000 STMicroelectronics
Copyright (C) 2006 David Gibson, IBM Corporation.
Copyright (C) 2010 Samsung Electronics Co., Ltd Author: Sylwester Nawrocki, s.nawrocki@samsung.com
Copyright (C) 2019 Jeff Klatsky
Copyright (C) 2004, 05, 06 MIPS Technologies, Inc. Elizabeth Clarke (beth@mips.com) Ralf Baechle (ralf@linux-mips.org)
Copyright (c) 2016 Alexandre Belloni
Copyright (C) 2008 Sergey Lapin Based on ds1307 driver by James Chapman and David Brownell
Copyright (C) 2017, STMicroelectronics - All Rights Reserved Author(s): Lionel DEBIEVE <lionel.debieve@st.com>
for STMicroelectronics.
Copyright 2008 Openmoko, Inc. Simtec Electronics, Ben Dooks <ben@simtec.co.uk>
Copyright (C) 2007-2010 ST-Ericsson Register access functions for the ABX500 Mixed Signal IC family. Author:
Mattias Wallin <mattias.wallin@stericsson.com>
Copyright 2011 Cirrus Logic, Inc.
Copyright (c) 2008 Jaswinder Singh Rajput
Copyright (C) 2010-2012 Matthias Fuchs <matthias.fuchs@esd.eu>, esd gmbh
Copyright (C) 2015 Davidlohr Bueso.
Copyright (C) 2017 Pengutronix, Jan Luebbe <kernel@pengutronix.de>
Copyright © 2017 Keith Packard <keithp@keithp.com>
Copyright (C) 2010, Lars-Peter Clausen <lars@metafoo.de>
Copyright (C) 2005 Kirk Lapray <kirk.lapray@gmail.com>
Copyright (C) 2010 - 2012 Paul Mundt
Copyright (C) 2012 Heiko Stuebner <heiko@sntech.de>
Copyright (C) 2013 Red Hat, Inc., Dave Young <dyoung@redhat.com>
Copyright (C) 2009 Texas Instruments Incorporated. http://www.ti.com/
Copyright (C) 2008 Option International
Copyright (C) 2002, 2003 Ladislav Michl (ladis@linux-mips.org)
Copyright (c) 2015, 2018, The Linux Foundation. All rights reserved.
Copyright (c) 2017 Savoir-faire Linux Inc. Vivien Didelot <vivien.didelot@savoirfairelinux.com>
Copyright (C) 2016 Marvell Ltd.
Copyright (C) 2010 SUSE Products GmbH/Novell Author: Thomas Renninger <trenn@suse.de>
Copyright (C) Miguel Ojeda Sandonis Date: 2006-10-12
Copyright 2017, Gustavo Romero, Breno Leitao, Cyril Bur, IBM Corp.
Copyright (C) 2014 Intel Corporation. All rights reserved.
Copyright (C) 2003-2005 Benjamin Herrenschmidt (benh@kernel.crashing.org)
Copyright(c) 2017-2018 Intel Corporation. All rights reserved.
Copyright (c) 1995-2005 Silicon Graphics, Inc. All Rights Reserved.
Copyright (C) 2012 Malcolm Priestley (tvboxspy@gmail.com) Beta Driver
Copyright (C) 2003 - 2010 Paul Mundt
Copyright (C) 2017 Chris Mi <chrism@mellanox.com>
Copyright 2012 Freescale Semiconductor, Inc.
Copyright: 2003, 2008 Intel Corporation
Copyright (C) 2015 Fujitsu Semiconductor Limited
(C) 2006 Red Hat Inc
Copyright 2000,2001,2002,2004 Dell Inc.
Copyright (c) Alan Smithee.
Copyright (C) 2018 NXP
Copyright 2013-2016 Freescale Semiconductor Inc.
Copyright 2006 SUSE Linux Products GmbH
Copyright (c) 2010 Red Hat, Inc. All Rights Reserved.
Copyright (c) 1999-2007 Tensilica Inc.
Copyright (C) 2014 STMicroelectronics Limited
(C) 2005 Finn Thain;(C) 1996,1998 by Thomas Bogendoerfer (tsbogend@alpha.franken.de);(C) 1995 by Andreas
Busse (andy@waldorf-gmbh.de);(C) 1999 David Huggins-Daines <dhd@debian.org>
Copyright (c) 2007-2013 Nicira, Inc.
Copyright 2008 - 2015 Freescale Semiconductor Inc.
Copyright (C) International Business Machines Corp., 2002,2008 Author(s): Steve French (sfrench@us.ibm.com)
Jeremy Allison (jra@samba.org) 2006.
Copyright (c) 2009 Intel Corp. Author: Huang Ying <ying.huang@intel.com>
Copyright (c) 2008-2009 Jonathan Cameron <jic23@kernel.org>
Copyright (C) 2018-2019 HUAWEI, Inc. http://www.huawei.com/ Created by Gao Xiang <gaoxiang25@huawei.com>
Copyright (c) 2015 Google, Inc
Copyright (c) 2011 - 2014 PLUMgrid, http://plumgrid.com
Copyright (C) 2009 Roberto De Ioris <roberto@unbit.it>
Copyright (C) 2016 Robert Jarzmik
Copyright (C) 2011 STRATO AG written by Arne Jansen <sensille@gmx.net>
Copyright (C) 2008, VMware, Inc.
Copyright 2007-2009 Freescale Semiconductor, Inc.
Copyright (c) 2006 Michal Ludvig <michal@logix.cz>
Copyright 2018, IBM Corporation.
Copyright (C) 2016 Guennadi Liakhovetski (guennadi.liakhovetski@intel.com)
Copyright (C) 2017 Alan Mizrahi, alan at mizrahi dot com dot ve
Copyright (C) 1998-2003 Hewlett-Packard Co David Mosberger-Tang <davidm@hpl.hp.com>
Copyright 2005-2007 Openedhand Ltd.
Copyright 2011 Free Software Foundation, Inc. Contributed by Bernd Schmidt <bernds@codesourcery.com>.
Copyright (c) 2007 University of Aberdeen, Scotland, UK
Copyright (c) 2019 MediaTek Inc. Author: Yong Liang <yong.liang@mediatek.com>
Copyright 1993, 1994: Eric Youngdale (eric@cais.com).
Copyright (C) 2009-2010 Samsung Electronics MyungJoo Ham <myungjoo.ham@samsung.com>
Copyright (C) 2010 Texas Instruments Inc. Author: Erik Gilling <konkers@android.com> Converted to new DSS
device model: Tomi Valkeinen <tomi.valkeinen@ti.com>
Copyright (C) 1994-1996 Scott Snyder <snyder@fnal0.fnal.gov>
Copyright 2012 Maarten Lankhorst
Copyright (C) 2017 Florian Eckert <fe@dev.tdt.de>
Copyright (c) 2018 Dmitry V. Levin <ldv@altlinux.org> All rights reserved.
Copyright (C) 2013-2015 Mentor Graphics Inc.
Copyright (c) 2014 Scott Alfter <scott@alfter.us>
Copyright (C) 2008 David Gibson, IBM Corporation
Copyright (C) 2008 Thomas Gleixner <tglx@linutronix.de>
Copyright (c) 2013-2017, Mellanox Technologies. All rights reserved.
Copyright (C) 2001 IBM. Dave Engebretsen, Peter Bergner, and Mike Corrigan {engebret|bergner|mikec}@us.ibm.
com Plus various changes from other IBM teams...
Copyright (C) 2013, Apelete Seketeli <apelete@seketeli.net>
(c) Copyright 1999 Red Hat Software;(c) Copyright 1999 SuSE GmbH;(c) Copyright 1999,2000 Hewlett-Packard
Company;(c) Copyright 2000 Grant Grundler;(c) Copyright 2006-2019 Helge Deller
Copyright (c) 2014,2016 Qualcomm Atheros, Inc.
Copyright (C) 1995 Linus Torvalds Adapted from 'alpha' version by Gary Thomas Modified by Cort Dougan (cort@
cs.nmt.edu) Modified by PPC64 Team, IBM Corp
Copyright (C) 2018-2019 Linaro Ltd.
Copyright (C) 2012 ROHM CO.,LTD.
Copyright (C) 1995 Uwe Kleine-Koenig <u.kleine-koenig@pengutronix.de> for Pengutronix
Copyright (c) 2016 MediaTek Inc. Author: Andrew-CT Chen <andrew-ct.chen@mediatek.com>
Copyright (C) 2006 Herbert Poetzl adapted from Remy Card's ext2/ioctl.c
Copyright (C) 2004-2009 Dominik Brodowski <linux@dominikbrodowski.net> This file is distributed under the same
license as the cpufrequtils package.
Copyright (C) 2009 Ira W. Snyder <iws@ovro.caltech.edu>
Copyright 2018 Alexander Monakov <amonakov@gmail.com>
Copyright (C) 1995-2000 Simon G. Vogl

LICENCE TERMS (cont.)

Copyright (C) 2009-2011 ST-Ericsson AB Author: Martin Persson <martin.persson@stericsson.com> Author: Linus Walleij <linus.walleij@linaro.org>
(c) Copyright 2000-2004 Grant Grundler <grundler@parisc-linux.org>;(c) Copyright 2004 Naresh Kumar Inna <knaresh@india.hp.com>;(c) Copyright 2000-2004 Hewlett-Packard Company;(c) 1999 Dave S. Miller (from sparc64 I/O MMU code)
Copyright (C) 2004 - 2009 Ivo van Doorn <ivdoorn@gmail.com>
Copyright (C) 2013 Freescale Semiconductor, Inc.
Copyright (C) 2013, Intel Corporation Author: Mika Westerberg <mika.westerberg@linux.intel.com>
Copyright (C) 2001, 2006 Tensilica Inc.
Copyright (c) 2002-2004, K A Fraser
Copyright (C) 1996, 1997, 1998, 2001 by Ralf Baechle
Copyright (c) 2014 Marek Szymanski <m.szymanski@samsung.com>
Copyright (c) 2015 Patrick McHardy <kaber@trash.net>
(c) 2004, Dave Jones, Red Hat Inc. v2.
Copyright (c) 2014 Cirrus Logic Inc.
Copyright (C) 2010, Lars-Peter Clausen <lars@metafoo.de> JZ4740 SoC prom code
Copyright (C) 2006-2009 Freescale Semiconductor, Inc. All rights reserved.
Copyright (C) 2008 Igor M. Liplianin <liplianin@me.by>
Copyright (C) 2000-2001 Toshiba Corporation
Copyright(c) 2003 - 2004 Intel Corporation. All rights reserved.
Copyright (c) 2009-2017, The Linux Foundation. All rights reserved.
Copyright (c) 2015 Qualcomm Atheros, Inc.
Copyright (c) 2005 Andrea Merello <andrea.merello@gmail.com>
Copyright 2007 Robert Schwebel <r.schwebel@pengutronix.de>, Pengutronix
Copyright (C) 2000 Anton Blanchard (anton@samba.org)
(c) 2008 Manuel Lauss <mano@roarinelk.homelinux.net>
Copyright IBM Corp. 1999,2013
Copyright (C) 2005 - 2010 Paul Mundt
Copyright (C) 2000 - 2003 Jeff Dike (jdike@addtoit.com)
Copyright (C) 2009 Lemote Inc. Author: Wu Zhangjin, wuzhangjin@gmail.com Xiang Yu, xiangy@lemote.com Chen Huacai, chenhc@lemote.com
Copyright (C) 2013 Red Hat, Inc., Frederic Weisbecker <fweisbec@redhat.com>
Copyright (c) 2013-2019, Intel Corporation. All rights reserved. Intel Management Engine Interface (Intel MEI) Linux driver
Copyright (C) 2016 - ARM Ltd
Copyright (c) Takashi Iwai <tiwai@suse.de>
Copyright (C) 2016 Renesas Electronics Corporation.
Copyright (C) 2014 Golden Delicious Computers Author: H. Nikolaus Schaller <hns@goldelico.com>
Copyright (c) 2014-2015, NVIDIA CORPORATION. All rights reserved.
Copyright (C) 2004 Olof Johansson <olof@lixom.net>, IBM Corporation
Copyright (C) 2010 Faraday Technology Corp.
Copyright (c) 2011 Mauro Carvalho Chehab
Copyright (C) 2004,2008 Laurent Vivier <Laurent@lvivier.info>;(c) Paul Mackerras, 1996;(c) 1997, 1998 Hauke Fath.
Copyright © 2013 Tony Breeds IBM Corporation
Copyright (C) 2019 Linaro Ltd Author: Georgi Djakov <georgi.djakov@linaro.org>
Copyright (C) 2018 NVIDIA Corporation. All rights reserved. Author: Ajay Gupta <ajayg@nvidia.com>
(C) 2017 Red Hat GmbH Author: Florian Westphal <fw@strln.de>;(c) 2000 Gerd Knorr <kraxel@bytesex.org> Nov 2002: Martin Bene <martin.bene@icomedia.com>: only ignore TIME_WAIT or gone connections;(C) CC Computer Consultants GmbH, 2007
Copyright (C) 2008 Alex Osborne <ato@meshy.org>
Copyright IBM Corp. 2007
Copyright (C) Freescale Semiconductor, Inc. 2007, 2008.
Copyright (C) 2017 Thomas Gleixner <tglx@linutronix.de>
Copyright (C) 2008 Renesas Solutions Corp. Kuninori Morimoto <morimoto.kuninori@renesas.com>
(C) Copyright David Gibson, IBM Corporation 2001-2003.
Copyright (c) 1997 Dan Malek <dmalek@jlc.net>
Copyright (C) 2016 MEN Mikroelektronik GmbH (www.men.de)

Copyright (C) 2015 Yoshinori Sato
(C) Copyright 1999 Roman Weissgaerber <weissg@vienna.at>;(C) Copyright 2000-2005 David Brownell;(C)
Copyright 2002 Hewlett-Packard Company;(C) Copyright 2008 Magnus Damm
(C) using AArch64 CRC instructions
Copyright 2008 Sascha Hauer, kernel@pengutronix.de
Copyright (C) 2002 Intersil Americas Inc.;(C) 2003,2004 Aurelien Alleaume <slts@free.fr>;(C) 2003 Herbert Valerio Riedel <hvr@gnu.org>;(C) 2003 Luis R. Rodriguez <mcgrof@rslug.rutgers.edu>
Copyright (C) 2012 Nobuhiro Iwamatsu <nobuhiro.iwamatsu.yj@renesas.com>
Copyright (C) 2015 Intel Corp Author: Sanjiv Kumar <sanjiv.kumar@intel.com>
Copyright 2016 Realtek Microelectronics
Copyright (c) 2000-2006, Ericsson AB
Copyright (c) 2013 Nikolay Aleksandrov <nikolay@redhat.com>
Copyright (C) 2002 Mark D. Studebaker <mdsxyz123@yahoo.com>
Copyright (C) 2010-2011 Intel Corporation Author: Yin Kangkai (kangkai.yin@intel.com)
Copyright 2011-2 Wolfson Microelectronics PLC.
Copyright (c) 2007, Intel Corporation.
Copyright (C) 2009 Rodolfo Giometti <giometti@linux.it>
Copyright (C) 1999, 2000 by Silicon Graphics
Copyright (C) 2001, Alcatel
Copyright (c) 2003 Matt T. Yourst <yourst@yourst.com>
Copyright (C) Collabora, Ltd.
Copyright (C) 1995-1997, Olaf Kirch <okir@monad.swb.de>
Copyright (C) 2018 Theobroma Systems Design und Consulting GmbH
Copyright(c) 2016 Google Inc. All rights reserved.
Copyright (C) 2018 Ayman Bagabas <ayman.bagabas@gmail.com>
Copyright (c) 1999 by Jaroslav Kysela <perex@perex.cz> Uros Bizjak <uros@kss-loka.si>
Copyright (C) 2009 - 2011 Paul Mundt
(c) Copyright 2008, RealTEK Technologies Inc. All Rights Reserved.
Copyright (C) 2016 Collabora Ltd
Copyright 2011-2013 Texas Instruments Inc.
Copyright (C) 2015 Zodiac Inflight Innovations
Copyright (C) 2004-2006 maintech GmbH, Thomas Kleffel <tk@maintech.de>
Copyright (C) 1998-2001, 2003 Hewlett-Packard Co David Mosberger-Tang <davidm@hpl.hp.com>
(c) Rebel.com, 1998-1999
Copyright (C) 2011 Sylwester Nawrocki <s.nawrocki@samsung.com>
Copyright 10/16/2005 Tilman Kranz <tilde@tk-sls.de>
Copyright 2009 Christian Pellegrin EVOL S.r.l.
Copyright 2011 Jonathan Corbet <corbet@lwn.net>
Copyright (C) 2011 Marvell International Ltd. All rights reserved. Author: Chao Xie <chao.xie@marvell.com> Neil Zhang <zhangwm@marvell.com>
Copyright (C) 2013, 2014 Red Hat, Inc. Author: Mark Salter <msalter@redhat.com>
Copyright (C) 1994 by Waldorf Electronics
Copyright (C) 2010-2011 Christopher Yeoh <cyeh@au1.ibm.com>, IBM Corp.
Copyright (C) IBM Corporation, 2011 Derived from copyuser_power7.s by Anton Blanchard <anton@au.ibm.com>
Author - Balbir Singh <bsingharora@gmail.com>
Copyright 2015-2016 Collabora Ltd.
Copyright (c) 2011 Ondrej Zary;(c) 2000-2002 Ziglio Frediano, freddy77@angelfire.com but almost nothing remained here after conversion to generic TEA575x implementation
Copyright (c) 2014 Andy Lutomirski
Copyright (C) 2015 Lukas Wunner <lukas@wunner.de>
Copyright (C) 2015 Intel Corp. Author: Chen, Gong <gong.chen@linux.intel.com>
Copyright 2016 Realtek Semiconductor Corp. Author: Jack Yu <jack.yu@realtek.com>
Copyright (c) 2017 Samsung Electronics Co., Ltd.
Copyright © 1999 Machine Vision Holdings, Inc.
Copyright (C) 2010 Intel Corp Author: Vinod Koul <vinod.koul@intel.com> Author: Harsha Priya <priya.harsha@intel.com>
Copyright (c) 2006-2007 Ondrej Zajicek <santiago@crfreenet.org>

LICENCE TERMS (cont.)

Copyright (C) 2005-2006 Kristian Hoegsberg <krh@bitplanet.net>
Copyright 2015 Google Chromium project. Author: Anatol Pomozov <anatol@chromium.org>
Copyright (C) 2019 Hangzhou C-SKY Microsystems co.,ltd. Mapping of DWARF debug register numbers into register names.
(C) 2000 -- This code is GPL.:(C) 2006-2012
Copyright (c) 2008 Intel Corporation
Copyright (C) 2010 Nathan Fontenot
Copyright IBM Corp. 2014, 2018 Author(s): Alexander Yarygin <yarygin@linux.vnet.ibm.com> Thomas Richter <tmricht@linux.vnet.ibm.com>
Copyright 2017 Benjamin Herrenschmidt, IBM Corporation.
Copyright (c) 2018 Andrew Lutomirski
Copyright 2001, Rik van Riel <riel@conectiva.com.br>
Copyright (c) 2016 Qualcomm Atheros, Inc
(C) 2001 Martin Josefsson <gandalf@wlug.westbo.se>
(C) 1996 Peter Braam;(C) 1997 Carnegie Mellon University
Copyright (C) 1998 Harald Koerfgen and Paul M. Antoine
Copyright 2003-2009,2014-2015 Red Hat, Inc.
Copyright (C) 2011, Nuvoton Technology Corporation. Dan Morav <dan.morav@nuvoton.com>
Copyright 2015 Priit Laes
Copyright (C) 2013-2015 Freescale Semiconductor, Inc. All Rights Reserved.
(C) 1999-2001 Paul 'Rusty' Russell;(C) 2002-2006 Netfilter Core Team <coreteam@netfilter.org>
Copyright (C) 1992 David Gillier
Copyright (C) 2000 by Andreas Gruenbacher <a.gruenbacher@computer.org>
Copyright: [copy] 2004 Intel Corporation
Copyright (c) 2008 Philipp Zabel
Copyright (C) 2003, 2004 IBM Corporation
Copyright (C) 2008-2011 Advanced Micro Devices Inc. 2013-2018 Borislav Petkov <bp@alien8.de>
Copyright 2005-2006 PMC-Sierra, Inc, derived from irq_cpu.c Author: Andrew Hughes, Andrew_Hughes@pmc-sierra.com
Copyright (c) 2018 Oleg Ivanov <balbes-150@yandex.ru>
Copyright (C) 2015 Linaro, Ltd Author: Andy Green <andy.green@linaro.org>
Copyright (C) 2015, Samsung Electronics, Co., Ltd. Andrzej Hajda <a.hajda@samsung.com>
Copyright 2006-2008 Johannes Berg <johannes@sipsolutions.net>
(c) belongs to Dan Malek.:(c) Dan Malek <dan@embeddedalley.com>;(c) MontaVista Software, Inc.
Copyright (C) 2006-07 Tower Technologies
Copyright (C) 2016 Marek Vasut <marex@denx.de>
Copyright: (C) 2015 Texas Instruments, Inc.
Copyright (c) 2001 Dan Malek <dan@embeddedalley.com>
(c) Copyright 2005 Jose Goncalves <jose.goncalves@inov.pt>
Copyright (C) 1992 Tommy Thorn and Modified by Eric Youngdale
Copyright 2013 Greg Ungerer <gerg@uclinux.org>
(c) Copyright 1999,2000 Hewlett-Packard Company
Copyright (c) 2004 Jon Smirl <jonsmirl@gmail.com>
Copyright Altera Corporation (C) <2015>. All rights reserved
Copyright 2008-2009 Freescale Semiconductor, Inc. All Rights Reserved.
Copyright (C) 2012-2020 IBM Corporation
Copyright (C) 2013 Xsens <info@xsens.com>
Copyright (C) 2006-2009 Renesas Solutions Corp.
(C) 2011 Thomas Renninger <trenn@suse.de>, Novell Inc.
Copyright (C) 2005 Georg Acher, BayCom GmbH (acher at baycom dot de)
Copyright (C) 2009, Sascha Hauer <s.hauer@pengutronix.de>
(C) Copyright IBM Corp. 2005
Copyright 2007 Benjamin Herrenschmidt, IBM Corp.
Copyright (C) 2004 Patrick Mochel 2005 Rudolf Marek <r.marek@assembler.cz>
Copyright (C) 2018 Linaro, Ltd. <ard.biesheuvel@linaro.org>
Copyright (C) 2002-2004 Yoichi Yuasa <yuasa@linux-mips.org>
Copyright 2011 Advanced Micro Devices, Inc. All Rights Reserved.

Copyright (c) 2004 Simtec Electronics <http://armlinux.simtec.co.uk/> Written by Ben Dooks, <ben@simtec.co.uk>
Copyright(c) 2007 Yuri Tikhonov <yur@emcraft.com>
Copyright 2001, 2002 - Jani Monoses <jani@iv.ro>
Copyright 2011 IBM Corporation.
Copyright (C) Kirill A. Shutemov <kirill@shutemov.name>
Copyright IBM Corp. 2002, 2008 Author(s): Cornelia Huck (cornelia.huck@de.ibm.com) Martin Schwidefsky (schwidefsky@de.ibm.com)
Copyright (C) 2013 Atmel, 2016 Andras Szemzo <szemzo.andras@gmail.com>
Copyright (C) 1998, 1999, 2003 Ralf Baechle
Copyright (C) 2017 Lucas Bates <lucasb@mojatatu.com>
Copyright 2014 Markus Pargmann <mpa@pengutronix.de>, Pengutronix
Copyright (C) 2008 Greg Kroah-Hartman <greg@kroah.com>
Copyright (c) 2017 Linaro Ltd.
Copyright 2017,2018 NXP
Copyright (C) 2008-2009 Manuel Lauss <manuel.lauss@gmail.com>
Copyright (C) 2007 Intel Corp Bibo Mao <bibo.mao@intel.com> Huang Ying <ying.huang@intel.com>
Copyright (c) 2011 QLogic Corporation
Copyright (c) 2009 Daniel Ribeiro <drwrym@gmail.com>
(C) Copyright Linaro 2013
Copyright 2007 Steven Brown <sbrown@cortland.com>
Copyright (C) 2007-2010 Texas Instruments, Inc.
(c) 1995 Michael Neuffer neuffer@goofy.zdv.uni-mainz.de
Copyright (C) 2001, 2002, 2003, 2007, 2008 David S. Miller (davem@davemloft.net)
Copyright (C) 2004 Nokia Corporation
Copyright (C) 2012 Wolfram Sang, Pengutronix <kernel@pengutronix.de>
Copyright (C) 2009 Intel Corporation. All rights reserved.
Copyright (C) 2012 - 2017 Rafał Miłecki <rafal@milecki.pl>
Copyright(C) 2010 Red Hat.
Copyright (C) Linaro Ltd 2019 - All Rights Reserved Author: Manivannan Sadhasivam <manivannan.sadhasivam@linaro.org>
Copyright (c) 2000-2001 Vojtech Pavlik <vojtech@ucw.cz>
Copyright (C) 2002 RidgeRun, Inc. Author: Steve Johnson
Copyright (C) 2005 Faraday Corp.
Copyright (C) 2009 Bill Liu <Bill.Liu@Conexant.com>
Copyright 2007 Simtec Electronics
Copyright 2014-2015 Freescale Semiconductor, Inc.
Copyright 1993 -- 1997 Drew Eckhardt, Frederic Potter, David Mosberger-Tang
Copyright (c) 2008,2009 Ilya Petrov <ilya.muromec@gmail.com>
(C) 2010 Eric Dumazet
Copyright (C) 2018-2019 Renesas Electronics Corp.
Copyright (2016) Chen-Yu Tsai
Copyright (C) 2005 Antonino Daplas <adaplas @pol.net>
Copyright (C) 2007 Krzysztof Helt <krzysztof.h1@wp.pl>
Copyright (C) 2000 Takashi Iwai <tiwai@suse.de>
(C) Copyright 1999 Roman Weissgaerber <weissg@vienna.at>;(C) Copyright 2000-2004 David Brownell <dbrownell@users.sourceforge.net>;(C) Copyright 1999 Linus Torvalds J;(C) Copyright 1999 Gregory P. Smith
Copyright 2016 Google Inc.
Copyright 2003, 2008 MontaVista Software Inc. Author: MontaVista Software, Inc. <source@mvista.com>
(C) 2007 Pavel Emelyanov <xemul@openvz.org>, OpenVZ, SWsoft Inc.:(C) 2007 Sukadev Bhattiprolu <sukadev@us.ibm.com>, IBM Many thanks to Oleg Nesterov for comments and help
Copyright (C) 2009 Bluewater Systems Ltd
Copyright (C) 2014 Intel Corporation.
Copyright 2011 Analog Devices Inc. Author: Yi Li <yi.li@analog.com> Author: Lars-Peter Clausen <lars@metafoo.de>
Copyright (c) 2009-2013, NVIDIA Corporation. All rights reserved.
Copyright (C) 2009-2012 Cavium, Inc
Copyright 2012 Creative Product Design Marc Reilly <marc@cpdesign.com.au>

LICENCE TERMS (cont.)

Copyright(c) 2015, Intel Corporation.
Copyright (C) 2016 Tomasz Chilinski <tomasz.chilinski@chilan.com>
Copyright (c) Clemens Ladisch <clemens@ladisch.de>
Copyright (C) 2007-2009 Motorola, Inc.
Copyright IBM Corp. 2004 Author(s): Martin Schwidefsky (schwidefsky@de.ibm.com)
(c) 1999 Martin Mares <mj@ucw.cz>
Copyright 2011 Freescale Semiconductor, Inc.
Copyright (C) 2015, Intel Corporation. All rights reserved.
Copyright 2011 Advanced Micro Devices, Inc.
Copyright (C) 1994, 1995, 1996, 1999, 2000, 2001, 2002, 2004, 2005, 2006, 2007 Free Software Foundation, Inc.
Copyright (C) 2004 Dmitry Yusupov
Copyright (C) 2015 Atmel Corporation, Nicolas Ferre <nicolas.ferre@atmel.com>
Copyright (c) 2006 Cisco Systems, Inc. All rights reserved.
Copyright (C) 2000 - 2001 by Kanoj Sarcar (kanoj@sgi.com)
Copyright (C) 2004 Jens Axboe <axboe@kernel.dk>
Copyright(c) 2014 Intel Mobile Communications GmbH
Copyright (C) 2017 Pengutronix, Juergen Borleis <kernel@pengutronix.de>
Copyright (c) 2010 Google, Inc
Copyright (c) 2011, 2012, Atheros Communications Inc.
Copyright (c) 2009 Tias Guns;(c) Vojtech Pavlik and Dan Streetman and Richard Lemon
Copyright (C) 2008 THE cpufrequtils'S COPYRIGHT HOLDER . Claudio Eduardo <claudioeddy@gmail.com>, 2009.
Copyright 2017 NXP Authors: Peter Chen <peter.chen@nxp.com>
Copyright (C) 2017-2019 Linaro Ltd <ard.biesheuvel@linaro.org>
(C) Copyright 2005 Tundra Semiconductor Corp. Alex Bounine, <alexandreb@tundra.com).
Copyright (c) 2016 Paolo Abeni <pabeni@redhat.com>
Copyright 2011 The Chromium Authors, All Rights Reserved.
Copyright 2008 Freescale Semiconductor, Inc.
Copyright (C) 2014, Intel Corporation Authors: Zhang Rui <rui.zhang@intel.com>
"Copyright: (C) 2016 Linaro Limited Created by: Nicolas Pitre, January 2016"
Copyright (C) 2001, 2002 Andreas Dilger <adilger@clusterfs.com>
Copyright (C) 2018 Advanced Micro Devices, Inc. Authors: Christian König <christian.koenig@amd.com>
Copyright (c) 2011 Konrad Rzeszutek Wilk <konrad.wilk@oracle.com>
Copyright (C) 2012 Russell King
Copyright IBM Corp. 1999, 2017
Copyright 2002 by Kai Germaschewski
Copyright (c) 2012, Microsoft Corporation.
(C) 2001 - 2005 Tensilica Inc.
Copyright (c) 2010-2012 Stephane Chatty <chatty@enac.fr>
Copyright (C) 2011 Atmel
Copyright 2007-2008 Wolfson Microelectronics
Copyright © 2018 VMware, Inc., Palo Alto, CA., USA All Rights Reserved.
Copyright (c) 2017 Mentor Graphics Inc.
Copyright (c) 2016-2017 HiSilicon Technologies Co., Ltd.
Copyright (C) 2007-2008 Carlos Corbacho <carlos@strangeworlds.co.uk>
Copyright (C) 2012-2018 ARM Limited
Copyright (C) 2014 Intel Corp Author: Subhransu S. Prusty <subhransu.s.prusty@intel.com> Mengdong Lin <mengdong.lin@intel.com>
Copyright (C) 2008-2010 Michael Hennerich, Analog Devices Inc.
Copyright 2003 Wichert Akkerman <wichert@wiggy.net>
Copyright (C) 2010 "Wu Zhangjin" <wuzhangjin@gmail.com>
Copyright 2016 Pengutronix, <kernel@pengutronix.de>
Copyright 2010-2011 Freescale Semiconductor, Inc. All Rights Reserved.
Copyright (C) 2014-2015 Hans de Goede <hdegoede@redhat.com>
Copyright (C) 2015-2018 Author: Matt Ranostay <matt.ranostay@konsulko.com>
Copyright (C) 2002 - 2003 Dominik Brodowski
Copyright (C) 2010 OMICRON electronics GmbH
Copyright (C) 2015 Xilinx, Inc. CEVA AHCI SATA platform driver

Copyright (C) 2014 Advanced Micro Devices, Inc. Authors: Suravee Suthikulpanit <suravee.suthikulpanit@amd.com> Harish Kasiviswanathan <harish.kasiviswanathan@amd.com> Brandon Anderson <brandon.anderson@amd.com>
Copyright 2002 MontaVista Software Inc.
Copyright (C) ST-Ericsson SA 2012
Copyright (c) 2016 Jonathan McDowell <noodles@earth.li>
Copyright 2004-2008 Freescale Semiconductor, Inc.
Copyright (c) 2003, Dr Brian Gladman, Worcester, UK.
Copyright (C) 2013-2014 Savoir-faire Linux Inc. Vivien Didelot <vivien.didelot@savoirfairelinux.com>
Copyright (C) 2015 William Breathitt Gray
Copyright (c) 1998-2007 Texas Instruments Incorporated
Copyright 2005, 2007 Simtec Electronics http://armlinux.simtec.co.uk/ Ben Dooks <ben@simtec.co.uk>
Copyright (C) 2004 Andriy Skulysch
Copyright (c) 2010-2011,2013 The Linux Foundation. All rights reserved.
Copyright (C) 2010 Michael Krufky <mkrufky@linuxtv.org>
Copyright © 2009 - Maxim Levitsky SmartMedia/xD translation layer;© 2005 Eptar srl Author: Claudio Lanconelli <lanconelli.claudio@eptar.com>
Copyright (c) 2010 Samsung Electronics Co., Ltd. http://www.samsung.com/
Copyright (c) 2016 Baolin Wang <baolin.wang@linaro.org>
Copyright 1993-2003 NVIDIA, Corporation. All rights reserved. *)
Copyright (C) 2010-2012 Samsung Electronics Co., Ltd. Sylwester Nawrocki <s.nawrocki@samsung.com>
Copyright (C) 2017 - 2018 Intel Corporation
Copyright (C) 2000 Tilmann Bitterberg tilmann@bitterberg.de)
Copyright (C) 2005-2010 Texas Instruments, Inc.
Copyright 2011-2013 Solarflare Communications Inc.
Copyright (C) 2014 IBM
Copyright (C) 2000 Imagination Technologies Ltd
Copyright 2012 Marvell International Ltd.
Copyright IBM Corporation 2007
Copyright 2019 Arm Limited Authors: Mark Rutland <mark.rutland@arm.com> Amit Daniel Kachhap <amit.kachhap@arm.com>
Copyright (C) 2011 Samsung Electronics Co., Ltd.
Copyright (C) 1998 Jon Howell
Copyright (C) 2015 Toby Churchill - http://www.toby-churchill.com/
Copyright (c) 2008-2014 Patrick McHardy <kaber@trash.net>
Copyright (C) 2018 Pengutronix, Marco Felsch <kernel@pengutronix.de>
Copyright (C) STMicroelectronics 2018 Author: Christophe Kerello <christophe.kerello@st.com>
(C) Copyright IBM Corp. 2001, 2004
Copyright (c) 1996-2001 Jonathan A. Buzzard (jonathan@buzzard.org.uk)
Copyright (c) 2013 Simon Wood
COPYRIGHT (C) 2014-2015 VMware, Inc., Palo Alto, CA., USA
Copyright (C) 2002 Yoshinori Sato
Copyright (C) 2007 Korea Information Security Agency (KISA).
Copyright (C) 2019 Jens Axboe
Copyright (C) 2019 IBM Corp.
Copyright (C) Daniel Lezcano <daniel.lezcano@linaro.org>
Copyright (C) 2018 Texas Instruments Incorporated - http://www.ti.com
Copyright (C) 2004 Interface Co.,Ltd. Saito.K
Copyright (c) 2006 Trond Myklebust <Trond.Myklebust@netapp.com>
Copyright (c) 2014, Lorenzo Bianconi <lorenzo.bianconi83@gmail.com>
Copyright 2018 Boundary Devices
Copyright (c) 2010 Don Prince <dhprince.devel@yahoo.co.uk>
Copyright (C) 2010 Texas Instruments Incorporated - http://www.ti.com/
Copyright (C) 2010 secunet Security Networks AG
(C) 2000 Red Hat. GPL'd
Copyright (C) 2005 Duncan Sands, Roman Kagan
Copyright 2008 Simtec Electronics Ben Dooks <ben@simtec.co.uk>

LICENCE TERMS (cont.)

Copyright (C) 2016 Advanced Micro Devices, Inc. All Rights Reserved.
Copyright (C) 2010 Alexander Graf (agraf@suse.de)
Copyright (C) 2012, Intel Corporation Authors: Mika Westerberg <mika.westerberg@linux.intel.com> Mathias Nyman <mathias.nyman@linux.intel.com> Rafael J. Wysocki <rafael.j.wysocki@intel.com>
Copyright (C) 2013-2015 Eric Dumazet <edumazet@google.com>
Copyright (C) 2019 Pawel Chmiel <pawel.mikolaj.chmiel@gmail.com>
Copyright (C) 2009 Jean-Francois Moine <http://moinejf.free.fr>
Copyright: (C) 2006-2009 Instrumentation Technologies
Copyright (C) 2012 Texas Instruments
Copyright (C) 2001 ARM Limited, by David A Rusling Updated to 2.5, Deep Blue Solutions Ltd.
Copyright (C) IBM Corporation, 2006
Copyright (C) 2003-2004 Kevin Thayer <nufan_wfk at yahoo.com>
Copyright (C) 1995, 96, 98, 99, 2000 by Ralf Baechle
Copyright (C) 2000-2003 Deep Blue Solutions Ltd.
Copyright (C) 2011 Red Hat, Inc., Frederic Weisbecker <fweisbec@redhat.com>
Copyright (c) 2012-2014 Samsung Electronics Co., Ltd http://www.samsung.com
Copyright (C) 2017 bjb@mojatatu.com
Copyright (c) 2016, Facebook
Copyright (c) 2018 Broadcom. All Rights Reserved.
Copyright (C) 2010 Ian Munsie, IBM Corporation.
Copyright (C) 2001 Sistina Software (UK) Limited.
Copyright (C) 2008, 2009 Renesas Solutions Corp.
Copyright (C) 2015, Intel Corporation. Author: Subhransu S. Prusty <subhransu.s.prusty@intel.com>
Copyright (C) 2014, Jiri Olsa <jolsa@redhat.com>
Copyright Altera Corporation (C) 2015. All rights reserved.
Copyright (c) 2014 JD Cole <jd.cole@plantronics.com>
Copyright (C) 2003 Richard Cumow
(c) 2006 Andrew de Quincey
Copyright (C) 2005-2006 Dell Inc.
Copyright (C) 2008 Christian Lamparter <chunkey@web.de>
Copyright (C) 2001 Niibe Yutaka & Kaz Kojima
Copyright (C) 1999-2000 Russell King
Copyright (C) 2007-2011 STMicroelectronics Ltd
Copyright: (C) 2017 Julia Lawall, Inria/LIP6, URL: <http://coccinelle.lip6.fr/> Requires: 1.0.7 Keywords: BQ27XXX_DATA
Copyright (C) 2014 Texas Instruments, Inc. - <http://www.ti.com> Roger Quadros <rogerq@ti.com>
Copyright Intel Corp. 2018 *
Copyright 2010 ARM Ltd.
Copyright (C) 2008 Nokia Corporation
Copyright (C) 2005 Dmitry Torokhov
Copyright 2008 DENX Software Engineering
Copyright (C) 2017-2018 Digital Devices GmbH Ralph Metzler <rjkm@metzlerbros.de> Marcus Metzler <mocm@metzlerbros.de>
Copyright (c) Harald Geyer <harald@ccbib.org>
Copyright (C) 2016 Linaro Ltd.
Copyright 2012 Actions Semi Inc. Author: Actions Semi, Inc.
Copyright (c) 2016 Martin Kepplinger <martink@posteo.de>
Copyright 2015 Akamai Technologies Inc. All Rights Reserved
Copyright 2005, Broadcom Corporation
Copyright (c) 2016 Martin Blumenstingl <martin.blumenstingl@googlemail.com>.
Copyright (c) International Business Machines Corp., 2000,2009 Modified by Steve French (sfrench@us.ibm.com)
Copyright (c) 1999-2000 Cisco, Inc.
Copyright IBM Corp. 2006 Author(s): Michael Holzheu <holzheu@de.ibm.com>
Copyright (C) 2009 Texas Instruments, Inc. Thara Gopinath <thara@ti.com>
Copyright (C) 2001 - 2005 Tensilica, Inc.
Copyright (c) 2000-2006, 2012-2016, Ericsson AB
Copyright (C) 2010, 2011, 2012, Lemote, Inc. Author: Chen Huacai, chenhc@lemote.com

(C) Copyright IBM Deutschland Entwicklung GmbH 2005;(C) Copyright 2006-2007, IBM Corporation
Copyright 2016 by Frank Rowand
Copyright (c) 2005 IBM Corporation Joachim Fenkes <fenkes@de.ibm.com> Heiko J Schick <schickhj@de.ibm.com>
(C) Copyright 2010-2013 Datera, Inc.:(C) Copyright 2010-2012 IBM Corp.
(c) Neuros Technology, LLC.:(c) Jorge Luis Zapata Muga <jorgeluis.zapata@gmail.com>;(c) Andrey A. Porodko <Andrey.Porodko@gmail.com>
Copyright (c) 2015-2016, Linaro Limited All rights reserved.
Copyright (C) 1996 Paul Mackerras with considerable contributions from Ben Herrens Schmidt and others.
Copyright 10/16/2005 Tilman Kranz <tilde@tk-sls.de> Creative Audio MIDI, for the CA0106 Driver Version: 0.0.1
Copyright (c) 2000-2006, 2014-2018, Ericsson AB
Copyright (c) 2010 by Pavel Osnova <pvosnova@gmail.com>
Copyright (C) 1995, 1996 Olaf Kirch, <okir@monad.swb.de>
Copyright (C) 2013 by Adfin Solutions, Inc. All Rights Reserved. Written by Milosz Tanski (milosz@adfin.com)
Copyright IBM Corp. 2009,2014
Copyright (C) 2017-2019 NXP
Copyright (C) 1996 Adrian Rodriguez (adrian@franklins-tower.rutgers.edu)
Copyright (c) 2011-2014, Intel Corporation Authors: Fenghua Yu <fenghua.yu@intel.com>, H. Peter Anvin <hpa@linux.intel.com>
Copyright 2012 ST Ericsson.
(C) COPYRIGHT 2013-2016 ARM Limited. All rights reserved.
"Copyright: (C) 2017 Conexant Systems, Inc. Author: Simon Ho, <Simon.ho@conexant.com>"
Copyright (C) 2017 Pengutronix, Juergen Borleis <jbe@pengutronix.de>
(C) 2007 Linux Networx (<http://lnxi.com>)
Copyright (C) 2002 Maxim Yevtyushkin <max@linuxmedialabs.com>
Copyright (c) 2018 Juergen Gross
Copyright (c) 2015 Armadeus Systems
Copyright (C) 2018,2019 Lubomir Rintel <lkundrak@v3.sk>
Copyright (c) 2011, Code Aurora Forum. All rights reserved.
Copyright (C) 1996-2000 Russell King;(c) 2000 Russell King v1.07
Copyright (C) 2015 Hauke Mehrtens <hauke@hauke-m.de>
Copyright (C) 2007, Miguel Gaio <miguel.gao@efixo.com>
(C) Copyright 2012, Steven King <sfking@fdwdc.com>;(C) Copyright 2002, Greg Ungerer (gerg@snapgear.com)
Copyright (C) 2014 Texas Instruments, Inc. Author: Sajesh Kumar Saran <sajesh@ti.com> Grygorii Strashko <grygorii.strashko@ti.com>
Copyright (C) 2006 Jack Lee
Copyright (C) 2013-2015 Renesas Electronics Corporation
Copyright IBM Corp. 2017 Author(s): Hendrik Brueckner <brueckner@linux.vnet.ibm.com> Changed by: Ravi Bangoria <ravi.bangoria@linux.vnet.ibm.com>
Copyright (C) 1999 Eric Youngdale
(C) 2011 MyungJoo Ham <myungjoo.ham@samsung.com>, GPL
Copyright (C) 1999-2002 Russell King.
Copyright (C) 2017-2018 Socionext Inc. Author: Masahiro Yamada <yamada.masahiro@socionext.com>
Copyright (C) 2014-2017 Texas Instruments Incorporated - <http://www.ti.com/> Jyri Sarha <jsarha@ti.com>
Copyright: (C) 2007 MontaVista Software, Inc., <source@mvista.com>;(c) 2016 Petr Kulhavy, Barix AG <petr@barix.com> based on davinci-mcasp.c DT support
Copyright (C) 2015 Benjamin Cama <benoar@dolka.fr>
Copyright (C) 2019 Texas Instruments Author: Bartosz Golaszewski <bgolaszewski@baylibre.com>
Copyright 2012 Stefan Roese <sr@denx.de>
(c) Copyright 1996 Alan Cox <alan@redhat.com>, All Rights Reserved. <http://www.redhat.com/>;(c) Copyright 1995 Alan Cox <alan@lxorguk.ukuu.org.uk>
Copyright (c) 2017 Red Hat, Inc. -- Jiri Benc <jbenc@redhat.com>
Copyright (C) 2011,2012 Nobuhiro Iwamatsu <nobuhiro.iwamatsu.yj@renesas.com>
Copyright (C) 2017 Cumulus Networks
Copyright (C) 2013 Atmel Corporation Bo Shen <voice.shen@atmel.com>
Copyright 1998-2000 SysKonnect,
Copyright (c) 2016, Applied Micro Circuits Corporation Authors: Khuong Dinh <kdinh@apm.com> Tanmay Inamdar

LICENCE TERMS (cont.)

<tinamdar@apm.com> lyappan Subramanian <isubramanian@apm.com>
Copyright (C) 2014 Synopsys, Inc. (www.synopsys.com)
Copyright (C) 2016, Hisilicon Ltd.
Copyright (c) 1998 Corey Thomas (corey@world.std.com)
Copyright (C) 2001 Matthew Wilcox <matthew@wil.cx>
Copyright (C) 2015 ARM Ltd. Punit Agrawal <punit.agrawal@arm.com>
Copyright (C) 2016 Icenowy Zheng Icenowy Zheng <icenowy@aosc.xyz>
Copyright (C) 2000 Silicon Graphics, Inc.
Copyright (c) 2005 Petr Stehlik of ARAnyM dev team
Copyright (C) 2014-2016 Maxime Ripard <maxime.ripard@free-electrons.com>
Copyright (C) 2006-2007, Advanced Micro Devices, Inc.
(C) 2003 Jozsef Kadlecsek <kadlec@netfilter.org>;(C) CC Computer Consultants GmbH, 2008
Copyright 2017 Ben Whitten <ben.whitten@gmail.com>
Copyright (C) 2001 MontaVista Software, Inc.
Copyright (c) 2013-2014, 2016-2018 The Linux Foundation. All rights reserved.
Copyright (C) 2016, Intel Corporation Authors: Aaron Lu <aaron.lu@intel.com>
Copyright (C) 2007 Texas Instruments, Inc.
Copyright (C) 2000, David Gibson, Linuxcare Australia.
Copyright (C) 2006-2008 Marvell International Ltd.
Copyright 2011 CompuLab, Ltd.
Copyright (c) Red Hat <mjg@redhat.com>
Copyright (C) 2002 Pavel Machek <pavel@ucw.cz>
Copyright (c) 1999-2002 Merlin Hughes <merlin@merlin.org>
(C) Copyright 2013, Jonas Jensen <jonas.jensen@gmail.com>
Copyright (c) 2001 Arndt Schoenewald
Copyright (c) 2014, Applied Micro Circuits Corporation Author: Rameshwar Prasad Sahu <rsahu@apm.com>
Shamal Winchurkar <swinchurkar@apm.com> Feng Kan <fkan@apm.com>
Copyright 2005 Simtec Electronics Ben Dooks <ben@simtec.co.uk> http://armlinux.simtec.co.uk/
Copyright 2004-2006 Freescale Semiconductor, Inc. All Rights Reserved.
Copyright (C) 1999-2003 Russell King
Copyright (C) 2006-2007 Renesas Technology Corp.
Copyright (C) 1997, 1999, 2001, 06 by Ralf Baechle
Copyright (C) 1996, 2007, 2008 David S. Miller (davem@davemloft.net)
Copyright (c) 2007 Freescale Semiconductor, Inc. All rights reserved.
Copyright (C) 1999, 2000 Ralf Baechle (ralf@gnu.org)
Copyright (C) 2017, STMicroelectronics - All Rights Reserved Author(s): Olivier Moysan <olivier.moysan@st.com>
for STMicroelectronics.
Copyright (c) 2014 Intel Corporation. All rights reserved.
Copyright (c) 2019, Mellanox Technologies */
Copyright (c) 2018 MediaTek Inc. Author: Sean Wang <sean.wang@mediatek.com>
Copyright (c) 2014 Rockchip Electronics Co. Ltd. Author: Jianqun <jay.xu@rock-chips.com>
Copyright 2009 Advanced Micro Devices, Inc.
Copyright (C) 2015 H Hartley Sweeten <hsweeten@visionengravers.com>
Copyright (c) 2009 Takashi Iwai <tiwai@suse.de> Based on the patches by Rainer Zimmermann <mail@lightshed.de>
Copyright (c) 2015-2016, The Linux Foundation. All rights reserved.;(C) 2014-2015 Pratik Patel <pratikp@codeaurora.org>;(C) 2015-2016 Mathieu Poirier <mathieu.poirier@linaro.org>;(C) 2015-2016 Chunyan Zhang <zhang.chunyan@linaro.org>
Copyright 2013 Eukrea Electromatique <denis@eukrea.com> Based on imx35-pinfunc.h in the same directory Which is:
Copyright (c) 2008-2011 Atheros Communications Inc.
Copyright: (C) 2014 Himangi Saraogi
Copyright (C) 2013 Ideas On Board SPRL
Copyright (C) 2003-2015 Chelsio Communications. All rights reserved.
Copyright (C) 2007, 2008 Magnus Damm
Copyright © 2006 Red Hat, Inc.
Copyright © 2014 Intel Corporation Daniel Vetter <daniel.vetter@ffwll.ch>

Copyright (c) 2011 Ericsson AB.
Copyright (C) 2009 William Hubbs
Copyright (c) 2005 Dag Arne Osvik <da@osvik.no>
Copyright (C) 2004 Anton Blanchard <anton@au.ibm.com>, IBM
Copyright (c) 2015, Sony Mobile Communications, AB.
Copyright (C) 2011 Texas Instruments. All rights reserved.
Copyright (c) 2019, NVIDIA CORPORATION. All rights reserved.
Copyright (c) 2017 Pengutronix, Oleksij Rempel <kernel@pengutronix.de>
(C) Copyright 2007 Rodolfo Giometti <giometti@enneenne.com>
Copyright (C) 2000 William Greathouse (wgreathouse@smva.com)
Copyright (C) 1999 Kaz Kojima
Copyright (C) 2000 by Massimo Piccioni <dafastidio@libero.it>
Copyright (c) 2013-2014 Intel Corporation Author: Matthew Wilcox <matthew.r.wilcox@intel.com> Author: Ross Zwisler <ross.zwisler@linux.intel.com>
Copyright (C) 2012 Renesas Electronics Europe
(C) 2007 Martin K. Petersen <mkp@mkp.net>;(C) 2009 Bartlomiej Zolnierkiewicz
Copyright (C) 2001 Convergence integrated media GmbH Ralph Metzler <ralph@convergence.de>
Copyright (c) 2017, General Electric Company
Copyright (c) 2016 Broadcom. All rights reserved.
Copyright 2012-2016 Freescale Semiconductor, Inc. All Rights Reserved.
Copyright (C) 1997-2001 David A. Schleele <ds@schleele.org>
Copyright (C) 2010 SUSE Linux Products GmbH Author: Thomas Renninger <trenn@suse.de>
Copyright (C) 2001-2004 Paul Mackerras <paulus@au.ibm.com>, IBM
Copyright (C) 2014, Imagination Technologies Ltd.
Copyright (C) 2006 NTT (Nippon Telegraph and Telephone Corporation).
Copyright (C) 2011-2015, Yann Collet.
Copyright 2013 Til-Technologies
Copyright (C) 1999, 2001 Ralf Baechle
Copyright (C) 2015 Microchip Andrei Pistorica, Paul Thacker
Copyright (C) 2019 NXP.
Copyright (C) International Business Machines Corp., 2002,2008 Author(s): Steve French (sfrench@us.ibm.com) Jeremy Allison (jra@samba.org)
Copyright (C) 2018 Helge Deller <deller@gmx.de>
Copyright (c) 2004-2005, K A Fraser
Copyright (C) 2006 Antonino Daplas <adaplas@pol.net>
Copyright (C) 2000, 2002, 2003 Maciej W. Rozycki
Copyright (C) 2013 Mauro Carvalho Chehab
Copyright (C) 2014 loloshka2871
Copyright (c) 2006 Guedez Clement <klem.dev@gmail.com>
Copyright 2010 - Steven Rostedt <srostedt@redhat.com>, Red Hat Inc.
Copyright (C) 2002,5 Red Hat, Inc. All Rights Reserved. Written by David Howells (dhowells@redhat.com)
Copyright (C) 1999, 2004 Silicon Graphics, Inc.
Copyright (c) 2003 Winfried Ritsch (IEM)
Copyright (c) 2018, Nuvoton Corporation.
Copyright (c) 2019 Manivannan Sadasivam
Copyright 2009-2015 Freescale Semiconductor, Inc. All Rights Reserved.
Copyright (C) 2018-2019, Intel Corporation
Copyright (C) 2003 Jana Saout <jana@saout.de>
(C) Copyright 1999-2000, Greg Ungerer (gerg@snapgear.com);(C) Copyright 2000, Lineo (www.lineo.com);(C) Copyright 2001, SnapGear (www.snapgear.com)
Copyright (C) 2002 Peter Hettkamp <peter.hettkamp@htp-tel.de>
Copyright (c) 2012 Mellanox Technologies. - All rights reserved.
Copyright (c) 2009-2011 Wind River Systems, Inc.
Copyright 2017 IBM Corp. include
Copyright: (C) 2010 Nicolas Palix, DIKU.
Copyright 2013 Google Inc. Author: Willem de Bruijn (willemb@google.com)
Copyright (C) 2000 Philipp Rumpf */

LICENCE TERMS (cont.)

Copyright (C) 2000-2001 Deep Blue Solutions Ltd.
Copyright © 2009 Keith Packard
Copyright (c) 1994-2001, 2004 Justin T. Gibbs.
Copyright 2010 Marvell International Ltd. Author: Haojian Zhuang <haojian.zhuang@marvell.com>
Copyright (C) 2013 TangoTec Ltd. Author: Baruch Siach <baruch@tkos.co.il>
Copyright (C) 2006 David Brownell
Copyright (C) 2013 Intel Corp. Author: Chen, Gong <gong.chen@intel.com>
Copyright 2015 VMware, Inc.
Copyright (C) 2013 Citrix Systems
Copyright (c) 1999-2004 Vojtech Pavlik
Copyright IBM Corp. 2007, 2016, 2018 Author(s): Martin Schwidefsky <schwidefsky@de.ibm.com> David Hildenbrand <david@redhat.com> Janosch Frank <frankja@linux.vnet.ibm.com>
Copyright (C) 2013 Davidlohr Bueso <davidlohr.bueso@hp.com>
Copyright (c) 2015, Sony Mobile Communications Inc.
Copyright (C) 2000, 2001, 04 Keith M Wesolowski
Copyright (c) 2004-2008 David Howells <dhowells@redhat.com>
Copyright (c) 2018 Synopsys, Inc.
Copyright (c) 1999-2004 Samsung Electronics Co., Ltd. <http://www.samsung.com/>
Copyright 2008 Advanced Micro Devices, Inc.
Copyright (c) 2015-2018 Oracle. All rights reserved.
Copyright (C) 2012 Google Finland Oy.
Copyright (C) 2015-2016, SUSE, IBM Corp.
Copyright (C) 2006-2008 Chelsio Communications. All rights reserved.
Copyright (C) 2002, 2004 Oracle. All rights reserved.
"Copyright (C) 2012 Samsung Electronics Co., Ltd(<http://www.samsung.com/>)"
Copyright (C) 2012-2015 Spreadtrum Communications Inc.
"Copyright (C) 2001-2013 Tensilica Inc. Authors Victor Prupis"
Copyright (c) 2010 Analog Devices Inc.
Copyright © 2002 SYSGO Real-Time Solutions GmbH
Copyright (C) 2016 Cogent Embedded, Inc.
Copyright (C) 2002,2005 SOMA Networks, Inc.
Copyright 2017 Daniel Axtens, IBM Corporation.
Copyright (C) 2009-2010 Texas Instruments Author: Raja Mani <raja_mani@ti.com> Pavan Savoy <pavan_savoy@ti.com>
Copyright (C) 2011-2015 Texas Instruments Incorporated - <http://www.ti.com/> Santosh Shilimkar <santosh.shilimkar@ti.com> sricharan <r.sricharan@ti.com>
Copyright (c) 2003-2009 Cavium Networks
Copyright 2014 Luxul Inc.
Copyright (C) 2018 Prevas A/S
Copyright (C) 2013 MEN Mikro Elektronik Nuernberg GmbH
Copyright (C) 2002 Rick Bronson
Copyright 2009 Luotao Fu @ Pengutronix (l.fu@pengutronix.de)
Copyright (C) 2018 Paul Walmsley <paul@pwsan.com>
Copyright (c) 2012-2013, The Linux Foundation. All rights reserved.
Copyright (c) 2005 Michael Schmitz
Copyright (C) 2010 Atmel Corporation Nicolas Ferre <nicolas.ferre@atmel.com>
Copyright (c) 2017 Microchip Corporation.
Copyright (C) 1999, 2000 Niibe Yutaka
Copyright (C) 2007-2009 ST-Ericsson DMA driver for COH 901 318 Author: Per Friden <per.friden@stericsson.com>
Copyright (c) 2003-2006, Ericsson AB
Copyright (C) 2015-2019 Texas Instruments Incorporated - <http://www.ti.com/> Suman Anna <s-anna@ti.com>
Copyright (c) 2012-2016 Qualcomm Atheros, Inc.
(C) Copyright 2012 by Wolfram Sang, Pengutronix e.K. same license as the driver
Copyright (c) 2016-2017, National Instruments Corp.
"Copyright (c) 2000-2004 Vojtech Pavlik <vojtech@ucw.cz>"
Copyright (C) 2015, Dmitry Eremin-Solenikov
Copyright (C) 2009,2011 Greg Kroah-Hartman (gregkh@suse.de)

(c) Copyright 1999 Red Hat Software;(c) Copyright 1999 The Puffin Group Inc.:(c) Copyright 1999 Hewlett-Packard
Copyright: (C) 2012 Julia Lawall, INRIA/LIP6.
Copyright IBM Corp. 2000, 2008 Author(s): Utz Bacher <utz.bacher@de.ibm.com> Jan Glauber <jang@linux.vnet.ibm.com>
Copyright (C) 2017 Noralf Trønnes
Copyright (C) 2006-2015 HighPoint Technologies, Inc. All Rights Reserved.
Copyright 2018 Google Inc. Author: Soheil Hassas Yeganeh (soheil@google.com)
Copyright 2013 Ideas On Board SPRL
Copyright (C) 2004 IBM Corporation, Rusty Russell.
Copyright IBM Corp. 2006
Copyright (C) 1999-2000 Nicolas Pitre <nico@fluxnic.net>
Copyright (c) 2010-2011 Wind River Systems, Inc.
Copyright (c) 2017, Mellanox Technologies, Ltd. All rights reserved.
Copyright (C) 2016 Neil Armstrong <narmstrong@baylibre.com> Heavily based on plat_nand.c : Author: Vitaly Wool <vitalywool@gmail.com>
Copyright (C) 1997, 1998 Francois-Rene Rideau <fare@tunes.org>
Copyright (C) 1997, 1998 by Ralf Baechle
Copyright (c) 2011 Google, Inc.
Copyright (c) 2007 Ondrej Zajicek <santiago@crfreenet.org>;(c) 2007 Ondrej Zajicek <santiago@crfreenet.org>")
Copyright (c) 2006, 2007, 2008 QLogic Corporation. All rights reserved.
Copyright (c) 2010 Samsung Electronics, Co. Ltd Contact: Sylwester Nawrocki <s.nawrocki@samsung.com>
Copyright (C) 2017 Texas Instruments Incorporated - <http://www.ti.com/>
Copyright (C) 2014 Intel Corp. Author: Jiang Liu <jiang.liu@linux.intel.com>
Copyright (c) 2018 Politecnico di Torino
Copyright (C) 2013 Red Hat Author: Rob Clark <robdclark@gmail.com>
Copyright (C) 1996,97,98 Ralph Metzler (rjkm@thp.uni-koeln.de) Marcus Metzler (mocm@thp.uni-koeln.de);(c) 1999-2001 Gerd Knorr <kxaxel@goldbach.in-berlin.de>
Copyright (C) 2019 Linus Walleij <linus.walleij@linaro.org>
Copyright (C) IBM Corporation, 2010
Copyright (C) 2006-2008 Barco N.V.
Copyright 2002 by Kai Gernaschewski <kai.gernaschewski@gmx.de>
Copyright 2004, Instant802 Networks, Inc.
Copyright (C) 2018 Laurent Pinchart <laurent.pinchart@ideasonboard.com>
Copyright (C) 2007 David Brownell
Copyright (C) 2005-2007 Asia Vital Components Co., Ltd.
Copyright (c) 2015,2017 Qualcomm Atheros, Inc.
Copyright(c) 1999 - 2006 Intel Corporation.
"Copyright (C) 2004, 2006 MIPS Technologies, Inc. All rights reserved. Author: Maciej W. Rozycki <macro@mips.com>"
Copyright (C) 2016 IBM Corporation
© Copyright 1995 by Geert Uytterhoeven (geert@linux-m68k.org) Peter De Schrijver Peter.DeSchrijver@linux.cc.kuleuven.ac.be)
Copyright (C) 1995-1998 Linus Torvalds & author (see below) Principal Author: mlord@pobox.com (Mark Lord)
Copyright (c) 2014 Ezequiel Garcia
Copyright (C) 1992 Darren Senn
Copyright (c) 2000 Eric Sandeen <eric_sandeen@bigfoot.com>
(c) 2010, Arnaldo Carvalho de Melo <acme@redhat.com>
Copyright (C) 2003-2018 Cavium, Inc.
Copyright (c) 2008 Rod Whitby <rod@whitby.id.au>
Copyright 2004 Karen Spearl
Copyright (c) 2017 MediaTek Inc. Author: Kevin-CW Chen <kevin-cw.chen@mediatek.com>
Copyright (C) 2013 Capella Microsystems Inc. Author: Kevin Tsai <ktsai@capellamicro.com>
Copyright 2007 IBM Corporation
Copyright (C) 2011 Fuel7, Inc. All rights reserved.
Copyright (C) 2018 Toradex AG
Copyright (C) 2004-2007 Herbert Pötzl - Arnaud Patard Additional cleanups by Ben Dooks <ben-linux@fluff.org>
Copyright (C) 1997-2014 AudioScience Inc. <support@audioscience.com>;(C) Copyright AudioScience Inc. 2002

LICENCE TERMS (cont.)

Copyright (c) 2006-2008 Intel Corporation
(C) 2001-2002 Patrick McHardy <kaber@trash.net>
(C) 2002 Louis Zhuang <louis.zhuang@intel.com>. 2007 Alexander Eichner 2008 Pekka Paalanen <pq@iki.fi>
Copyright (C) 2009, 2010, 2012, 2014 Imagination Technologies Ltd.
Copyright (C) 2002, 2003 Paul Mundt
Copyright (C) 2014 Samsung Electronics Krzysztof Kozlowski <krzk@kernel.org>
Copyright 2017 Valve Corporation
Copyright (C) 2001, 2002 M. R. Brown
Copyright (C) 2014 Topic Embedded Products Author: Mike Looijmans <mike.looijmans@topic.nl>
Copyright (c) 2016-2017 Socionext Inc.
Copyright 2014 IBM Corporation Author: Mahesh Salgaonkar <mahesh@linux.vnet.ibm.com>
Copyright (C) 2016 Linaro, Ltd. Stephen Boyd <stephen.boyd@linaro.org>
Copyright (C) 2003, 2004, 2005 Paul Mundt
Copyright (C) 1999 Michael Klar
Copyright 2015 Maxime Ripard
Copyright © 2006 Texas Instruments.
Copyright (C) 2015 Microchip Technology Germany II GmbH & Co. KG
Copyright (C) 2015, 2016 Zodiac Inflight Innovations
Copyright 2011-2014 Analog Devices Inc. Author: Lars-Peter Clausen <lars@metafoo.de>
Copyright 2015 Linaro Ltd.
Copyright (C) 2005 Martin Langer <martin-langer@gmx.de>
Copyright (C) 2015-2018 Pengutronix, Uwe Kleine-König <kernel@pengutronix.de>
Copyright 2008-2013 Broadcom Corporation
Copyright (C) 2004 David Gibson, IBM Corporation.
Copyright (C) 2011 Xilinx
Copyright (c) 2010 Arnaud Patard <arnaud.patard@rtp-net.org>
Copyright (C) 2000 David A. Schleef <ds@schleef.org>
Copyright (C) 2013 Andrey Moiseev <o2g.org.ru@gmail.com>
Copyright (C) 2017-2018, Bootlin
(c) 1999 R. Offermanns (rolf@offermanns.de) based on the aimslab radio driver from M. Kirkwood many thanks to Michael Becker and Friedhelm BIRTH (from TerraTec)
Copyright 2015-2016 Vladimir Zapolskiy <vz@mleia.com>
Copyright (C) 2010-2011, Laurent Pinchart <laurent.pinchart@ideasonboard.com>
Copyright (c) 1998, 1999 Frodo Looijaard <frodol@dds.nl>, Kyösti Mälkki <kmalkki@cc.hut.fi>
Copyright (c) 2013-2017, Intel Corporation. All rights reserved. Intel Management Engine Interface (Intel MEI) Linux driver
Copyright (c) 2002-2007 Volkswagen Group Electronic Research
Copyright (C) 2003 SAN People (Pty) Ltd
Copyright (C) STMicroelectronics SA 2015 Authors: Hugues Fruchet <hugues.fruchet@st.com> Jean-Christophe Troitin <jean-christophe.troitin@st.com> for STMicroelectronics.
Copyright (C) 2015 Texas Instruments Inc.
Copyright (c) 2010-2011 Atheros Communications Inc.
Copyright (C) 2013 Pavel Machek <pavel@ucw.cz>
Copyright 2016 Integrated Device Technology, Inc.
Copyright (C) 2007 Jean Delvare <jdelvare@suse.de>
Copyright (C) 2007 Instituto Nokia de Tecnologia - INdT Author: Carlos Eduardo Aguiar <carlos.aguiar@indt.org.br>
Copyright (C) 2013, LG Electronics, Kyungsik Lee <kyungsik.lee@lge.com>
Copyright (C) 2004, 2008-2009 Bartłomiej Zolnierkiewicz
Copyright (C) 1998, 2001, 03 by Ralf Baechle
Copyright (C) 2015 Hans de Goede <hdegoede@redhat.com>
Copyright (c) 2008 Rodolfo Giometti <giometti@linux.it>
Copyright (c) 2017, Linaro Ltd
(c) 1999, 2000, 2009 Ingo Molnar <mingo@redhat.com>
Copyright (c) 2006 Pototskiy Akex <alex.pototskiy@gmail.com> Takashi Iwai <tiwai@suse.de> Tobin Davis <tdavis@dsl-only.net>
Copyright (c) 2017 Ericsson AB All rights reserved.
Copyright (C) 1999 Eric A. Thomas.

Copyright (C) 2001 Steve Underwood
(C) Copyright IBM Corporation 2006-2008
Copyright 2018 Realtek Microelectronics Author: Bard Liao <bardliao@realtek.com>
Copyright (C) 2016 NXP Semiconductors. Author: Fabio Estevam <fabio.estevam@nxp.com>
Copyright (C) 2016 Stephan Mueller <smueller@chronox.de>
Copyright 2008, Johannes Berg <johannes@sipsolutions.net>
Copyright (c) 2012-2015, NVIDIA Corporation.
Copyright (C) 2006-2007 8D Technologies inc Raphael Assenat <raph@8d.com> Added video overlay support
Various improvements
Copyright 2007-2008 Jaime Velasco Juan <jsagarribay@gmail.com>
Copyright (C) 2019 Nicolas Saenz Julienne <nnsaenzjulienne@suse.de>
(C) Copyright 2016-2018 - Mathieu Desnoyers <mathieu.desnoyers@efficios.com>;(C) Copyright 2018 - Will Deacon <will.deacon@arm.com>
Copyright (C) 2014 Mario Kicherer (dev@kicherer.org)
Copyright (C) 2016-17 Synopsys, Inc. (www.synopsys.com)
Copyright 2011, Chetan Loke <loke.chetan@gmail.com>
Copyright IBM Corp. 2008, 2009
Copyright (C) 2015 Numascale AS. All rights reserved.
Copyright (C) 2012-2013 Linaro Ltd. Author: Haojian Zhuang <haojian.zhuang@linaro.org>
Copyright 2008 Freescale Semiconductor, Inc. All Rights Reserved.
Copyright (C) 2014, Google, Inc
Copyright (C) 1999 Jakub Jelinek (jj@ultra.linux.cz)
Copyright 2010 2011 Mark Nelson and Tseng-Hui (Frank) Lin, IBM Corporation
Copyright IBM Corp. 1999, 2000
Copyright (C) 2018 Daniel Mack
(C) 1999 by Joshua M. Thompson (funaho@jurai.org)
Copyright (c) 2016-2017 Hisilicon Limited.
Copyright (c) 2003 Patrick Mochel
Copyright (C) STMicroelectronics 2018
Copyright (C) 1999,2003 Matthew Wilcox <willy at debian . org > portions from "linux/ioctl.h for Linux" by H.H. Bergman.
Copyright (c) 2012-2019, Intel Corporation. All rights reserved.
Copyright 2014-2015 VMware, Inc., Palo Alto, CA., USA
Copyright (C) 2003 Conexant Americas Inc. All Rights Reserved.
Copyright (c) 2016-2018 QLogic Corporation
Copyright (c) by James Courtier-Dutton <James@superbug.demon.co.uk>
Copyright (c) 2006,2007 Daniel Mack
Copyright (C) 2000-2003 Deep Blue Solutions Ltd
Copyright 2009 Jerome Glisse
Copyright (C) 2010-2013 Felix Fietkau <nbd@openwrt.org>
Copyright (C) 2003-2008, LINBIT Information Technologies GmbH.
(c) 2000 Jimmie Mayfield (mayfield+datafab@sackheads.org);(c) 2002 Alan Stern <stern@rowland.org>
Copyright (C) 2013 Google, Inc., Stephane Eranian
Copyright (C) 2001-2006 Helge Deller <deller@gmx.de>
Copyright 2001 Matthew Wilcox
Copyright (C) 1995 Andreas Busse
Copyright (C) 1998 Ingo Molnar.
Copyright (C) 2017 Dialog Semiconductor
Copyright (c) 2012, Intel Corporation
Copyright (c) 2015 MediaTek, Shunli Wang <shunli.wang@mediatek.com>
Copyright (C) 2015 Helge Deller <deller@gmx.de>
Copyright 1998 Franco Venturi
Copyright (C) 2009 Manuel Gebele <forensix@gmx.de>, Germany
Copyright 2009 - 2016 Freescale Semiconductor, Inc.
Copyright (C) 2002 Khalid Aziz <khalid_aziz@hp.com>
Copyright (C) 2008 Adam Nielsen <a.nielsen@shikadi.net>
Copyright 2000 Paul Mackerras.

LICENCE TERMS (cont.)

Copyright (c) 2018 Manivannan Sadhasivam <manivannan.sadhasivam@linaro.org>
Copyright 2001-2004 Jeff Garzik <jgarzik@pobox.com>
Copyright (C) 2003, 2004 Chris Dearman
Copyright (C) 2015-2017 Renesas Electronics Corporation
Copyright (c) 2019 HiSilicon Limited.
Copyright (C) 2004 Michel Xhaard mxhaard@magic.fr
Copyright (C) 2001 Randolph Chung <tausq@debian.org>
Copyright (C) 2008-2011, Red Hat Inc, Ingo Molnar <mingo@redhat.com>
Copyright (c) 2007 by Bill Gatliff <bgat@billgatliff.com>.
Copyright (C) 2017 Google, Inc. Author: Gwendal Grignou <gwendal@chromium.org>
Copyright (c) 2014 Huang Bo <huangbobupt@163.com>
Copyright (C) 2018 Synaptics Incorporated Author: Jisheng Zhang <jszhang@kernel.org>
Copyright 1998 Jonas Munsin <jmunsin@iki.fi>;(C) 1998 Ben Pfaff;(C) 1997 M. Kirkwood Converted to new API by Alan Cox <alan@lxorguk.ukuu.org.uk> Various bugfixes and enhancements by Russell Kroll <rroll@exploits.org>
Copyright (C) 2018 Advanced Micro Devices, Inc.
Copyright (C) 2015-2017 Intel Corp
Copyright (C) 2016 Powerventure Semiconductor Ltd.
Copyright (C) 2004 - 2010 Ivo van Doorn <lvdoorn@gmail.com>
Copyright (C) 1992 Drew Eckhardt
(C) Copyright 2002-2015 Yoshinori Sato <ysato@users.sourceforge.jp>
Copyright (c) 2001 Richard Russon <nfts@flatcap.org>
Copyright (C) 1995, 1996 Olaf Kirch <okir@monad.swb.de>
Copyright (c) 2009, NVIDIA Corporation.
Copyright (C) 1992,1994,1995 Australia. E-mail billm@jacobi.maths.monash.edu.au |
Copyright 2016 Realtek Semiconductor Corp. Author: Bard Liao <bardliao@realtek.com>
Copyright © 2008, 2015 Oracle and/or its affiliates. All rights reserved.
Copyright: |copy| 2003-2005 AMD, Personal Connectivity Solutions
Copyright (C) 1992,1994,1997| Australia. E-mail billm@suburbia.net |
Copyright (C) 2006 Linus Torvalds
Copyright (C) 2019 Orolia
Copyright (C) 2006-2008 Michael Hennerich, Analog Devices Inc.
Copyright (C) 2017 Robert Jarzmk
Copyright (C) 2009 Red Hat <bskeggs@redhat.com>
Copyright (C) 2009 Laurent Pinchart <laurent.pinchart@skynet.be>
Copyright (C) 2001 RidgeRun, Inc. Author: Greg Lonnon <glonnon@ridgerun.com>
Copyright (C) 2003, Peter Sadik <peter.sadik@jdt.com>
(C) Copyright 2002,2004,2006 Greg Kroah-Hartman;(C) Copyright 2002,2004 IBM Corp.:(C) Copyright 2006 Novell Inc.
Copyright (C) 2017 Intel Corporation Author: Mika Westerberg <mika.westerberg@linux.intel.com>
Copyright 2007-2013 Solarflare Communications Inc.
Copyright (c) 2014-2015 Hisilicon Limited.
Copyright 2008 Realtek Microelectronics
Copyright (C) 2014 Red Hat Inc, author: Steven Rostedt <srostedt@redhat.com>
Copyright (c) 2005 David Shaohua Li <shaohua.li@intel.com>
Copyright (c) 2016 AmLogic, Inc. Author: Michael Turquette <mturquette@baylibre.com>
Copyright (C) 2014 Linaro Ltd
Copyright (C) 1992,1993,1994,1996 | E-mail billm@jacobi.maths.monash.edu.au |
Copyright 2007 (C) Oyvind Repvik (nail@nslu2-linux.org)
Copyright (C) 2017, STMicroelectronics - All Rights Reserved Author: Fabrice Gasnier <fabrice.gasnier@st.com>
Copyright (C) 2004-2016 Synopsys, Inc.
Copyright (C) 1998-2001 Russell King
Copyright (C) 2000, 2007 David S. Miller (davem@davemloft.net)
Copyright (C) 2012 Texas Instruments Santosh Shilimkar <santosh.shilimkar@ti.com> Sricharan <r.sricharan@ti.com>
Copyright (C) 2013-2014 Chelsio Communications. All rights reserved.
Copyright (C) 2007 OnStor, Inc. * Andrew Sharp <andy.sharp@lsi.com>;(c) Copyright 1996 Alan Cox <alan@lxorguk.ukuu.org.uk>, All Rights Reserved.

Copyright (C) 2016 Microchip Technology Inc. All rights reserved.
Copyright (C) Intel 2017
Copyright (C) 2003,2004 Krzysztof Benedyczak (golbi@mat.uni.torun.pl) Michal Wronski (michal.wronski@gmail.com)
Copyright 2008 Freescale Semiconductor Inc.
Copyright (c) 2016-present, Przemyslaw Skibinski, Yann Collet, Facebook, Inc. All rights reserved.
Copyright (C) 2002,2003 Broadcom Corporation
Copyright (c) 2014 MediaTek Inc.
Copyright 2014-2017 Freescale Semiconductor Inc.
Copyright IBM Corp. 2003, 2011 Author(s): Thomas Spatzier Jan Glauber (jan.glauber@de.ibm.com)
Copyright (C) 2004-2008 International Business Machines Corp. Author(s): Michael A. Halcrow <mhalcrow@us.ibm.com> Tyler Hicks <tyhicks@ou.edu>
Copyright (c) 2010 Samsung Electronics Co. Ltd. Jaswinder Singh <jassisinghbrar@gmail.com>
Copyright (C) 2008,2009 CompuLab Ltd.
Copyright 2018-2019 Purism SPC
Copyright (C) 2016-2017 Micron Technology, Inc.
Copyright (C) 2010 Broadcom Corporation.
(C) 2002 by Harald Welte <laforge@gnomons.org>;(C) 2010 Red Hat Inc Author: Michael S. Tsirkin <mst@redhat.com>
Copyright (C) 2014
Copyright 2011-2017 by the PaX Team <pageexec@freemail.hu> Modified by Alexander Popov <alex.popov@linux.com> v2
Copyright 2008 IBM Corp. Josh Boyer <jwboyer@linux.vnet.ibm.com>
(C) 1997 Carnegie Mellon University;(C) 2000 Carnegie Mellon University
Copyright 2012 Nouveau community
Copyright (C) 2010,2015 Broadcom
Copyright 2008-2010 Freescale Semiconductor, Inc.
Copyright (C) 2013 Texas Instruments Author: Tomi Valkeinen <tomi.valkeinen@ti.com> Based on a driver by: Steve Sakoman <steve@sakoman.com>
Copyright (c) by Matze Braun <MatzeBraun@gmx.de>. Takashi Iwai <tiwai@suse.de>
Copyright 2019 NXP Author: Xiaowei Bao <xiaowei.bao@nxp.com>
Copyright 2001, 2002 by Robert Olsson <robert.olsson@its.uu.se> Uppsala University and Swedish University of Agricultural Sciences
Copyright (C) 2016 - Marcin Malagowski <mrc@bourne.st>
Copyright(c) 2007-2011 Realtek Corporation.*/
Copyright (c) 2000,2002-2003,2005 Silicon Graphics, Inc. All Rights Reserved.
Copyright 2009 Wolfson Microelectronics
Copyright (c) 2018-2019, Vladimir Oltean <olteanv@gmail.com>
Copyright (C) 2010, 2013 Intel Corporation Author: Zhao Yakui <yakui.zhao@intel.com> Lv Zheng <lv.zheng@intel.com>
Copyright (C) 1998, 1999, 2001-2004 Hewlett-Packard Co David Mosberger-Tang <davidm@hpl.hp.com>
Copyright (C) 2018 Icenowy Zheng <icenowy@aosc.xyz>
(c) Copyright 2002 Robert Schwebel <r.schwebel@pengutronix.de>;(c) Sven Geggus <sven@geggus.net>
Copyright (C) 2005 Pete Zaitcev (zaitcev@redhat.com)
Copyright 2002 Andi Kleen, SuSE Labs.
Copyright (c) 2014 Arturo Borrero Gonzalez <arturo@debian.org>
Copyright 2014-2018 Advanced Micro Devices, Inc.
Copyright (C) 2001-2004 by David Brownell;(c) split iso entries.
Copyright 1993-2003 NVIDIA, Corporation. All rights reserved.
Copyright (C) 2007-2009 David T.L. Wong <davidtwong@gmail.com>
Copyright (C) 2013 Texas Instruments Inc
Copyright (C) 2005-2008 Pierre Ossman, All Rights Reserved.
Copyright (C) 1999-2002 Maxim Krasnyansky <maxk@qualcomm.com>
(C) 2001 - 2007 Tensilica Inc. Kevin Chea <kchea@yahoo.com> Marc Gauthier <marc@linux-xtensa.org> Chris Zankel <chris@zankel.net>;(C) 1996,1998 by Thomas Bogendoerfer (tsbogend@alpha.franken.de);(C) 1995 by Andreas Busse (andy@waldorf-gmbh.de)
Copyright (C) 1996-98 Erik Andersen

LICENCE TERMS (cont.)

Copyright: (C) 2015 Andrzej Hajda, Samsung Electronics Co., Ltd. URL: <http://coccinelle.lip6.fr/>
Copyright (C) 1999 Russell King.
Copyright (C) 2017 Florian Fainelli <f.fainelli@gmail.com>
(C) 2001 San Mehat <nettwerk@valinux.com>
Copyright (c) 2008-2009 Frederic Weisbecker <fweisbec@gmail.com>
Copyright © 2012-2013 Jussi Kivilinna <jussi.kivilinna@iki.fi>
Copyright (C) 1999,2000 Arm Limited
Copyright (C) 1997 Jay Estabrook
Copyright(c) 2013 - 2018 Intel Corporation.
Copyright (C) 2003 - 2005 Nokia Corporation
Copyright (C) 2007-2008 Texas Instruments
Copyright (C) 2003-2010 Jean Delvare <jdelvare@suse.de>
Copyright (c) 2007 Thomas Bogendoerfer
Copyright (C) 2001-2003 Andreas Gruenbacher, <agruen@suse.de>
(c) Copyright 2010-2013 Datera, Inc.
Copyright (C) 2009 David Gibson, IBM Corporation.
Copyright (c) Marc A. Viredaz, 1998 DEC Western Research Laboratory, Palo Alto, CA Date April 1998 (April 1997)
System Advanced RISC Machine (ARM)
Copyright (C) 2011, Samsung Electronics Co., Ltd. Sylwester Nawrocki <s.nawrocki@samsung.com>
Copyright (c) 2001 Denis Oliver Kropp <dok@convergence.de>
Copyright (C) 2015-17 Wolfram Sang, Sang Engineering <wsa@sang-engineering.com>
Copyright (c) 2006 Simtec Electronics Ben Dooks <ben@simtec.co.uk> Vincent Sanders <vince@simtec.co.uk>
Copyright 2018 HabanaLabs, Ltd. All Rights Reserved.
Copyright 2015 Baylibre SAS.
Copyright (c) 2018, NVIDIA CORPORATION.
Copyright 2019 Google Inc
Copyright (C) 2005 by Stefan Lucke
"Copyright (c) 2000-2001 Lineo Inc. <www.lineo.com>"
Copyright (C) 2016 Jamie Lentin <jm@lentin.co.uk>
Copyright (c) 2010-2011 by Mauro Carvalho Chehab
Copyright (C) 1998-2001 Hewlett-Packard Co Stephane Eranian <eranian@hpl.hp.com> David Mosberger-Tang <davidm@hpl.hp.com>
"Copyright (C) 2012 ARM Ltd. Author: Marc Zyngier <marc.zyngier@arm.com>"
(C) Copyright 2014 - 2015, Xilinx, Inc.
Copyright (C) 1995-1996 Linus Torvalds & authors (see below)
Copyright (c) 2011 Jussi Kivilinna <jussi.kivilinna@mbnet.fi>
(C) 1999-2001 Marc Boucher <marc@mbsi.ca>;(C) 2006,2008 Red Hat, Inc., James Morris <jmorris@redhat.com>
Copyright (c) 2003-2006, 2014-2015, Ericsson AB
Copyright (C) 2005 Yani Ioannou <yani.ioannou@gmail.com>
Copyright (c) 1998-1999 by Frank van de Pol <fvdpol@coil.demon.nl> Jaroslav Kysela <perex@perex.cz>
Copyright (c) 2005 Sasha Khapoyorsky <sashak@alsa-project.org> Takashi Iwai <tiwai@suse.de>
Copyright (C) 2005-2015 Freescale Semiconductor, Inc. All Rights Reserved.
Copyright (c) 2004 Herbert Xu <herbert@gondor.apana.org.au>
copyright abandoned. Code was subsequently included in the kernel, thus was re-licensed under the GNU GPL v2.
Copyright 2016 Paul Mackerras, IBM Corp. <paulus@au1.ibm.com>
Copyright (C) 2008 Red Hat, Inc. Author: Chris Wright
Copyright (C) 2015 Ben Chen <ben_chen@bizlinktech.com>
Copyright (C) 2008 Per Dalen <per.dalen@cnw.se>
Copyright (C) Freescale Semiconductor, Inc. 2006-2009. All rights reserved.
Copyright (C) 2019 IBM Corp. */
Copyright (C) 2003-2005 Anton Blanchard and Milton Miller, IBM Corp
(C) 2015 Red Hat GmbH Author: Florian Westphal <fw@strlen.de>
Copyright (c) 2013, Microsoft Corporation.
Copyright (C) 2012 Alexander Block. All rights reserved.
Copyright (C) 2017 exceet electronics GmbH
Copyright (C) 2016 Intel Corporation
Copyright (C) 1995, 1999, 2001, 2002 by Ralf Baechle

Copyright (C) 2008 David Brownell
(c) Copyright 1995 Simon "Guru Aleph-Null" Janes NCM: Network and Communications Management, Inc.
Copyright (C) 2015 Samsung Electronics Author: Jaewon Kim <jaewon02.kim@samsung.com>
Copyright (C) 2006 Free Software Foundation, Inc.
Copyright |copy| 2012 - 2013 Samsung Electronics Co., Ltd.
Copyright(20)02 Hewlett-Packard Company.
Copyright 2019 Collabora Ltd.
Copyright (c) 2014 Jiri Pirko <jiri@resnulli.us>
Copyright © 2008 Keith Packard
Copyright (C) 1996-2000 Russell King - Converted to ARM.
Copyright IBM Corp. 2016 Author(s): Janosch Frank <frankja@linux.vnet.ibm.com>
Copyright IBM Corporation, 2013.
Copyright (c) 2006 The Regents of the University of Michigan. All rights reserved.
Copyright (C) 2011-12 Synopsys, Inc. (www.synopsys.com)
Copyright (C) 2010, Lars-Peter Clausen <lars@metafoo.de> PWM beeper driver
Copyright** |copy| 2017 : LinuxTV Developers
Copyright(c) 2014 Intel Corporation. All rights reserved.
Copyright (c) 2016 Marek Vasut <marex@denx.de>
Copyright (C) 2011, 2012 STRATO. All rights reserved.
Copyright (c) 2002-2004, Jouni Malinen <j@w1.fi>
Copyright (C) 2000 RidgeRun, Inc. Author: Greg Lonnon <glonnon@ridgerun.com>;(c) MontaVista Software, Inc.
Copyright (C) 1997 Cobalt Microserver
Copyright (C) 2016-2019 B.A.T.M.A.N. contributors:
(C) Copyright 2010 Dirk Eibach, Guntermann & Drunck GmbH <eibach@gdsys.de>
Copyright (C) 2013 Texas Instruments Inc.
Copyright 2010 (c) Philippe De Muyter <phdm@macqel.be>
Copyright (C) 1998, 1999, 2002 Hewlett-Packard Co David Mosberger-Tang <davidm@hpl.hp.com>
Copyright (C) 2001, 2003 Rusty Russell IBM Corporation.
Copyright (C) 2004, 2008 Jean Delvare <jdelvare@suse.de>
Copyright (c) 2004-2005 Simtec Electronics <http://www.simtec.co.uk/products/SWLINUX/> Ben Dooks <ben@simtec.co.uk>
Copyright (c) 2001,2002 Christer Weinigel <wingel@nano-system.com>
Copyright (C) 2012 Freescale Semiconductor, Inc.
Copyright (C) 2001 Steve Underwood and 2007 David Rowe
Copyright 2011 Analog Devices Inc.
Copyright (C) IBM Corporation 2017.
Copyright IBM Corp. 2001, 2006 Author(s): Stefan Bader <shbader@de.ibm.com> Michael Holzheu <holzheu@de.ibm.com> Martin Schwidefsky <schwidefsky@de.ibm.com>
Copyright(C) 2015 Intel Corporation.
Copyright (C) 2006 Red Hat, Inc. All Rights Reserved. Written by David Howells (dhowells@redhat.com)
Copyright (C) 2017 Facebook
Copyright 2011 Wolfson Microelectronics plc. Author: Mark Brown <broonie@opensource.wolfsonmicro.com>
Copyright 2017 Omnibond Systems, L.L.C.
Copyright (c) 2004 Freescale Semiconductor, Inc.
Copyright(c) 2003-2015 Intel Corporation. All rights reserved. Intel Management Engine Interface (Intel MEI) Linux driver Intel MEI Interface Header
Copyright (C) STMicroelectronics 2018 - All Rights Reserved Author: Ludovic Barre <ludovic.barre@st.com> for STMicroelectronics.
Copyright (c) 2015-2019 Federico Lorenzi
Copyright (C) 2009 ST Microelectronics Viresh Kumar <vireshk@kernel.org>
Copyright (c) 2009/10 Intel Corporation
Copyright 2012 Wolfson Microelectronics PLC. Author: Mark Brown <broonie@opensource.wolfsonmicro.com>
Copyright (c) 2004 Matthieu Castet <castet.matthieu@free.fr>
Copyright (C) 2009 Semihalf.
Copyright (c) 2000,2002-2005 Silicon Graphics, Inc. All Rights Reserved.
Copyright (C) 2004-2007,2011-2012 Freescale Semiconductor, Inc. All rights reserved.
Copyright(c) 2015 Intel Mobile Communications GmbH

LICENCE TERMS (cont.)

Copyright (C) 2006-2007 Paul Mundt
Copyright (C) 2010,2012 - NVIDIA, Inc.
Copyright IBM Corp. 2017,2019 Author(s): Martin Schwidewsky <schwidewsky@de.ibm.com> Harald Freudenberger <freude@de.ibm.com>
Copyright (C) 2013 Christian Vogelgsang
Copyright IBM Corp. 2005 extended error reporting for DASD ECKD devices Author(s): Stefan Weinhuber <wein@de.ibm.com>
Copyright 2018 Hannes Reinecke, SUSE Linux GmbH <hare@suse.com>
Copyright 2017-2020 NXP.
Copyright 2017 Cirrus Logic
Copyright 2010-11 Wolfson Microelectronics plc
Copyright (C) 1995-2000 Linus Torvalds & author (see below)
Copyright (C) 2006-2008 KeyStream Corp.
Copyright © 2008 Michael Neuling IBM Corporation
Copyright (C) 2004 Silicon Graphics, Inc.
(C) Copyright 2009-2011 Faraday Technology Po-Yu Chuang <ratbert@faraday-tech.com>
Copyright (C) 2015, Inverse Path Andrej Rosano <andrej@inversepath.com>
Copyright (c) 2015 by Kamil Debski
Copyright (C) 1999,2000,2012 MIPS Technologies, Inc. All rights reserved. Authors: Carsten Langgaard <carsten@mips.com> Steven J. Hill <sjhill@mips.com>
Copyright (C) 2004 - 2005, 2009 Nokia corporation Written by Tuukka Tikkanen <tuukka.tikkanen@elektrobit.com>
Copyright (C) 2017 Netronome Systems, Inc.
Copyright (C) 2015 Sudip Mukherjee <sudip.mukherjee@codethink.co.uk>
Copyright 2019 Jonathan Corbet <corbet@lwn.net>
Copyright (c) 2016 Jan Kandziora <jjj@gmx.de>
Copyright (c) 2010 Ignaz Forster <ignaz.forster@gmx.de>
Copyright (c) 2003 International Business Machines, Corp.
Copyright 2002,2004 MontaVista Software Inc.
Copyright (C) 2003, 2004, 2006 Red Hat, Inc. All Rights Reserved. Written by David Howells (dhowells@redhat.com)
Copyright (C) 2017 Corentin Labbe <clabbe.montjoie@gmail.com>
Copyright (C) 2004,2008 Laurent Vivier <Laurent@lvivier.info>;(c) 1997, 1998 Hauke Fath.
Copyright (C) 2018 Paolo Pisati <p.pisati@gmail.com>
Copyright (c) 2012 Linaro : Daniel Lezcano <daniel.lezcano@linaro.org> (IBM)
Copyright (C) 1994 Martin Schaller & Roman Hodek
Copyright (C) 2008 Marek Vasut <marek.vasut@gmail.com>
Copyright (C) 2009 Johannes Berg <johannes@sipsolutions.net>
Copyright 2006-2008, Michael Ellerman, IBM Corporation.
Copyright (C) 2016 Savoir-Faire Linux Author: Sebastien Bourdelin <sebastien.bourdelin@savoirfairelinux.com>
Copyright (C) 2014-2017 Alex Hung <alex.hung@canonical.com>
copyright (C) 2007 Cluster File Systems, Inc
Copyright (c) 2011, TAOS Corporation.
(c) 2006-2012
Copyright (C) 1994 - 1999, 2000 by Ralf Baechle and others.
Copyright (C) 2009-2010 Tom Zanussi <tzanussi@gmail.com>
Copyright (C) 2009-2010 Samsung Electrnoics MyungJoo Ham <myungjoo.ham@samsung.com>
Copyright (c) 2016 Matthias Brugger <mbrugger@suse.com>
Copyright (C) 2002 - 2011 Paul Mundt
Copyright 2000-2001, 2006, 2008 MontaVista Software Inc. Author: MontaVista Software, Inc. <source@mvista.com>
Copyright (C) 2012, 2013, 2014, 2015 Red Hat Inc, Arnaldo Carvalho de Melo <acme@redhat.com>
Copyright (C) 2009 Wu Zhangjin <wuzhangjin@gmail.com>
Copyright (C) 2011 Yadwinder Singh (yadi.brar01@gmail.com) Jaswinder Singh (jaswinder.singh@linaro.org)
Copyright 2002 Hewlett-Packard Company
Copyright (C) 2011 One Laptop per Child
Copyright (c) 2007-2011 Nicira, Inc.
Copyright 2018, Thiago Jung Bauermann, IBM Corporation.
Copyright(c) 2015-17 Intel Corporation

Copyright 2015, Daniel Axtens, IBM Corporation
(c) Copyright 2016 Oracle Corporation
Copyright (C) 2011 Advanced Micro Devices, Inc., Robert Richter
Copyright (c) 2017 Angelo Dureghello <angelo@sysam.it>
Copyright (C) 2003, Daria Phoebe Brashear
(C) 2005 Finn Thain;(C) 1998 Alan Cox;(C) 1996 by Thomas Bogendoerfer (tsbogend@bigbug.franken.de);(C) 1995 by Andreas Busse (andy@waldorf-gmbh.de)
Copyright (C) 2011 Hans de Goede <hdegoede@redhat.com>
Copyright (C) 1998 Paul Mackerras and Fabio Riccardi.
Copyright (c) 2014 Petr Olivka
Copyright (C) 1998-2000 by Massimo Piccioni <dafastidio@libero.it>
Copyright (C) 2001 Momchil Velikov
Copyright(c) 2016 Intel Deutschland GmbH
Copyright (C) 1994, 95, 96, 97, 98, 99, 2000, 2003 Ralf Baechle
Copyright (C) 2013 STMicroelectronics (R&D) Limited. http://www.st.com
Copyright (c) 2000-2002 Vojtech Pavlik
Copyright (c) 2004, 2005 Mellanox Technologies Ltd. All rights reserved.
Copyright (C) 2016,2018 Advanced Micro Devices, Inc.
Copyright 2011 Samsung Electronics Co., Ltd. http://www.samsung.com/
Copyright (C) 2002 Intel Corporation
Copyright (C) 2000-2002 Lineo by Stuart Lynne, Tom Rushworth, and Bruce Balden
Copyright (C) 2004 MIPS Technologies, Inc. All rights reserved.
Copyright (C) 2012 Joachim Eastwood <manabian@gmail.com>
Copyright (C) 2016 CNEX Labs Initial: Javier Gonzalez <javier@cnexlabs.com>
Copyright (C) 2014 Samsung Electronics Lukasz Majewski <l.majewski@samsung.com>
Copyright (C) 2008 Intel Corporation Authors: Austin Zhang <austin_zhang@linux.intel.com> Kent Liu <kent.liu@intel.com>
Copyright 2013 Jeff Layton <jlayton@poochiereds.net>
Copyright 2000 Stuart Menefy (stuart.menefy@st.com)
(C) 2006 Thomas Gleixner <tglx@linutronix.de>;(C) 2006 Simtec Electronics
Copyright 2004-2007 Freescale Semiconductor, Inc. All Rights Reserved.
Copyright (C) 2004 David S. Miller <davem@redhat.com>
Copyright (C) 1995, 1999 by Ralf Baechle
(c) 2000, 2001 Robert Baruch (autophile@starband.net);(c) 2004, 2005 Daniel Drake <dsd@gentoo.org>;(c) 2002 Alan Stern <stern@rowland.org>;(c) 2002 Thomas Kreiling <usbdev@sm04.de>
(c) Copyright 2002, 2003 Hewlett-Packard Development Company, L.P. Bjorn Helgaas <bjorn.helgaas@hp.com>
Copyright (C) 2008-2009 Jon Masters, Red Hat, Inc. <jcm@redhat.com>
Copyright (C) 2001 - 2012 Paul Mundt <lethal@linux-sh.org>
(c) Copyright 2008-2013 Datera, Inc.
Copyright 2015 Red Hat, Inc. and/or its affiliates.
Copyright © 2007 Dave Mueller
Copyright (C) 2016-2017 Texas Instruments Incorporated - http://www.ti.com/ Dave Gerlach
copyright 2005 Oracle except when otherwise noted.
Copyright (C) 2018 ROHM Semiconductors
Copyright (C) 1992, 1994 by Theodore Ts'o.
Copyright (C) 2002, 2003, 2006 David S. Miller (davem@davemloft.net)
Copyright (c) 2005 Vojtech Pavlik <vojtech@suse.cz>
Copyright (C) 1999, 2001 Hewlett-Packard Co Stephane Eranian <eranian@hpl.hp.com> David Mosberger <davidm@hpl.hp.com>
Copyright (C) 2010-2016 Freescale Semiconductor, Inc. All Rights Reserved.
Copyright (c) 2014-2017 Mentor Graphics Inc.
Copyright (c) 2009 Xilinx, Inc.
Copyright (C) 1998 Paul Mackerras & Ben. Herrenschmidt.
Copyright (c) 2001-2005 Edouard TISSERANT <edouard.tisserant@wanadoo.fr>
Copyright (C) 2000-2003 David McCullough <davidm@snapgear.com>
Copyright (C) 2014 David Gibson <david@gibson.dropbear.id.au>
Copyright (C) 2016 Boundary Devices, Inc.

LICENCE TERMS (cont.)

Copyright (C) ST-Ericsson AB 2012
Copyright (C) 2010 Elan Digital Systems Limited
Copyright (C) 2005 Mips Technologies, Inc
Copyright 2002-2005, Devicescape Software, Inc.
Copyright (c) by Jaroslav Kysela <perex@perex.cz>, Creative Labs, Inc. Definitions for EMU10K1 (SB Live!) chips
Copyright (c) Red Hat Inc.
Copyright (C) 2018 MediaTek Inc. Author: Sean Wang <sean.wang@mediatek.com> Zhiyong Tao <zhiyong.tao@mediatek.com> Hongzhou.Yang <hongzhou.yang@mediatek.com>
Copyright (C) 2007 Red Hat, Inc. Author: Michal Schmidt <mschmidt@redhat.com> Based on the FTP conntrack helper (net/netfilter/nf_conntrack_ftp.c);(C) 1999-2001 Paul 'Rusty' Russell;(C) 2002-2004 Netfilter Core Team <coreteam@netfilter.org>;(C) 2003,2004 USAGI/WIDE Project <http://www.linux-ipv6.org>;(C) 2003 Yasuyuki Kozakai @USAGI <yasuyuki.kozakai@toshiba.co.jp>
Copyright (C) 1999-2007 by Helge Deller <deller@gmx.de>
Copyright (c) 1996-2004 Russell King.
Copyright (C) 2011 Richard Cochran <richardcochran@gmail.com> */
Copyright (C) 1999-2003 Matthew Wilcox <willy@parisc-linux.org>
Copyright (C) 2005-2007 by Texas Instruments
Copyright (C) ST-Ericsson SA 2010-2013 Author: Rickard Andersson <rickard.andersson@stericsson.com> for ST-Ericsson. Author: Daniel Lezcano <daniel.lezcano@linaro.org> for Linaro. Author: Ulf Hansson <ulf.hansson@linaro.org> for Linaro.
Copyright (C) 2009 Wind River Systems Inc Implemented by fredrik.markstrom@gmail.com and ivarholmqvist@gmail.com
Copyright (c) 2013-2017, The Linux Foundation. All rights reserved.
Copyright (C) 2016-17 Renesas Electronics Corporation
Copyright © 2015 Google Inc.
Copyright 2009-2010, 2012 Freescale Semiconductor, Inc
Copyright (C) 2005 Red Hat, Inc., James Morris <jmorris@redhat.com>
Copyright 2008/2009 Benjamin Herrenschmidt, IBM Corp behh@kernel.crashing.org>
Copyright (C) 2005 Paolo 'Blaisorblade' Giarrusso <blaisorblade@yahoo.it>
Copyright (C) 2005 Michael Hund <mhund@ld-didactic.de>
COPYRIGHT (C) by L. Wassmann <LW@KARO-electronics.de>
Copyright (C) 1995-2009 Russell King;(C) Linus Torvalds
Copyright 2018 Marty E. Plummer <hanetzer@startmail.com>
Copyright (C) 2003-2007 Yoichi Yuasa <yuasa@linux-mips.org>
Copyright 2013 Linaro Ltd. Written by: David A. Long
Copyright (C) 1991, 1992, 1993, 1994, 1996, 1998, 2000, 2001, 2002, 2003 Free Software Foundation, Inc.
Copyright (c) 2017 Fuzhou Rockchip Electronics Co., Ltd.
Copyright (C) 1998-2001 Hewlett-Packard Co David Mosberger-Tang <davidm@hpl.hp.com> Stephane Eranian <eranian@hpl.hp.com>
Copyright (C) 2005-2006 Anthony Liguori <aliguori@us.ibm.com>
Copyright (C) 1996 Paul Gortmaker
Copyright (C) 2011 Texas Instruments Incorporated - http://www.ti.com/ Author: Archit Taneja <archit@ti.com>
Copyright (c) 2015, LGE Inc. All rights reserved.
Copyright (C) 1995-2009 Russell King
Copyright (c) 2016 Citrix Systems Inc.
Copyright (C) 2009 Wind River Systems, written by Ralf Baechle <ralf@linux-mips.org>
Copyright (c) 2009-2010 Samsung Electronics Co., Ltd. Pawel Osciak, <pawel@osciak.com> Marek Szyrowski, <m.szyrowski@samsung.com>
Copyright (C) 1996-2003 Russell King.
Copyright (C) 2004 Sean Young <sean@mess.org>
Copyright 2001 H. Peter Anvin - All Rights Reserved
Copyright (C) 2009 Theodore Kilgore <kilgota@auburn.edu>
Copyright (C) 2011 Texas Instruments Incorporated - http://www.ti.com/ Contact: Eduardo Valentin <eduardo.valentin@ti.com>
Copyright (C) 2003-2017 Cavium, Inc.
Copyright 2005-06 Tower Technologies
Copyright (c) 2009 Secret Lab Technologies, Ltd.

Copyright (c) 2005 Arnaldo Carvalho de Melo <acme@conectiva.com.br>
Copyright (C) 2004,2007,2008 IBM Corporation
Copyright (C) 2008 Texas Instruments, Inc. Rajendra Nayak <rnyak@ti.com>
Copyright (C) 2007-2008 Michal Simek <monstr@monstr.eu>
Copyright (C) 2005 John Williams <jwilliams@itee.uq.edu.au>
Copyright (c) 1996 University of Cambridge Computer Laboratory
(c) 1998-2002 Petr Vandrovec <vandrove@vc.cvut.cz>;(c) 1999-2002 Petr Vandrovec <vandrove@vc.cvut.cz>")
Copyright (C) 2006, Advanced Micro Devices, Inc.
Copyright (C) 2015 Technologic Systems
Copyright (C) 2009 Paul Fox <pgf@laptop.org>
Copyright (C) 2015 Anshuman Khandual, IBM Corporation.
Copyright(c) 2013 - 2014 Intel Corporation.
Copyright (C) 2017-2018 Advanced Micro Devices, Inc.
Copyright (C) 2008-2012 Freescale Semiconductor, Inc.
Copyright (C) 2015 Micro Crystal SA Alexandre Belloni <alexandre.belloni@bootlin.com>
Copyright 2009-2010 Pengutronix Uwe Kleine-Koenig <u.kleine-koenig@pengutronix.de>
Copyright (C) 2004-2005 Stelian Pop <stelian@popies.net>
Copyright (C) 2010 MIPS Technologies, Inc. Author: Deng-Cheng Zhu
Copyright (C) 1995-2006 Dell Inc.
Copyright (c) 2010, by Texas Instruments
Copyright (C) 2015 Andrea Merello <adnrea.merello@gmail.com>
(c) Martin Sperl <kernel@martin.sperl.org>
Copyright (c) 2016 MediaTek Inc. Author: Youlin.Pei <youlin.pei@mediatek.com>
Copyright (C) 2019 Chris Brandt
Copyright (C) 2006 Yoshinori Sato
Copyright (C) 2008 Imre Kaloz <kaloz@openwrt.org>
Copyright (C) 2010 NEC corporation
Copyright 2001-2006 MontaVista Software Inc.
Copyright(c) 2017-2019 Intel Corporation.
Copyright (C) 2016 Author: Ruslan Bilovol <ruslan.bilovol@gmail.com>
Copyright © 2014 Red Hat.
Copyright (c) 2006, Ian Campbell, XenSource Ltd.
Copyright (C) 2007, 2012 Texas Instruments, Inc.
Copyright(c) 2017 - 2019 Pensando Systems, Inc
Copyright (C) 2012 Sascha Hauer <kernel@pengutronix.de>
Copyright (C) 2014 Advanced Micro Devices, Inc.
Copyright (C) 2008 Freescale Semiconductor, Inc. All rights reserved. Dave Liu <daveliu@freescale.com>
Copyright (c) 2017, 2018 Oracle. All rights reserved.
Copyright (C) 2010-2011 Jean-Francois Moine (http://moinejf.free.fr)
Copyright (c) 2008 Mauro Carvalho Chehab <mchehab@kernel.org>
Copyright (C) 2015 Samsung Electronics Co.Ltd Authors: Hyungwon Hwang <human.hwang@samsung.com>
Copyright (C) 2017 James.Bottomley@HansenPartnership.com
Copyright (C) 2017 Cogent Embedded Inc.
Copyright (c) 2014 Samsung Electronics Co., Ltd. Author: Thomas Abraham <thomas.ab@samsung.com>
Copyright (C): 2016 Nicolai Stange Options
Copyright (c) 2008 Silicon Graphics, Inc. All Rights Reserved.
Copyright (C) 2013 Terry Lam <vtlam@google.com>
Copyright (C) 2012 Texas Instruments Incorporated - http://www.ti.com/
Copyright (C) 1997-2002 David A. Schleeef <ds@schleeef.org>
Copyright (C) 2017 Icenowy Zheng <icenowy@aosc.xyz>
Copyright (C) 2012-2013 Uwe Kleine-Koenig for Pengutronix
(C) 1999 Nicolas Pitre <nico@fluxnic.net>
Copyright (C) 2018 ARM Limited or its affiliates. All rights reserved.
Copyright (C) 2007, 2008 Eric Van Hensbergen, IBM Corporation
Copyright (c) 2018 Rockchip Electronics Co. Ltd. Author: Elaine Zhang <zhangqing@rock-chips.com>
Copyright (C) 2004 Embedded Edge, LLC
Copyright: (C) 2014 Himangi Saraogi.

LICENCE TERMS (cont.)

(C) 2001-2003 Bart De Schuymer <bdschuymer@pandora.be>
Copyright (C) 2013, 2014 Intel Corporation. All rights reserved.
Copyright (C) 2001-2003 Frank Mori Hess <fmhess@users.sourceforge.net>
Copyright (C) 2018 by Patrick Lerda <patrick9876@free.fr>
Copyright (c) 2010 Werner Fink, Jiri Slaby
Copyright (c) 2014-2016 Qualcomm Atheros, Inc.
Copyright (c) 1999 Martin Mares <mj@ucw.cz>
(C) 2012-2014 by sysmocom - s.f.m.c. GmbH;(C) 2016 by Pablo Neira Ayuso <pablo@netfilter.org>
Copyright © 2006 MontaVista Software Inc. Author: Vitaly Wool <vwool@ru.mvista.com>
Copyright (C) Andrew Tridgell 1992-2000
Copyright (c) 2003 ARM Limited All Rights Reserved
Copyright (C) 2013 STMicroelectronics (R&D) Limited. Author: Stuart Menefy <stuart.menefy@st.com> Author: Srinivas Kandagatla <srinivas.kandagatla@st.com>
Copyright (C) 2007 Red Hat, Inc., Ingo Molnar <mingo@redhat.com>
Copyright (c) 2010 Daniel Mack <daniel@caiaq.de>
Copyright (C) 2008-2009 Ben. Herrenschmidt (benh@kernel.crashing.org), IBM Corp.
Copyright (c) 2014-2015 Imagination Technologies Ltd.
Copyright (C) 2010 Pengutronix, Wolfram Sang <kernel@pengutronix.de>
Copyright (c) 2014, Intel Corporation. Qiaowei Ren <qiaowei.ren@intel.com> Dave Hansen <dave.hansen@intel.com>
Copyright (c) 2006 Rik Snel <rsnel@cube.dyndns.org>
Copyright 2009 Andy Green <andy@warmcat.com>
Copyright (C) 2009 Krzysztof Helt <krzysztof.h1@wp.pl>
Copyright IBM Corporation, 2012
Copyright (C) 2017 by Stefano Stabellini <stefano@aporeto.com>
Copyright (C) 2018 Intel Corp.
Copyright (C) 2018 Marek Vasut <marex@denx.de>
Copyright 2008 (C) Rodolfo Giometti <giometti@linux.it>
Copyright (c) 1994-98 by Jaroslav Kysela <perex@perex.cz>
Copyright (C) International Business Machines Corp., 2000,2005
Copyright (C) 2004 Anton Blanchard, IBM Corp. <anton@samba.org>
Copyright (C) 2002 Matthew Dharm <mdharm@momenco.com>
Copyright 2012 Philippe Retornaz, <philippe.retornaz@epfl.ch>
Copyright IBM Corp. 2019 Author(s): Hendrik Brueckner <brueckner@linux.vnet.ibm.com>
Copyright (C) 2009-2012 Jason Baron <jbaron@redhat.com>
Copyright (C) 2013 Texas Instruments Incorporated - http://www.ti.com Author: Sricharan R <r.sricharan@ti.com>
Copyright (c) 2018-2019 SiFive, Inc */
Copyright (C) IBM Corporation, 2004;(c) container_of(c, struct command, kref)
(c) Copyright 2010 Intel Corporation
Copyright (C) 2010-2014 Freescale Semiconductor, Inc.
Copyright 2007, Google Inc.
Copyright (C) Greg Lonnon 2001 Updated for OMAP-1610 by Tony Lindgren <tony@atomide.com>
Copyright (c) 2011, ARM Ltd.
Copyright (C) 1996 Mike Shaver (shaver@zeroknowledge.com)
(c) 2018 Eyal Birger <eyal.birger@gmail.com>
Copyright (c) 2014-2015, Intel Corporation.
Copyright (C) 2003 Advanced Micro Devices
Copyright(c) 1999 - 2018 Intel Corporation. */
Copyright 2007 Andy Green <andy@warmcat.com>
Copyright 2006 Pengutronix Sascha Hauer <s.hauer@pengutronix.de>
Copyright (C) 2017 Jason A. Donenfeld <Jason@zx2c4.com>. All Rights Reserved.
Copyright (C) 1999, 2000, 2001 Ingo Molnar, Red Hat
(C) 1997-1998 Caldera, Inc.:(C) 1998 James Banks;(C) 1999-2001 Torben Mathiasen;(C) 2002 Samuel Chessman
Copyright 2006 PMC-Sierra, Inc.
Copyright (c) 2001-2015 Anton Altaparmakov and Tuxera Inc.
Copyright (C) 2012 Michael Buesch <m@buesch>
Copyright 2009 Wolfson Microelectronics plc

Copyright 2015 Aleksei Mamlin Aleksei Mamlin <mamlinav@gmail.com>
Copyright (c) 2014 eGauge Systems LLC Contributed by David Mosberger-Tang <davidm@egaugenet>
Copyright IBM Corp. 2006, 2015 Author(s): Jan Glauber <jan.glauber@de.ibm.com> Harald Freudenberger <freude@de.ibm.com>
Copyright (C) 2007 MEV Ltd. <http://www.mev.co.uk/>
Copyright (c) 2014, Fuzhou Rockchip Electronics Co., Ltd Author: Addy Ke <addy.ke@rock-chips.com>
Copyright (c) 2005-2006 Hewlett-Packard Development Company, L.P. Contributed by Stephane Eranian <eranian@hpl.hp.com>
Copyright (c) 2003 IBM Corp. Dave Engebretsen engebret@us.ibm.com Santiago Leon santil@us.ibm.com
Copyright (C) 2010, Red Hat Inc.
Copyright (c) 2008, VIA Technologies Inc. All Rights Reserved.
Copyright (C) 2005-2008 Marcel Holtmann <marcel@holtmann.org>
Copyright (C) 1996,97,98 Ralph Metzler (rjkm@thp.uni-koeln.de) Marcus Metzler (mocm@thp.uni-koeln.de);(c) 1999-2003 Gerd Knorr <kraxel@bytexsec.org>;(c) 2005 Mauro Carvalho Chehab <mchehab@kernel.org> Multituner support and i2c address binding
Copyright (C) 2017 Oleh Kravchenko <oleg@kaa.org.ua>
Copyright (C) 1995 David S. Miller
Copyright (c) 2007, 2010 George Joseph <george.joseph@fairview5.com>
(c) Jan-Simon Müller (dl9pf@gmx.de)
Copyright (C) Samuel Thibault <samuel.thibault@ens-lyon.org>
Copyright (C) 2005-2006 Intel Corporation
Copyright (C) 1997,1998,1999 Free Software Foundation, Inc. Contributed by Richard Henderson (rth@cygnus.com), Jakub Jelinek (jj@ultra.linux.cz) and Peter Maydell (pmaydell@chiark.greenend.org.uk).
Copyright (C) 2010 Wang Lei. All Rights Reserved. Written by Wang Lei (wang840925@gmail.com)
Copyright (c) 2019, Linaro Limited
Copyright (C) 2006 (davem@davemloft.net)
Copyright (C) 1997, 1998, 1999 David S. Miller (davem@redhat.com)
Copyright 1999 Jeff Garzik <jgarzik@pobox.com>
Copyright (c) 2008-2014, The Linux foundation. All rights reserved.
Copyright: [copy] 2002-2011 Sentelic Corporation.
Copyright (C) 1994 - 2002 by Ralf Baechle
(c) Copyright 2006-2013 Datera, Inc.
Copyright (C) 2004 Psion Teklogix (for NetBook PRO)
Copyright (C) 2014,2015 Samsung Electronics Jaewon Kim <jaewon02.kim@samsung.com> Krzysztof Kozlowski <krzk@kernel.org>
(C) 2003-2004 by Harald Welte <laforge@netfilter.org> based on ideas of Fabio Olive Leite <olive@unixforge.org>
Copyright (c) 2005-2006 Hans de Goede <hdegoede@redhat.com>
Copyright (C) 1995, 96, 97, 98, 99, 2000, 01, 02 by Ralf Baechle
Copyright Benjamin Herrenschmidt & Gavin Shan, IBM Corporation 2011.
Copyright IBM Corp. 2017 Author(s): Harald Freudenberger <freude@de.ibm.com>
Copyright (C) 2004 Advanced Micro Devices
Copyright (c) 2016, ROCKCHIP CORPORATION. All rights reserved.
Copyright (C) 2013 Linaro Ltd.
Copyright (C) 2006 Red Hat, Inc. All rights reserved.
Copyright (C) 2010 the Speakup Team
Copyright (C) 2010 Nokia Corporation
Copyright (c) 2006 ARM Ltd.
Copyright 2013 Texas Instruments, Inc.
Copyright IBM Corp. 1999, 2000 Author(s): Martin Schwidefsky (schwidefsky@de.ibm.com), Denis Joseph Barrow (djbarrow@de.ibm.com,barrow_dj@yahoo.com)
(C) Copyright 2010, Greg Ungerer <gerg@snapgear.com>
(C) 2001 Marc Boucher (marc@mbsi.ca).
Copyright (C) 2003-2005 Dave Boutcher (boutcher@us.ibm.com) IBM Corp. Santiago Leon (santil@us.ibm.com) IBM Corp. Linda Xie (lxie@us.ibm.com) IBM Corp.
Copyright (c) 2006 Maciej W. Rozycki
Copyright 2013 Golden Delicious Computers Nikolaus Schaller <hns@goldelico.com>
Copyright 2011 Analog Devices Inc. Author: Lars-Peter Clausen <lars@metafoo.de>

LICENCE TERMS (cont.)

Copyright (C) 2015, Google, Inc., Paul Turner <pjt@google.com> and Andrew Hunter <ahh@google.com>
Copyright (c) 2010, Applied Micro Circuits Corporation Author: Tanmay Inamdar <tinamdar@apm.com>
"Copyright (C) 2014-2019 Renesas Electronics Inc.:(c) container_of(c, struct rcar_dmac_chan, chan)"
(C) Copyright 2004 Jon Smirl <jonsmirl@yahoo.com>;(C) Copyright 2004 Silicon Graphics, Inc. Jesse Barnes <jbarnes@sgi.com>
Copyright (c) 2010 Nikolai Kondrashov
Copyright © 2010 Intel Corporation
Copyright (C) 2008 Gabor Juhos <juhosg@openwrt.org>
Copyright (c) 2009 QLogic Corporation. All rights reserved.
Copyright (C) 1992 Theodore Ts'o
Copyright (C) 2000 Damjan Lampret
copyright 2000 by Hans Reiser
Copyright 2017 John Sperbeck
Copyright (C) 2004, 2009 Texas Instruments Incorporated Author: Aurelien Jacquot <aurelien.jacquot@jaluna.com>
Copyright (C) 2013-2014 Stephane Grosjean <s.grosjean@peak-system.com>
Copyright (c) 2015 Rafal Milecki <zajec5@gmail.com>
Copyright (C) 2000 Uros Bizjak <uros@kss-loka.si>
Copyright (C) 2011-2014 Freescale Semiconductor, Inc.
Copyright (C) 2008 Atsushi Nemoto <anemo@mba.ocn.ne.jp>
Copyright (C) 2010-2011, Tobias Klauser <tklauser@distanz.ch>
Copyright (C) 2008-2010 Nokia Corporation
Copyright 2015 Marcus Cooper
Copyright (C) 2003 Matjaz Breskvar <phoenix@bsemi.com>
Copyright (C) 1995,1996 David S. Miller (davem@caip.rutgers.edu)
Copyright 2015-2018 Socionext Inc. Author: Kunihiro Hayashi <hayashi.kunihiko@socionext.com>
Copyright (c) 2002-2005, K A Fraser
Copyright (C) 2005 Intel Corporation Venkatesh Pallipadi <venkatesh.pallipadi@intel.com>
Copyright(c) 2018 Linus Torvalds. All rights reserved.
Copyright (C) 1995, 1996, 2003 by Ralf Baechle
Copyright: (C) 2014 Himangi Saraogi. Comments: Options:
Copyright (c) 2015-2017 The Linux Foundation. All rights reserved.
Copyright (C) 2009-2011 Texas Instruments, Inc.
Copyright 2017 Olimex Ltd. Stefan Mavrodiev <stefan@olimex.com>
Copyright (C) 1997-1999 Richard Gooch
Copyright (C) 2007 Andrew Victor
Copyright (c) 2015-2016 MediaTek Inc. Author: Honghui Zhang <honghui.zhang@mediatek.com>
Copyright 2002-2009, 2011-2013 Freescale Semiconductor, Inc.
Copyright (C) 2018 Vasily Khoruzhick <anarsoul@gmail.com>
(C) 2008 Korolev Alexey <akorolev@infradead.org>;(C) 2008 Vasilii Leonenko <vasilii.leonenko@gmail.com>
Copyright (C) 1996, 1997 Olaf Kirch
Copyright (C) 1996 David Mosberger-Tang.
"Copyright 2007-2009 Johannes Berg <johannes@sipsolutions.net>"
(C) 1999-2001 Paul 'Rusty' Russell;(C) 2002-2004 Netfilter Core Team <coreteam@netfilter.org>;(C) 2002-2013 Jozsef Kadlecsik <kadlec@netfilter.org>;(C) 2006-2012 Patrick McHardy <kaber@trash.net>
Copyright (c) 2014-2015 Thomas Graf <tgraf@suug.ch>
Copyright (C) 2009, 2010 Paul Mundt
Copyright (c) by Levent Guendogdu <levon@feature-it.com>
Copyright (C) 2012 Advanced Micro Devices, Inc. Author: Joerg Roedel <jroedel@suse.de>
Copyright (C) 2014 Steffen Trumtrar <s.trumtrar@pengutronix.de>
Copyright (C) 2017 Matt Ranostay <matt@ranostay.consulting>
Copyright (C) 2011-2012 Vayavya Labs Pvt Ltd
Copyright (C) 2008 Red Hat Inc, Steven Rostedt <srostedt@redhat.com>
Copyright (C) 2007 PA Semi, Inc
Copyright (C) 2011 Gabor Juhos <juhosg@openwrt.org>
Copyright (c) 2011 - 2013 Tatsunosuke Tobita, Wacom. tobita.tatsunosuke@wacom.co.jp>
Copyright 2015 Freescale Semiconductor, Inc.
Copyright (C) 1992 Eric Youngdale Simulate a host adapter with 2 disks attached.

Copyright (C) 2014 Joachim Eastwood <manabian@gmail.com>
Copyright (C) 2016, Semihalf Author: Tomasz Nowicki <tn@semihalf.com>
Copyright 2015 Texas Instruments
Copyright (C) 2015 Broadcom Corporation Author: Florian Fainelli <f.fainelli@gmail.com>
Copyright 2009 Red Hat Inc. All Rights Reserved.
Copyright (c) 2001, 2002 by D-Link Corporation Written by Edward Peng.<edward_peng@dlink.com.tw> Created 03-May-2001, base on Linux' sundance.c.
Copyright (C) 2004-2010 Sage Weil <sage@newdream.net>
Copyright Altera Corporation (C) 2013-2014. All rights reserved
Copyright (C) 2018 Masahiro Yamada <yamada.masahiro@socionext.com>
Copyright (c) 1999 Dan Malek <dmalek@jlc.net>
Copyright (C) 2006 Storlink, Corp.
Copyright (c) 2010-2011, Jarod Wilson <jarod@redhat.com>
Copyright (C) 2006 Thumtronics Pty Ltd. Developed for Thumtronics by Grey Innovation Ben Williamson <ben.williamson@greyinnovation.com>
Copyright (C) 2015 Frank Rowand
Copyright (C) 1994-1999 Russell King Moved from linux/arch/arm/kernel/debug.S by Ben Dooks Modified for ASM9260 by Oleksij Remepl <linux@rempe-privat.de>
Copyright (C) 1992 - 1997, 1999 Silcon Graphics, Inc.
Copyright (C) 2012 Linaro Limited
Copyright (C) 2007-2008 Novell
Copyright (C) 1996, 1999, 2001 Ralf Baechle
Copyright (c) 2015,2016 Krzysztof Kozlowski
Copyright © 2008,2010 Intel Corporation
Copyright (C) 2014 Thomas Petazzoni
Copyright © 2015 Pengutronix, Markus Pargmann <mpa@pengutronix.de>
copyright Jamal Hadi Salim (2002-4)
Copyright (C) 2015 VanguardiaSur - www.vanguardiasur.com.ar
Copyright (C) 2003 - 2007 Tensilica Inc.
Copyright (C) 2012-2015 Freescale Semiconductor, Inc.
Copyright 1996 Roman Zippel
Copyright (C) 2003-2005 Nokia Corporation
Copyright (C) 1992,1993,1995,1997. E-mail billm@suburbia.net |
Copyright (c) 2015 Google, Inc.
Copyright (C) 2006 8D Technologies inc.
Copyright(c) 2013 OpenVPN Technologies, Inc. All rights reserved.
"Copyright (C) 1999-2000 Andre Hedrick <andre@linux-ide.org>"
Copyright (C) 2006 Tino Reichardt
Copyright (C) 2002 NetChip Technology, Inc. (http://www.netchip.com)
Copyright (C) 2006 Jonathan McDowell <noodles@earth.li>
Copyright (C) 1997 Russell King;(C) 2003 Simtec Electronics
Copyright (c) 2014 Finn Thain
Copyright (C) 2017, STMicroelectronics - All Rights Reserved Author(s): Arnaud Pouliquen <arnaud.pouliquen@st.com>.
Copyright 2019-2020 NXP Zhou Guoniu <guoniu.zhou@nxp.com>
Copyright (C) People who wrote linux/arch/i386/kernel/sys_i386.c
Copyright (C) 2015, Stephan Mueller <smueller@chronox.de>
Copyright (C) 2015 Thomas Meyer (thomas@m3y3r.de)
Copyright (c) 2004-2008 Chelsio, Inc. All rights reserved.
Copyright (c) 2011 Bastian Blank <waldi@debian.org>
Copyright (C) 2015, Hisilicon Ltd.
Copyright (C) 1995, 1996, Olaf Kirch <okir@monad.swb.de>
Copyright (C) 2016 Neil Armstrong <narmstrong@baylibre.com>
Copyright 2014 Panasonic Corporation
Copyright (c) 2016 MediaTek Inc. Author: Daniel Hsiao <daniel.hsiao@mediatek.com> Kai-Sean Yang <kai-sean.yang@mediatek.com> Tiffany Lin <tiffany.lin@mediatek.com>
Copyright (c) 2010 by Mauro Carvalho Chehab

LICENCE TERMS (cont.)

Copyright (C) 2009 by Bart Hartgers (bart.hartgers+ark3116@gmail.com) Original version:
(C) Copyright 2015 Intel Corporation
Copyright (c) 2003 Vojtech Pavlik <vojtech@suse.cz>
Copyright IBM Corp. 1999, 2007 Author(s): Ingo Adlung <adlung@de.ibm.com> Cornelia Huck <cornelia.huck@de.ibm.com> Arnd Bergmann <arndb@de.ibm.com> Peter Oberparleiter <peter.oberparleiter@de.ibm.com>
Copyright (C) 2003 Microtronix Datacom Ltd.
Copyright 2005-2014 Freescale Semiconductor, Inc.
Copyright (C) 1997 Martin von Löwis, Régis Duchesne
Copyright(c) 2002-2010 Exar Corp.
Copyright (C) 2004 Mark M. Hoffman <mhoffman@lightlink.com>
Copyright (C) 2018 Octavo Systems LLC - <http://www.octavosystems.com/>
Copyright 2011 Maxim Integrated Products
Copyright (C) 2010 Johan Hovold <jhovold@gmail.com>
Copyright (C) 2013 Texas Instruments Author: Tomi Valkeinen <tomi.valkeinen@ti.com> Archit Taneja <archit@ti.com>
Copyright (c) by Digital Equipment Corp.
Copyright (c) 2010, 2011, 2016 The Linux Foundation. All rights reserved.
Copyright [copy] 2010 Nokia Corporation
Copyright (C) 2018 Matt Ranostay <matt.ranostay@konsulko.com>
(C) Copyright 2016 Intel Corporation
Copyright (c) 2013, Intel Corporation
Copyright (C) 2014 Paradox Innovation Ltd.
Copyright (C) 2012 Altera <www.altera.com>
Copyright (c) 2012-2019 The Linux Foundation. All rights reserved.
Copyright (C) 2007 Michael Krufky (mkrufky@linuxtv.org)
(C) 2006 Red Hat <alan@lxorguk.ukuu.org.uk>
(c) Copyright Matthew Wilcox <willy@debian.org> 2001-2002
Copyright (c) 2017 Andreas Klingler <ak@it-klinger.de>
Copyright (C) 1999 Dan Block
Copyright IBM Corp. 2001, 2009 Author(s): Original CTC driver(s): Fritz Elfert (felfert@millenux.com) Dieter Wellerdiek (wel@de.ibm.com) Martin Schwidofsky (schwidofsky@de.ibm.com) Denis Joseph Barrow (barrow_dj@yahoo.com) Jochen Roehrig (roehrig@de.ibm.com) Cornelia Hu
Copyright 2004 ATI Technologies Inc.
Copyright (C) 1994 Roman Hodek
Copyright (c) 2010-2012 Broadcom. All rights reserved.
Copyright (C) 2004 Anil S Keshavamurthy (anil.s.keshavamurthy@intel.com)
Copyright (c) 2009-2014 Chelsio, Inc. All rights reserved.
Copyright 2006 Tungsten Graphics, Inc., Bismarck, ND., USA.
Copyright(c) 2009 - 2018 Intel Corporation.
Copyright (c) by Jaroslav Kysela <perex@perex.cz>, Thomas Sailer <sailer@ife.ee.ethz.ch>
Copyright (C) 2007, Red Hat, Inc.
Copyright (C) 2011 Richard Weinberger <richrd@nod.at>
(c) 2001-2002 Petr Vandrovec <vandrove@vc.cvut.cz>
Copyright (c) 2002-2003 Patrick Mochel <mochel@osdl.org>
Copyright (C) 1999-2005 Hewlett-Packard Co David Mosberger-Tang <davidm@hpl.hp.com>
Copyright 2015 Tyler Baker
Copyright (c) 1994-1997, 99, 2000, 06, 07 Ralf Baechle (ralf@linux-mips.org)
Copyright 2019 American Megatrends International LLC.
Copyright (C) 2007 Red Hat, Inc. All Rights Reserved.
Copyright (C) 2014 Chen-Yu Tsai Chen-Yu Tsai <wens@csie.org>
Copyright (C) 2001-2002 Convergence Integrated Media GmbH Holger Waechter <holger@convergence.de>
Copyright (c) 2013 Faraday Technology Corporation;(c) split iso entries.
Copyright (c) 2016 Andreas Klingler <ak@it-klinger.de>
Copyright (C) 2002 - 2007 Jeff Dike (jdike@{addtoit,linux,intel}.com)
Copyright IBM Corp. 2007 Author(s): Martin Schwidofsky (schwidofsky@de.ibm.com),
(c) 2000 Geert Uytterhoeven <geert@linux-m68k.org>;(c) 1999--2000 Martin Mares <mj@ucw.cz>
Copyright (c) 1997 Carnegie-Mellon University

Copyright (C) 1995 - 2000 by Ralf Baechle
(C) 2015 Pengutronix, Alexander Aring <aar@pengutronix.de>
Copyright(c) 2011 - 2012 Intel Corporation. All rights reserved.
Copyright (C) 2010 - 2013 Texas Instruments Incorporated. <http://www.ti.com/>
Copyright 2000 Deep Blue Solutions Ltd
Copyright (C) 2003 Roy Bulter <rbulter@hetnet.nl>
Copyright (C) 2019 NVIDIA Corporation. All rights reserved.
Copyright (c) 2001-2002 Denis Oliver Kropp <dok@directfb.org>;(c) 2001-2002 Denis Oliver Kropp <dok@convergence.de>;); MODULE_DESCRIPTION("FBDev driver for NeoMagic PCI Chips"); module_param(internal, bool, 0); MODULE_PARM_DESC(internal, "Enable output on internal LCD Display."); module_param(external, bool, 0); MODULE_PARM_DESC(external, "Enable output on external LCD Display.");
Copyright (C) 2013 Peter Hurley <peter@hurleyssoftware.com>
Copyright (C) 2003, 04, 05 Ralf Baechle (ralf@linux-mips.org)
Copyright 2020 NXP YAML 1.2
Copyright (C) 2005 XenSource Ltd
Copyright (C) 2001 Russell King, All Rights Reserved.:(C) Adam Belay.
Copyright (c) 2003-2014 QLogic Corporation QLogic Linux FC-FCoE Driver
(c) 2007, Joe Perches <joe@perches.com> created from checkpatch.pl
Copyright (C) 2005 Andriy Skulys
Copyright (C) 2011,2013,2014 Linaro Limited.
Copyright (c) 2014 Red Hat Inc.
Copyright (C) 2015 Google, Inc
Copyright: (C) 2014 Fabian Frederick.
Copyright (C) 2008 Dave S.r.l. <www.dave.eu>
Copyright(c) 2018 Jesper Dangaard Brouer.
Copyright (C) 2013 Bruno Randolf <br1@einfach.org>;(c) Copyright 2008 Wim Van Sebroeck <wim@iguana.be>.
Copyright 2012, 2014-2016 Freescale Semiconductor, Inc.
Copyright (c) 2016-2019 Mellanox Technologies. All rights reserved */
Copyright 2003 PathScale Inc
Copyright (c) 2018 Alexandre Belloni <alexandre.belloni@bootlin.com>
Copyright (C) 2005-2009 Rodolfo Giometti <giometti@linux.it>
Copyright (C) 2016 STMicroelectronics Author: Gabriel Fernandez for STMicroelectronics.
Copyright © International Business Machines Corp., 2006-2008
Copyright(c) 2015-17 Intel Corporation.
Copyright 2010 - 2015 Freescale Semiconductor Inc.
Copyright (C) 2008-2009 Nokia Corporation. All rights reserved.
(C) Copyright 1999, Moreton Bay Ventures Pty Ltd.:(C) Copyright 1999, Lineo (www.lineo.com)
Copyright (C) 2001 - 2013 Tensilica Inc.
Copyright (c) 2013, Intel Corporation. Len Brown <len.brown@intel.com>
"Copyright (C) 1999 Frodo Looijaard <frodol@dds.nl> Philip Edelbrock <phil@netroedge.com>"
Copyright (c) 2008 Jaya Kumar
Copyright (C) 2018 Jacopo Mondini <jacopo@jmondi.org>
Copyright © 2012 Red Hat
Copyright (C) 1991, 1992, 1995, 1999, 2000 Linus Torvalds
(c) Michael AK Tesch (tesch@cs.wisc.edu)
Copyright (C) 2007, 2017 Red Hat, Inc. All Rights Reserved. Written by David Howells (dhowells@redhat.com)
Copyright (C) 2019 Pengutronix, Marco Felsch <kernel@pengutronix.de>
Copyright (C) 2006 International Business Machines Corp. Author(s): Michael A. Halcrow <mahalcro@us.ibm.com>
Copyright (C) 2016 Sergej Ivanovich
Copyright (C) 2015-2016 Mentor Graphics
Copyright (c) 1997, 1998 Martin Mares <mj@atrey.karlin.mff.cuni.cz>
Copyright (C) 2009 Lemote Inc. Author: Wu Zhangjin, wuzhangjin@gmail.com
Copyright (C) 1999,2002,2003 David A. Schleeff <ds@schleeff.org>
Copyright (C) 2018, Google LLC.
Copyright (c) 2002 - 2004 Karsten Wiese
Copyright IBM Corp. 2017 Author(s): Hendrik Brueckner <brueckner@linux.vnet.ibm.com> Changed by: Ravi Bangoria <ravi.bangoria@linux.vnet.ibm.com> Changed by: Kim Phillips <kim.phillips@arm.com>

LICENCE TERMS (cont.)

Copyright: [copy] 2013, Intel Corporation
Copyright (c) 2016 HiSilicon Limited.
Copyright (C) 2015 Pengutronix, Uwe Kleine-König <kernel@pengutronix.de>
Copyright (C) 2017 - Cambridge Greys Limited
Copyright (C) 2017 Hisilicon Limited, All Rights Reserved. Author: Zhichang Yuan <yuanzhichang@hisilicon.com>
Author: Zou Rongrong <zourongrong@huawei.com> Author: John Garry <john.garry@huawei.com>
(c) Copyright 2002 Xilinx Inc., Systems Engineering Group;(c) Copyright 2004 Xilinx Inc., Systems Engineering Group;(c) Copyright 2007-2008 Xilinx Inc. All rights reserved.
Copyright (C) 1997-1998 Richard Gooch
Copyright (C) 2002 2003 by MontaVista Software.
Copyright (C) 1999 - 2010 Intel Corporation.
Copyright (C) 2009 IBM
Copyright 2005 Lab126, Inc.
Copyright (C) 2011 John Crispin <blogic@openwrt.org>
Copyright (C) 2007 Sony Computer Entertainment Inc.
Copyright (C) 2008 Peter Griffin <pgriffin@mpc-data.co.uk>
Copyright 2015 Vishnu Patekar
Copyright 2005/2006 Red Hat, all rights reserved.
Copyright 2006 Andi Kleen, SUSE Labs.
Copyright (C) 2004 Red Hat
Copyright (C) 2014 Marek Belisko <marek@goldelico.com>
Copyright (C) 2015 Markus Reichl
Copyright (c) 2016 Mellanox Technologies. All rights reserved.
Copyright (C) 2008-2014 Altera Corporation
"Copyright (C) 2002 MontaVista Software Inc. Author: Yoichi Yuasa <source@mvista.com>"
Copyright Red Hat, Inc. 2019
(C) 2007 Michel Benoit
Copyright 2007 Freescale Semiconductor, Inc.
Copyright (c) 2008 Magnus Damm
Copyright (C) 2011 Intel Corporation Author: Andrzej Zaborowski <balrogg@gmail.com>
Copyright (c) 2019 Alex Henrie <alexhenrie24@gmail.com>
© Copyright 1996 by Geert Uytterhoeven <geert@linux-m68k.org>
Copyright (C) 2008 Steven Toth <stoth@linuxtv.org>
Copyright (C) 2005 Broadcom Corporation
Copyright (C) 2012 Bill Pemberton (wfp5p@virginia.edu)
Copyright (C) 2013 ARM Ltd. Sudeep Karkadanagesha <sudeep.karkadanagesha@arm.com>
Copyright (C) 2002 Russell King.
Copyright (c) 2011, 2012 Anssi Hannula <anssi.hannula@iki.fi>
Copyright (c) 2003 Manuel Estrada Sainz
copyright (c) 2013 Freescale Semiconductor, Inc. Freescale IMX AHCI SATA platform driver
Copyright 2018 Arcx Inc
Copyright (C) 2011-2017 Red Hat, Inc.
Copyright (C) 2003 - 2008 Nokia Corporation
Copyright (c) 2006-2007 David Brownell
Copyright (C) 2006, 2009, 2010 Texas Instruments Incorporated Author: Aurelien Jacquot (aurelien.jacquot@jaluna.com)
Copyright (c) 2012 Gilles Dartiguelongue, Thomas Richter
Copyright (C) ST-Ericsson AB 2010 Author: Sjur Brendeland
Copyright (C) 2002-2005 Roman Zippel <zippel@linux-m68k.org>
Copyright (c) 2009-2013 Silicon Graphics, Inc. All Rights Reserved.
Copyright (C) 1996, 1997, 2000 David S. Miller (davem@redhat.com)
Copyright (C) 2008, 2010 Pengutronix
Copyright 2008-2014 Freescale Semiconductor, Inc. All Rights Reserved.
Copyright 2010, 2011 Mark Nelson and Tseng-Hui (Frank) Lin, IBM Corporation
(c) Copyright 2002, 2004 Hewlett-Packard Development Company, L.P. Khalid Aziz <khalid.aziz@hp.com> Bjorn Helgaas <bjorn.helgaas@hp.com>
Copyright (c) 2013, The Linux Foundation. All rights reserved.

© Copyright IBM Corporation 2006-2008
Copyright (C) 2008 Philip Balister, OpenSDR <philip@opensdr.com>
Copyright © 2014-2015 Red Hat, Inc. All Rights Reserved.
Copyright IBM Corp. 1999, 2006 Author(s): Denis Joseph Barrow (djbarrrow@de.ibm.com,barrow_dj@yahoo.com)
Copyright 2012 Sascha Hauer, Uwe Kleine-König, Steffen Trumtrar and Markus Pargmann, Pengutronix
Copyright (c) 2019 Isovalent, Inc.
Copyright (C) 2004, 2005 Stephen Hemminger <shemminger@osdl.org>
Copyright (c) 2014 Google, Inc.
Copyright (c) 2012, NVIDIA CORPORATION. All rights reserved.
"Copyright 2009 Luis R. Rodriguez <lrodriguez@atheros.com>"
Copyright (C) 1997-2011 AudioScience Inc. <support@audioscience.com>
Copyright (C) 2008 Nir Tzachar <nir.tzachar@gmail.com>
Copyright (C) 2011 Atmel, 2011 Nicolas Ferre <nicolas.ferre@atmel.com>, 2011 Jean-Christophe PLAGNIOL-VILLARD <plagnioj@jcrosoft.com>
Copyright (C) 2015 Shaohua Li <shli@fb.com>
Copyright (C) ST-Ericsson SA 2010
Copyright (C) 2004 Michel Lachine <mike@mikelachaine.ca>
Copyright 2010 IBM Corporation Author: K.Prasad <prasad@linux.vnet.ibm.com>
Copyright (C) Andrea Merello 2004 <andrea.merello@gmail.com>
Copyright (C) 2015 Prevas A/S
Copyright (C) 2001-2016 Miklos Szeredi <miklos@szeredi.hu>
Copyright (c) 2006 ATRON electronic GmbH Author: Jan Nikitenko <jan.nikitenko@gmail.com>
Copyright (C) 2015 Felix Fietkau <nbd@openwrt.org>
Copyright (C) 1998 Olivier A. D. Lebaillif
Copyright (c) 2013 Tomasz Figa <tomasz.figa@gmail.com>
(c) Copyright 2003, 2006 Hewlett-Packard Development Company, L.P. Alex Williamson <alex.williamson@hp.com>
Bjorn Helgaas <bjorn.helgaas@hp.com>
Copyright 2017 - Patrice Chotard <patrice.chotard@st.com>
Copyright IBM Corp. 2011 Author(s): Michael Holzheu <holzheu@linux.vnet.ibm.com>
Copyright (c) 1998-1999 Andrzej Krzysztofowicz, Author and Maintainer
Copyright (C) 2000, 2001, 2002 by Ralf Baechle
Copyright (C) 2019 Micro Crystal SA
Copyright (C) 2002 KOBIL Systems GmbH Author: Thomas Wahrenbruch
Copyright 2012 Calxeda, Inc.
Copyright (c) 2012 Samsung Electronics Co., Ltd. Author: Inki Dae <inki.dae@samsung.com>
Copyright 2014, Hauke Mehrtens <hauke@hauke-m.de>
Copyright (c) 2002, 2007 Red Hat, Inc. All rights reserved.
Copyright (c) 2002 by David S. Miller <davem@redhat.com>
Copyright (c) by Jaroslav Kysela <perex@perex.cz> Universal interface for Audio Codec '97
Copyright (C) 1996-2000 Thomas Sailer (sailer@ife.ee.ethz.ch);(C) 1996-2000 Thomas Sailer
Copyright (C) 2004-2005 Nokia Corporation Author: Juha Yrjölä <juha.yrjola@nokia.com>
Copyright (C) 1996, 1998, 1999, 2002 by Ralf Baechle
Copyright 2005,2008 Freescale Semiconductor Inc.
Copyright (c) 2016-2017, The Linux Foundation. All rights reserved.
Copyright (C) 2000,2002 Stephen Rothwell
Copyright (c) 2007 MontaVista Software, Inc.
Copyright (C) 2003, 2006 David S. Miller (davem@davemloft.net)
Copyright (c) 2013, NVIDIA CORPORATION. All rights reserved.
Copyright (c) 1998-2007 InnoSys Incorporated. All Rights Reserved
Copyright (C) 2008 Sascha Hauer, Pengutronix <s.hauer@pengutronix.de>
Copyright (c) by AudioScience Inc <support@audioscience.com>
Copyright IBM Corp. 2001, 2012 Author(s): Robert Burroughs Eric Rossman (edrossma@us.ibm.com)
Copyright (C) 2010-2012 Texas Instruments Incorporated - http://www.ti.com/ Nishanth Menon Kevin Hilman Thara Gopinath
Copyright (C) 2015-2017 Texas Instruments Incorporated - http://www.ti.com/ Andrew F. Davis <afd@ti.com>
Copyright: 2017-2018 Cadence Design Systems, Inc.
Copyright (C) Ian Molton <spyro@f2s.com>

LICENCE TERMS (cont.)

Copyright (c) 2019 Hammerspace Inc
(c) 2006 Benjamin Herrenschmidt <benh@kernel.crashing.org>, IBM Corp.
Copyright (C) 1996, 2006, 2008 David S. Miller (davem@davemloft.net)
Copyright (C) 1991, 1992, 1996 Linus Torvalds Hacked together by Andi Kleen
Copyright (C) 2014-2015 Freescale Semiconductor, Inc.
Copyright (c) 2016-2018 Nuvoton Technology corporation.
Copyright (c) 2008 Peter Popovec
Copyright (c) 2014-2018 MediaTek Inc.
Copyright (C) 2005-2007 Michael Buesch <m@bues.ch>
Copyright (C) 1995-1999 Russell King
Copyright (C) 2010 ST Microelectronics. Deepak Sikri<deepak.sikri@st.com>
Copyright (C) 2013, 2014 ARM Limited, All Rights Reserved. Author: Marc Zyngier <marc.zyngier@arm.com>
Copyright (C) 2000 Jens Axboe <axboe@suse.de>
Copyright 2016 ZTE Corporation.
Copyright (C) 2004, 2005, 2006 Red Hat, Inc., Ingo Molnar <mingo@redhat.com>
Copyright(c) 2004 Intel Corporation. All rights reserved.
Copyright (C) 2002 Sam Creasey <sammy@sammy.net>
Copyright (C) 2003-2005 Yoichi Yuasa <yuasa@linux-mips.org>
Copyright (C) 2006 Matthew Wilcox <matthew@wil.cx>
Copyright (c) 2013-2014, Intel Corporation. All rights reserved. Intel Management Engine Interface (Intel MEI) Linux driver
Copyright (C) 2017-2019 Broadcom. All Rights Reserved.
Copyright (C) 2017-2018 Netronome Systems, Inc.
Copyright (c) 2015 Texas Instruments Incorporated - http://www.ti.com
Copyright (c) 2015-2016 Herbert Xu <herbert@gondor.apana.org.au>
Copyright (C) 2011 René Bolldorf <xsecute@googlemail.com>
Copyright (C) 2003 Broadcom Corporation
"Copyright (C) 2003 Ralf Baechle 6/2004 pf"
Copyright © 2013-2014 Jussi Kivilinna <jussi.kivilinna@iki.fi>
Copyright (C) 1997, 2008 David S. Miller (davem@davemloft.net)
Copyright (c) 2007-2011, Intel Corporation. All Rights Reserved.
Copyright Red Hat Inc 2010.
Copyright 1999-2000 by Mitchell Blank Jr */ Based on clip.c
Copyright (C) 2014, Intel Corporation Author: Lv Zheng <lv.zheng@intel.com>
(c) Rebel.COM, 1998;(c) 1998, 1999 Philip Blundell
Copyright (C) 2000-2018, VMware, Inc. All Rights Reserved.
Copyright (C) 2016 Synopsys Jose Abreu <joabreu@synopsys.com>
Copyright (c) by Jaroslav Kysela <perex@perex.cz>, Abramo Bagnara <abramo@alsa-project.org>
Copyright (C) 2012-2014 LSI Corporation mailto:DL-MPTFusionLinux@lsi.com
Copyright (C) 2004, Kyle McMartin <kyle@parisc-linux.org>
(c) the try lock" flag is set. A blocking request covers all the other lock requests.
Copyright (c) 2014 Martyn Welch
Copyright (c) 2015-2019 Intel Corporation
Copyright (C) 2018 Cambridge Greys Ltd
Copyright (C) 2007-2015 Imagination Technologies Ltd
Copyright (C) 2016-17 Intel Corp
(c) MontaVista Software, Inc.:(c) Secret Lab Technologies, Ltd.:(c) Xilinx Inc.
Copyright 2012-2014 VMware, Inc., Palo Alto, CA., USA
Copyright (C) 1998 Daniel Pirkl <daniel.pirkl@email.cz> Charles University, Faculty of Mathematics and Physics
Copyright 2019 HabanaLabs, Ltd. All Rights Reserved.
Copyright 2014-2016 IBM Corp.
Copyright (C) 2016 Marvell
Copyright (C) 1996 Paul H. Hargrove;(C) 2003 Ardis Technologies <roman@ardistech.com>
(c) cable in the chipselect.
Copyright (C) 1995-1997 Simon G. Vogl 1998-2000 Hans Berglund
Copyright (C) 2007 Atsushi Nemoto <anemo@mba.ocn.ne.jp>
Copyright (C) 2014 Atmel, 2014 Free Electrons
(C) Copyright 1999-2003, Greg Ungerer (gerg@snapgear.com);(C) Copyright 2000, Lineo Inc. (www.lineo.com)
Copyright (C) 2003-2004 Oleksij Rempel <bug-track@fisher-privat.net> Jean Delvare <jdelvare@suse.de>
Copyright (C) 2019 Texas Instruments Author: Bartosz Golaszewski <bgolaszewski@baylibre.com> with tiny parts adopted from code by Kevin Hilman <khilman@baylibre.com>
(c) 1996 Grant R. Guenther grant@torque.net David Campbell
Copyright IBM Corporation, 2007 Author Balbir Singh <balbir@linux.vnet.ibm.com>
Copyright (C) 2008 Florian Fainelli <florian@openwrt.org>
Copyright 2009-2014 Intel Corporation; author H. Peter Anvin
Copyright NXP 2020
Copyright 2015 - Marcus Cooper <codekipper@gmail.com>
Copyright 2008 Red Hat Inc.
(C) 2005 by Harald Welte <laforge@netfilter.org>;(C) 2007 by Patrick McHardy <kaber@trash.net>;(C) 2000-2002 James Morris <jmorris@intercode.com.au>;(C) 2003-2005 Netfilter Core Team <coreteam@netfilter.org>
Copyright (C) 2014, 2015 Synopsys, Inc. (www.synopsys.com)
Copyright (C) 2002-2005 Emmanuel Pacaud <emmanuel.pcaud@univ-poitiers.fr>
Copyright (C) 2001-2002 Inventel Systemes Written 2001-2002 by
Copyright (C) 2015, Intel Corp. Author: Kan Liang (kan.liang@intel.com)
Copyright (C) 2010-2014 Xilinx, Inc. All rights reserved.
Copyright (C) 2013 ARM Limited
Copyright 2006-12 Wolfson Microelectronics PLC. Author: Liam Girdwood <lrg@slimlogic.co.uk>
Copyright (C) 1999 VA Linux Systems
Copyright (C) 2001-2002 Inventel Systemes Written 2001-2002 by David Libault <david.libault@inventel.fr>
Copyright (C) 2016 Free Electrons Quentin Schulz <quentin.schulz@free-electrons.com>
Copyright 2009-2010, Intel Corporation and its suppliers.
Copyright (C) 2009-2010 Texas Instruments, Inc.
Copyright (c) 2016 Herbert Xu <herbert@gondor.apana.org.au>
Copyright (C) 1999 David A. Hinds -- dahinds@users.sourceforge.net
Copyright (C) 1999-2001 Hewlett-Packard Co David Mosberger <davidm@hpl.hp.com>
Copyright 2011-2015 IBM Corp.
Copyright (C) Shailabh Nagar, IBM Corp. 2005
Copyright 2005 MontaVista Software, Inc. Matt Porter <mporter@kernel.crashing.org>
Copyright 1998 by Franco Venturi.
Copyright (C) 1992, 1993, 1994 Rick Sladkey
Copyright (c) 2017 Lucas Stach, Pengutronix
Copyright (C) 2007 Freescale Semiconductor, Inc. Author: Li Yang
Copyright (C) 2015 Samsung Electronics
Copyright (C) 2000 Takashi YOSHII
(C) 2003 Dave Jones on behalf of SuSE Labs.
Copyright (C) 2008 Oracle. All rights reserved.
Copyright (c) 2016 MediaTek Inc. Author: Jungchang Tsao <jungchang.tsao@mediatek.com> PC Chen <pc.chen@mediatek.com>
Copyright IBM Corp. 2018
Copyright (c) 2013 Samsung Electronics Co., Ltd http://www.samsung.com
Copyright (C) 1996, 1998, 1999, 2002, 2003, 2006, 2008 David S. Miller (davem@davemloft.net)
Copyright (C) 1994, 1995, 1996, 1999, 2000 by Ralf Baechle
Copyright (c) 2008 Lev Babiev based on hid-cherry driver
Copyright (C) 2004 Roelf Diedericks <roelfd@inet.co.za>
Copyright 2000,2001 The Linux Kernel Team
Copyright (C) 2004, 2013 Intel Corporation Author: Naveen B S <naveen.b.s@intel.com> Author: Rafael J. Wysocki <rafael.j.wysocki@intel.com>
Copyright (C) 2000-2005 by David Brownell <dbrownell@users.sourceforge.net>
Copyright (C) 2007 Eurek srl Author: Claudio Lanconelli <lanconelli.claudio@eptar.com> based on enc28j60.c written by David Anders for 2.4 kernel version
Copyright (C) 2012 John Crispin <john@phrozen.org>
Copyright (C) 2009 SUSE Linux Products GmbH
Copyright (C) 2000-2005 by David Brownell
Copyright (c) 2005 Mauro Carvalho Chehab <mchehab@kernel.org>

LICENCE TERMS (cont.)

Copyright (C) 2007,2008 Freescale Semiconductor Inc. Original port from 52xx driver: Hongjun Chen <hong-jun.chen@freescale.com>
Copyright(c) 2012 Intel Corporation. All rights reserved.
Copyright (c) 2000 Silicon Graphics, Inc. All rights reserved.
Copyright 2014-2016 Analog Devices Inc. Author: Paul Cercueil <paul.cercueil@analog.com>
Copyright (c) 2001-2007 Helge Deller <deller@gmx.de> All rights reserved.
Copyright (c) 2012-2015, NVIDIA CORPORATION. All rights reserved.
Copyright (C) 2005-2007 Samsung Electronics Kyungmin Park <kyungmin.park@samsung.com>
Copyright (c) 2016 MediaTek Inc. Author: Zhiyong Tao <zhiyong.tao@mediatek.com>
Copyright (C) 2012 Matthias Kaehlcke Author: Matthias Kaehlcke <matthias@kaehlcke.net>
Copyright (c) 2006 Herbert Valerio Riedel <hvr@gnu.org>
Copyright (C) 2012-2014, Raydium Semiconductor Corporation.
Copyright © 2006-2008 Florian Fainelli <florian@openwrt.org> Mike Albon <malbon@openwrt.org>
(c) Copyright 2007 Hewlett-Packard Development Company, L.P. Contributed by Peter Keilty <peter.keilty@hp.com>
Copyright (C) 2017 Topic Embedded Products Author: Mike Looijmans <mike.looijmans@topic.nl>
Copyright 2003-2009 Red Hat, Inc.
Copyright (C) 2009 - 2010 Samsung Electronics Co.Ltd Author: Joonyoung Shim <jy0922.shim@samsung.com>
Author: HeungJun Kim <riferful.kim@samsung.com>
Copyright (C) 1995 David S. Miller (davem@davemloft.net)
Copyright 2012 bct electronic GmbH
Copyright (c) 2010 Wolfson Microelectronics plc Author: Mark Brown <broonie@opensource.wolfsonmicro.com>
Copyright (c) 2012 David Herrmann
Copyright (c) 2014 Pablo Neira Ayuso <pablo@netfilter.org>
Copyright (C) 1997, 1998, 1999, 2003, 2008 David S. Miller (davem@davemloft.net)
Copyright 2012-2016 VMware, Inc., Palo Alto, CA., USA
Copyright (C) 2002 Hewlett-Packard Co David Mosberger <davidm@hpl.hp.com>
Copyright (c) 2009 Jonathan Cameron <jic23@kernel.org>
Copyright 2017, Michael Ellerman, IBM Corp.
Copyright (C) 2011-2015 Freescale Semiconductor, Inc. Author: Zhang Jiejing <jiejing.zhang@freescale.com>
Copyright (C) 2006 Loping Dog Embedded Systems
Copyright (c) 2003, 2004 Zultys Technologies. Eugene Surovegin <eugene.surovegin@zultys.com> or <ebs@ebshome.net>
Copyright (C) 2011 Texas Instruments Incorporated - <http://www.ti.com>
Copyright (C) 2018 Canonical Ltd.
Copyright 2014 Emilio López <emilio@elopez.com.ar>
Copyright (C) 2003 Ethan Benson <erbenson@alaska.net> partially derived from linux/fs/ext2/iocli.c
Copyright (c) 2000 Eric Brower (ebrower@usa.net)
Copyright (c) 2003 ARM Limited
Copyright (C) 2016 Rafał Milecki <rafal@milecki.pl>
Copyright (C) 2011 Carsten Emde <C.Emde@osadl.org>
Copyright (C) 1991, 1992, 1993, 1994 Linus Torvalds Swap reorganised 29.12.95, Stephen Tweedie Support of BIGMEM added by Gerhard Wichert, Siemens AG, July 1999 Reshaped it to be a zoned allocator, Ingo Molnar, Red Hat, 1999 Discontiguous memory support, Kanoj Sarcar, SGI, Nov 1999
Copyright 2014-2015 Yoshinori Sato <ysato@users.sourceforge.jp>
Copyright (C) 2014 Simon Guinot <simon.guinot@sequanux.org>
Copyright 2018 Google LLC. Tomasz Figa <tfiga@chromium.org>
Copyright 2010 Dariusz Augulis <augulis.darius@gmail.com>
Copyright (C) 1992 Linus Torvalds Adapted from arch/i386 by Gary Thomas
"Copyright (C) 2014 Texas Instruments Incorporated Authors: Sandeep Nair <sandeep_n@ti.com> Sandeep Paulraj <s-paulraj@ti.com> Cyril Chemparathy <cyril@ti.com> Santosh Shilimkar <santosh.shilimkar@ti.com> Wingman Kwok <w-kwok2@ti.com>"
Copyright(c) 2018 Broadcom
Copyright (C) 2005 ScaleMP Inc.
Copyright (C) 2010-2013 Johan Hovold (jhovold@gmail.com)
Copyright: (C) 2016 Andrew F. Davis <afd@ti.com>
Copyright(C) 1995 David S. Miller (davem@caip.rutgers.edu)
Copyright 1998-2002 by Jes Sorensen, <jes@trained-monkey.org>.

Copyright (C) 2001 Randolph Chung <tausq@debian.org> Significantly tweaked by LaMont Jones <lamont@debian.org>
Copyright (c) 2006 Ralf Baechle (ralf@linux-mips.org)
(C) 1998-2004 Ben Fennema;(C) 1999-2000 Stelias Computing Inc
Copyright (C) 1998, 99, 2000, 01, 2002 Ralf Baechle (ralf@gnu.org)
Copyright 2011 Analog Devices Inc (from AD7923 Driver)
Copyright (c) 1994 John Aycock The University of Calgary Department of Computer Science.
Copyright (C) 2010 GUAN Xue-tao
Copyright (C) 2010 Samsung Electronics Co., Ltd.
Copyright (C) 1998-2001 Hewlett-Packard Co
Copyright (C) 2006 Intel Corporation
Copyright 2009-2010 Intel Corp. Author: Huang Ying <ying.huang@intel.com>
Copyright (C) 2006 Coentini LABBE <clabbe.montjoie@gmail.com>
Copyright (C) 2014-2015 Pengutronix, Markus Pargmann <mpa@pengutronix.de> Based on driver from 2011: Juergen Beisert, Pengutronix <kernel@pengutronix.de>
Copyright (C) 2013 GnuBIO Inc
Copyright (C) 2015 Atmel Corporation.
Copyright (c) 2017, NVIDIA CORPORATION. All rights reserved
Copyright (C) 2010 Tony Prisk
(C) 2003 zecke@handhelds.org
Copyright 2019, Nick Pigginn, Gautham R. Shenoy, Aneesh Kumar K.V, IBM Corp.
Copyright IBM Corporation, 2006-2007
Copyright (C) 1999 Intel Corporation.
"Copyright (C) International Business Machines Corp., 2000-2004;(c) UniStrupr((c)->name)"
Copyright (c) 2007 Citrix Systems, Inc.
Copyright (c) 2010 by Herton Ronaldo Krzesinski <herton@mandriva.com.br>
Copyright (c) 2017 Advanced Micro Devices, Inc. All Rights Reserved.
Copyright 2008 (c) Frederic Weisbecker <fweisbec@gmail.com>
Copyright (c) 2006 Simtec Electronics Vincent Sanders <vince@simtec.co.uk> Ben Dooks <ben@simtec.co.uk>
Copyright 2009 - 2015 Freescale Semiconductor Inc.
Copyright (C) 2014 Lemote Corporation. written by Huacai Chen <chenhc@lemote.com>
Copyright IBM Corp. 2010, 2017 Author(s): Heiko Carstens <heiko.carstens@de.ibm.com>, Hendrik Brueckner <brueckner@linux.vnet.ibm.com>
Copyright (C) 2008 Jason Baron <jbaron@redhat.com> By Greg Banks <gnb@melbourne.sgi.com>
Copyright 2007 IBM Corp. Josh Boyer <jwboyer@linux.vnet.ibm.com>
Copyright (C) 1995-97 Simon G. Vogl
Copyright (C) 2014, Xsens Technologies BV <info@xsens.com>
Copyright (c) 2013-2016, Intel Corporation.
Copyright (c) by Takashi Iwai <tiwai@suse.de> Jaroslav Kysela <perex@perex.cz>
Copyright (C) 2008 Hans de Goede <hdegoede@redhat.com>
Copyright (C) 2018 EPAM Systems Inc.
(C) 2002 by Brian J. Murrell <netfilter@interlinx.bc.ca>
Copyright (C) 2010-2016 Freescale Semiconductor, Inc.
Copyright (c) 2005, Intel Corporation.
(C) 2004 Paul Serice
Copyright(C) 2011 Linaro Limited. All rights reserved.
Copyright (C) 2015-2018 Bosch Sicherheitssysteme GmbH
Copyright (C) 2017 Priit Laes <plaes@plaes.org>
Copyright (c) 2014 Echo360 <http://www.echo360.com> Scott Kanowitz <skanowitz@echo360.com> <scott.kanowitz@gmail.com>
Copyright (C) 2008,2009 STMicroelectronics
Copyright (C) 2001,2005 IBM Corporation.
Copyright 2010 Sascha Hauer, Pengutronix <s.hauer@pengutronix.de>
"Copyright (C) 2001-2005 Tensilica Inc. Authors Christian Zankel, Joe Taylor"
Copyright (C) 1995-2000 Russell King;(c) 1995-2000 R.M.King v1.17
Copyright (c) 2012 Alexey Klimov <klimov.linux@gmail.com>
Copyright (C) 2007 Michel Ludwig <michel.ludwig@gmail.com>

LICENCE TERMS (cont.)

Copyright 2008 Stuart Bennett
Copyright (C) 2006-2008 Freescale Semiconductor, Inc. All rights reserved.
Copyright (C) 2018, Microsoft Corporation.
Copyright (C) 2007-2009 Nokia Corporation
Copyright (C) 2008 Sylvér Bruneau <sylvér.bruneau@gmail.com>
Copyright (C) Barak A. Pearlmutter.
Copyright (c) 2007 Shin-ya Okada sh_okada(at)d4.dion.ne.jp
Copyright (C) 2017, EETS GmbH, Felix Brack <fb@ltec.ch>
Copyright (c) 2006, 2007 IBM Corp. Benjamin Herrenscheidt <benh@kernel.crashing.org>
Copyright (c) 2018, 2019 Oracle. All rights reserved.
Copyright (C) 2009 Lemote Inc. Author: Wu Zhangjin <wuzhangjin@gmail.com>
Copyright (C) 2002 Yoshinori Sato <ysato@users.sourceforge.jp>,
Copyright 2003 OProfile authors remark Read the file COPYING
Copyright 2010 Marvell Zhangfei Gao <zhangfei.gao@marvell.com>
Copyright(C) MontaVista Software Inc, 2006
Copyright (c) 1999 Al Smith;(c) 1995,1996 Christian Vogelgsang.:(c) 1988 Silicon Graphics;(c) 1999 Al Smith <Al.Smith@aeschi.ch.ethz.ch>;
Copyright (C) 2014 Topic Embedded Systems
Copyright (C) 2017 Heiner Kallweit
Copyright (C) 2001 Peter Bergner, IBM Corp.
Copyright (c) Herbert Valerio Riedel <hvr@hvr-lab.org>
Copyright (C) 2003-2014 Chelsio Communications. All rights reserved.
Copyright (C) 2000 Atom Create Engineering Co., Ltd.
Copyright 2003-2005 Red Hat Inc
Copyright (c) 2007 Simtec Electronics Ben Dooks <ben@simtec.co.uk> <http://armlinux.simtec.co.uk/>
Copyright (c) 2005,2006 Option Wireless Sweden AB
Copyright (C) 2005-2011 Laurent Pinchart (laurent.pinchart@ideasonboard.com)
Copyright (C) 2003 - 2007 Jeff Dike (jdike@{addtoit,linux.intel}.com)
Copyright (c) 2004 Matthew Wilcox
Copyright (C) 2006 Alain <alain@knaff.lu >
Copyright (c) 2013-2016, Intel Corporation. All rights reserved.
Copyright (C) 2016 Anton Ivanov (aivanov@brocade.com)
Copyright (c) 2010-2011 Jeremy Kerr <jeremy.kerr@canonical.com>
Copyright (C) 2016 Imagination Technologies Author: Marcin Nowakowski <marcin.nowakowski@mips.com>
(c) 1997 Martin Mares <mj@atrey.karlin.mff.cuni.cz> based on ideas by Pavel Machek <pavel@atrey.karlin.mff.cuni.cz>
Copyright 1994, Linus Torvalds.
Copyright (C) 2012 IBM Corporation
(c) Copyright 2000 Red Hat Software;(c) Copyright 2000 Helge Deller <hdeller@redhat.com>;(c) Copyright 2001-2009 Helge Deller <deller@gmx.de>;(c) Copyright 2001 Randolph Chung <tausq@debian.org>
(C) Copyright 2009, Greg Ungerer <gerg@uclinux.org>
Copyright (C) 2016-2018 Cirrus Logic, Inc. and Cirrus Logic International Semiconductor Ltd.
Copyright (c) 2012-2014, The Linux Foundation. All rights reserved.
Copyright 2016-2017 Advanced Micro Devices, Inc.
Copyright (C) 1991,1992 Linus Torvalds
"(c) Copyright 2001 Red Hat Inc. <alan@redhat.com>"
Copyright (C) 2002 MontaVista Software Inc. Author: Jun Sun, jsun@mvista.com or jsun@junsun.net
Copyright (C) 2015 IT University of Copenhagen. All rights reserved. Initial release: Matias Bjorling <m@bjorling.me>
Copyright (C) 2011 NXP Semiconductors
Copyright (c) 2017 excecet electronics GmbH
Copyright (C) 2015 Gridpoint Author: Jon Ringle <jringle@gridpoint.com>
Copyright(c) 2008-2010 Intel Corporation. All rights reserved.
Copyright (C) 2004 MontaVista Software, Inc.
Copyright (C) 2004 - 2005, 2009-2010 Nokia Corporation Written by Tuukka Tikkanen <tuukka.tikkanen@elektrobit.com>
Copyright 2010-2011 GE Intelligent Platforms Embedded Systems, Inc.
Copyright (C) 2018 Russell King, Deep Blue Solutions Ltd.

Copyright 2016 Heiner Kallweit <hkallweit1@gmail.com>
Copyright (C) 2005-2008 Intel Co. Fenghua Yu <fenghua.yu@intel.com> Bibo Mao <bibo.mao@intel.com>
Chandramouli Narayanan <mouli@linux.intel.com> Huang Ying <ying.huang@intel.com>
Copyright (C) 2009 Theodore Kilgore
Copyright (c), 2005-2008 Siano Mobile Silicon, Inc.
Copyright(c) 2018 Intel Corporation
Copyright (c) 2016 MediaTek Inc. Author: Jungchang Tsao <jungchang.tsao@mediatek.com> Daniel Hsiao <daniel.hsiao@mediatek.com> PoChun Lin <pochun.lin@mediatek.com>
Copyright (C) 1999-2006 Helge Deller <deller@gmx.de>
Copyright (c) 2018 Macronix
Copyright (c) 2003, 2004 Damien Bergamini <damien.bergamini@free.fr>. All rights reserved.
Copyright 2012-2016 Freescale Semiconductor, Inc.
Copyright (C) 2005 Marc Kleine-Budde, Pengutronix
Copyright (C) 2000-2006 Tigran Aivazian <aivazian.tigran@gmail.com> 2006 Shaohua Li <shaohua.li@intel.com>
(C) 1992, 1993 Eric Youngdale
(c) 2006 Edgar Hucek <gimli@dark-green.com>
Copyright (C) 2015, He Kuang <hekuang@huawei.com>
Copyright (C) 2009 Fujitsu Limited.
Copyright 2007 Benjamin Herrenscheidt, IBM Corp benh@kernel.crashing.org
Copyright (C) 1997 | W. Metzenthien, E-mail billm@jacobi.maths.monash.edu.au |
Copyright (C) 1999 Don Dugger <don.dugger@intel.com>
Copyright (c) 2005-2006 Varma Electronics Oy
Copyright (C) 2014 Yunzhi Li <lyz@rock-chips.com>
Copyright (C) 2010 Hans de Goede <hdegoede@redhat.com>;(C) Copyright 1999 Johannes Erdelt;(C) Copyright 1999 Randy Dunlap
Copyright (C) 2006 Lennert Buytenhek <buytenh@wantstofly.org> Dedicated to Marija Kulikova.
Copyright (C) 1997, 1998, 1999, 2000, 06 by Ralf Baechle
Copyright (C) 2007-2009 Geert Uytterhoeven
Copyright (C) 1994 Linus Torvalds
Copyright 2016 Quentin Schulz
Copyright (C) 2015 - 2018 MediaTek Inc. Author: Biao Huang <biao.huang@mediatek.com> Ryder Lee <ryder.lee@mediatek.com> Sean Wang <sean.wang@mediatek.com>
Copyright (C) 2000 - 2009 Stuart Menefy
Copyright (C) 2009 Ken McQuire <kenm@desertweyr.com>
Copyright (C) 2017 Samsung Electronics Co.Ltd Author: Andrzej Pietrasiewicz <andrzejtp2010@gmail.com>
Copyright (C) 2018 MediaTek Inc.
Copyright (c) 1999 Frodo Looijaard <frodod@dds.nl> and Philip Edelbrock <phil@netroedge.com> and Mark D. Stuebaker <mdsxyz123@yahoo.com>
Copyright (C) 2019 Kai-Heng Feng <kai.heng.feng@canonical.com>
Copyright (c) 2007 Rik Snel <rsnel@cube.dyndns.org>
Copyright 2001-2003, 2007-2008 MontaVista Software Inc. Author: MontaVista Software, Inc. <source@mvista.com>
Copyright 2012 Sony Corporation
Copyright (C) 2007 Maciej W. Rozycki
Copyright (C) 2015-2018 Intel Corporation
Copyright 2006-2015 Freescale Semiconductor, Inc. All Rights Reserved.
(c) 2000 Jimmie Mayfield (mayfield+usb@sackheads.org);(C) 2002 Alan Stern <stern@rowland.org>
Copyright (C) 2005, 2008, 2009 Simtec Electronics <http://armlinux.simtec.co.uk/> Ben Dooks <ben@simtec.co.uk>
Copyright (C) 2007-2008 Silicon Graphics, Inc. All rights reserved.
Copyright (c) 2004-2005 Simtec Electronics Ben Dooks <ben@simtec.co.uk>
Copyright (C) 2014-2018 Nuvoton Technologies tomer.maimon@nuvoton.com All rights reserved.
Copyright (C) 2016 Intel Corporation Author: Lv Zheng <lv.zheng@intel.com>
Copyright (C) 2002 Intel Corp.
Copyright 2001 by Peter Sprenger (sprenger@moving-bytes.de)
Copyright (C) 1994, 1995 by Waldorf Electronics, written by Ralf Baechle.
Copyright 2018 IBM Corp.
Copyright (C) 2003 Russell King.
(c) 1999-2002 Matthew Dharm (mdharm-usb@one-eyed-alien.net);(c) 2002 Alan Stern <stern@rowland.org>;(c)

LICENCE TERMS (cont.)

1999 Michael Gee (michael@linuxspecific.com)
Copyright (C) 2004-9 Patrick Boettcher <patrick.boettcher@posteo.de>
Copyright (C) 2002-2006 Krzysztof Halasa <khc@pm.waw.pl>
Copyright (C) 2007 Philippe De Muyter <phdm@macqel.be>
Copyright (C) 1997, Olaf Kirch <okir@monad.swb.de>
Copyright (C) 2019, Nicolas Saenz Julienne <nsaenzjulienne@suse.de>
Copyright (C) 2001 - 2006 Paul Mundt
(C) Copyright 2007 Ash Willis <ashwillis@programmer.net>;(C) Copyright 2003 Red Hat Inc <alan@lxorguk.ukuu.org.uk>
Copyright (C) 2013-2014 Altera Corporation
Copyright (C) 2017 Intel Corp. Author: Len Brown <len.brown@intel.com>
Copyright IBM Corp. 2004, 2005 Christian Borntraeger <cborntra@de.ibm.com>
Copyright (c) 2016 Alexandrov Stanislav <neko@nya.ai>
(c) 2007 Trent Piepho <xyzzzy@speakeasy.org>;(c) 2005,2006 Ricardo Cerqueira <v4l@cerqueira.org>;(c) 2005 Mauro Carvalho Chehab <mchehab@kernel.org>
Copyright (C) 2003-2013 STMicroelectronics (R&D) Limited
Copyright © 2009 - Maxim Levitsky Common routines & support for SmartMedia/xD format
Copyright (C) 2013 Texas Instruments Incorporated - http://www.ti.com Author: Graeme Gregory <gg@slimlogic.co.uk> Author: Kishon Vijay Abraham I <kishon@ti.com> Based on twl6030_usb.c Author: Hema HK <hemahk@ti.com>
Copyright (c) 1999 Al Smith;(c) 1988 Silicon Graphics
Copyright (C) 1991, 1992, 1993, 1994 Linus Torvalds
Copyright(c) 2007-2013 Realtek Corporation.*/
Copyright (c) 2011 Picochip Ltd., Jamie Iles
Copyright (c) 2005, Christian Limpach
Copyright (C) 2010 Gyungoh Yoo <jack.yoo@maxim-ic.com>
Copyright (C) 2004 - 2006 Paul Mundt
Copyright © 2008 MontaVista Software, Inc. <source@mvista.com>
Copyright (c) 2014 Maciej W. Rozycki
Copyright (C) 2003-2011 Jean Delvare <jdelvare@suse.de>
Copyright (c) 2007 Richard Purdie
Copyright (C) 2014-2015 Toradex AG Author: Stefan Agner <stefan@agner.ch>
Copyright (C) 2017 HiSilicon Electronics Co., Ltd. http://www.huawei.com
Copyright (c) Amarula Solutions B.V. 2013
Copyright (c) 2003, 2006 Silicon Graphics, Inc. All rights reserved.
Copyright (C) 2007, Benedikt Spranger <b.spranger@linutronix.de>
Copyright 2014-2020 NXP
Copyright (C) International Business Machines Corp., 2002-2004
(c) the information as provided by the proprietary NI-MAX software, and (d) the user interface code provided by the user-land comedilib library.
(C) 2000-2001 Svenning Soerensen <svenning@post5.tele.dk>
Copyright (C) 2017-2018 HiSilicon Co., Ltd. http://www.hisilicon.com
Copyright (C) 2013 Hisilicon Ltd.
Copyright (C) 1992,1993,1994,1995,1997 Australia. E-mail billm@suburbia.net
Copyright (C) 2006 Sony Computer Entertainment Inc.
Copyright (C) 2003-2014 Bernd Porr, mail@berndporr.me.uk
Copyright (c) 2009 Manuel Stahl <manuel.stahl@iis.fraunhofer.de>
Copyright (C) 2015 STMicroelectronics (R&D) Limited
Copyright (C) 2001 Intel
Copyright 2012 Roland Stigge <stigge@antcom.de>
Copyright (C) 2004 Freescale Semiconductor, Inc.:(c) MontaVista Software, Inc. Vitaly Bordug <vbordug@ru.mvista.com>
Copyright 1999 (C) Niibe Yutaka
Copyright (C) 2013, Carlo Caione <carlo@caione.org>
Copyright (C) 2012 Alan Ott <alan@signal11.us> Signal 11 Software
Copyright (c) 2018 Hisilicon Limited.
(C) Copyright 2018 MIPS Tech LLC;(C) Copyright 2016-2018 - Mathieu Desnoyers <mathieu.desnoyers@efficios.com>
Copyright (C) 1992 Rick Sladkey
Copyright (C) 2010, Greg Ungerer (gerg@snapgear.com)
Copyright (C) 2001 RidgeRun, Inc.
(C) Copyright 1995 Linus Torvalds;(C) Copyright 2002 Christoph Hellwig
Copyright 2013-2014 Analog Devices Inc. Author: Lars-Peter Clauen <lars@metafoo.de>
Copyright (C) 2006-2008 Marvell International Ltd. Fengwei Yin <fengwei.yin@marvell.com> Bin Yang <bin.yang@marvell.com> Eric Miao <eric.miao@marvell.com>
Copyright (C) 2005 David Brownell
(c) 1998 David Huggins-Daines.
Copyright 2008 Christoph Hellwig, IBM Corp.
Copyright 2011 Benjamin Herrenschmidt <benh@kernel.crashing.org>, IBM Corp.
Copyright (C) 2010, Janusz Krzysztofik <jkrzysz@tis.icnet.pl>
Copyright (c) 2019 Volkswagen Group Electronic Research All rights reserved.
Copyright (C) 2019, Dell Inc
Copyright (C) 2000 Marcus Metzler <marcus@convergence.de> Ralph Metzler <ralph@convergence.de> Holger Waechter <holger@convergence.de> Andre Draszik <ad@convergence.de> for convergence integrated media GmbH
Copyright (C) 2001 Helge Deller (deller a parisc-linux org)
Copyright (C) 2012-2017 Mentor Graphics Inc.
Copyright 2006-2009 Wolfson Microelectronics PLC.
Copyright (C) 2003-2004 Chris Kennedy
Copyright (C) 2017 Lukas Wunner <lukas@wunner.de>
Copyright (C) 2005 IBM. Hex-dump auto generated from spu_save.c.
(C) 2000-2002 Harald Welte <laforge@netfilter.org>;(C) 2003-2006 Netfilter Core Team <coreteam@netfilter.org>;(C) 2007-2012 Patrick McHardy <kaber@trash.net>
Copyright (c) 2010 Arnaud Patard <apatard@mandriva.com>
Copyright (c) 2013-2015 Intel Corporation.
Copyright (c) 1996-2000 Jonathan A. Buzzard (jonathan@buzzard.org.uk)
Copyright (c) 2015 Linear Technology
Copyright 2015, Red Hat, Inc. and/or its affiliates.
Copyright (C) 2010 Extreme Engineering Solutions.
Copyright (c) 2002-2004 Anton Altaparmakov
Copyright (C) 2011-2013 Freescale Semiconductor, Inc. All Rights Reserved.
Copyright IBM Corp. 2004, 2012 Author(s): Jan Glauber <jan.glauber@de.ibm.com>
Copyright (C) 2013 Red Hat
Copyright (C) 2015 Intel Corp Author: Fang, Yang A <yang.a.fang@intel.com>
Copyright (C) 2015 Intel Corp
Copyright (C) 2017 Red Hat. All rights reserved.
Copyright (C) 2011 Wolfram Sang, Pengutronix e.K.
Copyright (c) 2014-2015 Google Inc.
Copyright (C) 2008, 2009, 2010 Michael Krufky <mkrufky@linuxtv.org>
Copyright (c) 2008 Embedded Alley Solutions Inc
Copyright (C) 2016 Tony Lindgren <tony@atomide.com>
Copyright (C) 2008-2011 Manuel Lauss
Copyright 2012 by Servery, Inc.
Copyright 2005,2008 Wolfson Microelectronics PLC. Author: Liam Girdwood Mark Brown <broonie@opensource.wolfsonmicro.com>
Copyright (C) 2018 Rockchip Electronics Co., Ltd. Alpha Lin <Alpha.Lin@rock-chips.com> Jeffy Chen <jeffy.chen@rock-chips.com>
Copyright (C) 1998, 1999 Ralf Baechle
Copyright (C) 2013 ST-Ericsson AB Author: Linus Walleij <linus.walleij@linaro.org>
Copyright (c) 2000 Mike Corrigan <mikejc@us.ibm.com>
Copyright (c) 2013 Coraid, Inc. See COPYING for GPL terms.
Copyright (C) 1998,1999 Russell King
(C) 2006-2007 Shaohua Li <shaohua.li@intel.com>
Copyright (C) 2013-2018 Renesas Electronics Corporation
Copyright (C) 2015 Andrea Venturi Andrea Venturi <be17068@iperbole.bo.it>

LICENCE TERMS (cont.)

Copyright (C) 2012-2015 Google, Inc
Copyright (C) 2001 Jeff Wiedemeier (Compaq Computer Corporation)
Copyright (C) 2003 MontaVista Software, Inc.
Copyright (C) 2009 Wolfson Microelectronics
Copyright 2016 Qtechnology A/S 2016 Ricardo Ribalda <ricardo.ribalda@gmail.com>
Copyright (C) 2007 Nick Piggin
Copyright 2013 Texas Instruments, Inc. Santosh Shilimkar <santosh.shilimkar@ti.com>
Copyright (C) STMicroelectronics SA 2013 Authors: Vincent Abriou <vincent.abriou@st.com> for STMicroelectronics.
Copyright (C) 2014-2015, Marvell International Ltd.
Copyright (C) 2014 STMicroelectronics -- All Rights Reserved
Copyright (C) 2015 Softing Industrial Automation GmbH
Copyright (C) 2009 DiBcom (<http://www.dibcom.fr/>)
Copyright (c) 2010 by: Mauro Carvalho Chehab
Copyright (C) 2003 Al Borchers (alborchers@steinerpoint.com)
Copyright (C) 2008-2011 Freescale Semiconductor, Inc.
Copyright (C) 2005-2008 Michael Buesch <m@bues.ch>
Copyright (C) 1995, 1999, 2002 by Ralf Baechle
Copyright (c) 2014-2016 Mentor Graphics Inc.
Copyright (C) 1995-1996 Jean-loup Gailly.
Copyright IBM Corp. 2005, 2011 Author(s): Jan Glauber (jang@de.ibm.com)
Copyright (C) 1995-06 ICP vortex GmbH, Achim Leubner *
Copyright 2004 Simon Kelley.
Copyright (C) 2015 Synopsys, Inc. (www.synopsys.com)
Copyright (C) 2016 Red Hat, Inc. All rights reserved. Author: Alex Williamson <alex.williamson@redhat.com>
Copyright (C) 1998 Gabriel Paubert.
Copyright (C) 2006-2009 Pengutronix Sascha Hauer <s.hauer@pengutronix.de> Juergen Beisert <j.beisert@pengutronix.de> Wolfram Sang <w.sang@pengutronix.de>
Copyright (c) 1997-2007 Jean Tourrilhes, All Rights Reserved.
Copyright 2007, Lennart Poettering
Copyright (C) 2008-2009 SUSE Linux Products GmbH
Copyright (C) 1994, 1995 Linus Torvalds
Copyright (C) 1995-1997 Paul H. Hargrove;(C) 2003 Ardis Technologies <roman@ardistech.com>
Copyright (C) 2012 Bernd Krumboeck (krumboeck@universalnet.at)
Copyright (C) 2007-2012 VMware, Inc. All rights reserved.
Copyright (c) 2001-2021, Huawei Tech. Co., Ltd.
Copyright (C) 2019 Martin Blumenstingl <martin.blumenstingl@googlemail.com>
Copyright (c) 2002 The Regents of the University of Michigan
Copyright (C) 2014 Marek Vasut <marex@denx.de>
Copyright (c) 2000-2006, 2014-2016, Ericsson AB
(C) Copyright 2005 4G Systems <info@4g-systems.biz>, All Rights Reserved. <http://www.4g-systems.biz/>;
Copyright 2007 OpenWrt.org, Florian Fainelli <florian@openwrt.org>;(c) Copyright 2005 4G Systems <info@4g-systems.biz>
Copyright (C) 2000 Oleg Drokin <green@crimea.edu>;(c) MontaVista Software, Inc.:(C) 2012 Wolfram Sang, Pengutronix
Copyright (C) 1998 Daniel Jacobowitz <dan@debian.org>
Copyright (c) 2015 Rockchip Electronics Co. Ltd. Author: Xing Zheng <zhengxing@rock-chips.com>
Copyright (C) 2004 Nokia Corporation Partial timer rewrite and additional dynamic tick timer support by Tony Lindgen <tony@atomide.com> and Tuukka Tikkanen <tuukka.tikkanen@elektrobit.com>
Copyright (C) 2015 Freescale Semiconductor, Inc. All rights reserved.
Copyright (C) 2006-2010 Nokia Corporation
Copyright (c) 2018 Covalent IO, Inc. <http://covalent.io>
(C) 2007 SGI, Christoph Lameter;(C) 2011 Linux Foundation, Christoph Lameter
Copyright (C) 2000 Andrew Henroid
Copyright (c) 2000 Uros Bizjak <uros@kss-loka.si>
Copyright (C) 2018-2019, Bridge Systems BV
Copyright 2016 Netflix, Inc.
(C) Copyright 2010 Marvell International Ltd. All Rights Reserved

Copyright 1996, 1997, 1998 Hans Reiser, see reiserfs/README for
Copyright (C) 2004 Adaptec, Inc. All rights reserved.
Copyright (C) 1996 Thomas K. Dyas (tdyas@noc.rutgers.edu)
Copyright 2017 Icenowy Zheng <icenowy@aosc.xyz>
(C) Copyright 1996 Linus Torvalds
Copyright (c) 2018-2019 by Geoffrey D. Bennett <g at b4.vu>
(c) Copyright 2000 The Puffin Group Inc.
Copyright (C) 2001-2005 Stelian Pop <stelian@popies.net>
Copyright (C) 2009 secunet Security Networks AG
Copyright (C) 2014,2018 Advanced Micro Devices, Inc.
Copyright © 2005-2009 Samsung Electronics Kyungmin Park <kyungmin.park@samsung.com>
Copyright (C) 2004, 2008 Red Hat, Inc. All Rights Reserved. Written by David Howells (dhowells@redhat.com)
Copyright (C) 2002-2003 Ralph Metzler <rjkm@metzlerbros.de> Metzler Brothers Systementwicklung GbR
Copyright 2016 Mylène Josserand
(c) 1998 Ruurd Reitsma <R.A.Reitsma@wbmt.tudelft.nl>
Copyright 2013-2016 Integrated Device Technology, Inc.
Copyright (C) 2014 STMicroelectronics Author: Gabriel Fernandez <gabriel.fernandez@st.com>
(C) Copyright 2014 Intel Corporation Author: David Cohen <david.a.cohen@linux.intel.com>
Copyright (ST) 2012 Vipin Kumar (vipin.kumar@st.com)
Copyright 2011 Picochip, Jamie Iles.
Copyright (C) 2006 Texas Instruments.
Copyright (C) 2006-2008, Uri Shkolnik, Anatoly Greenblat
Copyright (c) by Jaroslav Kysela <perex@perex.cz>, Hannu Savolainen 1993-1996
Copyright (c) 2010 Adam Bennett;(c) Tias Guns
Copyright (c) 2016, Fuzhou Rockchip Electronics Co., Ltd Author: Lin Huang <hl@rock-chips.com>
Copyright (C) 2008 Intel Corp
Copyright (c) 2003-2004 Simtec Electronics Ben Dooks <ben@simtec.co.uk>
"Copyright (C) 2009 Karsten Keil <keil@b1-systems.de> 2002 Wolfgang Mues <wolfgang@iksw-muees.de>
2001 Frode Isaksen <fisaksen@bewan.com> 2001 Kai Gernaschewski <kai.gernaschewski@gmx.de>"
Copyright(c) 2012 EZchip Technologies.
Copyright 2017 Priit Laes
Copyright (C) 2015, Imagination Technologies Ltd. Authors: Matt Redfearn (matt.redfearn@mips.com)
Copyright (C) 2008-2011 Silicon Graphics, Inc. All rights reserved.
Copyright (C) 2015 Linus Walleij <linus.walleij@linaro.org>
Copyright 2005 Wolfson Microelectronics PLC. Author: Liam Girdwood lrg@slimlogic.co.uk
(c) Copyright 2001 Scott Jennings <linuxdrivers@oro.net>
Copyright (C) 2010 Urs Fleisch <urs.fleisch@sensirion.com>
Copyright IBM Corp. 1999, 2010 Author(s): Denis Joseph Barrow Martin Schwidofsky (schwidofsky@de.ibm.com)
Copyright (C) 1998 - 2001 Frodo Looijaard <frodol@dds.nl>, Kyösti Mälkki <kmalkki@cc.hut.fi>, and Mark D. Studebaker <mdsxyz123@yahoo.com> Ported to Linux 2.6 by Aurelien Jarno <aurelien@aurel32.net> with the help of Jean Delvare <jdelvare@suse.de>
Copyright (c) 2017 Linus Walleij <linus.walleij@linaro.org>
Copyright (C) 2012 Lothar Felten <lothar.felten@gmail.com> Thanks to Jan Volkering
Copyright (C) 2016 Nobuhiro Iwamatsu <iwamatsu@nigauri.org>
Copyright 2002 Momentum Computer, Inc. Author: Matthew Dharm <mdharm@momenco.com>
Copyright (c) 2017 Red Hat, Inc
Copyright: (C) 2008 Mistral Solutions Pvt Ltd
Copyright (C) 2016 Matt Ranostay <mat@ranostay.consulting>
Copyright (c) 2013 - 2017 Intel Corporation. All rights reserved.
Copyright (c) 2000-2001, 2010, Code Aurora Forum. All rights reserved.
Copyright (C) 1991, 1999 Free Software Foundation, Inc.
Copyright (C) 2000-2001 Hewlett-Packard (John Marvin)
Copyright (C) 1999 Takashi Iwai <tiwai@suse.de>
Copyright (C) 2001 IBM Corporation. All rights reserved.
(C) Copyright 2000 John Fremlin <vii@penguinpowered.com>
Copyright (c) 2018 Synopsys, Inc. and/or its affiliates. stmmac XGMAC definitions.
Copyright (C) 1999, 2000, 2003 Ralf Baechle

LICENCE TERMS (cont.)

Copyright (C) 2007 Jeff Dike (jdike@{addtoit.com,linux.intel.com})
Copyright (C) 2008 Marvell Semiconductors, All Rights Reserved.
Copyright (C) 2000, David Gibson, Linuxcare Australia.:(C) Copyright David Gibson, IBM Corp. 2001-2003.
Copyright (c) 2019 Tomasz Figa <tomasz.figa@gmail.com>
Copyright (C) 2004-2005, Kyle McMartin <kyle@parisc-linux.org>
Copyright (C) The Weather Channel, Inc. 2002. All Rights Reserved.
Copyright (C) 2015 Robert Jarzmik <robert.jarzmik@free.fr>
Copyright (C) 1999, 2000, 2001 by Michael Engel <engel@unix-ag.org>, Karsten Merker <merker@linuxtag.org> and Harald Koerfgen.
Copyright (c) 2018 Davide Caratti, Red Hat inc.
Copyright 2015-2017 Pengutronix, Lucas Stach <kernel@pengutronix.de>
Copyright 2006 - Florian Fainelli <florian@openwrt.org>
Copyright 2013-2017 IBM Corp.
Copyright (c) 2012-2013 by Tensilica Inc. ALL RIGHTS RESERVED.
Copyright (C) 2019 Phytex Messtechnik GmbH Author: Teresa Remmet <t.remmet@phytec.de>
Copyright (C) 2005 David Shaohua Li <shaohua.li@intel.com>
Copyright (C) 1995, 96, 97, 98, 99, 2003 by Ralf Baechle
Copyright (C) 2006 Nokia Corporation Author: Imre Deak <imre.deak@nokia.com>
Copyright (C) 2014-2015 Broadcom Corporation
Copyright (c) 2010-2011,2014 The Linux Foundation. All rights reserved.
"Copyright (C) 1997-1998 Mark Lord"
Copyright (C) 2002, Greg Ungerer (gerg@snapgear.com)
Copyright (C) ST-Ericsson SA 2013 Author: Gabriel Fernandez <gabriel.fernandez@st.com> for ST-Ericsson.
Copyright (C) 2014 Altera Corporation
Copyright IBM Corp. 1999, 2000 Author(s): Hartmut Penner (hp@de.ibm.com), Martin Schwidefsky (schwidefsky@de.ibm.com)
Copyright (c) 2015, Linaro Limited
Copyright (c) 2012-2013, Intel Corporation Author: Mathias Nyman <mathias.nyman@linux.intel.com>
Copyright (C) 2007 Gary Jennejohn <garyj@denx.de>
Copyright IBM Corp. 2011 Author(s): Gerald Schaefer <gerald.schaefer@de.ibm.com>
Copyright 2008-12 Wolfson Microelectronics PLC.
Copyright (C) 2007-2008 Google, Inc.
Copyright(c) 2016-2017 Intel Deutschland GmbH
Copyright 2011-2013 Analog Devices Inc. Author: Lars-Peter Clausen <lars@metafoo.de>
Copyright (c) 2001-2004 Silicon Graphics, Inc. All rights reserved.
Copyright (C) 2017 Tomohiro Yoshidomi <sylyph23k@gmail.com>
Copyright (c) 2012 Marvell International Ltd. Wenzeng Chen<wzch@marvell.com> Qiao Zhou <zhouqiao@marvell.com>
Copyright IBM Corp. 2001, 2009 Author(s): Ulrich Weigand <Ulrich.Weigand@de.ibm.com>, Martin Schwidefsky <schwidefsky@de.ibm.com>,
Copyright (C) 2012 Samsung Electronics Co.Ltd Authors: Eunchul Kim <chulspro.kim@samsung.com> Jinyoung Jeon <jy0.jeon@samsung.com> Sangmin Lee <lsmin.lee@samsung.com>
Copyright (C) 2008, VMware, Inc. Author : Alok N Kataria <akataria@vmware.com>
Copyright (C) 2013 STMicroelectronics Limited Author: Stephen Gallimore <stephen.gallimore@st.com>
Copyright (C) 2002 MontaVista Software Inc.
Copyright (C) 2019 Dell Inc by Narendra K <Narendra.K@dell.com>
Copyright (c) 2013 Olivier Scherler
(C) SGI 2006, Christoph Lameter (C) Linux Foundation 2008-2013
Copyright 2011-2012 Intel Corporation
Copyright (c) 2019 MediaTek Inc. Author: KaiChieh Chuang <kaichieh.chuang@mediatek.com>
Copyright (c) 2018 Microchip Technology, Inc. All rights reserved.
Copyright (c) 2009-2012 Freescale Semiconductor, Inc.
Copyright (C) 2011 Marius Bjoernstad Kotsbak <marius@kotsbak.com>
Copyright (C) 2016 Ash Hughes <ashley.hughes@blueyonder.co.uk>
Copyright 2016 ArcticSand, Inc. Author : Brian Dodge <bdodge@arcticsand.com>
Copyright (C) 2014 Texas Instruments Incorporated - http://www.ti.com/ Author: Felipe Balbi <balbi@ti.com> Author: Marcin Niestroj <m.niestroj@grinn-global.com>
Copyright (C) 1998 Dan Jacobowitz
Copyright (C) 2007 IBM Corporation
Copyright (C) Neil Brown 2002
Copyright (C) 2019 SiFive, Inc.
(C) Copyright 1999 Roman Weissgaerber <weissg@vienna.at>;(C) Copyright 2000-2004 David Brownell <dbrownell@users.sourceforge.net>
Copyright (C) 2014 LSI
Copyright 2004 Andi Kleen, SuSE Labs.
Copyright (C) 1996-2001 Linus Torvalds & author (see below)
Copyright (C) 2005 Paul Mackerras <paulus@samba.org>
Copyright (C) 2007 - 2009 Adrian McMenamin
Copyright 2012 Simon Arlott
Copyright (C) 2017-2018 CTERA Networks. All Rights Reserved.
Copyright (c) 2011-2012, NVIDIA CORPORATION. All rights reserved.
Copyright 2019 NXP.:(c) readl(c)
Copyright (C) 2007 Manuel Lauss <mano@roarinelk.homelinux.net>
Copyright (C) 2008-2009 Red Hat, Inc. Authors: Izik Eidus Andrea Arcangeli Chris Wright Hugh Dickins
Copyright © 2007 Nokia Corporation. All rights reserved.
Copyright (C) 2001 Peter Bergner.
Copyright (C) 2000-2001, 2003-2004 Hewlett-Packard Co David Mosberger-Tang <davidm@hpl.hp.com>
Copyright (C) 2010-2015 Texas Instruments Incorporated - http://www.ti.com
Copyright (C) 2004 Hollis Blanchard <hollisb@us.ibm.com>, IBM
Copyright (c) 2018 Amlogic, inc. Author: Liang Yang <liang.yang@amlogic.com>
Copyright (C) 2015 Atmel, 2015 Josh Wu <josh.wu@atmel.com>
Copyright (C) 1997, 98, 99, 2000, 2003 Ralf Baechle
(C) Copyright IBM Corporation 2001,2006
Copyright (C) 1999-2010 3ware Inc.
Copyright (C) 2010 NetUP Inc.
(c) Copyright 2005 Benjamin Herrenschmidt, IBM Corp. benh@kernel.crashing.org;:(c) container_of(c, struct smu_fan_control, ctrl)
Copyright (c) 2016 Chanwoo Choi <cw00.choi@samsung.com>
Copyright (C) 2010 Matt Fleming <matt@console-pimps.org>
Copyright (C) 2014 Juergen Holzmann
Copyright (C) 2009 - 2013 Johan Hovold (jhovold@gmail.com)
Copyright(c) 2007 - 2009 Intel Corporation.
Copyright (C) 2007 Texas Instruments.
Copyright (c) 2019 MediaTek Inc. Author: Min.Guo <min.guo@mediatek.com>
Copyright (c) Siemens AG, 2012, 2013
Copyright (c) 2018 MundoReader S.L. Author: Heiko Stuebner <heiko.stuebner@bq.com>
Copyright (C) 2006 SWAPP Andrea Paterniani <a.paterniani@swapp-eng.it>
Copyright (c) 2009 Micrel Inc.
Copyright (C) 2019, Amarula Solutions. Author: Jagan Teki <jagan@amarulasolutions.com>
Copyright (C) 2009 Rafael Ignacio Zurita <rizarita@yahoo.com>
Copyright (C) 2010 Texas Instruments Incorporated - http://www.ti.com/ Tarun Kanti DebBarma <tarun.kanti@ti.com> Thara Gopinath <thara@ti.com>
Copyright (C) 2016-19 Renesas Electronics Corporation
Copyright (c) 2014-2015 Samsung Electronics Co., Ltd. Author : Chanwoo Choi <cw00.choi@samsung.com>
Copyright (C) 2001 Matthew Wilcox <willy at parisc-linux.org>
Copyright IBM Corp. 2008, 2013
Copyright (c) 2009 Herton Ronaldo Krzesinski <herton@mandriva.com.br>
Copyright (C) 2000 Steve Hill (sjhill@cotw.com) Rob Scott (rscott@mtrob.fdns.net)
Copyright (C) 2018, Intel Corporation Authors: Andy Shevchenko <andriy.shevchenko@linux.intel.com> Mika Westerberg <mika.westerberg@linux.intel.com>
Copyright (c) 2014, Mellanox Technologies inc. All rights reserved.
Copyright (c) 2018-2019 by Vijai Kumar K Author: Vijai Kumar K <vijaikumar.kanagarajan@gmail.com>
Copyright (C) 2012-2017 ASPEED Technology Inc.
Copyright (C) 1996, 2004, 2007 David S. Miller (davem@davemloft.net).

LICENCE TERMS (cont.)

Copyright (c) 1999-2002 Transmeta Corporation
Copyright (C) 2004 Dirk Behme <dirk.behme@de.bosch.com>
(c) 2010 Arnaud Patard <apatard@mandriva.com>
Copyright (C) 2019 MediaTek Inc. Authors: Stanley Chu <stanley.chu@mediatek.com> Peter Wang <peter.wang@mediatek.com>
Copyright (c) 2008-2011, Intel Corporation.
Copyright (c) 2013 MundoReader S.L. Author: Heiko Stuebner <heiko@sntech.de>
Copyright 2003 H. Peter Anvin - All Rights Reserved
Copyright (C) 2016 - 2017 Linaro Ltd <ard.biesheuvel@linaro.org>
Copyright (C) 2007-2017 Google, Inc.
Copyright (C) 2005 James Chapman (ds1337 core)
Copyright (c) 2004 Dmitry Torokhov
Copyright (C) 2016 - 2017 Linaro, Ltd. <ard.biesheuvel@linaro.org>
Copyright (C) 2010 Texas Instruments Incorporated - http://www.ti.com/ Senthilvadivu Guruswamy Sumit Semwal
Copyright (c) 2015 Samsung Electronics Co., Ltd. http://www.samsung.com/
Copyright (C) 2003-2005 Nokia Corporation Written by Juha Yrjölä <juha.yrjola@nokia.com>
Copyright © 2006-2014 Intel Corporation.
Copyright (C) 2008 Antonio Ospite <ospite@studenti.unina.it>
Copyright (C) 2004, OGAWA Hirofumi
(c) 2004 Ben Dooks
Copyright (C) 2001 Daniel Barlow
Copyright (c) 2002-2007 Anton Altaparmakov
Copyright 2009 Wolfson Microelectronics Mark Brown <broonie@opensource.wolfsonmicro.com>
Copyright © 2009 Bluewater Systems Ltd Author: Andre Renaud <andre@bluewatersys.com> Author: Ryan Mallon
Copyright (C) 2004 Neil Brown
Copyright (C) 2001 Will Dyson (will_dyson at pobox.com)
Copyright (c) 2002-2003 Patrick Mochel
Copyright (C) 2015 Regents of the University of California
(C) 2007 Red Hat Inc
Copyright (C) 2009 Antonio Ospite <ospite@studenti.unina.it>;(c) container_of(c, struct lp3944_led_data, ldev)
Copyright 2017 Impinj, Inc Author: Andrey Smirnov <andrew.smirnov@gmail.com>
Copyright (C) 1996,97 Ralph Metzler <rjkm@thp.uni-koeln.de>
Copyright (c) 1999-2009 Tensilica Inc.
Copyright (C) 2009 Alan Stern (stern@rowland.harvard.edu)
Copyright (C) 2005-2009 Nokia Corporation Author: Juha Yrjölä <juha.yrjola@nokia.com>
Copyright (C) 2013 Linaro Limited Author: AKASHI Takahiro <takahiro.akashi@linaro.org>
Copyright (c) 2004 Eugene Surovegin <ebs@ebshome.net>
(c) Copyright 2013 Guenter Roeck converted to watchdog infrastructure
Copyright 2015 Vishnu Patekar Vishnu Patekar <vishnupatekar0510@gmail.com>
Copyright (C) 2018 Josef Bacik
Copyright (C) 2012 Marvell International Ltd. Haojian Zhuang <haojian.zhuang@marvell.com> Qiao Zhou <zhouqiao@marvell.com>
Copyright 2010 by Konrad Rzeszutek Wilk <konrad.wilk@oracle.com>
Copyright (c) 2004 The Regents of the University of Michigan.
Copyright (c) 2011 Rafael J. Wysocki <rjw@sisk.pl>, Renesas Electronics Corp.
Copyright (c) 2015, Sony Mobile Communications AB.
Copyright (C) 2001 Robert Schwebel <robert@schwebel.de>
Copyright (C) 1999-2008, Greg Ungerer <gerg@snapgear.com>
Copyright 2013 Olliver Schinagl <olliver@schinagl.nl>
(C) 2000,2001 by Harald Welte <laforge@netfilter.org>;(C) 2001-2002 Maciej Soltysiak <solt@dns.toxicfilms.tv>
Copyright (C) 1991,1996 Free Software Foundation
Copyright 2006-2009 Solarflare Communications Inc.
Copyright 2004 Antonino Daplas <adaplas@pol.net>
Copyright 1997 Andi Kleen <ak@muc.de>
Copyright 2008,2009 Ben Herrenschmidt <benh@kernel.crashing.org> IBM Corp.
Copyright (C) 1997-2011 AudioScience Inc. <support@audioscience.com>;(C) Copyright AudioScience Inc. 1998-2003

Copyright (C) 2010 - 2013 UNISYS CORPORATION All rights reserved.
Copyright (c) 2007 Nobuhiro Iwamatsu
Copyright (c) 2010 Simtec Electronics Ben Dooks <ben@simtec.co.uk>
Copyright 2019 NXP Author: Jun Li <jun.li@nxp.com>
Copyright (c) 2013 Samsung Electronics Co., Ltd. http://www.samsung.com
Copyright (c) 2014 NVIDIA Corporation. All rights reserved.
Copyright (c) 2010 Manuel Stahl <manuel.stahl@iis.fraunhofer.de>
Copyright (c) 2013 Freescale Semiconductor, Inc. All rights reserved.
Copyright (C) 2004-2011 Texas Instruments Incorporated Author: Aurelien Jacquot (aurelien.jacquot@virtuallogix.com) Updated for 2.6.34: Mark Salter <msalter@redhat.com>
(C) Copyright 2004 Texas Instruments, <www.ti.com> Richard Woodruff <r-woodruff2@ti.com>
Copyright by Michael T. Mayers (c) Jan 09, 2000 mail: michael@tweakoz.com Thanks to John Galbraith
Copyright (C) 2011 Florian Fainelli <florian@openwrt.org>
Copyright 2012-2015 Maxime Ripard
Copyright (c) 2018 Axentia Technologies AB Author: Peter Rosin <peda@axentia.se>
Copyright (C) William M. Brack
Copyright (C) 2006 Google, Inc
Copyright (c) 2017 NXP. */
(c) 2007-2008 MSC Vertriebsges.m.b.H., Manuel Lauss <manuel.lauss@gmail.com>
Copyright (c) 2018 Inspur Corporation dts-v1/;
Copyright (C) 2004 Sten Wang <sten.wang@rdc.com.tw>
Copyright 1998-1999 Precision Insight, Inc., Cedar Park, Texas. All Rights Reserved.
Copyright (C) 2002,2003 by Andreas Gruenbacher <a.gruenbacher@computer.org>
Copyright (C) 2004-2006 International Business Machines Corp. Author(s): Michael A. Halcrow <mhalcrow@us.ibm.com> Michael C. Thompson <mcthoms@us.ibm.com> Trevor S. Highland <trevor.highland@gmail.com>
Copyright (C) 2005,2006 Yoshinori Sato
Copyright: (C) 2010, 2011 Nokia Corporation
Copyright (C) 2007-2010 Florian Fainelli <florian@openwrt.org>
Copyright (C) 2004 ICT CAS Author: Li xiaoyu, ICT CAS lixy@ict.ac.cn
Copyright 2015 Jelle van der Waa <jelle@vdwaa.nl>
Copyright (C) 2009 Andy Walls <awalls@md.metrocast.net>
Copyright (c) 2008 Texas Instruments
Copyright (C) 2001, 2002, 2003, 2004 David S. Miller (davem@redhat.com)
Copyright (c) 2016, Ericsson AB All rights reserved.
Copyright (C) 2009-2010 Marek Vasut <marek.vasut@gmail.com>
Copyright (C) 2010 Canonical, Ltd.
Copyright (C) 2007 MontaVista Software, Inc Author: Alexandre Rusev <source@mvista.com>
(C) 2001-2002 Magnus Boden <mb@ozaba.mine.nu>;(C) 2006-2012 Patrick McHardy <kaber@trash.net>
(c) 2006 Bob Copeland <me@bobcopeland.com>;(c) 2006 Keith Bennett <keith@mcs.st-and.ac.uk>
Copyright (C) 2008-2011 Freescale Semiconductor, Inc. Author: Timur Tabi <tibur@freescale.com>
Copyright (c) 2012 Markus Franke <franke.m@sebakmt.com>
Copyright (C) 2014, 2015 Intel Corporation; author Matt Fleming
Copyright (C) 2008 by Tom Tucker <tom@opengridcomputing.com>
Copyright (C) 2006-2013 Texas Instruments.;(c) MontaVista Software, Inc.
Copyright (c) 2005 Martin Langer <martin-langer@gmx.de>
(C) Copyright 2000 John Fremlin <vii@penguinpowered.com>;(C) Copyright 2000 Oliver Neukum <Oliver.Neukum@lrz.uni-muenchen.de>
Copyright © CC Computer Consultants GmbH, 2007
Copyright (c) 2006 Rick Koch <n1gp@hotmail.com>
Copyright (C) 1996, 1997 David S. Miller (davem@caip.rutgers.edu)
Copyright (C) 2002 Dag Arne Osvik <osvik@ii.uib.no> 2003 Herbert Valerio Riedel <hvr@gnu.org>
Copyright (C) 2016 Freescale Semiconductor, Inc. Author: Peter Chen <peter.chen@freescale.com>
(c) 2005,2006 Simtec Electronics Ben Dooks <ben@simtec.co.uk>
Copyright (c) 1999-2001 Vojtech Pavlik
Copyright (c) 2011-2013 Datera, Inc. All rights reserved.
Copyright (C) 2019 Texas Instruments Incorporated - http://www.ti.com Author: Peter Ujfalusi <peter.ujfalusi@ti.com>

LICENCE TERMS (cont.)

Copyright © 2012 Intel Corporation
Copyright (c) 2001 by Stefan Eilers and Hansjoerg Lipp <hjlipp@web.de>.
Copyright 2007 Simtec Electronics <linux@simtec.co.uk> http://armlinux.simtec.co.uk/
Copyright (C) 2010-2015 Freescale, Inc. All Rights Reserved.
"Copyright (c) 2010 Marvell International Ltd. Author: Haojian Zhuang <haojian.zhuang@marvell.com>"
Copyright (c) 2018 excecet electronics GmbH
Copyright (c) by James Courtier-Dutton <James@superbug.demon.co.uk> Driver p16v chips Version: 0.25
(c) 1996-2003 Gerd Knorr <kraxel@bytestex.org>
Copyright Waterloo Microsystems Inc.
Copyright (C) 2013 Wesley W. Terpstra <w.terpstra@gsi.de>
Copyright 2002/2003 by Andreas Eversberg (jolly@eversberg.eu)
Copyright (c) 2005 Andriy Skulysch
Copyright (C) 2004 Microtronix Datacom Ltd. Written by Wentao Xu <xuwentao@microtronix.com>
Copyright (C) 1996 by David S. Miller
Copyright (C) 2015-2016 Endless Mobile, Inc.
Copyright 2006 Tungsten Graphics, Inc., Bismarck, ND. USA. All Rights Reserved.
(c) 1998 Grant R. Guenther <grant@torque.net> Under the terms of the GNU General Public License
Copyright (c) 2005 David Brownell
Copyright (C) 2004 Lonnie Mendez (dignome@gmail.com)
Copyright (C) 2009 Alberto Panizzo <maramaopercheseimorto@gmail.com>
Copyright (C) 2000 by Bart Hartgers <bart@etpmod.phys.tue.nl>, Jaroslav Kysela <perex@perex.cz>
Copyright (C) 1998 Russell King
Copyright (c) 2014-2015, Imagination Technologies
(C) 2002 Zwane Mwaikambo <zwane@commfireservices.com>;(C) 2002 Hiroshi Miura <miura@da-cha.org> All Rights Reserved
Copyright (C) 2012 LSI Corporation
Copyright (c) 1999 Al Smith
Copyright (c) 2015, 2016, Primary Data, Inc. All rights reserved.
Copyright 2015, Michael Neuling, IBM Corp.
Copyright 2005-2007 PMC-Sierra, Inc, Author: Jun Sun, jsun@mvista.com or jsun@junsun.net
Copyright 2013-2016 Freescale Semiconductor, Inc.
Copyright IBM Corp. 1999,2012
Copyright (c) 2005-2006, 2013-2018 Ericsson AB
Copyright (C) 2004-5 Patrick Boettcher (patrick.boettcher@desy.de)
Copyright (C) 2014-2015 Pengutronix, Markus Pargmann <mpa@pengutronix.de>
Copyright (C) 2007 Nobuhiro Iwamatsu
Copyright (C) 1999, 2001 David Mosberger-Tang <davidm@hpl.hp.com>
Copyright (c) 2013 Andrew Lunn <andrew@lunn.ch>
(C) Copyright 2005 Linus Torvalds;(C) Copyright 2005 Andi Kleen;(C) Copyright 2008 Glauber Costa
Copyright (C) 2018-2019 Intel Corporation
Copyright (C) 2015 Carlo Caione <carlo@endlessm.com>
Copyright (C) 2008 Red Hat <mjg@redhat.com>
Copyright (C) 2010 Renesas Solutions Corp. Yusuke Goda <yusuke.goda.sx@renesas.com>
Copyright (c) 2006 Jochen Voss <voss@seehuhn.de>
Copyright (C) 2010 Alberto Panizzo <maramaopercheseimorto@gmail.com>
Copyright (c) 2012-2013 David Herrmann <dh.herrmann@gmail.com>
Copyright (C) 2001 Ming Lei <ming.lei@canonical.com>
(C) 2004-2009 Dominik Brodowski <linux@dominikbrodowski.de>;(C) 2010 Thomas Renninger <trenn@suse.de>
(c) 2007 Timur Tabi <timir at freescale.com>, Freescale Semiconductor
(C) 2005, 2006 Linux Networx (http://lnxi.com)
Copyright (C) 2004-5 Patrick Boettcher (patrick.boettcher@posteo.de)
Copyright (c) 2017 Red Hat Inc.
Copyright © 2006-2007, 2010 Freescale Semiconductor
Copyright (c) 2017 Samsung Electronics Co., Ltd. Author: Marek Szyrowski <m.szyrowski@samsung.com>
Copyright 2003 Sony Corporation
Copyright (c) 2010, 2011 Fabien Marteau <fabien.marteau@armadeus.com>
Copyright (C) 2011-2013 Texas Instruments Incorporated - http://www.ti.com Author: Keshava Munegowda <kesava_mgowda@ti.com> Author: Roger Quadros <rogerq@ti.com>
Copyright (c) 2004, 2005, 2006, 2007 Broadcom Corporation
Copyright (C) 2008 Jochen Friedrich <jochen@scram.de> based on a previous patch from Jon Smirl <jonsmirl@gmail.com>
Copyright 2007-2009 HV Sistemas S.L.
Copyright (c) by Jaroslav Kysela <perex@perex.cz> DRAM access routines
Copyright (C) 2013 Faraday Technology Corporation Author: Yuan-Hsin Chen <yhchen@faraday-tech.com>
Copyright (c) 2018-2019, The Linux Foundation. All rights reserved.
Copyright(C) 2006, Red Hat, Inc., Ingo Molnar
Copyright (C) 2002 USAGI/WIDE Project
Copyright(c) 2009, RealTEK Technology Inc. All Right Reserved.
Copyright IBM Corp. 2001, 2006 Author(s): Michael Holzheu <holzheu@de.ibm.com>
Copyright (C) 2012 ST Microelectronics author: Federico Vaga <federico.vaga@gmail.com>
Copyright (C) Freescale Semiconductor, Inc. 2009. All rights reserved.
Copyright (C) 2005-2012 Jean Delvare <jdelvare@suse.de>
Copyright (C) 2016 Imagination Technologies
Copyright 2011 Ben Hutchings.
Copyright (C) 2015 Intel Corporation Inc.
Copyright (c) 2010-2019, Intel Corporation. All rights reserved.
Copyright (C) 2005-2007 Red Hat GmbH
Copyright (c) 2011 Andrei Warkentin <andreiw@motorola.com>
(c) Richard Zidlicky
Copyright (C) 2014 Broadcom Corporation Author: Kevin Cernekee
Copyright (c) 2017 BayLibre, SAS. Author: Neil Armstrong <narmstrong@baylibre.com> Author: Jerome Brunet <jbrunet@baylibre.com>
Copyright IBM Corp. 1999, 2008 Author(s): Hartmut Penner (hp@de.ibm.com), Martin Schwidefsky (schwidefsky@de.ibm.com), Denis Joseph Barrow (djabarrow@de.ibm.com,barrow_dj@yahoo.com)
Copyright 2003-2009 Simtec Electronics http://armlinux.simtec.co.uk/ Ben Dooks <ben@simtec.co.uk>
Copyright (C) 2005-2008 Yoichi Yuasa <yuasa@linux-mips.org>
Copyright (C) 2003 Lineo uSolutions, Inc.
(C) Peter T. Breuer (ptb@ot.uc3m.es) 2003
Copyright (C) 2006 Paul Mackerras, IBM Corp.
Copyright (C) STMicroelectronics SA 2018 Author: Benjamin Gaignard <benjamin.gaignard@st.com> for STMicroelectronics.
Copyright (C) 2014 H Hartley Sweeten <hsweeten@visionengravers.com>
"Copyright (C) ST-Ericsson AB 2010 Authors: Sjur Brendeland Daniel Martensson"
Copyright (C) 2013 Max nibble <nibble.max@gmail.com>
Copyright © 2007,2011 Nokia Corporation. All rights reserved.
Copyright(c) 2010 Intel Corporation. All rights reserved.
Copyright (C) 2002 Connect Tech Inc.
Copyright (c) 2009 Jiri Kosina
Copyright (C) 1999, 2000, 01, 02, 03 by Ralf Baechle
Copyright (C) 1995, 1997, 2005, 2008 David S. Miller <davem@davemloft.net>
Copyright (C) 2003 Ladislav Michl (ladis@linux-mips.org)
Copyright (C) 2008 Lemote Technology
Copyright (C) 2018 Jernej Skrabec <jernejskrabec@siol.net>
Copyright (c) 2006-2009 VMware, Inc., Palo Alto, CA., USA
Copyright (C) 2010 CompuLab, Ltd. Konstantin Sinyuk <kostyas@compuLab.co.il>
Copyright (C) 2009 OMICRON electronics GmbH
Copyright (C) 2002 - 2005, Areca Technology Corporation All rights reserved
Copyright (C) 2013 - 2015 Renesas Electronics Corporation
Copyright 2001, 2003-2005 MontaVista Software Inc. Author: MontaVista Software, Inc. ahennesy@mvista.com source@mvista.com
Copyright(c) 2015, 2016, 2018 Intel Corporation.
Copyright 2011 Matt Evans <matt@ozlabs.org>, IBM Corporation 2016 Naveen N. Rao <naveen.n.rao@linux.vnet.ibm.com>
Copyright (C) 2014-2015 Cogent Embedded, Inc. <source@cogentembedded.com>

LICENCE TERMS (cont.)

Copyright (C) 2017 Tony Lindgren <tony@atomide.com>
Copyright (C) 2017-2018 Digital Devices GmbH Marcus Metzler <mocm@metzlerbros.de> Ralph Metzler <rjkm@metzlerbros.de>
Copyright (C) 2016-2017 Hans de Goede <hdegoede@redhat.com>
Copyright (c) 2018 Cirrus Logic, Inc. and Cirrus Logic International Semiconductor Ltd.
(C) Copyright 2003 Red Hat Inc
Copyright (C) 2017 NXP Semiconductors. Author: Marco Franchi <marco.franchi@nxp.com>
Copyright (C) 2012 ST Microelectronics Ltd. Deepak Sikri <deepak.sikri@st.com>
Copyright 2006-2008, 2011-2012, 2015 Freescale Semiconductor Inc.
Copyright (C) 2005-2007 Atmel Corporation
Copyright (C) 2015 Alex Hung <alex.hung@canonical.com>
Copyright (c) 2005 Alexander Wykes
Copyright IBM Corp. 1999, 2011
Copyright © 2002, 2003 David Dawes <dawes@xfree86.org> 2004 Sylvain Meyer 2006 David Airlie
Copyright (C) 2010 Nokia Corporation Contact: Yauheni Kaliuta <yauheni.kaliuta@nokia.com>
(c) Copyright 2001 Ascensit <support@ascensit.com>
Copyright (C) 2005-2008 Red Hat, Inc. All rights reserved.
Copyright (C) 2019 Mellanox Technologies, Ltd.
Copyright (C) 1992 Tommy Thorn
Copyright (c) 2015 Intel Corporation. All rights reserved.
Copyright (C) 1996 Peter J. Braam <braam@maths.ox.ac.uk>, Michael Callahan <callahan@maths.ox.ac.uk>
(C) 2007 sgi. Christoph Lameter.
copyright 1999-2001 by Donald Becker.
Copyright (c) 2007 Xceive Corporation
(C) 1998 Thomas Bogendoerfer (tsbogend@alpha.franken.de)
Copyright 2005 - 2011, Broadcom Corporation
Copyright (C) 2011-2013 Jozsef Kadlec <kadlec@netfilter.org> */
Copyright (C) 2018 MOXA Inc. - <https://www.moxa.com/>
Copyright (c) 2009 Silicon Graphics, Inc. All rights reserved.
Copyright 2016 Axis Communications AB.
(C) CC Computer Consultants GmbH, 2007
Copyright (C) 2014 Stefan Kristiansson <stefan.kristiansson@saunalahti.fi>
Copyright (C) 2005-9 DiBcom, SA et al
Copyright 2013 Google Inc. Written by Willem de Bruijn <willemb@google.com>
Copyright (C) 2016 FuZhou Rockchip Co., Ltd. Author: Yakir Yang <ykk@rock-chips.com>
Copyright (C) 2013 Red Hat, Inc., Johannes Weiner
Copyright 2002-2003 Rusty Russell, IBM Corporation 2003 Kai Germaschewski
Copyright IBM Corp. 2016 Author(s): Holger Dengler (hd@linux.vnet.ibm.com) Harald Freudenberger <freude@de.ibm.com>
Copyright IBM Corp. 2003
Copyright (C) 2006 Antti Palosaari <crope@iki.fi> Aapo Tahkola <aet@rasterburn.org>
Copyright (c) 2003-2011 QLogic Corporation QLogic Linux qlge NIC Driver
Copyright (C) 2015, Taeung Song <treeze.taeung@gmail.com>
Copyright (C) 2013 Douglas Gilbert <dgilbert@interlog.com>
Copyright (C) 2009 Imagination Technologies Ltd.
Copyright (C) 2007 Texas Instruments, Inc. Rajendra Nayak <rnayak@ti.com> Lesly A M <x0080970@ti.com>
Copyright 2019 Qtechnology A/S 2019 Ricardo Ribalda <ricardo@ribalda.com>
Copyright (C) Google LLC, 2018
Copyright (c) 2018 Chen-Yu Tsai
Copyright (C) 2015 Google, Inc.
Copyright (C) 2010 OKI SEMICONDUCTOR Co., LTD.
Copyright (c) 2015, Daniel Thompson
copyright 1997-2001 by Donald Becker.
Copyright (C) 2000 Eric Youngdale,
Copyright (C) 2014 Broadcom Corporation
Copyright (C) 2012 Sascha Hauer, Pengutronix <s.hauer@pengutronix.de>
Copyright (C) 2013 Texas Instruments Eduardo Valentin <eduardo.valentin@ti.com>

(C) 1993, Ralf Baechle, see gvp11.c for more info;(C) 1993 by Hamish Macdonald
Copyright (C) 2010 Felix Fietkau <nbd@openwrt.org>
Copyright (C) 2007 Chris Smith <chris.smith@st.com>
Copyright (C) 2016 Florian Fainelli <f.fainelli@gmail.com>
Copyright (C) ST-Ericsson SA 2010 Author: Shujuan Chen (shujuan.chen@stericsson.com) Author: Joakim Bech (joakim.xx.bech@stericsson.com) Author: Berne Hebark (berne.hebark@stericsson.com)
Copyright (C) ST-Microelectronics SA 2013 Author: Maxime Coquelin <maxime.coquelin@st.com>
Copyright (C) 2010 Parallels, Inc., Cyrill Gorcunov <gorcunov@openvz.org>
(c) Copyright 2013 Datera, Inc.
(C) 2009 Daniel Mack <daniel@caiaq.de>).
Copyright (C) 2008-2009 ST-Ericsson AB
Copyright 2011-2012 Freescale Semiconductor, Inc
Copyright (C) 2015 - 2017 Linaro Ltd. <ard.biesheuvel@linaro.org>
Copyright (C) 2011 Sergiy <piratfm@gmail.com>
Copyright (C) 1997, 2000, 2008 David S. Miller (davem@davemloft.net)
Copyright 2007-2010 Wolfson Microelectronics PLC. Author: Graeme Gregory Graeme.Gregory@wolfsonmicro.com
Copyright (C) 2007 Lemote, Inc. & Institute of Computing Technology Author: Fuxin Zhang, zhangfx@lemote.com
Copyright (C) 2013-2014 Mauro Carvalho Chehab <mchehab+samsung@kernel.org>
Copyright 2002-2003 MontaVista Software Inc.
Copyright (c) 2014, National Instruments Corp. All rights reserved.
Copyright 1999 by Werner Cornelius (werner@isd4linux.de)
Copyright (C) 2007-2008 Advanced Micro Devices, Inc. Author: Joerg Roedel <jroedel@suse.de>
Copyright (C) 2005 - 2011 Myricom, Inc. All rights reserved.
(C) 2009 Google Inc. John(Jung-lk) Lee <jilee@google.com>
Copyright (C) 1995. Send bug reports for the VFAT filesystem to <chaffee@cs.berkeley.edu>
Copyright (C) 2006 Texas Instruments.;(C) 2007-2008, MontaVista Software, Inc.
Copyright (c) 2015 Zhang, Keguang <keguang.zhang@gmail.com>
Copyright (c) 2003-2005 Code Mercenaries GmbH written by Christian Lucht <lucht@codemercs.com>
Copyright (C) 2014 Eduardo Valentin <edubezval@gmail.com>
Copyright (C) 2015-2016 Raspberry Pi (Trading) Ltd.
Copyright (C) 199x the Anonymus
Copyright 2006 One Laptop Per Child Association, Inc. Written by Jonathan Corbet with substantial inspiration from Mark McClelland's ovcamchip code.
Copyright 2011-2014, ARM Ltd.
Copyright 2013 Linaro Limited; author Roy Franz
Copyright (C) 2008-2011 Jean-François Moine <http://moinejf.free.fr>
Copyright (c) 2017 Martin Blumenstingl <martin.blumenstingl@googlemail.com>
(c) Copyright 2003-2007 Wim Van Sebroeck <wim@iguana.be>.
Copyright (C) 2016, NVIDIA CORPORATION. All rights reserved.
Copyright 2004 SGI
Copyright (C) 2013 Steffen Trumtrar <s.trumtrar@pengutronix.de>
Copyright (C) 2003 Winfried Ritsch (IEM) based on hdsp.h from Thomas Charbonnel (thomas@undata.org)
Copyright (C) 2018 Andreas Brauchli <andreas.brauchli@sensirion.com>
Copyright (c) 2005 Christoph Bartelmus <lirc@bartelmus.de>
Copyright(C) 2005, Benedikt Spranger <b.spranger@linutronix.de>
Copyright (C) 2005 Yoichi Yuasa <yuasa@linux-mips.org>
Copyright (c) 2013 Oliver Schinagl <oliver@schinagl.nl>
Copyright (C) 2009 Andre Prendel <andre.prendel@gmx.de> Preliminary support by: Melvin Rook, Raymond Ng
Copyright (c) 2010 CompuLab Ltd. Mike Rapoport <mike@compulab.co.il>
Copyright (C) 2007-2009 NEC Corporation. All Rights Reserved.
Copyright (c) 2016 Kuninori Morimoto <kuninori.morimoto.gx@renesas.com>
Copyright (c) 2018, Collabora Ltd. Author: Enric Balletbo i Serra <enric.balletbo@collabora.com>
Copyright 2007 Wolfson Microelectronics PLC. Author: Graeme Gregory graeme.gregory@wolfsonmicro.com or linux@wolfsonmicro.com
Copyright © 2004 Ferenc Havasi <havasi@inf.u-szeged.hu>, Zoltan Sogor <weth@inf.u-szeged.hu>, Patrik Kluba <pajko@halom.u-szeged.hu>, University of Szeged, Hungary
Copyright (C) 2017-2019 Cadence Design Systems Inc.

LICENCE TERMS (cont.)

Copyright (C) 2014 Alexander Shiyani <shc_work@mail.ru> Based on driver by Russell King <rmk@arm.linux.org.uk>
Copyright (C) 2005 Hewlett-Packard Development Comapny, L.P.
Copyright IBM Corporation, 2012 Author Aneesh Kumar K.V <aneesh.kumar@linux.vnet.ibm.com>
Copyright (C) 2007-2009 The GameCube Linux Team
Copyright (C) 2013 ARM Ltd. Author: Lorenzo Pieralisi <lorenzo.pieralisi@arm.com>
Copyright (C) by Hannu Savolainen 1993-1997
Copyright (c) 2017-2018 Microsoft Corporation
Copyright (C) 2007 Mike Isely <isely@pobox.com>
Copyright (C) 2014 Thomas Petazzoni <thomas.petazzoni@free-electrons.com>
Copyright (C) 1996, 1997, 1999 by Ralf Baechle
(c) 1999-2002 Matthew Dharm (mdharm-usb@one-eyed-alien.net);(c) 2000 David L. Brown, Jr. (usb-storage@davidb.org);(c) 2002 Alan Stern (stern@rowland.org);(c) 1999 Michael Gee (michael@linuxspecific.com)
Copyright 1999-2000 Jeremy Fitzhardinge <jeremy@goop.org>
Copyright (C) 2009 TMT Services & Supplies (Pty) Ltd.
Copyright (c) 2005 Network Appliance, Inc. All rights reserved.
Copyright (C) 2013 Cisco Systems, Inc, 2013.
Copyright 2017 VMware Inc. Author: Steven Rostedt <rstrostedt@goodmis.org>
Copyright (C) Jonathan Naylor G4KLX (g4klx@g4klx.demon.co.uk)
Copyright (c) 2013 NVIDIA Corporation. All rights reserved.
Copyright (C) 2005 Andreas Oberitter <obi@linuxtv.org>
(C) 2006 IBM Corp
Copyright (c) 2014-2016, Fuzhou Rockchip Electronics Co., Ltd Caesar Wang <wxt@rock-chips.com>
Copyright (c) 2014 by Florian 'floe' Echtler <floe@butterbrot.org>
Copyright (C) 1998, 1999 Frodo Looijaard <frodol@dds.nl> and Philip Edelbrock <phil@netroedge.com>
Copyright (C) 2002, 2005 - 2011 by Andreas Mohr <andi AT lisas.de>
Copyright (C) 2009 Embedian Inc.
(C) 2003 Ardis Technologies <roman@ardistech.com>
Copyright (C) 2012 Thomas Petazzoni <thomas.petazzoni@free-electrons.com>
Copyright (C) 2003 Heiko Ronsdorf <hero@ihg.uni-duisburg.de>
(C) 2016 by Pablo Neira Ayuso <pablo@netfilter.org>
Copyright (C) 2003, 2004 Samuel Rydh (samuel@ibrium.se)
copyright (C) 1999/2000 by Henning Zabel <henning@uni-paderborn.de>;(c) 1999/2000 Henning Zabel <henning@uni-paderborn.de>
Copyright (C) 2012-2016 Smart Energy Instruments, Inc.
Copyright (C) 2009 by Holger Schurig <hs4233@mail.mn-solutions.de>
Copyright (C) 2007 Advanced Micro Devices, Inc.
Copyright 2011 Red Hat, Inc. All Rights Reserved.
Copyright (C) 2008 Linutronix GmbH Author: John Ogness <john.ogness@linutronix.de>
Copyright (C) 2016 Cadence Design Systems - <http://www.cadence.com>
Copyright (C) 2007 Rodolfo Giometti <giometti@enneenne.com>
Copyright 2009,2012-2013 Freescale Semiconductor Inc.
Copyright (c) 2002 by David Brownell
Copyright (C) 2005 Yoshinori Sato
Copyright (C) 2002,2003 Intrinsyc Software
Copyright (c) 2019 Baylibre, SAS. Author: Jerome Brunet <jbrunet@baylibre.com>
Copyright (C) 2013-14 Intel Corp Author: Ramesh Babu <ramesh.babu.koul@intel.com> Omair M Abdullah <omair.m.abdullah@intel.com> Samreen Nilofer <samreen.nilofer@intel.com>
Copyright (c) 2016, Applied Micro Circuits Corporation Author: lyappan Subramanian <isubramanian@apm.com>
Copyright (c) 2018 Ondrej Mosnacek <omosnacek@gmail.com>
Copyright 2004-2006 Freescale Semiconductor, Inc.
Copyright (C) 2007 - 2009 Paul Mundt
Copyright (C) 2015-2016 Yinghai Lu
Copyright (c) 2018 Nuvoton Technology corporation.
Copyright (C) 2008, 2009 Paul Mundt
Copyright (c) 2008 Alexey Klimov <klimov.linux@gmail.com>
Copyright (C) 2000, 2001, 2002 Jeff Dike (jdike@karaya.com)

Copyright (C) 2006 Jens Axboe <axboe@kernel.dk>
Copyright (c) 2013 Texas Instruments Inc. David Griego, <dagriego@biglakesoftware.com> Dale Farnsworth, <dale@farnsworth.org> Archit Taneja, <archit@ti.com>
Copyright IBM Corp. 2006, 2007 Author(s): Heiko Carstens <heiko.carstens@de.ibm.com> Michael Holzheu <holzheu@de.ibm.com>
Copyright (c) 2013 Intel Corporation. All rights reserved.
Copyright 2015 Google Inc.
Copyright (c) 2018-2019, Linaro Ltd. Author: Georgi Djakov <georgi.djakov@linaro.org>
Copyright (C) 2019 Pawel Dembicki <paweldembicki@gmail.com> Based on vitesse-vsc-spi.c by: (C) Roman Zippel (assigned DJD, 1999)
Copyright (C) 2015,2016 ARM Ltd. Author: Andre Przywara <andre.przywara@arm.com>
Copyright (C) 2018 KVASER AB, Sweden. All rights reserved.
Copyright (c) 2015-2018 The Linux Foundation. All rights reserved.
Copyright (c) 2010-2014 Broadcom. All rights reserved.
Copyright (C) 2002-2003 Stephen Rothwell, IBM Corporation
Copyright (C) 2006-2008 Artem Bityutskiy
Copyright (C) 1999,2002 David A. Schleef <ds@schleef.org>
(c) 1995 Alan Cox, Building #3 <alan@lxorguk.ukuu.org.uk>;(c) 1998-99, 2000, 2009 Ingo Molnar <mingo@redhat.com>;(c) 2002,2003 Andi Kleen, SuSE Labs.
Copyright IBM Corp. 2011 Author(s): Martin Schwidefsky <schwidefsky@de.ibm.com>
Copyright (c) 2005, 2006 Anssi Hannula <anssi.hannula@gmail.com>
Copyright (C) 2004 Alexandre d'Alton <alex@alexdalton.org> Reworked by Jean Delvare <jdelvare@suse.de>
Copyright (C) 2004, Kyle McMartin <kyle@{debian.org,parisc-linux.org}>
Copyright (C) 2005 Trond Myklebust
Copyright (C) 2010 Dell Inc. by Narendra K <Narendra_K@dell.com>, Jordan Hargrave <Jordan_Hargrave@dell.com>
Copyright (C) 2015 Intel Coropration
Copyright (C) 2008-2011 Freescale Semiconductor Inc.
Copyright (C) 2005 Russell King.
Copyright (C) 2012-2014 Texas Instruments Incorporated - <http://www.ti.com/> Girish S Ghongdemath Nishanth Menon
Copyright 2002 Adam Belay <ambx1@neo.rr.com>;(c) Copyright 2007 Hewlett-Packard Development Company, L.P. Bjorn Helgaas <bjorn.helgaas@hp.com>
Copyright 2003 Richard Curnow, SuperH (UK) Ltd.
Copyright (C) 2017-2018, Intel Corporation. All rights reserved
(C) 2000 ChyGwyn Limited - <http://www.chywyn.com/>
Copyright (c) by Jaroslav Kysela <perex@perex.cz> GUS's memory allocation routines / bottom layer
Copyright 2013 Crystalfontz America, Inc. Free Electrons
Copyright 2007 Hugh Blemings, IBM Corporation. Based on cuboot-ebony.c which is:
Copyright (C) 2018 Red Hat. All rights reserved.
Copyright (c) 2006 Kyle McMartin <kyle@parisc-linux.org>
Copyright (C) 2002 - 2005 Benjamin Herrenschmidt <benh@kernel.crashing.org>
Copyright (C) 2010 Hans de Goede <hdegoede@redhat.com>
Copyright (C) 2002-2003 Florian Schirmer <jolt@tuxbox.org>
Copyright 2006 Wolfson Microelectronics
Copyright (C) 2007, 2008 Wolfson Microelectronics <linux@wolfsonmicro.com>
Copyright © 2004 Ferenc Havasi <havasi@inf.u-szeged.hu>, Zoltan Sogor <weth@inf.u-szeged.hu>, Patrik Kluba <pajko@halom.u-szeged.hu>, University of Szeged, Hungary 2006 KaiGai Kohei <kaigai@ak.jp.nec.com>
Copyright 2017 by Helge Deller <deller@gmx.de>
Copyright (C) 2014, VMware, Inc. All Rights Reserved.
Copyright (c) 2009 Magnus Damm
Copyright (C) 2015-2018 Netronome Systems, Inc.
Copyright (C) 2009, 2010 ARM Limited
Copyright (C) 2009 Jean-Francois Moine (<http://moinejf.free.fr>)
Copyright (C) 2017 Steven Rostedt, VMware Inc.
(C) Copyright 2012, Steven King <sfking@fdwdc.com>;(C) Copyright 2009, Greg Ungerer <gerg@snapgear.com>
Copyright IBM Corp. 1999, 2009 Author(s): Martin Schwidefsky <schwidefsky@de.ibm.com>

LICENCE TERMS (cont.)

Copyright (C) 2017, STMicroelectronics - All Rights Reserved Author(s): Arnaud Pouliquen <arnaud.pouliquen@st.com> for STMicroelectronics.
copyright Adrian McMenamin, 2007 With thanks to Marcus Comstedt and Nathan Keynes for work in reversing PIO and DMA
Copyright (C) 2005-2008, 2012 Texas Instruments, Inc.
Copyright (C) 2003 - 2005 Tensilica Inc.
Copyright (C) 2006 David Gibson, IBM Corporation.
Copyright (C) 2012-2015 Synaptics Incorporated. All rights reserved.
Copyright (C) 2011 Anssi Hannula <anssi.hannula@?ki.fi>
Copyright (c) 2002 Holger Waechter <holger@convergence.de>
Copyright (c) 2008-2014,2016 Intel Corporation.
Copyright (c) 2013 Qualcomm Atheros Inc.
Copyright (C) 2000 Andrea Arcangeli <andrea@suse.de> SuSE
Copyright (c) 2013-15, Intel Corporation.
(C) 2000 Milan Pikula <www@fornax.sk>
Copyright (C) 2000-2010 Steven J. Hill <sjhill@realitydiluted.com> David Woodhouse <dwmw2@infradead.org> Thomas Gleixner <tglx@linutronix.de>
"Copyright (C) 2014 Texas Instruments Incorporated - http://www.ti.com Authors: Sandeep Nair <sandeep_n@ti.com> Cyril Chemparathy <cyril@ti.com> Santosh Shilimkar <santosh.shilimkar@ti.com>"
Copyright 2010-2011 Paul Mackerras, IBM Corp. <paulus@au1.ibm.com>
Copyright 2014-2016 Analog Devices Author: Lars-Peter Clausen <lars@metafoo.de>
Copyright: (C) 2012 ST Microelectronics
Copyright (C) 2017, Microsoft Corporation.
Copyright (C) 1994 - 1999, 2000, 01, 06 Ralf Baechle
Copyright 1994 by Robert de Vries
Copyright 2013 Pavel Machek <pavel@denx.de>
Copyright 2015 Adam Sampson <ats@offog.org>
Copyright (c) 2019 Linux Foundation
Copyright (c) 2010 by Kyle Strickland based on kworld-plus-tv-analog.c by Mauro Carvalho Chehab
Copyright (C) 2008 Marvell International Ltd. Eric Miao <eric.miao@marvell.com>
Copyright (C) 2006 Greg Kroah-Hartman <greg@kroah.com>
(c) Rebel.COM, 1998,1999;(c) Philip Blundell, 1999, 2001
(C) Copyright 2000-2002, Greg Ungerer <gerg@snapgear.com>
Copyright (C) 2008 Red Hat, Inc. All Rights Reserved. Written by David Howells (dhowells@redhat.com) Derived from security/selinux/hooks.c
Copyright 2001-2003, 2006 MontaVista Software Inc.
Copyright (c) 2009, Citrix Systems, Inc.
Copyright (C) 2011 Oliver Endriss <o.endriss@gmx.de>
Copyright (c) 2013 Steffen Trumtrar <s.trumtrar@pengutronix.de>
Copyright 2013 Red Hat, Inc. Author: Daniel Borkmann <dborkman@redhat.com> Chetan Loke <loke.chetan@gmail.com>
"Copyright IBM Corp. 2007 Authors: Peter Tiedemann (ptiedem@de.ibm.com)"
Copyright (C) 1995-2003 Geert Uytterhoeven
Copyright (C) 2009 Extreme Engineering Solutions, Inc.
Copyright (C) 2009-2011 Jean-Francois Moine http://moinejf.free.fr
Copyright (C) 2010 Marvell International Ltd. Zhangfei Gao <zhangfei.gao@marvell.com> Kevin Wang <dwang4@marvell.com> Jun Nie <njun@marvell.com> Qiming Wu <wuqm@marvell.com> Philip Rakity <prakity@marvell.com>
Copyright (C) 2010 by Frederic Weisbecker <fweisbec@gmail.com>
Copyright (C) 2014 Imre Kaloz <kaloz@openwrt.org>
Copyright (C) 1995, 96, 97, 98, 99, 2000, 01 by Ralf Baechle
Copyright 2004 Philip Rischel <rischelp@jdt.com>
Copyright (C) Luke Kenneth Casson Leighton 1997-2001.
Copyright (C) 2003 Linus Torvalds
Copyright (c) 2006-2017, CRYPTOGAMS by <appro@openssl.org> All rights reserved.
(C) 2002 Andreas Gruenbacher, <a.gruenbacher@computer.org>
(C) Copyright 2010-2016 Reuimilla Technology Co., Ltd. <www.reuimillatech.com> huangxin <huangxin@reuimillatech.com> Mylène Josserand <mylene.josserand@free-electrons.com>

Copyright (C) 2018 Arcx Inc
Copyright (C) 1994, 1995 Waldorf GmbH
Copyright (C) 2011,2012 NVIDIA Corporation.
Copyright (C) 2016 Eckelmann AG.
Copyright (C) 2008 Johannes Weiner <hannes@saeurebad.de>
Copyright (C) 1992 - 1997, 1999 Silicon Graphics, Inc.
Copyright (C) 2015-2016 Freescale Semiconductor, Inc.
Copyright (C) 2003 Jeremy Fitzhardinge <jeremy@goop.org>
Copyright (C) 2015 Samsung Electronics Co.Ltd Authors: Marek Szyprowski <m.szyprowski@samsung.com>
Copyright (c) 2019 Facebook
Copyright (C) 1999 ARM Limited
Copyright (c) 2018 Simon Shields <simon@lineageos.org>
Copyright (C) 2016 Linaro Ltd. Author: Linus Walleij <linus.walleij@linaro.org>
Copyright (C) 2003 Maxim Krasnyansky <maxk@qualcomm.com>
Copyright 2009 Felipe Balbi <me@felipebalbi.com>
Copyright (C) 2014 Freescale Semiconductor, Inc. All Rights Reserved.
(C) 2011 Pablo Neira Ayuso <pablo@netfilter.org>;(C) 2011 Intra2net AG <http://www.intra2net.com>
Copyright 2007 Red Hat, Inc. by Peter Jones <pjones@redhat.com>
Copyright (C) 2014, Linaro Ltd. Author: Hanjun Guo <hanjun.guo@linaro.org> Author: Graeme Gregory <graeme.gregory@linaro.org>
Copyright (C) 2016 Freescale Semiconductor, Inc
(c) 2007 Mauro Carvalho Chehab <mchehab@kernel.org>
Copyright (C) 2012 Daniel Mack
Copyright (C) 2004, 2007 Maciej W. Rozycki
Copyright (C) 1996-1999 Gadi Oxman <gadio@netvision.net.il>
(C) 1998 Christian Schmidt (chr.schmidt@tu-bs.de);(c) 1998 Tom Lees <tom@lpsg.demon.co.uk> Minor reorganizations by David Hinds <dahinds@users.sourceforge.net>
Copyright (C) 2008-2009 ST-Ericsson AB Low-level control of the AB3100 IC Low Dropout (LDO) regulators, external regulator and buck converter Author: Mattias Wallin <mtias.wallin@stericsson.com> Author: Linus Walleij <linus.walleij@stericsson.com>
Copyright (C) 2017 Marcus Cooper <codekipper@gmail.com>
(C) 1999-2001 Paul 'Rusty' Russell;(C) 2002-2004 Netfilter Core Team <coreteam@netfilter.org>;(C) 2003,2004 USAGI/WIDE Project <http://www.linux-ipv6.org>;(C) 2006-2012 Patrick McHardy <kaber@trash.net>
Copyright © 1999 Hannu Mallat All rights reserved
Copyright (c) 2011 Vista Silicon S.L. Javier Martin <javier.martin@vista-silicon.com>
Copyright (C) 2018 NXP Semiconductor.
Copyright (C) 2018 Olimex Ltd. Author: Stefan Mavrodiev <stefan@olimex.com>
Copyright (C) 2013 Wolfram Sang <wsa@sang-engineering.com>
Copyright (C) 1995, 1999 Ralf Baechle
Copyright (C) 2007 Alan Stern
(C) 2004 Dominik Brodowski
Copyright (c) 2000-2003,2005 Silicon Graphics, Inc.
Copyright 1996,1997 David S. Miller (davem@caip.rutgers.edu)
Copyright (c) 2012-2018 Cirrus Logic, Inc. and Cirrus Logic International Semiconductor Ltd.
Copyright (c) 2009-2010 by: Mauro Carvalho Chehab
Copyright 1999-2007 H. Peter Anvin - All Rights Reserved
(c) 2000 Manfred Spraul;(c) 2002 Manfred Spraul
Copyright (C) 2012-2013 Texas Instruments Incorporated - http://www.ti.com Author: Keshava Munegowda <keshava_mgowda@ti.com> Author: Roger Quadros <rogerq@ti.com>
Copyright (C) 2003-2013 Jozsef Kadlec <kadlec@netfilter.org>
Copyright (C) 2012, 2013 Renesas Solutions Corp.
Copyright (C) 2012 Texas Instruments Author: Tomi Valkeinen <tomi.valkeinen@ti.com>
Copyright (C) 2010 IBM Corporation
Copyright (c) 2007-2011 Atheros Communications Inc.
Copyright (C) 2008 Paul Mundt
Copyright Stephan Mueller <smueller@chronox.de>, 2015
Copyright IBM Corp. 2008, 2014

LICENCE TERMS (cont.)

Copyright IBM Corp. 2010 Author(s): Hendrik Brueckner <brueckner@linux.vnet.ibm.com>
copyright Chris Mason 2000
(c) 2017 Tobin C. Harding <me@tobin.cc>
(c) 2011 Jiri Olsa <jolsa@redhat.com>
(c) MontaVista Software, Inc.:(C) 2006-2007 MontaVista Software
Copyright (C) 2014 Intel Corp Author: Subhransu S. Prusty <subhransu.s.prusty@intel.com>
Copyright (C) 2010-2011 Analog Devices Inc.
Copyright (C) 2006 Pavel Emelyanov <xemul@openvz.org> OpenVZ, SWsoft Inc.
(c) Copyright 2014 Panasonic Corporation;(c) Copyright 2016 Socionext Inc. All rights reserved.
Copyright 2017 Intel Corporation. All rights reserved.
Copyright (C) 2010 Jason Wessel <jason.wessel@windriver.com>
Copyright (C) 2009 Arnd Bergmann <arnd@arndb.de>
Copyright (c) 2012 Coraid, Inc. See COPYING for GPL terms. */
Copyright (C) 2000 Benjamin Herrenschmidt
Copyright (C) 2012, Samsung Electronics Co., Ltd.
Copyright (C) International Business Machines Corp., 2002, 2011 Etersoft, 2012 Author(s): Pavel Shilovsky
(pshilovsky@samba.org), Steve French (sfrench@us.ibm.com)
Copyright (C) 2001-2006 Tensilica Inc.
Copyright (C) 1998,99 Takashi Iwai
Copyright (C) 1999,2000,2004,2005,2012 MIPS Technologies, Inc. All rights reserved. Authors: Carsten Langgaard
<carstenl@mips.com> Maciej W. Rozycki <macro@mips.com> Steven J. Hill <sjhill@mips.com>
Copyright: (C) 2010-2012 Nicolas Palix.
Copyright (C) 2017 Oracle Corporation Authors: Hans de Goede <hdegoede@redhat.com>
Copyright (C) 2010-2015 Freescale Semiconductor, Inc.
Copyright (C) 2012-2016 Mentor Graphics Inc.
copyright (C) 2003 Russell King, PXA MMCI Driver
Copyright 2016 Rockwell Collins
Copyright (C) 2013-2015 Josh Poimboeuf <jpoimboe@redhat.com>
Copyright (C) 2015 Wolfram Sang <wsa@sang-engineering.com>
Copyright IBM Corp. 2012, 2019 Author(s): Holger Dengler <hd@linux.vnet.ibm.com>
Copyright (C) 2006-2008 Nokia Corporation.
Copyright (C) 2007-2009 ST-Ericsson AB Driver to read out OTP from the AB3100 Mixed-signal circuit Author: Linus
Walleij <linus.walleij@stericsson.com>
Copyright (c) 2016 Intel Corporation. Author: Sakari Ailus <sakari.ailus@linux.intel.com>
Copyright (C) 2016 BayLibre, Inc
Copyright (C) 2003 Anton Blanchard <anton@au.ibm.com>, IBM Rework, based on alpha PCI code.
Copyright (C) 2001 Deep Blue Solutions Ltd. Modified by Catalin Marines for noMMU support
Copyright (C) 1997-2011 AudioScience Inc. <support@audioscience.com>;(C) Copyright AudioScience Inc. 1997-
2003
Copyright (C) 2007 Cambridge Silicon Radio Ltd.
Copyright (c) 2000 Jaroslav Kysela <perex@perex.cz> 2002 James Stafford <jstafford@ampltd.com> 2003 Takashi
Iwai <tiwai@suse.de>
Copyright (C) 1994 Bjoern Brauel
Copyright(c) 2008 Intel Corporation.
Copyright (C) 2000 Holger Waechtler <holger@convergence.de> for convergence integrated media GmbH
Copyright (c) 2018 Hanno Zulla <kontakt@hanno.de>
Copyright (C) 2006-2007 Atmel Norway
Copyright (c) 2011 Samsung Electronics Co., Ltd. Author: Inki Dae <inki.dae@samsung.com>
Copyright (c) 2013-2016, Intel Corporation. All rights reserved. Intel Management Engine Interface (Intel MEI) Linux
driver
Copyright (C) 2002 Linus Torvalds. License: GPL
Copyright(c) 2008, RealTEK Technology Inc. All Right Reserved.
Copyright 2017 Icenowy Zheng <icenowy@aosc.io>
Copyright (c) 2005 Intel Inc. All rights reserved.
Copyright 2009-2017 Analog Devices Inc.
Copyright (C) 2009 Sascha Hauer, Pengutronix
Copyright (C) 2008 CompuLab, Ltd. Mike Rapoport <mike@compulab.co.il>

Copyright (C) 2007 Thomas Bogendorfer (tsbogend@alpha.frankende)
Copyright (c) 2005-2006, 2014, Ericsson AB
Copyright (c) 2000 Jaroslav Kysela <perex@perex.cz>
Copyright (c) 2014 Samsung Electronics Co., Ltd Author: Chanwoo Choi <cw00.choi@samsung.com>
(C) Texas Instruments, Inc. http://www.ti.com/
Copyright (C) 2004 - 2005 Nokia Corporation Partial timer rewrite and additional dynamic tick timer support by Tony
Lindgen <tony@atomide.com> and Tuukka Tikkanen <tuukka.tikkanen@elektrobit.com>
Copyright (C) 1995,1997,2008,2009,2012 David S. Miller (davem@davemloft.net)
Copyright 2002 James Simmons
Copyright (C) 2012 Texas Instruments Incorporated - http://www.ti.com All rights reserved.
Copyright (c) [xxxx]-[xxxx] [Owner Organization] All rights reserved.
Copyright (C) Miroslav Lichvar <mlichvar@redhat.com> 2017
Copyright (C) 2019 Clément Péron <peron.clem@gmail.com>
Copyright (C) 2015 STMicroelectronics (R&D) Limited. Author: Maxime Coquelin <maxime.coquelin@st.com>
Copyright (C) 2011-2015 Freescale Semiconductor, Inc.
Copyright (C) 2015, 2016 Intel Corporation Author: Mika Westerberg <mika.westerberg@linux.intel.com>
Copyright (C) 2013, 2014 Horms Solutions Ltd.
Copyright (C) 2009 Marek Vasut <marek.vasut@gmail.com>
Copyright (C) 2009 Intel corporation
Copyright (c) 2015 Vladimir Zapolskiy <vz@mleia.com>
Copyright (C) 1999-2005, Greg Ungerer (gerg@snapgear.com)
(C) Copyright 2013 Intel Corporation
Copyright 2011, Netlogic Microsystems Inc.
Copyright (C) 2004-6 Patrick Boettcher (patrick.boettcher@posteo.de)
Copyright (C) 2016 Thomas Gleixner.
Copyright (C) 2012 Hans-Frieder Vogt <hfvogt@gmx.net> partially based on driver code from Fitipower
Copyright (C) 1996, 1997 Ingo Molnar, Miguel de Icaza, Gadi Oxman
Copyright (c) 2003 by Giuliano Pochini <pochini@shiny.it>
Copyright (C) 2009 Nobuhiro Iwamatsu <iwamatsu.nobuhiro@renesas.com>
Copyright (C) 2015 FUJITSU LIMITED Author: Taku Izumi <izumi.taku@jp.fujitsu.com>
Copyright IBM Corp. 2003, 2008
Copyright (C) 2015 Microchip Technology, Inc.
Copyright IBM Corp. 2012, 2013 Author(s): Hendrik Brueckner <brueckner@linux.vnet.ibm.com>
Copyright (C) 2013 NVIDIA Corporation
Copyright (c) 2018 Microsemi Corporation
Copyright (C) 2016 CogentEmbedded Inc Author: Andrey Gusakov <andrey.gusakov@cogentembedded.com>
Copyright (C) 2007-2017 Cavium, Inc.:(c) Copyright 1996-1997 Alan Cox <alan@lxorguk.ukuu.org.uk>, All Rights
Reserved.:(c) Copyright 1995 Alan Cox <alan@lxorguk.ukuu.org.uk>
(C) Copyright 2004, 2005 Cavium Networks
(C) Copyright 1999-2000, Moreton Bay (www.moretonbay.com);(C) Copyright 2000-2001, Lineo Inc. (www.lineo.
com);(C) Copyright 2001-2002, SnapGear Inc., (www.snapgear.com)
Copyright (C) Pavel Machek, pavel@ucw.cz.
Copyright (C) 2014 Google, Inc.
Copyright 2002 by Andi Kleen, SuSE Labs with some code from asm-x86/checksum.h
Copyright 2013 Linaro Ltd.
Copyright (C) 2015 Toradex AG.
Copyright (C) 2011, 2017, 2018 Maciej S. Szmigiero (mail@maciej.szmigiero.name)
Copyright (C) 2012-2017 Cavium Inc. Authors: David Daney <david.daney@cavium.com> Peter Swain <pswain@
cavium.com> Steven J. Hill <steven.hill@cavium.com> Jan Glauber <jglauber@cavium.com>
Copyright (C) 2008 Mercury IMC Ltd Written by Mark Jackson <mpfj@mimc.co.uk>
Copyright (c) 2016-2018 Mellanox Technologies. All rights reserved.
Copyright (C) 2012-2014 Intel Corporation
Copyright (c) by 2007 Joachim Foerster <JOFT@gmx.de>
Copyright 2009-2012 Freescale Semiconductor, Inc.
Copyright (c) Red Hat <mjg@redhat.com> Based on code from Pommed:
Copyright (c) International Business Machines Corp., 2008 Author(s): Steve French (sfrench@us.ibm.com) Wang Lei
(wang840925@gmail.com)

LICENCE TERMS (cont.)

Copyright (c) 2003-2005 AMD, Personal Connectivity Solutions
Copyright (C) 1994, 1996, 1998, 1999 Free Software Foundation, Inc.
Copyright (C) International Business Machines Corp., 2002,2011 Etersoft, 2012 Author(s): Steve French (sfrench@us.ibm.com) Pavel Shilovsky (pshilovsky@samba.org) 2012
Copyright (c) 2011 by: Mauro Carvalho Chehab
Copyright 2006, Segher Boessenkool, IBM Corporation.
Copyright (c) 2017-2019, Linaro Ltd. Author: Georgi Djakov <georgi.djakov@linaro.org>
Copyright (c) 2005 Embedded Alley Solutions, Inc. Matt Porter <mporter@embeddedalley.com>
Copyright (C) 2007-2016, VMware, Inc. All Rights Reserved.
Copyright © 2016 Andrew Lunn <andrew@lunn.ch>
Copyright (c) 2010, 2014 Samsung Electronics http://www.samsung.com/
Copyright 2013 Sascha Hauer <s.hauer@pengutronix.de>
Copyright (c) 1997-2000 LAN Media Corporation (LMC) All rights reserved. www.lanmedia.com
Copyright (C) 2016 Marvell International Ltd.
Copyright 1998 C. van Schaik <carl@leg.uct.ac.za>
Copyright (c) 2008, 2018 Oracle and/or its affiliates. All rights reserved.
Copyright (c) 2011 John Crispin <john@phrozen.org>
Copyright (C) 2003-2004 Intel
Copyright (c) 2001 Matthew Wilcox for Hewlett Packard
Copyright (c) 2000-2003 Adaptec Inc. All rights reserved.
Copyright (c) 2018 Nuvoton Technologies, Avi Fishman <avi.fishman@nuvoton.com> <avifishman70@gmail.com>
Tomer Maimon <tomer.maimon@nuvoton.com> <tmaimon77@gmail.com>
Copyright 2008 GE Intelligent Platforms Embedded Systems, Inc.
Copyright IBM Corp. 1999, 2009
Copyright (c) 2018 Bitmain Ltd.
Copyright (c) 2013 Stefan Achatz <erazor_de@users.sourceforge.net>
Copyright (c) 2014 LSI Corporation
Copyright (c) 2010 Johnathon Harris <jmharris@gmail.com>
Copyright © 2012 John Crispin <john@phrozen.org>
Copyright (C) 2003 Andriy Skulysch
Copyright (C) 1992 by Linus Torvalds based on ideas by Darren Senn
Copyright (C) 2000 - 2007 Jeff Dike (jdike@{addtoit,linux.intel}.com)
Copyright 2017 IBM Corp. include "ocxl_internal.h"
Copyright (C) 2006-2007 Bernhard Kaindl <bk@suse.de>
Copyright (c) 2010 Secret Lab Technologies, Ltd.
Copyright (C) 2011 Max Planck Institute for Gravitational Physics
Copyright: [copy] 2005-2010: Thomas Gleixner
Copyright (C) 2004 Linda Xie <lxie@us.ibm.com>
Copyright 2009 Simtec Electronics http://www.simtec.co.uk/ Ben Dooks <ben@simtec.co.uk>
Copyright (C) 2012 CERN (www.cern.ch) Author: Alessandro Rubini <rubini@gnudd.com>
(c) 1996 Hans-Joachim Widmaier - Rewritten;(C) 1993 Ray Burr - Amiga FFS filesystem.
Copyright (C) 1999 Benjamin Herrenschmidt (benh@kernel.crashing.org) and Paul Mackerras (paulus@samba.org).
Copyright (c) 2002, 2003 Gary Thomas (<gary@mlbassoc.com>
Copyright (C) 2009 Rafael J. Wysocki <rjw@sisk.pl>, Novell Inc.
Copyright 2008 rPath, Inc. - All Rights Reserved
Copyright (c) 2018 MediaTek Inc. Author: Owen Chen <owen.chen@mediatek.com>
Copyright (C) 2007-2009 Rodolfo Giometti <giometti@linux.it>
Copyright 2018 Maxime Roussin-Belanger <maxime.roussinbelanger@gmail.com>
Copyright (C) 1997-2001 David Woodhouse
Copyright IBM Corp. 1999, 2000 Author(s): Hartmut Penner (hp@de.ibm.com)
Copyright (C) 2007-2010, 2011-2012 Synopsys, Inc. (www.synopsys.com)
(c) 2007 Michal Januszewski <spock@gentoo.org>
Copyright (C) 2011 Philippe Réturnaz
Copyright © 2004 Ferenc Havasi <havasi@inf.u-szeged.hu>, University of Szeged, Hungary
(c) 1993,2000 by Joerg Reuter DL1BKE <jreuter@yaina.de>;(c) 1993 Guido ten Dolle PE1NZZ
(c) Jan Andersson <jan@gaisler.com>;(c) Valentine Barshak <vbarshak@ru.mvista.com> and in turn based on "ehci-ppc-soc.c" by Stefan Roese <sr@denx.de> and "ohci-ppc-of.c" by Sylvain Munaut <tnt@246tnt.com>

Copyright (c) 2000 Justin Cormack
Copyright (c) 2013 Samsung Electronics Co., Ltd
Copyright 2006-2008, IBM Corporation.
Copyright 2012 (C), Jason Cooper <jason@lakedaemon.net>
Copyright (C) 2009-2010 IBM Corporation
Copyright (c) 2018 Oracle. All rights reserved.
Copyright (C) Andrea Merello 2004-2005 <andrea.merello@gmail.com>
Copyright (c) IBM Corporation 2009 Author: Mel Gorman <mel@csn.ul.ie>
Copyright (C) 2001 - 2002 Greg Kroah-Hartman (greg@kroah.com)
(C) Copyright 1995 1996 Linus Torvalds Hacked for ARM by Phil Blundell <philb@gnu.org>
Copyright 2014 Oleksij Rempel <linux@rempel-privat.de> Provide Alphascale ASM9260 support.
Copyright 2001, 2007-2008 MontaVista Software Inc. Author: MontaVista Software, Inc. <source@mvista.com>
Copyright (C) 2007-2012 Steven Rostedt <strosedt@redhat.com>
Copyright(c) 2015-2017 Intel Deutschland GmbH
Copyright (C) 2017 Collabora Ltd.
Copyright (c) 2005 Roger Lucas <vt8231@hiddenengine.co.uk>
Copyright (c) 1997-1999 by Paul Barton-Davis <pbdb@op.net>
Copyright IBM Corp. 2001, 2009;(C) 2001 IBM Corporation by Fritz Elfert (felfert@millenium.com)
Copyright (C) 2013-2017 Broadcom
Copyright (C) 2005-2006 Thibaut VARENE <varenet@parisc-linux.org>
Copyright (c) 2003-2005 IBM Corp. Dave Engebretsen engebret@us.ibm.com Santiago Leon santil@us.ibm.com
Hollis Blanchard <hollisb@us.ibm.com> Stephen Rothwell
Copyright (C) Altera Corporation 1998-2001
Copyright (c) 2005, 2006, 2007, 2008 Mellanox Technologies. All rights reserved.
(C) 2003 Red Hat, Inc.
Copyright (c) 2010 Samsung Electronics http://www.samsung.com/
Copyright (c) 2005 by Tilman Schmidt <tilman@imap.cc>, Hansjoerg Lipp <hjiipp@web.de>.
Copyright(C) 2015 Intel Ltd
Copyright (c) 2016 Intel Corporation Author: Ross Zwisler <ross.zwisler@linux.intel.com> Author: Matthew Wilcox <matthew.r.wilcox@intel.com>
Copyright 2015 Linaro Ltd
Copyright (C) 2011, 2012 by Wolfram Sang, Pengutronix e.K.
Copyright (C) 2012-2013 Philippe De Muyter <phdm@macqel.be>
Copyright (C) 2009 Compulab, Ltd. Mike Rapoport <mike@compulab.co.il> Igor Grinberg <grinberg@compulab.co.il>
Copyright 2016 Christophe Leroy, CS Systemes d'Information
Copyright 2009-2010 Ben Dooks <ben-linux@fluff.org>
Copyright (C) 2002 Takashi Iwai <tiwai@suse.de>
Copyright (C) 2008 Yoichi Yuasa <yuasa@linux-mips.org>
Copyright 2009 Novell. All Rights Reserved.
Copyright (C) 2014 Mauro Carvalho Chehab <mchehab+samsung@kernel.org>
Copyright (C) 2014 Ulrich Hecht
Copyright (C) 2008 Harrison Metzger <harrisonmetz@gmail.com> Based on usbled.c by Greg Kroah-Hartman (greg@kroah.com)
Copyright 2014, 2015 O.S. Systems Software LTDA.
Copyright (C) 2019 ARM Ltd. Author: Lorenzo Pieralisi <lorenzo.pieralisi@arm.com>
Copyright (C) 2015-2017 Texas Instruments Incorporated - http://www.ti.com/ J Keerthy <j-keerthy@ti.com> Dave Gerlach <d-gerlach@ti.com>
Copyright (C) 2005 Nokia Corporation Author: Paul Mundt <paul.mundt@nokia.com>
Copyright (c) 2005-2008 Simtec Electronics http://armlinux.simtec.co.uk/ Ben Dooks <ben@simtec.co.uk>
Copyright © 2009 Paul Mackerras, IBM Corporation.
Copyright (C) 2016, Freescale Semiconductor
Copyright (C) 2008 Oliver Endriss <o.endriss@gmx.de>
Copyright (C) 2015-2016 Texas Instruments Incorporated - http://www.ti.com/ Nishanth Menon
"Copyright (C) 2014 Texas Instruments Incorporated Authors: Santosh Shilimkar <santosh.shilimkar@ti.com> Sandeep Nair <sandeep_n@ti.com> Cyril Chemparathy <cyril@ti.com>"
Copyright: [copy] 2017-2018 NXP

LICENCE TERMS (cont.)

Copyright (C) 2002-2003 Eric Biederman <ebiederm@xmission.com>
Copyright (c) 2008 Gerrit Renker <gerrit@erg.abdn.ac.uk>
Copyright (C) 1999, 2000, 2002 Niibe Yutaka
Copyright (C) 2008-2009 The GameCube Linux Team
Copyright (c) Mauro Carvalho Chehab <mchehab@kernel.org>
Copyright (C) 2002 James Simmons <jsimmons@users.sf.net>
Copyright (C) 2008-2009 Samsung Electronics
Copyright (C) 2012,2015 Eric Dumazet <edumazet@google.com>
Copyright (c) 2015 Cumulus Networks
Copyright 1999 by Carsten Paeth (calle@calle.in-berlin.de)
Copyright (C) 2015-2016 Marvell International Ltd.
Copyright (C) 2014-2016 Zhang, Keguang <keguang.zhang@gmail.com>
Copyright (C)2002 USAGI/WIDE Project
Copyright (c) 2010 Alan Ott <alan@signal11.us>
Copyright 2003 MontaVista Software Inc. <source@mvista.com>
Copyright (C) 2016 Host Mobility AB. All rights reserved.
Copyright (c) 2004 Erik Rigtorp <erikki@linux.nu> <erik@rigtorp.com>
Copyright (C) 2015, Broadcom Corporation Author: Florian Fainelli <f.fainelli@gmail.com>
Copyright (C) Intel Corp.
Copyright (C) 2011 Neil Brown <neil@brown.name>
Copyright (C) 2014 Cadence Design Systems Inc.
Copyright (C) 2006, 2007 Eugene Konev
Copyright (C) 2009-2013 Texas Instruments, Inc.
Copyright (C) 2010, Intel Corp. Authors: Maxim Locktyukhin <maxim.locktyukhin@intel.com> Ronen Zohar <ronen.zohar@intel.com>
Copyright (C) 2014-2015 Altera Corporation. All rights reserved.
Copyright (C) 1996, 1997, 1998, 2001, 07, 08 by Ralf Baechle
Copyright 2012-2013 Analog Devices Inc.
Copyright (c) 2017 MediaTek Inc. Author: Sean Wang <sean.wang@mediatek.com>
Copyright © 2000 ARM Limited
Copyright (C) 2009-2010 Oracle Corp. All rights reserved. Author: Dan Magenheimer
Copyright (c) 2016 Golden Delicious Comp. GmbH&Co. KG Nikolaus Schaller <hns@goldelico.com>
Copyright (C) 2015 Broadcom Corporation
Copyright (C) 2009 Red Hat <mjg@redhat.com>
Copyright (C) 2019 ROHM Semiconductors
Copyright (C) 2017 Samsung Electronics Co., Ltd.
Copyright (C) 2008 Silicon Graphics, Inc. All Rights Reserved.
Copyright (c) 2013 by Jan Klötzke <jan@kloetzke.net>
Copyright (C) 2010, 2011 David S. Miller <davem@davemloft.net>
Copyright (C) 2014 Linaro Ltd <yazen.ghannam@linaro.org>
Copyright 2007, 2008 Wolfson Microelectronics PLC.
Copyright 2004 BEAM Ltd.
Copyright (C) 2010 - 2016 UNISYS CORPORATION All rights reserved.
Copyright (C) 2008-2010 Gabor Juhos <juhosg@openwrt.org>
Copyright (C) 2017-2018 Cogent Embedded Inc.
Copyright (C) 2005 Texas Instruments Incorporated
Copyright 2016 Michael Ellerman, IBM Corporation.
Copyright (C) 2001 Ingo Molnar <mingo@redhat.com>
Copyright (c) 1999,2001 by Jaroslav Kysela <perex@perex.cz>
(c) 2008 Mijhail Moreyra <mijhail.moreyra@gmail.com> Adapted from cx88-alsa.c;(c) 2009 Steven Toth <stoth@kernellabs.com>
Copyright (c) 2016 Intel Corporation Author: Ross Zwisler <ross.zwisler@linux.intel.com>
Copyright (C) 2018, Microsoft, Inc.
Copyright (C) 2017 by Changbin Du <changbin.du@intel.com>
Copyright (C) 1993,1995,1997 Australia. E-mail billm@suburbia.net |
Copyright (C) 2016 Broadcom Author: Jayachandran C <jchandra@broadcom.com>
"Copyright (C) 2012 Samsung Electronics Co.Ltd Authors: Inki Dae <inki.dae@samsung.com>;(c)

container_

of(c, struct vidi_context, \ connector)"
Copyright 2013: Jeff Layton <jlayton@redhat.com>
Copyright (c) 2015 MediaTek Inc. Author: Bayi Cheng <bayi.cheng@mediatek.com>
Copyright 2005 Mark Lord
(C) 2002 Harald Welte <laforge@gnumonks.org>;(C) 2000 by Matthew G. Marsh <mgm@paktronix.com>
Copyright (C) 2005 Robert Love <rml@novell.com>
Copyright (C) 2002-2005 Yoichi Yuasa <yuasa@linux-mips.org>
(C) Copyright 1999 Linus Torvalds;(C) Copyright 1999-2002 Johannes Erdfelt, johannes@erdfelt.com;(C) Copyright 1999 Randy Dunlap;(C) Copyright 1999 Georg Acher, acher@in.tum.de;(C) Copyright 1999 Deti Fliegl, deti@fliegl.de;(C) Copyright 1999 Thomas Sailer, sailer@ife.ee.ethz.ch;(C) Copyright 1999 Roman Weissgaerber, weissg@vienna.at;(C) Copyright 2000 Yggdrasil Computing, Inc. (port of new PCI interface support from usb-ohci.c by Adam Richter, adam@yggdrasil.com).;(C) Copyright 1999 Gregory P. Smith (from usb-ohci.c);(C) Copyright 2004-2007 Alan Stern, stern@rowland.harvard.edu
Copyright(c) 2015-2018 Intel Corporation.
Copyright (C) 2006 Sam Hocevar <sam@zoy.org>
Copyright(c) 2015 Intel Deutschland GmbH
Copyright 2013 Solarflare Communications Author: Ben Hutchings
Copyright 2018 Realtek Microelectronics
Copyright (C) 2018 Synopsys Author: Eugeniy Paltsev <Eugeniy.Paltsev@synopsys.com>
Copyright (c) 2006-2007 Jorge Boncompte - DTI2 <jorge@dti2.net>
Copyright (C) 2008, 2009 Renesas Technology Corp. All rights reserved.
Copyright(C) 2010 Corentin Chary <corentin.chary@gmail.com>
Copyright (C) 2009, 2011 Renesas Solutions Corp.
Copyright (c) 2015, Mellanox Technologies, Ltd. All rights reserved.
Copyright (C) 2006 Winbond Electronics Corp. Yuan Mu Rudolf Marek <r.marek@assembler.cz>
Copyright (C) 2009 Steven Toth <stoth@kernellabs.com>
Copyright (C) 2013 Free Electrons
Copyright (c) 2015 Cumulus Networks, Inc.
Copyright (C) 2001-2008 Silicon Graphics, Inc. All rights reserved.
Copyright (C) International Business Machines Corp., 2002,2010 Author(s): Steve French (sfrench@us.ibm.com) Jeremy Allison (jra@samba.org)
Copyright (C) 2006-2007 Texas Instruments, Inc.
Copyright (C) 2016-2018 Texas Instruments Incorporated - <http://www.ti.com/> Dave Gerlach
Copyright (C) 2007 Intel
Copyright (C) 2010 Texas Instruments Author: Archit Taneja <archit@ti.com>
Copyright (C) 2004-2005 Advanced Micro Devices, Inc.
Copyright (c) by Jaroslav Kysela <perex@perex.cz> Universal routines for AK4531 codec
Copyright (C) 2008 by Ralf Baechle (ralf@linux-mips.org)
Copyright (c) 2003-2006, Cluster File Systems, Inc, info@clusterfs.com Written by Alex Tomas <alex@clusterfs.com>
Copyright (C) 2008 Mike Christie
Copyright (C) 1992, 1998 Linus Torvalds, Ingo Molnar
Copyright © 2007 Eugene Konev <ejka@openwrt.org>
Copyright (C) 2001,2002,2003,2004 Broadcom Corporation
Copyright(c) 2018 Oracle and/or its affiliates. All rights reserved.
Copyright (c) 2004-2008 LSI Corporation.
Copyright (C) 2014-2015 Capella Microsystems Inc. Author: Kevin Tsai <ktsai@capellamicro.com>
Copyright (C) M'boumba Cedric Madianga 2017
Copyright (c) 2016 Yusuke Fujimaki <usk.fujimaki@gmail.com>
Copyright (c) 1999-2004 Geert Uytterhoeven <geert@linux-m68k.org>
(C) Copyright 2009 Renesas Solutions Corp
Copyright (c) 2000-2004 Silicon Graphics, Inc. All Rights Reserved.
Copyright (C) 2016 Intel. All rights reserved.
Copyright (C) 1996,1997,1998 Russell King
Copyright (C) 2005 Paul Mackerras, IBM Corp. <paulus@samba.org>
Copyright (C) 2002 MontaVista Software Inc. Author: Yoichi Yuasa <source@mvista.com>
Copyright (C) 2014 Gumstix, Inc. - <https://www.gumstix.com/>

LICENCE TERMS (cont.)

(C) Copyright 2003-2007, Greg Ungerer <gerg@uclinux.org>
Copyright (c) 1996 Paul Mackerras <paulus@cs.anu.edu.au>
Copyright (C) 2009 Renesas Solutions Corp. Kuninori Morimoto <morimoto.kuninori@renesas.com>
Copyright (C) 2011 Texas Corporation Felipe Balbi <balbi@ti.com> Santosh Shilimkar <santosh.shilimkar@ti.com>
sricharan <r.sricharan@ti.com>
Copyright(c) 2018-19 Canonical Corporation.
Copyright 2012 Linaro Ltd
(c) The contribution was provided directly to me by some other
Copyright © 2012 Rafał Milecki <zajec5@gmail.com>
Copyright (C) 2010 Ed Spiridonov <edo.rus@gmail.com>
Copyright (C) 2006 ARM Ltd. written by Russell King, Deep Blue Solutions Ltd.
Copyright (C) 1991, 1992 Linus Torvalds.
Copyright (C) 2016 Jeremy Kerr <jk@ozlabs.org>, IBM Corp.
"Copyright: 2005-2008 Wolfson Microelectronics. PLC."
Copyright IBM Corp. 2001, 2009 Authors: Malcolm Beattie <beattiem@uk.ibm.com> Michael Holzheu <holzheu@de.ibm.com> Frank Munzert <munzert@de.ibm.com>
Copyright (C) 2001 Tensilica, Inc. by Kevin Chea Optimized by Joe Taylor
Copyright (c) 1998 Harald Koerfgen
Copyright (C) 2001-2007 Greg Kroah-Hartman (greg@kroah.com)
Copyright (C) 2007, 2008, 2009 Oracle Corporation Written by: Martin K. Petersen <martin.petersen@oracle.com>
Copyright (c) 2008 Steven Toth <stoth@linuxtv.org>
Copyright (C) 2005-2009, 2010 Cavium Networks
Copyright (C) 2010 MIPS Technologies, Inc.
Copyright (c) 2014 Scott Feldman <sfeldma@cumulusnetworks.com>
Copyright (c) 2000 Markus Demleitner <msdemlei@cl.uni-heidelberg.de>
Copyright(C) 2007, 2008 Wolfson Microelectronics PLC.
Copyright (C) 1996 Simon G. Vogl 1999 Hans Berglund
Copyright (c) 2009-2012 Freescale Semiconductor, Inc All rights reserved.
Copyright (C) 2013 Cogent Embedded, Inc.
Copyright (c) 2018 Synopsys, Inc. and/or its affiliates. stmmac HW Interface Callbacks
Copyright (c) 2016 Google, Inc
(C) Copyright 2009-2010 Nokia Siemens Networks, michael.lawnick.ext@nsn.com
Copyright (C) 2007 MIPS Technologies, Inc. Chris Dearman (chris@mips.com)
Copyright (C) 2015 Martin Willi
Copyright (C) 1999, 2007, 2008 David S. Miller (davem@davemloft.net)
Copyright (c) 2018 Intel Corporation
Copyright (c) 2013 Texas Instruments Incorporated Author: Joel Fernandes <joelf@ti.com>
(C) 2010 Michael J. Cree
Copyright (c) 2002, 2003, 2005 Maciej W. Rozycki
Copyright (C) 1995-1998 Mark Adler
Copyright (C) 2004-2007 Marcel Holtmann <marcel@holtmann.org>
Copyright (c) 2016 Mellanox Technologies, LTD. All rights reserved.
Copyright (C) 2003, 2004 Oracle. All rights reserved.
(c) 2005 Hans J. Koch
(c) 2004 Jelle Foks <jelle@foks.us>;(c) 2004 Chris Pascoe <c.pascoe@itee.uq.edu.au>;(c) 2004 Gerd Knorr <kxaxel@bytesex.org>
Copyright (C) 2010 Red Hat, Inc. All Rights Reserved.
Copyright (c) 2006,2007 The Regents of the University of Michigan. All rights reserved.
Copyright (c) 2001, 2003 Maciej W. Rozycki
Copyright 2009 CompuLab, Ltd.
Copyright 2011 bct electronic GmbH
Copyright (C) 1996,2005 David S. Miller (davem@davemloft.net)
Copyright 2013 Wills Wang
(C) Copyright 2017 Intel Corporation Author: Andy Shevchenko <andriy.shevchenko@linux.intel.com>
copyright 2016 google inc.
Copyright (C) 2016 Intel Corp Author: Shreyas NC <shreyas.nc@intel.com>
Copyright (C) 2016 Helge Deller <deller@gmx.de>

Copyright (C) 2013 Freescale Semiconductor, Inc. Author: Varun Sethi <varun.sethi@freescale.com>
Copyright (C) 2012 Horms Solutions Ltd.
Copyright 2019 YADRO dts-v1/;
(c) 1999 Dr. Henrik Seidel <Henrik.Seidel@gmx.de>
Copyright 2009 Intel Corp. Author: Huang Ying <ying.huang@intel.com>
Copyright (C) 2004 Sascha Hauer, Pengutronix
Copyright (C) 2001-2003 Russell King, All Rights Reserved.
(C) COPYRIGHT 2018 ARM Limited. All rights reserved. Author: James.Qian.Wang <james.qian.wang@arm.com>
Copyright (c) 2013-2014 Intel Corp.
Copyright 2007, Michael Ellerman, IBM Corporation.
Copyright (c) 1998, 1999 Frodo Looijaard <frodol@dds.nl> and Philip Edelbrock <phil@netroedge.com>
Copyright (C) 2017 Alexandre Belloni
Copyright 2003-2008 Simtec Electronics Ben Dooks <ben@simtec.co.uk>
Copyright (C) 1997-2004 Erez Zadok
Copyright (c) 2010-2011 Samsung Electronics Co., Ltd. http://www.samsung.com/
Copyright (C) 2001-2003 Stelian Pop <stelian@popies.net>
Copyright (C) 2006 Simtec Electronics Ben Dooks <ben@simtec.co.uk> Vincent Sanders <vince@simtec.co.uk>
Copyright (C) 2001-2004 FarSite Communications Ltd. www.farsite.co.uk;(c) 2001-2004 FarSite Communications Ltd.
Copyright (C) 2015 Dennis Menschel
Copyright (c) 2017 Pablo M. Bermudo Garay <pablombg@gmail.com>
Copyright (C) 2014-2015 Chen-Yu Tsai <wens@csie.org>
Copyright (C) 2014, Red Hat Inc, Arnaldo Carvalho de Melo <acme@redhat.com>
Copyright 2011 Google, Inc.
Copyright (C) ST-Ericsson SA 2010 Author: Shujuan Chen <shujuan.chen@stericsson.com> for ST-Ericsson.
Author: Jonas Linde <jonas.linde@stericsson.com> for ST-Ericsson. Author: Niklas Hernaes <niklas.hernaes@stericsson.com> for ST-Ericsson. Author: Joakim Bech <joakim.xx.bech@stericsson.com>
Copyright (C) 2005-9 DiBcom (http://www.dibcom.fr/)
Copyright (C) 2007 International Business Machines Corp. Author(s): Michael A. Halcrow <mahalcro@us.ibm.com>
Copyright (C) 2008-2010 Samsung Electronics Kyungmin Park <kyungmin.park@samsung.com>
Copyright (C) 2002-2008 Krzysztof Halasa <khc@pm.waw.pl>
Copyright (C) 2005 MEV Ltd. <http://www.mev.co.uk/>
(c) 1995 by Michael Schlueter & Michael Marte
Copyright (c) 2010 Vasily Khoruzhick <anarsoul@gmail.com>
Copyright (C) 2013 Texas Instruments Inc. Contact: Eduardo Valentin <eduardo.valentin@ti.com> Tero Kristo <t-kristo@ti.com>
Copyright (C) 2000-2001 Ralph Metzler <ralph@convergence.de> Marcus Metzler <marcus@convergence.de> for convergence integrated media GmbH
Copyright (C) 1996-2002 Russell King
Copyright 2005 Simtec Electronics http://www.simtec.co.uk/products/ Ben Dooks <ben@simtec.co.uk>
Copyright (C) 2003 IBM Corporation
(C) 2007 by Holger Schurig <hs4233@mail.mn-solutions.de>
Copyright 2005 Freescale Semiconductor, Inc.
Copyright (c) 2011,2016 Samsung Electronics Co., Ltd. http://www.samsung.com
(C) Copyright 2008-2010,2015 Intel Corporation Author: Sreedhara DS (sreedhara.ds@intel.com)
Copyright (C) 2005, Jaya Kumar <jayalk@intworks.biz>
Copyright (C) 2015 ARM Ltd.
Copyright (c) 2008-2010 Rafi Rubin
Copyright (c) 2011 Rafał Milecki <zajec5@gmail.com>
Copyright (C) 2016 AceLan Kao <acelan.kao@canonical.com>
Copyright (C) 2012-2013 Xilinx
"Copyright:(C) 2013 Sergei Ivanovich <yvich@gmail.com>"
Copyright (C) 2017 Facebook. All rights reserved.
Copyright (C) 2014 Freescale Semiconductor.
Copyright (C) 2009-2015 Cavium, Inc.
Copyright IBM Corp. 1999,2001
(C) Copyright Linaro 2015v2

LICENCE TERMS (cont.)

Copyright (C) 2001 Peter Bergner
(C) 2004 Nadia Yvette Chambers, Oracle
(C) 2001 Dimitromanolakis Apostolos <apdim@grecian.net>;(c) 2006, 2007 by Mauro Carvalho Chehab <mchehab@kernel.org>
Copyright (C) 2000 YAEGASHI Takeshi Hitachi HD64461 companion chip support
Copyright 2018~2019 NXP
Copyright (C) 2001 - 2008 Tensilica Inc.
(C) 1992, 1993, 1994 Eric Youngdale Modified for ISO 9660 filesystem.:(C) 1991 Linus Torvalds - minix filesystem
Copyright (c) 2006-2007 Freescale Semiconductor, Inc.
Copyright(c) 2016, 2017 Intel Corporation.
Copyright 2013 Oliver Schinagl
Copyright Stephan Mueller <smueller@chronox.de>, 2014
Copyright IBM Corp. 2017, 2018 Author(s): Harald Freudenberger
Copyright (c) 2017 Cavium Inc.
Copyright (c) 2007 Nokia Siemens Networks - Mikko Herranen <mh1@iki.fi>
Copyright (c) 2014, The Linux Foundation. All rights reserved. */
Copyright (C) 1996-1998 Martin Mares <mj@atrey.karlin.mff.cuni.cz>
Copyright (C) 2015 CNEX Labs. All rights reserved.
Copyright 2003,2004 Ben. Herrenschmidt <benh@kernel.crashing.org>
Copyright (c) 2016 Intel Corporation. Author: Andy Shevchenko <andriy.shevchenko@linux.intel.com>
Copyright (C) 2015 Hisilicon Limited, All Rights Reserved. Author: Jun Ma <majun258@huawei.com> Author: Yun Wu <wuyun.wu@huawei.com>
Copyright (C) 2012 Intel Corp Author: Durgadoss R <durgadoss.r@intel.com>
Copyright (C) 2001 - 2003 Sistina Software (UK) Limited.
Copyright (C) 1995 Geert Uytterhoeven
Copyright (c) 2009 Samsung Electronics Co. Ltd Author: Jaswinder Singh <jassinghbrar@gmail.com>
Copyright (C) 2009 DSLab, Lanzhou University, China Author: Wu Zhangjin <wuzhangjin@gmail.com>
Copyright (C) 2007 Arnaud Patard <arnaud.patard@rtp-net.org>
Copyright (C) 2008-2016 Freescale Semiconductor, Inc. All Rights Reserved.
Copyright (C) 2005 Rusty Russell IBM Corporation
Copyright (c) 2013-2018, Mellanox Technologies. All rights reserved.
Copyright (C) 1995-1996 Linus Torvalds & author (see below)
Copyright (C) 2013 Linaro Ltd; <roy.franz@linaro.org>
Copyright (C) 1999, 2000, 2004 MIPS Technologies, Inc. All rights reserved. Authors: Carsten Langgaard <carstenl@mips.com> Maciej W. Rozycki <macro@mips.com>
Copyright 2004 SuperH (UK) Ltd Author: Richard Curnow
Copyright (C) 2014 Intel Corp. Author: Rafael J. Wysocki <rafael.j.wysocki@intel.com>
Copyright 2006-11 One Laptop Per Child Association, Inc.
Copyright (c) Phil Blundell <pb@nexus.co.uk>, 1998;(c) Copyright 1996 Alan Cox <alan@lxorguk.ukuu.org.uk>, All Rights Reserved.
Copyright (C) 2012 Vista Silicon S.L. Javier Martin, <javier.martin@vista-silicon.com> Xavier Duret
Copyright (c) 2002,2003 Alexander Malyshev <amalysh@web.de>
Copyright (c) 2008-2009 Rodolfo Giometti <giometti@linux.it>
Copyright (C) 2010 SecretLab Grant Likely <grant@secretlab.ca> John Bonesio <bones@secretlab.ca>
Copyright 2007 Openmoko Inc Author: Graeme Gregory <graeme@openmoko.org>
Copyright (C) 2004 by FS Forth-Systeme GmbH All rights reserved.
Copyright (C) 2017 Arm Ltd.
Copyright (C) 2010, Paul Cercueil <paul@crapouillou.net> JZ4740 Watchdog driver
(C) Copyright IBM Corporation 2001-2005;(C) Copyright Red Hat, Inc. 2005
Copyright © 2015 Keith Packard <keithp@keithp.com>
Copyright IBM Corp. 1999, 2007 Author(s): Martin Schwidefsky (schwidefsky@de.ibm.com), Christian Borntraeger (cborntra@de.ibm.com),
(c) 2014 ST Microelectronics
Copyright (c) 2018 Intel Corporation
Copyright (C) 2018 O.S. Systems Software LTDA.
Copyright (c) 2016-2017 Hans de Goede <hdegoede@redhat.com>
Copyright (C) 2009 Kyle Guinn <elyk03@gmail.com>

Copyright 2015 Heiko Stuebner <heiko@sntech.de>
Copyright IBM Corp. 2000, 2008 Author(s): Utz Bacher <utz.bacher@de.ibm.com> Jan Glauber <jang@linux.vnet.ibm.com> 2.6 cio integration by Cornelia Huck <cornelia.huck@de.ibm.com>
Copyright (c) 2014 SUSE LINUX Products GmbH
Copyright 2003, 2004, 2005, 2006, 2007, 2008 Wolfson Microelectronics PLC. Author: Liam Girdwood <lrg@slimlogic.co.uk>
Copyright (C) 2014 Boris Brezillon Boris Brezillon <boris.brezillon@free-electrons.com>
Copyright (C) 2015-2016 Free Electrons
Copyright (C) 2006 Dominik Kühlen Based on Inbp21.h
Copyright (C) 2017 Texas Instruments Incorporated - http://www.ti.com/ Keerthy <j-keerthy@ti.com>
Copyright 2005-2006 Fen Systems Ltd.
Copyright (C) 2006 Lennart Poettering
Copyright 2008 NXP Semiconductors Daniel Laird <daniel.j.laird@nxp.com> Andre McCurdy <andre.mccurdy@nxp.com>;(c) Copyright 2002 Guido Guenther <agx@sigxcpu.org>, All Rights Reserved.
Copyright (C) 2003 Intel Corporation Venki Pallipadi;(c) Copyright 2004 Hewlett-Packard Development Company, L.P. Bob Picco <robert.picco@hp.com>
Copyright (C) 2016 Luc Maranget <luc.maranget@inria.fr>
Copyright (C) 2016 STMicroelectronics (R&D) Limited Author: Giuseppe Cavallaro <peppe.cavallaro@st.com>
Copyright (C) 2015 IT University of Copenhagen (rrpc.h)
Copyright (C) 2005-2006 Harald Welte <laforge@openezx.org>, 2007-2008 Daniel Ribeiro <drwirm@gmail.com>, 2007-2008 Stefan Schmidt <stefan@datenfreihafen.org>
Copyright (C) 2001 Romain Dolbeau <romain@dolbeau.org>.
Copyright (C) 2002 Toshiba Corporation
Copyright (c) 2008 Richard Lemon;(c) Vojtech Pavlik and Dan Streetman
Copyright (c) 2004 Helge Deller <deller@gmx.de>
Copyright (C) 2011 Texas Instruments Incorporated - http://www.ti.com/ Author: Chandrabhanu Mahapatra <cmahapatra@ti.com>
Copyright 2005 (c) Andriy Skulysh <askulysh@gmail.com>
Copyright (c) 2016-2019 Mentor Graphics Inc.
Copyright: (C) 2015 Intel Corp. Options
Copyright 2016 NXP
Copyright (C) 1992-1997, 1999 Silicon Graphics, Inc.
Copyright (C) 2000 Greg Banks, Mitch Davis
Copyright 2010 Ilya Yanok, Emcraft Systems, yanok@emcraft.com
(C) 2001 Dave Jones, Arjan van de ven.:(C) 2002 - 2003 Dominik Brodowski <linux@brodo.de>
Copyright (c) 2017 Cadence Cadence PCIe host controller driver. Author: Cyrille Pitchen <cyrille.pitchen@free-electrons.com>
Copyright (c) 2010 Jean-Francois Dagenais <dagenaisj@sonatest.com>
Copyright (C) 2001 Stefan Gmeiner <riddlebox@freesurf.ch>
Copyright (C) 2013-2014, Linaro Ltd. Author: Al Stone <al.stone@linaro.org> Author: Graeme Gregory <graeme.gregory@linaro.org> Author: Hanjun Guo <hanjun.guo@linaro.org>
Copyright (C) 2008 Shaohua Li <shaohua.li@intel.com>
Copyright (C) 2005 Brian Rogan <bcr6@cornell.edu>, IBM
Copyright 2015-16 Golden Delicious Computers
Copyright (C) 1999 Ingo Molnar <mingo@redhat.com>
Copyright IBM Corp. 2001, 2006 Author(s): Carsten Otte <cotte@de.ibm.com> Michael Holzheu <holzheu@de.ibm.com> Tuan Ngo-Anh <ngoanh@de.ibm.com> Martin Schwidefsky <schwidefsky@de.ibm.com>
Copyright (C) 2008-2012 Freescale Semiconductor, Inc. Authors: Andy Fleming <afleming@freescale.com> Timur Tabi <timur@freescale.com> Geoff Thorpe <Geoff.Thorpe@freescale.com>
Copyright (c) 2018 Facebook
Copyright (C) 2010 Renesas Solutions Corp. Tony SIM <chinyeow.sim.xt@renesas.com>
(C) 1998 Thomas Bogendoerfer
Copyright (C) 1998, 1999, 2002-2003 Hewlett-Packard Co David Mosberger-Tang <davidm@hpl.hp.com>
Copyright (c) 2019 BayLibre SAS. All rights reserved.
Copyright (C) 1999-2001 Ralph Metzler Marcus Metzler Holger Waechter for convergence integrated media GmbH
(C) 2005 Pablo Neira Ayuso <pablo@eurodev.net>
Copyright (c) 2008 Harris Corporation

LICENCE TERMS (cont.)

Copyright (c) 2008 Sascha Hauer <s.hauer@pengutronix.de>, Pengutronix
Copyright (c) 2004 Ray Lehtiniemi
Copyright (C) 2013 TangoTec Ltd.
Copyright (C) 2002, 2018 Red Hat, Inc. All Rights Reserved. Written by David Howells (dhowells@redhat.com)
Copyright (C) 2010 - 2012 Samsung Electronics Co., Ltd. Sylwester Nawrocki <s.nawrocki@samsung.com>
Copyright (C) 1995, 1996 by Andreas Busse
Copyright (C) 2002, 2004, 2007 by Ralf Baechle <ralf@linux-mips.org>
Copyright (C) 1996, 1997, 1998, 2000 Ralf Baechle
Copyright (C) 2013 Ideas on board SPRL
Copyright (c) Teenage Engineering AB 2016
Copyright (c) 2016-2018 Oracle. All rights reserved.
Copyright (C) 2019, Red Hat Inc, Arnaldo Carvalho de Melo <acme@redhat.com>
(c) Copyright 2000 Jakob Oestergaard <jakob@unthought.net>
Copyright (C) 2004, 2005 Ralf Baechle
Copyright (C) 2015 Asahi Kasei Microdevices Corporation
Copyright (C) 2018 SiFive
Copyright 2010, Christian Lamparter <chunkeey@googlegmail.com>
Copyright (C) 2008 Renesas Solutions Corp. Author : Yusuke Goda <goda.yusuke@renesas.com>
Copyright (c) 2004-2006 Richard Purdie
Copyright (C) 2014 Texas Instruments Incorporated - http://www.ti.com/ Author: Balaji T K <balajitk@ti.com>
Copyright (c) International Business Machines Corp., 2009,2011 Author(s): Steve French (sfrench@us.ibm.com)
Copyright (C) 2006 Alex Osborne <ato@meshy.org>
Copyright (C) 2004 Konrad Eisele (eiselekd@web.de,konrad@gaisler.com) Gaisler Research
Copyright (C) ST-Ericsson SA 2007-2010 Author: Per Friden <per.friden@stericsson.com>
Copyright (C) 2005, 2008 Oracle. All rights reserved.
Copyright 2014, Broadcom Corporation
Copyright 2018 Arm Limited Author: Dave Martin <Dave.Martin@arm.com>
Copyright (C) 2013 Lee Jones <lee.jones@lianro.org>
Copyright (C) 2002 - 2010 Paul Mundt
Copyright (C) 2008 Pau Oliva Fora <pof@eslack.org>
(c) Copyright 2000, Grant Grundler
"Copyright (C) 2005, 2006 Nokia Corporation Author: Samuel Ortiz <samuel.ortiz@nokia.com> and Juha Yrjölä <juha.yrjola@nokia.com>"
Copyright (C) 2012 Marvell International Ltd.
Copyright (C) 2003 Convergence GmbH
Copyright: [copy] 2015 Freescale Semiconductor Inc.
Copyright (c) 2010-2011, NVIDIA Corporation.
Copyright (C) 1998, 2003 by Ralf Baechle
Copyright 2010 MontaVista Software, LLC.
Copyright Matthew Wilcox for Intel Corp, 2010
Copyright (c) 2017 Nikolai Kondrashov
Copyright (C) 2012 Samsung Electronics Jonghwa Lee <jonghwa3.lee@samsung.com>
Copyright (C) 2006-2007 Adam Belay <abelay@novell.com>
Copyright (C) 2012 Samsung Electronics.
Copyright (C) 1991, 1992, 1993, 1994 Linus Torvalds Swap reorganised 29.12.95, Stephen Tweedie
Copyright (c) 2016-present, Facebook, Inc. All rights reserved.
Copyright Adrian McMenamin adrian@mcmen.demon.co.uk> 2006
Copyright (C) 2014-2015 Freescale Semiconductor, Inc. All Rights Reserved.
Copyright (C) STMicroelectronics 2019 Author(s): Fabrice Gasnier <fabrice.gasnier@st.com>.
Copyright (c) 2003-2006, 2014-2018, Ericsson AB
Copyright (c) 2011 Stephen Hemminger <shemminger@vyatta.com>
Copyright IBM Corp. 2006 Author(s): Melissa Howland <melissah@us.ibm.com>
Copyright (C) 2005 Hans Verkuil <hverkuil@xs4all.nl>
Copyright (C) 2004, 2009, 2010 2011 Texas Instruments Incorporated Author: Aurelien Jacquot (aurelien.jacquot@jaluna.com)
Copyright IBM Corp. 2019 Author(s): Hendrik Brueckner <brueckner@linux.ibm.com>
Copyright (c) International Business Machines Corp., 2000,2002 Modified by Steve French (sfrench@us.ibm.com)

Copyright (C) 2010 Broadcom
copyright : (C) 2002 by karsten wiese email : annabellesgarden@yahoo.de
Copyright (C) 2016 Martin Sperrl <kernel@martin.sperl.org>
Copyright 2012-2013 Solarflare Communications Inc.
Copyright (c) 2012 Red Hat, Inc. All rights reserved.
Copyright (C) 2002-2006 Yoichi Yuasa <yuasa@linux-mips.org>
Copyright (C) 2003-2004 Marcel Holtmann <marcel@holtmann.org>
Copyright (C) 2014 Evgeni Dobrev <evgeni@studio-punkt.com>
Copyright (c) 1999-2001 Vojtech Pavlik;(c) return;
Copyright (C) 2018 Red Hat, Inc. All rights reserved.
Copyright (C) 2008 Hans de Goede <j.w.r.degoede@hhs.nl>
Copyright (C) 2001 Will Dyson (will@cs.earlham.edu)
Copyright (c) 2015 Steve French <steve.french@primarydata.com>
Copyright 2002 Embedded Edge, LLC Author: dan@embeddededge.com
Copyright (C) 2012-2016 Marvell
(C) 2005 Red Hat Inc Alan Cox <alan@lxguk.ukuu.org.uk>;(C) 2007,2009,2010 Bartłomiej Zolnierkiewicz
Copyright (C) 2011 Freescale Semiconductor, Inc. Author: Zhang Jiejing <jiejing.zhang@freescale.com>
Copyright 2009 Guennadi Liakhovetski <g.liakhovetski@gmx.de>
Copyright (C) 2008 Abhishek Sagar <sagar.abhishek@gmail.com>
Copyright © 2010 Daniel Vetter
Copyright © 2009
Copyright (c) 2012 Katalix Systems Ltd
Copyright (c) 2007 Oracle Corporation. All rights reserved. Written by Martin K. Petersen <martin.petersen@oracle.com>
Copyright (c) 2010 Henrik Rydberg
Copyright Adrian McMenamin 2005, 2006, 2007 adrian@mcmen.demon.co.uk> Requires firmware (BSD licenced) available from: http://linuxdc.cvs.sourceforge.net/linuxdc/linux-sh-dc/sound/oss/aica/firmware/ or the maintainer
Copyright IBM Corp. 2019 Author(s): Hendrik Brueckner <brueckner@linux.ibm.com> Thomas Richer <tmricht@linux.ibm.com>
Copyright (C) 1998 D. Jeff Dionne <jeff@ryeham.ee.ryerson.ca>, Kenneth Albanowski <kjahds@kjahds.com>, The Silver Hammer Group, Ltd.
Copyright 2009-2010, 2012 Freescale Semiconductor, Inc.
Copyright (C) 2010, Intel Corp. Huang Ying <ying.huang@intel.com>
(C) Copyright TOSHIBA CORPORATION 2005-2006;(c) MontaVista Software, Inc.
Copyright (c) 2009 Samsung Electronics Co. Ltd Author: Jaswinder Singh <jassi.brar@samsung.com>
Copyright (c) 2009 Marek Vasut <marek.vasut@gmail.com>
Copyright (c) 2015 - 2016 Red Hat, Inc
(C) 2000-2001 by Harald Welte <laforge@gnumonks.org>;(C) 2004 Rusty Russell <rusty@rustcorp.com.au> IBM Corporation based on a copy of RR's ip_nat_ftp.c
Copyright (C) 2014-2015 Glider bvba
Copyright (C) 2002 - 2005 Benjamin Herrenschmidt <benh@kernel.crashing.org> and Markus Demleitner <msdemlei@cl.uni-heidelberg.de>
(C) 1999-2001 Paul 'Rusty' Russell;(C) 2002-2004 Netfilter Core Team <coreteam@netfilter.org>;(C) 2006-2010 Patrick McHardy <kaber@trash.net>
Copyright (C) 2014 Red Hat Inc, Steven Rostedt <srostedt@redhat.com>
Copyright IBM Corp. 2001, 2009 Author(s): Carsten Otte <cotte@de.ibm.com> Tuan Ngo-Anh <ngoanh@de.ibm.com> Martin Schwidofsky <schwidofsky@de.ibm.com>;(C) 2001-2002 IBM
Copyright 2016 Luo Yi <luoyi.ly@gmail.com>
Copyright (C) 2003 David Brownell
Copyright (C) 2012 Russell King Written from the i915 driver.
(C) Copyright 1999, 2000 Linus Torvalds
Copyright (c) 2016, Cascoda, Ltd. All rights reserved.
Copyright 2002/2003 by Andreas Eversberg (jolly@eversberg.eu) Rewritten by Peter
Copyright (C) 1996 Paul Mackerras.
Copyright (C) 2011 NVIDIA Corporation
Copyright 2007 DENX Software Engineering, Stefan Roese <sr@denx.de>
Copyright (C) 1999-2005 James Simmons <jsimmons@www.infradead.org>

LICENCE TERMS (cont.)

Copyright 2008-2010 DENX Software Engineering, Stefan Roese <sr@denx.de>
Copyright 2003-11 Wolfson Microelectronics PLC. Author: Liam Girdwood <lr@slimlogic.co.uk>
Copyright (C) 2000-2001 Hewlett-Packard Co Stephane Eranian <eranian@hpl.hp.com> David Mosberger-Tang <davidm@hpl.hp.com>
Copyright (C) (2012) Texas Instruments Incorporated - http://www.ti.com/
Copyright (c) 2015, Hannes Reinecke
(C) 1999 by Joshua M. Thompson (funaho@jurai.org) Based on via-cuda.c by Paul Mackerras.
Copyright (C) 2008 Christian Hohnstaedt <chohnstaedt@innominate.com>
Copyright (c) 2017 Microchip Technology Inc. Tristram Ha <Tristram.Ha@microchip.com>
Copyright (C) 1996, 1997, 1998, 1999 by Ralf Baechle
Copyright (c) 1994-1998, 2000, 2001 Justin T. Gibbs. All rights reserved.
Copyright (C) 2015-2016 Renesas Electronics Corporation
Copyright (c) 2010 Paul Thomas <pthomas8589@gmail.com>
Copyright (C) 2002 Anton Blanchard, IBM Corp.
Copyright (C) 2008 Krzysztof Halasa <khc@pm.waw.pl>
Copyright 1993-2003 NVIDIA, Corporation
Copyright(c) 2017-2018 Jesper Dangaard Brouer, Red Hat Inc.
Copyright (C) 2013 HUAWEI Author: Cai Zhiyong <caizhiyong@huawei.com>
Copyright (c) 2007 Bruno Randolf <bruno@thinktube.com>
Copyright (c) 2015 Axis Communications AB
Copyright (c) 2016 Jiri Pirko <jiri@mellanox.com>
Copyright (C) 2013 STMicroelectronics (R&D) Limited Author: Stephen Gallimore <stephen.gallimore@st.com>
Copyright 2006 IBM
Copyright (C) 2002 Anton Blanchard <anton@au.ibm.com>, IBM
Copyright (C) IBM Corporation, 2009
Copyright (c) 2013-2014 Samsung Electronics Co., Ltd. Mateusz Krawczuk <m.krawczuk@partner.samsung.com>
Tomasz Figa <t.figa@samsung.com>
Copyright (c) 2016 Andy Yan <andy.yan@rock-chips.com>
Copyright (c) 2011, 2012, Qualcomm Atheros Communications Inc.
Copyright (c) 2013 Federico Simoncelli All rights reserved.
Copyright © 2012-2014 HiSilicon Technologies Co., Ltd. http://www.hisilicon.com
Copyright (C) 2007, Riku Voipio <riku.voipio@iki.fi>
Copyright (c) 2016, Citrix Systems Inc
Copyright (c) 2005 The University of Waikato, Hamilton, New Zealand.
Copyright 2003, 2008 Pavel Machek <pavel@suse.cz>
Copyright (c) 2017-2018 Christoph Hellwig.
Copyright (c) 2009 Aava Mobile
Copyright (c) 2010 Christoph Mair <christoph.mair@gmail.com>
Copyright (c) 2017-2018 Socionext Inc.
Copyright (c) 2005-2007 Mauro Carvalho Chehab <mchehab@kernel.org>
Copyright 2016 Freescale Semiconductor, Inc
Copyright (c) 2001,2002 Christer Weinigel <wingel@nano-system.com>;(c) Copyright 2002 Zwane Mwaikambo <zwane@commfireservices.com>
Copyright 2004-2015 Freescale Semiconductor, Inc. All Rights Reserved.
copyright holders: 1992-2000 by Donald Becker, NE2000 core and various modifications. 1995-1998 by Paul Gortmaker, core modifications and PCI support.
Copyright (C) 2009 John Crispin <john@phrozen.org>
(C) using ARM CRC, NEON and Crypto Extensions instructions
Copyright (c) 1997, 1998, 2000 Justin T. Gibbs. All rights reserved.
Copyright (C) 2001 FarSite Communications Ltd. www.farsite.co.uk
Copyright (C) 2013 Roman Rolinsky
Copyright (c) 2008-2009 PMC-Sierra, Inc., All rights reserved.
Copyright 2019 dvanced Micro Devices, Inc.
copyrights (c) 1994,1995,1996 by M.Hipp
Copyright (C) Nokia Corporation Author: Matti Aaltonen <matti.j.aaltonen@nokia.com>
Copyright (C) 2014, Topic Embedded Products Licenced under GPL
Copyright 2011-2013 Autronica Fire and Security AS

Copyright 2004, Matt Porter <mporter@kernel.crashing.org>;(C) Copyright Embedded Alley Solutions, Inc 2005
Author: Pantelis Antoniou <pantelis@embeddedalley.com>
Copyright (C) 2002 Intersil Americas Inc.:(C) 2003 Aurelien Alleaume <slts@free.fr>;(C) 2003 Luis R. Rodriguez <mcgrof@ruslug.rutgers.edu>
Copyright (c) 2008 Michael Krufky <mkrufky@linuxtv.org>
Copyright (C) 2015 ASMedia Technology Inc. Author: YD Tseng <yd_tseng@asmedia.com.tw>
Copyright (C) 2002-2005 Pavel Roskin <proski@gnu.org>
Copyright (C) 2012 Texas Instruments Author: Peter Ujfalusi <peter.ujfalusi@ti.com>
Copyright (c) 2008-2009 Philipp Zabel
(C) 1993, Hamish Macdonald, see mvme147.c for more info
Copyright (c) 2001-2007, 2012-2017, Ericsson AB
Copyright 2008, 2009 Intel Corporation.
Copyright (C) 2012, 2014 Intel Corporation. All rights reserved.
Copyright (C) 2015 Seagate Technology PLC
(c) 2003-04 Gerd Knorr <kxarel@bytex.org> (c) 2005-2006 Mauro Carvalho Chehab <mchehab@kernel.org>
Copyright (c) 2006-2014 Brocade Communications Systems, Inc.
Copyright (c) 2019 Akash Gajjar <Akash_Gajjar@mentor.com>
Copyright (C) 2006 Atsushi Nemoto <anemo@mba.ocn.ne.jp>
Copyright (C) 1992, 1993, 1994, 1995 Remy Card (card@masi.ibp.fr) Laboratoire MASI
Copyright (C) 2013 STMicroelectronics
Copyright 2006 Tungsten Graphics, Inc., Bismarck, ND., USA. All Rights Reserved.
(C) Copyright 2016, Angelo Dureghello <angelo@sysam.it>
Copyright (c) 2018 Cumulus Networks. All rights reserved.
Copyright 2017 IBM Corp. include
Copyright (C) 2012 Johannes Goetzfried Johannes.Goetzfried@informatik.stud.uni-erlangen.de>
Copyright (c) 2011 DENX Software Engineering GmbH
Copyright (c) 2016 MediaTek Inc. Author: Ir Lian <ir.lian@mediatek.com> Garlic Tseng <garlic.tseng@mediatek.com>
Copyright (C) 2019 Vlad Buslov <vladbu@mellanox.com>
Copyright (c) 2014 Dmitry Eremin-Solenikov
Copyright (c) 2012 Bernhard Seibold
Copyright 2017 VMware, Inc., Palo Alto, CA., USA All Rights Reserved.
Copyright IBM Corp. 2001, 2018 Author(s): Robert Burroughs Eric Rossman (edrossma@us.ibm.com) Cornelia Huck <cornelia.huck@de.ibm.com>
Copyright (C) 2013-2016 STMicroelectronics (R&D) Limited
Copyright (C) 2004 Psion Teklogix
Copyright (C) 2008 Texas Instruments, Inc.
Copyright 2009 Jon Smirl, Digispeaker Author: Jon Smirl <jonsmirl@gmail.com>
Copyright (C) 2011-2012 Avionic Design GmbH
Copyright (c) 2013, Intel Corporation Author: Lv Zheng <lv.zheng@intel.com>
Copyright (C) 2004 George T. Joseph Derived from Coyote
Copyright (c) 2005 Stanislaw Skowronek <skylark@linux-mips.org>
Copyright (C) 2007-2009, 2011 Texas Instruments, Inc.
Copyright (c) 2000, 2001 Anders Torger <torger@ludd.luth.se>
Copyright(c) 2015-2017 Broadcom. All rights reserved.
Copyright 2006 Michael Buesch <m@bues.ch>
Copyright (C) 2011 by Mauro Carvalho Chehab
Copyright (c) 2011 Samsung Electronics Co., Ltd. http://www.samsung.com/
Copyright (C) 2008 Aleksandar Radovanovic <biblbroks@sezampro.rs>
Copyright 2013 VMware, Inc., Palo Alto, CA., USA
Copyright 2016 Broadcom Limited
Copyright (c) 2013, Kenneth MacKay All rights reserved.
Copyright (C) 2016 Freescale Semiconductor, Inc. All Rights Reserved.
Copyright (c) 1998 David Huggins-Daines.
Copyright (C) 2000 Hewlett-Packard Co, Linuxcare Inc.
Copyright 2017-2019 NXP
(c) Copyright 2006 Calin A. Cuiianu <calin@ajvar.org>, All Rights Reserved.

LICENCE TERMS (cont.)

(C) 2007 by Hans J. Koch <hjk@hansjkoch.de>
Copyright (C) 2004 Sun Microsystems Inc.
Copyright (C) 2010 ST Microelectronics Rajeev Kumar <rajeev-dlh.kumar@st.com>
Copyright (C) 2005 Anders Blomdell <anders.blomdell@control.lth.se>
Copyright (C) 2012 Jamie Lentini
Copyright (C) 1996,1997,1998 Russell King.
Copyright (c) 2013-2016 Brocade Communications Systems, Inc.
Copyright(c) 2016, Analogix Semiconductor.
Copyright 2005-2008 Freescale Semiconductor, Inc. All Rights Reserved.
Copyright (c) 2017-2018 MediaTek Inc.
Copyright (C) 2006 Arnd Bergmann <arnd@arndb.de>, IBM Corp.
(c) 2007 Sebastian Siewior <bigeasy@linutronix.de>;(c) 2011 Arvid Brodin <arvid.brodin@enea.com>
Copyright (C) 2013 BayHub Technology Ltd.
Copyright (C) 2012-2013 MundoReader S.L.
Copyright (c) 2009 Rafael J. Wysocki <rjw@sisk.pl>, Novell Inc.
Copyright © 2014 Rafał Milecki <zajec5@gmail.com>
Copyright (c) 2015, The Linux Foundation. All rights reserved.
Copyright (C) 2014 Anna Schumaker.
Copyright (C) 1998-2000 Thomas Sailer (sailer@ife.ee.ethz.ch);(C) 1998-2000 Thomas Sailer
Copyright 2018, Breno Leitao, IBM Corp. Licensed under GPLv2.
Copyright (C) 2012 MIPS Technologies, Inc. All rights reserved. Authors: Yann Le Du <ledu@kymasys.com>
Copyright 1997 by Michael Schmitz
Copyright 2012-2016 by the PaX Team <pageexec@freemail.hu>
Copyright (c) 2005 Intracom S.A. by Pantelis Antoniou <panto@intracom.gr>;(c) MontaVista Software, Inc. Vitaly Bordug <vbordug@ru.mvista.com>
(C) 1996 Peter Braam
Copyright (C) 2018 Hangzhou C-SKY Microsystems co.,ltd.
Copyright (c) 2008 Loc Ho <lho@amcc.com>
Copyright 2011-2012 Analog Devices Inc.
Copyright (C) 2009 Nathan Fontenot
Copyright (C) 2015 Chen-Yu Tsai <wens@csie.org>
Copyright 2015-2016 Axis Communications AB.
Copyright (C) 2017 ZTE Ltd
Copyright (C) 2017 Marek Vasut <marek.vasut@gmail.com>
Copyright (c) 2001 by Jaroslav Kysela <perex@suse.cz>
Copyright (C) 2005 Thomas Hellstrom, All Rights Reserved.
Copyright (C) 2005-2008 Jean Delvare <jdelvare@suse.de>
Copyright (c) 2015 MediaTek Inc. Author: Hongzhou.Yang <hongzhou.yang@mediatek.com>
Copyright (C) 2007 MontaVista Software, Inc.
Copyright (C) 2015 HiSilicon Co., Ltd. http://www.hisilicon.com
Copyright 2001-2002 Pavel Machek <pavel@suse.cz> Based on code
Copyright (c)1999-2016 : LinuxTV Developers
Copyright (C) 2019 Macronix International Co., Ltd.
Copyright: (c) 2011 Czech Technical University in Prague;(c) 2011 Volkswagen Group Research Authors: Michal Sojka <sojkam1@fel.cvut.cz> Pavel Pisa <pisa@cmp.felk.cvut.cz> Rostislav Lisovy <lisovy@gmail.cz> Funded by: Volkswagen Group Research
Copyright 2017 (c) Samsung Electronics Software, Inc.
Copyright 2010 Integrated Device Technology, Inc. Alexandre Bounine <alexandre.bounine@idt.com>
Copyright (c) 1998-2002 by Paul Davis <pbd@op.net>
"Copyright (c) 2014, Applied Micro Circuits Corporation Author: Tin Huynh <tnhuynh@apm.com>. Y Vo <yvo@apm.com>. Quan Nguyen <qnguyen@apm.com>."
Copyright (C) 2005-2007 PMC-Sierra, Inc. All rights reserved. Author: Andrew Hughes, Andrew_Hughes@pmc-sierra.com
Copyright (c) 2016-2017 VMware, Inc. All rights reserved.
Copyright (C) 2010 Thomas Langer <thomas.langer@lantiq.com>
(C) Copyright 2004 John Lenz
Copyright 2006-2008 Tungsten Graphics, Inc., Cedar Park, TX. USA.

Copyright (c) 2005 Oracle Corporation, Joel Becker <joel.becker@oracle.com>
Copyright (C) 2001, 2002 Sistina Software (UK) Limited.
Copyright (c) 2016 Andrew Lunn <andrew@lunn.ch>
Copyright (C) 2017-2018 Texas Instruments Inc.
Copyright © 2006-2009 Intel Corporation
Copyright (c) 2006-2009 Simtec Electronics http://armlinux.simtec.co.uk/ Ben Dooks <ben@simtec.co.uk> Vincent Sanders <vince@simtec.co.uk>
(C) Copyright Linus Torvalds 1999;(C) Copyright Johannes Erdfeldt 1999-2001;(C) Copyright Andreas Gal 1999;(C) Copyright Gregory P. Smith 1999;(C) Copyright Deti Fliegl 1999 (new USB architecture);(C) Copyright Randy Dunlap 2000;(C) Copyright David Brownell 2000-2004;(C) Copyright Yggdrasil Computing, Inc. 2000 usb_device_id matching changes by Adam J. Richter);(C) Copyright Greg Kroah-Hartman 2002-2003
Copyright (c) 2014 Imagination Technologies Authors: Will Thomas, James Hartley
Copyright (c) 2017-2018, The Linux Foundation. All rights reserved. */
Copyright (C) 2013 ISEE 2007 SL - http://www.isee.biz/
© 2004 Simtec Electronics
Copyright (C) 2007 Marvell International Ltd. 2007-08-21: eric miao <eric.miao@marvell.com> initial version
Copyright (c) 1995-2006, 2013-2014, Ericsson AB
Copyright 1999 ARM Limited
Copyright (C) 2008 Andres Salomon <dilinger@debian.org>
Copyright (c) 2008 Nissin Systems Co., Ltd., Yoshio Kashiwagi
Copyright (C) 2007-2009 Jiri Slaby <jirislaby@gmail.com>
Copyright (C) 2004-2005 Nokia Corporation Authors: Juha Yrjölä <juha.yrjola@nokia.com> Imre Deak <imre.deak@nokia.com> YUV support: Jussi Laako <jussi.laako@nokia.com>
Copyright (C) 2014 ROCKCHIP, Inc.
(C) chipset IDE D
Copyright (C) 2008, cozybit Inc.
Copyright (C) 2004 SAN People (Pty) Ltd.
Copyright (C) 2016 HiSilicon Co., Ltd.
Copyright (c) 2017 Samsung Electronics Co., Ltd. http://www.samsung.com
Copyright (C) 2017 Arm Ltd.
Copyright (C) 2009-2010, Lars-Peter Clausen <lars@metafoo.de> JZ4740 SoC NAND controller driver
Copyright (C) 2015, Linaro Ltd Author: Graeme Gregory <graeme.gregory@linaro.org>
Copyright (c) 2018 Covalent IO, Inc. http://covalent.io
(C) 2000 by Harald Welte <laforge@gnumonks.org>
Copyright (c) 2006 Thomas Gleixner <tglx@linutronix.de>
Copyright (C) 2015 Lucas Stach <kernel@pengutronix.de>
Copyright (C) 2019 Axis Communications AB
Copyright (C) 2006 Georg Acher, BayCom GmbH, acher (at) baycom (dot) de for Reel Multimedia
Copyright (C) 2010 David S. Miller <davem@davemloft.net>
Copyright 2017 Realtek Semiconductor Corp.
Copyright (C) 2013-2014 Texas Instruments., Ltd. http://www.ti.com
Copyright (c) 2002-2010, Intel Corporation.
Copyright (C) 1999,2001 Richard Zidlicky
Copyright (C) 2014-2018 Renesas Electronics Europe Limited
Copyright (C) 2013 - 2015 Linaro Ltd.
Copyright (C) 2001-2004 Stelian Pop <stelian@popies.net>
Copyright 1993 United States Government as represented by the Director, National Security Agency.
Copyright (c) 2014 Takashi Iwai <tiwai@suse.de>
Copyright (C) 2010 Michael Hennerich, Analog Devices Inc.
Copyright (c) 2005 Alexey Starikovskiy <alexey.y.starikovskiy@intel.com>
Copyright (C) 1998-1999 Takashi Iwai <tiwai@suse.de>
Copyright 2008 Analog Devices Inc.
Copyright (C) 2006-2009 Red Hat, Inc., Ingo Molnar <mingo@redhat.com>
(c) Copyright 1996 Alan Cox <alan@lxorguk.ukuu.org.uk>, All Rights Reserved.:(c) Copyright 1995 Alan Cox <alan@lxorguk.ukuu.org.uk>
Copyright (C) 2015 Broadcom
Copyright IBM Corp. 1999, 2000 Author(s): Denis Joseph Barrow (djbarrow@de.ibm.com,barrow_dj@yahoo.com)

LICENCE TERMS (cont.)

Copyright (C) 1994 by Linus Torvalds Changes for PPC by Gary Thomas Rewritten by Cort Dougan and Paul Mackerras
Copyright (C) 2011-2013 One Laptop Per Child
Copyright (C) 2008, Red Hat Inc, Ingo Molnar <mingo@redhat.com> 2011, Red Hat Inc, Arnaldo Carvalho de Melo <acme@redhat.com>
(C) 2007 SGI, Christoph Lameter
Copyright (c) 1999 Martin Mares <mj@ucw.cz> and others
Copyright (C) 1999-2002, Greg Ungerer (gerg@snapgear.com)
Copyright (C) 2010-2016 Oracle Corporation
copyright Jamal Hadi Salim (2016)
Copyright (c) 2000 Peter Denison <peterd@pnd-pc.demon.co.uk>
Copyright 1999 Derrick J Brashear (shadow@dementia.org)
Copyright 2002 Karsten Merker <merker@debian.org>
Copyright (c) 2007 MontaVista Software, Inc. Anton Vorontsov <avorontsov@ru.mvista.com>
Copyright IBM Corp. 2012, 2018 Author(s): Hendrik Brueckner <brueckner@linux.vnet.ibm.com> Jan Glauber <jang@linux.vnet.ibm.com>
Copyright (c) 2010-2017 Nikolai Kondrashov
Copyright (c) Harald Koerfgen, 1998
Copyright (C) 2012 Red Hat, Inc.:(C) 2011 The Chromium OS Authors
Copyright 2009 Simon Arlott
Copyright (c) 2014-2017 Samsung Electronics Co., Ltd
(C) 2005-2006 Red Hat Inc
Copyright (C) 2012 Texas Instruments Incorporated - <http://www.ti.com>
Copyright (C) 2017 Antony Antony <antony@phenome.org>
Copyright © 2006-2008 Intel Corporation Jesse Barnes <jesse.barnes@intel.com>
Copyright 2009 Texas Instruments.
Copyright (C) 2011 Samsung Electronics Co.Ltd MyungJoo Ham <myungjoo.ham@samsung.com>
Copyright (C) 2011 Samsung Electronics Co., Ltd. Kamil Debski, <k.debski@samsung.com>
Copyright (C) 2017 Hisilicon Ltd.
Copyright (c) 2015 Jamal Hadi Salim <jhs@mojatatu.com>
Copyright (C) 2010 Samsung Electronics Author: Michal Nazarewicz <mina86@mina86.com>
Copyright (c) 2015 Chen-Yu Tsai
Copyright (c) 2010, 2011 Intel Corporation
Copyright (C) 2000, 2004, 2005 MIPS Technologies, Inc. All rights reserved. Authors: Carsten Langgaard <carsten@mips.com> Maciej W. Rozycki <macro@mips.com>
Copyright (c) 2012, NVIDIA CORPORATION. All rights reserved. Author: Venu Byravarasu <vbyravarasu@nvidia.com>
Copyright IBM Corp. 2005, 2011
Copyright (C) 2000, 2003 Ralf Baechle
(c) 2005 MontaVista Software, Inc.
Copyright (C) STMicroelectronics SA 2017 Author: Alexandre Torgue <alexandre.torgue@st.com> for STMicroelectronics.
Copyright 2004-2013, 2015 Freescale Semiconductor, Inc. All Rights Reserved.
Copyright (c) 2015 Quantenna Communications */
Copyright (C) 2015-2016 Paul Kocialkowski <contact@paulk.fr>
Copyright (c) 1995-1996 Gary Thomas <gdt@linuxppc.org> Initial PowerPC version.
Copyright (C) 2005-2006 Jean Delvare <jdelvare@suse.de>
Copyright (c) 1995,2001 Compaq Computer Corporation
Copyright (c) 2016-2017 Andreas Färber
Copyright (c) 2014, Applied Micro Circuits Corporation Author: Feng Kan <fkan@apm.com>.
Copyright (c) 2015, Hans Ulli Kroll <ulli.kroll@googlemail.com>
Copyright IBM Corp. 2001, 2007 Authors: Malcolm Beattie <beattiem@uk.ibm.com> Michael Holzheu <holzheu@de.ibm.com> Frank Munzert <munzert@de.ibm.com>
Copyright (c) 2006 Mellanox Technologies. All rights reserved
Copyright (C) 2010 Digital Design Corporation
Copyright 2015 Verifone Int.
Copyright (C) 2019 Synaptics Incorporated

Copyright (C) STMicroelectronics SA 2017 - All Rights Reserved Author: Gerald Baeza <gerald.baeza@st.com> for STMicroelectronics.
Copyright (C) ST-Ericsson SA 2011-2013
Copyright (C) 2010 Texas Instruments.
(c) 2000-2003 Gerd Knorr <kxaxel@bytestex.org>
Copyright (C) 2013 Samsung Electronics Co., Ltd. Authors: Girish K S <ks.giri@samsung.com> Yuvaraj Kumar C D <yuvaraj.cd@samsung.com>
Copyright (c) 2019 Max Staudt <max@enpas.org>
(C) 2005 EADS Astrium
Copyright (C) 2016 Nicolai Stange <nicstange@gmail.com>
Copyright 2014-2015 Freescale Semiconductor Inc.
Copyright (C) 2013 Carsten Emde <C.Emde@osadl.org>
(C) 2002 Harald Welte <laforge@gnumonks.org>
Copyright (c) 2003-2016 Cavium Inc.
Copyright (C) 1989, 1991 Free Software Foundation, Inc.
Copyright (C) 2009 The GameCube Linux Team
Copyright (C) 2017 - Cambridge Greys Ltd
Copyright (C) 2016 Icenowy Zheng <icenowy@aosc.xyz>
Copyright (C) 2015, 2017 Raspberry Pi
Copyright Compulab Ltd, 2002-2007 Mike Rapoport <mike@compulab.co.il>
Copyright (C) 2011 Ilya Yanok, EmCraft Systems
Copyright (C) 2016-2017 Red Hat, Inc. All rights reserved.
Copyright (c) 2009 by Martin Fuzzey
Copyright (c) 2000 Ani Joshi <ajoshi@kernel.crashing.org>
Copyright (C) IBM Corporation, 2005, 2006
Copyright (C) 1989 Free Software Foundation, Inc.
Copyright (C) 2013 Florian Fainelli <florian@openwrt.org>
(C) 2005-2007 Linux Networx (<http://lnxi.com>);(c) 2012-2013 - Mauro Carvalho Chehab The entire API were re-written, and ported to use struct device
Copyright (C) 2012-2019 ARM Limited (or its affiliates).
Copyright (C) 2004-2009 Mattia Dongili <malattia@gmail.com>.:@ non sembra essere presente\n"
Copyright (c) 2017 Renesas Solutions Corp. Kuninori Morimoto <kuninori.morimoto.gx@renesas.com>
Copyright 2013 Michael Ellerman, IBM Corp.
Copyright (C) 2007-2008 Nokia Corporation. All rights reserved.
Copyright 2011 Google Inc. All Rights Reserved
Copyright (C) 2016 Canonical Ltd. <seth.forshee@canonical.com>
Copyright (C) 2014 Sukadev Bhattiprolu, IBM Corporation.
(c) 2003, 2004 Andrew de Quincey & Robert Schlabach
Copyright (C) 2016-2017 Broadcom
Copyright (C) 2002,2003 Florian Schirmer <jolt@tuxbox.org>
Copyright (C) 2012 Ralf Baechle <ralf@linux-mips.org>
Copyright (C) 2014-2016 Freescale Semiconductor, Inc.
Copyright (C) 2006 Paolo Abeni (paolo.abeni@email.it)
Copyright 2016 Freescale Semiconductor Inc.
Copyright (C) 2002 Stefan Eletzhofer <stefan.eletzhofer@eletztrick.de>
Copyright (C) 2013 Boris BREZILLON <b.brezillon.dev@gmail.com>
Copyright (C) 2017 Intel Corporation */ Functions to access TPS68470 power management chip. */
Copyright (C) 2010 Jean Delvare <jdelvare@suse.de>
"Copyright (C) 1995 Linus Torvalds"
Copyright, (C) 2015 Heiko Schocher <hs@denx.de>
Copyright (c) 2006 Mauro Carvalho Chehab <mchehab@kernel.org>
Copyright (c) 2009, Jouni Malinen <j@w1.fi>
Copyright (C) 2013 ST-Ericsson AB
Copyright (c) 2009-2016 Chelsio Communications, Inc. All rights reserved.
Copyright 2014 Prodrive Technologies B.V.
Copyright (C) 2012, Linaro, Sangwook Lee <sangwook.lee@linaro.org>
Copyright (C) 2010 Linus Torvalds

LICENCE TERMS (cont.)

Copyright 2008-2013 Freescale Semiconductor Inc.
Copyright (C) 2010-2012 Stephane Grosjean <s.grosjean@peak-system.com>
Copyright (c) 2003, 2005 Maciej W. Rozycki
Copyright (C) 1998, 1999 Hewlett-Packard Co
Copyright (C) 2012 MIPS Technologies, Inc. Authors: Sanjay Lal <sanjayl@kymasys.com>
Copyright (c) 2010 Richard Nauber <Richard.Nauber@gmail.com>
Copyright (c) 2017-2018, The Linux Foundation. All rights reserved.
Copyright (C) 2002 Vivien Chappelier
Copyright (C) 1991-1998 Linus Torvalds
Copyright (C) 1999 Hewlett-Packard (Frank Rowand)
Copyright (c) 2005 John Lenz Based on from xtkbd.c
Copyright 2018 Einfochips
Copyright (C) 2009 Renesas Solutions Corp.
Copyright (C) 2000-2003 Krzysztof Halasa <khc@pm.waw.pl>
Copyright (c) 2016 Eric Biederman <ebiederm@xmission.com>
Copyright 2013 Golden Delicious Computers Lukas Mårdian <lukas@goldelico.com>
Copyright (c) 1997 Alan Cox
Copyright (C) 2006-2007, Advanced Micro Devices, Inc.
Copyright 2004,2007,2012 Freescale Semiconductor, Inc
(C) Copyright 2007-2008 TOSHIBA CORPORATION
Copyright (c) 2011 Jamie Iles
Copyright (C) 2019 Microchip Technology Inc.
Copyright (C) 2010-2015 Cavium Networks
Copyright (C) 2007-2009 ST-Ericsson AB Timer COH 901 328, runs the OS timer interrupt. Author: Linus Walleij <linus.walleij@stericsson.com>
Copyright (C) 1999 Intel Corp.
Copyright (c) 2017 Pablo Neira Ayuso <pablo@netfilter.org>
Copyright (c) 2010, Octasic semiconductor.
Copyright (C) 2008 Ira W. Snyder <iws@ovro.caltech.edu>
Copyright © 2018 Intel Corp
Copyright(c) 2003 - 2005 Intel Corporation. All rights reserved.
Copyright (C) 2003 David Glance <davidgsf@sourceforge.net> 2001-2004 Juergen Stuber <starblue@users.sourceforge.net>
Copyright (C) 2006, Ondrej Zajicek <santiago@crfreenet.org>
Copyright (C) 1994, 1996, 1998, 2001 Free Software Foundation, Inc.
Copyright (C) 2010 IBM Corporation Author: David Safford <safford@us.ibm.com>
Copyright (C) 2010 Texas Instruments Incorporated Author: Mark Salter (msalter@redhat.com)
Copyright (C) 2017 NutsBoard.Org
Copyright (c) 2013,2016 Lubomir Rintel All rights reserved.
Copyright (c) 2008-2009 PIKA Technologies Sean MacLennan <smacLennan@pikatech.com>
Copyright (C) 2001-2003 Saito.K & Jeanne
Copyright (c) 2011-2014 Andy Lutomirski
Copyright (c) 2014,2015 Ken Xue <Ken.Xue@amd.com> Jeff Wu <Jeff.Wu@amd.com>
Copyright (C) 2013 Douglas Gilbert <dgilbert@interlog.com>, Robert Nelson <robertnelson@gmail.com>
Copyright (C) 2002, David McCullough <davidm@snapgear.com> modified for 2.6 by Hyok S. Choi <hyok.choi@samsung.com>
Copyright (c) 2018, Linaro Ltd. */
Copyright (C) 2018 Mellanox Technologies
Copyright (C) Peter T. Breuer (ptb@ot.uc3m.es) 2003
Copyright IBM Corp. 2001, 2009 Author(s): Carsten Otte <cotte@de.ibm.com> Tuan Ngo-Anh <ngoanh@de.ibm.com> Martin Schwidefsky <schwidefsky@de.ibm.com> Stefan Bader <shbader@de.ibm.com>
Copyright (c) 2006 Rafael J. Wysocki <rjw@sisk.pl>
Copyright (C) 2011 taskit GmbH Author: Christian Glindkamp <christian.glindkamp@taskit.de>
Copyright 2012 Intel Corporation
Copyright (c) 2013, 2014 Kenneth MacKay. All rights reserved.
Copyright (C) 2014-2015 Synopsys, Inc. (www.synopsys.com)
Copyright (c) 2003 Embedded Edge, LLC. Author: Embedded Edge, LLC. dan@embeddededge.com or tim@

embeddededge.com
Copyright (c) 2015, Linaro Ltd. Author: Fu Wei <fu.wei@linaro.org> Suravee Suthikulpanit <Suravee.Suthikulpanit@amd.com> Al Stone <al.stone@linaro.org> Timur Tabi <timur@codeaurora.org>
Copyright (C) 2018 Hangzhou C-SKY Microsystems co.,Ltd. */
Copyright (c) 2012 Smith Micro Software, Inc.
Copyright (C) 2006 Hartmut Rick <linux@rick.clarinet.de>
Copyright: (c) 2000-2001 Cyclades Corp.
Copyright 2009 MontaVista Software, Inc.
Copyright (C) 2010 Ed Spiridonov <edo.rus@gmail.com>
Copyright (C) 2010 - 2011 Samsung Electronics Co., Ltd. Contact: Sylwester Nawrocki, <s.nawrocki@samsung.com>
Copyright (C) 2001-2003 MontaVista Software Inc. Author: Yoichi Yuasa <source@mvista.com>
Copyright (C) 2017 Samsung Electronics Co.Ltd Authors: Marek Szyrowski <m.szyrowski@samsung.com>
Copyright (C) 2016, Linaro Ltd.
Copyright 2007,2008 Simtec Electronics
Copyright (c) 2015, Applied Micro Circuits Corporation Author: Feng Kan fkan@apm.com
Copyright (c) 2004 Peter Gruber <nokos@gmx.net>
Copyright 2009,2010 Wolfson Microelectronics PLC.
Copyright (C) 2002,2005 by SOMA Networks, Inc.
Copyright (c) 2007 Dmitry Torokhov
Copyright(c) 2017 Intel Corporation. All rights reserved.
Copyright: Vovan888 at gmail com
(c) 2013 Hans de Goede <hdegoede@redhat.com>;(c) 2000-2002 Matthew Dharm (mdharm-usb@one-eyed-alien.net);(c) 2000 Adam J. Richter (adam@yggdrasil.com), Yggdrasil Computing, Inc.
Copyright (C) 2006-2007 Ivan N. Zlatev <contact@i-nz.net>
Copyright (c) 2002 Rob Miller (rob@inpharmatica . co . uk)
Copyright (c) 2008 James Bottomley <James.Bottomley@HansenPartnership.com>
Copyright 2011-2012 Freescale Semiconductor Inc.
Copyright (C) 2017 Martin Blumenstingl <martin.blumenstingl@googlemail.com>
Copyright 2007,2011 Freescale Semiconductor, Inc
(C) 2009-2010 Nishanth Menon <nm@ti.com>, Texas Instruments Incorporated
Copyright (C) 2012 Andrew Lunn <andrew@lunn.ch>
Copyright (C) 2010 Texas Instruments, Inc. Author: Santosh Shilimkar <santosh.shilimkar@ti.com>
Copyright (c) 2012 Samsung Electronics.
Copyright © 2010 Luca Barbieri
Copyright (C) 2013-2017 Linaro Ltd Authors: Roy Franz <roy.franz@linaro.org> Ard Biesheuvel <ard.biesheuvel@linaro.org>
Copyright (C) 2019 ARM Limited.
(C) 2002 - 2003 Dominik Brodowski <linux@brodo.de>;(C) 2002 Zwane Mwaikambo <zwane@commfireservices.com>;(C) 2002 Arjan van de Ven <arjanv@redhat.com>;(C) 2002 Tora T. Engstad All Rights Reserved
Copyright 2013 Advanced Micro Devices, Inc.
Copyright (C) 2002 by Theodore Ts'o
Copyright (C) 2005-2007 Ulrich Kunitz <kune@deine-taler.de>
Copyright (C) 2009 ST-Ericsson AB Handle board-bound regulators and board power not related to any devices. Author: Linus Walleij <linus.walleij@stericsson.com>
(C) 1999-2001 Paul 'Rusty' Russell;(C) 2002-2006 Netfilter Core Team <coreteam@netfilter.org>;(C) 2003,2004 USAGI/WIDE Project <http://www.linux-ipv6.org>;(C) 2005-2012 Patrick McHardy <kaber@trash.net>
Copyright (C) 1999 Linus Torvalds
Copyright (C) 2017-2019 Jean Delvare
Copyright Benjamin Herrenschmidt & Gavin Shan, IBM Corporation 2013.
Copyright (c) 2003-2004, K A Fraser.
Copyright 2007 Russell King
Copyright (C) 2014 Intel Corporation; author Matt Fleming
Copyright(c) 2017 Broadcom Corporation. All rights reserved.
Copyright (C) 2014-2015 Imagination Technologies Ltd.
Copyright (C) 2002, 2003, 2005, 2008 Maciej W. Rozycki
Copyright (C) 2015 Imagination Technologies

LICENCE TERMS (cont.)

Copyright (C) 1998 Peter Maydell (pmaydell@chiark.greenend.org.uk)
Copyright (C) 2008 Thomas Chou <thomas@wytron.com.tw>
Copyright (C) 2005 Sensoria Corp. Derived from the unified SMC91x driver by Nicolas Pitre
Copyright (c) 2005, Advanced Micro Devices, Inc.
Copyright (C) 2018 Free Software Foundation, Inc.
Copyright 2007 IBM Corporation. Josh Boyer <jwboyer@linux.vnet.ibm.com>
Copyright (c) 2009 Pavel Hofman <pavel.hofman@ivitera.com>
Copyright (C) 2017 Google
Copyright (C) 1999 - 2003 Greg Kroah-Hartman (greg@kroah.com)
"Copyright 2007-11 Wolfson Microelectronics, plc;(c) regmap_write(c, WM8960_RESET, 0)"
Copyright (C) 2002, 2003 David S. Miller (davem@redhat.com)
Copyright 2018 IBM Corporation */
Copyright (c) 2008-2013 Jonathan Cameron
Copyright: [copy] 2016, NVIDIA CORPORATION. All rights reserved. Author: Neo Jia <cjia@nvidia.com> Author: Kirti Wankhede <kwankhede@nvidia.com>
Copyright (c) 2018 Julian Sax <jsbc@gmx.de>
Copyright (C) 2008 - 2012 Marvell Technology Group Ltd.
Copyright © 2006-2007 Red Hat, Inc.
Copyright (c) 2014, 2015 Andy Yan <andy.yan@rock-chips.com>
Copyright (C) 2004 Keith M Wesolowski
Copyright (C) 1996,2005,2008 David S. Miller (davem@davemloft.net)
Copyright 2019 Inspur Corp.
Copyright (C) 2007 Sylvain Munaut <tnt@246tnt.com>
Copyright (c) 2003 Matthew Wilcox <matthew@wil.cx>
Copyright (C) 2017 Microchip/Atmel, 2017 Wenyou Yang <wenyou.yang@microchip.com> 2017 Ludovic Desroches <ludovic.desroches@microchip.com>
Copyright (c) 2010-2014 Nikolai Kondrashov
Copyright (c) 201 Broadcom Corporation
Copyright (C) 1996-1998 Russell King.
Copyright (c) 2005-2006 Silicon Graphics, Inc. All Rights Reserved.
"Copyright (C) 2000-2002 Andre Hedrick <andre@linux-ide.org>"
Copyright (c) 2005-2007 Takashi Iwai <tiwai@suse.de>
Copyright (C) 2014 Xilinx
Copyright (C) 2018 Broadcom */
Copyright 1997 Transmeta Corporation - All Rights Reserved
Copyright (c) 2013, Intel Corporation Authors: Huajun Li <huajun.li@intel.com> Haicheng Li <haicheng.li@intel.com>
Copyright (C) 1998-2000 Andreas S. Krebs (akrebs@altavista.net), Maintainer
Copyright (C) 2015 Intel Corp Author:Rafal Redzimski <rafal.f.redzimski@intel.com> Jeeja KP <jeeja.kp@intel.com>
Copyright 2006-2008 Qumranet Technologies
Copyright (C) 2015-16 Intel Corp Author:Rafal Redzimski <rafal.f.redzimski@intel.com> Jeeja KP <jeeja.kp@intel.com>
(C) Copyright 1995 1996 Linus Torvalds;(C) Copyright 2001, 2002 Ralf Baechele
Copyright (C) 1996 Martin von Löwis original #-checking implemented by tytso.
(c) 2000 Interlan Communications;(c) 2000 Stephane Alnet;(C) 2001 Brad Hards;(C) 2002 Oliver Neukum
(c) 2008-2014 Cliff Wickman <cpw@sgi.com>, SGI.
Copyright (C) 2013 Takashi Yoshii <takashi.yoshii.ze@renesas.com>
Copyright 2017 David Lechner <david@lechnology.com>
Copyright (c) 2017 Krzysztof Kozłowski <krzk@kernel.org>
Copyright (C) 2003 Peter Milne, D-TACQ Solutions Ltd Peter dot Milne at D hyphen TACQ dot com>
Copyright (C) 2012 Seth Jennings <sjenning@linux.vnet.ibm.com>
Copyright (c) 2018 Advanced Micro Devices, Inc. All Rights Reserved.
Copyright (C) 2006 Benjamin Herrenschmidt, IBM Corp. benh@kernel.crashing.org> and Arnd Bergmann, IBM Corp.
Copyright 2017 - Free Electrons
Copyright (C) 1999-2018 Tigran Aivazian <aivazian.tigran@gmail.com> Made endianness-clean by Andrew Stribblehill <ads@wompom.org> 2005
Copyright 2003 Intel Corporation
Copyright 2017 NXP

Copyright (c) 2018 Matthew Wilcox <willy@infradead.org>
Copyright (c) 2003-2006, Marvell International Ltd. All Rights Reserved
Copyright (C) 2017 Zodiac Inflight Innovation
Copyright (c) 1994-1998 Initio Corporation All rights reserved.:(c) Copyright 2007 Red Hat <alan@lxorguk.ukuu.org.uk>
Copyright (c) 2018 Pengutronix, Philipp Zabel
Copyright (C) 2015 Intel Corporation
Copyright 2013 Michael Ellerman, Guo Chao, IBM Corp.
Copyright (C) 1997, 2001 by Geert Uytterhoeven and others
Copyright 2010 Tiler Corporation. All Rights Reserved.
Copyright 2004 NVIDIA Corp. All rights reserved.
Copyright (C) 1996,1997 Jakub Jelinek (jj@sunsite.mff.cuni.cz) Pete Zaitcev <zaitcev@yahoo.com> endian fixes for cross-compiles, 2000.
Copyright (c) 2017 Samsung Electronics Co., Ltd. http://www.samsung.com/
(c) 2000-03 Gerd Knorr <kraxel@bytesex.org> [SuSE Labs]
"Copyright (C) 2011 Intel Corporation Authors: Pierre-Louis Bossart <pierre-louis.bossart@linux.intel.com> Vinod Koul <vinod.koul@linux.intel.com>"
Copyright (c) 2002 by Jeff Mahoney, <jeffm@suse.com>
Copyright (C) 2010 Gražvydas Ignotas <notasas@gmail.com>
Copyright (c) 2018 Chris Coffey <cmc@babblebit.net> Based on: Sławomir Stepien's code from mcp4131.c
Copyright (C) 2012 ARM Ltd. Author: Marc Zyngier <marc.zyngier@arm.com>
Copyright (C) 2009 Oberthur Technologies by Omar Laazimani, Olivier Condemine
Copyright: 2011 Raumfeld GmbH Author: Sven Brandau <info@brandau.biz>
Copyright (c) 2010-2012 Savoir-faire Linux Inc. Jerome Oufella <jerome.oufella@savoirfairelinux.com> Vivien Didelot <vivien.didelot@savoirfairelinux.com>
(C) Copyright TOSHIBA CORPORATION 2004-2007 All Rights Reserved.
Copyright (C) 2017 Arm Ltd. ifndef __ASM_SDEI_H define __ASM_SDEI_H
Copyright (C) 2002, ATI Corp.
Copyright (c) 2003 Neil Brown <neilb@cse.unsw.edu.au>
Copyright (C) 2007 FUJITSU LIMITED
Copyright (C) 1995-1997 Paul H. Hargrove
(c) Copyright 1998 Rebel.com (Woody Suwalski <woody@netwinder.org>)
Copyright (C) Martin Schlemmer <azarah@nosferatu.za.org>
Copyright (C) 2014 Rockchip Electronics Co., Ltd. ZhiChao Yu <zhihao.yu@rock-chips.com>
Copyright (C) 2008 Christian Pellegrin <chripell@evolware.org>
Copyright (C) 1997 Roman Hodek
Copyright (c) 2003, Fabian Frederick <ffrederick@users.sourceforge.net>
Copyright (c) 2000 Frodo Looijaard <frodol@dds.nl>, Philip Edelbrock <phil@netroedge.com>, Mark D. Stuebaker <mduxy123@yahoo.com>, Dan Eaton <dan.eaton@rocketlogix.com> and Stephen Rousset <stephen.rou
<stephen.rou>
Copyright (C) 2003 Tresys Technology, LLC
Copyright (C) 2001, 2003 Steve Underwood, 2007 David Rowe
(c) Jason Wessel - Wind River Systems, Inc.
Copyright 2018 Marty E. Plummer <hanetzer@startmail.com> */
(C) Copyright TOSHIBA CORPORATION 2005-2007 All Rights Reserved.
Copyright (c) 2018 Microsemi Corporation
Copyright (C) XLR8, Inc. 1994-2000
Copyright (c) by Jaroslav Kysela <perex@perex.cz> Routines for control of GF1 chip (PCM things)
Copyright (c) 2002 Marko Friedemann <mfr@bmx-chemnitz.de> 2004 Oliver Schwartz <Oliver.Schwartz@gmx.de>, Steven Toth <steve@toth.demon.co.uk>, Franz Lehner <franz@caos.at>, Ivan Hawkes <blackhawk@ivanhawkes.com>
Copyright (C) 2005-2008 Ville Syrjala <syrjala@sci.fi>
Copyright (c) 2017-2019 Pensando Systems, Inc. All rights reserved. */
Copyright (c) 2011, Intel Corporation Authors: Fenghua Yu <fenghua.yu@intel.com>, H. Peter Anvin <hpa@linux.intel.com>
Copyright (C) 2018 Chris Brandt
(c) 2007 Network Appliance, Inc. All Rights Reserved.:(c) 2009 NetApp. All Rights Reserved.
Copyright (C) 2013 Faraday Technology Corporation

LICENCE TERMS (cont.)

Copyright (C) 2010 Stephane Duverger
Copyright (C) 2011-2012 Intel Corporation
Copyright 2002,2003 Andi Kleen, SuSE Labs.
Copyright IBM Corp. 2007, 2009 Author(s): Hongjie Yang <hongjie@us.ibm.com>, Heiko Carstens <heiko.carstens@de.ibm.com>
Copyright (c) 2015 MediaTek Inc. Author: YH Huang <yh.huang@mediatek.com>
(c) Copyright 1998 Alan Cox <alan@ixorguk.ukuu.org.uk>;(c) Copyright 2000, 2001 Red Hat Inc
Copyright (C) 2016 Rafal Milecki <rafal.milecki@gmail.com>
Copyright (C) 2005-2007 Intel Corporation Inaky Perez-Gonzalez <inaky.perez-gonzalez@intel.com>
Copyright (C) 2006-2008 Nokia Corporation Tony Lindgren <tony@atomide.com> Jouni Hogander
Copyright 2005 PMC-Sierra, Inc.
Copyright 2001 Free Software Foundation, Inc.
Copyright IBM Corp 2019
Copyright (c) 2007-2009 Patrick McHardy <kaber@trash.net>
Copyright (c) 2003-2004 Simtec Electronics <linux@simtec.co.uk> http://www.simtec.co.uk/products/SWLINUX/
Copyright (C) 2016 Linaro. Viresh Kumar <viresh.kumar@linaro.org>
Copyright (C) 1992 Drew Eckhardt Generic hard disk header file by Drew Eckhardt
Copyright 2005 Freescale Semiconductor Inc.
Copyright (C) 2015 Xilinx, Inc.
Copyright 2015 Simon Arlott
Copyright (C) 2008 - 2009 Paul Mundt
Copyright (C) 2009 ARM Limited user
(C) Copyright 1994 Linus Torvalds;(C) Copyright 2002 Christoph Hellwig;(C) Copyright 2002 Red Hat Inc, All Rights Reserved
Copyright 2008-2011 Wolfson Microelectronics PLC.
Copyright (C) 2001-2006 Silicon Graphics, Inc. All rights reserved.
Copyright (C) 2017 Google, Inc. Thiebaud Weksteen <tweek@google.com>
Copyright (C) 2009 Marvell Semiconductor
Copyright (C) 2017 Intel Corporation Author: Pierre-Louis Bossart <pierre-louis.bossart@linux.intel.com>
Copyright (c) 2003-2017, Ericsson AB
Copyright (c) 2005 Aristeu Sergio Rozanski Filho <aris@cathedralabs.org>
Copyright (c) 2014, Intel Corporation. Author: Ramakrishna Pallala <ramakrishna.pallala@intel.com>
Copyright (C) 1997,1998 Jakub Jelinek (jj@sunsite.mff.cuni.cz) Heavily based on arch/sparc/kernel/irq.c.
Copyright (C) 2014-2015 SUSE Linux GmbH Written by: Hannes Reinecke <hare@suse.de> Modified by: Damien Le Moal <damiem.lemoal@hgst.com> Modified by: Shaun Tancheff <shaun.tancheff@seagate.com>
Copyright (C) STMicroelectronics SA 2014 Authors: Benjamin Gaignard <benjamin.gaignard@st.com> Fabien Dessenne <fabien.dessenne@st.com> Vincent Abriou <vincent.abriou@st.com> for STMicroelectronics.
Copyright (c) 2014 PLUMgrid, http://plumgrid.com
Copyright (c) 2019 Chelsio Communications, Inc. All rights reserved. */
Copyright 2002 Allend Stichter <allen.stichter@idt.com>
Copyright 2004-2008 Freescale Semiconductor, Inc. All Rights Reserved.
Copyright (C) 2017 SiFive
"Copyright (C) 2008-14 Intel Corp Authors: Vinod Koul <vinod.koul@intel.com> Harsha Priya <priya.harsha@intel.com> Dharageswari R <dharageswari.r@intel.com>"
Copyright (C) 2017 Sebastian Reichel <sre@kernel.org>
(C) 2002 Martin Devera (devik@cdi.cz).
Copyright (C) 2012 Tobias Klauser <tklauser@distanz.ch>
Copyright 2015 Sutajio Ko-Usagi PTE LTD
Copyright (C) 2008 Cedric Bregardis <cedric.bregardis@free.fr> and Jean-Christian Hassler <jhassler@free.fr>
Copyright (C) 2010 Samsung Electronics Co.Ltd Author: HeungJun Kim <riverful.kim@samsung.com> Author: Joonyoung Shim <jy0922.shim@samsung.com>
Copyright 2004 Zwane Mwaikambo <zwane@linuxpower.ca>
(C) The elitist m68k Users(TM)
Copyright (c) 2016, The Linux Foundation. All rights reserved.
Copyright (c) 2007-2014 Jiri Kosina;(C) Jiri Kosina out: return result;
Copyright (C) 2014 Mans Rullgard <mans@mansr.com>
Copyright (C) 2009 Theodore Kilgore <kilgota@auburn.edu>

(C) Jens Axboe <jens.axboe@oracle.com> 2008
Copyright (c) 2000 by Zach Brown <zab@zabbo.net> Takashi Iwai <tiwai@suse.de>
Copyright IBM Corp. 2008 Authors: Sebastian Ott <sebott@linux.vnet.ibm.com>
Copyright (C) 2009/2010 Stefani Seibold <stefani@seibold.net>
Copyright 2011 - 2012 Maxim Integrated Products
Copyright (C) 2009 Novell <trenn@suse.de>
Copyright (C) 2013-2015 Dialog Semiconductor Ltd.
Copyright (C) 2013-2014, Linaro Ltd. Author: Al Stone <al.stone@linaro.org> Author: Graeme Gregory <graeme.gregory@linaro.org> Author: Hanjun Guo <hanjun.guo@linaro.org> Author: Tomasz Nowicki <tomasz.nowicki@linaro.org> Author: Naresh Bhat <naresh.bhat@linaro.org>
Copyright (C) 2001 Mike Corrigan & Dave Engebretsen, IBM Corporation
Copyright (C) 2010 Critical Link LLC - http://www.criticallink.com
Copyright (C) 2018 Collabora, Ltd.
Copyright (C) 2015 Chris Diamand <chris@diamand.org>
Copyright (C) 2006 Aapo Tahkola <aet@rasterburn.org>
Copyright (C) 2002, 2017 Red Hat, Inc. All Rights Reserved. Written by David Howells (dhowells@redhat.com)
Copyright (C) 2000 MontaVista Software Inc.
Copyright (C) 2012 Kevin Cernekee <cernekee@gmail.com>
Copyright (C) 2001 Mike Corrigan & Dave Engebretsen IBM Corporation
Copyright (c) ???? Jochen Schäuble <psionic@psionic.de>
Copyright (C) 1998 Free Software Foundation, Inc.
Copyright (c) 1999 Alexander Larsson <alex@cendio.se>
Copyright (C) 2018-2019 Cadence.
Copyright (c) 2008 Martin Kebert
Copyright (C) 2015 Amlogic, Inc. All rights reserved
Copyright (C) 2001 Laurent Pinchart <lpinchart@freemove.be>
Copyright (c) 2014, The Linux foundation. All rights reserved.
Copyright 1996 The XFree86 Project, Inc.
Copyright (C) 2002 Ladislav Michl
Copyright 2008 Johannes Berg <johannes@sipsolutions.net>
Copyright 2011 Lars-Peter Clausen <lars@metafoo.de>
Copyright (c) 2007 Chelsio, Inc. All rights reserved.
Copyright (C) 2002 - 2005 Tensilica Inc.
Copyright (C) 2018-2019 Jens Axboe
(C) Copyright 2005, Intec Automation, Mike Lavender (mike@steroidmicros);(C) Copyright 2006-2007, David Brownell;(C) Copyright 2007, Axis Communications, Hans-Peter Nilsson (hp@axis.com);(C) Copyright 2007, ATRON electronic GmbH, Jan Nikitenko <jan.nikitenko@gmail.com>
Copyright 2015 Andrea Venturi <be17068@iperbole.bo.it>
Copyright (C) 1996,1997,1998 Russell King. ARM700 fix by Matthew Godbolt (linux-user@willowthetisp.demon.co.uk)
nommu support by Hyok S. Choi (hyok.choi@samsung.com)
Copyright (C) 2011 Samsung Electronics Co.Ltd Author: Jingoo Han <jg1.han@samsung.com>
Copyright (C) 2008 James Smart, Emulex Corporation
Copyright (C) 2009 HIRANO Takahito <hiranotaka@zng.info>
Copyright (C) 2012 Red Hat, Inc., Frederic Weisbecker <fweisbec@redhat.com>
Copyright (C) 1999-2000 Maxim Krasnyansky <max_mk@yahoo.com>
Copyright (C) 1994 by Waldorf GMBH, written by Ralf Baechle
Copyright (C) 2006 Herbert Poetzl
Copyright (C) 1994 by Florian La Roche
Copyright (C) 2017 Google, Inc. Author: Stephen Barber <sbarber@chromium.org>
Copyright IBM Corp. 2001, 2008
Copyright (c) 2008 QUALCOMM Incorporated.
Copyright 1993 United States Government as represented by the Director,
Copyright (C) 2014 NXP Semiconductors All rights reserved.
(C) Copyright 2004, Greg Ungerer (gerg@snapgear.com);(C) Copyright 2009, Philippe De Muyter (phdm@macqel.be)
Copyright (C) 2004-6 DiBcom (http://www.dibcom.fr)
Copyright (c) 2007, 2008 QLogic Corporation. All rights reserved.

LICENCE TERMS (cont.)

Copyright IBM Corporation, 2014
Copyright (C) 2016 PHYTEC Messtechnik Author: Christian Hemp <c.hemp@phytec.de>
Copyright (C) 1995-1999 Olaf Kirch <okir@monad.swb.de>;(C) 2002 Hirokazu Takahashi <taka@valinux.co.jp>
Copyright (c) 2015-2016, NVIDIA CORPORATION. All rights reserved.
Copyright (C) 2016 Free Electrons
Copyright(c) 2011 Integrated Device Technology, Inc. All rights reserved.
(c) Copyright 2002 Justin Cormack <justin@street-vision.com>
Copyright (C) 2016 Martin Peres
Copyright (C) 2015 NVIDIA CORPORATION. All rights reserved.
Copyright 2008-2015 VMware, Inc., Palo Alto, CA., USA
Copyright (C) 2014-2016, Intel Corporation. All rights reserved.
Copyright (C) STMicroelectronics 2017 Author: Gabriel Fernandez <gabriel.fernandez@st.com> for STMicroelectronics.
Copyright (C) 2011-2013 Texas Instruments Incorporated - <http://www.ti.com/>
Copyright (C) 2016 Texas Instruments Incorporated - <http://www.ti.com>
Copyright (C) 2014 Robert Butora (robert.butora.fi@gmail.com)
(C) Copyright IBM Corporation 2001,2006;(c) 2006 Benjamin Herrenschmidt <benh@kernel.crashing.org>, IBM Corp.
Copyright (C) 2018, Anup Patel. Author: Anup Patel <anup@brainfault.org>
(c) Copyright 2000 Grant Grundler;(c) Copyright 2000 Ryan Bradetich;(c) Copyright 2000 Hewlett-Packard Company
Copyright (C) 2017 Touchless Biometric Systems AG Tomas Novotny <tomas@novotny.cz>
Copyright (c) 2004 by Jaroslav Kysela <perex@perex.cz>
Copyright © 2006 Advanced Micro Devices, Inc.
Copyright (c) 1995 Ted Lemon (hereinafter referred to as the author)
Copyright (C) 2000 Toshiba Corporation
Copyright (C) 1998 Franz Sirl
Copyright (C) 2017 Renesas Electronics Corp.
Copyright (C) 2000-2002 Andre Hedrick <andre@linux-ide.org>
Copyright (C) 2012, Anish Kumar <anish198519851985@gmail.com> based on jz4740-battery.c based on s3c_adc_battery.c
Copyright IBM Corp. 2012 Author(s): Holger Dengler <hd@linux.vnet.ibm.com>
Copyright (C) 2000 Inside Out Networks, Inc.
Copyright (c) 2014 David Jander, Protonic Holland
Copyright (C) 2006-2007 Till Harbaum (Till@Harbaum.org)
Copyright (C) 2005-2006 Michael Buesch <m@bues.ch>
Copyright (C) 2008 Jean-Francois Moine (<http://moinejf.free.fr>)
Copyright 2000,2001 Jeff Garzik <jgarzik@pobox.com>
Copyright 2015-16 Maxim Integrated Products
Copyright (c) 1998, 1999 Frodo Looijaard <frodol@dds.nl>
Copyright 2013-2017 by PaX Team <pageexec@freemail.hu> v2
Copyright (C) 1998,2000 Rik van Riel
Copyright (C) 2008 Valentin Longchamp, EPFL Mobots group
Copyright (c) 2014-2016 Andy Lutomirski
Copyright (c) 2017 Akinobu Mita <akinobu.mita@gmail.com>
Copyright (C) 2017 Centrum Embedded Systems, Jia-Bin Huang <jb@ces.com.tw>
Copyright (C) 2015-2016 Broadcom
Copyright 2011 Integrated Device Technology, Inc. Alexandre Bounine <alexandre.bounine@idt.com> Chul Kim <chul.kim@idt.com>
(c) Gerd Hoffmann <kraxel@redhat.com>
Copyright (C) 1998, 1999, 2001, 2003 Ralf Baechle
(C) Copyright IBM 2012;(C) Copyright Linaro Limited 2015v2
Copyright (c) 2008, 2009 open80211s Ltd. Author: Luis Carlos Cobo <luisca@cozybit.com>
Copyright (C) 2005, 2006 Nokia Corporation Author: Samuel Ortiz <samuel.ortiz@nokia.com> and Juha Yrjö <juha.yrjola@nokia.com>
Copyright (C) 2007-2009 Texas Instruments Inc
Copyright (c) 2018 Fuzhou Rockchip Electronics Co., Ltd.
Copyright (C) 2009 Nokia Corporation Author: Juha Yrjöla <juha.yrjola@solidboot.com>
Copyright (c) 2009 Alexander Clouter <alex@digriz.org.uk>
(C) 2005 by Christian Hentschel <chentschel@arnet.com.ar> based on RR's ip_contrack_ftp.c and other modules.:(C) 2007 United Security Providers;(C) 2007, 2008 Patrick McHardy <kaber@trash.net>
Copyright (c) 2002-2004 Martin Langer <martin-langer@gmx.de>, Pilo Chambert <pilo.c@wanadoo.fr>
(c) Copyright 2006-2009 Wim Van Sebroeck <wim@iguana.be>.
Copyright 2010 VMware, Inc., Palo Alto, CA., USA
Copyright (C) 2010 David S. Miller (davem@davemloft.net)
Copyright (c) 2015-2018 Federico Lorenzi
Copyright (C) 2015 IBM Corp.
Copyright (C) 2001 Jens Axboe <axboe@kernel.dk>
Copyright © 2006 Eric Anholt
Copyright (C) 2005, 2006, 2009, 2010, 2012 Texas Instruments Incorporated Author: Aurelien Jacquiot (aurelien.jacquiot@jaluna.com)
Copyright (c) 2015, Intel Corporation.:(C) Copyright 2011~2014 Bosch Sensortec GmbH All Rights Reserved
Copyright (C) 2012 Stefan Roese <sr@denx.de>
Copyright (C) 2002 Richard Henderson
Copyright (C) 2005-2007 Yoichi Yuasa <yuasa@linux-mips.org>
Copyright (C) 2016-2019 Renesas Electronics Corp.
Copyright 2005 Matthew Wilcox <matthew@wil.cx>
Copyright (C) 2006 Benjamin Herrenscheidt, IBM Corporation
Copyright (C) 2000 VA Linux Co
Copyright (c) 2016 The Linux Foundation. All rights reserved.
Copyright (C) 2018 Pengutronix, Lucas Stach <kernel@pengutronix.de>
Copyright (c) 2008 by Jaroslav Kysela <perex@perex.cz>
Copyright IBM Corp. 2010 Author(s): Michael Holzheu <holzheu@linux.vnet.ibm.com>
Copyright (C) 2001 Allan Willcox <allanwillcox@ozemail.com.au>
Copyright (C) 2003-2007 Micronas
(C) 2008 Korolev Alexey <akorolev@infradead.org>;(C) 2008 Vasily Leonenko <vasiliy.leonenko@gmail.com> Many thanks to Roman Borisov for initial enabling
Copyright 2016, Daniel Axtens, IBM Corporation.
Copyright 2018 Cisco Systems, Inc. All rights reserved.
Copyright (c) 2010 Wang Lei Author(s): Wang Lei (wang840925@gmail.com). All Rights Reserved.
Copyright (C) 2012 Samsung Electronics Chanwoo Choi <cw00.choi@samsung.com>
Copyrighted (c) 2013 by Freescale Semiconductor, Inc.:(c) MontaVista Software, Inc.
Copyright (C) 1999 - 2002 Greg Kroah-Hartman (greg@kroah.com)
Copyright (C) 2004 Broadcom Corporation
Copyright (C) 2004 Nokia Corporation Written by Tony Lindgren <tony@atomide.com>
Copyright (C) 2013, Intel Corporation Author: Andy Shevchenko <andriy.shevchenko@linux.intel.com>
Copyright (C) 2018 ROHM Semiconductors ROHM BD70528MWV watchdog driver
Copyright (C) 2012 Atmel
Copyright 2008 MontaVista Software, Inc.
Copyright (C) 2004-2009 EMS Dr. Thomas Wuensche
(c) 1995 Alan Cox, Building #3 <alan@lxguk.ukuu.org.uk>;(c) 1998, 1999, 2000, 2009 Ingo Molnar <mingo@redhat.com>;(c) 2008 Alexey Starikovskiy <astarikovskiy@suse.de>
Copyright (C) 2004, 2007 Jean Delvare <jdelvare@suse.de>
Copyright (C) 2012-2013 Linus Walleij
Copyright (c) 2016 AmLogic, Inc. Michael Turquette <mturquette@baylibre.com>
Copyright 2007 Simtec Electronics <http://www.simtec.co.uk/products/EB2410ITX/> <http://armlinux.simtec.co.uk/> Ben Dooks <ben@simtec.co.uk>
Copyright (C) 2013 Samsung Electronics Co.Ltd
Copyright (C) 2010 ST-Ericsson AB Mian Yousaf Kaukab <mian.yousaf.kaukab@stericsson.com>
Copyright (C) 1999, 2000, 06 Ralf Baechle (ralf@linux-mips.org)
(C) 1992,1993 Brad McLean. See aha1740.c for more info
Copyright (C) 2014 Intel Corporation Contact: Sakari Ailus <sakari.ailus@iki.fi>
Copyright (C) 2006. Bob Jenkins (bob_jenkins@burtleburtle.net)
Copyright (c) 2001 Haroldo Gamal <gamal@alternex.com.br>
Copyright (C) 1998, 1999, 2000 Ralf Baechle

LICENCE TERMS (cont.)

Copyright (C) 2003 Yoshinori Sato <ysato@users.sourceforge.jp>
(c) 1996-8 Grant R. Guenther <grant@torque.net> Under the terms of the GNU General Public License
Copyright (C) 2014 Renesas Electronics Corp.
Copyright (C) 2014 STMicroelectronics (R&D) Limited Author: Giuseppe Cavallaro <peppe.cavallaro@st.com>
Copyright 2004 Silicon Graphics Inc. All Rights Reserved. remark Read the file COPYING
Copyright © 2002-2003, Greg Ungerer (gerg@snapgear.com)
Copyright 2000-2003 Hewlett-Packard Company.
Copyright (c) 2006-2007 Ondrej Zajicek <santiago@crfreenet.org>;(c) 2006 Ondrej Zajicek <santiago@crfreenet.org>); MODULE_DESCRIPTION("fbdev driver for integrated graphics core in VIA VT8623 [CLE266]");
(c) 2014-2017 Valentin Rothberg <valentinrothberg@gmail.com>;(c) 2014 Stefan Hengelein <stefan.hengelein@fau.de>
Copyright (C) 2005 Thomas Kaiser thomas@kaiser-linux.li
Copyright(C) 2007, Red Hat, Inc., Ingo Molnar
Copyright (C) 2017 Red Hat, Inc., Frederic Weisbecker
Copyright 2003 Digi International (www.digi.com) Scott H Kilau <Scott_Kilau at digi dot com>
Copyright (c) 2000-2006 Silicon Graphics, Inc. All rights reserved.
Copyright (C) 2015 Freescale Semiconductor, Inc. All Rights Reserved.
Copyright (C) 2013, Intel Corporation Authors: Mika Westerberg <mika.westerberg@linux.intel.com> Heikki Krogerus <heikki.krogerus@linux.intel.com>
Copyright (C) 2013 Samsung Electronics Co., Ltd. Authors: Kamil Debski <k.debski@samsung.com>
Copyright (C) 2004 Paul Mundt
Copyright IBM Corp. 2001, 2007 Author(s): Martin Peschke <mpeschke@de.ibm.com> Michael Ernst <mernst@de.ibm.com>
Copyright 2013, Anton Blanchard, IBM Corporation.
Copyright (C) 2004-2007 Pierre Ossman, All Rights Reserved.
Copyright (C) 2004 Antoine Jacquet <royale@zerezo.com> http://royale.zerezo.com/zr364xx/
Copyright (C) 2018 Joel Fernandes (Google) <joel@joelfernandes.org>
Copyright (C) 2000-2002 Russell King;(C) 1999 Chris Kemp and Tim Watterton;(C) 2000 Aleph One Ltd (Tak-Shing Chan) EtherM integration re-engineered by Russell King.:(c) 2002-2004 Russell King " DRV_VERSION
Copyright (C) 1999 Philipp Rumpf <prumpf@tux.org>
Copyright (C) 2010 Kan-Ru Chen <kanru@0xlab.org>
Copyright (C) 2016-2018 Hisilicon Ltd.
Copyright (C) 2009 Paulius Zaleckas <paulius.zaleckas@teltonika.lt>
Copyright IBM Corporation, 2013 Author Aneesh Kumar K.V <aneesh.kumar@linux.ibm.com>
(c) 2002-2004 Randolph Chung <tausq@debian.org>
(C) 1999-2001 Paul 'Rusty' Russell;(C) 2002-2006 Netfilter Core Team <coreteam@netfilter.org>;(C) 2003,2004 USAGI/WIDE Project <http://www.linux-ipv6.org>;(C) 2006-2012 Patrick McHardy <kaber@trash.net>
Copyright (C) 2007-2011 Marek Vasut <marek.vasut@gmail.com>
Copyright 2013 - 2014 Maxim Integrated Products
Copyright (C) 2012 Texas Instruments Inc. Peter Ujfalusi <peter.ujfalusi@ti.com>
Copyright (C) 2009 Alexander Clouter <alex@digriz.org.uk>
Copyright (C) 1999-2008 Tensilica Inc.
Copyright (c) 2018 He Yangxuan
Copyright (C) 2007-2010 Hannes Reinecke, SUSE Linux Products GmbH. All rights reserved.
Copyright (C) 2009 Jay Fenlason <fenlason@redhat.com>
Copyright (C) 2004 Benjamin Herrenschmidt (benh@kernel.crashing.org, IBM Corp.
Copyright 2012 Linaro Ltd. Anton Vorontsov <anton.vorontsov@linaro.org>
(C) Waldorf Electronics, Germany Written by Andreas Busse
Copyright 2009 - 2015 VMware, Inc., Palo Alto, CA., USA
Copyright (c) 2016, Jelle van der Waa <jelle@vbwaa.nl>
(C) Copyright 1999 Linus Torvalds;(C) Copyright 1999-2001 Johannes Erdfelt
Copyright (c) 2015 MediaTek Inc. Author: Erin.Lo <erin.lo@mediatek.com>
Copyright (c) 2009 Peter Holik
Copyright (C) 2011 Thomas Langer <thomas.langer@lantiq.com>
Copyright (C) 2013 Chen-Yu Tsai
Copyright (C) 2004 David S. Miller <davem@davemloft.net>
Copyright 2005-2015 Freescale Semiconductor, Inc. All Rights Reserved.

Copyright (C) 2010, 2016 Intel Corp. Huang Ying <ying.huang@intel.com>
(c) 2001 Micro Solutions Inc. Released under the terms of the GNU General Public license
Copyright (C) 2019 Glider bvba
Copyright © 2014 Red Hat
Copyright (c) 2014 Aleksij Rempel <linux@rempe-privat.de>.
Copyright (C) 2018 Rafał Milecki <rafal@milecki.pl>
Copyright (c) 2015, Linaro Limited, Shannon Zhao
Copyright(C) 2005-2006 Chris Humbert
Copyright 2008-2011 DENX Software Engineering GmbH Author: Heiko Schocher <hs@denx.de>
Copyright (C) 2014 Philippe Reynes
Copyright (C) 2014 Ondrej Zary
Copyright 1998, Michael Schmitz <mschmitz@lbl.gov>
Copyright (c) 2012, Alexander Holler.
Copyright (C) 2012 - 2014 Cisco Systems
Copyright (c) 2008 Ramax Lo <ramaxlo@gmail.com> Based on mach-anubis.c by Ben Dooks <ben@simtec.co.uk> and modifications by SBZ <sbz@spgui.org> and Weibing <http://weibing.blogbus.com>
Copyright (C) 2004 Ulf Eklund
Copyright (C) 2012 ST Microelectronics Rajeev Kumar <rajeevkumar.linux@gmail.com>
Copyright 2001 MontaVista Software Inc. Author: Jun Sun, jsun@mvista.com or jsun@junsun.net
Copyright (c) 2016 Microsemi. All Rights Reserved.
Copyright (c) 1999 ITConsult-Pro Co. <info@itc.hu>
Copyright (c) 2018, The Linux Foundation. All rights reserved.*/
Copyright (c) 2002 Brian Bonlander, Bill Soudan
Copyright 2004 Matt Mackall <mpm@selenic.com>;(c) 1997 by Andi Kleen
Copyright (C) 2004 Andreas Monitzer <andy@monitzer.com>
(c) Copyright 2006, 2007 Hewlett-Packard Development Company, L.P. Bjorn Helgaas <bjorn.helgaas@hp.com>
Copyright (C) 2014-2017 Linaro Ltd. <ard.biesheuvel@linaro.org>
Copyright 2016 Icenowy <icenowy@aosc.xyz>
Copyright (C) 2012, Linaro
Copyright (C) 1996,2008 David S. Miller (davem@davemloft.net)
Copyright 2008 Ilya Yanok, Emcraft Systems
Copyright (C) 2008 Yoshihiro Shimoda
copyrighted and maintained by the FlexNet team.
Copyright (c) 2014 Rafał Milecki <zajec5@gmail.com>
Copyright (c) 1997, 1999 by Ralf Baechle
Copyright (C) 1998,2000 David A. Schleef <ds@schleef.org>
Copyright (c) 2011 David George <david.george@ska.ac.za>
Copyright 2014 Linaro Ltd.
Copyright (C) Huawei Futurewei Technologies.
Copyright 2004 Jens Maurer <Jens.Maurer@gmx.net>
Copyright (c) 2014-2015 QLogic Corporation All rights reserved www.qlogic.com
Copyright (c) 2006, 2008 Junio C Hamano
Copyright (C) 2005-2013 MEV Ltd. <http://www.mev.co.uk>
Copyright(c) 2018-2019 Realtek Corporation
Copyright (C) 2004, 2007-2010, 2011-2012 Synopsys, Inc. (www.synopsys.com)
Copyright (c) 2012 Guenther Roeck <linux@roeck-us.net>
Copyright (c) 2014, NVIDIA CORPORATION. All rights reserved.
Copyright (C) 1997-2000 David A. Schleef <ds@schleef.org>
Copyright (C) 2007 Ian Armstrong <ian@iarmst.demon.co.uk>
Copyright (c) 2015-2017 QLogic Corporation
Copyright (C) 2012 Texas Instruments Incorporated - http://www.ti.com/
Copyright 02 Jul 2003, Linux Networx (http://lnxi.com) This file may be distributed
Copyright (C) 2007 Davide Libenzi <davidel@xmailserver.org>
Copyright (c) 2019 Andy Yan <andy.yan@gmail.com>
Copyright 2015 Linaro Limited
Copyright 2014 Google Inc.
Copyright (c) 2014-2018, The Linux Foundation. All rights reserved.

LICENCE TERMS (cont.)

(C) 1999-2001 Paul 'Rusty' Russell;(C) 2002-2004 Netfilter Core Team <coreteam@netfilter.org>
Copyright (C) 2018, Google LLC.
Copyright (c) 2014 Samsung Electronics Co., Ltd. Author: Ajay Kumar <ajaykumar.rs@samsung.com>
Copyright © 2014 Intel Corporation
Copyright (C) 2012-2014 Boris BREZILLON <b.brezillon@overkiz.com> 2014-2015 Gaël PORTAY <g.portay@overkiz.com>
Copyright 2006 Wolfson Microelectronics PLC
Copyright 2005 Thomas Hellstrom. All Rights Reserved.
Copyright 2010 Freescale Semiconductor, Inc.
Copyright (C) 2011 Texas Instruments, Inc. Santosh Shilimkar <santosh.shilimkar@ti.com>
Copyright 2012 Cisco Systems, Inc. All rights reserved.
Copyright (C) 2017 Broadcom
Copyright (c) 1999-2002 Vojtech Pavlik
Copyright (C) 2012 ARM Limited
Copyright (c) 2014, Intel Corporation.
Copyright (C) Linaro.
Copyright 2012 Red Hat <mjg@redhat.com>
Copyright (C) 2002 - 2007 Jeff Dike (jdike@{addtoit,linux.intel}.com)
Copyright (C) 1999-2001, 2005 Hewlett-Packard Co David Mosberger-Tang <davidm@hpl.hp.com>
Copyright (c) 2009-2013 VMware, Inc., Palo Alto, CA., USA All Rights Reserved.
(C) Copyright 2009-2011, Greg Ungerer <gerg@snapgear.com>
Copyright (c) by Jaroslav Kysela <perex@perex.cz>
Copyright 2014-2017 Lothar Waßmann <LW@KARO-electronics.de>
Copyright © 2019 Intel Corporation
Copyright 2008 NXP Semiconductors Chris Steel <chris.steel@nxp.com> Daniel Laird <daniel.j.laird@nxp.com>
Copyright (c) 2013, Cisco Systems, Inc. All rights reserved.
Copyright (C) 2014-2015 Ralph Metzler <rjkm@metzlerbros.de> Marcus Metzler <mocm@metzlerbros.de>
developed for Digital Devices GmbH
Copyright (C) 2009 Renesas Solutions Corp.
Copyright (C) 2002 Intersil Americas Inc.
Copyright (c) 2005-2014 Brocade Communications Systems, Inc.
Copyright 2015 Analog Devices Inc. Author: Lars-Peter Clausen <lars@metafoo.de>
Copyright (C) 2011 Wind River Systems, written by Ralf Baechle <ralf@linux-mips.org>
Copyright (C) 2001-2016 PaX Team, Bradley Spengler, Open Source Security Inc.
Copyright 2015 Hans de Goede <hdegoede@redhat.com>
Copyright (c) 2016 BayLibre, SAS. Author: Neil Armstrong <narmstrong@baylibre.com>
Copyright (c) 2018 Samsung Electronics Co., Ltd. Author: Marek Szymowski <m.szymowski@samsung.com>
Copyright (C) 2010-2014 Intel Corp Author: Vinod Koul <vinod.koul@intel.com> Author: Harsha Priya <priya.harsha@intel.com>
Copyright (C) 2015 Renesas Solutions Corp. Kuninori Morimoto <kuninori.morimoto.gx@renesas.com>
Copyright (C) 2000 - 2007 Jeff Dike (jdike@{addtoit,linux.intel}.com)
Copyright (C) 2005-2011 NTT DATA CORPORATION
Copyright (C) 2014 Felix Fietkau <nbd@openwrt.org>
Copyright © 2016 Intel Corporation
Copyright (c) 2003-2012 Cavium Networks
Copyright (c) 2016, Intel Corporation.
Copyright (C) 2007 Felix Fietkau <nbd@openwrt.org>
Copyright (C) 1993 Linus Torvalds
Copyright (C) 2011-2012 Texas Instruments Inc. Contact: Eduardo Valentin <eduardo.valentin@ti.com>
Copyright (C) 2013-2015 Renesas Electronics Corporation
"Copyright (C) 2006 Yoichi Yuasa <yuasa@linux-mips.org>"
Copyright (C) 2004 - 2009 Ivo van Doorn <ivdoorn@gmail.com> http://rt2x00.serialmonkey.com>
Copyright (C) 1996-2005 Paul Mackerras.
Copyright (c) 2010, NVIDIA Corporation. Based on arch/arm/plat-mxc/pwm.c by Sascha Hauer <s.hauer@pengutronix.de>
Copyright (C) STMicroelectronics SA 2014 Author: Fabien Dessenne <fabien.dessenne@st.com> for STMicroelectronics.

Copyright (C) 2004, 2005, 2006, 2008 Thiemo Seufer
Copyright (C) 2011 Texas Instruments Incorporated - http://www.ti.com/ Author: Rob Clark <rob.clark@linaro.org>
Copyright 2008 Wolfson Microelectronics PLC. Author: Mark Brown <broonie@opensource.wolfsonmicro.com>
Copyright (c) 2000-2002,2005 Silicon Graphics, Inc. All Rights Reserved.
Copyright (c) 2018 MediaTek Inc. Author: Chunhui Dai <chunhui.dai@mediatek.com>
Copyright (c) 2004-2005 Simtec Electronics http://armlinux.simtec.co.uk/ Ben Dooks <ben@simtec.co.uk>
Copyright (C) 2008 Maxime Bizon <mbizon@freebox.fr>
Copyright (C) 2009-2010 PetaLogix
Copyright (c) 2015-2016 HiSilicon Technologies Co., Ltd.
Copyright (C) 2010 Francisco Jerez. All Rights Reserved.
Copyright (c) 2019 Facebook
Copyright (C) 2018 Stanislaw Gruszka <stf_xl@wp.pl>
Copyright (C) 2001 Randolph Chung <tausq@parisc-linux.org>
Copyright 2008-2012 Freescale Semiconductor Inc.
Copyright (C) 2014 Marvell Technology Group Ltd.
Copyright (C) 2011 Fujitsu. All rights reserved. Written by Miao Xie <miaox@cn.fujitsu.com>
Copyright (c) 2012, NVIDIA CORPORATION. All rights reserved.
Copyright (c) 2009 Intel Corporation
Copyright 2017 Advanced Micro Devices, Inc.
Copyright (c) 2016 AmLogic, Inc. Author: Michael Turquette <mturquette@baylibre.com>
Copyright (C) 2007 Hans Verkuil <hverkuil@xs4all.nl>
Copyright (C) 2013-2017 Oracle Corporation This file is based on ast_drv.h
Copyright (C) 2008 Gabor Juhos <juhosg@openwrt.org>
Copyright (c) 2012-2016, The Linux Foundation. All rights reserved.
Copyright (c) 2006-2007 Mauro Carvalho Chehab <mchehab@kernel.org>
Copyright (C) 2005 by Stefan Lucke
Copyright (C) 2000 Harald Koerfgen
Copyright (C) 2012-2013 Cavium Inc., All Rights Reserved.
Copyright 2018 Advanced Micro Devices, Inc.
Copyright © 2008 IBM Corporation
Copyright (C) 2016 Imagination Technologies Author: Paul Burton <paul.burton@mips.com>
Copyright 2009-2018 Canonical Ltd.
Copyright (c) 1996, 2003 VIA Networking Technologies, Inc. All rights reserved.
Copyright 2016 Realtek Microelectronics Author: Bard Liao <bardliao@realtek.com>
Copyright (C) 2013 John Crispin <john@phrozen.org>
Copyright (c) 2015 Cadence Design Systems Inc.
Copyright 2012 Stefan Roese <sr@denx.de>
Copyright (C) 2011 Texas Instruments
Copyright (c) 2013 Samsung Electronics Co., Ltd. http://www.samsung.com
Copyright (c) 2015-2019, Linaro Limited
Copyright (c) 2019, Intel Corporation.
Copyright (C) IBM Corporation, 2015
Copyright 2012 Advanced Micro Devices, Inc.
Copyright(c) 2013 Intel Corporation.
Copyright (C) 2006-2010 Nokia Corporation
Copyright (C) 1998-2003 Hewlett-Packard Co David Mosberger-Tang <davidm@hpl.hp.com>
Copyright (c) 2015, The Linux Foundation. All rights reserved.
Copyright (C) Abilis Systems 2013
Copyright 2015 Red Hat Inc.
Copyright 2008 Cisco Systems, Inc. All rights reserved.
Copyright (c) 2012, Intel Corporation.
Copyright 2006 Tejun Heo <htejun@gmail.com>
Copyright 2017 Texas Instruments, Inc.
Copyright 2017-2019 Qiang Yu <yuyq825@gmail.com>
Copyright(c) 2003 - 2014 Intel Corporation. All rights reserved.
Copyright (C) 2004, 2009, 2010 Texas Instruments Incorporated Author: Aurelien Jacquot (aurelien.jacquot@jaluna.com)

LICENCE TERMS (cont.)

Copyright (c) 2010-2011 Samsung Electronics Co., Ltd. <http://www.samsung.com/>
Copyright (C) 2010 - 2015 Len Brown <len.brown@intel.com>
Copyright (C) 2011 Anssi Hannula <anssi.hannula@?ki.fi>
Copyright (C) 2007 Casey Schaufler <casey@schaufler-ca.com>
Copyright (C) 2007-2009 STMicroelectronics Ltd
Copyright 2012 Cisco Systems, Inc. and/or its affiliates. All rights reserved.
Copyright Intel Corporation (C) 2014-2016. All Rights Reserved
Copyright (C) 2018 Hangzhou C-SKY Microsystems co.,ltd.
Copyright (C) 1991, 1992 Linus Torvalds
Copyright (C) 2010-2011 Red Hat, Inc.
Copyright (C) Manu Abraham (abraham.manu@gmail.com)
Copyright 2010 Wolfson Microelectronics plc Author: Dimitris Papastamos <dp@opensource.wolfsonmicro.com>
Copyright (c) 2018 BayLibre, SAS. Author: Jerome Brunet <jbrunet@baylibre.com>
Copyright (C) 2005 Ralph Metzler <rjkm@metzlerbros.de> Metzler Brothers Systementwicklung GbR
Copyright (C) 2018 Xue Liu <liuxuenetmail@gmail.com>
Copyright 2014-2016 The OpenSSL Project Authors. All Rights Reserved.
Copyright (C) 2016 David Lechner <david@lechnology.com>
Copyright (C) 2014 Altera Corporation. All rights reserved
Copyright 2009-2010 Pengutronix Uwe Kleine-Koenig <u.kleine-koenig@pengutronix.de>
Copyright (c) 2008-2011 Atheros Communications Inc.
Copyright (C) 2000 - 2019, Intel Corp.
Copyright (C) 2012 Red Hat, Inc. All Rights Reserved. Written by David Howells (dhowells@redhat.com)
Copyright (c) 1995-2000 Advanced System Products, Inc.
Copyright (c) 2005 Andrea Merello <andrea.merello@gmail.com>
Copyright (C) 2011 Instituto Nokia de Tecnologia
Copyright (c) 2006-2008 Hans de Goede <hdegoede@redhat.com>
Copyright (C) 2005-2009 Yoichi Yuasa <yuasa@linux-mips.org>
Copyright (C) 2006 Freescale Semiconductor, Inc. All rights reserved.
"Copyright: (C) Torsten Schenk"
Copyright(c) 2009-2014 Realtek Corporation.
Copyright (C) 2001 - 2012 Tensilica Inc.
Copyright (C) 2000 Geert Uytterhoeven <geert@linux-m68k.org> Sony Software Development Center Europe (SDCE), Brussels
Copyright (C) 2015 Dialog Semiconductor Ltd.
Copyright 2013 Freescale Semiconductor Inc.
Copyright (C) 1992 - 1997, 1999 Silicon Graphics, Inc.
Copyright (C) 2019 Hangzhou C-SKY Microsystems co.,ltd.
Copyright (c) 2010-2011 Samsung Electronics Co., Ltd. http://www.samsung.com
Copyright 2003 Andi Kleen, SuSE Labs.
Copyright 2005 (c) MontaVista Software, Inc.
Copyright (C) 2012 Marvell International Ltd. Joseph(Yossi) Hanin <yhanin@marvell.com> Yi Zhang <yizhang@marvell.com>
Copyright (C) 1999 Steve Ratcliffe
Copyright (C) 2018 Aleksandr Aleksandrov <aleksandr.aleksandrov@emlid.com>
Copyright (C) 2001 Chris Gauthron
Copyright © 2018-2019 Intel Corporation
Copyright (C) 1992 by Theodore Ts'o.
Copyright (c) 2002 James Morris <jmorris@intercode.com.au>
Copyright (c) 2014-2017 Qualcomm Atheros, Inc.
Copyright (c) 2019 Christian Mauderer <oss@c-mauderer.de>
Copyright (c) 1998 Harald Koerfgen
Copyright (c) 2014 - 2020 Vivante Corporation
Copyright (C) 2008-2012 Jean-Francois Moine <<http://moinejf.free.fr>>
Copyright 2018-2019 NXP
Copyright (C) 2018 Advanced Micro Devices, Inc.
Copyright (C) 2012 Sylwester Nawrocki <sylwester.nawrocki@gmail.com>
Copyright(c) 2014 Broadcom Corporation. All rights reserved.

Copyright (c) 2007 Secret Lab Technologies Ltd.
Copyright (C) 2018 Netronome Systems, Inc.
Copyright IBM Corp. 2008
Copyright (C) 1996,97 Ralph Metzler (rjkm@thp.uni-koeln.de);(c) 1999,2000 Gerd Knorr <kraxel@goldbach.in-berlin.de>
Copyright (C) 2017 Linaro Ltd. <ard.biesheuvel@linaro.org>
Copyright(c) 2018 Intel Corporation. All rights reserved.
Copyright 2002-2003, Instant802 Networks, Inc.
Copyright (C) 2013-2014, Marvell International Ltd.
Copyright (c) 2012 Steffen Trumtrar <s.trumtrar@pengutronix.de>, Pengutronix
Copyright 2009-2011 Analog Devices Inc.
Copyright 2018 Cirrus Logic, Inc.
Copyright (c) 1999-2000 Cisco, Inc.
Copyright (C) 2018 Chelsio Communications. All rights reserved.
Copyright (C) 2016 Red Hat, Inc. All rights reserved.
Copyright (C) 2015-2017 I2SE GmbH <info@i2se.com>
Copyright 2013 Freescale Semiconductor, Inc.
Copyright (C) 2008 Michal Simek <monstr@monstr.eu>
Copyright (C) 2004 Kay Sievers <kay.sievers@vrfy.org>
Copyright IBM Corp. 2001, 2009;(C) 2001 IBM Corp. by Fritz Elfert (felfert@millenux.com)
Copyright 2012-15 Advanced Micro Devices, Inc.
Copyright IBM Corp. 2003 Author(s): Martin Schwidefsky (schwidefsky@de.ibm.com),
Copyright (C) 2013-2014 Broadcom Corporation
Copyright (c) 2018 Martin Blumenstingl <martin.blumenstingl@googlemail.com>
Copyright 2017 Icenowy Zheng <icenowy@aosc.xyz>
(c) 1997-8 Grant R. Guenther <grant@torque.net>
(c) Copyright 2007-2008 Xilinx Inc. All rights reserved.
Copyright (ST) 2011 Vipin Kumar (vipin.kumar@st.com)
Copyright (C) 2008 Google, Inc.
(C) 2006-2008 by Openmoko, Inc. Author: Balaji Rao <balajirao@openmoko.org> All rights reserved.
Copyright (C) 2007 Luca Olivetti (luca@ventoso.org)
Copyright (c) 2015 MediaTek Inc.
Copyright 2014 Advanced Micro Devices, Inc.
Copyright (C) 2017 Pengutronix, Juergen Borleis <kernel@pengutronix.de>
Copyright (C) 2001, 2002, 2003 Paul Mundt
Copyright (C) STMicroelectronics 2018 - All Rights Reserved Author: Ludovic.barre@st.com for STMicroelectronics.
Copyright (c) 2010-2015 Chelsio Communications, Inc.
Copyright (C) 2006 Atmark Techno, Inc.
(c) 2001-03 Gerd Knorr <kraxel@bytesex.org> [SuSE Labs]
Copyright (C) 2010 Nokia Corporation
Copyright (c) 2015 Sasha Levin <sasha.levin@oracle.com>
Copyright (c) 2013-2015, Mellanox Technologies. All rights reserved.
Copyright(c) 2014 Intel Corporation. This program is free software
Copyright (C) 2016-2018 Netronome Systems, Inc.
Copyright 1999 by Carsten Paeth <calle@calle.de>
Copyright 2012 - 2015 Freescale Semiconductor Inc.
Copyright (C) 2011-2012 Red Hat UK.
Copyright 2004-2007 Freescale Semiconductor, Inc. All Rights Reserved.
Copyright (C) 2013 Samsung Electronics Co., Ltd.
Copyright: (C) 2012 Julia Lawall, INRIA/LIP6.
Copyright (c) 2011, 2012, Qualcomm Atheros Communications Inc.
Copyright (C) 2004-2012 Cavium Networks
Copyright 2005-2007 PMC-Sierra, Inc.
Copyright 2019 NXP
Copyright (C) 1999 Niibe Yutaka & Takeshi Yaegashi
Copyright (C) 2012-2015 Freescale Semiconductor, Inc. All Rights Reserved.
Copyright (C) 2004 Utilitek Systems, Inc.

LICENCE TERMS (cont.)

Copyright (c) 2003-2006, Cluster File Systems, Inc, info@clusterfs.com Written by Alex Tomas <alex@clusterfs.com>
Copyright (c) Clemens Ladisch <clemens@ladisch.de>
Copyright (c) 2009-2013 QLogic Corporation
Copyright (C) 2012, by Texas Instruments
Copyright (c) 2009 Yauhen Kharuzhy <jekhor@gmail.com>, as part of OpenInkpot project
Copyright 2012 Freescale Semiconductor, Inc.
Copyright (c) 2014 Red Hat, Inc. All Rights Reserved.
Copyright (C) 2010 John Crispin <john@phrozen.org>
Copyright (C) 2010-2011 Texas Instruments Incorporated - http://www.ti.com/ Authors: Yong Zhi Mythri pk <mythripk@ti.com>
Copyright (C) 2011 The AC100 Kernel Team <ac100@lists.lauchpad.net>
Copyright (c) 2016-2017 Hisilicon Limited.
Copyright 2014 Zoltan HERPAI Zoltan HERPAI <wigyori@uid0.hu>
Copyright 2013 Red Hat Inc.
Copyright 1998,1999 SysKonnect, a business unit of Schneider & Koch & Co. Datensysteme GmbH.
Copyright (C) 2015 Microchip Technology
Copyright (C) 2015 Intel Corporation
Copyright (c) 2003 Adaptec Inc. All rights reserved.
(C) 2002 by Brian J. Murrell <netfilter@interlinx.bc.ca> based on a copy of HW's ip_nat_irc.c as well as other modules;(C) 2006-2012 Patrick McHardy <kaber@trash.net>
Copyright (C) 2008-2014 Red Hat Inc, Steven Rostedt <ststedt@redhat.com>
Copyright (c) 1999 by Jaroslav Kysela <perex@perex.cz>, Abramo Bagnara <abramo@alsa-project.org>
Copyright (C) 2003 David Borowski.
Copyright 2008-2010 Cisco Systems, Inc. All rights reserved.
Copyright (C) 1995-1997 Olaf Kirch <okir@monad.swb.de>
Copyright (c) 2014, The Linux Foundation. All rights reserved.
Copyright (C) 2006-2008 Nokia Corporation.
Copyright (C) 2014 Axentia Technologies AB Author: Peter Rosin <peda@axentia.se>
Copyright 2009 Jerome Glisse. All Rights Reserved.
Copyright (C) 2013 Renesas Electronics Corporation
Copyright (c) 2007, 2010, 2012 Freescale Semiconductor, Inc.
Copyright 2011-2014 Autronica Fire and Security AS
Copyright (C) ST-Ericsson SA 2010
Copyright (C) 2007-2016 Oracle Corporation
Copyright (C) 2007-2010 Texas Instruments Inc
Copyright IBM Corp. 2019
Copyright (C) 2002, 2003 Maciej W. Rozycki
Copyright (C) 2017 Linus Walleij <linus.walleij@linaro.org>
Copyright 2012-2015 Freescale Semiconductor Inc.
Copyright (C) 2016 Florent Revest <florent.revest@free-electrons.com>
Copyright 2016 Advanced Micro Devices, Inc.
(C) Copyright 2004 Linus Torvalds
Copyright (C) 2013 - Virtual Open Systems Author: Antonios Motakis <a.motakis@virtualopensystems.com>
Copyright (C) 2013 Pengutronix Uwe Kleine-Koenig <u.kleine-koenig@pengutronix.de>
Copyright (C) 1996-2012 Markus F.X.J. Oberhumer <markus@oberhumer.com>
Copyright (c) 2008, Jouni Malinen <j@w1.fi>
Copyright (C) 2014-2016 Texas Instruments Incorporated - http://www.ti.com/
Copyright (C) 2007 Tomi Orava (tomimo@ncircle.nullnet.fi)
Copyright (c) 2014-2015 MediaTek Inc. Author: Hongzhou.Yang <hongzhou.yang@mediatek.com>
Copyright (C) 2010-2014 Michael Krufky <mkrufky@linuxtv.org>
Copyright (C) 2013-2019 B.A.T.M.A.N. contributors:
Copyright © 2004 Texas Instruments, Jian Zhang <jzhang@ti.com>
Copyright (C) Motorola, Inc. 1990 All Rights Reserved
Copyright (c) 2018, The Linux Foundation. All rights reserved. *)
Copyright (C) 2017 Radioavionica Corporation Author: Alex A. Mihaylov <minimumlaw@rambler.ru>
Copyright (c) 2006-2009 VMware, Inc., Palo Alto, CA., USA All Rights Reserved.

Copyright (C) ST-Ericsson SA 2010 Author: Shujuan Chen <shujuan.chen@stericsson.com> for ST-Ericsson.
Author: Jonas Linde <jonas.linde@stericsson.com> for ST-Ericsson. Author: Joakim Bech <joakim.xx.bech@stericsson.com> for ST-Ericsson. Author: Berne Hebrak <berne.hebrak@stericsson.com>
Copyright (c) 2007, 2009 Anssi Hannula <anssi.hannula@gmail.com>
Copyright 2014 Maxime Ripard
Copyright (C) 2001-2010 GUAN Xue-tao
Copyright 2006 Freescale Semiconductor Inc.
Copyright © 2003-2018 Intel Corporation
Copyright (C) 2013 Freescale Semiconductor, Inc.
Copyright(c) 2015 Intel Corporation.
Copyright (c) 1998-1999 by Frank van de Pol <fvdpol@coil.demon.nl>;(c) 1998-1999 by Jaroslav Kysela <perex@perex.cz>
Copyright (C) 2011-2012 Texas Instruments Incorporated - http://www.ti.com/
Copyright IBM Corp. 2003, 2009
Copyright(c) 2007 - 2010 Realtek Corporation. All rights reserved. Linux device driver for RTL8192SU
Copyright (C) 2005-2010 Red Hat, Inc. All rights reserved.
Copyright(c) 2011-2016 Intel Corporation. All rights reserved.
Copyright (C) 2007 Oracle. All rights reserved.
Copyright (c) 2018 MediaTek Inc. Author: KaiChieh Chuang <kaichieh.chuang@mediatek.com>
Copyright (c) 2014 Samsung Electronics Co., Ltd. http://www.samsung.com
Copyright (C) 2004 Benjamin Herrenschmidt (benh@kernel.crashing.org), IBM Corp.
Copyright 1998-2004 H. Peter Anvin -- All Rights Reserved
(c) Copyright Hewlett-Packard Development Company, L.P., 2006
Copyright 1991-2012 Unicode, Inc. All rights reserved. Distributed under
Copyright (c) 2016-2017 The Linux Foundation. All rights reserved.
Copyright (C) Paul Mackerras 1997.
Copyright (C) 2012-2019 ARM Limited (or its affiliates).
Copyright 2019 NXP.
Copyright (c) Harald Koerfgen, 1998
Copyright (C) IBM Corporation, 2010-2011 Author: Srikar Dronamraju
Copyright (C) 2018 Zodiac Inflight Innovations
Copyright 2011 Red Hat Inc.
Copyright (C) 2016 Imre Kaloz <kaloz@openwrt.org>
Copyright 2017-2018 NXP
Copyright (C) ST-Ericsson SA 2012
Copyright (C) 1999-2000 Hewlett-Packard Co
Copyright (c) 2016-2018 Cavium Inc.
(C) Copyright 2016, Xilinx, Inc.
Copyright 2016-2018 HabanaLabs, Ltd. All Rights Reserved.
Copyright (C) 2015-2017 Spreadtrum, Inc. Author: Chunyan Zhang <chunyan.zhang@spreadtrum.com>
Copyright (C) 1998 Steffen A. Mork (linux-dev@morknet.de)
Copyright (C) 2000-2002 Joakim Axelsson <gozem@linux.nu> Patrick Schaaf <bof@bof.de>
Copyright (C) Tino Reichardt, 2012
Copyright (C) 2017-2018 Broadcom
Copyright (c) 1997,1998 Werner Koch (dd9jn)
Copyright (c) 2002 Russell King. Modified for nommu by Hyok S. Choi
Copyright (C) 2007 Imre Kaloz <Kaloz@openwrt.org>
Copyright (C) 2001 Jens Axboe <axboe@suse.de>
Copyright (c) 2015, Intel Corporation.
Copyright (C) 2000 Jeff Wiedemeier (Compaq Computer Corporation)
Copyright (C) 2011-2014, Marvell International Ltd.
Copyright (C) 1995-2003 Geert Uytterhoeven
Copyright (C) 2007 Stefan Kopp, Gechingen, Germany
Copyright (c) 2010-2011 Atheros Communications Inc.
Copyright (C) 2017 Marvell
Copyright (C) 2017-2019 Microchip Technology Inc.
Copyright (C) 2018 Sean Young <sean@mess.org>

LICENCE TERMS (cont.)

Copyright 2010 Paul Mackerras, IBM Corp. <paulus@au1.ibm.com>
Copyright 2012-17 Advanced Micro Devices, Inc.
Copyright 2007 Secret Lab Technologies Ltd.
Copyright (C) 2008 Nokia Corporation. All rights reserved.
Copyright (c) 2007-2017 Nicira, Inc.
Copyright (c) 2011 - 2012 Samsung Electronics Co., Ltd. http://www.samsung.com
Copyright (C) 2005 Stephen Hemminger <shemminger@osdl.org>
Copyright 2008-2013 Freescale Semiconductor Inc.
Copyright (c) 2010-2012, The Linux Foundation. All rights reserved.
Copyright (C) 2011 Texas Instruments Incorporated
Copyright(c) 2013-2018 Intel Corporation.
Copyright (C) 1999-2001 ARM Limited
Copyright 2014, Michael Ellerman, IBM Corp.
Copyright (c) 2014-2015 Hisilicon Limited.
Copyright 2017 IBM Corp.
Copyright (C) 2005 Adaptec, Inc. All rights reserved.
Copyright (c) 2013, The Linux Foundation. All rights reserved.
Copyright 2009 Analog Devices Inc.
Copyright (c) 2010 Broadcom Corporation
Copyright (c) 1999 Al Smith;(c) 1995,1996 Christian Vogelgsang.
Copyright (c) 2017 Microsemi Corporation
Copyright 2009-2014 Analog Devices Inc.
Copyright(c) 2007 - 2011 Realtek Corporation. All rights reserved.
Copyright (C) 1999, 2007, 2008 David S. Miller (davem@davemloft.net)
Copyright (C) 2010 Pengutronix Uwe Kleine-Koenig <u.kleine-koenig@pengutronix.de>
"Copyright: [copy] 2009-2010 Henrik Rydberg <rydberg@euromail.se>"
Copyright (c) 2003-2018, Intel Corporation. All rights reserved. Intel Management Engine Interface (Intel MEI) Linux driver
Copyright (c) 2001 by David Brownell
Copyright (C) 2019 Arm Ltd.
Copyright (C) 2001-2005 Thomas Winischhofer, Vienna, Austria.
Copyright (C) 2010,2012 - NVIDIA, Inc.
Copyright(c) 2015 EZchip Technologies.
Copyright (C) 2016 Freescale Semiconductor, Inc.
(C) Copyright IBM Corp. 2001, 2004
Copyright (C) 2012 Samsung Electronics Co., Ltd. http://www.samsung.com/
Copyright: [copy] 2015 Stephen Chandler Paul <thatslyude@gmail.com>
Copyright (C) 2013 Maxime Ripard
Copyright (c) 2017 Facebook
Copyright (c) 2014 MediaTek Inc. Author: Joe.C <yingjoe.chen@mediatek.com>
Copyright (C) 2008 SUSE LINUX Products GmbH by Bernhard Walle <bernhard.walle@gmx.de>
Copyright(c) 2008 - 2014 Intel Corporation. All rights reserved.
Copyright(c) 2009-2012 Realtek Corporation.
Copyright (C) 2015, Samsung Electronics Co., Ltd.
(C) Copyright IBM Deutschland Entwicklung GmbH 2005-2007
Copyright (c) 2017, Oracle and/or its affiliates. All rights reserved.
Copyright 2014 Cisco Systems, Inc. All rights reserved.
Copyright 2000 by Hans Reiser, licensing governed by reiserfs/README
Copyright (c) International Business Machines Corp., 2006
Copyright 2012 Red Hat Inc.
Copyright (C) 1999 Jeff Hartmann
Copyright (C) 2015 Yoshinori Sato <ysato@users.sourceforge.jp>
Copyright (C) 2003 Andreas Oberitter <obi@linuxtv.org>
Copyright (C) 2003-2008 Alan Stern;(C) 2009 Samsung Electronics Author: Michal Nazarewicz (mina86@mina86.com)
Copyright 2011 Freescale Semiconductor Inc.
Copyright (C) 2007 Sony Computer Entertainment Inc.

Copyright © 2009 - Maxim Levitsky SmartMedia/xD translation layer
Copyright(c) 2012 - 2014 Intel Corporation. All rights reserved.
Copyright (c) 2012-2016 VMware, Inc. All rights reserved.
Copyright (C) 2014 ARM Ltd.
Copyright 2008 by Karsten Keil <kkeil@novell.com>
Copyright (C) 2016 Neil Armstrong <narmstrong@baylibre.com>
Copyright (C) 2003, 04, 07 Ralf Baechle <ralf@linux-mips.org>
Copyright (C) 1999,2000 MIPS Technologies, Inc. All rights reserved.
Copyright 2016,2017 IBM Corporation.
Copyright (C) 2003 by Ralf Baechle
Copyright 2008-2015 Freescale Semiconductor Inc.
Copyright 2016 Elettra-Sincrotrone Trieste S.C.p.A.
Copyright (C) 2017 Hisilicon Limited Author: Anurup M <anurup.m@huawei.com> Shaokun Zhang <zhangshaokun@hisilicon.com>
Copyright(c) 2009-2013 Realtek Semiconductor Corp. All rights reserved.
Copyright (C) 2014 Romain Perier
Copyright (c) 2001 by Jaroslav Kysela <perex@perex.cz>
Copyright (c) 2014-2017 Oracle. All rights reserved.
Copyright (C) 2010, Guennadi Liakhovetski <g.liakhovetski@gmx.de>
Copyright (c) 2013, NVIDIA Corporation. All rights reserved.
Copyright (c) 2013 Eugene Krasnikov <k.eugene.e@gmail.com>
Copyright (c) 2010-2013, NVIDIA Corporation.
Copyright 2013 Crystalfontz America, Inc.
Copyright IBM Corp. 2013
Copyright (C) 1995, 1996, 1997, 2002, 2003 by Ralf Baechle
Copyright (c) 2007-2013 Broadcom Corporation
Copyright (C) 2004, 2007 Freescale Semiconductor, Inc.:(C) 2004 Intracom, S.A.:(C) 2005-2006 MontaVista Software, Inc. Vitaly Bordug <vbordug@ru.mvista.com>
Copyright (C) 1998, 1999 Hewlett-Packard Co David Mosberger-Tang <davidm@hpl.hp.com>
Copyright (C) 2015 Samsung Electronics Co., Ltd Author: Jacek Anaszewski <j.anaszewski@samsung.com>
Copyright 2003-2006, 2008-2009, 2011 Freescale Semiconductor, Inc.
Copyright (C) 2009 Texas Instruments Inc Author: Santiago Nunez-Corrales <santiago.nunez@ridgerun.com>
Copyright (C) 2012 Phil Edworthy
Copyright (C) ST Microelectronics SA 2011
Copyright 2004 Felix Kuehling All Rights Reserved.
Copyright 2016-2019 HabanaLabs, Ltd. All Rights Reserved.
Copyright (C) 1996 David S. Miller (davem@davemloft.net)
Copyright 2014 IBM Corp.
Copyright (c) 2004-2008 Reyk Floeter <reyk@openbsd.org>
Copyright (C) 2015 Josh Poimboeuf <jpoimboe@redhat.com>
Copyright (c) 2018 Synopsys, Inc. and/or its affiliates. stm32 TC Handling (HW only)
Copyright(c) by Ralph Metzler, Gerd Knorr, Gunther Mayer
Copyright (C) 2013 VMware, Inc. All rights reserved.
Copyright (c) 2000,2002,2005 Silicon Graphics, Inc.
Copyright (c) 2003-2017 Cavium, Inc. All rights reserved.
Copyright (C) 1995-2003 Russell King
Copyright (C) 2012, Intel Corporation Authors: Mathias Nyman <mathias.nyman@linux.intel.com> Mika Westerberg <mika.westerberg@linux.intel.com>
Copyright (C) 2008 ARM Limited
Copyright 2017 Red Hat Inc.
Copyright (C) 2016 Intel Corporation. All rights reserved.
Copyright (c) 2019 BayLibre, SAS Author: Neil Armstrong <narmstrong@baylibre.com>
Copyright (c) 2007 Freescale Semiconductor, Inc.
Copyright (c) 2010-2015 Steven Toth <stoth@kernellabs.com>
Copyright (c) 2016, NVIDIA CORPORATION. All rights reserved.
Copyright (C) 2016 David Lechner
Copyright (C) 2007 Alex Dubov <oakad@yahoo.com>

LICENCE TERMS (cont.)

Copyright (c) 2010-2013, The Linux Foundation. All rights reserved.
Copyright (c) 2015-2016 HGST, a Western Digital Company.
Copyright (C) 2012 Marvell
Copyright (c) 1997 by Procom Technology, Inc. 2001-2003 by Arnaldo Carvalho de Melo <acme@conectiva.com.br>
Copyright © 2014-2017 Broadcom
Copyright IBM Corp. 2009, 2017
Copyright (C) 2005-2007 AMD (<http://www.amd.com>) Author: Thomas Dahlmann
Copyright (C) 2008-2009 Texas Instruments Inc
Copyright (C) 2008 IBM
Copyright (c) 2018 Facebook
Copyright (c) 2003-2014 QLogic Corporation
Copyright (C) 1996-1999 David S. Miller (davem@caip.rutgers.edu)
Copyright (C) 2006 Arcom Control Systems Ltd.
Copyright (C) 2016 Jens Axboe
Copyright (C) 2009 Magnus Damm
Copyright (C) 2012,2013 - ARM Ltd Author: Marc Zyngier <marc.zyngier@arm.com>
Copyright (C) 2013 STMicroelectronics (R&D) Limited. Authors: Srinivas Kandagatla <srinivas.kandagatla@st.com>
Copyright (C) 2013 Texas Instruments, Inc.
Copyright (C) 2011 Google, Inc.
Copyright (C) 2017 Linaro Ltd <ard.biesheuvel@linaro.org>
Copyright 2012-16 Advanced Micro Devices, Inc.
Copyright 2005-2006 Red Hat Inc, all rights reserved.
Copyright (C) 2007 Nicolas Thill <nico@openwrt.org>
Copyright 2012 ST-Ericsson AB
Copyright 2011 Analog Devices Inc.
Copyright (C) 2000-2002 Michael Cornwell <cornwell@acm.org>
Copyright (C) 2016 Robert Jarzmik <robert.jarzmik@free.fr>
Copyright (C) 2003 BULL SA
Copyright (C) 2012 Texas Instruments. All rights reserved.
Copyright (c) 2008-2012 Freescale Semiconductor, Inc. All rights reserved.
Copyright (C) 2003-2006 David Hollis <dhollis@davehollis.com>
Copyright (c) 1999-2007 Joerg Heckenbach <joerg@heckenbach-aw.de> Dwaine Garden <dwainegarden@rogers.com>
Copyright (c) 2010-2011 Ericsson AB
Copyright (c) 2015-2018 Mellanox Technologies. All rights reserved */
Copyright (C) 2017, Intel Corporation Authors: Michael Jamet <michael.jamet@intel.com> Mika Westerberg <mika.westerberg@linux.intel.com>
Copyright(c) 2007 - 2012 Realtek Corporation. All rights reserved.
Copyright (C) 2014 by Ralf Baechle <ralf@linux-mips.org>
Copyright (c) 2018-2019 Synopsys, Inc. and/or its affiliates. Synopsys DesignWare eDMA PCIe driver
Copyright (C) 2017 Free Electrons Maxime Ripard <maxime.ripard@free-electrons.com>
Copyright (C) 2018 Johan Hovold <johan@kernel.org>
Copyright IBM Corp. 2008, 2010
Copyright (c) 2003 Intracom S.A. by Pantelis Antoniou <panto@intracom.gr>;(c) MontaVista Software, Inc. Vitaly Bordug <vbordug@ru.mvista.com>
Copyright (C) 2018 David Lechner <david@lechnology.com>
Copyright (C) 2016 Renesas Electronics Corp.
Copyright (c) 2017 Oracle and/or its affiliates. All rights reserved.
Copyright (c) 2009 Diego Giagio <diego@giagio.com> All rights reserved.
Copyright (C) 1995,1996 David S. Miller (davem@caip.rutgers.edu)
Copyright (C) 2017-2018 Broadcom. All Rights Reserved. The term
Copyright (C) 2008 Atmel Corporation
Copyright (C) 2004, 05, 06 by Ralf Baechle
Copyright (C) 2001 Hewlett-Packard (Paul Bame) <bame@debian.org>
(c) 2008 Dan Williams <dcwb@redhat.com>
Copyright (C) 2011 - 2014 Xilinx
Copyright (C) 2018, Red Hat Inc, Arnaldo Carvalho de Melo <acme@redhat.com> SPDX-License-Identifier: LGPL-

2.1
Copyright 2007 Sony Corporation
Copyright (C) 2016 BayLibre, SAS Author: Neil Armstrong <narmstrong@baylibre.com>
(C) 2003 - 2004 Dominik Brodowski
Copyright (C) 2007-2008 Yoichi Yuasa <yuasa@linux-mips.org>
Copyright(c) 1999 - 2018 Intel Corporation.
Copyright (C) 2007 Red Hat, Inc. All Rights Reserved. Written by David Howells (dhowells@redhat.com)
Copyright (c) 2016 Oracle. All rights reserved.
Copyright (C) 2006 - 2009 Paul Mundt
Copyright (C) 1998-2002 Hewlett-Packard Co David Mosberger-Tang <davidm@hpl.hp.com>
Copyright 2014-2015 Google Inc.
Copyright (C) 2014 ARM Ltd. Author: Catalin Marinas <catalin.marinas@arm.com>
Copyright (C) 2010 Lantiq Deutschland
Copyright (C) Hitachi Ltd., 2015 Written by Hiraku Toyooka <hiraku.toyooka.gu@hitachi.com>
Copyright 2016-2017 Cisco Systems, Inc. and/or its affiliates. All rights reserved.
Copyright (C) 2018 Google, Inc.
Copyright (C) 2014 Microchip Alexandre Belloni <alexandre.belloni@free-electrons.com>
Copyright 2012-2013 STMicroelectronics Inc.
Copyright (C) ST-Ericsson AB 2010 Author: Daniel Martensson Dmitry.Tarnyagin / dmitry.tarnyagin@lockless.no
Copyright (C) 2003 Sistina Software (UK) Limited.
Copyright (c) 2017, Fuzhou Rockchip Electronics Co., Ltd
Copyright 2010-2017 ARM Limited. All rights reserved.
Copyright (C) 2009 Nokia Corporation
Copyright (c) 2018 Mellanox Technologies. All rights reserved
Copyright 2016 Boundary Devices, Inc.
Copyright (c) 2019 Sven Schnelle <svens@stackframe.org>
Copyright (c) 2008 Ramax Lo <ramaxlo@gmail.com> Based on mach-anubis.c by Ben Dooks <ben@simtec.co.uk> and modifications by SBZ <sbz@spgui.org> and Weibing <<http://weibing.blogbus.com>> and Michel Pollet <buserror@gmail.com>
Copyright (c) 2013 Samsung Electronics Co., Ltd. <http://www.samsung.com/>
Copyright (c) 2000-2002 Vojtech Pavlik <vojtech@ucw.cz>
Copyright 2018, Michael Ellerman, IBM Corporation.
Copyright 1993, Drew Eckhardt Visionary Computing Unix consulting and custom programming) drew@colorado.edu 1 (303) 666-5836
Copyright (c) 2014 Janne Kannianen <janne.kannianen@gmail.com>
Copyright (c) 2012-2013, NVIDIA CORPORATION. All rights reserved.
Copyright 2004 Arnaud Patard <arnaud.patard@rtp-net.org>
Copyright (C) 2012 Red Hat. All rights reserved.
Copyright (c) 1987-1999 Carnegie Mellon University Additional copyrights listed below
Copyright (c) 2000 The Regents of the University of Michigan. All rights reserved.
Copyright (C) 2015 Marvell Technology Group Ltd.
Copyright (c) 2016 Andreas Färber
(C) Copyright 1999 Roman Weissgaerber <weissg@vienna.at>
Copyright (C) 2017 HiSilicon Limited, All Rights Reserved. Author: Gabriele Paoloni <gabriele.paoloni@huawei.com>
Author: Zhichang Yuan <yuanzhichang@hisilicon.com>
Copyright (c) 2011-2013, NVIDIA Corporation.
Copyright (c) 2018 Chelsio Communications, Inc.
Copyright 2012 Wolfson Microelectronics plc
Copyright (c) 2016-2017 Broadcom Limited
Copyright (C) 2017-2019 Broadcom. All Rights Reserved. The term
Copyright (c) 2009 Philipp Zabel
Copyright 2016-2019 NXP
Copyright IBM Corp. 1999, 2010
Copyright 2018 Google LLC. Tomasz Figa <tfiga@chromium.org>
Copyright (C) 1993, 1994, 1995 Remy Card (card@masi.ibp.fr) Laboratoire MASI - Institut Blaise Pascal Universite Pierre et Marie Curie (Paris VI)
Copyright (C) 2017-2018 HUAWEI, Inc. <http://www.huawei.com/> Created by Gao Xiang <gaoxiang25@huawei.com>

LICENCE TERMS (cont.)

Copyright (C) 1999–2000 Geert Uytterhoeven
Copyright (C) 2011 Gabor Juhos <juhosg@openwrt.org>
Copyright (c) 2009, Intel Corporation.
Copyright NXP 2020
Copyright (C) 2003-2013 Jozsef Kadlec <kadlec@netfilter.org>
Copyright (C) 2008 Cambridge Silicon Radio Ltd.
Copyright (C) 1996 David S. Miller (davem@caip.rutgers.edu)
Copyright 2019,2020 NXP
Copyright (C) 2011 STRATO. All rights reserved.
Copyright (C) 2009 IBM Corporation Author: Mimi Zohar <zohar@us.ibm.com>
Copyright (C) 2002 Maxim Krasnyansky <maxk@qualcomm.com>
Copyright (c) 2015 MediaTek Inc. Author: Leilk Liu <leilk.liu@mediatek.com>
Copyright (c) 2011 Broadcom Corporation
Copyright (C) 2015 Texas Instruments Incorporated - <http://www.ti.com/> Andrew F. Davis <afd@ti.com>
Copyright (C) 2019 MediaTek Inc.
Copyright 1995-2001 Russell King
Copyright (C) 2010 ST Microelectronics Bhupesh Sharma <bhupesh.sharma@st.com>
Copyright (C) 2009 Nokia Corporation Author: Tomi Valkeinen <tomi.valkeinen@nokia.com>
Copyright (C) 2016 Advanced Micro Devices, Inc.
Copyright (C) 2004-2006 Trusted Computer Solutions, Inc.:(c) Copyright Hewlett-Packard Development Company, L.P., 2006
Copyright (C) 1998 Paul Mackerras.
Copyright (C) 2000 Marcus Metzler <marcus@convergence.de> Ralph Metzler <ralph@convergence.de> for convergence integrated media GmbH
(C) 2001-2004 Dave Jones.:(C) 2002 Pdraig Brady. <padraig@antefacto.com>
Copyright (c) 2009 NVIDIA Corporation.
Copyright Altera Corporation (C) 2013-2015. All rights reserved
Copyright (c) 2013-2018, The Linux Foundation. All rights reserved.
Copyright 2015-2016 Google Inc.
Copyright(c) 2007 - 2018 Intel Corporation.
Copyright 2013 Advanced Micro Devices, Inc.
Copyright (C) 2016-2018 Matt Ranostay Author: < matt.ranostay@konsulko.com>
Copyright (c) 2008 by David Brownell
Copyright (C) 2001, 2002 Andy Grover <andrew.grover@intel.com>
Copyright 2016 Toradex AG
Copyright IBM Corp. 2017
Copyright (C) 2012-2015 - ARM Ltd Author: Marc Zyngier <marc.zyngier@arm.com>
Copyright Echo Digital Audio Corporation (c) 1998 - 2005 All rights reserved www.echoaudio.com
Copyright(c) 2014 Intel Corporation.
Copyright © 2018 Alexey Dobriyan <adobriyan@gmail.com>
Copyright © 2006-2007 Red Hat, Inc.
Copyright (c) 2000-2006 PMC-Sierra INC.
Copyright (C) STMicroelectronics SA 2015 Author: Hugues Fruchet <hugues.fruchet@st.com> for STMicroelectronics.
Copyright 2013 Boundary Devices, Inc.
Copyright (c) STMicroelectronics 2015
Copyright (c) 2016 - 2017, Broadcom. All rights reserved. The term Broadcom refers to Broadcom Limited and/or its subsidiaries.
Copyright (C) 2001-2010 Guan Xuetao
Copyright (C) 2016 Linaro Ltd. Author: Linus Walleij <linus.walleij@linaro.org>
Copyright (C) 2014 Google, Inc.
Copyright (C) 2002 Deep Blue Solutions Ltd, All Rights Reserved.
Copyright (C) 2009 picoChip Designs, Ltd., Jamie Iles
Copyright (c) 2005-2007 Michael Buesch <m@bues.ch>
Copyright (C) 2012-2013 Samsung Electronics Co., Ltd.
Copyright (c) 2018 MediaTek Inc. Author: Houlong Wei <houlong.wei@mediatek.com>
Copyright (C) 2004 Ryan S Arnold, IBM Corporation

Copyright (c) 2004 Evgeniy Polyakov <zbr@ioremap.net>
Copyright (c) 2009 Daniel Mack <daniel@caiaq.de>
Copyright (c) 2018 MediaTek Inc. Author: Yong Wu <yong.wu@mediatek.com>
Copyright (C) 2001 - 2007 Tensilica Inc.
Copyright (C) 2016 Altera Corporation. All rights reserved.
Copyright (c) 2010-2011, The Linux Foundation. All rights reserved.
"Copyright (C) 1999 David A. Hinds. All Rights Reserved.:(C) 1999 David A. Hinds:(C) 2003 - 2010 Dominik Brodowski"
Copyright 2014 Analog Devices Inc. Author: Lars-Peter Clausen <lars@metafoo.de>
Copyright (C) 2004 by Eric Van Hensbergen <ericvh@gmail.com>
Copyright 2018 Red Hat Inc.
Copyright (C) 2007 Lemote, Inc. Author : jlliu, liujl@lemote.com
Copyright (c) 2017-2019 Mellanox Technologies. All rights reserved.
Copyright (C) 2010 Tobias Klauser <tklauser@distanz.ch>
Copyright (C) 2005 Tower Technologies
Copyright (C) 2016 T-Platforms. All Rights Reserved.
Copyright (c) 2018, NVIDIA CORPORATION. All rights reserved.
Copyright (c) 2006-2008 Dominik Kühlen <dkuhlen@gmx.net>
Copyright 2012 Red Hat Inc. Parts based on xf86-video-ast
Copyright(c) 2015, 2016 Intel Corporation.
Copyright (c) 2014 MediaTek Inc. Author: Flora Fu <flora.fu@mediatek.com>
Copyright (C) 2013-14 Renesas Solutions Corp.
Copyright 2014-2020 NXP
Copyright (C) 2017-2018 Microchip Technology Inc.
Copyright (C) 2018-2019, Intel Corporation.
Copyright (C) 1999 David A. Hinds. All Rights Reserved.
Copyright(c) 2019 Realtek Semiconductor Corp.
Copyright 2011 Advanced Micro Devices, Inc.
(C) Copyright 2016-2018 - Mathieu Desnoyers <mathieu.desnoyers@efficios.com>
Copyright SUSE Linux Products GmbH 2009
Copyright (C) 2011 Tobias Klauser <tklauser@distanz.ch>
Copyright (C) 2012 Samsung Electronics. Kyungmin Park <kyungmin.park@samsung.com> Tomasz Figa <t.figa@samsung.com>
Copyright (C) 2015-2016 Samsung Electronics Igor Kotrasinski <i.kotrasinsk@samsung.com> Krzysztof Opasiak <k.opasiak@samsung.com>
Copyright (C) 2012 ARM Ltd. Author: Marc Zyngier <marc.zyngier@arm.com>
Copyright (C) 2008-2014 Mathieu Desnoyers <mathieu.desnoyers@efficios.com>
Copyright (c) 2016 Mellanox Technologies. All rights reserved.
Copyright (C) 2013 Samsung Electronics Co., Ltd. <http://www.samsung.com>
Copyright (C) 2000 Marc Boucher <marc@mbsi.ca>;(C) 2005 by Harald Welte <laforge@netfilter.org>
Copyright: (C) 2009-2010 Julia Lawall, Nicolas Palix, DIKU.
Copyright (c) 2010, 2014 The Linux Foundation. All rights reserved.
Copyright (C) 1996, 1997, 1998 Olaf Kirch <okir@monad.swb.de>
Copyright (C) 2003 Sean McGoogan (Sean.McGoogan@superh.com)
Copyright (C) 2009 Texas Instruments Inc Author: Ajay Kumar Gupta <ajay.gupta@ti.com>
Copyright (c) Jean-Luc Cooke <jlcooke@certaintkey.com>
Copyright 2011 Realtek Microelectronics Author: Johnny Hsu <johnnyhsu@realtek.com>
Copyright (C) 2010 Antti Palosaari <crope@iki.fi>
Copyright (C) 2006 - 2008 Paul Mundt
Copyright (c) 2014 Actions Semi Inc. Author: David Liu <liuwei@actions-semi.com>
Copyright (C) 2009 Red Hat, Inc.
Copyright 2002-2004 H. Peter Anvin - All Rights Reserved
Copyright (C) 2015 Vishnu Patekar <vishnupatekar0510@gmail.com>
Copyright (C) 1996 Russell King.
Copyright (c) 2012 Samsung Electronics Co., Ltd. <http://www.samsung.com/>
Copyright (c) 2012, NVIDIA Corporation. All rights reserved.
Copyright 2012-2013 Freescale Semiconductor Inc.

LICENCE TERMS (cont.)

Copyright (c) 2013-2014 Linaro Ltd.
Copyright (C) Alex Holden <alex@linuxhacker.org> 1998, 1999.;(C) Alex Holden " alex@linuxhacker.org> 1998.
Copyright (C) 2016 Synopsys, Inc. (www.synopsys.com)
Copyright (c) 2009-2010 Atheros Communications Inc.
Copyright (c) 2013 Trond Myklebust <Trond.Myklebust@netapp.com>
Copyright 1998-2009 VIA Technologies, Inc. All Rights Reserved.
Copyright (c) 2010 Red Hat Inc. Author : Dave Airlie <airlied@redhat.com>
Copyright (C) 2014 MEN Mikro Elektronik Nuernberg GmbH
Copyright(c) 2007 Intel Corporation. All rights reserved.
Copyright (c) 2018, Mellanox Technologies inc. All rights reserved.
Copyright(c) 2009-2010 Realtek Corporation.
Copyright (c) 2012-2014, The Linux Foundation. All rights reserved.
Copyright (c) 2013, Applied Micro Circuits Corporation Author: Loc Ho <lho@apm.com>
Copyright (C) 2014-2015 Marvell International Ltd.
Copyright (C) 2010-2013 Texas Instruments, Inc. Rajendra Nayak <rnayak@ti.com> Santosh Shilimkar <santosh.shilimkar@ti.com>
Copyright (C) 2009-2010, Lars-Peter Clausen <lars@metafoo.de> PCF50633 backlight device driver
Copyright (C) 2019 Advanced Micro Devices, Inc.
Copyright (C) 2004-2019 Bernd Porr, mail@berndporr.me.uk
Copyright (C) 2001-2004 Stelian Pop <stelian@popies.net>
Copyright (C) 2017 Google, Inc.
Copyright (C) 2012 Bachmann electronic GmbH Christian Gmeiner <christian.gmeiner@gmail.com>
Copyright (C) ST-Ericsson SA 2013
Copyright (C) 2000 Jeff Dike (jdike@karaya.com)
Copyright (C) 1996,1998 David S. Miller (davem@redhat.com)
Copyright 2012 Red Hat Inc
Copyright(c) 2007 - 2010 Realtek Corporation. All rights reserved.
Copyright (C) Hitachi Ltd., 2014 Written by Masami Hiramatsu <masami.hiramatsu.pt@hitachi.com>
Copyright(c) 2015 - 2018 Intel Corporation.
Copyright (C) 1998, 1999, 2002, 2003 Hewlett-Packard Co David Mosberger-Tang <davidm@hpl.hp.com>
Copyright (C) 2013-2015 Samsung Electronics Jonghwa Lee <jonghwa3.lee@samsung.com> Krzysztof Kozlowski <krzk@kernel.org>
Copyright IBM Corp. 2006 Author(s): Heiko Carstens <heiko.carstens@de.ibm.com>
Copyright (c) 2004, 2005 Topspin Communications. All rights reserved.
Copyright (c) 2012 Broadcom Corporation
Copyright (C) 2012 Renesas Solutions Corp.
Copyright (C) 2015 Laurent Fasnacht <l@libres.ch>
Copyright (c) International Business Machines Corp., 2003, 2007 Author(s): Steve French (sfrench@us.ibm.com)
Copyright (C) 2012, Analog Devices Inc. Author: Lars-Peter Clausen <lars@metafoo.de>
Copyright (C)2004-2010 Freescale Semiconductor, Inc. All Rights Reserved.
Copyright (C) 1995 Hamish Macdonald
Copyright 2013 Emilio López
Copyright (C) 2015 John Crispin <blogic@openwrt.org>
Copyright 2005, Red Hat, Inc., Ingo Molnar
Copyright (C) 2011 Texas Instruments Incorporated Author: Mark Salter <msalter@redhat.com>
Copyright (C) 2011 The AC100 Kernel Team <ac100@lists.launchpad.net>
Copyright (C) 2000-2008, Willy Tarreau <w@1wt.eu>
Copyright (c) 2016, Intel Corporation Authors: Salvator Benedetto <salvatore.benedetto@intel.com>
Copyright (c) 2006 SUSE Linux Products GmbH
Copyright (C) 1992 - 1997 Silicon Graphics, Inc.
Copyright (C) 1996,97,98 Ralph Metzler (rjkm@thp.uni-koeln.de) Marcus Metzler (mocm@thp.uni-koeln.de);(c) 2002 Yuriy Sysoev <yurij@naturesoft.net>;(c) 1999-2003 Gerd Knorr <kraxel@bytesex.org>;(c) 2005 Mauro Carvalho Chehab <mchehab@kernel.org> Multituner support and i2c address binding
Copyright (C) 2005-2007 Kristian Hoegsberg <krh@bitplanet.net>
Copyright (c) 2019 Microsemi Corporation
Copyright (C) 1996 David S. Miller (davem@caipfs.rutgers.edu)
Copyright (C) 2009, 2010, 2011 Cypress Semiconductor, Inc.

Copyright (c) 2017, NVIDIA CORPORATION. All rights reserved.
Copyright (C) 2006 International Business Machines Corp.
Copyright (C) 2012 Texas Instruments, Inc. Paul Walmsley
Copyright (c) 2009 Patrick McHardy <kaber@trash.net>
Copyright (C) Sistina Software, Inc. 1997-2003 All rights reserved.
Copyright 2017 NXP Semiconductor, Inc.
Copyright (C) 2009 Texas Instruments, Inc.
Copyright 2015 IBM Corp.
Copyright (C) 1996,97,98 Ralph Metzler (rjkm@thp.uni-koeln.de) 2001 Michael Eskin 2002 Yuriy Sysoev <yurij@naturesoft.net> 2003 Gerd Knorr <kraxel@bytesex.org>
(C) COPYRIGHT 2018 ARM Limited. All rights reserved. Author: James.Qian.Wang <james.qian.wang@arm.com>
Copyright (C) 2015, IBM Corporation Author: Laurent Dufour <ldufour@linux.vnet.ibm.com>
Copyright (C) 2003-2018 Cavium, Inc.
Copyright (C) 2005-2006 Intel Corporation Inaky Perez-Gonzalez <inaky.perez-gonzalez@intel.com>
Copyright (C) 2004-2013 Synopsys, Inc.
(C) 2016 Arnaldo Carvalho de Melo <acme@redhat.com>
Copyright (c) 2019 MediaTek Inc. Author: James Liao <jamesjliao@mediatek.com> Fabien Parent <fparent@baylibre.com>
Copyright (C) 2015, Microchip Technology Germany II GmbH & Co. KG
Copyright (c) 2017, Mellanox Technologies. All rights reserved.
Copyright (c) 2018 Socionext Inc.
Copyright 2009-2011 Freescale Semiconductor Inc.
Copyright (c) 2000-2003,2005 Silicon Graphics, Inc. All Rights Reserved.
Copyright (C) 2004 by Ralf Baechle
Copyright (C) 2000 MIPS Technologies, Inc. All rights reserved.
Copyright (C) 2004 Richard Curnow
Copyright (C) 2009 by Tom Zanussi <tzanussi@gmail.com>
Copyright (C) 1999-2003 Matthew Wilcox <willy at parisc-linux.org>
Copyright 2016 Google Inc.
Copyright (C) 2000, 2001 Paolo Alberelli
Copyright 2020 NXP
Copyright 2015 Karol Herbst
Copyright (C) 2003-2008 David Brownell
Copyright (C) 2015 Paradox Innovation Ltd.
Copyright (C) 2007 by Alan Stern
Copyright (C) 2014 Advanced Micro Devices, Inc.
Copyright (c) 2013, Intel Corporation.
Copyright (C) 2019 Zodiac Inflight Innovations
Copyright (c) 2007 Alexey Starikovskiy <astarikovskiy@suse.de>
Copyright IBM Corp. 2018
Copyright (C) 2017 Jagan Teki <jteki@openedev.com>
Copyright © 2001-2007 Red Hat, Inc.
Copyright (C) 2016 Free Electrons
Copyright 2005-2009 - Steven Rostedt
Copyright (C) 2017 Josh Poimboeuf <jpoimboe@redhat.com>
Copyright (C) 2005 Ivan Kokshaysky
Copyright (c) 2017 Icenowy Zheng <icenowy@aosc.xyz>
Copyright (c) 2003 K.M. Liu <kmliu@sis.com>
Copyright (C) 2002 David S. Miller (davem@redhat.com)
Copyright 2012 Analog Devices Inc.
Copyright (C) 2012-2019 ARM Limited or its affiliates.
Copyright (c) 2008 Magnus Damm
Copyright (C) 2014 by Wolfram Sang <wsa@sang-engineering.com>
Copyright (C) 2013-2015 Fujitsu Semiconductor Ltd.
Copyright (c) 2006 Chelsio, Inc. All rights reserved.
Copyright © 2016-2019 Intel Corporation
Copyright (C) 2012 Texas Instruments, Inc.

LICENCE TERMS (cont.)

Copyright (C) 2018 Spreadtrum Communications Inc.
Copyright (C) 2007-2009 Arjan Opmeer <arjan@opmeer.net>
Copyright (C) 2007 Anders Blomdell <anders.blomdell@control.lth.se>
Copyright (C) 2009 - 2010 Ivo van Doorn <IvDoorn@gmail.com>
Copyright (c) 2002 Paul Davis Marcus Andersson Thomas Charbonnel
Copyright (C) 2018 Cadence Design Systems Inc.
Copyright (c) 2015, Intel Corporation Authors: Tadeusz Struk <tadeusz.struk@intel.com>
Copyright (C) 2006 Texas Instruments.
Copyright 2006 Andi Kleen, SUSE Labs.
Copyright © 2008-2010 Intel Corporation
Copyright (C) 2014-2015 Intel Corporation.
Copyright (C) 2005 Matthias Urlichs <smurf@smurf.noris.de>
Copyright (C) IBM Corporation, 2012
Copyright (C) 2016-2017 Texas Instruments Incorporated - <http://www.ti.com/> Nishanth Menon <nm@ti.com> Dave Gerlach <d-gerlach@ti.com>
Copyright (C) 2013 Synopsys, Inc. (www.synopsys.com)
Copyright (C) 2017, Spreadtrum Communications Inc.
Copyright 2018 Broadcom
Copyright (c) 2015-2016 Intel Corporation. All rights reserved.
Copyright (c) 2016, NVIDIA Corporation
Copyright (C) 2002 Michael Hillmann <hillmann@syscongroup.de>
Copyright (C) 2015-2017 Russell King.
(C) Copyright 2016 Intel Corporation Author: Andy Shevchenko <andriy.shevchenko@linux.intel.com>
Copyright (C) 2002, 2004, 2007 by Ralf Baechle <ralf@linux-mips.org>
Copyright (C) 2001 Deep Blue Solutions Ltd.
Copyright 2000 by Hypercope GmbH
Copyright (C) 2011 secunet Security Networks AG
Copyright 2011 Calxeda, Inc.
Copyright (c) 2015, Linaro Limited
Copyright (c) 2003-2004 LSI Logic Corporation.
Copyright (C) 2016, 2018 Author: Matt Ranostay <matt.ranostay@konsulko.com>
Copyright (c) 2012-2014 NVIDIA CORPORATION. All rights reserved.
Copyright (C) 1996, 1997, 1998, 1999, 2000 by Ralf Baechle
Copyright 2018 Analog Devices Inc.
Copyright (C) 2015-2016 Freescale Semiconductor, Inc.
Copyright (c) 2018 James.Bottomley@HansenPartnership.com
Copyright 2012 Benjamin Herrenschmidt, IBM Corp.:(c) container_of(c, struct wf_lm87_sensor, sens)
Copyright (C) 2003-2004 Kevin Thayer <nufan_wfk at yahoo.com>
Copyright (C) 2015 Freescale Semiconductor, Inc.
Copyright 2017-2020 NXP
Copyright (C) 2016-2018 Xilinx
Copyright 2018 NXP
Copyright 2017 NXP
Copyright 2014 Ulrich Hecht
Copyright 2016 Chandan Kumar, IBM Corporation.
Copyright (c) 2010 Ira W. Snyder <iws@ovro.caltech.edu>
Copyright(c) 2007 - 2014 Intel Corporation. All rights reserved.
Copyright (C) 2014 SUSE Linux Products GmbH
Copyright 2015 Google Inc.
Copyright 2005 Mentor Graphics Corporation
Copyright (C) 2004 David Gibson <dwg@au.ibm.com>, IBM Based on earlier code written by: Dave Engebretsen and Mike Corrigan {engebret|mikejc}@us.ibm.com
Copyright (C) 2018 Texas Instruments Incorporated - <http://www.ti.com> Author: Peter Ujfalusi <peter.ujfalusi@ti.com>
Copyright (C) 1992, 1993, 1994, 1995 Remy Card (card@masi.ibp.fr) Theodore Ts'o (tytso@mit.edu)
Copyright (c) 2015-2016, Intel Corporation. All rights reserved. Intel Management Engine Interface (Intel MEI) Linux driver

Copyright (C) 2009 Marvell International Ltd.
Copyright (c) 2014 Samsung Electronics Co., Ltd. Author: Tomasz Figa <t.figa@samsung.com>
"Copyright (C) 2008-14 Intel Corp Authors: Vinod Koul <vinod.koul@intel.com> Harsha Priya <priya.harsha@intel.com> Dharageswari R <dharageswari.r@intel.com> KP Jeeja <jeeja.kp@intel.com>"
Copyright (C) 2019 Renesas Electronics Corp. Kuninori Morimoto <kuninori.morimoto.gx@renesas.com>
Copyright (C) 2017 Renesas Electronics America, Inc.
Copyright (c) 2011 David George <david.george@ska.ac.za>
Copyright (C) 2014 Red Hat Author: Rob Clark <robdclark@gmail.com>
Copyright (c) 2004-2011 Freescale Semiconductor, Inc.
(c) 2009,2010 Dick Streefland <dick@streefland.net>;(c) 2011 Corentin Chary <corentin.chary@gmail.com>
Copyright (c) 2006 Philipp Zabel <philipp.zabel@gmail.com>
Copyright (C) Maxime Coquelin 2015
Copyright 2018 Google LLC
Copyright (C) Fuzhou Rockchip Electronics Co.Ltd Author: Chris Zhong <zyw@rock-chips.com>
Copyright © 2014 Jussi Kivilinna <jussi.kivilinna@iki.fi>
Copyright (C) IBM Corporation, 2009
Copyright 2001, STMicroelectronics, Inc.
Copyright (C) 2000 Philipp Rumpf <prumpf@tux.org>
Copyright © 2017 Intel Corporation
Copyright (C) 2013, Analog Devices Inc. Author: Lars-Peter Clausen <lars@metafoo.de>
Copyright (c) 2010 Mika Laitio <laitio@iki.fi>
Copyright (C) 2010 Yong Shen <yong.shen@linaro.org>
Copyright (C) 2016-17 Synopsys, Inc. (www.synopsys.com)
Copyright (C) 1995-1998 Russell King
Copyright (C) 2009 Antti Palosaari <crope@iki.fi>
Copyright (C) 2000-2002 Hewlett-Packard (John Marvin)
Copyright (C) 2007 Gabor Juhos <juhosg at openwrt.org>
Copyright (C) 2013 Philipp Zabel, Pengutronix
Copyright (C) 2008-2011 Gabor Juhos <juhosg@openwrt.org>
(c) 1999-2002 Matthew Dharm (mdharm-usb@one-eyed-alien.net);(c) 1999 Michael Gee (michael@linuxspecific.com)
Copyright (C) 2018 Intel Corp.
Copyright (C) 2001 - 2005 Tensilica Inc.
Copyright (c) 2006, 2007, 2008, 2009 QLogic Corporation. All rights reserved.
Copyright (c) 2012 Mellanox Technologies. All rights reserved.
Copyright (C) 1994-1996 Linus Torvalds & authors
Copyright IBM Corp. 2001,2008
Copyright IBM Corporation, 2007 Authors: Chandra Seetharaman <sekharan@us.ibm.com> Mike Anderson <andmike@linux.vnet.ibm.com>
Copyright (c) 2012 Samsung Electronics Co., Ltd. <http://www.samsung.com>
Copyright (C) 1998 Eddie C. Dost (ecd@skynet.be)
Copyright 2008 Red Hat, Inc. All rights reserved.
Copyright (c) 2004,2005 Arnaud Patard
Copyright 2008-2009 VMware, Inc., Palo Alto, CA., USA All Rights Reserved.
Copyright (C) 2004, 2008 Oracle. All rights reserved.
Copyright (C) 2014 Seth Jennings <sjenning@redhat.com>
Copyright (C) 1995 David S. Miller (davem@davemloft.net)
Copyright 2005, 2006 Freescale Semiconductor Inc.
Copyright(c) 2008 - 2010 Realtek Corporation. All rights reserved.
Copyright (C) 1998 Inside Out Networks, Inc.
Copyright (C) 2004-6 Patrick Boettcher (patrick.boettcher@posteo.de)
Copyright (C) 1998 Jakub Jelinek (jj@ultra.linux.cz)
Copyright (C) 2007, 2016 Red Hat, Inc. All Rights Reserved. Written by David Howells (dhowells@redhat.com)
Copyright (C) 2012 LSI
Copyright (C) 2002, Linus Torvalds.
Copyright (C) 2016 Felix Fietkau <nbd@nbd.name>
Copyright (C) 2010 Paul Mundt

LICENCE TERMS (cont.)

Copyright (C) 2012 Hans-Frieder Vogt <hfvogt@gmx.net>
Copyright (c) 2013 by Tobias Hoffmann
"Copyright (C) 2003 Megasolution Inc. <matsu@megasolution.jp>"
Copyright 2009 Freescale Semiconductor, Inc.
Copyright (c) 2019, Vladimir Oltean <olteanv@gmail.com>
Copyright (C) 2010-2013 Bluecherry, LLC <http://www.bluecherrydvr.com>
Copyright (C) 2014 Texas Instruments Incorporated - http://www.ti.com
Copyright (C) 2002, 2003, 2004 Dell Inc. by Matt Domsch <Matt_Domsch@dell.com>
Copyright 2015-2016 Freescale Semiconductor, Inc.
Copyright (C) 2018 PHYTEC Messtechnik GmbH Author: Christian Hemp <c.hemp@phytec.de>
Copyright (C) 2008 Pierrick Hascoet <pierrick.hascoet@abilis.com>
Copyright 2015 Maxime Ripard
Copyright (c) 2018, Mellanox Technologies. All rights reserved.
Copyright (C) 2001 - 2007 Jeff Dike (jdike@{linux.intel,addtoit}.com)
Copyright (C) 2004 Texas Instruments
Copyright (C) 2004-2013 Texas Instruments
Copyright 2014 Realtek Microelectronics Author: Bard Liao <bardliao@realtek.com>
Copyright (C) 2014 Chen-Yu Tsai
Copyright (C) 2012 ST Microelectronics Rajeev Kumar <rajeevkumar.linux@gmail.com>
Copyright (c) 2015 Takashi Sakamoto
Copyright (C) 2015 Imagination Technologies Ltd Author: Qais Yousef <qais.yousef@imgtec.com>
Copyright (c) 2015 Pengutronix, Sascha Hauer <kernel@pengutronix.de>
Copyright (C) 2015 Nikolaus Schaller <hns@goldelico.com>
Copyright 2016 Naveen N. Rao <naveen.n.rao@linux.vnet.ibm.com> IBM Corporation
Copyright (C) 2012-2015 Emulex. All rights reserved. EMULEX and SLI are trademarks of Emulex. www.emulex.com
Copyright 2003 mjander@mjander@users.sourceforge.net
Copyright IBM Corp. 2009, 2017 Author(s): Martin Schwidofsky <schwidofsky@de.ibm.com> Hendrik Brueckner <brueckner@linux.vnet.ibm.com>
Copyright (C) 2017 Tony Lindgren <tony@atomide.com>
Copyright (C) 2016 CNEX Labs Initial release: Javier Gonzalez <javier@cnexlabs.com>
Copyright (C) 2009-2016 Helge Deller <deller@gmx.de>
Copyright (C) 2014 Intel Corporation
Copyright © 2006 Dave Airlie
Copyright 2012 Sony Corporation
Copyright (C) 1995-2009 Russell King
Copyright (c) 2018 Amlogic, Inc. All rights reserved.
(C) 2005, 2006 Red Hat Inc.
Copyright (C) 2000, 2002 Jeff Dike (jdike@karaya.com)
Copyright (C) 2013-2016 Altera Corporation, All Rights Reserved.
Copyright (C) 2006 Scott Alfter <salfter@ssai.us>
Copyright (C) 2005 Sensoria Corp Derived from the unified SMC91x driver by Nicolas Pitre and the smsc911x.c reference driver by SMSC
Copyright (C) Qu Wenruo 2017. All rights reserved.
Copyright (C) 2013 Lothar Waßmann <LW@KARO-electronics.de>
Copyright (C) 2017 Red Hat, Inc. All Rights Reserved. Written by David Howells (dhowells@redhat.com)
Copyright (C) 1995 David A Rusling
Copyright (C) 2014 Texas Instruments Incorporated - http://www.ti.com/ Author: Tomi Valkeinen <tomi.valkeinen@ti.com>
Copyright (c) 2014 Imagination Technologies Ltd. Author: Markos Chandras <markos.chandras@imgtec.com>
Copyright (C) 1992, 1998-2004 Linus Torvalds, Ingo Molnar
Copyright (C) 2013 Texas Instruments Incorporated - http://www.ti.com/
Copyright 2015 Allworx Corp.
Copyright 2008 Juergen Beisert, kernel@pengutronix.de
Copyright NXP 2018
Copyright (c) 2000-2005 Silicon Graphics, Inc. All Rights Reserved.
Copyright 2017 Collabora Ltd.
Copyright(c) 2010 Arnaud Patard <apatard@mandriva.com>

Copyright (c) 1998 - 2002 Frodo Looijaard <frodol@dds.nl>, Philip Edelbrock <phil@netroedge.com>, Kyösti Mälkki <kmalkki@cc.hut.fi>, Mark D. Studebaker <mduxyz123@yahoo.com>
Copyright (C) 2013 Renesas Solutions Corp.
Copyright 2016 David Lechner <david@lechnology.com>
Copyright 2011 Wolfson Microelectronics plc Mark Brown <broonie@opensource.wolfsonmicro.com>
Copyright 2010 Torez Smith, IBM Corporation.
Copyright 1999 Precision Insight, Inc., Cedar Park, Texas.
Copyright (C) 2008-2009 Michal Simek <monstr@monstr.eu>
Copyright (C) 2010,2011 NetUP Inc.
Copyright (C) 2019 Renesas Electronics Corp.
Copyright 2019 Advanced Micro Devices, Inc.
Copyright 2018-2019 Amazon.com, Inc. or its affiliates. All rights reserved.
Copyright (c) 1994-2003 by Jaroslav Kysela <perex@perex.cz>, Abramo Bagnara <abramo@alsa-project.org>
Copyright (C) 2005-2009 Laurent Pinchart (laurent.pinchart@ideasonboard.com)
Copyright 2011 - 2015 Freescale Semiconductor Inc.
Copyright (C) 2003 PathScale, Inc.
Copyright 2000,2001,2002,2003 Broadcom Corporation. All rights reserved.
Copyright (C) 2003-2008 Geert Uytterhoeven
Copyright (C) 2007-2008 Avionic Design Development GmbH
Copyright (c) 2011 The Chromium OS Authors. All rights reserved.
Copyright (C) 2014 Samsung Electronics, Co., Ltd. Author: Beomho Seo <beomho.seo@samsung.com>
Copyright (c) 2007 Intel Corporation
"Copyright (C) 2018 ARM Ltd.:(c) container_of(c, struct scmi_chan_info, cl) define handle_to_scmi_info(h) container_of(h, struct scmi_info, handle)"
Copyright (C) 2011 Samsung Electronics
Copyright (C) 1998-2008 Novell/SUSE
copyright (C) ST-Ericsson AB 2010 Author: Sjur Brandeland/ sjur.brandeland@stericsson.com
Copyright (C) 1995-1996 Gary Thomas (gdt@linuxppc.org)
Copyright (c) 2015-2016 Quantenna Communications, Inc. All rights reserved.
Copyright (C) 2005 Intel Corporation
Copyright (C) 1997-2002 Russell King Modified for ARMv7 by Catalin Marinas
Copyright 2012 Paul Mackerras, IBM Corp. <paulus@au1.ibm.com>
Copyright (c) 2005 Martin Langer <martin-langer@gmx.de>,
Copyright 1997 Andi Kleen <ak@muc.de>
Copyright (c) 2016 MediaTek Inc. Author: Mars.C <mars.cheng@mediatek.com>
Copyright (C) 1992 Rick Sladkey
Copyright 2016 Analog Devices Inc.
Copyright (C) 2002 Motorola GSG-China
Copyright (C) 2004 Sylvain Munaut <tnt@246tNt.com>
Copyright IBM Corp. 2016
Copyright (C) 2015 Marek Vasut <marex@denx.de>
Copyright (C) 2003-2006, Advanced Micro Devices, Inc.
Copyright (C) 2017 NXP
Copyright 2016 Broadcom
Copyright (C) 2005 Red Hat, Inc. All Rights Reserved. Written by David Howells (dhowells@redhat.com)
Copyright (C) 2010 Samsung Electronics
Copyright (C) 2016 Atmel
Copyright (c) 2011 Jonathan Cameron
Copyright (c) 2014 Samsung Electronics Co., Ltd. Author: Rahul Sharma <rahul.sharma@samsung.com>
Copyright (c) 2016 ARM Ltd.
Copyright (c) 2010-2011, Code Aurora Forum. All rights reserved.
Copyright (c) 2014 Mauro Carvalho Chehab <mchehab@samsung.com>
(c) Copyright 2006 Benjamin Herrenschmidt, IBM Corp. benh@kernel.crashing.org>
Copyright (C) 2013-2014 Freescale Semiconductor, Inc.
Copyright (c) 2010,2015, The Linux Foundation. All rights reserved.
(C) Copyright 2013 - 2014 Xilinx, Inc.:(C) Copyright 2011 (Alejandro Cabrera <aldaya@gmail.com>)
Copyright (c) 2014-2018, NVIDIA CORPORATION. All rights reserved.

LICENCE TERMS (cont.)

Copyright (C) 2017 Sanechips Technology Co., Ltd.
Copyright 2010 Advanced Micro Devices, Inc.
Copyright 2008 Openmoko, Inc.
Copyright (C) 2015-2017 Josh Poimboeuf <jpoimboe@redhat.com>
Copyright (c) 2016,2017 Facebook
Copyright (c) 2001-2007, 2013-2014, Ericsson AB
Copyright (C) 2007 Alan Stern
Copyright (C) Matt Helsley, IBM Corp. 2005 Based on cn_fork.h by Nguyen Anh Quynh and Guillaume Thouvenin
Copyright (C) 2008, 2010 Davide Rizzo <elpa.rizzo@gmail.com>
Copyright (C) 2006, 2007 David S. Miller (davem@davemloft.net)
Copyright (C) 2008, Guennadi Liakhovetski, DENX Software Engineering <lg@denx.de>
(c) Gerd Hoffmann <kraxel@redhat.com>
Copyright (C) 2017 Linaro Ltd. Author: Ard Biesheuvel <ard.biesheuvel@linaro.org>
Copyright © 2010 Intel Corporation
Copyright (c) 2010-2019, NVIDIA Corporation.
Copyright 2018 Google LLC.
Copyright (c) 2016 Icenowy Zheng <icenowy@aosc.xyz>
Copyright (C) 1994 Linus Torvalds
Copyright IBM Corp. 2008 Author(s): Peter Oberparleiter <peter.oberparleiter@de.ibm.com>
Copyright (C) 2014, Spreadtrum Communications Inc.
Copyright (C) 2015-2018 Etnaviv Project
Copyright 2010 (C) Texas Instruments, Inc. http://www.ti.com/
Copyright (C) 2005 Rusty Russell, IBM Corporation
Copyright 2012 Freescale Semiconductor Inc.
Copyright (C) 2012 NVIDIA Corporation
Copyright (C) 2013 Jonas Gorski <jogo@openwrt.org>
Copyright (C) 2015 Kozhevnikov Anatoly
Copyright (C) 1991, 1992, 1993, 1994 Linus Torvalds
Copyright (c) 2015 Kontron Author: Vadim V. Vlasov <vvlasov@dev.rtsoft.ru>
Copyright 2013 Tomasz Figa <tomasz.figa@gmail.com>
Copyright (C) 2002, 2003, 2005, 2006 Maciej W. Rozycki
Copyright (c) 2007 Andi Kleen (ak@suse.de)
Copyright IBM Corporation 1999, 2009
Copyright(C) 2011 STMicroelectronics Ltd
Copyright (C) 2013 Texas Instruments
Copyright (C) Jonathan Naylor G4KLX (g4klx@g4klx.demon.co.uk)
Copyright (C) 1994, 1995, 1996, 1999 Ralf Baechle
Copyright (C) 2013-2015 Alexander Popov <alex.popov@linux.com>.
Copyright (C) 2012 Linus Walleij
Copyright (c) 2011 Samsung Electronics, Co. Ltd Contact: Tomasz Stanislawski <t.stanislaw@samsung.com>
Copyright 2016 Red Hat Inc.
Copyright (C) 2013 Intel Corporation. All rights reserved.
Copyright (C) 2004 IBM Corporation
Copyright (c) 2019, Linaro Ltd
Copyright 2012 Armadeus Systems - <support@armadeus.com>
Copyright (C) 2016, 2017, 2018 Sony Semiconductor Solutions Corporation
Copyright (C) 2008, 2009 Renesas Solutions Corp. Kuninori Morimoto <morimoto.kuninori@renesas.com>
Copyright © 2005 Sean Young <sean@mess.org>
Copyright (C) 2012 Texas Instruments.
Copyright (c) 2000,2002,2005 Silicon Graphics, Inc. All Rights Reserved.
Copyright (C) 1995 David S. Miller (davem@caip.rutgers.edu)
Copyright (C) 2010 NXP Semiconductors
Copyright 2007 Michael Wu <flamingice@sourmilk.net>
Copyright (C) 2018 ARM Ltd. Sudeep Holla <sudeep.holla@arm.com>
Copyright (c) 2017-19 Cumulus Networks
Copyright (C) 1998-2008 Krzysztof Halasa <khc@pm.waw.pl>
(C) Copyright Linaro 2013v2
(c) 2009 Daniel Mack <daniel@caiaq.de>
Copyright (C) 2000 MIPS Technologies, Inc. All rights reserved. Author: Carsten Langgaard, carstenl@mips.com
Copyright (C) 2003 Kirk Reiser.
Copyright (C) 2013 Altera Corporation
Copyright 2014 Freescale Semiconductor Inc.
Copyright (C) 2017 ARM Ltd.
Copyright (C) 2011 Weinmann Medical GmbH Author: Nikolaus Voss <n.voss@weinmann.de>
(C) Copyright 1995 1996 Linus Torvalds
Copyright (C) 2002-2003 David McCullough <davidm@snapgear.com>
Copyright (C) 2007-2019 B.A.T.M.A.N. contributors:
Copyright (c) 2018 MediaTek Inc.
Copyright 1995-1996 by Mylex Corporation. All Rights Reserved
Copyright (C) 2002 Atom Create Engineering Co., Ltd.
Copyright (C) 1998, 1999, 2001 Hewlett-Packard Co Stephane Eranian <eranian@hpl.hp.com>
Copyright (c) 2015-2018 Mathieu Desnoyers <mathieu.desnoyers@efficios.com>
Copyright (C) 2011, Thomas Gleixner
Copyright (C) 1999 ARM Limited
Copyright 2017 Karol Herbst
Copyright (C) 2009-2010 Laurent Pinchart (laurent.pinchart@ideasonboard.com)
Copyright 2019 Google LLC
Copyright (C) 1999 Niibe Yutaka
Copyright 2008-2012 Freescale Semiconductor, Inc.
Copyright 2017 Peter Meerwald-Stadler <pmeerw@pmeerw.net>
Copyright (C) 1996, 1999, 2007 David S. Miller (davem@davemloft.net)
Copyright (C) 2012 Regents of the University of California
Copyright (C) 2011-2013 Jonas Gorski <jogo@openwrt.org>
Copyright (C) 2004 Benjamin Herrenschmidt, IBM Corp.
Copyright (C) 2017-2018 Netronome Systems, Inc. */
Copyright (c) 2014 Tomasz Figa <tomasz.figa@gmail.com>
Copyright (C) 2007 Google, Inc. Author: Robert Love <rlove@google.com>
Copyright (c) 2015-2018, The Linux Foundation. All rights reserved.
Copyright (C) 2006-2017 Oracle Corporation */
Copyright (C) 2001 - 2010 Tensilica Inc.
Copyright (C) Nokia Corporation
Copyright 2014 Google Chromium project. Author: Anatol Pomozov <anatol@chromium.org>
Copyright (C) 1998 Frederic Rible F1OAT (frible@teaser.fr) Adapted from baycom.c driver written by Thomas Sailer (sailer@ife.ee.ethz.ch)
Copyright (C) 2016 Red Hat Author: Rob Clark <robdclark@gmail.com>
Copyright (C) 2004-2005 Trusted Computer Solutions, Inc.
Copyright (C) IBM Corporation 2016.
Copyright (C) 2001 Dan Malek (dmalek@jlc.net)
Copyright 2013-2015 Analog Devices Inc. Author: Lars-Peter Clausen <lars@metafoo.de>
Copyright (C) 2011 Marvell International Ltd.
Copyright (C) 2014-2017 aQuantia Corporation. All rights reserved
Copyright (C) 2012 Marvell International Ltd. Haojian Zhuang <haojian.zhuang@marvell.com> Joseph(Yossi) Hanin <yhanin@marvell.com> Qiao Zhou <zhouqiao@marvell.com>
Copyright (C) 2011 NetUP Inc. All rights reserved.
Copyright (C) 1996 David S. Miller (dm@sgi.com) Compatibility with board caches, Ulf Carlsson
Copyright (c) 1998-2007 Texas Instruments Incorporated
(c) Marvell International Ltd.
Copyright (C) 2016 Markus Heiser
"Copyright (C) 2005 Chuck Lever <cel@netapp.com>"
Copyright (c) 2007-2008 MontaVista Software, Inc.
Copyright (C) 2012-2015 Synaptics Incorporated. All rights reserved.
Copyright (c) 2015-2017 Qualcomm Atheros, Inc.
Copyright (c) 2009-2010 Chelsio Communications, Inc. All rights reserved.
Copyright (C) 2014 Texas Instruments Incorporated. http://www.ti.com/

LICENCE TERMS (cont.)

Copyright (c) 2008 Marvell Semiconductor
Copyright (c) 2010-2011,2013-2015 The Linux Foundation. All rights reserved.
(C) Copyright IBM Corp. 2013
Copyright (C) 2007 FUJITA Tomonori <tomof@acm.org>
Copyright (C) 2018 Mellanox Technologies.
Copyright (c) 2002 by Takashi Iwai <tiwai@suse.de>
Copyright (C) 1997 by Paul M. Antoine. reworked 1998 by Harald Koerfgen.
Copyright: (C) 2010-2012 Nicolas Palix.
Copyright (c) 2018, Intel Corporation.
Copyright (C) 2012 Alexander Shiyan <shc_work@mail.ru>
Copyright (C) STMicroelectronics 2016 Author: Benjamin Gaignard <benjamin.gaignard@st.com>
Copyright 2009 by Karsten Keil <keil@isdn4linux.de>
Copyright (c) 2014 MediaTek Inc. Author: Hongzhou.Yang <hongzhou.yang@mediatek.com>
Copyright (C) 2004, 2009, 2010 Texas Instruments Incorporated Author: Aurelien Jacquot (aurelien.jacquot@jaluna.com) Rewritten for 2.6.3x: Mark Salter <msalter@redhat.com>
Copyright © 2006 NEC Corporation
Copyright (C) 2013 Broadcom Corporation
Copyright IBM Corp. 2007
Copyright (C) 1999-2000 by Massimo Piccioni <dafastidio@libero.it>
Copyright 2000, 2008 MontaVista Software Inc. Author: MontaVista Software, Inc. <source@mvista.com>
Copyright (c) 2016 Broadcom
Copyright (C) 2003 Maciej W. Rozycki
Copyright (c) 1999 Andreas Gal
Copyright IBM Corp. 2012
Copyright (C) 2004, 2009, 2011 Texas Instruments Incorporated Author: Aurelien Jacquot (aurelien.jacquot@jaluna.com)
Copyright (C) 2011, Bastian Hecht <hechtb@gmail.com>
Copyright (C) 2010 Texas Instruments Inc
Copyright 2015 Nouveau Project
Copyright (c) 2006 Jing Min Zhao <zhaojingmin@users.sourceforge.net>
Copyright (c) 2018 Nuvoton Technology tomer.maimon@nuvoton.com
Copyright (C) 2006 Sony Computer Entertainment Inc.
Copyright (c) 2009 Manuel Lauss.
Copyright (C) 1994, 1996, 1997, 1998, 2001 Free Software Foundation, Inc.
Copyright (c) 2009-2011 Samsung Electronics Co., Ltd. http://www.samsung.com/
Copyright 2012-2014 Imagination Technologies Ltd.
Copyright 2014 Hans de Goede <hdegoede@redhat.com>
Copyright (c) 2012-2015, The Linux Foundation. All rights reserved.
Copyright 2007 Benjamin Herrenschmidt, IBM Corp. benh@kernel.crashing.org>
Copyright (C) 2017 Willy Tarreau <w@1wt.eu>
Copyright (C) 1994-2000 Algorithmics Ltd.
Copyright (c) International Business Machines Corp., 2002,2004 Author(s): Steve French (sfrench@us.ibm.com)
Copyright (C) 2009, Marvell International Ltd.
Copyright (C) 2017 Cadence Design Systems, Inc.
Copyright (c) 2013 Heiko Stuebner <heiko@sntech.de>
Copyright 2007-8 Advanced Micro Devices, Inc.
Copyright (c) 2006, 2007, 2008, 2009, 2010 QLogic Corporation. All rights reserved.
(C) 1996 Miguel de Icaza
Copyright (C) 2010-2011 Texas Instruments Incorporated - http://www.ti.com
Copyright (c) 2017, Intel Corporation.
Copyright IBM Corp. 1999, 2009
Copyright (C) 2009 Theodore Ts'o (tytso@mit.edu)
Copyright © 2012 Intel Corporation
Copyright (C) 2018 Linaro Limited Author: AKASHI Takahiro <takahiro.akashi@linaro.org>
Copyright (C) 2005-2014 Nippon Telegraph and Telephone Corporation.
Copyright (C) 2008 Sensoray Company Inc.
Copyright (C) IBM Corporation, 2004

Copyright (C) 2012 Google, Inc. Author: Benson Leung <bleung@chromium.org>
(c) 1999, 2000 Matthew Dharm (mdharm-usb@one-eyed-alien.net)
Copyright (C) 2007 Paul Mundt
Copyright 1992 by Greg Harp
Copyright (C) 2015 Rabeeh Khoury <rabeeh@solid-run.com> Based on work by Russell King
Copyright (c) 2006-2007 Simtec Electronics http://armlinux.simtec.co.uk/ Ben Dooks <ben@simtec.co.uk> Vincent Sanders <vince@arm.linux.org.uk>
Copyright (C) 2012 Tony Prisk <linux@prisktech.co.nz>
Copyright 2004 Interface Co.,Ltd. Saito.K
Copyright (c) 2018 Jernej Skrabec <jernej.skrabec@siol.net>
Copyright (C) 2019 BayLibre, SAS Author: Neil Armstrong <narmstrong@baylibre.com>
Copyright (C) 2014 Red Hat Inc.
Copyright (c) 2009-2013 Silicon Graphics, Inc. All Rights Reserved.
Copyright (C) 2012-14 Intel Corporation Author: Jeeja KP <jeeja.kp@intel.com> Omair Mohammed Abdullah <omair.m.abdullah@intel.com> Vinod Koul ,vinod.koul@intel.com>
Copyright (C) 2009 Wind River Systems, written by Ralf Baechle <ralf@linux-mips.org>
Copyright (c) 2010 by Mauro Carvalho Chehab
(c) Copyright 2001 Red Hat Inc.
Copyright (C) 2017-2018 SUSE
Copyright (c) 2019, Google Inc. Author - Rajat Jain
Copyright 2016 Intel Corp.
(c) MontaVista Software, Inc.:(C) Copyright TOSHIBA CORPORATION 2000-2001, 2004-2007
Copyright (c) 2004 by Digigram <alsa@digigram.com>
Copyright (C) 2016-2018 T-Platforms JSC All Rights Reserved.
Copyright (C) 1995 - 1997, 1999 Silcon Graphics, Inc.
Copyright (c) 2015 MediaTek Inc. Author: James Liao <jamesjliao@mediatek.com>
Copyright (c) 2016 Facebook
Copyright 2008 Advanced Micro Devices, Inc.
Copyright (C) 2001-2003 Andreas Gruenbacher <agruen@suse.de>
"Copyright (C) ST-Ericsson AB 2010 Author: Sjur Brendeland"
Copyright 2000,2001 Dell Inc.
Copyright (C) 2006 Christoph Pfister (christophpfister@gmail.com)
Copyright (c) 1996, 1998, 1999, 2004 by Ralf Baechle
Copyright (c) 2003-2016 Cavium, Inc.
Copyright © 2006-2011 Intel Corporation
Copyright (c) Evgeniy Polyakov <johnpol@2ka.mipt.ru> All rights reserved.
Copyright (C) 2015 - ARM Ltd Author: Marc Zyngier <marc.zyngier@arm.com>
Copyright 2007 Freescale Semiconductor Inc.
Copyright (C) 2012-2014 Broadcom Corporation
Copyright (C) 2014 Fraunhofer ITWM
Copyright (C) 2009-2010 Nokia Corporation
Copyright (C) 2019 Intel Corporation
Copyright (C) 2010 Johan Hovold <jhovold@gmail.com>
Copyright (c) 2001-2013 ATTO Technology, Inc. mailto:linuxdrivers@attotech.com)
Copyright (C) 2000, 2001 Jeff Dike (jdike@karaya.com)
Copyright(c) 2009-2013 Realtek Corporation.
Copyright (C) 2010 Nokia Corporation. Author: Mika Westerberg
Copyright (C) 2009-2012 Siemens AG
Copyright 2008-2011 Freescale Semiconductor, Inc.
Copyright(c) 2009 Intel Corporation. All rights reserved.
Copyright (C) 1999 Niibe Yutaka But consider these trivial functions to be public domain.
Copyright (C) 1997, 2008 David S. Miller (davem@davemloft.net)
Copyright (C) 2006, 2007 Christopher Pascoe <c.pascoe@itee.uq.edu.au>
Copyright 2018 Advanced Micro Devices, Inc. All Rights Reserved.
Copyright © 2013 Tony Breeds IBM Corporation
Copyright (C) 2004 SAN People
Copyright (C) 2006-2008 Nokia Corporation

LICENCE TERMS (cont.)

Copyright (C) 2014 Texas Instruments, Inc.
Copyright (c) 2017 Martin Blumenstingl <martin.blumenstingl@googlemail.com>.
Copyright (C) 2017 Icenoway Zheng <icenoway@aosc.io>
Copyright (C) 2013 Advanced Micro Devices, Inc.
Copyright (C) 2011 Freescale Semiconductor, Inc. All Rights Reserved.
Copyright © 2006-2009, Intel Corporation.
Copyright (C) STMicroelectronics SA 2015 Authors: Yannick Ferte <yannick.ferte@st.com> Hugues Fruchet <hugues.fruchet@st.com>
Copyright (C) 2014, Intel Corporation All rights reserved.
(C) 2006-2008 by Openmoko, Inc. Author: Harald Welte <laforge@openmoko.org> Balaji Rao <balajirao@openmoko.org> All rights reserved.
Copyright (C) 2009 Nokia Corporation Author: Tomi Valkeinen <tomi.valkeinen@ti.com>
Copyright 2013-2016 Freescale Semiconductor Inc.
Copyright (c) 2007 Simtec Electronics Ben Dooks, <ben@simtec.co.uk>
Copyright(c) 2011 Dialog Semiconductor Ltd.
Copyright (C) 2003 Frank Mori Hess <fmhess@users.sourceforge.net>
Copyright (c) 2002, 2003, 2004, 2005, 2006, 2007, 2008 Phillip Lougher <phillip@squashfs.org.uk>
Copyright (C) 1991, 1992, 1995 Linus Torvalds
Copyright (c) 2016 Fuzhou Rockchip Electronics Co., Ltd
Copyright 2018 NXP Dong Aisheng <aisheng.dong@nxp.com>
Copyright 2013 Maxime Ripard
Copyright (C) 2014 Seong-Woo Kim
Copyright (c) 2013, Sony Mobile Communications AB.
Copyright (C) 2012 Mentor Graphics Inc.
Copyright 2016 Anju T, IBM Corporation.
Copyright 2015 Advanced Micro Devices, Inc.
Copyright 2019-2020 NXP
Copyright (C) 2013,2014 Linaro Limited Roy Franz <roy.franz@linaro.org>
Copyright (C) 2005 Mike Isely <isely@pobox.com>
Copyright (c) 1998, 1999 Frodo Looijaard <frodol@dds.nl>
Copyright (c) 2008 Simtec Electronics http://armlinux.simtec.co.uk/ Ben Dooks <ben@simtec.co.uk>, <ben-linux@fluff.org>
Copyright (C) 2012 Sven Schnelle <svens@stackframe.org>
Copyright (C) 2005, 2006 IBM Corporation
Copyright (C) IBM Corporation, 2011-2015
Copyright (C) 2018 SolidRun Ltd. Based on Marvell MACCHIATOBin board
Copyright (C) 2003 Sistina Software Limited.
Copyright (C) 2017 Hamster Tian <haotia@gmail.com>
Copyright (C) 2019 Netronome Systems, Inc.
Copyright (C) 1999 Eric A. Thomas.
Copyright (C) 2012 VMware, Inc. All rights reserved.
Copyright (c) 2014 Redpine Signals Inc.
Copyright (C) 2006 Red Hat, Inc. All Rights Reserved. Written by David Howells (dhowells@redhat.com)
Copyright (C) 2008 Red Hat. All rights reserved.
Copyright 2014-2017 Toradex AG
Copyright (c) 2004 Takashi Iwai <tiwai@suse.de>
Copyright (c) 2003-2014 Broadcom Corporation All Rights Reserved
Copyright (C) 2010 Texas Instruments.
Copyright (C) 2014 Free Electrons
Copyright 2012-2015 VMware, Inc.
Copyright 2012 Texas Instruments
Copyright (C) 2013-2015 Freescale Semiconductor, Inc. All Rights Reserved.
Copyright (C) 2011-2013 Samsung India Software Operations
Copyright (C) 2017 Eric Nelson
Copyright (c) 2011, NVIDIA Corporation.
Copyright (C) 2008, Creative Technology Ltd. All Rights Reserved.
Copyright (C) 1999 Nicolas Pitre <nico@fluxnic.net>
Copyright (C) 2007 Krzysztof Helt <krzysztof.h1@wp.pl> Based on 2.4 driver by Frodo Looijaard <frodol@dds.nl> and Philip Edelbrock <phil@netroedge.com>
Copyright (C) 2009-2010 Texas Instruments Author: Pavan Savoy <pavan_savoy@ti.com>
Copyright (c) 2002 Pavel Machek <pavel@ucw.cz>
(c) 1999-2002 Matthew Dharm (mdharm-usb@one-eyed-alien.net);(c) 2000 David L. Brown, Jr. (usb-storage@davidb.org);(c) 2000 Stephen J. Gowdy (SGowdy@lbl.gov);(c) 1999 Michael Gee (michael@linuxspecific.com)
Copyright (C) 2014 Marvell
Copyright (C) 2012-2018 Texas Instruments Incorporated - http://www.ti.com/ Vaibhav Bedia, Dave Gerlach
Copyright (C) 2013 Jozsef Kadlecik <kadlec@netfilter.org>
Copyright (C) 2014 Beniamino Galvani <b.galvani@gmail.com>
Copyright (c) 2011-2014 Samsung Electronics Co., Ltd http://www.samsung.com
Copyright 2017 Analog Devices Inc. Author: Lars-Peter Clausen <lars@metafoo.de>
Copyright(c) 2017 Huawei Technologies Co., Ltd
Copyright (c) 2016 Shuah Khan <shuahkh@osg.samsung.com>
Copyright (C) 2016 Spencer E. Olson <olsonse@umich.edu> based of parts of drivers/of/unittest.c
Copyright (c) 2011 Cambridge Silicon Radio Limited, a CSR plc group company.
Copyright © 2007 David Woodhouse <dwmw2@infradead.org>
Copyright 2002 MontaVista Software
Copyright (C) 2000, 2001, 2002 Broadcom Corporation
Copyright (C) 2013 Red Hat, Inc. All Rights Reserved. Written by David Howells (dhowells@redhat.com)
Copyright (c) 2004-2008 Silicon Graphics, Inc. All Rights Reserved.
Copyright (C) 2008 Erik Andrén
Copyright (C) 2009 Secret Lab Technologies Ltd.
Copyright (C) 2012 Atmel, 2012 Nicolas Ferre <nicolas.ferre@atmel.com>
Copyright (C) 2009 Lemote, Inc. Author: Wu Zhangjin <wuzhangjin@gmail.com>
Copyright (C) 2016 Maxime Ripard Maxime Ripard <maxime.ripard@free-electrons.com>
Copyright (C) 2013-2017 Matthias Schwarzott <zzam@gentoo.org>
Copyright (C) 2005-2010 Laurent Pinchart (laurent.pinchart@ideasonboard.com)
Copyright (C) 2006,2007 Nobuhiro Iwamatsu
Copyright (c) 2008 Intel Corporation
Copyright 2014-2016 Freescale Semiconductor Inc.
Copyright (c) 2002-2005 Sam Leffler, Errno Consulting
Copyright (c) 2014-2015 Andrew Lutomirski
Copyright (C) 2012 Marvell Technology Ltd. Yunfan Zhang <yfzhang@marvell.com>
Copyright (C) 2013 Enrico Mioso <mrkiko.rs@gmail.com>
Copyright (C) 2015-2016 Synopsys, Inc. (www.synopsys.com)
Copyright (c) 1999 The Puffin Group
Copyright (C) 2012 Red Hat Inc, Steven Rostedt <ststedt@redhat.com>
Copyright(c) 2015 Intel Corporation. This program is free software
Copyright IBM Corp. 2007 Author(s): Utz Bacher <utz.bacher@de.ibm.com>, Frank Pavlic <fpavlic@de.ibm.com>, Thomas Spatzier <tspat@de.ibm.com>, Frank Blaschka <frank.blaschka@de.ibm.com>
Copyright (c) by Uros Bizjak <uros@kss-loka.si>
Copyright (C) 2018 Intel Corporation Author: Heikki Krogerus <heikki.krogerus@linux.intel.com> Hans de Goede <hdegoede@redhat.com>
Copyright (C) 1999, 2000, 2002 Niibe Yutaka
Copyright (C) 2006 Lennert Buytenhek <buytenh@wantstofly.org>
Copyright (C) 2009 Francisco Jerez. All Rights Reserved.
Copyright (C) 2008 Robert Jarzmik
Copyright (c) 2013-2019 David Ahern <dsahern@gmail.com>. All rights reserved.
Copyright (C) 2009-2010 Laurent Pinchart <laurent.pinchart@ideasonboard.com>
Copyright (C) 2016 Texas Instruments Incorporated - http://www.ti.com/ Author: Tomi Valkeinen <tomi.valkeinen@ti.com>
Copyright (C) 2005-2017 Andes Technology Corporation
Copyright (c) 2013-2015, Linux Foundation. All rights reserved.
Copyright IBM 2015
Copyright (c) 2011 Rafał Milecki <zajec5@gmail.com>
Copyright (C) 2013-2014 Renesas Electronics Corporation

LICENCE TERMS (cont.)

Copyright 2017-2019 NXP
Copyright (c) 2014-2015, The Linux Foundation. All rights reserved.
Copyright (C) 2018 William Breathitt Gray
Copyright (c) by Lee Revell <lrrevell@joe-job.com> Clemens Ladisch <clemens@ladisch.de> Routines for control of EMU10K1 chips
Copyright (c) Microsoft Corporation
Copyright (C) 2009 Mauro Carvalho Chehab
Copyright (c) 2003 Patrick Mochel
Copyright (C) 2003 Anton Blanchard <anton@au.ibm.com>, IBM
Copyright (C) 2001 - 2007 Jeff Dike (jdike@{addtoit,linux.intel}.com)
Copyright (c) 2011-2016 Synaptics Incorporated
Copyright (C) 1992, 1993, 1994, 1995 Remy Card (card@masi.ibp.fr) Laboratoire MASI - Institut Blaise Pascal Universite Pierre et Marie Curie (Paris VI)
Copyright 2018-2019 NXP.
Copyright (c) by Jaroslav Kysela <perex@perex.cz> Creative Labs, Inc. Routines for effect processor FX8010
Copyright(c) 2015-2018 Intel Corporation.
Copyright (c) 2018 Collabora Ltd.
Copyright (c) by Jaroslav Kysela <perex@perex.cz> Routines for control of MPU-401 in UART mode
Copyright (C) 2013 Texas Instruments Author: Tomi Valkeinen <tomi.valkeinen@ti.com>
Copyright (c) 2016 Oracle. All Rights Reserved.
Copyright (C) 2007 Red Hat. All rights reserved.
Copyright 2003-2005 Simtec Electronics Ben Dooks <ben@simtec.co.uk>
Copyright 2009 Red Hat Inc.
Copyright (C) 2013 Boris BREZILLON <b.brezillon@overkiz.com>
(c) 2010 Arnaldo Carvalho de Melo <acme@redhat.com>
Copyright (c) 2002 Vojtech Pavlik
Copyright (c) 2012-2013, NVIDIA Corporation.
Copyright (C) 2014 Marvell Chao Xie <chao.xie@marvell.com>
Copyright (C) 2013 MEN Mikroelektronik GmbH (www.men.de) Author: Johannes Thumshirn <johannes.thumshirn@men.de>
Copyright (C) 2005-2008 Nippon Telegraph and Telephone Corporation.
Copyright (C) 1997-2005 Russell King
Copyright (C) 2004-2010 Markus Grabner (grabner@icg.tugraz.at)
Copyright (C) 1995-97 Simon G. Vogl
Copyright (c) 2008 Patrick McHardy <kaber@trash.net>
Copyright (C) 1998 Kirk Reiser.
Copyright (C) 2015-2017 Netronome Systems, Inc.
Copyright (C) 2017 Andes Technology Corporation
Copyright (C) 2009 Samsung Electronics Co.Ltd Author: Joonyoung Shim <jy0922.shim@samsung.com>
Copyright (C) 2012 Vista Silicon S.L. Javier Martin, <javier.martin@vista-silicon.com> Xavier Duret
Copyright © 2014 Broadcom
Copyright(c) 2016 Broadcom. All rights reserved.
Copyright (C) 2002-2003 Hewlett-Packard Co David Mosberger-Tang <davidm@hpl.hp.com>
Copyright (C) 2008 Ben Skeggs. All Rights Reserved.
Copyright IBM Corp. 2000, 2009 Author(s): Utz Bacher <utz.bacher@de.ibm.com> Jan Glauber <jang@linux.vnet.ibm.com>
Copyright (C) 2002-2005 MontaVista Software, Inc.
Copyright (c) 1998 - 2002 Frodo Looijaard <frodol@dds.nl>, Kyösti Mälkki <kmalkki@cc.hut.fi>, Mark Studebaker <mduxyz123@yahoo.com>, and Bob Dougherty <bobd@stanford.edu>
Copyright (C) International Business Machines Corp., 2002, 2011 Etersoft, 2012 Author(s): Steve French (sfrench@us.ibm.com) Jeremy Allison (jra@samba.org) Pavel Shilovsky (pshilovsky@samba.org) 2012
Copyright (c) 2000-2005 Silicon Graphics, Inc.
Copyright 2018 SUSE Linux. Author: Coly Li <colyli@suse.de>
Copyright (C) 1999 Niibe Yutaka & Kaz Kojima
Copyright (C) 2010 Guennadi Liakhovetski <g.liakhovetski@gmx.de>
Copyright (C) 2018 Intel Corporation
Copyright (c) 2015-2016 Qualcomm Atheros, Inc.

Copyright (C) 1995 Linus Torvalds Adapted from 'alpha' version by Gary Thomas Modified by Cort Dougan (cort@cs.nmt.edu) Modified by PPC64 Team, IBM Corp Modified by Cell Team, IBM Deutschland Entwicklung GmbH
Copyright (C) 1997 Jakub Jelinek <jj@sunsite.mff.cuni.cz>
Copyright (C) 2006-2008 Barco N.V. Derived from the Cypress cy7c67200/300 ezusb linux driver and based on multiple host controller drivers inside the linux kernel.
Copyright (c) 2013 Samsung Electronics Co., Ltd.
Copyright (c) 2017 Eva Rachel Retuya <eraretuya@gmail.com>
Copyright (C) 2013 - 2015 Fujitsu Semiconductor, Ltd Vincent Yang <vincent.yang@tw.fujitsu.com>
Copyright (c) 2014 Samsung Electronics Co., Ltd
Copyright (c) 2013 Coraid, Inc. See COPYING for GPL terms.
Copyright (C) 2015 Broadcom Corporation
Copyright 2005 Tensilica Inc.
Copyright (C) 2016 Facebook
Copyright (C) 1997, 2001 Ralf Baechle (ralf@gnu.org), derived from r4xx0.c by David S. Miller (davem@davemloft.net).
Copyright (c) 2015 Imagination Technologies Author: Paul Burton <paul.burton@mips.com>
Copyright (C) 05/1998 Peter Maydell <pmaydell@chiark.greenend.org.uk>
Copyright (c) 2014 Christoph Hellwig.
Copyright (C) 2001,2002,2003 Broadcom Corporation
Copyright (C) 2017 Advanced Micro Devices, Inc.
Copyright (C) 2015-2018 Netronome Systems, Inc.
Copyright (C) International Business Machines Corp., 2006 Authors: Artem Bityutskiy (Битюцкий Артём) Thomas Gleixner Frank Haverkamp Oliver Lohmann Andreas Arnez
Copyright (c) by Christian Fischbach <fishbach@pool.informatik.rwth-aachen.de>
Copyright (C) 2006-2008 PA Semi, Inc
Copyright (C) 2017 Google, Inc
Copyright (C) 2007 by Bjorge Dijkstra <bjd@jooz.net>
Copyright (C) 1993, 1994 by Hamish Macdonald
Copyright (c) 2005 Linas Vepstas <linas@linas.org>
Copyright (C) 2014 Freescale Semiconductor, Inc.
(C) 2009 Sascha Hauer, Pengutronix;(C) 2009 Uwe Kleine-Koenig, Pengutronix
Copyright (c) 2016 MediaTek Inc. Author: Chen Zhong <chen.zhong@mediatek.com>
"Copyright (C) 1997-1998 Mark Lord <mlord@pobox.com>"
Copyright (C) 2009 Guennadi Liakhovetski, DENX Software Engineering, <lg@denx.de>
Copyright (C) 2012 ARM Ltd.
Copyright (c) 2009 Takashi Iwai <tiwai@suse.de>
Copyright (C) 2018 BayLibre SAS Author: Bartosz Golaszewski <bgolaszewski@baylibre.com>
Copyright (C) 2011 Pengutronix, Sascha Hauer
Copyright IBM Corporation, 2007 Author Balbir Singh <balbir@linux.vnet.ibm.com>
Copyright (C) 2004, 2005 Winbond Electronics Corp. Shane Huang, Rudolf Marek <r.marek@assembler.cz>
Copyright (C) 2017 Willy Tarreau <w@1wt.eu> Partially based on Atsushi Nemoto's ledtrig-heartbeat.c.
Copyright (c) 2014 MediaTek Inc. Author: Jie Qiu <jie.qiu@mediatek.com>
Copyright (C) 1998 David A. Schleef <ds@schleef.org> Janne Jalkanen <jalkanen@cs.hut.fi> Eric Bunn <ebu@cs.hut.fi>
Copyright (C) 1996 Dave Frascione [chaos@mindspring.com] Cloned from Richard Hirst [richard@sleepie.demon.co.uk]
Copyright (C) 2002 Shane Nay (shane@minirl.com)
Copyright (C) 2016 Glider bvba
(C) Copyright 2000, Lineo (www.lineo.com);(C) Copyright 1999, Moreton Bay Ventures Pty Ltd.
Copyright 2011 Wolfson Microelectronics PLC. Author: Mark Brown <broonie@opensource.wolfsonmicro.com>
Copyright (C) 2013 Jean-Christophe PLAGNIOL-VILLARD <plagnioj@jcrosoft.com>
Copyright (C) 2019 NVIDIA Corporation
Copyright (C) 2017 Chelsio Communications. All rights reserved.
Copyright (C) 2013-2018 Toradex AG <stefan.agner@toradex.com>
Copyright (C) 2005-7 DiBcom (http://www.dibcom.fr)
Copyright (C) 2007 Xilinx, Inc. All rights reserved.
Copyright (C) 2011, 2012 Nobuhiro Iwamatsu <nobuhiro.iwamatsu.yj@renesas.com>

LICENCE TERMS (cont.)

Copyright (C) 2016, Hisilicon Ltd.
Copyright (C) 2017 Jason A. Donenfeld <Jason@zx2c4.com>. All Rights Reserved.
Copyright (c) 2004, K A Fraser
Copyright (C) 2012-2016 Mentor Graphics Inc.
Copyright(c) 2013 - 2019 Intel Corporation.
Copyright (C) 2014-2015 Intel Corp Author: Jeeja KP <jeeja.kp@intel.com>
Copyright (C) 2008 Cezary Jackiewicz <cezary.jackiewicz (at) gmail.com>
Copyright (C) 2016, Yann Collet.
Copyright (c) 2012 Intel Corporation Author: Liu, Jinsong <jinsong.liu@intel.com> Author: Jiang, Yunhong <yunhong.jiang@intel.com>
Copyright (C) 2014 Carlo Caione
Copyright 2014 Chen-Yu Tsai
(c) 1997-8 Grant Guenther <grant@torque.net>
Copyright (C) 2013 Antti Palosaari <crope@iki.fi>
Copyright (C) 2006 Paul Mundt
Copyright (c) 2017-2018 Mellanox Technologies. All rights reserved
Copyright (c) 2016 Tom Haynes <loghyr@primarydata.com>
Copyright (c) 2016-2017, Mellanox Technologies. All rights reserved.
Copyright (c) 2012 Stefan Achatz <erazor_de@users.sourceforge.net>
Copyright(C) 2015 Linaro Limited. All rights reserved. Author: Mathieu Poirier <mathieu.poirier@linaro.org>
Copyright (c) 2009 Andy Walls <awalls@md.metrocast.net>
Copyright (C) 2006 Contec Steuerungstechnik & Automation GmbH Manfred Gruber <m.gruber@tirol.com>
(c) 1998-2002 Petr Vandrovec <vandrove@vc.cvut.cz>
Copyright(c) 2018 NXP. All rights reserved.
Copyright © 2015 Broadcom Corporation
Copyright (C) 2014 Florian Vaussard, EPFL Mobots group
Copyright (C) 2001 Ralph Metzler <ralph@convergence.de> Marcus Metzler <marcus@convergence.de> for convergence integrated media GmbH
Copyright (C) 2008 by Eric Van Hensbergen <ericvh@gmail.com>
Copyright 2006-2007, Michael Ellerman, IBM Corporation.
Copyright (C) 2011-2015 Freescale Semiconductor, Inc. All Rights Reserved.
Copyright (c) 2018, The Linux Foundation. All rights reserved.
Copyright (C) 2017 Socionext Inc. Author: Masahiro Yamada <yamada.masahiro@socionext.com>
Copyright (C) 2004 Red Hat, Inc., James Morris <jmorris@redhat.com>
Copyright © 2002, 2003 David Dawes <dawes@xfree86.org> 2004 Sylvain Meyer
Copyright 2001, 2008 MontaVista Software Inc. Author: MontaVista Software, Inc. <source@mvista.com>
Copyright (C) 1998,99 Takashi Iwai <tiwai@suse.de>
Copyright (C) 2007 Nobuhiro Iwamatsu
Copyright 2017 CS Systemes d'Information.
Copyright (C) 2007, 2008 David S. Miller <davem@davemloft.net>
Copyright 2000-2020 Broadcom Inc. All rights reserved.
Copyright 2012, Fabio Baltieri <fabio.baltieri@gmail.com>
Copyright (C) 2017 Broadcom Author: Florian Fainelli <f.fainelli@gmail.com>
Copyright (C) 2005-2008, PA Semi, Inc
Copyright 1998-2015 VMware, Inc.
Copyright 2013 Advanced Micro Devices, Inc. All Rights Reserved.
Copyright (C) 1996, 1999, 2001 David S. Miller (davem@redhat.com)
Copyright (c) 2010 Samsung Electronics Co., Ltd. http://www.samsung.com/
Copyright 2009-10 Wolfson Microelectronics, plc
Copyright 2015 Technologic Systems
Copyright (c) Siemens AG, 2015-2017
Copyright (C) 2016 Icenowy Zheng <icenowy@aosc.xyz>
Copyright 2011 Realtek Microelectronics
Copyright (C) 2017 Glider bvba
Copyright (C) 2016 Texas Instruments, Inc.
Copyright (C) 2007-2013 ST-Ericsson DMA driver for COH 901 318 Author: Per Friden <per.friden@stericsson.com>
Copyright (C) Alan Cox GW4PTS (alan@lxorguk.ukuu.org.uk)

Copyright 2000, 2006 IBM Corporation Author(s):Alan Altmark (Alan_Altmark@us.ibm.com) Xenia Tkatschow (xenia@us.ibm.com) Rewritten for af_iucv: Martin Schwidfsky <schwidfsky@de.ibm.com>
Copyright (C) 2009-2010 Marvell International Ltd. Haojian Zhuang <haojian.zhuang@marvell.com>
Copyright (c) 2013-2014, The Linux Foundation. All rights reserved.
Copyright (C) 2007, 2008, Marvell International Ltd.
(c) Copyright 2007-2013 Datera, Inc.
Copyright (C) 2018-2019 SiFive, Inc.
Copyright (c) 2014 Andreas Noever <andreas.noever@gmail.com>
Copyright 2011 Wolfson Microelectronics plc
Copyright (C) 1999-2000 Takashi Iwai
Copyright (C) 2012 Texas Instruments Author: Rob Clark <robdclark@gmail.com>
Copyright (C) 2012 Google, Inc
Copyright (C) 2011 Texas Instruments Author: Raja Mani <raja_mani@ti.com> Author: Manjunatha Halli <manjunatha_halli@ti.com>
Copyright (C) 2010 by David Härdeman <david@hardeman.nu>
Copyright (C) 2006/2007 Kristoffer Ericson <Kristoffer.Ericson@gmail.com>
Copyright 2009,2012 Gražvydas Ignatas <notasas@gmail.com>
Copyright (c) 2016 Hisilicon.
Copyright (C) 2006 - 2008 Lemote Inc. & Institute of Computing Technology Author: Yanhua, yanh@lemote.com
Copyright 2016, Cyril Bur, IBM Corp.
Copyright (c) 2014 Peter Meerwald <pmeerw@pmeerw.net>
Copyright (c) 2011, Intel Corporation. All Rights Reserved.
Copyright 2014-2015 Advanced Micro Devices, Inc.
Copyright (C) 2013 Tensilica Inc.
Copyright (C) 2017 Imagination Technologies Author: Paul Burton <paul.burton@mips.com>
Copyright 1999, Thomas Davis, tadavis@lbl.gov.. Based on dummy.c, and eql.c devices.
Copyright (c) 2004 Aaron Grothe ajgrothe@yahoo.com
Copyright (C) 2002 Herbert Valerio Riedel <hvr@gnu.org>
Copyright (C) 2006 Hans Verkuil (hverkuil@xs4all.nl)
Copyright (C) 2001 - 2007 Paul Mundt
Copyright (C) 2015 Naveen N. Rao, IBM Corporation
Copyright (C) International Business Machines Corp., 2009 Author(s): Steve French (sfrench@us.ibm.com)
Copyright (c) 2016-2018 Broadcom Limited
Copyright (C) 2016 Marvell
Copyright (C) 2017 Pintu Kumar <pintu.ping@gmail.com>
Copyright 2016 Karol Herbst
Copyright 2002-2004, 2008-2009 Freescale Semiconductor, Inc.
Copyright (c) 2012-2019, NVIDIA CORPORATION. All rights reserved.
Copyright (c) 2008-2009 Atheros Communications Inc.
Copyright (C) 2017 Fuzhou Rockchip Electronics Co.Ltd Author: Jacob Chen <jacob-chen@iotwrt.com>
Copyright (c) 2016-2017 Hisilicon Limited. */ include <linux/crypto.h> include <linux/dma-mapping.h> include <linux/dmapool.h> include <linux/module.h> include <linux/mutex.h> include <linux/slab.h>
Copyright © 2014 Red Hat Inc.
Copyright: (C) 2015 Julia Lawall, Inria. URL: http://coccinelle.lip6.fr/ Options: --no-includes --include-headers
Requires: 1.0.4 Keywords: for_each_child_of_node, etc.
Copyright 2017 Chen-Yu Tsai <swens@csie.org>
Copyright (c) 2010, CompuLab, Ltd. Author: Mike Rapoport <mike@compulab.co.il>
Copyright (c) by Jaroslav Kysela <perex@perex.cz>,
Copyright (c) 2018 MediaTek Inc. Author: Ben Ho <ben.ho@mediatek.com> Erin Lo <erin.lo@mediatek.com>
Copyright (c) 2011-2016 Zhang, Keguang <keguang.zhang@gmail.com>
Copyright (C) 2015, Sebastian Hesselbarth <sebastian.hesselbarth@gmail.com>
Copyright (C) 2018, Red Hat Inc, Arnaldo Carvalho de Melo <acme@redhat.com>
Copyright (C) 2002 Jeff Dike (jdike@karaya.com)
Copyright 2017 Beckhoff Automation GmbH & Co. KG based on imx53-qsb.dts
(C) Copyright 2008 Xilinx, Inc.
Copyright (C) IBM Corporation, 2005 Jeff Muizelaar, 2006, 2007 Pekka Paalanen, 2008 <pq@iki.fi>
Copyright 2016 Nuvoton Technology Corp.

LICENCE TERMS (cont.)

Copyright (C) 2018 Renesas Electronics
Copyright 2005 Eric Anholt All Rights Reserved.
Copyright (C) IBM Corporation, 2014
Copyright (c) 2019 BayLibre, SAS. Author: Jerome Brunet <jbrunet@baylibre.com>
Copyright 2008-2009 Paul Mackerras, IBM Corporation.
Copyright (C) 2015, Intel Corporation
Copyright 2001 Compaq Computer Corporation.
Copyright (C) 2006 Nokia Corporation
Copyright 2015 Google, Inc
Copyright (C) 2015 Jens Kuske <jenskuske@gmail.com>
Copyright (C) STMicroelectronics 2009
Copyright (C) 2002 Maciej W. Rozycki
Copyright (C) 2010, Lars-Peter Clausen <lars@metafoo.de> Driver for chargers which report their online status through a GPIO pin
Copyright (C) 2008 James Smart, Emulex Corporation
Copyright (C) 2016 Chen-Yu Tsai <wens@csie.org>
Copyright (C) 2007-2008 Advanced Micro Devices, Inc. Author: Joerg Roedel <joerg.roedel@amd.com>
Copyright IBM Corp. 1999, 2013 Author(s): Ingo Adlung (adlung@de.ibm.com) Cornelia Huck (cornelia.huck@de.ibm.com) Arnd Bergmann (arndb@de.ibm.com)
Copyright (C) 2011 Samsung Electronics Co.Ltd Authors: Seung-Woo Kim <sw0312.kim@samsung.com> Inki Dae <inki.dae@samsung.com> Joonyoung Shim <jy0922.shim@samsung.com>
Copyright 2019 NXP Semiconductors
Copyright (C) 2008 by Sascha Hauer <kernel@pengutronix.de>
Copyright (C) 2017 Martin Blumenstingl <martin.blumenstingl@googlemail.com>
Copyright (c) 2015, Fuzhou Rockchip Electronics Co., Ltd
Copyright 2015 Joachim Eastwood <manabian@gmail.com>
Copyright (C) 2019 NXP Semiconductor, Inc.
Copyright (C) 2005 Hewlett-Packard Co Alex Williamson <alex.williamson@hp.com>
Copyright (C) 2003-2004 Giuliano Pochini <pochini@shiny.it>
Copyright 2019 Google LLC.
Copyright (C) International Business Machines Corp., 2002,2008 Author(s): Steve French (sfrench@us.ibm.com)
Copyright (C) 2000 Takashi Iwai <tiwai@suse.de>
Copyright (C) 2016 Rafał Milecki <rafal@milecki.pl>
Copyright 2009-2010 Integrated Device Technology, Inc. Alexandre Bounine <alexandre.bounine@idt.com> Added EM support Modified switch operations initialization.
Copyright (C) STRATO AG 2013. All rights reserved.
Copyright (C) 2009 Texas Instruments, Inc. http://www.ti.com/
Copyright (C) 2014 STMicroelectronics (R&D) Limited. Author: Giuseppe Cavallaro <peppe.cavallaro@st.com>
Copyright (C) 2015 Cogent Embedded, Inc.
Copyright (C) 2012 ST Microelectronics Viresh Kumar <vireshk@kernel.org>
Copyright (C) 2011 Texas Instruments Incorporated - http://www.ti.com/
Copyright (C) 2011 ARM Ltd. Author: Catalin Marinas <catalin.marinas@arm.com>
Copyright (C) 2016-19 Renesas Electronics Corporation
(c) Copyright 2003-2008 Xilinx Inc. All rights reserved.
Copyright (C) 1995, 2008 David S. Miller (davem@davemloft.net)
Copyright (C) 2018 metux IT consult Author: Enrico Weigelt, metux IT consult <info@metux.net>
Copyright (c) 2011-2014, The Linux Foundation. All rights reserved.
Copyright 1999 - 2003 ARM Limited
Copyright (C) 2013 Pengutronix, Sascha Hauer <kernel@pengutronix.de>
Copyright (C) 1997 Martin von Löwis, Régis Duchesne
Copyright (c) 2012 Eukréa Electromatique - ATMEL Author: Nicolas Royer <nicolas@eukrea.com>
Copyright 2004-2015 Freescale Semiconductor, Inc. All Rights Reserved.
Copyright (C) 2005 IBM Corporation
Copyright (c) 2004-2005 Richard Purdie
Copyright 2002-2005, Instant802 Networks, Inc.
Copyright(c) 2008 - 2009 Atheros Corporation. All rights reserved.
Copyright (C) 2000 - 2007 Jeff Dike (jdike@{linux.intel,addtoit}.com)
Copyright (C) 1999 - 2008 Krzysztof Halasa <khc@pm.waw.pl>
Copyright (c) 2013-2019, The Linux Foundation. All rights reserved.
Copyright(c) 2015-2017 Intel Corporation.
Copyright (c) 2003 Simtec Electronics <linux@simtec.co.uk> http://www.simtec.co.uk/products/SWLINUX/
(c) 2006 Andrew de Quincey
Copyright (C) 1995-1997 Paul H. Hargrove
Copyright (C) 2007 Sven Schnelle <svens@bitebene.org>
Copyright (C) 2005 Dell Inc.
"Copyright (C) 2015 ARM Ltd.:(c) readq_relaxed(c) define gic_write_irouter(v, c) writeq_relaxed(v, c);(c) readq_relaxed(c) define gic_write_ipir(v, c) writeq_relaxed(v, c);(c) readq_relaxed(c) define gits_write_baser(v, c) writeq_relaxed(v, c);(c) readq_relaxed(c) define gits_write_cbaser(v, c) writeq_relaxed(v, c);(c) readq_relaxed(c) define gicr_write_propbaser(v, c) writeq_relaxed(v, c);(c) readq_relaxed(c) define readq_relaxed(c)"
Copyright (c) 2008 Steven Toth <stoth@linuxtv.org>
Copyright (c) 2012 Takashi Iwai <tiwai@suse.de>
Copyright 2019 NXP
Copyright (C) 2016-2017 Advanced Micro Devices, Inc.
Copyright (C) 1994, 1996, 1998, 1999, 2000 Free Software Foundation, Inc.
Copyright (C) 2015 Red Hat, Inc. All Rights Reserved.
Copyright (C) 2013, Andrew Lunn <andrew@lunn.ch>
Copyright (c) 2008-2011 Juliusz Chroboczek <jch@pps.jussieu.fr>
Copyright (C) 2017 Olli Salonen <olli.salonen@iki.fi>
Copyright (C) 2013 NVIDIA Corporation
Copyright(c) 2016 Intel Corporation. All rights reserved.
Copyright IBM Corp. 2014 Author(s): Jan Willeke,
Copyright (c) 2011 Samsung Electronics Co., Ltd. http://www.samsung.com
Copyright (C) 1995, 1996 Russell King.:(C) 1996 Philip Blundell & Russell King.
Copyright (C) 2002, 2004 Oracle. All rights reserved.
Copyright IBM Corp. 2014
Copyright (C) 2012 Avionic Design GmbH
Copyright (C) 2013,2017 Advanced Micro Devices, Inc.
Copyright IBM Corp. 2011 Author(s): Jan Glauber <jang@linux.vnet.ibm.com>
Copyright (C) 1997-1999 Russell King
Copyright (C) 2004 Jochen Friedrich
Copyright (C) 2011 Samsung Electronics Donggeun Kim <dg77.kim@samsung.com>
Copyright (C) 2015, Intel Corporation. All Rights Reserved.
Copyright (C) 2018 Red Hat, Inc. All Rights Reserved. Written by David Howells (dhowells@redhat.com)
Copyright 2014 Analog Devices Inc.
Copyright (C) 2012, Intel Corp. Author: Rafael J. Wysocki <rafael.j.wysocki@intel.com>
Copyright 2019 BayLibre, SAS YAML 1.2
Copyright (c) 2009 Secret Lab Technologies, Ltd.
Copyright (c) 2011 Samsung Electronics http://www.samsung.com/
Copyright (C) 2000 ARM Limited
Copyright (C) 2009 ST-Ericsson SA
Copyright (c) 2005 by Tilman Schmidt <tilman@imap.cc>, Hansjoerg Lipp <hjlipp@web.de>, Stefan Eilers.
Copyright(c) 2013-2015 Intel Corporation. All rights reserved.
Copyright (C) 2008 ARM Ltd.
(C) 1998 Red Hat;(C) 1998 Red Hat TCP NFS related read + write fixes;(C) 1999 Dave Airlie, University of Limerick, Ireland <airlied@linux.ie>;(C) 1999 Trond Myklebust <trond.myklebust@fys.uio.no>;(C) 2005 Chuck Lever <cel@netapp.com>
copyright Jamal Hadi Salim (2015)
Copyright (C) 2011 Texas Instruments, Inc.
Copyright (c) 2012 - 2019 Intel Corporation. All rights reserved.
Copyright (c) 2017, Microsemi Corporation
Copyright (C) 2016 CNEX Labs Initial release: Javier Gonzalez <javier@cnexlabs.com> Matias Bjorling <matias@cnexlabs.com>
Copyright (C) 1996-2000 Thomas Sailer (sailer@ife.ee.ethz.ch)
Copyright (C) 2016 Derald D. Woods <woods.technical@gmail.com>

LICENCE TERMS (cont.)

Copyright Novell Inc. 2010
Copyright (C) 2018 Rockchip Electronics Co., Ltd. Alpha Lin <alpha.lin@rock-chips.com>
Copyright (C) 1996 Paul Mackerras.
Copyright © 2014-2016 Intel Corporation
(C) Copyright Linus Torvalds 1999;(C) Copyright Johannes Erdfelt 1999-2001;(C) Copyright Andreas Gal 1999;(C)
Copyright Gregory P. Smith 1999;(C) Copyright Deti Fliegl 1999 (new USB architecture);(C) Copyright Randy Dunlap
2000;(C) Copyright David Brownell 2000-2001 (kernel hotplug, usb_device_id, more docs, etc);(C) Copyright
Yggdrasil Computing, Inc. 2000 usb_device_id matching changes by Adam J. Richter);(C) Copyright Greg Kroah-
Hartman 2002-2003
Copyright (C) 2008 Chipidea - MIPS Technologies, Inc. All rights reserved.
Copyright (C) 2015-2016 Texas Instruments Incorporated - http://www.ti.com/
Copyright (c) 2014-2016 Broadcom Corporation
Copyright (C) 1995-99, 2000- 02, 06 Ralf Baechle <ralf@linux-mips.org>
Copyright (c) 2016 Mentor Graphics Inc.
Copyright (C) 2015-2016 Socionext Inc. Author: Masahiro Yamada <yamada.masahiro@socionext.com>
Copyright (C) 2014 Broadcom Corporation
(C) Copyright 2004 Texas Instruments, <www.ti.com> Richard Woodruff <r-woodruff2@ti.com>;(C) Copyright 2006
Nokia Corporation Fixed idle loop sleep Igor Stoppa <igor.stoppa@nokia.com>
Copyright 2014 Canonical
Copyright (c) 2000 by Takashi Iwai <tiwai@suse.de>, Jaroslav Kysela <perex@perex.cz>
Copyright (C) 2005 Sean Young <sean@mess.org>
Copyright (C) 2008 Bryan Wu <cooloney@kernel.org>
Copyright (C) 2012 Damian Hobson-Garcia
Copyright (c) 2004 Kailang Yang <kailang@realtek.com.tw> PeiSen Hou <pshou@realtek.com.tw> Takashi Iwai
<tiwai@suse.de> Jonathan Woithe <jwoithe@just42.net>
Copyright 2013, Michael (Ellerman) Neuling, IBM Corporation.
Copyright 2010 Samsung Electronics Co., Ltd. Pawel Osciak <p.osciak@samsung.com>
(C) 2007 by Sebastian Claßen <sebastian.classen@freenet.ag>;(C) 2007-2010 by Jan Engelhardt <jengelh@
medozas.de>
Copyright (C) 2010 Marcin Kościelnicki
Copyright (C) 2011 Texas Instruments Author: Rob Clark <rob@ti.com>
Copyright (C) 2002 Simon Evans
Copyright (C) 2010 Samsung Electronics;(c) 2004 Gerd Knorr <kxaxel@bytesex.org> [SUSE Labs]
Copyright (c) 2000-2001 Adaptec Inc. All rights reserved.
Copyright (c) 2016 Chelsio Communications, Inc. All rights reserved.
Copyright (c) 2019 Nuvoton Technology corporation.
(C) 2001 Marc Boucher (marc@mbsi.ca).
Copyright (C) 2014-2016 Glider bvba
Copyright (c) 2017-2018, Arm Ltd.
Copyright (C) 2001 Brad Boyer (flar@allandria.com);(C) 2003 Ardis Technologies <roman@ardistech.com>
Copyright (C) 2008 Igor M. Liplianin (liplianin@me.by)
Copyright (C) 2005 Nokia Corporation Written by Tony Lindgren <tony@atomide.com>
Copyright (C) 2013, NVIDIA Corporation. All rights reserved.
"Copyright: Intel Corp 2005 Jonathan Cameron <jic23@cam.ac.uk> 2009"
Copyright (c) 2016 Linaro Limited.
Copyright © International Business Machines Corp., 2009
Copyright (C) 2018 Jacob Feder
Copyright (c) 2000-2003 Gerd Knorr <kxaxel@bytesex.org> modified for PixelView (BT878P+W/FM) by Michal
Kochanowicz <mkochoano@pld.org.pl> Christoph Bartelmus <lirc@bartelmus.de> modified for KNC ONE TV Station/
Anubis Typhoon TV Tuner by Ulrich Mueller
Copyright (C) 2011 Nokia Corporation Paul Walmsley
Copyright 2002 MontaVista Software Author: MontaVista Software, Inc. ppopov@mvista.com or source@mvista.com
Copyright (C) 2013-2015 Altera Corporation
Copyright © 2008 Intel Corporation
(C) Copyright 1995 1996, 2014 Linus Torvalds
Copyright (c) 2014 Lucas Stach <l.stach@pengutronix.de>, Pengutronix
Copyright 2013 Christian Hemp, Phytex Messtechnik GmbH
Copyright (C) 1995-1996 Jean-loup Gailly
(C) Copyright 2003-2004 Humboldt Solutions Ltd, adrian@humboldt.co.uk.
Copyright © 2014-2015 Broadcom
Copyright (C) 2008-2018 Andes Technology Corporation
Copyright IBM Corp. 2000, 2006 Author(s): Denis Joseph Barrow (djabarrow@de.ibm.com,barrow_dj@yahoo.com)
Gerhard Tonn (ton@de.ibm.com)
Copyright (C) 2010-2017 Mathieu Desnoyers <mathieu.desnoyers@efficios.com>
Copyright (C) 2001-2005 Tensilica Inc.
Copyright (c) 2011 Bryan Schumaker <bjschuma@netapp.com>
Copyright (C) 1991, 1992, 2002 Linus Torvalds
(c) MontaVista, Software, Inc.
Copyright (C) 2001-2003 Patrick Mochel
Copyright (c) 2016-present, Yann Collet, Facebook, Inc. All rights reserved.
Copyright (C) 2001 Momchil Velikov
Copyright (C) Guenter Roeck <linux@roeck-us.net>
Copyright 2013 Freescale Semiconductor, Inc. Author: Dongsheng Wang <Dongsheng.Wang@freescale.com> Li
Yang <leoli@freescale.com>
Copyright (C) 2010 Alexey Charkov <alchark@gmail.com>
(c) 1993 Drew Eckhard;(c) 1994,1995,1996 Kevin Lentin
Copyright (C) 2017 Netronome Systems, Inc.
Copyright (C) 2018 Laurent Pinchart <laurent.pinchart@ideasonboard.com>
Copyright (c) 2018 ARM Ltd.
Copyright 2018 Hans de Goede <hdegoede@redhat.com>
Copyright (C) 2011-2012 Jean-Christophe PLAGNIOL-VILLARD <plagnioj@jcrosoft.com>
Copyright (C) 2002 - 2009 Paul Mundt
Copyright 2015 Boundary Devices, Inc.
Copyright 2010-2013 Imagination Technologies Ltd.
Copyright (c) 2003 John Homppi (SCO, leave this notice here)
Copyright (C) 2004 Infineon IPAC DC COM CPE
Copyright (C) 2012 Intel Corporation. All rights reserved.
Copyright (C) 2017 Zodiac Inflight Innovations
Copyright (C) 1999 VA Linux Systems
Copyright (C) 2006,2007 Red Hat, Inc., Ingo Molnar <mingo@redhat.com>
Copyright (C) 1994 by Ingo Wilken (Ingo.Wilken@informatik.uni-oldenburg.de)
Copyright (C) 2010 CompuLab Ltd.
(C) 1997-1998 Caldera, Inc.:(C) 1998 James Banks;(C) 1999-2001 Torben Mathiasen <trmm@image.dk, torben.
mathiasen@compaq.com>
(c) 2016 Arnaldo Carvalho de Melo <acme@redhat.com>
Copyright (C) 2017 SiFive
Copyright (C) 2009 James Smart, Emulex Corporation
Copyright (C) 2012 Bastian Hecht
Copyright(c) 2017 Intel Corporation.
Copyright (C) 1995-97 Simon G. Vogl 1998-99 Hans Berglund
Copyright 2018 David Lechner <david@lechnology.com>
Copyright (C) 2012 V Lab Technologies Teddy Reed <teddy@prosauce.org>
(c) 2002 Gerd Knorr <kxaxel@bytesex.org>
Copyright (C) 2007 Antonino Daplas <adaplas@pol.net>
Copyright (C) 2011 Renesas Solutions Corp.
(C) Copyright IBM Corporation 1994, 2003 Authors: Colin DeVilbiss (devilbis@us.ibm.com) Santiago Leon (santil@
us.ibm.com) Dave Boutcher (sleddog@us.ibm.com)
Copyright (c) 2017-18 Linaro Limited
Copyright (C) 1995 Linus Torvalds
(C) 2001 Andreas Gruenbacher, <a.gruenbacher@computer.org>
"Copyright (C) 2001,2002 Simon Evans <spse@secret.org.uk>"
Copyright 2016 Freescale Semiconductor, Inc.
Copyright 1999 by Werner Cornelius (werner@titro.de)
Copyright (c) 2003-2008 Cavium Networks

LICENCE TERMS (cont.)

(c) MontaVista Software, Inc. Vitaly Bordug <vbordug@ru.mvista.com>
Copyright 2011 Wolfson Microelectronics. PLC.
Copyright 2011 Ben Herrenscheidt, IBM Corp.
Copyright (c) 2015, Roger Pau Monne <roger.pau@citrix.com>
Copyright 2002 by Kai Gernaschewski <kai.gernaschewski@gmx.de>
Copyright (C) 2016 Texas Instruments Incorporated - http://www.ti.com/
Copyright (c) 2018 Martin Blumenstingl <martin.blumenstingl@googlemail.com>. Based on meson-gxl-s905d-p231.dts:
Copyright(c) 2019 Intel Corporation. All rights reserved.
Copyright (C) 2015 Texas Instruments, Inc.
Copyright (C) Manu Abraham <abraham.manu@gmail.com>
Copyright (c) 2017 Chen-Yu Tsai. All rights reserved.
Copyright (C) IBM Corporation, 2013
(C) 2003 Marc Zyngier <maz@wild-wind.fr.eu.org>
Copyright (C) 2002,2003 Jun Nakajima <jun.nakajima@intel.com>
Copyright(c) 2013 - 2018 Intel Corporation. */
Copyright (c) 2011, Tom Herbert <therbert@google.com>
Copyright (c) 2005 Benjamin Herrenscheidt, IBM Corp. benh@kernel.crashing.org>
Copyright (C) 2011 Hans de Goede <hdegoede@redhat.com>
Copyright (C) 2003 MontaVista Software, Inc. Author: George G. Davis <gdavis@mvista.com> or <source@mvista.com>
Copyright (C) 2018 Macronix International Co., Ltd.
Copyright (C) 2010 Nokia Corporation. All rights reserved.
Copyright (C) 2002,2004 MARA Systems AB <http://www.marasystems.com> by Henrik Nordstrom <hno@marasystems.com>
Copyright 1998-2008 VIA Technologies, Inc. All Rights Reserved.
Copyright (C) 1997-2002 Russell king
Copyright 2005 Tejun Heo
Copyright 2011-2014 VMware, Inc., Palo Alto, CA., USA
Copyright (C) 2010 Texas Instruments Incorporated - http://www.ti.com/ Tarun Kanti DebBarma <tarun.kanti@ti.com> Thara Gopinath <thara@ti.com>
Copyright IBM Corp. 2003, 2006
Copyright (c) 2000-2001 Silicon Graphics, Inc. All Rights Reserved.
"Copyright (C) 1999-2002 Andre Hedrick <andre@linux-ide.org>"
Copyright (C) 2002 STMicroelectronics
Copyright (C) 2018 IBM Corp. All rights reserved. Author: Alexey Kardashevskiy <aik@ozlabs.ru>
Copyright(c) 1999 - 2008 Intel Corporation.
Copyright (C) 2006. Freescale Semiconductor, Inc. All rights reserved.
Copyright (C) 2007-2008 BalaBit IT Ltd. Author: Krisztian Kovacs
Copyright (c) 2012, NVIDIA Corporation.
Copyright (C) 2012, Anish Kumar <anish198519851985@gmail.com>
Copyright (c) 2006 - 2009 Mellanox Technology Inc. All rights reserved.
Copyright (C) 2008 Magnus Damm
Copyright (c) 2019 Mellanox Technologies.
Copyright (C) 2018 BayLibre, SAS
Copyright(c) 2016 Intel Corporation.
Copyright (c) 2014 MediaTek Inc. Author: Flora Fu, MediaTek
Copyright (c) 2005 - James Bottomley <James.Bottomley@steeleye.com>
Copyright (c) 2007 Mellanox Technologies. All rights reserved.
Copyright 2013 Matrox Graphics
Copyright (C) 2018 Renesas Electronics Corp.
Copyright (c) 2009-2010 Clemens Ladisch
Copyright (C) 2015 Intel Corporation. All rights reserved.
Copyright (C) 2008 Sascha Hauer, Pengutronix
Copyright (C) 2014-15 Synopsys, Inc. (www.synopsys.com)
Copyright 2013 Eukrea Electromatique <eric@eukrea.com>
Copyright (c) 2010 Katalix Systems Ltd

Copyright (C) 2008 Cluster Computing, Inc.
Copyright (c) 2009-2010 Marvell International Ltd. Haojian Zhuang <haojian.zhuang@marvell.com>
Copyright (c) Matthew Wilcox 1999 <willy@infradead.org>
Copyright (C) 2014 Rabeeh Khoury (rabeeh@solid-run.com) Based on dt work by Russell King
Copyright 2019 Intel Corporation.
Copyright © 1997-1998 by PowerLogix R & D, Inc.
Copyright (c) 2011 Stefan Achatz <erazor_de@users.sourceforge.net>
Copyright (c) 2015-2016, IBM Corporation.
Copyright (C) 1996 Russell King
Copyright IBM Corp. 2001 Author(s): Carsten Otte <cotte@de.ibm.com> Michael Holzheu <holzheu@de.ibm.com>
Tuan Ngo-Anh <ngoanh@de.ibm.com>
Copyright (c) 2018 Red Hat, Inc. All rights reserved.
Copyright (C) 2013, Microsoft, Inc. Author : K. Y. Srinivasan <kys@microsoft.com>
Copyright (C) 1995,2001 Compaq Computer Corporation
Copyright (c) 2017-2018 Mellanox Technologies. All rights reserved.
Copyright (C) 2007-2013 VMware, Inc. All rights reserved.
Copyright (C) 2017 Chen-Yu Tsai <wens@csie.org>
"Copyright (c) 2012 Marvell International Ltd. Author: Jett Zhou <jtzhou@marvell.com> Haojian Zhuang <haojian.zhuang@marvell.com>"
Copyright (C) 2014 Linaro Limited Author: AKASHI Takahiro <takahiro.akashi@linaro.org>
Copyright (c) 2011, Microsoft Corporation.
Copyright (c) 2015 MediaTek Inc. Author: YT SHEN <yt.shen@mediatek.com>
Copyright (C) 2015 Atmel Corporation
Copyright (c) 2011 Analog Devices Inc.
Copyright(c) 2017 - 2019 Pensando Systems, Inc
Copyright (C) 2007, 2008 Oracle Corporation Written by: Martin K. Petersen <martin.petersen@oracle.com>
Copyright 2015 Amazon.com, Inc. or its affiliates.
Copyright (C) 2015-2018 Glider bvba
Copyright (C) 2015 Microchip Technology Inc. All rights reserved.
Copyright (c) 2012 - 2018 Microchip Technology Inc., and its subsidiaries. All rights reserved.
Copyright 2013 Red Hat All Rights Reserved.
Copyright (C) 2018 Western Digital Corporation
Copyright (C) 2007-2012 Siemens AG
Copyright (c) 2016, Oracle and/or its affiliates. All rights reserved.
Copyright (C) 2012, Michel Lespinasse <walken@google.com>
Copyright 2012 Wolfson Microelectronics PLC.
Copyright (c) 2016 Tom Herbert <tom@herbertland.com>
Copyright © 2000 Red Hat UK Limited
Copyright (c) 2001-3 Patrick Mochel
Copyright (C) 2008 Ralf Baechle (ralf@linux-mips.org)
Copyright (C) 2016 Icenowy Zheng <icenowy@aosc.io>
Copyright (C) 2005-2006 Intel Corporation. Inaky Perez-Gonzalez <inaky.perez-gonzalez@intel.com>
Copyright (C) 2015 Stefan Wahren <stefan.wahren@i2se.com>
(C) Copyright 1998-2000 by some Elitist 680x0 Users(TM)
Copyright (c) 2018-2019 Synopsys, Inc. and/or its affiliates. Synopsys DesignWare eDMA v0 core
Copyright 2017 IBM Corporation
Copyright (C) 2002 Russell King
Copyright (C) 2007,2008 Freescale semiconductor, Inc.
Copyright (C) 2015-2019 Google, Inc.
Copyright (c) 2018 Quantenna Communications, Inc. All rights reserved.
"Copyright (C) 2005-2006 by Texas Instruments;(c) and read length is less than 64KB (max per cpipi descriptor) not a multiple of 4096 (g_zero default, full reads typical) N (>1) packets long, ditto (full reads not EXPECTED) THEN try rx ndis mode"
Copyright 2011 Analog Devices Inc. Author: Lars-Peter Clausen <lars@metafoo.de> based on an initial version by Cliff Cai <cliff.cai@analog.com>
Copyright 2006 Michael Ellerman, IBM Corporation
Copyright (C) 1997, 99, 2001 - 2004 Ralf Baechle <ralf@linux-mips.org>

LICENCE TERMS (cont.)

Copyright 2017 Canonical Ltd.
Copyright (c) 2012 Dongjin Kim <tobetter@gmail.com>
Copyright (C) 2014 Akihiro Tsukada <tskd08@gmail.com>
Copyright (C) 2015, Applied Micro Circuits Corporation
Copyright: (c) 2014 Czech Technical University in Prague;(c) 2014 Volkswagen Group Research Author: Rostislav Lisovy <rostislav.lisovy@fel.cvut.cz> Funded by: Volkswagen Group Research
Copyright (C) 2015 VanguardiaSur - www.vanguardiasur.com.ar
Copyright (c) 2008, Christoph Hellwig All Rights Reserved.
Copyright (c) by Jaroslav Kysela <perex@perex.cz> Routines for control of EMU10K1 MPU-401 in UART mode
Copyright (C) 2009-2010 Advanced Micro Devices, Inc. Author: Joerg Roedel <jroedel@suse.de>
"Copyright 2008-2009 Johannes Berg <johannes@sipsolutions.net>"
Copyright (C) 2011--2012 Nokia Corporation Contact: Sakari Ailus <sakari.ailus@iki.fi>
Copyright 2009 Jonathan Corbet <corbet@lwn.net>
Copyright (C) 2018 Intel Corporation Author: Heikki Krogerus <heikki.krogerus@linux.intel.com>
Copyright (C) 2007 Stephen Hemminger <shemminger@linux-foundation.org>
Copyright IBM Corp. 2002, 2006
Copyright (c) 2002 Daniel Engstrom <5116@telia.com>
Copyright (c) 2015 Samsung Electronics Co., Ltd. http://www.samsung.com
Copyright (C) 2019 Oleksij Rempel <o.rempel@pengutronix.de>
Copyright (c) 2004+ Evgeniy Polyakov <zbr@ioremap.net>
Copyright (c) 2013-2014 Hisilicon Limited.
Copyright (c) 2011 Samsung Electronics Co., Ltd. Kamil Debski, <k.debski@samsung.com>
Copyright (C) 1997, 2004 David S. Miller (davem@redhat.com)
Copyright (c) 2008-2009 Patrick McHardy <kaber@trash.net>
Copyright (C) 2014 Red Hat
Copyright (c) 2008, John W. Linville <linville@tuxdriver.com>
Copyright NXP 2019
Copyright (C) 2007-2008 Intel Corporation <linux-wimax@intel.com> Inaky Perez-Gonzalez <inaky.perez-gonzalez@intel.com>
(C) 2010,2011 Thomas Renninger <trenn@suse.de>, Novell Inc.
Copyright 2005-2006 Fen Systems Ltd.
Copyright (C) 2013 Texas Instruments, Inc Tero Kristo (t-kristo@ti.com)
Copyright 2003 NVIDIA, Corporation. All rights reserved. *|
Copyright 2017, Michael Neuling, IBM Corp. Original: Breno Leitao <brenohl@br.ibm.com> & Gustavo Bueno Romero <gromero@br.ibm.com> Edited: Michael Neuling
Copyright (C) 2012 - 2013 Xilinx
(C) Copyright Red Hat Inc. 2017
Copyright 2013 Texas Instruments
Copyright (C) 2014 Anton Blanchard <anton@au.ibm.com>, IBM
(c) Copyright 1999, 2000 Red Hat Software
Copyright (C) 2007, David Kilroy
Copyright (c) 2010 - 2017 Intel Corporation. Len Brown <len.brown@intel.com>;(C) Len Brown <len.brown@intel.com>
Copyright (c) 2015 Measurement-Specialties
Copyright (C) 2019 Texas Instruments
Copyright (C) 2014 Renesas Solutions Corp.
Copyright IBM Corp. 1999, 2000 Author(s): Martin Schwidefsky (schwidefsky@de.ibm.com), Denis Joseph Barrow (djbarrow@de.ibm.com,barrow_dj@yahoo.com),
Copyright (C) 2015 Endless Mobile, Inc. Author: Carlo Caione <carlo@endlessm.com>
Copyright (C) 1999 Eddie C. Dost (ecd@atecom.com)
Copyright (C) 2015, 2016 IBM Corporation
Copyright (c) 2012-2013 Samsung Electronics Co., Ltd. http://www.samsung.com
Copyright (C) 2014 ARM Limited
Copyright (c) 2007 Cisco Systems, Inc. All rights reserved.
Copyright (c) 2010 Stefan Achatz <erazor_de@users.sourceforge.net>
Copyright (C) 2017 Texas Instruments Incorporated - http://www.ti.com/
Copyright (C)2003 USAGI/WIDE Project

Copyright (C) 2004,2005 ADDI-DATA GmbH for the source code of this module. Project manager: Eric Stolz
Copyright (C) 1998, 1999, 2000 Ingo Molnar
Copyright 2019 IBM Corp.
Copyright (C) 2014 Maxime Ripard
Copyright (C) 1995-2002 Russell King
Copyright (c) 2019 MediaTek Inc. Author: Wendell Lin <wendell.lin@mediatek.com>
(C) 1999 Mihai Spatar;(C) 2000 YAEGASHI Takeshi;(C) 2003, 2004 Paul Mundt;(C) 2003, 2004, 2006 Andriy Skulys
Copyright (C) 2002 Andriy Skulys
Copyright IBM Corp. 2017,2019 Author(s): Harald Freudenberger
Copyright IBM Corp. 2000 Author(s): Martin Schwidefsky (schwidefsky@de.ibm.com), Gerhard Tonn (ton@de.ibm.com) Thomas Spatzier (tspat@de.ibm.com)
Copyright (C) 2005 Paul Mundt
Copyright (C) NEC Electronics Corporation 2004-2006
Copyright (C) 2003 David Gibson, IBM Corporation.
Copyright (c) 2006 by Matthias König <mk@phasorlab.de>
Copyright (C) Icenowy Zheng <icenowy@aosc.io>
Copyright (c) 2011 Ericsson AB.
(C) 2000-2005 by Harald Welte <laforge@gnumonks.org>;(C) 2006-2012 Patrick McHardy <kaber@trash.net>
Copyright (C) 2016 Martin Spertl
Copyright (c) 2008-2014 STMicroelectronics Limited
Copyright (c) 2009-2010 Intel Corporation
Copyright (C) 2004 Alex Kern <alex.kern@gmx.de>
Copyright(c) 2013 Realtek Corporation. All rights reserved.
Copyright (C) 2016 William Breathitt Gray
Copyright 2017 - Alexandre Torgue <alexandre.torgue@st.com>
Copyright (C) 1998 by Michael Schmitz
Copyright (C) 1999, 2000 Ralf Baechle
Copyright (C) 2004 MontaVista Software, Inc.
Copyright (c) 2014 Samsung Electronics Co., Ltd http://www.samsung.com
Copyright (c) 2008-2009 USI Co., Ltd. All rights reserved.
Copyright (C) 2003 MontaVista Software Inc. Author: Jun Sun, jsun@mvista.com or jsun@junsun.net
Copyright (C) 2011 Daniel Hellstrom (daniel@gaisler.com) Aeroflex Gaisler AB
Copyright (C) 2015 Joachim Eastwood <manabian@gmail.com>
Copyright (c) 2001-2012 Anton Altaparmakov and Tuxera Inc.
Copyright (C) 2007 Atmel Corporation
Copyright 2005-2006 PMC-Sierra, Inc. Author: Marc St-Jean, Marc_St-Jean@pmc-sierra.com
Copyright (C) 2003 Jamie Honan
Copyright 2010-2011 Texas Instruments Inc.
Copyright (C) 2007 Lemote, Inc. Author : jlliu <liujl@lemote.com>
Copyright 2007, 2009 CompuLab, Ltd.
Copyright 2002 Rusty Russell <rusty@rustcorp.com.au> IBM Corporation
Copyright (c) 2009 Matthieu Crapet <mcrapet@gmail.com>
Copyright (c) 2001 Cliff Brake <cbrake@accelent.com>
Copyright (C) 2000, 05 by Ralf Baechle (ralf@linux-mips.org)
Copyright (c) 1997-2000 LAN Media Corporation (LMC) All rights reserved. www.lanmedia.com
Copyright (C) 2016 Markus Heiser
Copyright (C) 1992 Drew Eckhardt SCSI disk driver header file by Drew Eckhardt
Copyright (C) 2012 Intel Corporation Author: Jim Kukunas <james.t.kukunas@linux.intel.com>
Copyright (c) 2001 Adaptec Inc. All rights reserved.
Copyright (C) 2015 Linus Walleij
Copyright 2015, Michael Ellerman, IBM Corp.
Copyright (C) 2013-2015 Alexei Starovoitov <ast@kernel.org>
Copyright (C) 2005 Stuart Brady
Copyright 2002-2007 H. Peter Anvin - All Rights Reserved
Copyright 2007-2008 Freescale Semiconductor Inc.
Copyright (C) 2013 ARM Limited

LICENCE TERMS (cont.)

Copyright (C) 2010 Google, Inc. Author: Colin Cross <ccross@android.com>
Copyright 2007-2015 VMware, Inc.
"Copyright: (C) 2004 MontaVista Software, Inc."
Copyright (c) 2017-2019, IBM Corporation.
Copyright (C) 2008 Steven Rostedt <srostedt@redhat.com>
Copyright IBM Corporation, 2010 Author Aneesh Kumar K.V <aneesh.kumar@linux.vnet.ibm.com>
Copyright (C) 2012 Red Hat, Inc. All rights reserved. Author: Alex Williamson <alex.williamson@redhat.com>
Copyright (C) Peter Maydell 05/1998 <pmaydell@chiark.greenend.org.uk> Converted to driver model Jochen Friedrich <jochen@scram.de>
Copyright (C) 2019 PHYTEC Messtechnik GmbH Author: Stefan Riedmueller <s.riedmueller@phytec.de>
Copyright © 2004-2008 Simtec Electronics http://armlinux.simtec.co.uk/ Ben Dooks <ben@simtec.co.uk>
Copyright (C) 2001 Kaz Kojima
Copyright (C) 1994, 95, 96, 97, 98, 99, 2000 by Ralf Baechle
Copyright (C) 2013 Linus Torvalds
Copyright 2014 Sony Mobile Communications Inc.
Copyright 2007-2009 Freescale Semiconductor, Inc. All Rights Reserved.
Copyright (C) 2015-2017 Socionext Inc. Author: Masahiro Yamada <yamada.masahiro@socionext.com> Kunihiro Hayashi <hayashi.kunihiko@socionext.com>
Copyright (c) 2010-2016, FocalTech Systems, Ltd., all rights reserved.
Copyright (C) 2011-2014 Joshua Kinard <kumba@gentoo.org>.
Copyright (c) by Jaroslav Kysela <perex@perex.cz> Universal interface for Audio Codec '97
Copyright (C) 2017-2018 Intel Corporation, Inc.
Copyright (c) 1998 by Frank van de Pol <fvdpol@coil.demon.nl>
Copyright (c) 1999 Al Smith;(c) 1985 MIPS Computer Systems, Inc.
Copyright 2009 Paul Mackerras, IBM Corporation.
Copyright (C) 2011 Intel Corporation. All rights reserved.
Copyright (C) 2018 MediaTek Inc. Author: Ryder Lee <ryder.lee@mediatek.com>
Copyright 2012 IBM Corporation
Copyright (C) 1994-2013 Russell King
Copyright (C) 2013-2016 Geschwister Schneider Technologie-, Entwicklungs- und Vertriebs UG (Haftungsbeschränkt).
Copyright (C) 2015 Advanced Micro Devices, Inc.
Copyright (C) 2003, 2004 Ralf Baechle
Copyright (C) 2007 Google, Inc.
Copyright (c) 2014-2016, The Linux Foundation. All rights reserved.
Copyright (c) 2016 Cavium Inc.
Copyright 2009 Wolfson Microelectronics PLC.
Copyright 1994 Digital Equipment Corporation.
Copyright IBM Corp. 2001 Author(s): Fritz Elfert <felfert@millenux.com> <elfert@de.ibm.com>
Copyright (c) 2019 Mellanox Technologies. */
Copyright (C) 2006,2007 Felix Fietkau <nbd@openwrt.org>
Copyright (C) 2016, Sony Mobile Communications Inc.
Copyright (c) International Business Machines Corp., 2009, 2013 Etersoft, 2012 Author(s): Steve French (sfrench@us.ibm.com) Pavel Shilovsky (pshilovsky@samba.org) 2012
Copyright 1995-2002, Russell King
Copyright (C) 2009 Thomas Chou <thomas@wytron.com.tw>
Copyright (C) 2009 Wind River Systems, Inc.
Copyright (c) 2010-2011 by Samsung Electronics.
Copyright (C) 2013 Dialog Semiconductor Ltd.
Copyright (C) 2017 MediaTek, Inc.
Copyright 2018-2019 Qiang Yu <yuq825@gmail.com> */
Copyright 2019~2020 NXP
Copyright (C) 2008 Oracle. All rights reserved.
Copyright (C) 2004 Adam Litke (agl@us.ibm.com)
Copyright (C) 2004 Randolph Chung <tausq@debian.org>
Copyright (C) 2011 Marvell International Ltd. All rights reserved.
Copyright (c) 2014 MundoReader S.L. Author: Heiko Stuebner <heiko@sntech.de>
Copyright (C) 2009 Sascha Hauer <s.hauer@pengutronix.de>
Copyright (C) 2008-2009 Nokia Corporation
Copyright (c) 2017 Dialog Semiconductor
Copyright(c) 2004 Intel Corporation. All rights reserved.
Copyright (c) 2012 Taobao. Written by Tao Ma <boyu.mt@taobao.com>
Copyright © 2007-2008 MontaVista Software, Inc.
Copyright (C) 1997,1998 Jakub Jelinek (jj@sunsite.mff.cuni.cz)
Copyright (C) 2018 MediaTek Inc.
Copyright (c) by Takashi Iwai <tiwai@suse.de>
Copyright 1995, 2008 David S. Miller (davem@davemloft.net)
Copyright (C) 2012 Red Hat, Inc.
Copyright (c) 2015, Sony Mobile Communications Inc.
Copyright (C) 1999-2005 Krzysztof Halasa <khc@pm.waw.pl>
Copyright (C) 1996 Jesper Skov (jskov@cygnus.co.uk)
Copyright (C) 1998-9 David A. Schleef <ds@schleef.org>
Copyright © 2003-2010 David Woodhouse <dwmw2@infradead.org>
Copyright (C) 2016 Linus Walleij
Copyright 2011-2013 Broadcom Corporation
(C) Copyright 2012 Intel Corporation Author: Dirk Brandewie <dirk.j.brandewie@intel.com>
Copyright 2008 Wolfson Microelectronics PLC.
Copyright (C) 2010 OMICRON electronics GmbH
(c) G. Liakhovetski g.liakhovetski@gmx.de
Copyright (C) 2018 NXP
Copyright (c) 2000,2005 Silicon Graphics, Inc. All Rights Reserved.
Copyright (C) 2004-2010 Markus Grabner (grabner@icg.tugraz.at) Emil Myhrman (emil.myhrman@gmail.com)
Copyright (c) 2015, NVIDIA CORPORATION. All rights reserved.
Copyright 2012 Actions Semi Inc. Author: Actions Semi, Inc.
Copyright (c) 2011 Samsung Electronics Co., Ltd. Authoer: Inki Dae <inki.dae@samsung.com>
Copyright (C) 2016 Freescale Semiconductor, Inc. All Rights Reserved.
Copyright (c) 2007-2008 Mauro Carvalho Chehab <mchehab@kernel.org>
Copyright 2017 Gateworks Corporation
Copyright (C) 2012 Jussi Kivilinna <jussi.kivilinna@mbnet.fi>
Copyright 2014 Cisco Systems, Inc. and/or its affiliates. All rights reserved.
Copyright (c) 2018 Pengutronix, Oleksij Rempel <o.rempel@pengutronix.de>
Copyright (C) 2017 Microchip Technology Inc. Tristram Ha <Tristram.Ha@microchip.com>
Copyright (C) 2001 Sysgo Real-Time Solutions GmbH
Copyright (c) 2009 Trond Myklebust <Trond.Myklebust@netapp.com>
Copyright (c) 2015 Endless Mobile, Inc. Author: Carlo Caione <carlo@endlessm.com>
Copyright (C) 2002, Erich Focht, NEC
(C) Copyright 1995-1999 Tekram Technology Co., Ltd.
Copyright (C) 2014 Chen-Yu Tsai Author: Chen-Yu Tsai <wens@csie.org>
Copyright (C) 2002 Tensilica Inc.
Copyright IBM Corp. 1999, 2000
Copyright (C) 2017, Adaptrum, Inc. Written by Alexandru Gagniuc <alex.g at adaptrum.com> for Adaptrum, Inc.)
Copyright (C) STMicroelectronics SA 2017 Authors: Yannick Fertre <yannick.fertre@st.com> Hugues Fruchet <hugues.fruchet@st.com> for STMicroelectronics.
Copyright 2010 Analog Devices Inc.
Copyright 2016 Hans Verkuil <hverkuil@xs4all.nl
(C) 2005 Georges Toth <g.toth@e-biz.lu> *
Copyright (C) 2015 Renesas Electronics Corporation
Copyright (c) 2011 Samsung Electronics Co., Ltd http://www.samsung.com
Copyright 2006 Moschip Semiconductor Tech. Ltd.
Copyright (c) 2003-2013 QLogic Corporation
Copyright (C) 2000-2005 by David Brownell
Copyright (c) 2015 Rockchip Electronics Co. Ltd. Author: Xing Zheng <zhengxing@rock-chips.com> Jeffy Chen <jeffy.chen@rock-chips.com>
Copyright 2015 Ariel D'Alessandro <ariel.dalessandro@gmail.com>

LICENCE TERMS (cont.)

Copyright (C) 2007 IBM Corporation.
Copyright (c) 2015, Intel Corporation Author: Lv Zheng <lv.zheng@intel.com>
Copyright (C) 2002, 2004, 2007 by Ralf Baechle
Copyright IBM Corp. 2008, 2017
Copyright (C) 2008 Alex Dubov <oakad@yahoo.com>
Copyright (C) 2015 Rafał Milecki <zajec5@gmail.com>
Copyright (C) 2001-2008, LINBIT Information Technologies GmbH.
Copyright: [copy] 2005 Stelian Pop <stelian@popies.net>
Copyright (C) 2015 ARM Limited
Copyright (C) 2017 Engicam S.r.l.
Copyright (c) 2008-2011, Intel Corporation
Copyright (c) 2008 Dmitry Baryshkov
Copyright (c) 2019 Andreas Klinger <ak@it-klinger.de>
Copyright (C) 2011 Texas Instruments Incorporated Author: Mark Salter (msalter@redhat.com)
Copyright 2016 Advanced Micro Devices, Inc. All Rights Reserved.
Copyright (C) 1997 David S. Miller (davem@caip.rutgers.edu)
Copyright (C) 2014 Alexsey Shestacov <wingrime@linux-sunxi.org>
Copyright (C) 2017 Oracle. All Rights Reserved. Author: Darrick J. Wong <darrick.wong@oracle.com>
Copyright Alistair Popple, IBM Corporation 2015.
Copyright 2009 Wolfson Microelectronics plc
Copyright (C) 2001-2003 Andreas Gruenbacher, <agruen@suse.de>
(C) 1999-2000 Yon Uriarte <yon@astaro.de>
Copyright (c) 2014, Primary Data, Inc. All rights reserved.
Copyright (C) 2008 Pekka Paalanen <pq@iki.fi>
Copyright (C) 2009 Samsung Electronics Author: Marek Szymowski <m.szymowski@samsung.com>
Copyright (C) 1996-2003 Russell King
Copyright (C) 2016 Hans de Goede <hdegoede@redhat.com>
Copyright (C) 2011-2012 Texas Instruments, Inc.
Copyright (C) 2014 Antti Palosaari <crope@iki.fi>
Copyright (C) 2016-2017 Texas Instruments Incorporated - <http://www.ti.com/> Author: Andreas Dannenberg <dannenberg@ti.com> Andrew F. Davis <afd@ti.com>
Copyright (C) 2015-2017 Socionext Inc. Author: Masahiro Yamada <yamada.masahiro@socionext.com>
Copyright by Hannu Savolainen 1993-1997
Copyright (C) 2005 Oracle. All rights reserved.
Copyright (c) 2016 Intel Corporation
Copyright (C) 2009 Raphael Derossa Pereira <raphaelpereira@gmail.com>
Copyright(c) 2016-2017 Broadcom. All rights reserved.
Copyright (c) 2014, Applied Micro Circuits Corporation Author: Tanmay Inamdar <tinamdar@apm.com> Duc Dang <dhdang@apm.com>
Copyright (C) 2010 Fabien Chouteau <fabien.chouteau@barco.com>
Copyright (c) 2010 Google, Inc
Copyright (C) 2008 - 2014 Xilinx, Inc.
Copyright (c) 2017, Maxim Integrated
(C) Copyright IBM 2012;(C) Copyright 2013, 2015 Linaro Limited
Copyright (C) 2019 Xilinx, Inc.
Copyright (C) 2018-2019 SiFive, Inc. Wesley Terpstra Paul Walmsley
"(c) Copyright 2005 Google Inc., All Rights Reserved.:(c) Copyright 2000 kernel concepts <nils@kernelconcepts.de>,
All Rights Reserved. <http://www.kernelconcepts.de/>;(c) Copyright 2000 kernel concepts <nils@kernelconcepts.de> developed for Jentro AG, Haar/Munich (Germany)"
Copyright (c) 2014 Marvell Technology Group Ltd.
Copyright (C) 2011 Texas Instruments, Inc. Rajendra Nayak
Copyright (C) 2010 - 2012 Samsung Electronics Co., Ltd.
Copyright (C) 1995 by Linus Torvalds
Copyright (C) 2016 Xilinx, Inc. All rights reserved.
Copyright (C) 2009 Cavium Networks
Copyright (C) 2007, 2008 Freescale Semiconductor, Inc. All rights reserved.
Copyright (C) 2018 Linus Walleij <linus.walleij@linaro.org> Parts of this file were based on the MCDE driver by
Marcus Lorentzon;(C) ST-Ericsson SA 2013
Copyright (C) 2000 Deep Blue Solutions Ltd
Copyright 2016 Cisco Systems, Inc. and/or its affiliates. All rights reserved.
Copyright (c) 1994, 1995, 2000 Justin T. Gibbs. All rights reserved.
Copyright (c) 2006-2008 Chelsio, Inc. All rights reserved.
Copyright (C) 1999 by Kaz Kojima & Niibe Yutaka
Copyright (c) 2001 Vojtech Pavlik
Copyright (C) 2019 GRATE-DRIVER project
Copyright (C) Linus Torvalds, 2005
Copyright (C) 2013 Kuninori Morimoto <kuninori.morimoto.gx@renesas.com>
Copyright (C) 2018 Axentia Technologies AB
Copyright (C) 2015 John Crispin <john@phrozen.org>
Copyright (c) 2015 Linaro Ltd.
Copyright (c) 2017 Redpine Signals Inc.
Copyright(c) 2018 Intel Corporation.
Copyright (C) 2009-2011, Frederic Weisbecker <fweisbec@gmail.com>
Copyright (C) 2012 - 2013 Samsung Electronics Co., Ltd.
Copyright (C) 2009, 2010 Red Hat Inc, Steven Rostedt <srstedt@redhat.com>
Copyright (c) 2005, 2006, 2007, 2008 Mellanox Technologies. All rights reserved.
Copyright (C) 2008 Secret Lab Technologies Ltd.
Copyright (C) 2018 BayLibre, SAS Author: Maxime Jourdan <mjourdan@baylibre.com>
Copyright 2007 David Gibson, IBM Corporation.
Copyright 2007 Red Hat, Inc.
Copyright 2005 Stephane Marchesin. All Rights Reserved.
Copyright (C) 2009, 2010 David S. Miller <davem@davemloft.net>
Copyright (C) 2009 Atsushi Nemoto;(C) Copyright TOSHIBA CORPORATION 2004-2006
Copyright (C) 2016 Linaro Ltd <ard.biesheuvel@linaro.org>
Copyright (C) 2011-2019 B.A.T.M.A.N. contributors:
Copyright (C) 2009-2016 John Crispin <blogic@openwrt.org>
Copyright (C) 1989, 92-98, 1999 Free Software Foundation, Inc.
Copyright (C) IBM 2005 Author: Mark Nutter <mnutter@us.ibm.com>
Copyright (C) STMicroelectronics SA 2013 Author: Hugues Fruchet <hugues.fruchet@st.com> for STMicroelectronics.
Copyright (C) 2015 Dmitry Eremin-Solenikov
Copyright (C) 2000 David A. Schleef <ds@schleef.org>
Copyright (c) 2011-2012, NVIDIA CORPORATION. All rights reserved. Author: Laxman dewangan <ldewangan@nvidia.com>
Copyright (C) 2009-2011 Texas Instruments, Inc.
Copyright (C) 1997 Andi Kleen Based on ideas by D.J.Bernstein and Eric Schenk.
Copyright (C) 1997,1998,1999 Free Software Foundation, Inc. This file is part of the GNU C Library. Contributed by Richard Henderson (rth@cygnus.com), Jakub Jelinek (jj@ultra.linux.cz) and David S. Miller (davem@redhat.com).
Copyright (c) 2002, 2003, 2004, 2005, 2006, 2007, 2008, 2009 Phillip Lougher <phillip@squashfs.org.uk>
Copyright (c) 2014, Linaro Limited Author: Linus Walleij <linus.walleij@linaro.org>
Copyright (C) 2005 Ludovico Cavedon <cavedon@sss.it> Markus Rechberger <mrechberger@gmail.com> Mauro Carvalho Chehab <mchehab@kernel.org> Sascha Sommer <saschasommer@freenet.de>
Copyright (c) 2017 Yotam Gigi <yotamg@mellanox.com>
Copyright (C) 2001 by Jiun-Jie Huang <huangjj@genesyslogic.com.tw>
Copyright (C) 2012 Carsten Emde <C.Emde@osadl.org>
Copyright (c) 2018 Inventec Corporation dts-v1/;
Copyright (C) 2000,2012 MIPS Technologies, Inc. All rights reserved. Carsten Langgaard <carstenl@mips.com> Steven J. Hill <sjhill@mips.com>
Copyright (C) 2007-2014 Silicon Graphics, Inc. All rights reserved.
Copyright 2001, 2003-2005 MontaVista Software Inc. Author: MontaVista Software, Inc. ahennesy@mvista.com source@mvista.com
Copyright (c) 2012 Samsung Electronics Co., Ltd. <http://www.samsung.com/>;(C) 2001 Andreas Gruenbacher, <a.gruenbacher@computer.org>
Copyright (C) 2000-2001 Deep Blue Solutions

LICENCE TERMS (cont.)

Copyright (c) 2013 Peter Meerwald <pmeerw@pmeerw.net>
Copyright (C) 2017 Axentia Technologies AB
Copyright (C) 2016-2017 Zodiac Inflight Innovations
Copyright (c) 2014-2016 Christoph Hellwig.
Copyright (c) 2018 Maciej W. Rozycki
Copyright (C) 2000 - 2001 by Kanoj Sarcar (kanoj@sgi.com)
Copyright (C) 2001, 2002, 2003 Broadcom Corporation
Copyright (C) 1996-2000 Russell King.
Copyright (C) 2001,2002 Richard Russon <ldm@flatcap.org>
Copyright (C) 2007 Inaky Perez-Gonzalez <inaky@linux.intel.com> Intel Corporation
Copyright (c) 2015-2016 MediaTek Inc. Author: Houlong Wei <houlong.wei@mediatek.com> Ming Hsiu Tsai <minghsiu.tsai@mediatek.com>
Copyright (C) 2010 Cisco Systems Inc. <dediao@cisco.com>
Copyright (C) 2006 David Gibson, IBM Corporation.
Copyright (c) 2018 BayLibre, SAS. Author: Neil Armstrong <narmstrong@baylibre.com>
Copyright 2004 Arcom Control Systems
Copyright (C) 2010, Intel Corp. Author: Huang Ying <ying.huang@intel.com>
Copyright (C) 2008 Nokia Corporation Author: Tomi Valkeinen <tomi.valkeinen@nokia.com>
Copyright (c) 2011 Samsung Electronics Co., Ltd. http://www.samsung.com/
Copyright IBM Corp. 2013 Author(s): Ralf Hoppe (rhoppe@de.ibm.com)
Copyright (c) Ian Molton 2004, 2005, 2008 Original work, independent of sharps code. Included hardware ECC support. Hard ECC did not work for writes in the early revisions.
Copyright (c) 2012 Savoir-faire Linux Inc. Vivien Didelot <vivien.didelot@savoirfairelinux.com>
Copyright (C) STMicroelectronics SA 2017
Copyright (C) 2013-2014 Altera Corporation
Copyright (C) 2013 Intel Corporation
Copyright (c) Tomasz Duszynski <tduszyns@gmail.com>
Copyright (C) 2014-2016 Freescale Semiconductor, Inc. Author: German Rivera <German.Rivera@freescale.com>
Copyright (C) 2006 Atsushi Nemoto <anemo@mba.ocn.ne.jp>
Copyright (C) 2011-2012 John Crispin <john@phrozen.org>
Copyright 2016 Linaro Ltd
(C) Copyright 2014 Valentin Longchamp, Keymile AG, valentin.longchamp@keymile.com
Copyright (C) 2004-2005 ARM Ltd.
Copyright (C) 2014 Joachim Eastwood <manabian@gmail.com>
Copyright (C) 2013 Red Hat Author: Rob Clark <robdclark@gmail.com>
Copyright 2007 Wolfson Microelectronics PLC
Copyright (C) 2001-2002 Marcel Holtmann <marcel@holtmann.org>
Copyright (C) 2012 Thomas Petazzoni
Copyright (c) 2017, Applied Micro Circuits Corporation Author(s): Iyappan Subramanian <isubramanian@apm.com> Keyur Chudgar <kchudgar@apm.com>
Copyright (c) 1994 John Aycock The University of Calgary Department of Computer Science.
Copyright (c) 2009 Tobias Doerffel <tobias.doerffel@gmail.com>
Copyright (c) 2018 Fuzhou Rockchip Electronics Co., Ltd
Copyright (c) 1993, 1994 Motorola Inc. All rights reserved.
Copyright (C) 2018 MediaTek Inc. Author: Wenzhen Yu <Wenzhen Yu@mediatek.com> Ryder Lee <ryder.lee@mediatek.com>
Copyright 2015-2017 Lothar Waßmann <LW@KARO-electronics.de>
Copyright (c) 2013 Johannes Berg <johannes@sipsolutions.net>
Copyright 2013-2015, Michael Ellerman, IBM Corp.
Copyright (C) 2016 Synopsys
Copyright (C) 2013 Renesas Electronics, Inc.
Copyright (C) 2016-2019 GRATE-DRIVER project
Copyright (c) 2018 Cumulus Networks. All rights reserved.
Copyright (C) 2010 One Laptop per Child
Copyright (C) 2014 Alexandre Belloni <alexandre.belloni@free-electrons.com>
Copyright (c) 2010, ST-Ericsson Author: Dmitry Tarnyagin <dmitry.tarnyagin@lockless.no>
Copyright IBM Corp. 2004, 2009 character device driver for reading z/VM system service records, Version 1.0

Author(s): Xenia Tkatschow <xenia@us.ibm.com> Stefan Weinhuber <wein@de.ibm.com>;(C) 2004 IBM Corporation by Xenia Tkatschow (xenia@us.ibm.com)\n" Stefan Weinhuber (wein@de.ibm.com)"); MODULE_DESCRIPTION ("Character device driver for reading z/VM " system service records.");
Copyright (c) 2009 Tim Blechmann <tim@klingt.org>
Copyright (C) 2011 Novell Inc.
Copyright 2008 GE Intelligent Platforms Embedded Systems, Inc.
Copyright 2017 Broadcom. All Rights Reserved. The term "Broadcom" refers to Broadcom Limited and/or its subsidiaries.
Copyright (C) 1992 Linus Torvalds
Copyright (c) 2007 University of Aberdeen, Scotland, UK
Copyright (c) 2003 by Karsten Wiese <annabellesgarden@yahoo.de>
Copyright (c) 2013-2014 Freescale Semiconductor, Inc
Copyright (c) 2007-2014 Nicira, Inc.
Copyright (C) 2013 Samsung Electronics Co., Ltd. Author: Jingoo Han <jg1.han@samsung.com>
Copyright (C) 1995 Linus Torvalds Adapted from 'alpha' version by Gary Thomas Modified by Cort Dougan (cort@cs.nmt.edu)
Copyright (c) 2000 Jaroslav Kysela <perex@perex.cz>
Copyright (C) 1994 - 1999, 2000, 03 Ralf Baechle
Copyright (c) 2003-2004 Simtec Electronics Ben Dooks <ben@simtec.co.uk>
Copyright (c) 2002 by Takashi Iwai <tiwai@suse.de>, Clemens Ladisch <clemens@ladisch.de>
Copyright (C) 2000 Frank Mori Hess <fmhess@users.sourceforge.net>
Copyright (c) 2015 Qualcomm Atheros Inc.
Copyright (c) 2009-2011 Atheros Communications Inc.
(C) Copyright 2011, Greg Ungerer <gerg@uclinux.org>
Copyright (C) 2006 Alan Nisota (alannisota@gmail.com)
Copyright (c) 2018 Linaro Ltd.
Copyright 2015 Savoir-faire Linux
Copyright (C) 2016 Spencer E. Olson <olsonse@umich.edu>
Copyright (C) 2015 EMC Corporation. All Rights Reserved.
Copyright (C) 2011-2012 by Broadcom Corporation
Copyright (C) 2018 The Linux Foundation. All rights reserved.
Copyright (c) 2011-2018 Magewell Electronics Co., Ltd. (Nanjing) All rights reserved. Author: Yong Deng <yong.deng@magewell.com>
Copyright 2000 VA Linux Systems, Inc., Sunnyvale, California. All Rights Reserved.
Copyright (C) 2016 MediaTek Inc.
Copyright (c) 2010 Intel Corporation
(C) Copyright 2000-2005, Greg Ungerer (gerg@snapgear.com)
Copyright (C) 2013 Oracle, Inc.
Copyright 2000 Silicon Graphics, Inc.
Copyright 1994, Tom Zerucha. tz@execpc.com
Copyright (C) 2011 Richard Weinberger <richrd@nod.at>
Copyright (C) 2011 Linaro Limited
Copyright (c) 2013-2018 Cirrus Logic, Inc. and Cirrus Logic International Semiconductor Ltd.
Copyright (c) 2019 Facebook define STACK_MAX_LEN 50 include "pyperf.h"
Copyright (c) 2010-2012 Kontron Europe GmbH Author: Michael Brunner <michael.brunner@kontron.com>
Copyright (c) 2006 American Microsystems Limited David Anders <danders@amltd.com>
Copyright 2019 IBM Corp. include <linux/sched/mm.h> include "trace.h" include "ocxl_internal.h"
Copyright (c) 2012 Lucas Stach <dev@lynxeye.de>
Copyright Altera Corporation (C) 2013. All rights reserved
Copyright (C) 2003, 2006 David S. Miller (davem@davemloft.net)
Copyright (C) 2009 Red Hat, Matthew Garrett <mjg@redhat.com>
Copyright (c) 2007 Igor Mammedov
Copyright 1993, Drew Eckhardt Visionary Computing Unix and Linux consulting and custom programming) drew@Colorado.EDU 1 (303) 786-7975
Copyright 2014 Linaro Ltd.
Copyright IBM Corporation, 2018
Copyright (C) 2013 Oskar Andero <oskar.andero@gmail.com>

LICENCE TERMS (cont.)

Copyright (c) 2014 - 2017 Jes Sorensen <Jes.Sorensen@gmail.com>
Copyright 2009-2010 Creative Product Design Marc Reilly marc@cpdesign.com.au
Copyright (C) 2010 Gabor Juhos <juhosg@openwrt.org>
Copyright (C) 2000, 2001, 2004 MIPS Technologies, Inc.
Copyright (C) 2013,2016 Samsung Electronics Co., Ltd. Author: Sylwester Nawrocki <s.nawrocki@samsung.com>
Copyright (C) 2002 Intrinsyc, Inc. (Frank Becker)
Copyright (C) 2011, Red Hat Inc, Arnaldo Carvalho de Melo <acme@redhat.com>
Copyright 1996 Erik Stahlman Released under terms of the GNU General Public License.
Copyright (C) 2011 Mika Westerberg
Copyright (C) 2014 Alexander Shiyan <shc_work@mail.ru>
Copyright (C) 2017 Linaro Ltd.
Copyright (C) 2010 Red Hat, Inc.
Copyright (C) 2012-2017 Hideep, Inc.
Copyright (C) 2013 Linaro Ltd <ard.biesheuvel@linaro.org>
Copyright (C) 2019 Linaro Ltd.
Copyright (C) 1999 Silicon Graphics, Inc. - Jeffrey Newquist
(c) 2001-04 Gerd Knorr <kraxel@bytesex.org> [SuSE Labs]
copyright.xml (1572 bytes, from 2018-07-03 19:37:13) home/robclark/src/envytools/rnndb/mdp/mdp4.xml (20915 bytes, from 2018-07-03 19:37:13) home/robclark/src/envytools/rnndb/mdp/mdp_common.xml (2849 bytes, from 2018-07-03 19:37:13) home/robclark/src/envytools/rnndb/m
Copyright 2005-2009 MontaVista Software, Inc.
"Copyright (C) 2007 Yoichi Yuasa <yuasa@linux-mips.org>"
Copyright 2003-2011 NetLogic Microsystems, Inc. (NetLogic). All rights reserved.
Copyright(c) 2005 - 2014 Intel Corporation. All rights reserved.
Copyright (C) 2009 Andy Walls <awalls@md.metrocast.net>
Copyright (C) 2008 Michael Krufky <mkrufky@linuxtv.org>
Copyright (C) 2016 National Instruments Corp.
Copyright (C) 2009 Zhang Rui <rui.zhang@intel.com>
© Luis Sánchez (jsanchezv@teleline.es) Status: untested
Copyright (c) 2014 Qualcomm Atheros, Inc.
Copyright (C) 2018 Facebook
Copyright (C) 2006 Kristian Hoegsberg <krh@bitplanet.net>
Copyright (c) 2015-2016 Quantenna Communications. All rights reserved.
Copyright (c) 2015 HiSilicon Technologies Co., Ltd.
Copyright (C) 2001-2005 by Thomas Winischhofer, Vienna, Austria
Copyright (C) 2017, Intel Corporation
Copyright (C) 2016 Marvell Technology Group Ltd.
Copyright (c) 2016-2019 Cirrus Logic, Inc. and Cirrus Logic International Semiconductor Ltd.
Copyright(c) 2002-2010 Exar Corp.
Copyright (C) 2017, Intel Corporation Author: Mika Westerberg <mika.westerberg@linux.intel.com>
Copyright (C) 2012 Kevin Cernekee <cernekee@gmail.com>
Copyright (C) 2016 Endless Mobile, Inc. Author: Carlo Caione <carlo@endlessm.com>
Copyright 2008 IBM Corp.
Copyright (c) 2012, Metasoft s.c. Rafal Prylowski <prylowski@metasoft.pl>
Copyright 2004-2014 Freescale Semiconductor, Inc. All Rights Reserved.
Copyright 2014 Laurent Pinchart
Copyright (c) 2014 Cambridge Silicon Radio Limited, a CSR plc group company.
Copyright (c) 2012-2013 Vyatta Inc.
Copyright (c) 2012, NVIDIA CORPORATION. All rights reserved. Author: Venu Byravarasu <vbyravarasu@nvidia.com>
Copyright (C) 2008-2009 ST-Ericsson AB TCM memory handling for ARM systems
Copyright (c) 2014-2016, Intel Corporation.
Copyright (C) 2015 Google, Inc.
Copyright (c) 2013 Broadcom Corporation
Copyright (c) 2015 Samsung Electronics Co., Ltd. Author: Andrey Ryabinin <ryabinin.a.a@gmail.com>
Copyright (C) 2006 Hans Verkuil <hverkuil@xs4all.nl>
Copyright 2012 Nouveau Community

Copyright IBM Corp. 2012 Author(s): Michael Holzheu <holzheu@linux.vnet.ibm.com>
Copyright © 2015 Broadcom
Copyright (C) 2010-2011 Michael Hennerich, Analog Devices Inc.
Copyright 2018 Lukasz Majewski, DENX Software Engineering, lukma@denx.de
Copyright (c) 2017 VMware
Copyright (C) 2005 Nokia Corporation Author: Paul Mundt <paul.mundt@nokia.com>
Copyright (C) 2012 Altera Corporation
Copyright (C) International Business Machines Corp., 2000-2002
Copyright (C) 2006-2008, LINBIT Information Technologies GmbH.
Copyright (c) 2002-2004, Jouni Malinen <jkmaline@cc.hut.fi>
Copyright (C) 2005-2018 Andes Technology Corporation */
Copyright (c) 2015 Herbert Xu <herbert@gondor.apana.org.au>
Copyright (c) 2011-2014, Intel Corporation.
Copyright (c) 2003-2012 Broadcom Corporation All Rights Reserved
Copyright 2014 Linaro Limited Author: Matt Porter <mporter@linaro.org>
Copyright (c) 2012 Ondrej Zary <linux@rainbow-software.org>
Copyright (c) 2014 The Linux Foundation. All rights reserved.
(C) Copyright 2009 Intel Corporation Author: Jacob Pan (jacob.jun.pan@intel.com)
Copyright (C) 1997-2002 Russell King
Copyright (C) 2010 Texas Instruments
Copyright (C) IBM Corporation, 2017
(c) Copyright Red Hat Inc 2002
Copyright (C) Intel Corporation, 2005
Copyright (C) 2011 Nokia Corporation
Copyright © 1993, 1994 Motorola Inc. All rights reserved.
Copyright (C) 2013 Lubomir Rintel <lkundrak@v3.sk>
Copyright (c) 2016 Samsung Electronics Co., Ltd. http://www.samsung.com
Copyright (C) 2008 Renesas Solutions
Copyright (C) 2010 ARM Ltd. Written by Catalin Marinas <catalin.marinas@arm.com>
Copyright (c) 2018-2019 Synopsys, Inc. and/or its affiliates. Synopsys DesignWare eDMA core driver
Copyright (C) 2018 ARM Limited
Copyright (c) 2001 Paul Stewart
(C) 2002, 2003 Marc Zyngier <maz@wild-wind.fr.eu.org>
Copyright (C) 1996 Linus Torvalds & author (see below)
Copyright 2015 VMware, Inc., Palo Alto, CA., USA
Copyright (c) by Jaroslav Kysela <perex@perex.cz> Creative Labs, Inc. Routines for IRQ control of EMU10K1 chips
(c) 1998 Gerd Knorr <kraxel@cs.tu-berlin.de> Modified for the ALSA driver by Jaroslav Kysela <perex@perex.cz>
Copyright IBM Corp. 2008, 2011
Copyright (C) 2010 Nouveau Project
Copyright (C) 2007 Jeff Dike (jdike@addtoit.linux.intel.com)
Copyright 2005 Wolfson Microelectronics PLC. Author: Graeme Gregory.gregory@wolfsonmicro.com or linux@wolfsonmicro.com
Copyright (C) 2016 PHYTEC Messtechnik GmbH Author: Christian Hemp <c.hemp@phytec.de>
Copyright (C) 1992 Lawrence Foard
Copyright (C) 2012 Texas Instruments Paul Walmsley
Copyright (c) 2009, 2011 Wolfgang Grandegger <wg@grandegger.com>
Copyright (c) 2011 Patrick McHardy <kaber@trash.net>
Copyright (c) 2013 Hardkernel Co., Ltd. http://www.hardkernel.com
Copyright (c) 2000-2006 Silicon Graphics, Inc.
Copyright (C) 1998 Andrew Veliath
Copyright (C) 2014 Texas Instruments Incorporated
Copyright (C) 1998 Carnegie Mellon University
Copyright (C) 2013 Ezequiel Garcia <ezequiel@free-electrons.com>
Copyright (c) 2002, 2003, 2013 Maciej W. Rozycki
Copyright (c) 2018 - Bootlin
Copyright (C) 2018 HUAWEI, Inc. http://www.huawei.com/ Created by Gao Xiang <gaoxiang25@huawei.com>
Copyright: 2017 Cadence Design Systems, Inc.

LICENCE TERMS (cont.)

Copyright (C) 2019 Linaro, Ltd. <ard.biesheuvel@linaro.org>
Copyright (C) 2013 Renesas Corporation
Copyright (C) 2006, NXP Semiconductors, All Rights Reserved Author: Jean-Paul Saman <jean-paul.saman@nxp.com>
Copyright (c) 2002,2003 by Takashi Iwai <tiwai@suse.de>
Copyright (c) 2002 The Regents of the University of Michigan. All rights reserved.
Copyright 2014 Oleksij Rempel <linux@rempel-privat.de>
Copyright © 2010 ST Microelectronics Vipin Kumar <vipin.kumar@st.com> Ashish Priyadarshi
Copyright (C) 2006-2008 WIZnet Co.,Ltd.
Copyright (c) 2018 Microsemi Corporation
Copyright 2007, Frank A Kingswood <frank@kingswood-consulting.co.uk>
Copyright (C) 2014-2015 Broadcom
Copyright (C) 2006 Philips Semiconductors
Copyright (C) 2008-2011 Nokia Corporation
Copyright (C) 2011-2012 International Business Machines Inc.
Copyright (C) 2014 Chen-Zhi (Roger Chen)
Copyright 2017 Lothar Waßmann <LW@KARO-electronics.de>
Copyright (C) 2006 Jim Cromie
Copyright (C) 2015 Citrix Systems R&D Ltd.
Copyright (C) 1994, 1995 Waldorf Electronics Written by Ralf Baechele and Andreas Busse
Copyright (C) 2017 Sean Wang <sean.wang@mediatek.com>
Copyright (C) 2007 Cambridge Silicon Radio Ltd.
Copyright (C) 2009 - 2010 Paul Mundt
Copyright: (C) 2012, 2015 Julia Lawall, INRIA.
(c) Deep Root Systems, LLC.
Copyright (c) 2017 MediaTek Inc. Author: Weiyi Lu <weiyi.lu@mediatek.com>
Copyright 2010 Andre B. Oliveira
Copyright (C) 2009 Michal Simek <monstr@monstr.eu>
Copyright 2011 IBM Corp.
Copyright (c) 2014 Linaro Ltd.
Copyright (c) 1998-2001 Vojtech Pavlik
Copyright 2000,2001 The Linux Kernel Team
Copyright (C) 1998, 1999, 2001 Hewlett-Packard Co
Copyright (C) 2007 AMD (http://www.amd.com) Author: Thomas Dahlmann
Copyright (C) 2013 Linaro Limited. Written by: Yi Li (yi.li@linaro.org)
Copyright (C) 2010-2012 by Dell Inc. All rights reserved.
Copyright (C) 2006-2016 Oracle Corporation
Copyright (C) 2010-2013 Mauro Carvalho Chehab
Copyright (C) 1992, 1998-2006 Linus Torvalds, Ingo Molnar
Copyright (C) 2001-2014 Yoshinori Sato <ysato@users.sourceforge.jp>;(C) 1998,1999 Kenneth Albanowski, D. Jeff Dionne
Copyright (c) 2010-2011 Atheros Communications, Inc.
Copyright (c) 2017 Sagi Grimberg.
Copyright (c) 2006-2009 Simtec Electronics http://armlinux.simtec.co.uk/ Ben Dooks <ben@simtec.co.uk>
(C) 2002-2003 Nadia Yvette Chambers, IBM;(C) 2004 Nadia Yvette Chambers, Oracle;(C) 2002-2004 Ingo Molnar, Red Hat;(C) 2007 Pavel Emelyanov <xemul@openvz.org>, OpenVZ, SWsoft Inc.;(C) 2007 Sukadev Bhattiprolu <sukadev@us.ibm.com>, IBM Many thanks to Oleg Nesterov for comments and help
Copyright (C) 2011 Jan Weitzel
Copyright © 2006-2016 Intel Corporation
Copyright (C) 2005-2006 by Texas Instruments
Copyright (c) 1999-2014 Tensilica Inc.
Copyright (C) 2009 Phil Sutter <n0-1@freewrt.org>
Copyright (c) 2004 Mark M. Hoffman <mhoffman@lightlink.com>
Copyright (C) 2011-2015 Daniel Schwierzeck <daniel.schwierzeck@gmail.com>
Copyright (C) 2001 WireX Communications, Inc <chris@wirex.com>
Copyright (C) 2015, Marvell International Ltd.
Copyright (C) 2012 Lothar Felten <lothar.felten@gmail.com>

Copyright (c) 2013-2016, The Linux Foundation. All rights reserved.
"Copyright (C) 2005 Yoichi Yuasa <yuasa@linux-mips.org>"
Copyright (c) 2002, Trond Myklebust <trond.myklebust@fys.uio.no>
Copyright (C) 2013 Linaro Limited
Copyright (C) 2016-2017 Intel Corporation
Copyright (C) 2017 Etnaviv Project
(C) Copyright IBM 2012v2
Copyright (c) 2014 MediaTek Inc. Author: Shunli Wang <shunli.wang@mediatek.com>
Copyright (C) 2012-2014 Mentor Graphics Inc.
Copyright (C) 05/1998 Peter Maydell <pmaydell@chiark.greenend.org.uk> Based on the Sun Lance driver and the NetBSD HP Lance driver
Copyright (C) 2012 Red Hat
(c) 2015, Quentin Casasnovas <quentin.casasnovas@oracle.com>
Copyright (C) 2011-2012 Gabor Juhos <juhosg@openwrt.org>
Copyright 2007 Freescale Semiconductor, Inc. Author: Scott Wood <scottwood@freescale.com>
Copyright (C) 2017 Renesas Electronics Corp.
Copyright (C) 2006,2007 Thomas Bogendoerfer (tsbogend@alpha.franken.de)
Copyright (C) 2013 Jean-Jacques Hiblot <jhiblot@traphandler.com>
Copyright © 2014-2018 Intel Corporation
Copyright (c) 2015-2017 Takashi Sakamoto
(C) Copyright IBM Deutschland Entwicklung GmbH 2005
Copyright (c) 1998 - 2002 Frodo Looijaard <frodo@dds.nl> and Philip Edelbrock <phil@netroedge.com>
(c) 2005 Patrick McHardy <kaber@trash.net>
Copyright (C) 2013,2014 Samsung Electronics
Copyright (C) 2007-2008 Yan Burman
Copyright (C) 2013-2015 Ideas on Board
Copyright 2011-2016 Freescale Semiconductor Inc.
Copyright 2012 Wolfson Microelectronics
Copyright (C) 2013 Steven Liu <steven_liu@mediatek.com>
Copyright (c) 2009-2011 Manuel Lauss <manuel.lauss@gmail.com>
(c) 1997 M. Kirkwood;(c) 1998 Petr Vandrovec, vandrove@vc.cvut.cz
Copyright (c) 2008 Applied Micro Circuits Corporation. All rights reserved. James Hsiao <jhsiao@amcc.com>
"Copyright: (C) 2003 Monta Vista Software, Inc."
Copyright (c) 2012 Texas Instruments, Inc
Copyright 2010 Wolfson Microelectronics plc
Copyright (C) 2015 Regents of the University of California
Copyright (C) 2009 Intel Corporation. Author: Patrick Ohly <patrick.ohly@intel.com>
Copyright 2013 Gateworks Corporation
Copyright (C) 1998 Phil Blundell
Copyright (C) 2009-2011 Motorola, Inc.
Copyright (C) 2004-2005, IBM Corp.
Copyright (c) 2004 Anton Altaparmakov
Copyright 2010 Cisco Systems, Inc. All rights reserved.
Copyright (C) 2017 Narcisa Vasile <narcisaanamaria12@gmail.com>
Copyright (C) ST Ericsson SA 2011
(C) 2003 - 2004 Dominik Brodowski <linux@dominikbrodowski.de>
Copyright (C) 2013-2014 Texas Instruments Incorporated - http://www.ti.com
Copyright (c) 2006 Simtec Electronics Ben Dooks <ben@simtec.co.uk>
Copyright (c) 1998 by Jaroslav Kysela <perex@perex.cz>
Copyright (C) 2018 Intel Corporation Author: Rafael J. Wysocki <rafael.j.wysocki@intel.com>
Copyright (C) 2008 Paul Mundt
Copyright (c) 2018 Google, Inc. Author: Andrey Konovalov <andreyknvl@google.com>
Copyright (C) 2016 Amarula Solutions B.V.
Copyright (C) 2006 Intel Corp. Tom Long Nguyen (tom.l.nguyen@intel.com) Zhang Yanmin (yanmin.zhang@intel.com)
Copyright (C) 2007, 2008 Karsten Wiese <fzu@wemgehoertderstaat.de>
Copyright (c) 2006 Moxa Technologies Co., Ltd.

LICENCE TERMS (cont.)

Copyright (C) 2003-2013 Altera Corporation All rights reserved.
Copyright (C) 2000 Markus Kempf <kempf@matsci.uni-sb.de> with suggestions from David Schleef 16.06.2000
(C) 2001 Clemson University and The University of Chicago
Copyright 1993-2004 Jürgen E. Fischer
Copyright (C) 2014 MEN Mikroelektronik GmbH (www.men.de) Author: Andreas Werner <andreas.werner@men.de>
Copyright 2002 Hewlett-Packard Company
Copyright (c) 2003 Jim Hague (jim.hague@acm.org)
Copyright © 1999-2010 David Woodhouse <dwmw2@infradead.org>
Copyright (c) 2015 Cambridge Silicon Radio Limited, a CSR plc group company.
Copyright (c) 2012 Hans de Goede <hdegoede@redhat.com>
Copyright(c) 2009 Ian Molton <spyro@f2s.com>
Copyright (C) 2015 Srinivas Kandagatla <srinivas.kandagatla@linaro.org>
Copyright(c) 2015 Broadcom Corporation. All rights reserved.
Copyright (c) 2014 PLUMgrid, http://plumgrid.com
Copyright (C) 1991, 1992, 1993 Linus Torvalds
(c) Copyright Hewlett-Packard Development Company, L.P., 2006 - 2008
Copyright (C) 2005-2007 Ulrich Kunitz <kune@deine-taler.de>
Copyright (C) 2011 Antti Palosaari <crope@iki.fi>
Copyright(c) 2006 Tundra Semiconductor Corporation.
Copyright © 2017-2018 Intel Corporation
Copyright 2005 Simtec Electronics
Copyright: (C) 2012 Nicolas Palix.
Copyright (c) 2010-2012 Broadcom. All rights reserved.
Copyright(c) 2016 - 2018 Intel Corporation.
Copyright (C) 1999 MIPS Technologies, Inc. All rights reserved. Author: Carsten Langgaard, carstenl@mips.com
Copyright (C) 2013 Renesas Electronics Inc. Author: Guennadi Liakhovetski <g.liakhovetski@gmx.de>;(c) container_of(c, struct shdma_chan, dma_chan)
Copyright(c) 1999 - 2004 Intel Corporation. All rights reserved.
Copyright Alistair Poppo, IBM Corporation 2014.
Copyright (C) 1996 Olaf Kirch, <okir@monad.swb.de>;(C) 1999 Dave Airlie, University of Limerick, Ireland <airlied@linux.ie>
Copyright (C) 2014-2015 Texas Instruments, Inc.
Copyright (C) 2015-2016 Texas Instruments Incorporated - http://www.ti.com/ Nishanth Menon
Copyright (c) 2016 by Detlef Urban (onkel@paraair.de)
Copyright 2016 Chen-Yu Tsai <wens@csie.org>
Copyright (C) STMicroelectronics 2018 - All Rights Reserved Author: Gabriel Fernandez <gabriel.fernandez@st.com> for STMicroelectronics.
Copyright 2018 SiFive, Inc.
Copyright (C) 2013 Samsung Electronics Co., Ltd. Sylwester Nawrocki <s.nawrocki@samsung.com>
Copyright (c) 2013-2015, Mellanox Technologies, Ltd. All rights reserved.
Copyright (C) 2006 Intel Corp.
Copyright (C) 2003 - 2005 Tensilica Inc.
Copyright (C) 2015-2016 Freescale Semiconductor, Inc. All Rights Reserved.
Copyright (c) 2017-2018 Microsoft Corporation
Copyright 1993 United States Government as represented by the Director, National Security Agency.
Copyright (c) 2018 Covalent IO, Inc. http://covalent.io undef SOCKMAP define TEST_MAP_TYPE BPF_MAP_TYPE_SOCKHASH include "/test_sockmap_kern.h"
Copyright (C) 2001 Dave Engebretsen & Todd Inglett IBM Corporation.
Copyright (C) 2013-2015 ARM Limited, All Rights Reserved. Author: Marc Zyngier <marc.zyngier@arm.com>
Copyright 2006-2010 Johannes Berg <johannes@sipsolutions.net>
Copyright (C) 2014 Red Hat, Inc. All Rights Reserved. Written by David Howells (dhowells@redhat.com)
Copyright (C) 2018 Texas Instruments Incorporated - http://www.ti.com/
Copyright (C) 2014-2018 Daktronics Author: Matt Sickler <matt.sickler@daktronics.com> Very loosely based on spi-omap2-mcspi.c
Copyright (C) 2009 Marek Vasut <marek.vasut@gmail.com>
Copyright (C) 2004-2005 Red Hat, Inc. All rights reserved.
Copyright (C) 2018 NXP.

Copyright (c) 2018, NVIDIA CORPORATION. All rights reserved. */
Copyright (C) 2011, Guennadi Liakhovetski <g.liakhovetski@gmx.de>
Copyright (c) 2010-2011 EIA Electronics, Kurt Van Dijk <kurt.van.dijk@eia.be>
Copyright (C) 2019 Oceanic Systems (UK) Ltd.
Copyright (C) 2015-2017 Pengutronix, Uwe Kleine-König <kernel@pengutronix.de>
Copyright (C) 2015 Renesas Electronics Corp.
Copyright (C) 1994-2002 Russell King
Copyright (C) 2012 Texas Instruments Incorporated - http://www.ti.com
Copyright 2009-2013 Solarflare Communications Inc.
(c) Copyright 2002 Zwane Mwaikambo <zwane@commfreservices.com>, All Rights Reserved.
Copyright 2006-2011 Solarflare Communications Inc.
Copyright 2018, Red Hat, Inc. and/or its affiliates.
Copyright(c) 2016 - 2018 Intel Corporation. All rights reserved.
Copyright (C) 2018 Rockchip Electronics Co., Ltd.
Copyright (C) 2015 Karol Kosik <karo9@interia.eu>
Copyright (C) 2001 Russell King;(C) 2003 Venkatesh Pallipadi <venkatesh.pallipadi@intel.com>. Jun Nakajima <jun.nakajima@intel.com>
Copyright (C) 2006-2013 Texas Instruments.
Copyright (C) 2016, Intel Corporation Author: Rafael J. Wysocki <rafael.j.wysocki@intel.com>
Copyright 2004 Andi Kleen, SuSE Labs.
Copyright (c) 2002-2007 Sam Leffler, Errno Consulting All rights reserved.
Copyright (c) 2013-2015, Intel Corporation.
Copyright (c) 2014 Nicira, Inc.
Copyright (C) 2006-2008 David Brownell;(c) presumably a wireless_ep wrapping a usb_ep, and reporting wireless-specific parameters like maxburst and maxsequence; d) configurations that are specific to wireless links; e) function drivers that understand wireless configs and will support wireless for (additional) funct
Copyright 2015 Realtek Semiconductor Corp. Author: Oder Chiou <oder_chiou@realtek.com>
Copyright 2012-2015 Cisco Systems, Inc. and/or its affiliates. All rights reserved.
Copyright (C) 1999 Anders Blomdell <anders.blomdell@control.lth.se>
Copyright (C) 1999 AbsoluteValue Systems, Inc. All Rights Reserved.
Copyright (C) 2012, 2016 Red Hat, Inc. All Rights Reserved. Written by David Howells (dhowells@redhat.com)
Copyright (c) 2016-2017 Marcel Hasler <mahasler@gmail.com>
Copyright: (C) 2016 Linaro Limited
Copyright (c) 2016 Chelsio Communications, Inc.
Copyright (C) 2016 Russell King
Copyright 2017-2018 Sean Wang <sean.wang@mediatek.com>
Copyright (C) 2015, Intel Corporation Authors: Lv Zheng <lv.zheng@intel.com>
Copyright (C) 2014 Paradox Innovation Ltd.
Copyright (C) 2014-2015, Intel Corporation
Copyright (C) 2005 Arcom Control Systems Ltd.
Copyright 2018-2020 NXP
Copyright (C) 2001-2002 Sistina Software (UK) Limited.
Copyright (c) 2004-2005 Silicon Graphics, Inc. All Rights Reserved.
Copyright (c) 2000-2003,2005 Silicon Graphics, Inc.
Copyright (C) 2001 Russell King
Copyright (C) 2012-2017 Red Hat, Inc.
Copyright (C) 2001 - 2002 Ganesh Varadarajan <ganesh@veritas.com>
Copyright (c) 2014, Fuzhou Rockchip Electronics Co., Ltd Author: Tony Xie <tony.xie@rock-chips.com>
Copyright (C) 2016 TQ Systems GmbH Author: Markus Niebel <Markus.Niebel@tq-group.com>
Copyright (C) 2019 Martin Blumenstingl <martin.blumenstingl@googlemail.com>
(C) 2006 kogiidena;(C) 2002 Atom Create Engineering Co., Ltd.
Copyright (C) 1992 Drew Eckhardt
Copyright 2017 STMicroelectronics Inc.
Copyright (c) 2007 Herbert Xu <herbert@gondor.apana.org.au>
Copyright (C) 2017 Intel Corporation
Copyright 2012 Analog Devices Inc. Author: Lars-Peter Clausen <lars@metafoo.de>
Copyright (C) 2013 - ARM Ltd Author: Marc Zyngier <marc.zyngier@arm.com>

LICENCE TERMS (cont.)

Copyright 2015 Cirrus Logic, Inc.
Copyright IBM Corp. 1999 Author(s): Hartmut Penner (hp@de.ibm.com) Ulrich Weigand (uweigand@de.ibm.com)
Copyright (c) Henry Wang <Henry.wang@AzureWave.com>
Copyright (C) 1997 - 2000, 2003, 04 Ralf Baechle (ralf@linux-mips.org)
Copyright 2015 Hannes Reinecke
Copyright (C) 2011 Texas Instruments Inc
Copyright (C) 2008 Badari Pulavarty, IBM Corporation
Copyright(c) 2014 Intel Mobile Communications GmbH
Copyright (C) 1996, 1997, 1998, 1999, 2000, Ingo Molnar, Matti Aarnio, Jakub Jelinek, Richard Henderson.
Copyright (C) 2014-2018 Etnaviv Project
"Copyright (C) 1997,1998 Jakub Jelinek (jj@sunsite.mff.cuni.cz)"
Copyright (C) 2005 by David Brownell
Copyright (c) 1996-2002 Russell King.
Copyright (C) 1995-2005 Russell King
Copyright (c) 2017 BayLibre, SAS Author: Neil Armstrong <narmstrong@baylibre.com>
Copyright (C) 2004, 2007 Red Hat, Inc. All Rights Reserved. Written by David Howells (dhowells@redhat.com)
"Copyright 2006-2010 Johannes Berg <johannes@sipsolutions.net>"
Copyright (C) 2016 Bluecherry, LLC <maintainers@bluecherrydvr.com>
Copyright (c) 2015 MediaTek Inc. Author: Chunfeng Yun <chunfeng.yun@mediatek.com>
Copyright (c) 2019, Intel Corporation. */
Copyright (C) 2016, Linaro Ltd. Author: Daniel Lezcano <daniel.lezcano@linaro.org> Fu Wei <fu.wei@linaro.org>
Hanjun Guo <hanjun.guo@linaro.org>
Copyright (C) 2004-2005, 2008 Red Hat, Inc. All Rights Reserved. Written by David Howells (dhowells@redhat.com)
Copyright (C) International Business Machines Corp., 2005,2013 Author(s): Steve French (sfrench@us.ibm.com)
Copyright (C) 1999 Gerhard Wichert, Siemens AG Gerhard.Wichert@pdb.siemens.de
"Copyright (C) 2008 Rodolfo Giometti <giometti@linux.it>"
Copyright (C) 2008 ARM Limited Written by Catalin Marinas <catalin.marinas@arm.com>
Copyright (c) 2001 Brian S. Julin All rights reserved.
Copyright(c) 2003 - 2011 Intel Corporation. All rights reserved.
"Copyright (C) 2016 MediaTek Inc. Authors: Xiaolei Li <xiaolei.li@mediatek.com> Jorge Ramirez-Ortiz <jorge.ramirez-ortiz@linaro.org>"
Copyright (C) 2008 - 2009 Nokia Corporation
Copyright 2008-2013 Solarflare Communications Inc.;(c) the request times-out (in timer context)
Copyright 2007-2010 Red Hat, Inc. by Peter Jones <pjones@redhat.com>
Copyright (C) 2016 SuSE. All rights reserved.
Copyright (C) 2007, 2008 CompuLab, Ltd. Mike Rapoport <mike@compulab.co.il>
Copyright (C) 2004 Vernon Mauery <vemux@us.ibm.com>
Copyright (C) 1999 Eddie C. Dost (ecd@skynet.be)
Copyright (C) 1995 Olaf Kirch <okir@monad.swb.de>
Copyright (C) 2005-2006 Intel Corporation Inaky Perez-Gonzalez <inaky.perez-gonzalez@intel.com> Reinette Chatre <reinette.chatre@intel.com>
Copyright (c) 2012 Samsung Electronics Co., Ltd. Author: Joonyoung Shim <jy0922.shim@samsung.com>
Copyright (C) 2016-2018 Renesas Electronics Corp.
Copyright (C) 2006 Komal Shah <komal_shah802003@yahoo.com>
Copyright (C) 2018 Gateworks Corporation
Copyright (C) 2005 Sascha Hauer, Pengutronix
Copyright (c) 2015 Dialog Semiconductor
Copyright (C) 1999 David A. Hinds. All Rights Reserved.:(C) 1999 David A. Hinds
Copyright (C) 2010 Magnus Damm
Copyright (C) 1999 Geert Uytterhoeven
Copyright (C) 2007 Kristoffer Ericson <Kristoffer.Ericson@gmail.com>
Copyright (c) 2012 Jiri Pirko <jpirko@redhat.com>
Copyright (C) 2004, 2009, 2010, 2011 Texas Instruments Incorporated Author: Aurelien Jacquiot (aurelien.jacquiot@jaluna.com)
Copyright (C) 2010 Samsung Electronics Co.Ltd Author: Joonyoung Shim <jy0922.shim@samsung.com>
Copyright (C) 2013 Maxim Levitsky <maximlevitsky@gmail.com>
Copyright 2003-2004 Red Hat, Inc.

Copyright (C) 2010 Andres Salomon <dilinger@queued.net>
Copyright 2014-2015 Freescale Semiconductor, Inc. All Rights Reserved.
Copyright (C) 2019 Bootlin Author: Paul Kocikowski <paul.kocikowski@bootlin.com>
Copyright (C) 2015 Dan Streetman, IBM Corp
Copyright (C) 2005 Anthony Liguori <aliguori@us.ibm.com>
Copyright (C) 2001 by Andreas Gruenbacher <a.gruenbacher@computer.org>
Copyright (C) 1995-2001 Russell King
(C) 2012 by Hans Schillstrom <hans.schillstrom@ericsson.com>;(C) 2012 by Pablo Neira Ayuso <pablo@netfilter.org>
(c) 1999-2003 Matthew Dharm (mdharm-usb@one-eyed-alien.net);(c) 2000 David L. Brown, Jr. (usb-storage@davidb.org);(c) 2003-2009 Alan Stern (stern@rowland.harvard.edu);(c) 1999 Michael Gee (michael@linuxspecific.com);(c) 2000 Yggdrasil Computing, Inc.
Copyright (C) 2011 Samsung Electronics MyungJoo Ham <myungjoo.ham@samsung.com>
Copyright (C) 2014-2017 Axis Communications AB
Copyright (C) 2010 Google, Inc. Author: Erik Gilling <konkers@android.com>
Copyright (C) 2018 David Abdurachmanov <david.abdurachmanov@gmail.com>
Copyright (C) 2017 Red Hat Inc.
Copyright (C) 2010, 2011 Texas Instruments Incorporated Contributed by: Mark Salter (msalter@redhat.com)
Copyright (c) 2008-2012 Freescale Semiconductor, Inc All rights reserved.
Copyright (C) 2014, Intel Corporation Authors: Zhang Rui <rui.zhang@intel.com> Rafael J. Wysocki <rafael.j.wysocki@intel.com>
Copyright 2010 Google, Inc. Arve Høyenøvåg <arve@android.com> Colin Cross <ccross@android.com>
Copyright (C) 2001, 2007, 2008 David S. Miller (davem@davemloft.net)
Copyright (c) 2017 Marek Szyprowski
Copyright (C) 2004 Konrad Eisele (eiselekd@web.de, konrad@gaisler.com) Gaisler Research
Copyright (C) 2006 Russell King.
Copyright (C) 1998, 1999 Free Software Foundation, Inc.
Copyright (C) 2015-19 Renesas Electronics Corporation
Copyright (C) 2012 ST Microelectronics Vipin Kumar <vipin.kumar@st.com>
Copyright 2001 MontaVista Software Inc. Author: Jun Sun, jsun@mvista.com or jsun@junsun.net
Copyright © 2006 Intel Corporation
Copyright (C) 2008, Guennadi Liakhovetski <kernel@pengutronix.de>
Copyright: (C) 2016 Nicholas Mc Guire, OSADL. Comments: Options: --no-includes --include-headers
Copyright (C) 2007 Semihalf Marian Balakowicz <m8@semihalf.com>
Copyright (c) 2014 MediaTek Inc. Author: Howard Chen <ibanezchen@gmail.com>
Copyright (C) 2003-2004 Marcel Holtmann <marcel@holtmann.org>
Copyright (c) 2014 Realtek Semiconductor Corp. All rights reserved.
Copyright 2012-2014 Freescale Semiconductor, Inc.
Copyright (C) 2016 Broadcom
Copyright IBM Corp. 2015 Author(s): Martin Schwidefsky <schwidefsky@de.ibm.com>
Copyright (c) 2014-2017 Intel Corporation. All rights reserved.
Copyright (C) 2000-2001 Qualcomm Incorporated
Copyright 2014 Boris Brezillon
Copyright (C) 2006-2019 B.A.T.M.A.N. contributors:
Copyright (C) 2010-2011 Texas Instruments Incorporated - http://www.ti.com/
Copyright (c) 2011-2015, The Linux Foundation. All rights reserved.
Copyright (C) 2007 ARM Limited
Copyright (c) 2016 Hans de Goede <hdegoede@redhat.com>
Copyright (c) 2014 Broadcom Corporation
Copyright 2004-2005 Andrea Arcangeli <andrea@cpushare.com>
Copyright (C) 2005 Mark M. Hoffman <mhoffman@lightlink.com>
Copyright © 2009 - Maxim Levitsky Common routines & support for xD format
Copyright (C) 2001-2004 by David Brownell
Copyright (c) 1998-2003 InnoSys Incorporated. All Rights Reserved
Copyright (C) 1998-2001 Russell King
Copyright (C) 2018 Matan Ziv-Av <matan@svglib.org>
Copyright (C) 2004 Andriy Skulysh <askulysh@image.kiev.ua>

LICENCE TERMS (cont.)

Copyright (C) 2013, Intel Corporation Authors: Mika Westerberg <mika.westerberg@linux.intel.com> Rafael J. Wysocki <rafael.j.wysocki@intel.com>
Copyright (C) 2006, 2007 Motorola Inc.
Copyright (C) 2012 Texas Instruments Incorporated - <http://www.ti.com> Author: Kishon Vijay Abraham I <kishon@ti.com>
Copyright 2001-2002 MontaVista Software Inc.
Copyright (c) 2004 James Simmons <jsimmons@infradead.org>
Copyright (C) 1996-2000 Russell King
Copyright (C) 2013, Arnaud EBALARD <arno@natisbad.org>
Copyright (c) 2003 by Clemens Ladisch <clemens@ladisch.de>
Copyright 2006 Sony Corp.
(c) 2003 Gerd Knorr <krxel@bytesex.org> [SuSE Labs];(c) 2005-2006 Mauro Carvalho Chehab <mchehab@kernel.org> Multituner support video_ioctl2 conversion PAL/M fixes
Copyright 2016 Intel Corporation All Rights Reserved.
Copyright 2003-2004, Instant802 Networks, Inc.
Copyright Jonathan Naylor G4KLX (g4klx@g4klx.demon.co.uk)
Copyright (C) 2008-2009 Red Hat, Inc. All rights reserved.
Copyright 2013 Daniel Borkmann <borkmann@redhat.com>
Copyright (C) 2011 - 2013 Samsung Electronics Co., Ltd. Author: Sylwester Nawrocki <s.nawrocki@samsung.com>
Copyright (c) 1998 - 2002 Frodo Looijaard <frodo@dds.nl> and Philip Edelbrock <phil@netroedge.com> Intel SCH support
Copyright (c) 2011 Bosch Sensortec GmbH
Copyright (C) 2004, 2008 Nokia Corporation
Copyright (C) 2009 M&N Solutions GmbH, 61191 Rosbach, Germany Holger Schurig <hs4233@mail.mn-solutions.de>
Copyright (C) 2012 Texas Instruments
"Copyright (C) 2008-14 Intel Corporation Authors: Vinod Koul <vinod.koul@linux.intel.com>"
Copyright (c) by James Courtier-Dutton <James@superbug.demon.co.uk> Driver p17v chips Version: 0.01
Copyright 2012 The Nouveau community
Copyright (c) 2008 Jonathan Cameron
Copyright (C) 2010-2014 Freescale Semiconductor, Inc. All Rights Reserved.
Copyright 2001 - 2006 Tensilica Inc.
Copyright (C) 2016-2018 EPAM Systems Inc.
Copyright (c) 2017, Linaro Ltd.
Copyright 2004 IDT Inc. (rischelp@idt.com)
Copyright (C) 2009-2019 B.A.T.M.A.N. contributors:
Copyright (c) 2016-2018 Socionext Inc.
Copyright (c) 2008-2019, IBM Corporation
Copyright (C) 2008 Frank Zago
Copyright (C) 2015 CompuLab, Ltd. - <http://www.complab.co.il/>
Copyright 2014 Linaro Ltd
"Copyright: (C) 2009 Marvell Technology Group Ltd."
Copyright (C) 2014 Texas Instruments. All rights reserved.
Copyright 2012 Stanislav Yakovlev <stas.yakovlev@gmail.com>
Copyright (C) 1998-2003 Michael Hunold <michael@mihu.de>
Copyright © 2006-2010 David Woodhouse <dwmw2@infradead.org>
Copyright (c) 2012 GCT Semiconductor, Inc. All rights reserved.
Copyright (C) 2008 Red Hat, Inc., Peter Zijlstra
Copyright IBM Corp. 1999 Author(s): Hartmut Penner (hp@de.ibm.com)
Copyright (C) 2007 - 2010 Paul Mundt
Copyright 2002 MontaVista Software Inc.
Copyright (c) 2009 Clemens Ladisch <clemens@ladisch.de>
Copyright (C) 2003 Oliver Endriss
Copyright (c) 2000-2001 Christoph Hellwig. All rights reserved.
Copyright (C) 2016 Hisilicon Ltd.
Copyright (C) June 1999 James Simmons
Copyright (C) 2010 - Maxim Levitsky driver for Ricoh memstick readers

Copyright 2008 Gerhard Pircher (gerhard_pircher@gmx.net)
Copyright (C) 2015, Google, Inc.
Copyright (c) 2002 Holger Waechtler <holger@convergence.de>
Copyright (c) 2011-2013 Datera, Inc.
Copyright 2001,2002 by Andi Kleen, SuSE Labs.
Copyright: |copy| 2016-2018 NXP
Copyright (C) 2018 Lorenzo Bianconi <lorenzo.bianconi83@gmail.com>
Copyright (C) 2003, 2004 Oracle. All rights reserved.
Copyright (C) 2001 Anton Blanchard <anton@au.ibm.com>, IBM
Copyright (C) 2007 David S. Miller (davem@davemloft.net)
Copyright (C) 2016 Advanced Micro Devices, Inc. All Rights Reserved.
Copyright (C) 2000 Abramo Bagnara <abramo@alsa-project.org>
Copyright (C) IBM Corporation, 2008
Copyright IBM Corp. 2001, 2012 Author(s): Robert Burroughs Eric Rossman (edrossma@us.ibm.com)
Copyright (c) 1997-2007 Jean Tourrilhes, All Rights Reserved.
(c) 2013 Jonas Gorski <jogo@openwrt.org>;(c) 2013 Deutsche Telekom Innovation Laboratories;(c) 2014 Luka Perkov <luka@openwrt.org>;(c) 2014 Randy C. Will <randall.will@gmail.com>
Copyright (C) 2001 IBM
Copyright (c) 2011 Marvell Semiconductors Inc. All Rights Reserved
Copyright (C) 2010-2019 B.A.T.M.A.N. contributors:
Copyright (c) 2015-2016 QLogic Corporation
Copyright (C) 2016 Marek Vasut <marex@denx.de>
Copyright © 2007 Red Hat, Inc. All Rights Reserved. Written by David Howells (dhowells@redhat.com)
Copyright (C) 2015 Free Electrons
Copyright (C) 2013 Andrey Smirnov
Copyright (C) 2014 Digital Devices GmbH
Copyright (C) 2016, Intel Corporation
Copyright (c) 2014 Rockchip Electronics Co. Ltd. Author: Jianqun xu <jay.xu@rock-chips.com>
Copyright 1996 Roman Zippel
Copyright 2013 Eukréa Electromatique <denis@eukrea.com>
Copyright (C) 2014 Samsung Electronics Chanwoo Choi <cw00.choi@samsung.com> Krzysztof Kozlowski <krzk@kernel.org>
Copyright (C) 2014 Imagination Technologies Ltd.
Copyright (C) 2015 IT University of Copenhagen (rrpc.c)
Copyright (C) 2003 Herbert Valerio Riedel <hvr@gnu.org>
Copyright (C) 2008-2013 Freescale Semiconductor, Inc. All rights reserved.
Copyright 2013 CSC Australia Pty. Ltd.
(C) Copyright 2015 - 2018, Xilinx, Inc.
Copyright (c) Freescale Semicondutor, Inc. 2006. Shlomi Gridish <gridish@freescale.com> Jerry Huang <Chang-Ming.Huang@freescale.com>
Copyright(c) 2013, Intel Corporation.
Copyright 2008 - 2016 Freescale Semiconductor, Inc.
Copyright (C) 2003-2015 Broadcom Corporation All Rights Reserved
Copyright (C) 2010, Jason Baron <jbaron@redhat.com>
Copyright (c) 2003-2006 Simtec Electronics <linux@simtec.co.uk> <http://armlinux.simtec.co.uk/>
Copyright (C) 2007, 2008 Siemens AG
Copyright (C) 2018 Davidlohr Bueso.
Copyright 2012 Michael Ellerman, IBM Corporation.
(c) 2010, Tom Zanussi <tzanussi@gmail.com>
Copyright (C) 2009-2010 Guennadi Liakhovetski <g.liakhovetski@gmx.de>
Copyright SUSE Linux Products GmbH 2010
Copyright (c) Jürgen Schindele 2006
Copyright (c) 2016 Mellanox Technologies Ltd. All rights reserved.
Copyright (C) 2011-2012 Freescale Semiconductor, Inc.
Copyright © 2012-2014 Intel Corporation
Copyright (C) 2011-2015 Bernd Porr, mail@berndporr.me.uk
Copyright (C) 2002 Steve Schmidtke

LICENCE TERMS (cont.)

Copyright (C) 2011 LAPIS Semiconductor Co., Ltd.
Copyright (C) 2009 Tom Zanussi <tzanussi@gmail.com>
Copyright (c) 2001 by Jay Schulist <jschlst@samba.org> 2002-2003 by Arnaldo Carvalho de Melo <acme@conectiva.com.br>
Copyright (C) 2007 Domen Puncer, Telargo, Inc.
Copyright (c) 2013 by Jakob Haufe <sur5r@sur5r.net>
Copyright (C) 2010 Nokia Corporation and/or its subsidiary(-ies).
Copyright (c) 2015 Guenter Roeck
Copyright © 2013 Raspberry Pi (Trading) Ltd.
Copyright (C) 2014 Rafał Milecki <zajec5@gmail.com>
Copyright (c) 2017-2019, The Linux Foundation. All rights reserved.
Copyright (C) 2013 Davidlohr Bueso <davidlohr@hp.com>
Copyright (c) 2006 Patrick McHardy <kaber@trash.net>
Copyright (C) 2016 Sergio Prado (sergio.prado@e-labworks.com)
Copyright (C) 1995, 1996, 2000, 2001 by Ralf Baechle
Copyright 2003 Adam Belay <ambx1@neo.rr.com>
Copyright (C) 2015 Altera Corporation
Copyright 2019, Hari Bathini, IBM Corporation.
Copyright (C) 2019 Mentor Graphics Inc.
(c) 2005 Guillaume GOURAT / NexVision guillaume.gourat@nexvision.fr
Copyright (c) 2014-2017 Broadcom
Copyright (C) 2015 Robert Jarzmik
Copyright (C) 2001 Will Dyson <will_dyson@pobox.com>
Copyright (c) 2018 VMware, Inc., Palo Alto, CA., USA All Rights Reserved.
Copyright (C) 2010 Wolfgang Grandegger <wg@denx.de>
Copyright (c) 2016 MediaTek Inc. Author: Tiffany Lin <tiffany.lin@mediatek.com>
Copyright (c) International Business Machines Corp., 2002, 2007 Author(s): Steve French (sfrench@us.ibm.com)
Copyright (c) 2014-2015 Takashi Sakamoto
Copyright (C) 2000 Crossnet Co. <info@crossnet.co.jp>
Copyright (C) 1996 Olaf Kirch <okir@monad.swb.de>
Copyright (c) 2017 Mellanox Technologies. All rights reserved.
(C) COPYRIGHT 2016 ARM Limited. All rights reserved. Author: Liviu Dudau <Liviu.Dudau@arm.com>
Copyright (C) 2005 SAN People
Copyright (C) 2013 Texas Instruments Incorporated
Copyright (C) 1995, 1996 Russell King
Copyright (c) 2016, Intel Corporation
Copyright (C) 2007 - 2008 Alfred E. Heggstad <aeh@db.org>
Copyright (C) 2011-2013 Eric Dumazet (eric.dumazet@gmail.com)
Copyright (c) 2010 Patrick McHardy <kaber@trash.net>
Copyright 2014 Gerd Hoffmann <kraxel@redhat.com>
Copyright (C) 2009 - 2011 Texas Instruments
Copyright (C) 1995-2005 Mark Adler
Copyright (C) 2006 Rafał J. Wysocki <rjw@sisk.pl>
Copyright (C) 2017 Stefan Wahren <stefan.wahren@i2se.com>
Copyright (C) 2014,2015 Hisilicon Ltd.
Copyright (C) 2015-2017 Helen Koike <helen.fornazier@gmail.com>
Copyright (c) 2006, 2007 Cisco Systems. All rights reserved.
Copyright (c) 2012 - 2017 Intel Corporation. All rights reserved.
Copyright (C) 2018 emtrion GmbH
Copyright (C) 2012 Antti Palosaari <crope@iki.fi>
Copyright (C) Maxime Coquelin 2015 Author: Maxime Coquelin <mcoquelin.stm32@gmail.com>
Copyright 2010 GE Intelligent Platforms Embedded Systems, Inc.
Copyright (C) 2015 Imagination Technologies Ltd.
Copyright 1999 ARM Limited
Copyright 2005, 2011, Broadcom Corporation
Copyright (C) 2017 ZTE Ltd.
Copyright © 2006, Intel Corporation.

Copyright IBM Corp. 2002, 2007 Author(s): Ingo Adlung <adlung@de.ibm.com> Cornelia Huck <cornelia.huck@de.ibm.com> Arnd Bergmann <arndb@de.ibm.com> Peter Oberparleiter <peter.oberparleiter@de.ibm.com>
Copyright (c) 2018 NVIDIA Corporation.
Copyright (C) 2010 Alan Stern
Copyright (C) 2016 STMicroelectronics Imaging Division.
Copyright (C) 2015, 2016 ARM Ltd.
Copyright (c) 2016-2018 Mellanox Technologies. All rights reserved
Copyright (C) 2017 Joe Lawrence <joe.lawrence@redhat.com>
Copyright (C) 2012 ARM Ltd. Author: Catalin Marinas <catalin.marinas@arm.com>
Copyright (C) 2013-2014 Hisilicon Ltd.
Copyright (C) 1997 Russell King
Copyright (C) 2002, 2003, 2004 Dell Inc. by Matt Domsch <Matt_Domsch@dell.com> disk signature by Matt Domsch, Andrew Wilks, and Sandeep K. Shandilya legacy CHS by Patrick J. LoPresti <patl@users.sourceforge.net>
Copyright 2006-2007 Secret Lab Technologies Ltd. Grant Likely <grant.likely@secretlab.ca>
Copyright (C) 2010 Takashi Yoshii
Copyright (C) 2008 - 2010 Paul Mundt
Copyright (C) 2014 Altera Corporation
(C) Copyright IBM Corporation 2006
Copyright(C) 1995 Linus Torvalds
Copyright (c) 2003-2016 Chelsio Communications, Inc. All rights reserved.
Copyright (C) 2014 Jozsef Kadlecsek <kadlec@netfilter.org>
Copyright (c) 2000-2006, 2014-2015, Ericsson AB
(C) 2006-2009 VIA Technology, Inc.:(C) 2006-2008 Takashi Iwai <tiwai@suse.de>
Copyright 2011 IBM Corporation Author: Mahesh Salgaonkar <mahesh@linux.vnet.ibm.com>
Copyright (c) 2010 Arnaud Patard <apatard@mandriva.com>
Copyright (c) 2011-2012, The Linux Foundation. All rights reserved.
Copyright (C) STMicroelectronics 2017
Copyright (C) 2017 Stefano Stabellini <stefano@aporetto.com>
Copyright IBM Corp. 2001, 2007 Authors: Fritz Elfert (felfert@millenux.com) Peter Tiedemann (ptiedem@de.ibm.com) MPC additions : Belinda Thompson (belindat@us.ibm.com) Andy Richter (richtera@us.ibm.com)
(C) Copyright 1999 Roman Weissgaerber <weissg@vienna.at>;(C) Copyright 2000-2005 David Brownell;(C)
Copyright 2002 Hewlett-Packard Company
Copyright (c) 2018 Baylibre SAS. Author: Jerome Brunet <jbrunet@baylibre.com>
Copyright (C) 2010 Texas Instruments, Inc. Written by Santosh Shilimkar <santosh.shilimkar@ti.com>
Copyright 2011-2012 Maxim Integrated Products
Copyright 2011-2012 Freescale Semiconductor Inc.
Copyright (C) 2005 Red Hat, Inc. All rights reserved.
Copyright (c) 2017 Shubham Bansal <illusionist.neo@gmail.com>
Copyright (C) 2010 Jean-François Moine <http://moinejf.free.fr>
Copyright 2011 Freescale Semiconductor, Inc.
Copyright (c) 1982, 1986 Regents of the University of California. All rights reserved.
Copyright (C) 2004-2008 Atmel Corporation
Copyright (C) 2006 IBM Corporation
Copyright (C) 2005-2008 Texas Instruments, Inc.
Copyright (C) 2011 Atmel Corporation Josh Wu, <josh.wu@atmel.com>
Copyright (C) 2016-2017 Texas Instruments, Inc. Dave Gerlach <d-gerlach@ti.com>
Copyright (c) 1997 by Procom Technology, Inc. 2001-2003 by Arnaldo Carvalho de Melo <acme@conectiva.com.br>
Copyright (C) 2008-2010 Nokia Corporation Contact: Felipe Balbi <felipe.balbi@nokia.com>
Copyright (C) 2013 Ma Haijun <mahaijuns@gmail.com>
Copyright (c) 2015, 2017-2018, The Linux Foundation. All rights reserved.
Copyright (C) 1995 - 1997 Marco van Wieringen - ELM Consultancy B.V.
Copyright 2013 Cisco Systems, Inc. and/or its affiliates. All rights reserved.
Copyright (c) 2008-2011 Freescale Semiconductor, Inc. All rights reserved.
Copyright (C) 2009 Peter Edwards <sweetilmre@gmail.com>
Copyright (C) 2012-2013, Analog Devices Inc. Author: Lars-Peter Clausen <lars@metafoo.de>
Copyright (C) 2014 Google, Inc
Copyright (C) 2015 Renesas Corporation

LICENCE TERMS (cont.)

Copyright (c) 2000-2001 Christoph Hellwig.
Copyright 2003-2013 Broadcom Corporation. All Rights Reserved.
Copyright (c) 2001-2007 Jean Tourrilhes, All Rights Reserved.
Copyright (C) 2015 Anton Ivanov (aivanov@brocade.com,kot-begemot.co.uk)
Copyright 2007 Rusty Russell <rusty@rustcorp.com.au> IBM Corporation
Copyright (C) 2009 Lemote Inc. Author: Wu Zhangjin <wuzhangjin@gmail.com>
Copyright (C) 2002 Ingo Molnar
copyright;(c) Florian Schirmer <jolt@tuxbox.org>
Copyright 2018, Murilo Opsfelder Araujo, IBM Corporation.
Copyright 2019 Red Hat Inc.
Copyright (C) 2007, 2008, 2009 Siemens AG
Copyright (c) 2014-2018, Intel Corporation.
Copyright (C) 2013-2015 Freescale Semiconductor, Inc.
Copyright 2009 Benjamin Herrenschmidt, IBM Corp behn@kernel.crashing.org
"Copyright (C) 2001-2002 Andre Hedrick <andre@linux-ide.org>"
Copyright 2007 Matthieu CASTET <castet.matthieu@free.fr> All Rights Reserved.
Copyright (C) 2013, Samsung Electronics Co., Ltd. Andrzej Hajda <a.hajda@samsung.com>
Copyright (c) Thiebaud Weksteen, 2015
Copyright (c) 2005-2011 Atheros Communications Inc.
Copyright (C) 2007-2008 Steven Rostedt <strosedt@redhat.com>
Copyright (C) 2013 Texas Instruments Incorporated - http://www.ti.com/ Author: Tomi Valkeinen <tomi.valkeinen@ti.com>
Copyright (C) 2003, 2005, 2006 David S. Miller (davem@davemloft.net)
Copyright (C) 2015 Intel Corporation Author: Andy Shevchenko <andriy.shevchenko@linux.intel.com>
Copyright (C) 2010 Texas Instruments, Inc. Author: Santosh Shilimkar <santosh.shilimkar@ti.com>
Copyright (c) 2006-2009 Victor Chukhantsev, Denis Grigoriev,
Copyright 2009 Roderick Colenbrander
Copyright (C) 2014 Peter Feuerer <peter@piie.net>
Copyright (C) 2000-2001 Toshiba Corporation;(c) MontaVista Software, Inc.
Copyright (c) 2003 by Digigram <alsa@digigram.com>
Copyright (C) 2012 John Crispin <john@phrozen.org>
Copyright (C) 2010-2014 Michael Krufky (mkrufky@linuxtv.org)
Copyright (C) 2016 Atmel Corporation, Songjun Wu <songjun.wu@atmel.com>, Nicolas Ferre <nicolas.ferre@atmel.com>
Copyright (c) 2014 Carlo Caione
Copyright (C) 2000, 2001, 2002 David A. Schleef <ds@schleef.org>
Copyright 2006 Johannes Berg <johannes@sipsolutions.net>
Copyright (C) 2006-2009 Kristoffer Ericson <kristoffer.ericson@gmail.com>
Copyright (C) 2007 Intel Corporation <linux-wimax@intel.com> Yanir Lubetkin <yanirx.lubetkin@intel.com> Inaky Perez-Gonzalez <inaky.perez-gonzalez@intel.com>
Copyright (C) 2014 NetUP Inc.
Copyright (C) 1999 MIPS Technologies, Inc. All rights reserved.
Copyright 2000-2001 ATMEL Corporation.
Copyright (C) 1998-2001, 2003-2004 Hewlett-Packard Co David Mosberger-Tang <davidm@hpl.hp.com> Stephane Eranian <eranian@hpl.hp.com>
Copyright (C) 1998, 1999, 2001, 2003 Hewlett-Packard Co David Mosberger-Tang <davidm@hpl.hp.com>
Copyright (C) 2016 BayLibre, SAS. Author : Neil Armstrong <narmstrong@baylibre.com>
Copyright 2004 Uwe Koziol
Copyright (c) 2018 MediaTek Inc. Author: Ryder Lee <ryder.lee@mediatek.com>
Copyright (C) 2015 Jade Alglave <j.alglave@ucl.ac.uk>,
Copyright (C) 2011 Texas Instruments Author: Tomi Valkeinen <tomi.valkeinen@ti.com>
Copyright (c) 2018 Icenow Zheng <icenow@aos.com>
Copyright (C) 2009 Ivo van Doorn <lvdoorn@gmail.com>
Copyright (C) 1999-2012 the contributors
Copyright (C) 2015 Intel Corp Author: Jeeja KP <jeeja.kp@intel.com>
(C) Copyright IBM 2012;(C) Copyright Linaro 2013 2015v2
Copyright (C) 2015-2019 Vladimir Zapolskiy <vz@mleia.com>
Copyright 2016 Grinn
Copyright (c) 2013-2014, Intel Corporation.
Copyright (C) 2018, 2019 Red Hat Inc, Arnaldo Carvalho de Melo <acme@redhat.com>
Copyright (C) 2009-2011 Jean-François Moine <http://moinejf.free.fr>
Copyright (C) 2002, 2005 Oracle. All rights reserved.
Copyright (C) 2005-2006 Intel Corporation <linux-wimax@intel.com> Inaky Perez-Gonzalez <inaky.perez-gonzalez@intel.com>
Copyright (c) 1999 by Uros Bizjak <uros@kss-loka.si> Takashi Iwai <tiwai@suse.de>
Copyright 2016 Russell King <rmk+kernel@arm.linux.org.uk>
Copyright (C) 2013 Samsung Electronics Co., Ltd. Author: Kamil Debski <k.debski@samsung.com>
Copyright (C) 2012 Broadcom Corporation
Copyright (c) 2000-2008 LSI Corporation mailto:DL-MPTFusionLinux@lsi.com)
Copyright (c) 2004 Topspin Communications. All rights reserved.
Copyright (c) 2014-2016, Ericsson AB All rights reserved.
Copyright 1994, 1995 Digital Equipment Corporation.
(C) Copyright 2013-2014 Hewlett-Packard Development Company, L.P.
Copyright (C) 2016 Google, Inc.
Copyright (C) 2016 John Muir <john@jmuir.com>
Copyright (C) Freescale Semiconductor, Inc. 2007. All rights reserved.
Copyright (c) 2011-2014 Samsung Electronics Co., Ltd. http://www.samsung.com
Copyright (C) 1999, 2007 David S. Miller (davem@davemloft.net)
Copyright: (C) 2014 Wolfram Sang.
Copyright (C) 2012 Synopsys, Inc. (www.synopsys.com)
Copyright (c) 2007 Oracle Corporation. All rights reserved. Written by Martin K. Petersen <martin.petersen@oracle.com>
Copyright (C) 1999-2003 Andre Hedrick <andre@linux-ide.org>
Copyright (c) 2016 Pawel Jarosz <paweljarosz3691@gmail.com>
Copyright (c) 2016, The Linux Foundation. All rights reserved.
Copyright (c) 2015 MediaTek Inc. Author: Zhigang.Wei <zhigang.wei@mediatek.com> Chunfeng.Yun <chunfeng.yun@mediatek.com>
Copyright (c) 2002 - 2011 Tony Finch <dot@dotat.at>
Copyright (C) 1999 IBM Corporation
Copyright (c) 2000-2002,2005 Silicon Graphics, Inc.
Copyright 2013 Oleksandr Kravchenko <o.v.kravchenko@globallogic.com>
Copyright (C) 2004 Sun Microsystems Inc.
Copyright (C) 2014 Max nibble <nibble.max@gmail.com>
Copyright (c) 2015 MediaTek Inc. Author: Hongzhou.Yang <hongzhou.yang@mediatek.com> Yingjoe Chen <yingjoe.chen@mediatek.com>
Copyright (C) 2015 Henri Chain
(c) 1996 Hans-Joachim Widmaier
Copyright 2007-2010 Solarflare Communications Inc.
Copyright (c) 2003 - 2005 Chelsio Communications, Inc. * All rights reserved. *
Copyright (C) 2014, Stephan Mueller <smueller@chronox.de>
Copyright (C) 2001-2002 Convergence Integrated Media GmbH Holger Waechter <holger@convergence.de>
Copyright 1992 - 2016 Kai Makisara email Kai.Makisara@kolumbus.fi
Copyright (c) 2012 Andreas Hübner
Copyright (C) 2017 Sigma Designs
Copyright (c) 2015, National Instruments Corp. Author: Moritz Fischer <moritz.fischer@ettus.com>
Copyright (C) 2018 Broadcom
Copyright (C) 2007 Calin A. Cuianu <calin@ajvar.org>
Copyright (C) 2008-2011 Jean-François Moine <moinejf@free.fr>
Copyright (C) 2015 Azael Avalos <coproscefalo@gmail.com>
Copyright (C) 2016 NVIDIA CORPORATION. All rights reserved.
Copyright (C) 2012 Tensilica Inc.
Copyright (c) 2013, NVIDIA Corporation.
Copyright 1999 Paul Mackerras.
Copyright (C) 2000-2002 Russell King modification for nommu, Hyok S. Choi, 2004

LICENCE TERMS (cont.)

Copyright (c) 2013 Red Hat, Inc. and Parallels Inc. All rights reserved. Authors: David Chinner and Glauber Costa
Copyright (c) 2017 Andreas Färber
Copyright (C) 2014 Darek Marcinkiewicz <reksio@newterm.pl>
Copyright 2002 OProfile authors remark Read the file COPYING
Copyright (C) 2012 Johannes Goetzfried Johannes.Goetzfried@informatik.stud.uni-erlangen.de>
Copyright 2011 Heiko Stuebner <heiko@sntech.de>
Copyright (C) 1999 Paul `Rusty' Russell & Michael J. Neuling
Copyright (C) 2019 Texas Instruments Incorporated
Copyright 2016 Cirrus Logic, Inc.
Copyright (C) 2011 Red Hat, Inc.
Copyright (C) 2006 Takashi YOSHII
(C) Copyright 2017 - 2018, Xilinx, Inc.
Copyright (C) 2003 David Brownell
Copyright (c) 2019 Fuzhou Rockchip Electronics Co., Ltd.
Copyright (C) 2009-2010 Pengutronix Uwe Kleine-Koenig <u.kleine-koenig@pengutronix.de>
Copyright (C) 2003 ATI Inc. <hyu@ati.com>
Copyright (C) 2002-2003 Hewlett-Packard Co Stephane Eranian <eranian@hpl.hp.com>
"Copyright (C) 2006 Silicon Motion Technology Corp. Authors: Ge Wang, gewang@siliconmotion.com Boyod boyod.yang@siliconmotion.com.cn"
Copyright (c) 2011 Chris Schlund based on hid-topseed module
Copyright (c) 2010-2013 Kontron Europe GmbH Author: Michael Brunner <michael.brunner@kontron.com>
Copyright (C) 2004 Paul Mundt
Copyright (c) 2017-2018 Chelsio Communications, Inc. All rights reserved.
Copyright (c) 2006, Michael Wu <flamingice@sourmilk.net>
Copyright (c) 2012 Trond Myklebust <Trond.Myklebust@netapp.com>
Copyright 2018 Anshuman Khandual, IBM Corporation.
(c) 1998 Grant R. Guenther <grant@torque.net>
Copyright 2013-2015 Freescale Semiconductor Inc.
Copyright (C) 2014 STMicroelectronics Limited. Author: Giuseppe Cavallaro <peppe.cavallaro@st.com>
Copyright (C) 2013 - 2014 Texas Instruments Incorporated - http://www.ti.com
Copyright (c) 2008-2009 Silicon Graphics, Inc. All Rights Reserved.
Copyright (C) 2003 Michael Hunold <michael@mihu.de>
Copyright (C) 1994-2002 Linus Torvalds & authors
Copyright (C) 2015 Atmel
Copyright (c) 2006, 2018 Oracle and/or its affiliates. All rights reserved.
Copyright (C) 2016 Laurent Pinchart <laurent.pinchart@ideasonboard.com>
Copyright 2013 Peter Meerwald <pmeerw@pmeerw.net>
Copyright (C) 1997-2011 AudioScience Inc. <support@audioscience.com>;(C) Copyright AudioScience Inc. 2007
Copyright (C) 2003-2005 SAN People (Pty) Ltd
Copyright (c) 2012-2013 by Tensilica Inc. ALL RIGHTS RESERVED.
Copyright (C) 2018 Marvell International Ltd.
Copyright (C) 2012 Marvell Chao Xie <xiechao.mail@gmail.com>
Copyright (C) 2008-2009, 2012 Freescale Semiconductor, Inc. Author: Mingkai Hu <Mingkai.hu@freescale.com>
Reworked by Sven Schuchmann <schuchmann@schleissheimer.de> DT support added by Clemens Gruber <clemens.gruber@pqqgruber.com>
Copyright (C) 2008 Hartmut Hackmann
Copyright (C) 2013 Cavium, Inc.
Copyright (C) 2011-2014 Freescale Semiconductor, Inc.
(c) 2003 Phytex Messtechnik GmbH <armlinux@phytec.de>;(c) 2007 Juergen Beisert <j.beisert@pengutronix.de>
Copyright (C) IBM Corporation, 2011
Copyright (C) 1998, 1999 Frodo Looijaard <frodol@dds.nl> and Philip Edelbrock <phil@netroedge.com>
Copyright (c) 2004-2007 Intel Corporation. All rights reserved.
Copyright (C) 2014 STMicroelectronics SAS. All rights reserved.
Copyright (C) 2012 Hauke Mehrkens <hauke@hauke-m.de>
Copyright 2004,2010 Freescale Semiconductor, Inc.
Copyright (C) 2010-2017 Digital Devices GmbH Marcus Metzler <mocm@metzlerbros.de> Ralph Metzler <rjkm@metzlerbros.de>

Copyright (C) 2000 David Huggins-Daines <dhd@debian.org>
Copyright(C) Timesys Corporation 2016
Copyright (C) 2013-2015 Red Hat, Inc. Author: Asias He <asias@redhat.com> Stefan Hajnoczi <stefanha@redhat.com>
Copyright (c) 2018 Mobeiveil Inc.
Copyright (C) 2017, Leopard Imaging, Inc.
Copyright (C) 2013-2015 GlobalLogic Inc.
Copyright (c) 2005 Voltaire Inc. All rights reserved.
Copyright(c) 2019 Pensando Systems, Inc
Copyright 2007 Simtec Electronics Ben Dooks <ben@simtec.co.uk>
Copyright 2012 Philippe Reynes <tremyfr@yahoo.fr>
Copyright (C) 2003 Tresys Technology, LLC
(C) 2013 Daniel Borkmann <dborkman@redhat.com>
Copyright (C) 2007 Antonino Daplas <adaplas@gmail.com>
Copyright(c) 2007 Atheros Corporation. All rights reserved.
Copyright (c) 2011-2013 Xilinx Inc.
Copyright (c) 2012 - 2018 Intel Corporation. All rights reserved.
Copyright (C) 1998-2003 Geert Uytterhoeven
Copyright © 2008-2010 Samsung Electronics Kyungmin Park <kyungmin.park@samsung.com> Marek Szymowski <m.szymowski@samsung.com>
(C) Copyright 2002, Greg Ungerer (gerg@snapgear.com)
Copyright (C) 2014-18 H. Nikolaus Schaller <hns@goldelico.com>
(C) Copyright 2003-2005, Greg Ungerer <gerg@snapgear.com>
Copyright © 2014-2018 Broadcom
Copyright (C) 2000-2003 Deep Blue Solutions Ltd
Copyright (c) 2017 Google Inc
Copyright (c) 2019 Jernej Skrabec <jernej.skrabec@siol.net>
Copyright (c) 2013 Samsung Electronics Co., Ltd. Authors: Thomas Abraham <thomas.ab@samsung.com> Chander Kashyap <k.chander@samsung.com>
Copyright (c) 1998 Daniel Pirkl <daniel.pirkl@email.cz> Charles University, Faculty of Mathematics and Physics
Copyright 2006, 2008 Freescale Semiconductor Inc.
Copyright 2013 Daniel Borkmann <daniel@iogearbox.net>
Copyright (C) 2016 Sensirion AG, Switzerland Author: David Frey <david.frey@sensirion.com> Author: Pascal Sachs <pascal.sachs@sensirion.com>
Copyright 2011-2012 Calxeda, Inc.
Copyright 2016 Hans de Goede <hdegoede@redhat.com>
(c) 2005 by Hans J. Koch
Copyright (c) 2015 Imagination Technologies Author: Alex Smith <alex@alex-smith.me.uk>
Copyright (C) 2006 - 2007 Ivo van Doorn
Copyright 2016-2019 Toradex AG
Copyright 2019 NXP Sandor Yu <Sandor.yu@nxp.com>
Copyright (c) 2010-2010 Analog Devices Inc.
Copyright (C) 2014, Intel Corporation Author: Mika Westerberg <mika.westerberg@linux.intel.com>
Copyright (c) 2018 MediaTek Inc. Author: Chenglin Xu <chenglin.xu@mediatek.com> Sean Wang <sean.wang@mediatek.com>
Copyright (C) 2006 Marvell International Ltd.
Copyright (c) 2012, 2014, 2015 Lantiq Deutschland GmbH
Copyright (c) 2014 Samsung Electronics Co., Ltd.:(c) container_of(c, struct exynos_dpi, connector)
Copyright 2018 Konsulko Group
Copyright (C) 2004-2009 Applied Micro Circuits Corporation.
Copyright (c) 2002-2004 MontaVista Software, Inc
Copyright 2019 Amazon.com, Inc. or its affiliates. All Rights Reserved.
Copyright (C) 2016-2019 Netronome Systems, Inc.
(c) 2005 MontaVista Software, Inc.:(c) 2008 Xilinx, Inc.
Copyright (c) 2005 Richard Purdie
Copyright (C) 1996, 2001, 2006 David S. Miller (davem@davemloft.net)
Copyright © 2018 Intel Corporation

LICENCE TERMS (cont.)

Copyright (c) 2016 Hisilicon Limited.
Copyright (C) 2008 Lemote Inc. Author: liujl <liujl@lemote.com>, 2008-04-20
Copyright 2008 Jon Smirl, Digspeaker Author: Jon Smirl <jonsmirl@gmail.com>
Copyright (c) 2012-2014,2018 The Linux Foundation. All rights reserved.
Copyright (C) 2012 Richard Cochran <richardcochran@gmail.com>
Copyright (C) STMicroelectronics SA 2014 Authors: Benjamin Gaignard <benjamin.gaignard@st.com> Fabien Dessenne <fabien.dessenne@st.com> for STMicroelectronics.
Copyright (C) 1997 Roman Hodek <Roman.Hodek@informatik.uni-erlangen.de> idea by and with help from Richard Jelinek <rj@suse.de>
Copyright (C) 2015 Thomas Meyer (thomas@m3y3r.de)
Copyright Roman Zippel, 1997. All rights reserved.
Copyright IBM Corp. 2015
Copyright (c) 2000-2008 The Regents of the University of Michigan. All rights reserved.
Copyright (C) 2018 Jon Nettleton <jon@solid-run.com>
Copyright (C) 2003 Deep Blue Solutions Ltd, All Rights Reserved.
Copyright (C) 2012-2013 Freescale Semiconductor, Inc. All Rights Reserved.
Copyright (C) 2005-2008, 2015 Texas Instruments, Inc.
Copyright (c) International Business Machines Corp., 2002,2008 Author(s): Steve French (sfrench@us.ibm.com)
Copyright (C) 2016-2019 Texas Instruments Incorporated - http://www.ti.com/
Copyright (c) 2004 Rudolf Marek <r.marek@assembler.cz>
Copyright (C) 1995 Linus Torvalds Adapted from 'alpha' version by Gary Thomas Modified by Cort Dougan (cort@cs.nmt.edu) Modified for MBX using prep/chrp/pmac functions by Dan (dmalek@jlc.net) Further modified for generic 8xx by Dan.
Copyright (C) 2012 Pantelis Antoniou <panto@antoniou-consulting.com>
Copyright (C) 2015, Intel Corporation Author: Jiang Liu <jiang.liu@linux.intel.com>
Copyright 2015, Michael Neuling, IBM Corp.
Copyright (C) 2015-2016 Renesas Electronics Corp.
Copyright IBM Corp. 1999, 2012 Author(s): Hartmut Penner <hp@de.ibm.com>, Martin Schwidefsky <schwidefsky@de.ibm.com>, Denis Joseph Barrow,
Copyright (C) 1993 Hamish Macdonald
Copyright (C) 2000-2002 Mark Lord <mlord@pobox.com>
Copyright (C) 2016 Red Hat
Copyright (C) 2011 - 2015 UNISYS CORPORATION All rights reserved.
Copyright (C) 1996-1999 Russell King
Copyright (C)2006 USAGI/WIDE Project
Copyright (c) 2013 Intel Corporation. All rights reserved.
Copyright(c) 2012 Dialog Semiconductor Ltd.
Copyright (C) 2004 Nokia Corporation Author: Imre Deak <imre.deak@nokia.com>
Copyright (C) 2012 Wolfram Sang, Pengutronix <w.sang@pengutronix.de>
Copyright (C) 2006-2007 Sylvain Munaut <tnt@246tNt.com>
Copyright (c) 2019 Facebook include <linux/sched.h> include <linux/ptrace.h> include <stdint.h> include <stddef.h> include <stdbool.h> include <linux/bpf.h> include "bpf_helpers.h"
Copyright (C) 2019, Jiaxun Yang <jiaxun.yang@flygoat.com> Loongson-1 platform IRQ support
(C) Copyright 2002-2012, Greg Ungerer <gerg@snapgear.com>
Copyright 2017 Rhys Kidd
Copyright (C) 2003-2008 Takahiro Hirofuchi
Copyright (c) 2014-2017, The Linux Foundation. All rights reserved.
Copyright (C) 2018 Song Qiang <songqiang1304521@gmail.com>
Copyright(c) 2016-2019 Intel Corporation. All rights reserved.
(C) Texas Instruments, Inc.:(C) David Brownell
(C) Copyright 2014 David Mosberger-Tang <davidm@egauge.net>
Copyright (c) 2016 MediaTek Inc. Author: Daniel Hsiao <daniel.hsiao@mediatek.com> Jungchang Tsao <jungchang.tsao@mediatek.com> Tiffany Lin <tiffany.lin@mediatek.com>
Copyright (c) by Jaroslav Kysela <perex@perex.cz> Routines for control of ICS 2101 chip and "mixer" in GF1 chip
Copyright (c) 2003 James Morris <jmorris@intercode.com.au>
(c) PAWS (Protection Against Wrapped Sequence numbers) check failure
Copyright (C) 2019, Paul Cercueil <paul@crapouillou.net>
(c) 2000-2002 Gerd Knorr <kxarel@bytehex.org>
Copyright (c) 2005 ASPEED Technology Inc.
Copyright (C) 2011 ST-Ericsson SA Written on behalf of Linaro for ST-Ericsson
Copyright (c) 2003, B Dragovic
Copyright IBM Corp. 2001, 2006 Author(s): Robert Burroughs Eric Rossman (edrossma@us.ibm.com)
Copyright (C) 2007 by Ralf Baechle
Copyright 2011 IBM Corporation
Copyright 2011 Florian Tobias Schandinat <FlorianSchandinat@gmx.de>
Copyright (c) 2019 MediaTek Inc. Author: Ryder Lee <ryder.lee@mediatek.com>
Copyright (C) 2014 Samsung Electronics Co., Ltd. Sylwester Nawrocki <s.nawrocki@samsung.com>
Copyright 2001-2003 Pavel Machek <pavel@suse.cz> Based on code
Copyright (C) 2019 Lorenzo Bianconi <lorenzo.bianconi83@gmail.com>
Copyright (C) 2013 ARM Ltd.
Copyright (c) 2014 Tomasz Figa <t.figa@samsung.com>
Copyright 2014 Carlo Caione <carlo@caione.org>
Copyright 2013-15 Advanced Micro Devices, Inc.
Copyright © 2017 Broadcom
Copyright 2012-2017 <LW@KARO-electronics.de> based on imx53-qsb.dts
Copyright (C) 2008 Google, Inc. Author: Mike Lockwood <lockwood@android.com>
Copyright 2015 Realtek Microelectronics Author: Oder Chiou <oder_chiou@realtek.com>
Copyright (C) 2007,2008 Freescale Semiconductor, Inc. */
Copyright (c) 2015-2016, Mellanox Technologies. All rights reserved.
Copyright (C) 2006 Red Hat, Inc. All rights reserved.
Copyright (c) 2008 MontaVista Software, Inc. Anton Vorontsov <avorontsov@ru.mvista.com>
Copyright (C) 2007 Marvell International Ltd.
"Copyright (C) IBM Corporation, 2010-2012 Author: Srikar Dronamraju <srikar@linux.vnet.ibm.com>"
"Copyright (c) 2010, Applied Micro Circuits Corporation Authors: Tirumala R Marri <tmarri@apm.com> Feng Kan <fkan@apm.com>"
Copyright (C) 2008, Robert Jarzmik <robert.jarzmik@free.fr>
Copyright (C) 2012 Jean-Christophe PLAGNIOL-VILLARD <plagnioj@jcrosoft.com>
Copyright (C) 2015, 2016 Roger Shimizu <rogershimizu@gmail.com>
Copyright © 1998, 1999, 2000, 2001 Free Software Foundation, Inc.
Copyright 2010 Ben Dooks <ben-linux@fluff.org>
Copyright (C) 2018 Cadence Design Systems, Inc.
(c) Copyright Hewlett-Packard Development Company, L.P., 2008
Copyright (C) 2017, Red Hat Inc, Arnaldo Carvalho de Melo <acme@redhat.com>
"Copyright IBM Corp. 2004, 2007 Authors: Belinda Thompson (belindat@us.ibm.com) Andy Richter (richtera@us.ibm.com) Peter Tiedemann (ptiedem@de.ibm.com)"
Copyright 2003 Jonathan Corbet <corbet@lwn.net> This file is originally from the LWN.net Driver Porting series at http://lwn.net/Articles/driver-porting/
Copyright (c) 2008, 2009, 2010 QLogic Corporation. All rights reserved.
Copyright (c) 2007 Simtec Electronics Ben Dooks <ben@simtec.co.uk>
Copyright IBM Corp. 2009, 2015
Copyright (C) 2017-2018 Jason A. Donenfeld <Jason@zx2c4.com>. All Rights Reserved.
Copyright (C) 2010 Renesas Solutions Corp.
Copyright (C) 2007-2010 Advanced Micro Devices, Inc. Author: Joerg Roedel <jroedel@suse.de> Leo Duran <leo.duran@amd.com>
Copyright (C) 2004 IBM
Copyright (C) 2004 Andreas Monitzer <andy@monitzer.com>
Copyright 2010 Benjamin Herrenschmidt, IBM Corp beh@kernel.crashing.org and David Gibson, IBM Corporation.
Copyright (C) 2002 Roman Zippel <zippel@linux-m68k.org>
Copyright by Michal Miroslaw, 2008-2009
Copyright 2008, Michael Ellerman, IBM Corporation.
Copyright (C) 2011 Texas Instruments Incorporated - http://www.ti.com/ Tarun Kanti DebBarma <tarun.kanti@ti.com> Thara Gopinath <thara@ti.com>
Copyright (C) 1995-2003 Russell King 2001-2002 Keith Owens
Copyright 2012-2013 Freescale Semiconductor, Inc.

LICENCE TERMS (cont.)

Copyright (c) 1997--1999 Martin Mares <mj@ucw.cz>
Copyright (c) 2014-2015,2017 Qualcomm Atheros, Inc.
Copyright (C) 1992 - 1997, 2000 Silicon Graphics, Inc.
(C) 2004-2009 Dominik Brodowski <linux@dominikbrodowski.de>;(C) 2011 Thomas Renninger <trenn@novell.com>
Novell Inc.
(c) Copyright 2007 Gilles GIGAN <gilles.gigan@jcu.edu.au>
Copyright (c) 2014 Hisilicon Ltd.
Copyright (C) 2008-2012 ST-Ericsson AB
Copyright (c) 2015 Oliver Neukum <oneukum@suse.com>
Copyright (C) 2013 Atmel Corporation.
Copyright (C) 2011 Texas Instruments Author: Chandrabhanu Mahapatra <cmahapatra@ti.com>
Copyright 1993, Drew Eckhardt Visionary Computing Unix and Linux consulting and custom programming) drew@colorado.edu 1 (303) 666-5836
Copyright (C) 1999 Convergence Integrated Media GmbH <ralph@convergence.de>
Copyright (c) 2011-2014 PLUMgrid, http://plumgrid.com
Copyright (c) 2009-2010 Analog Devices, Inc. Author: Michael Hennerich <michael.hennerich@analog.com>
Copyright (c) 2018 Theobroma Systems Design und Consulting GmbH
Copyright (c) 2008 Sascha Hauer <s.hauer@pengutronix.de>, Pengutronix
Copyright (C) 2005-2006 Nokia Corporation
Copyright (c) 2011 Takashi Iwai <tiwai@suse.de>
Copyright (C) 2012 Altera Corporation <www.altera.com>
Copyright (c) 2012 Neratec Solutions AG
Copyright (C) 2013-2018 Xilinx, Inc.
Copyright (C) 2019 Western Digital Corporation or its affiliates.
© Smoktun and Christian Frömmel for supporting me with hardware and listening to my problems very patiently.
Copyright 1996 by Carsten Paeth (calle@calte.in-berlin.de)
Copyright (c) 2016-2017, The Linux Foundation. All rights reserved.
Copyright (C) 2004 - 2005, 2009-2010 Nokia Corporation Written by Tuukka Tikkanen <tuukka.tikkanen@elektrobit.com> Based on clocks.h by Tony Lindgren, Gordon McNutt and RidgeRun, Inc
(C) 2004-2006 Sebastian Witt <se.witt@gmx.net>
Copyright © 2014-2019 Intel Corporation
Copyright (c) 2016, Amir Vadai <amir@vadai.me>
Copyright (C) 2008 David Brownell
Copyright (C) STMicroelectronics 2017 Author: Fabrice Gasnier <fabrice.gasnier@st.com> Inspired by Benjamin Gaignard's stm32-timers driver
Copyright 2018 Intel Corporation
Copyright (c) 2015-2017 Oracle. All rights reserved.
Copyright (C) 1999, 2007 2012 David S. Miller (davem@davemloft.net)
Copyright (c) 2014-2015, Intel Corporation.
Copyright (C) 2006-2009 Nokia Corporation. All rights reserved.
Copyright 2007 Michael Buesch <m@buesch.ch>
Copyright (C) 2001 Russell King;(C) 2002 - 2003 Dominik Brodowski <linux@brodo.de>;(C) 2013 Viresh Kumar <viresh.kumar@linaro.org>
Copyright (c) 2015 Weida Hi-Tech Co., Ltd. HN Chen <hn.chen@weidahitech.com>
Copyright (c) 2002 - 2003 Oliver Kurth
Copyright © 2011 Ivan Djelic <ivan.djelic@parrot.com>
Copyright (C) 2010-2013 Digital Devices GmbH
Copyright 2013 IBM Corp.
Copyright 2014 Open Source Support GmbH
Copyright (C) 2018 Socionext Inc.
Copyright 2014 IBM Corporation.
Copyright (c) 2009 Atheros Communications Inc.
Copyright (C) 2002 - 2005 Tensilica Inc.
Copyright (C) 1997-2004 Erez Zadok
Copyright (C) 2012 Samsung Electronics Chiwoong Byun <woong.byun@samsung.com>
Copyright (C) International Business Machines Corp., 2002,2011 Author(s): Steve French (sfrench@us.ibm.com)
Copyright (C) 1998,2001 David A. Schleaf <ds@schleaf.org>

Copyright (C) 1997 Sten Wang
Copyright: (C) 2010 Nicolas Palix, DIKU.
Copyright 2003 Digi International (www.digi.com)
(C) 2007 Venkatesh Pallipadi <venkatesh.pallipadi@intel.com> Shaohua Li <shaohua.li@intel.com> Adam Belay <abelay@novell.com>
Copyright (c) 2014 Toradex AG.
Copyright (C) 2019 Oracle. All Rights Reserved. Author: Darrick J. Wong <darrick.wong@oracle.com>
Copyright (C) 2006 Felix Fietkau <nbd@openwrt.org>
Copyright (C) 1994, 1996, 1997, 1998, 2000 Free Software Foundation, Inc.
Copyright (C) 2007,2012 Texas Instruments, Inc.
Copyright C 2016, Oracle and/or its affiliates. All rights reserved.
Copyright (C) 2009 Janusz Krzysztofik <jkrzysz@tis.icnet.pl>
Copyright (c) 2015 Caesar Wang <wxt@rock-chips.com>
Copyright (C) 2005, Intec Automation Inc.
Copyright 2000, 2001, 2002, 2003 Broadcom Corporation. All rights reserved.
Copyright (c) 2011, Intel Corporation.
Copyright (C) 2018 Renesas Electronics Europe Limited
Copyright IBM Corp. 2008 Author(s): Jan Glauber <jang@linux.vnet.ibm.com>
Copyright (C) 1997,1998 Russell King
Copyright IBM Corp. 1999 Author(s): Ulrich Hild (first version) Martin Schwidofsky (heavily optimized CKSM version) D.J. Barrow (third attempt)
Copyright © 2013 Jussi Kivilinna <jussi.kivilinna@iki.fi>
Copyright (c) 2009 Manuel Lauss <manuel.lauss@gmail.com>
Copyright 2011 Marvell. <jyli@marvell.com>
Copyright (C) 2015 Marvell
Copyright (C) 2017 Cavium, Inc.
Copyright (C) 2006 Peter Korsgaard <jacmet@sunsite.dk>
Copyright (C) 2005 XenSource Ltd.
Copyright (C) 2010 by Tom Zanussi <tzanussi@gmail.com>
Copyright (c) 2016, Mellanox Technologies. All rights reserved.
Copyright (C) 1994 by Linus Torvalds
Copyright (C) 2009, 2010 Red Hat Inc.
Copyright 1994-2000 by Donald Becker.
Copyright (C) 2014 MEN Mikroelektronik GmbH (www.men.de) Author: Johannes Thumshirn <johannes.thumshirn@men.de>
Copyright (C) 2017 John Crispin <john@phrozen.org>
Copyright (C) 1997-2000 Russell King, Stefan Hanske
Copyright (C) 2015 - 2018 Linaro Ltd. <ard.biesheuvel@linaro.org>
Copyright (C) 2013 Richard Weinberger <richrd@nod.at>
Copyright 2007 Pierre Ossman
(C) Copyright 2004 Linus Torvalds;(C) Copyright 2006 Ralf Baechle <ralf@linux-mips.org>;(C) Copyright 2007 MIPS Technologies, Inc. written by Ralf Baechle <ralf@linux-mips.org>
Copyright (c) 2018 Politecnico di Torino
Copyright (C) 1995-2000 Russell King
Copyright (C) 2018 Oracle. All Rights Reserved. Author: Darrick J. Wong <darrick.wong@oracle.com>
(c) Ian Molton (spyro@f2s.com) 2003
Copyright 2018,2020 NXP
Copyright 2015 Marcus Cooper <codekipper@gmail.com>
Copyright (C) 1992 - 1997, 2000-2006 Silicon Graphics, Inc. All rights reserved.
Copyright (c) 2014 Google, Inc
Copyright (c) 2016 Rockchip Electronics Co. Ltd. Author: Shawn Lin <shawn.lin@rock-chips.com> Andy Yan <andy.yan@rock-chips.com>
Copyright 2016-2018 NXP Semiconductors
Copyright (C) 2012 - 2014 Allwinner Tech Pan Nan <pannan@allwinnertech.com>
Copyright (C) 2013,2014 Samsung Electronics Chanwoo Choi <cw00.choi@samsung.com> Krzysztof Kozłowski <krzk@kernel.org>
Copyright (C) 2009 Jes Sorensen <Jes.Sorensen@gmail.com>

LICENCE TERMS (cont.)

Copyright (C) 2011-2013 Gabor Juhos <juhosg@openwrt.org>
Copyright (C) 2002 Red Hat, Inc. All Rights Reserved. Written by David Howells (dhowells@redhat.com)
Copyright (C) 2012, Jeff Layton <jlayton@redhat.com>
Copyright (C) 2002 Sun Microsystems, Inc. Tim Hockin <thockin@sun.com>
Copyright (c) 2013 Linaro Ltd.
Copyright (C) 2013 Texas Instruments Incorporated - http://www.ti.com
Copyright (c) 2006 by Jaroslav Kysela <perex@perex.cz>
Copyright (c) 2005,2006 Mauro Carvalho Chehab <mchehab@kernel.org>
Copyright (c) 2016, Fuzhou Rockchip Electronics Co., Ltd. Author: Lin Huang <hl@rock-chips.com>
Copyright (c) 2003-2014 Chelsio Communications, Inc. All rights reserved.
Copyright(c) Arnaldo Carvalho de Melo <acme@conectiva.com.br>
Copyright (C) 2001-2002 Marcel Holtmann <marcel@holtmann.org> Jose Orlando Pereira <jop@di.uminho.pt>
Copyright (C) 2005-2008 Cavium Networks
Copyright (C) 2017 DENX Software Engineering
Copyright (c) 2016-2018, The Linux Foundation. All rights reserved.
Copyright (C) 2012 Texas Instruments Incorporated - http://www.ti.com/ Author: Archit Taneja <archit@ti.com>
"Copyright (C) 2002 MontaVista Software Inc. Author: Yoichi Yuasa <source@mvista.com>"
Copyright (C) 2018 IBM Corporation
Copyright (c) 2003-2007 Cavium Networks
Copyright (C) 2008 - 2012 Paul Mundt
Copyright (C) 2012 Innovative Converged Devices(ICD)
Copyright 2008, Johannes Berg <johannes@sipsolutions.net>
Copyright (c) 2019 Mellanox Technologies. All rights reserved.
Copyright (C) 1998 Nicolas Pitre <nico@fluxnic.net>
Copyright (c) Siemens AG, 2019
Copyright (C) 2003-2004 Hewlett-Packard Co David Mosberger-Tang <davidm@hpl.hp.com>
Copyright (c) 2004, 2005 Jeroen Vreeken (pe1rxq@amsat.org)
(C) 1998-2004 Ben Fennema
Copyright (C) 2008-2010 Analog Devices Inc.
Copyright (C) 2012 Maxime Ripard
Copyright (c) 2014, Fuzhou Rockchip Electronics Co., Ltd
Copyright (C) 1989 - 1997 Carnegie Mellon University
copyright : (C) 2001 by Adaptec
Copyright (c) 2010, Red Hat. All rights reserved.
Copyright (C) 2002 - 2013 Tensilica, Inc.
Copyright (c) 2013-2014 Takashi Sakamoto
Copyright 2006-10 Wolfson Microelectronics PLC. Author: Liam Girdwood <lrg@slimlogic.co.uk>
Copyright (c) 2001, 2d3D, Inc.
(c) 2014 Daniel Mack <linux@zonque.org>
Copyright 2014 IBM Corp. Author(s): Alexander Yarygin <yarygin@linux.vnet.ibm.com>
Copyright (C) 2007 Sony Computer Entertainment Inc. All rights reserved.
Copyright Red Hat Inc 2010. Author : Dave Airlie <airlied@redhat.com>
Copyright (C) 2004 Konrad Eisele (eiselekd@web.de,konrad@gaisler.com), Gaisler Research
Copyright (c) 2008 Freescale Semiconductor, Inc.
(C) 1999 Thomas Bogendoerfer (tsbogend@alpha.franken.de)
Copyright (C) 2005-2008 Pierre Ossman, All Rights Reserved.
Copyright (C) 2011 Rafael J. Wysocki <rjw@sisk.pl>, Renesas Electronics Corp.
(c) Copyright 1996-1997 Alan Cox <alan@lxorguk.ukuu.org.uk>, All Rights Reserved.;(c) Copyright 1995 Alan Cox <alan@lxorguk.ukuu.org.uk>
Copyright (C) 2014 Atmel Corporation
Copyright (C) 2001 - 2008 Tensilica Inc.
"Copyright (C) 1999 Linus Torvalds"
Copyright (C) 2014-2015 Freescale Semiconductor, Inc.
Copyright 2008 IBM Corporation, 2008 Author Mel Gorman <mel@csn.ui.ie>
Copyright (c) 2011 Andy Lutomirski
Copyright (c) 2010 Samsung Electronics Kyungmin Park <kyungmin.park@samsung.com> Marek Szyprowski <m.szyprowski@samsung.com>

Copyright (c) 2009-2010 Chelsio, Inc. All rights reserved.
"Copyright (C) 1997 Wu Ching Chen;(C) 1998 Krzysztof G. Baranowski;(C) 2002 Red Hat;(C) 2004 Red Hat"
Copyright(c) 2007 - 2013 Realtek Corporation. All rights reserved.
Copyright (C) 1996 Roman Zippel
Copyright (C) 2001 David J. McKay (david.mckay@st.com)
Copyright 2012 Wolfson Microelectronics. PLC.
(C) 1999 Andrea Arcangeli <andrea@suse.de>;(C) 2002 David Woodhouse <dwmw2@infradead.org>;(C) 2012 Michel Lespinasse <>walken@google.com>
Copyright (C) 2017, STMicroelectronics - All Rights Reserved Author: Arnaud Pouliquen <arnaud.pouliquen@st.com>.
Copyright (C) 2012-2016 Hans Verkuil <hans.verkuil@cisco.com>
Copyright (C) 2004 - 2008 by Tensilica Inc.
Copyright 2019 Collabora Ltd
Copyright(c) 2015-18 Intel Corporation.
Copyright (C) 2011 Texas Instruments, Inc. Rajendra Nayak <rnyak@ti.com>
Copyright (C) 2003 Hewlett-Packard Co David Mosberger-Tang <davidm@hpl.hp.com>
Copyright (C) 2015 - 2016 ZTE Corporation.
Copyright (c) 2014 Red Hat Inc.
Copyright (C) 2016, Microsoft, Inc.
Copyright (c) 2016 Endless Computers, Inc. Author: Carlo Caione <carlo@endlessm.com>
Copyright (C) 2011, <lokec@ccs.neu.edu>
Copyright IBM Corp. 2019 Author(s): Thomas Richter <tmricht@linux.ibm.com>
Copyright (C) 1999 Hewlett-Packard Co.
Copyright 2016 Microsemi Corporation
Copyright (c) 2015,2017 Qualcomm Atheros, Inc.
(C) Copyright 2001-2003 by Geert Uytterhoeven <geert@linux-m68k.org>
Copyright (c) 2015 Intel Corporation
Copyright(c) 2005 - 2006 Attansic Corporation. All rights reserved.
Copyright 2018 Marty E. Plummer <hanetzer@startmail.com>
Copyright (c) 2000-2001 Vojtech Pavlik
Copyright 2012 Linaro Ltd.
Copyright 2011 Benjamin Herrenschmidt, IBM Corp.
Copyright (C) 2005, 2006 Arnaud Giersch.
Copyright 2017 Lukasz Majewski, DENX Software Engineering, lukma@denx.de
Copyright 2014-2016 Toradex AG
Copyright(c) 2008 - 2011 Intel Corporation. All rights reserved.
Copyright IBM Corp. 1999, 2000 Author(s): Martin Schwidefsky (schwidefsky@de.ibm.com), Thomas Spatzier (tspat@de.ibm.com)
Copyright (C) 2016 Samsung Electronics Author: Chanwoo Choi <cw00.choi@samsung.com> Author: MyungJoo Ham <myungjoo.ham@samsung.com>
Copyright 1996, 1997 Linux International.
Copyright (C) 2005-2006 PLX Technology, Inc.
(c) Rebel.com, 1998-1999;(c) Philip Blundell, 1998, 2001
Copyright 2012 STEC, Inc.
Copyright (c) 2015 Linaro Ltd. www.linaro.org
Copyright (c) 2016-2018 Microsoft Corporation
Copyright (C) 2015 Powerventure Semiconductor Ltd.
Copyright (C) 2010 secunet Security Networks AG
Copyright (C) 2010 Indesign, LLC
Copyright (c) 2012, 2013, NVIDIA CORPORATION. All rights reserved.
Copyright(c) 2013 - 2014 Intel Corporation. All rights reserved.
Copyright (C) April 2007 Antonino Daplas <adaplas@pol.net>
Copyright (C) 1992,1993,1994,1996,1997 | W. Metzenthien, 22 Parker St, Ormond, Vic 3163, Australia | E-mail billm@suburbia.net |
Copyright (C) 2000,2001,2004 Broadcom Corporation
Copyright(c) 2007 - 2011 Intel Corporation. All rights reserved.
Copyright (C) 2019 Spreadtrum Communications Inc.

LICENCE TERMS (cont.)

Copyright (c) 1995-1996 Gary Thomas <gdt@linuxppc.org> Initial PowerPC version.
Copyright 2010-2011 Freescale Semiconductor, Inc.
Copyright 2013, Michael Ellerman, IBM Corp.
Copyright (c) 2007 Oliver Neukum
Copyright (c) 2019 Facebook Inc
Copyright (C) 2005-2006 Rodolfo Giometti <giometti@linux.it>
Copyright (C) 2002 Russell King.
(c) Query current usage::
Copyright (C) 2003 Rick Bronson
Copyright: [copy] ST-Ericsson AB 2010
Copyright (C) 2005 Kirk Lapray (kirk.lapray@gmail.com) based on nxt2002 by Taylor Jacob <rtjacob@earthlink.net> and nxt2004 by Jean-Francois Thibert (jeanfrancois@sagetv.com)
Copyright (C) 2000 Silicon Graphics, Inc. Written by Ulf Carlsson (ulfc@enr.sgi.com)
Copyright (C) 2011 Ericsson AB.
Copyright (C) 2012 Cypress Semiconductor
Copyright (C) 2015 Linaro, Ltd. Rob Herring <robh@kernel.org>
Copyright (C) 1998, 99, 2000, 01, 2002 Ralf Baechle (ralf@gnu.org)
Copyright (C) 2007,2008,2013 Imagination Technologies Ltd.
Copyright (c) 2000-2006 Silicon Graphics, Inc. All Rights Reserved.
Copyright (c) 2019 Facebook include <linux/bpf.h> include <linux/version.h> include "bpf_helpers.h"
Copyright (C) 2013 - 2017 Linaro, Ltd.
Copyright 2006-2009 Solarflare Communications Inc.
Copyright (C) 2017-2018 Jacopo Mondi <jacopo+renesas@jmondi.org>
Copyright (c) 2012-2013 Hisilicon Ltd.
Copyright (c) 2017 Broadcom Limited
Copyright (C) 2005 MIPS Technologies, Inc. All rights reserved.
Copyright (C) 2000 Ralph Metzler & Marcus Metzler for convergence integrated media GmbH
Copyright (C) 2016, 2017 Cavium Inc.
Copyright (C) 2011-2013 Freescale Semiconductor, Inc. All Rights Reserved.
Copyright 2010 Broadcom
Copyright (C) 1995, 1999, 2000 Ralf Baechle
Copyright (C) 2005 Ben Gardner <bgardner@wabtec.com>
Copyright (C) 2014 Javier Martinez Canillas <javier@osg.samsung.com>
Copyright(c) 2004 - 2006 Intel Corporation. All rights reserved.
Copyright (c) 2011 Volkswagen Group Electronic Research All rights reserved.
(C) SYSFS Interface:
Copyright (C) 1996, Olaf Kirch <okir@monad.swb.de>
Copyright (c) 2015 Linaro Ltd. Author: Pi-Cheng Chen <pi-cheng.chen@linaro.org>
Copyright (c) 2014 Samsung Electronics Co., Ltd. http://www.samsung.com/
Copyright (c) 2017 Baylibre SAS. Author: Jerome Brunet <jbrunet@baylibre.com>
Copyright (C) 1994,1999 | W. Metzenthien, 22 Parker St, Ormond, Vic 3163, | Australia. E-mail billm@melbpc.org.au |
"Copyright (c) 2009 Jiri Kosina;(c) hid_map_usage(hi, usage, bit, max, EV_KEY, (c))"
Copyright (c) 2008 Richard Liu, STMicroelectronics <richard.liu@st.com>
Copyright (C) 1992,1993,1997 | W. Metzenthien, 22 Parker St, Ormond, Vic 3163, Australia | E-mail billm@suburbia.net |
Copyright (C) 1998 David S. Miller (davem@redhat.com)
Copyright 2007 MontaVista Software, Inc
Copyright 1993-2003 NVIDIA, Corporation
Copyright (c) 2012 Cypress Semiconductor Corporation.
Copyright IBM Corp. 2007 Author(s): Jan Glauber (jang@de.ibm.com)
Copyright 2009 Advanced Micro Devices, Inc.
Copyright(c) 2014, Intel Corporation.
Copyright (c) 2003,2008 IBM Corp. Dave Engebretsen engebret@us.ibm.com Santiago Leon santil@us.ibm.com
Hollis Blanchard <hollisb@us.ibm.com> Stephen Rothwell Robert Jennings <rcjenn@us.ibm.com>
(c) 2008 NetApp. All Rights Reserved.
Copyright (C) 2014 Intel Corp
Copyright (c) 2014-2015 MediaTek Inc. Author: Tianping.Fang <tianping.fang@mediatek.com>

Copyright (c) 2017 HiSilicon Technologies Co., Ltd.
(C) Copyright 2006 IBM Corp.
Copyright 2011, Broadcom Corporation
Copyright (C) 2018 Amarula Solutions B.V. Author: Jagan Teki <jagan@amarulasolutions.com>
Copyright 2017 Paul Mackerras, IBM Corp. <paulus@au1.ibm.com>
Copyright (C) 2008 Renesas Solutions Corp.
Copyright 2015 Linaro Ltd.
Copyright (c) 2017 MediaTek Inc.
Copyright (c) International Business Machines Corp., 2004 Author(s): Steve French (sfrench@us.ibm.com)
Copyright(c) 1999 - 2018 Intel Corporation. *;(c) the value must fit within the timinca register space math based on internal DMA clock rate and available bits
Copyright (C) 2012 by Alan Stern
Copyright (C) 2003 Aurelien Alleaume <slts@free.fr>
Copyright (C) 2001-2002 MontaVista Software Inc. Author: Yoichi Yuasa <source@mvista.com>
Copyright (c) 2013-2015 Imagination Technologies Author: Paul Burton <paul.burton@mips.com>
Copyright (C) 1995-2000 Simon G. Vogl
Copyright (c) 2004 Simtec Electronics Ben Dooks <ben@simtec.co.uk>
Copyright (C) 2018 BayLibre, SAS Author: Neil Armstrong <narmstrong@baylibre.com>
Copyright 2008 JMicon Technology Corporation http://www.jmicon.com/
Copyright 2005 Openedhand Ltd.
Copyright (c) 2015 FUJITSU LIMITED
Copyright (C) 2005,2006,2007,2008 IBM Corporation
Copyright (C) 2005-2011 Nicolas Pitre <nico@fluxnic.net>
Copyright (C) 2013 Cogent Embedded, Inc. <source@cogentembedded.com>
Copyright 2011 Solarflare Communications Inc.
Copyright (C) 2001 by James.Bottomley@HansenPartnership.com
Copyright (C) 2015 Linaro Ltd. Author: Shannon Zhao <shannon.zhao@linaro.org>
Copyright 2015 Freescale Semiconductor, Inc.
Copyright (C) 1997,1998 Jakub Jelinek (jj@ultra.linux.cz)
Copyright (c) Jeffrey Layton <jlayton@redhat.com>, 2013
Copyright (C) 2015,2016 Cavium Inc. Authors: Fred Martin <fmartin@caviumnetworks.com> Jan Glauber <jglauber@cavium.com>
Copyright (C) 2005 Steven Toth <stoth@linuxtv.org>
Copyright (C) 1998 Daniel Jacobowitz <dan@debian.org>
Copyright (C) 2011, SUSE, Jan Kara <jack@suse.cz>
Copyright 2019 Red Hat, Inc. and/or its affiliates.
Copyright (c) 2010 Sascha Hauer <s.hauer@pengutronix.de>
Copyright © 2008 Koninklijke Philips Electronics NV. Author: Frans Meulenbroeks
Copyright (c) 2018 Mellanox Technologies.
Copyright (C) 2002 AbsoluteValue Systems, Inc. All Rights Reserved.
Copyright (C) 2014 Linaro Ltd.
Copyright (c) 2016 MediaTek Inc.
Copyright (c) 2003-2010 Cavium Networks
Copyright (C) STMicroelectronics SA 2014 Authors: Fabien Dessenne <fabien.dessenne@st.com> for STMicroelectronics.
Copyright (C) 1991,1996 Free Software Foundation
Copyright: [copy] 2008, Jouni Malinen <j@w1.fi>
Copyright (C) 2015 Broadcom
Copyright 2015 Martin Peres
Copyright (c) 2019 MediaTek Inc.
Copyright (c) 2017, Linaro Limited Author: Georgi Djakov <georgi.djakov@linaro.org>
Copyright(c) 2017 Jesper Dangaard Brouer, Red Hat, Inc.
Copyright 2006 Johannes Berg <johannes@sipsolutions.net>;(c) container_of(c, struct toonie, codec)
Copyright (c) 2013 MundoReader S.L. Author: Heiko Stuebner <heiko@sntech.de>
Copyright (C) 2010 Cambridge Silicon Radio Ltd.
Copyright IBM Corp. 2003, 2009;(C) 2003 IBM Corporation by Martin Schwidewsky (schwidewsky@de.ibm.com)
Copyright (C) 2016, LG Electronics

LICENCE TERMS (cont.)

Copyright (c) 2017 Cadence Cadence PCIe endpoint controller driver. Author: Cyrille Pitchen <cyrille.pitchen@free-electrons.com>
Copyright (C) 2010 Yoichi Yuasa <yuasa@linux-mips.org>
Copyright (C) 2009-2014 Texas Instruments Incorporated. Nishanth Menon Romit Dasgupta Kevin Hilman
Copyright (C) 1995-1997 H. Peter Anvin
Copyright 2007 Jan D. Louw <jd.louw@mweb.co.za>
Copyright (C) 2014 Steven Rostedt, Red Hat Inc
Copyright (C) IBM Corporation, 2014, 2017 Anton Blanchard, Rashmica Gupta.
Copyright 2014 FEDEVEL, Inc.
Copyright (C) 2006 Red Hat
Copyright (c) 2013 David Herrmann <dh.herrmann@gmail.com>
Copyright IBM Corp. 2007 Author(s): Stefan Weinhuber <wein@de.ibm.com>
Copyright (C) 2012 Telit, 2012 Fabio Porcedda <fabio.porcedda@gmail.com>
Copyright (C) Fuzhou Rockchip Electronics Co.Ltd Author: Jacob Chen <jacob-chen@iotwrt.com>
Copyright (C) 2012 Freescale Semiconductor, Inc.
Copyright (C) 2002 ARM Ltd.
Copyright 2017 Thomas Gleixner <tglx@linutronix.de>
Copyright (c) 2016 Samsung Electronics Co., Ltd.
Copyright (C) 2013 Atmel, 2013 Josh Wu <josh.wu@atmel.com>
Copyright(c) 2015, 2016, 2017 Intel Corporation.
Copyright (C) 1995 David S. Miller (davem@caip.rutgers.edu) Sun3/3x models added by David Monro (davidm@psrg.cs.usyd.edu.au)
Copyright (C) 2015-2018 Y Soft Corporation, a.s.
Copyright (C) 2012 Marvell Technology Group Ltd. Authors: Guoqing Li <ligq@marvell.com> Lisa Du <cldu@marvell.com> Zhou Zhu <zzhu3@marvell.com>
Copyright (C) Fuzhou Rockchip Electronics Co.Ltd Author: Chris Zhong <zyw@rock-chips.com> Nickey Yang <nickey.yang@rock-chips.com>
Copyright (C) 2001 Tim Waugh <tw@redhat.com>
Copyright (C) 2018 Samsung Electronics Co., Ltd
Copyright (C) 2010-2011 Jonas Bonn <jonas@southpole.se>
Copyright © 2012 Roland Stigge
Copyright (c) 2005 Arnaldo Carvalho de Melo <acme@ghostprotocols.net>
Copyright (C) 2014-2016 Freescale Semiconductor, Inc.
Copyright (c) 2016 - Savoir-faire Linux Author: Sebastien Bourdelin <sebastien.bourdelin@savoirfairelinux.com>
Copyright 2015 Vladimir Zapolskiy <vz@mleia.com>
Copyright (C) 2006 Savin Zlobec
Copyright (c) 2014 Anna Schumaker <Anna.Schumaker@Netapp.com>
Copyright (c) 1999-2006 Silicon Graphics, Inc. All Rights Reserved.
(C) Copyright 2012, Greg Ungerer <gerg@uclinux.org>
Copyright (C) 2010 Kent Overstreet <kent.overstreet@gmail.com>
Copyright (C) 2008 Marvell Semiconductor
Copyright Altera Corporation (C) 2016. All rights reserved.
Copyright (c) 2006-2008 Simtec Electronics http://armlinux.simtec.co.uk/ Ben Dooks <ben@simtec.co.uk>
Copyright (C) 2012 Sean Young <sean@mess.org>
Copyright (c) 2019 Mellanox Technologies. All rights reserved
Copyright IBM Corp. 1999, 2012
Copyright (C) 2009 Helge Deller <deller@gmx.de> based on arch/x86/kernel/stacktrace.c by Ingo Molnar <mingo@redhat.com> and parisc unwind functions by Randolph Chung <tausq@debian.org>
Copyright (C) NEC Electronics Corporation 2005-2006
Copyright (c) 2015, Mellanox Technologies inc. All rights reserved.
Copyright (C) 2016-2017 HiSilicon Co., Ltd. http://www.hisilicon.com
Copyright (c) 2008 Philipp Zabel <philipp.zabel@gmail.com>
Copyright (C) 2006 Kaiwan N Billimoria <kaiwan@designergraphix.com>
(c) 2004 Gerd Knorr <kx@bytesex.org> [SuSE Labs]
Copyright (c) 2015-2016, Linaro Limited
Copyright (C) 2010 Nokia Corporation (Hiroshi Doyu)
Copyright (C) 2008 Thomas Gleixner <tglx@linutronix.de>

(c) Copyright 2007 Oliver Schuster <olivers137@aol.com>
Copyright (c) 2001, 2002 Daniel Engstrom <5116@telia.com>
Copyright (c) 2014-2016 Advanced Micro Devices, Inc.
Copyright (C) 2004 Intel Corp.
(C) Copyright 2006-2007 TOSHIBA CORPORATION
Copyright (C) 2016 IBM Corp.
Copyright 2012 Steffen Trumtrar, Pengutronix
Copyright (C) 2004, 2005, 2006 Red Hat, Inc., Ingo Molnar <mingo@redhat.com>
Copyright (C) 2007-2009 Michal Simek <monstr@monstr.eu>
Copyright (c) 2016-2017 NVIDIA Corporation
Copyright 2011 Red Hat, Inc. and/or its affiliates.
Copyright (C) 2006 Steven Toth <stoth@linuxtv.org>
Copyright 2011, 2012, Hauke Mehrkens <hauke@hauke-m.de>
Copyright (c) 2017-2018 Hisilicon Limited.
Copyright 2007 IBM Corp
Copyright (c) 2003-2007 Network Appliance, Inc. All rights reserved.
Copyright (C) 1991, 1992 Linus Torvalds 1995 Jay Estabrook
Copyright 2013 Prodrive B.V.
Copyright (c) 1998 - 2003 Frodo Looijaard <frodol@dds.nl>, Philip Edelbrock <phil@netroedge.com>, and Mark Studebaker <mdsxyz123@yahoo.com> Ported to 2.6 by Bernhard C. Schrenk <clem@clm.org>
Copyright (C) 2017 NVIDIA CORPORATION. All rights reserved.
Copyright 2011, Mahesh Salgaonkar, IBM Corporation.
Copyright (C) STMicroelectronics SA 2014 Author: Benjamin Gaignard <benjamin.gaignard@st.com> for STMicroelectronics.
Copyright (C) 2012 Samsung Electronics SangYoung Son <hello.son@samsung.com>
Copyright (c) 2015-2018 Oracle. All rights reserved.
Copyright (C) STMicroelectronics 2017 - All Rights Reserved Author: Ludovic Barre <ludovic.barre@st.com> for STMicroelectronics.
Copyright (C) 2011 Texas Instruments Incorporated - http://www.ti.com/ Author: Rob Clark <rob@ti.com>
Copyright (c) 2012 Cirrus Logic Inc.
Copyright 2008-2015 Freescale Semiconductor, Inc.
Copyright 2016 Mans Rullgard <mans@mansr.com>
Copyright (C) 2017 Chen Liqin <liqin.chen@sunplusct.com>
Copyright (C) 2013 Intel Corporation.
Copyright (c) 2017 The Linux Foundation. All rights reserved.
Copyright 2013 Armadeus Systems - <support@armadeus.com>
Copyright (C) 2005 Olav Kongas <ok@artecdesign.ee> Portions:
(c) 2009, Tom Zanussi <tzanussi@gmail.com>
Copyright Echo Digital Audio Corporation (c) 1998 - 2004 All rights reserved www.echoaudio.com
Copyright: (C) 2013 Julia Lawall, INRIA/LIP6.
Copyright (C) 1997,1998,1999 Free Software Foundation, Inc. This file is part of the GNU C Library. Contributed by Richard Henderson (rth@cygnus.com), Jakub Jelinek (jj@ultra.linux.cz), David S. Miller (davem@redhat.com) and Peter Maydell (pmaydell@chiark.greenend.org.uk).
Copyright (c) 2006 Herbert Xu <herbert@gondor.apana.org.au>
(c) Aeroflex Gaisler AB
Copyright (c) 2012 Vista Silicon S.L. Javier Martin <javier.martin@vista-silicon.com>
Copyright (c) 2007-2015 Herbert Xu <herbert@gondor.apana.org.au>
Copyright (C) 2004 Dmitry Yusupov
Copyright (c) 2009 Gary Stein <LordCnidarian@gmail.com>
Copyright (C) 1995-2005 Dell Inc.
Copyright 2008 Simtec Electronics
Copyright 2015 Álvaro Fernández Rojas <noltari@gmail.com>
Copyright IBM Corp. 2005
Copyright 2017 Google Inc.
Copyright (C) 2013-2014 Red Hat Author: Rob Clark <robdclark@gmail.com>
Copyright (C) 2017 Texas Instruments Author: Kishon Vijay Abraham I <kishon@ti.com>
Copyright (c) 2013-2016 Qualcomm Atheros, Inc.

LICENCE TERMS (cont.)

Copyright (c) 1996-2007, 2012-2016, Ericsson AB
Copyright (c) 2015, Intel Corporation. All Rights Reserved.
Copyright (c) 2012 Samsung Electronics Co., Ltd. Author: Inki Dae <inki.dae@samsung.com> Author: Andrzej Hajda <a.hajda@samsung.com>
Copyright (C) 1995-2000 Russell King.
(C) Copyright IBM Corp. 2006
Copyright (c) 2013, Applied Micro Circuits Corporation Author: Feng Kan <fkan@apm.com>
Copyright (C) 2008-2009, Thomas Gleixner <tgx@linutronix.de>
Copyright(c) 2018 - 2019 Intel Corporation
Copyright (C) 2011 matt mooney <mfm@muteddisk.com> 2005-2007 Takahiro Hirofuchi
Copyright (C) 2006 Polycom, Inc.
Copyright (C) 2009 Texas Instruments.
Copyright (C) ARM Limited, 2017.
Copyright (C) 2003 Sistina Software
Copyright (c) 2018 Facebook, Inc. Author: Johannes Weiner <hannes@cmpxchg.org>
Copyright (c) 2016 Akinobu Mita <akinobu.mita@gmail.com>
Copyright (c) 1996 John Shifflett, GeoLog Consulting Modified by Russell King for 8MHz WD33C93A
Copyright (c) 2004-2011 Atheros Communications Inc.
Copyright (C) 2007 Kieran Bingham (MPC-Data Ltd)
Copyright 2011 (c) Oracle Corp.
Copyright (C) 2014, Marvell International Ltd.
"Copyright (C) 2011 Intel Corporation Authors: Vinod Koul <vinod.koul@linux.intel.com> Pierre-Louis Bossart <pierre-louis.bossart@linux.intel.com>"
Copyright (C) 2011 Texas Instruments Author: Archit Taneja <archit@ti.com>
(C) 2004-2009 Dominik Brodowski <linux@dominikbrodowski.de>
Copyright (c) 2014, Insignal Co., Ltd.
Copyright (c) 2006 Oracle. All rights reserved.
Copyright (C) 2002-2003 Hewlett Packard Co Stephane Eranian <eranian@hpl.hp.com>
Copyright 2010-2014 Imagination Technologies Ltd.
Copyright (C) 2016, STMicroelectronics - All Rights Reserved Author(s): Olivier Moysan <olivier.moysan@st.com> for STMicroelectronics.
Copyright 2015, Laurent Dufour, IBM Corp.
Copyright (C) 2011 Linaro Limited. Written by: Vincent Guittot
Copyright 2014 CirrusLogic, Inc.
Copyright (C) 1994-1999 Linus Torvalds
Copyright (C) 2014 Stefan Kristiansson <stefan.kristiansson@saunalahti.fi>
(c) 1995-1998 E.M. Serrat emserratt@geocities.com
Copyright (C) 2006 Yoshinori Sato
Copyright(c) 2013 Mauro Carvalho Chehab
Copyright(C) 2006 Elan Digital Systems Limited <http://www.elandigitalsystems.com>
Copyright (c) 2003-2019, Intel Corporation. All rights reserved. config INTEL_MEI tristate "Intel Management Engine Interface" depends on X86 && PCI help The Intel Management Engine (Intel ME) provides Manageability, Security and Media services for system containing Intel chipsets. if se
Copyright (c) 2008 Alek Du <alek.du@intel.com>
Copyright (c) 2018, Arm Ltd. Written by: Quentin Perret, Arm Ltd.
Copyright (c) 2005 Topspin Communications. All rights reserved.
Copyright 2014-2015 Macq S.A.
Copyright (C) 2006 Markus Rechberger <mrechberger@gmail.com>
(c) MontaVista Software, Inc.
Copyright (c) 2002-2017 Volkswagen Group Electronic Research All rights reserved.
Copyright IBM Corp. 2007, 2009 Author(s): Utz Bacher <utz.bacher@de.ibm.com>, Frank Pavlic <fpavlic@de.ibm.com>, Thomas Spatzier <tspat@de.ibm.com>, Frank Blaschka <frank.blaschka@de.ibm.com>
Copyright 2013 Free Electrons
Copyright 2018 Qtechnology A/S
Copyright (C) 1994 by Linus Torvalds Changed by many, many contributors over the years.
Copyright (C) 2018, Spreadtrum Communications Inc.
Copyright 2002 SOMA Networks, Inc.

Copyright (C) 2015, Intel Corporation. All rights reserved.
Copyright (C) 2012 Roland Stigge <stigge@antcom.de>
Copyright (C) 1994, 95, 96, 97, 98, 99, 2003 by Ralf Baechle
Copyright 2002 OProfile authors
Copyright 2005 Wolfson Microelectronics PLC.
Copyright (C) 1998 Russell King
Copyright IBM Corporation 2015
Copyright (c) 2014, Chen-Yu Tsai <wens@csie.org>
Copyright (c) 2011-2017, The Linux Foundation. All rights reserved.
Copyright (c) 2008-2012 Chelsio Communications, Inc. All rights reserved.
Copyright (C) 2012 Renesas Electronics Corporation Author: Guennadi Liakhovetski, <g.liakhovetski@gmx.de>
Copyright (C) 2018-2019 Texas Instruments Incorporated - <http://www.ti.com/> Lokesh Vutla <lokeshvutla@ti.com>
Copyright (C) 1998-2003 Krzysztof Halasa <khc@pm.waw.pl>
Copyright (c) 2015, Advanced Micro Devices Author: Brijesh Singh <brijesh.singh@amd.com>
Copyright (C) 2010-2012 Hans de Goede <hdegoede@redhat.com>
Copyright (C) 2012 Samsung Electronics Donggeun Kim <dg77.kim@samsung.com>
Copyright (C) 2003 Nokia Corporation Author: Juha Yrjölä <juha.yrjola@nokia.com>
Copyright (C) 2006-2008, 2010 Freescale Semiconductor, Inc.
(c) 1996-8 Grant R. Guenther <grant@torque.net>
Copyright (C) 2015 Rabeeh Khoury <rabeeh@solid-run.com> Based on dt work by Russell King
Copyright (c) 2011 Tony Prisk <linux@prisktech.co.nz>;(C) Copyright 2004-2007 Alan Stern, stern@rowland.harvard.edu
Copyright (C) 2017 Endless Mobile, Inc.
Copyright (c) 2002-2009 Clemens Ladisch All rights reserved.
(C) 1999-2001 by Helge Deller <deller@gmx.de>
Copyright (c) 2004 Freescale Semiconductor, Inc.
Copyright (C) 2018 Chris Brandt
Copyright (c) 2005 Cisco Systems. All rights reserved.
Copyright (c) 2016 MediaTek Inc. Author: PC Chen <pc.chen@mediatek.com>
Copyright (C) 2002 MEV Ltd. <<http://www.mev.co.uk/>>
Copyright (c) 2010, Microsoft Corporation.
Copyright 2015 Lothar Waßmann <LW@KARO-electronics.de>
Copyright 2012 Viresh Kumar <vireshk@kernel.org>
Copyright (C) 2003-2009 Yoichi Yuasa <yuasa@linux-mips.org>
Copyright (C) 2012 ST-Ericsson SA Author: Ulf Hansson <ulf.hansson@linaro.org>
Copyright © 2006-2007 Intel Corporation
Copyright (C) 2000, 2001 Broadcom Corporation
Copyright (c) Arnaud Patard <arnaud.patard@rtp-net.org>
Copyright (c) 1998, 1999, Rik van Riel <riel@nl.linux.org>
Copyright (C) 2004 ARM Limited. Written by Deep Blue Solutions Limited.
Copyright (C) 2012-2014, Marvell International Ltd.
Copyright (c) 2013-2015 PLUMgrid, <http://plumgrid.com>
Copyright (C) 1999-2003, Brad Douglas <brad@neruo.com>
"Copyright IBM Corp. 2001, 2007 Authors: Fritz Elfert (felbert@millenux.com) Peter Tiedemann (ptiedem@de.ibm.com) MPC additions : Belinda Thompson (belindat@us.ibm.com) Andy Richter (richtera@us.ibm.com)"
Copyright 1999-2002 Paul Mackerras.
Copyright (C) 2002-2003 Eric Biederman <ebiederm@xmission.com>
Copyright (C) 2010-2011 Mika Westerberg
Copyright (C) 2019 Linaro Ltd
Copyright (C) 2000 Sam Creasey
Copyright 2015 Cirrus Logic Inc.
Copyright (C) David A. Schleef <ds@schleef.org>
(C) 2005 Red Hat Inc Alan Cox <alan@lxorguk.ukuu.org.uk>
(c) Copyright Hewlett-Packard Development Company, L.P., 2006, 2008
Copyright IBM Corp. 2008 Author(s): Martin Schwidefsky (schwidefsky@de.ibm.com)
Copyright (C) 2000 Hewlett Packard (Grant Grundler)
Copyright (C) 2004 Interface Co., Ltd. Saito.K

LICENCE TERMS (cont.)

Copyright (c) 2015 H Hartley Sweeten <hsweeten@visionengravers.com>
Copyright (C) International Business Machines Corp., 2000-2005
Copyright (C) 2001, 2002, 2003 YOKOTA Hiroshi <yokota@netlab.is.tsukuba.ac.jp> GOTO Masanori <gotom@debian.or.jp>, <gotom@debian.org>
Copyright (c) 2018 Mellanox Technologies. All rights reserved.
Copyright 2015 Cisco Systems, Inc. and/or its affiliates. All rights reserved.
Copyright (c) 2013 ARM/Linaro
Copyright (c) 2008 H Hartley Sweeten <hsweeten@visionengravers.com>
Copyright (C) 2003 by Chuck Lever <cel@netapp.com>
Copyright (c) 2011-2015 PLUMgrid, <http://plumgrid.com>
Copyright (C) 2016-2017 Cogent Embedded, Inc.
Copyright IBM Corporation, Author: Paul E. McKenney
Copyright 2016 Ezequiel Garcia <ezequiel@vanguardiasur.com.ar>
Copyright (C) 2016 Christian Lamparter <chunkeey@gmail.com>
Copyright (c) 2012-2016, Intel Corporation.
Copyright (C) 2007 Freescale Semiconductor, Inc. All rights reserved.
Copyright 2002-2004, Instant802 Networks, Inc.
Copyright (c) 2018, The Linux Foundation. All rights reserved. datasheet: <http://www.ti.com/lit/ds/symlink/sn65dsi86.pdf>
Copyright (c) 2006 - 2013 Broadcom Corporation
Copyright (C) 2014 Samsung Electronics Author: Beomho Seo <beomho.seo@samsung.com>
Copyright (C) 2004-2006 Kristian Hoegsberg <krh@bitplanet.net>
Copyright (c) 2015, Applied Micro Circuits Corporation Authors: Rameshwar Prasad Sahu <rsahu@apm.com> Loc Ho <lho@apm.com>
Copyright (C) 2017-2018 NVIDIA Corporation. All rights reserved. Author: Ajay Gupta <ajayg@nvidia.com>
Copyright 2009-2013 Broadcom Corporation
Copyright © 2019 Alexey Dobriyan <adobriyan@gmail.com>
Copyright (C) 2008 <srinivasa.deevi at conexant dot com>
Copyright (C) 2003 Russell King, All Rights Reserved.
Copyright (C) 2009 Texas Instruments Incorporated - <http://www.ti.com/>
Copyright Altera Corporation (C) 2014. All rights reserved.
Copyright (c) 2012-2017 Qualcomm Atheros, Inc.
Copyright (C) 2003, 04, 07 Ralf Baechle (ralf@linux-mips.org)
Copyright (C) 2008 Aurelien Jarno <aurelien@aurel32.net>
Copyright (C) 1995-1999 Russell King
Copyright (c) 2013-2016, Mellanox Technologies. All rights reserved.
Copyright (C) 2019 Pengutronix, Michael Tretter <kernel@pengutronix.de>
Copyright (C) 2015 Imagination Technologies, Ltd. Author: Markos Chandras <markos.chandras@imgtec.com>
Copyright (C) 2015 Linaro Ltd. Author: Ard Biesheuvel <ard.biesheuvel@linaro.org>
Copyright (c) 2005 Simtec Electronics <http://www.simtec.co.uk/products/> Ben Dooks <ben@simtec.co.uk>
Copyright (C) 2003 Anton Blanchard <anton@au.ibm.com>, IBM Rework, based on alpha PCI code.
Copyright (C) 2015 Anshuman Khandual, IBM Corporation.
Copyright (C) 2009 Wolfgang Grandegger <wg@grandegger.com>
Copyright (c) 2012 Heiko Stuebner <heiko@sntech.de>
Copyright (C) 2008-2010 Nokia Corporation
Copyright (C) 2007 Imre Kaloz <kaloz@openwrt.org>
Copyright 2015 Chen-Yu Tsai
Copyright (c) 2006 Mauro Carvalho Chehab <mchehab@kernel.org>
Copyright(c) 2007 - 2008 Intel Corporation. All rights reserved.
Copyright (C) 1997-8 David A. Schleef <ds@schleef.org>
Copyright (C) 2007-2008 Atmel Corporation
Copyright (C) 2011 Texas Instruments, Inc. - <http://www.ti.com/>
Copyright (C) 2003-2005 by David Brownell
Copyright (C) 2000-2001 VERITAS Software Corporation.
Copyright (C) 1999 Linus Torvalds
Copyright(c) 2012 Intel Corporation. All rights reserved.
Copyright (c) 2019 Facebook include <test_progs.h>
(C) Copyright 2013 Intel Corporation Author: Sathyanarayanan Kuppuswamy <sathyanarayanan.kuppuswamy@intel.com>
Copyright 2016, Qualcomm Atheros, Inc.
(C) Copyright IBM Corp. 2005
Copyright (C) 2004 Anton Blanchard <anton@au.ibm.com>, IBM
Copyright (C) 2003 Al Borchers (alborchers@steinerpoint.com)
Copyright 1996 by Carsten Paeth <calle@calle.de>
Copyright (C) 2009 Wind River Systems Inc Implemented by fredrik.markstrom@gmail.com and ivarholmqvist@gmail.com
Copyright (C) 2007-8 Patrick Boettcher <pb@linuxtv.org>
Copyright (c) 2016 HiSilicon Technologies Co., Ltd.
Copyright (C) 2008 Christoph Hellwig.
Copyright (c) 2007 Freescale Semiconductor
Copyright (C) 2011, Greg Ungerer (gerg@snapgear.com)
Copyright (C) 2015 Rabeeh Khoury <rabeeh@solid-run.com>
Copyright (C) 2015 ARM Ltd.
Copyright (C) ST Microelectronics.
Copyright (C) 2004-2005 Richard Purdie
Copyright (C) 2018 ROHM Semiconductors bd70528-regulator.c ROHM BD70528MWV regulator driver
Copyright: [copy] 2012, Intel Corporation
Copyright (C) 2007-2008 Google, Inc.
Copyright (C) 1999, 2001-2002 Hewlett-Packard Co Stephane Eranian <eranian@hpl.hp.com>
Copyright (c) 2007 Philipp Zabel
Copyright (c) 2002 James Morris <jmorris@intercode.com.au> 2002 Adam J. Richter <adam@yggdrasil.com> 2004 Jean-Luc Cooke <jlcooke@certaintkey.com>
Copyright (c) 2019 Mellanox Technologies */
Copyright (C) 2015, Google, Inc
Copyright 2010 Nicolas Palix <npalix@diku.dk>
Copyright (C) 2012 Samsung Electronics MyungJoo Ham <myungjoo.ham@samsung.com>
Copyright 2000,2001,2002,2003,2004,2005 Broadcom Corporation. All rights reserved.
Copyright (C) 2016, Spreadtrum Communications Inc.
Copyright (c) 2006-2008 One Laptop Per Child Authors: Zephaniah E. Hull Andres Salomon <dlinger@debian.org>
Copyright (C) 2007, 2010 Texas Instruments, Inc. Rajendra Nayak <rnayak@ti.com> Lesly A M <x0080970@ti.com> Thara Gopinath <thara@ti.com>
Copyright (C) 2005 David Brownell
Copyright (C) 1996, 97, 98, 99, 2000 by Ralf Baechle
Copyright (C) 1994 Waldorf GMBH
Copyright (c) 2008-2009 MontaVista Software, Inc. <source@mvista.com>
Copyright (c) 2016-2017, Linaro Ltd
Copyright (c) 2003 by Jaroslav Kysela <perex@perex.cz>
Copyright (C) 2013-2017 ARM Limited, All Rights Reserved. Author: Marc Zyngier <marc.zyngier@arm.com>
Copyright (C) 1994-2016 Free Software Foundation, Inc. Written by Ian Lance Taylor, Cygnus Support
Copyright (c) 2012-2013 David Herrmann <dh.herrmann@gmail.com>
Copyright 2009 Simtec Electronics Ben Dooks <ben@simtec.co.uk>
(C) 2001-2002 Andras Kis-Szabo <kisza@sch.bme.hu>
Copyright 2008 Wolfson Microelectronics plc
Copyright (C) 2016 Wolf-Entwicklungen Marcus Wolf <linux@wolf-entwicklungen.de>
(C) 2000,2001,2002,2003,2004 Omnikey AG;(C) 2005-2006 Harald Welte <laforge@gnumonks.org> Adhere to Kernel process/coding-style.rst Port to 2.6.13 "new" style PCMCIA Check for copy_{from,to}_user return values Use nonseekable_open() add class interface for udev device creation
Copyright (C) 2002,2003 Florian Schirmer <jolt@tuxbox.org>
(c) Copyright 1997 by Carsten Paeth (calle@calle.in-berlin.de)
Copyright (C) 2005-2016 Broadcom. All rights reserved.
Copyright (c) 2016-2018, Logan Gunthorpe
Copyright (C) 2014 Traphandler
Copyright (C) 1997-2003 Erez Zadok
Copyright 2011 Red Hat Inc. All Rights Reserved.

LICENCE TERMS (cont.)

Copyright (C) 2015 IBM Corporation
Copyright IBM Corp. 2007, 2011 Author(s): Heiko Carstens <heiko.carstens@de.ibm.com>
Copyright(c) 2005 - 2011 Intel Corporation. All rights reserved.
Copyright (C) 1998, 1999, 2000, 2001 Free Software Foundation, Inc.
Copyright (c) 2000 Gerd Knorr based on code by: Eric Sandeen (eric_sandeen@bigfoot.com) Steve VanDeBogart (vandebo@uclink.berkeley.edu) Greg Alexander (galexand@acm.org)
Copyright (C) 2016 BayLibre SAS
Copyright (c) 2009 Simtec Electronics http://armlinux.simtec.co.uk/ Ben Dooks <ben@simtec.co.uk>
Copyright (c) 2010, 2011 Fabien Marteau <fabien.marteau@armadeus.com> Sponsored by ARMadeus Systems
Copyright (C) Microsoft Corporation
(C) 2004-2006 Luc Saillard (luc@saillard.org)
Copyright (C) 2008 - 2012 Tensilica Inc.
Copyright (C) 1998, 1999 Russell King, Phil Blundell
(C) 2018 Uladzislau Rezki (Sony) <urezki@gmail.com>
Copyright (C) 2018 Nuvoton Technologies tali.perry@nuvoton.com
Copyright (c) 2015 Rockchip Electronics Co. Ltd. Author: Caesar Wang <wxt@rock-chips.com>
Copyright 2013 Emilio López Emilio López <emilio@elopez.com.ar>
Copyright (c) 2015 Red Hat, Inc.
Copyright (C) 2003-2004 Dennis Noermann <dennis.noermann@noernet.de>
Copyright (C) 2001 Mike Corrigan & Dave Engebretsen, IBM Corporation Rewrite, cleanup:
Copyright (C) 1999, 2004 Manfred Spraul
Copyright (c) 2001-2002, SSH Communications Security Corp and Jouni Malinen jkmaline@cc.hut.fi
Copyright (C) 2017 Linaro, Ltd. <ard.biesheuvel@linaro.org>
Copyright 2015 Jelle de Jong <jelledejong@powercraft.nl>
Copyright 2018-2019 NXP Dong Aisheng <aisheng.dong@nxp.com>
Copyright (C) 2008 Cavium Networks
(C) 1999-2004 Ben Fennema;(C) 1999 Stelias Computing Inc
(C) Copyright 2008, 2012 Intel Corporation Author: Jacob Pan (jacob.jun.pan@intel.com) Author: Sathyanarayanan Kuppuswamy <sathyanarayanan.kuppuswamy@intel.com>
Copyright (C) 2008 Nokia Corporation
Copyright (C) 2016 Cavium, Inc.
Copyright 2005 Phil Blundell
Copyright 2014 Belkin Inc.
Copyright (C) 2008 STMicroelectronics
Copyright 2009 Intel Corporation; author H. Peter Anvin
Copyright (C) 2011 Jean Delvare <jdelvare@suse.de>
Copyright IBM Corp. 1999, 2008 Author(s): Martin Schwidefsky <schwidefsky@de.ibm.com>, Heiko Carstens <heiko.carstens@de.ibm.com>,
(c) 2010 Arnaud Patard <apatard@mandriva.com>;(c) 2010 Arnaud Patard <arnaud.patard@rtp-net.org>
(C) Copyright 2018, Xilinx, Inc.
Copyright (c) 2005 Milan Jurik, Petr Stehlik of ARAnyM dev team
Copyright 2007 Ben. Herrenschmidt <benh@kernel.crashing.org>, IBM Corp.
(C) 2005 Red Hat Inc
Copyright (c) 2019 Netronome Systems, Inc.
Copyright (c) 2015, Mellanox Technologies. All rights reserved.
Copyright (C) 2018 Jacopo Mondì <jacopo+renesas@jmondi.org>
Copyright (c) 2008 Wind River Systems, Inc.
Copyright (C) 2001 Steve Underwood and 2007-2008 David Rowe
Copyright (C) 2016 Freescale Semiconductor.
(c) the licenses granted in this Section 2.1(a) and (b) are effective on the date Initial Developer first distributes Original Code under the terms of this License.
Copyright 2011-2012 Hauke Mehrkens <hauke@hauke-m.de>
Copyright (C) 1996,97,98 Ralph Metzler <rjkm@thp.uni-koeln.de> Marcus Metzler <mocm@thp.uni-koeln.de>
Copyright (C) International Business Machines Corp., 2000-2004
Copyright (C) 2003,4,5 Manfred Spraul
Copyright (c) 2018 Jesper Dangaard Brouer, Red Hat Inc.
Copyright(c) 2012-2017 Intel Corporation. All rights reserved.

(c) 2008 Daniel Mack <daniel@caiaq.de>
Copyright (C) 2019 Red Hat, Inc. All Rights Reserved. Written by David Howells (dhowells@redhat.com) Derived from NFS's sillyrename.
Copyright (c) 2013-2014 Samsung Electronics, Co. Ltd.
Copyright (C) 1999, 2000, 2004, 2005 MIPS Technologies, Inc. All rights reserved. Authors: Carsten Langgaard <carstenl@mips.com> Maciej W. Rozycki <macro@mips.com>
Copyright (C) 2016-2017 Cirrus Logic, Inc. and Cirrus Logic International Semiconductor Ltd.
Copyright (C) 1995 by Ralf Baechle
Copyright (C) 2012 Ezequiel Garcia elezegarcia--a.t--gmail.com>
Copyright (C) 2003 Atheros Communications, Inc., All Rights Reserved.
Copyright (C) 2010 Loongson Inc. & Lemote Inc. & Institute of Computing Technology Author: Xiang Gao, gaoxiang@ict.ac.cn Huacai Chen, chenhc@lemote.com Xiaofu Meng, Shuangshuang Zhang
Copyright (c) 2017-2018 MediaTek Inc. Author: Sean Wang <sean.wang@mediatek.com>
Copyright 1993 by Theodore Ts'o.
Copyright (C) 2013-2019 Advanced Micro Devices, Inc.
(C) 2001-2002 Magnus Boden <mb@ozaba.mine.nu>
Copyright (C) 1999 - 2004 Greg Kroah-Hartman (greg@kroah.com)
Copyright 2014-2015 Analog Devices Inc. Author: Lars-Peter Clausen <lars@metafoo.de>
Copyright (c) 2003-2012 QLogic Corporation
Copyright (C) 2015, Samsung Electronics Co., Ltd. Andrzej Hajda <a.hajda@samsung.com>
Copyright (C) 2005-2015 Promise Technology Inc.
Copyright (C) 2019 Texas Instruments Incorporated - http://www.ti.com/ Author: Vignesh Raghavendra <vigneshr@ti.com>
Copyright (C) 2001 Mike Corrigan & Dave Engebretsen, IBM Corporation
Copyright 2005 (C) Jes Sorensen <jes@trained-monkey.org>
Copyright 2016 Madhavan Srinivasan, IBM Corporation.
Copyright (C) 2010 LaCie
Copyright (c) 2012-2016, Intel Corporation. All rights reserved Intel Management Engine Interface (Intel MEI) Linux driver
Copyright (C) 2010 Janusz Krzysztofik <jkrzysz@tis.icnet.pl>
Copyright (C) 2003 Robert Schwebel <r.schwebel@pengutronix.de>, Pengutronix
Copyright (C) 2005 IBM
Copyright (C) 2011 by Kevin Cernekee (cernekee@gmail.com)
Copyright (C) 1991-1998 Linus Torvalds Re-organised Feb 1998 Russell King
Copyright 2014-2015 Cisco Systems, Inc. and/or its affiliates. All rights reserved.
Copyright (c) 2008 Thomas Bogendoerfer <tsbogend@alpha.franken.de>
Copyright (C) 2012 Peter Meerwald <pmeerw@pmeerw.net>
Copyright (C) 2015 Samsung Electronics Robert Baldyga <r.baldyga@samsung.com>
Copyright (C) 1999-2001 Gerard Roudier <groudier@free.fr>
Copyright IBM Corporation, 2008
Copyright (C) 1997 Michael AK Tesch written with much help from Jon Howell
Copyright (C) 2000, 2001 Gary Brubaker (xavyer@ix.netcom.com)
Copyright 2013 Cisco Systems, Inc. All rights reserved.
Copyright (C) 2012-2013 Broadcom Corporation
Copyright (C) 1997-2002 Inside Out Networks, Inc.
Copyright (C) 1997, 1998, 2001, 03, 05, 06 by Ralf Baechle
Copyright (C) 2007 Ben. Herrenschmidt (benh@kernel.crashing.org), IBM Corp.
Copyright (C) 2013-2014 Jens Axboe
Copyright (C) Shailabh Nagar, IBM Corp. 2006;(C) Balbir Singh, IBM Corp. 2006;(C) Jay Lan, SGI, 2006
Copyright 2010,2012 IBM Corp.
Copyright (C) 2001 Manuela Cirronis, Paolo Alberelli
Copyright (C) 1992,1993 Rick Sladkey <jrs@world.std.com>
Copyright (C) 2010 Freescale Semiconductor, Inc.
Copyright (c) 2015 Samsung Electronics Co., Ltd http://www.samsung.com
Copyright (C) 2012 Red Hat based in parts on udlfb.c:
Copyright 2002 (c) Intel Corporation
Copyright (C) 2015-2018 Cirrus Logic

LICENCE TERMS (cont.)

Copyright 2002 Andi Kleen */
Copyright(C) 2012-2016 Canonical Ltd.
Copyright 2020 NXP Dong Aisheng <aisheng.dong@nxp.com>
"Copyright 2008-2009 Luis R. Rodriguez <mcgrof@qca.qualcomm.com>"
Copyright (C) 2002 - 2007 Jeff Dike (jdike@{linux.intel,addtoit}.com)
Copyright © 2007 Anton Vorontsov <cbou@mail.ru>
Copyright (C) 2008 Maarten Maathuis. All Rights Reserved.
Copyright (C) 2004 Hyok S. Choi
Copyright (C) 2012 Renesas Electronics Europe Ltd
Copyright (C) 2016 - 2017 Xilinx, Inc.
Copyright 2012-2013 Stefan Roese <sr@denx.de>
Copyright 2007, IBM Corporation
Copyright (c) 1999-2010 Tensilica Inc.
(c) Mellanox Technologies, 2016
Copyright (C) STMicroelectronics 2017 Author: Alexandre Torgue <alexandre.torgue@st.com> for STMicroelectronics.
Copyright (C) 2016 ARM Ltd.
Copyright (c) 2017 Samsung Electronics Co., Ltd.
Copyright (c) 2005-2008 Chelsio, Inc. All rights reserved.
Copyright (C) 2018 Michael Neuling, IBM Corporation.
Copyright (c) NXP 2019
Copyright (C) IBM Corporation, 2004. All rights reserved
Copyright 2018 Wandboard, Org.
Copyright (c) 2017, Microchip Technology Inc. Author: Tudor Ambarus <tudor.ambarus@microchip.com>
Copyright (C) 2016-2017 Synopsys, Inc. (www.synopsys.com)
Copyright 2000 Precision Insight, Inc., Cedar Park, Texas.
Copyright (c) 2015 Axentia Technologies AB Author: Peter Rosin <peda@axentia.se>
Copyright (C) 2016 Intel Corporation Author: Andy Shevchenko <andriy.shevchenko@linux.intel.com>
Copyright (C) 2002, Rohit Seth <rohit.seth@intel.com>
Copyright (C) 2006 - 2009 Ingenic Semiconductor Inc.
(C) Copyright 1991-2000 Linus Torvalds
Copyright (C) Joel Fernandes (Google) <joel@joelfernandes.org>
Copyright IBM Corp. 2016 Author(s): Harald Freudenberger <freude@de.ibm.com>
Copyright (C) 2001-2018 Miklos Szeredi <miklos@szeredi.hu>
Copyright (C) 2014 Imagination Technologies Author: Paul Burton <paul.burton@mips.com>
Copyright (C) Josef Gajdusek <atx@atx.name>
Copyright (c) 2002 Convergence GmbH
Copyright 2018 Noralf Trønnes
Copyright (C) 2016-2017 Texas Instruments Incorporated - http://www.ti.com/
Copyright (C) 2018 Zoro Li
Copyright (c) 2003-2017 Chelsio Communications, Inc. All rights reserved.
Copyright (C) 2013-2015, Yann Collet.
Copyright (C) 2017 Samsung Electronics Author: Chanwoo Choi <cw00.choi@samsung.com>
Copyright (C) 2007-2008 Intel Corporation. All rights reserved.
Copyright (c) 2008-2010 Henrik Rydberg
Copyright (C) 2018, SECO Spa.
Copyright (C) 2009 Devin Heitmueller <dheitmuelle@kernellabs.com>
Copyright (C) 2007-2008 SMSC
Copyright 2000,2001 MontaVista Software Inc. Author: MontaVista Software, Inc. ppopov@mvista.com or source@mvista.com
Copyright (C) 2007 Craig W. Nadler
Copyright IBM Corp. 2016 Author(s): Martin Schwidofsky <schwidofsky@de.ibm.com>
Copyright (c) 2006 by Jing Min Zhao <zhaojingmin@users.sourceforge.net>
Copyright (C) Fuzhou Rockchip Electronics Co.Ltd Author:Mark Yao <mark.yao@rock-chips.com>
Copyright (c) 2015 NVIDIA Corporation.
Copyright 1999 by Alex deVries <alex@onefishtwo.ca>
Copyright (c) 1997-1998 Mark Lord

Copyright(c) 2015 - 2019 Intel Corporation.
Copyright (c) 2000-2001,2005 Silicon Graphics, Inc. All Rights Reserved.
Copyright (C) 2012 Cavium, Inc.
Copyright (c) 1994-1998 Initio Corporation All rights reserved.
Copyright (C) 2016-2017 Texas Instruments Inc. Dave Gerlach
Copyright (C) 2019, Red Hat Inc, Arnaldo Carvalho de Melo <acme@redhat.com>
Copyright (C) 2001 Antonino Daplas<adaplas@pol.net> All Rights Reserved
Copyright 2016 Linaro Ltd.
Copyright (c) 2016, Linaro Ltd.
Copyright (c) 2007 Benjamin Herrenschmidt, IBM Corporation Extracted from signal_32.c and signal_64.c
Copyright (c) 2017 Broadcom
Copyright (C) 2014 Stmicroelectronics
Copyright (C) 2010-2012 ADVANSEE - http://www.advantsee.com/
Copyright (C) 1999-2002, Greg Ungerer (gerg@snapgear.com)
Copyright 2001 MontaVista Software Inc. Author: MontaVista Software, Inc. ahennesy@mvista.com
Copyright (c) 2016 Yang Ling <gnaygnil@gmail.com>
Copyright (C) 2012 (davem@davemloft.net)
Copyright (C) 2013 Linaro Limited Author: AKASHI Takahiro <takahiro.akashi@linaro.org>
Copyright (C) 2006-2007 PA Semi, Inc
Copyright (C) 2014 NVIDIA Corporation
Copyright 2011 Vista Silicon S.L.
Copyright 2019 Analog Devices Inc. YAML 1.2
Copyright (c) 2003-2013 Thomas Graf <tgraf@suug.ch>
Copyright (C) 2010 Marek Vasut <marek.vasut@gmail.com>
Copyright (C) 2011 Nokia Corporation Author: Matti J. Aaltonen <matti.j.aaltonen@nokia.com>
Copyright 2015 - 2016 Amazon.com, Inc. or its affiliates.
Copyright 2010 Intel Corp. Author: Huang Ying <ying.huang@intel.com>
Copyright(c) 2016-2017 Realtek Corporation.*/
Copyright (C) 2010 Texas Instruments, Inc.
Copyright (C) 2015 Annapurna Labs Ltd.
Copyright (C) 2009, Hitoshi Mitake <mitake@dcl.info.waseda.ac.jp>
Copyright (C) 2009 Texas Instruments Added OMAP4 support- Santosh Shilimkar <santosh.shilimkar@ti.com>
Copyright 2001-2003 SuSE Labs.
Copyright IBM Corp. 1999, 2004 Author(s): Martin Schwidofsky <schwidofsky@de.ibm.com> Peter Oberparleiter <peter.oberparleiter@de.ibm.com>
Copyright (C) 1995-1998 Jean-loup Gailly.
Copyright(c) 2016-2018 Intel Corporation. All rights reserved.
Copyright (c) 2018, Linaro Limited
Copyright (C) 2016 Cogent Embedded Inc.
Copyright (C) 2017 Intel Corp Author: Jaikrishna Nemallapudi <jaikrishna.nemallapudi@intel.com> Author: Subhransu S. Prusty <subhransu.s.prusty@intel.com>
Copyright (c) 2009 Nokia Corporation Contact: Eduardo Valentin <eduardo.valentin@nokia.com>
Copyright (c) 2016 Chen Zhong <chen.zhong@mediatek.com>
Copyright (C) 1999 Richard Gooch
Copyright 2007 Rafael J. Wysocki <rjw@sisk.pl>
Copyright (c) 2013 Phillip Lougher <phillip@squashfs.org.uk>
Copyright (C) 2010 Intel Corporation <tony.luck@intel.com>
Copyright 2007-2012 Solarflare Communications Inc.
Copyright (c) 2008 PIKA Technologies Sean MacLennan <smacLennan@pikatech.com>
Copyright 2010 Free Software Foundation, Inc. Contributed by Bernd Schmidt <bernds@codesourcery.com>.
Copyright: [copy] 1998-2000 Vojtech Pavlik <vojtech@ucw.cz>
Copyright (c) 2010 David Härdeman <david@hardeman.nu>
Copyright (C) 2016-2017 Socionext Inc. Author: Masahiro Yamada <yamada.masahiro@socionext.com>
Copyright (C) 2005 Patrick Boettcher <patrick.boettcher@posteo.de>
Copyright (C) 1998-2001, 2003, 2005 Hewlett-Packard Co Stephane Eranian <eranian@hpl.hp.com> David Mosberger <davidm@hpl.hp.com>
Copyright (C) 2012 Dario Faggioli <raistlin@linux.it>, Juri Lelli <juri.elli@gmail.com>, Michael Trimarchi <michael@

LICENCE TERMS (cont.)

amarulasolutions.com>, Fabio Checconi <fchecconi@gmail.com>
Copyright (C) 2016 Red Hat, Inc. Author: Michael S. Tsirkin <mst@redhat.com>
Copyright (c) 2018 Facebook Inc.
Copyright © 2013 Intel Corporation
Copyright (c) 2013 Jiri Pirko <jiri@resnulli.us>
Copyright (c) 2005,2006 Jim Cromie <jim.cromie@gmail.com>
Copyright 2007 OProfile authors Jens Wilke Daniel Hansel
Copyright IBM Corp. 2001, 2019 Author(s): Robert Burroughs Eric Rossman (edrossma@us.ibm.com)
Copyright 2016-2020 Broadcom Limited. All rights reserved.
Copyright (c) 2015-2018 Socionext Inc.
Copyright (C) 2006 Benjamin Herrenschmidt (benh@kernel.crashing.org) IBM, Corp.:(C) Copyright IBM Deutschland Entwicklung GmbH 2005
Copyright (C) 2004 Luming Yu <luming.yu@intel.com>
Copyright (c) 2006 Olivier DANET <odanet@caramail.com>
Copyright 2014 Rose Technology
Copyright IBM Corp. 2002, 2009
Copyright (C) 2017 Rafał Milecki <rafal@milecki.pl>
Copyright (c) 2020 Cloudflare
Copyright (C) 1993, 2000 Linus Torvalds
Copyright (C) 1994, 1996, 1998, 1999, 2000, 2001 Free Software Foundation, Inc.
Copyright 2018, Anton Blanchard, IBM Corp.
Copyright (c) 2002 Eric Brower (ebrower@usa.net)
(C) Copyright IBM Corp. 2003, 2004
Copyright (C) 2016 NVIDIA Corporation
Copyright (c) 2005 Andrey Panin <pazke@donpac.ru>
Copyright 2012 Sascha Hauer, Pengutronix <s.hauer@pengutronix.de>
Copyright (c) 2001 Jean-Fredric Clere, Nikolas Zimmermann, Georg Acher Mark Cave-Ayland, Carlo E Prezl, Dick Streefland
Copyright 2013 Google Inc. All Rights Reserved
Copyright (C) 2012 Peter Hurley <peter@hurleysoftware.com>
Copyright (C) 2014,2016 Maksim Salau <maksim.salau@gmail.com>
Copyright (C) 2002-2014 ARM Limited.
Copyright (C) 2002,2004 MARA Systems AB <http://www.marasystems.com> by Henrik Nordstrom <hno@marasystems.com>;(C) 2006,2008 Red Hat, Inc., James Morris <jmorris@redhat.com>
Copyright 2007 Dave Airlie All Rights Reserved.
Copyright (C) 2005-2018 Andes Technology Corporation include <linux/uaccess.h>
Copyright (C) 2015-2016 Altera Corporation
Copyright (c) 2000-2017, Ericsson AB
Copyright (C) STMicroelectronics SA 2017 Author(s): M'boumba Cedric Madianga <cedric.madianga@gmail.com>
Pierre-Yves Mordret <pierre-yves.mordret@st.com>
Copyright (C) 2002 Connect Tech Inc.
Copyright 2008 Cavium Networks
Copyright © 2014 NVIDIA Corporation
Copyright (C) 2007 Ville Syrjala <syrjala@sci.fi>
Copyright (C) 2012 Intel Corporation
Copyright (C) 2010 Andreas Mohr <andi@lissas.de>
Copyright (C) 2004-2008 SMSC
Copyright FUJITSU LIMITED 2010
Copyright (c) 2007-2011 Atheros Communications Inc.
Copyright IBM Corp. 2006, 2009
Copyright (C) 2007 Ben Skeggs. All Rights Reserved.
Copyright (C) 2007 Ivo van Doorn
Copyright (C) 2005 Pavel Mironchik <pmironchik@optifacio.net>
Copyright Gavin Shan, IBM Corporation 2014.
Copyright 2016 Chen-Yu Tsai
Copyright (c) 2019, Intel Corporation. All rights reserved.
Copyright (C) 1994 David S. Miller (davem@caip.rutgers.edu)

Copyright (C) 2007-2014 by Sensoray Company Inc. Dean Anderson
Copyright (c) 2000-2008 LSI Corporation.
Copyright (c) 2009-2013, The Linux Foundation. All rights reserved.
Copyright (C) 2012 OMICRON electronics GmbH
Copyright IBM Corp. 2003 Author(s): Martin Schwidefsky (schwidefsky@de.ibm.com)
Copyright (C) International Business Machines Corp., 2007,2008 Author(s): Steve French (sfrench@us.ibm.com)
Copyright (C) 2004,2005 ADDI-DATA GmbH for the source code of this module. Project manager: S. Weber
Copyright** [copy] 2019 Intel Corporation
Copyright (c) 2012, The Linux Foundation. All rights reserved.
Copyright 2009 Sysgo AG Thomas Moll <thomas.moll@sysgo.com> fixed maintenance access routines, check for aligned access
Copyright (C) 2010 Digital Design Corporation
Copyright 2005-2013 Solarflare Communications Inc.
Copyright © 1999 Machine Vision Holdings, Inc.
Copyright (C) 2017 David Lechner <david@lechnology.com>
Copyright (C) 2005-2019 Andes Technology Corporation
Copyright (C) 2014 Renesas Electronics Corporation
Copyright 2012 Red Hat, Inc. Doug Ledford <dledford@redhat.com>
Copyright (C) 2012 Samsung Electronics Co.Ltd Authors: Joonyoung Shim <jy0922.shim@samsung.com>
Copyright(c) 2017 Oracle and/or its affiliates. All rights reserved.
Copyright (C) 2003-2006 Marcel Holtmann <marcel@holtmann.org>
Copyright (c) 2014 Advanced Micro Devices, Inc.
Copyright (c) 2017, Mellanox Technologies, Ltd. All rights reserved.
Copyright (c) 2015, Huawei Inc. All rights reserved.
Copyright 2004-2013 Synopsys, Inc.
Copyright (c) 2012-2015 Synaptics Incorporated
Copyright (C) Jaya Kumar
Copyright (C) 2018 Xilinx, Inc.
Copyright (C) 2015 Jakub Sitnicki
Copyright © 2017-2019 Intel Corporation
Copyright (c) 2011,2012, NVIDIA CORPORATION. All rights reserved.
Copyright 2015 Yoshinori Sato <ysato@users.sourceforge.jp>
Copyright(c) 2017 Intel Deutschland GmbH
Copyright 2012 IBM Corp.
Copyright (C) 2011 Jussi Kivilinna <jussi.kivilinna@mbnet.fi>
Copyright (C) 2019 IBM Corporation
Copyright (C) 2013-2015 Microchip Technology Germany II GmbH & Co. KG
Copyright (C) 2014 Guenter Roeck <linux@roeck-us.net>
Copyright (C) 1999, 2000, 2001
Copyright (C) 2011 - 2013 Samsung Electronics Co., Ltd.
Copyright 2005 MontaVista Software, Inc. Matt Porter <mporter@kernel.crashing.org>
Copyright (C) 1998 Paul Mackerras and Fabio Riccardi.
Copyright(c) 2014-2016 Intel Corporation. All rights reserved.
Copyright (C) STMicroelectronics 2018 - All Rights Reserved Author: Philippe Peurichard <philippe.peurichard@st.com>, Pascal Paillet <p.paillet@st.com> for STMicroelectronics.
Copyright (c) 2016, Fuzhou Rockchip Electronics Co., Ltd
Copyright 2015-2016 Freescale Semiconductor Inc.
Copyright (C) 2014 Huawei Inc.
Copyright (C) 2005-06 Tower Technologies Author: Alessandro Zummo <a.zummo@towertech.it>
Copyright (C) 2009 - 2014 Xilinx, Inc.
Copyright (C) 2009 Matt Fleming
Copyright (C) 2013 Ludovic Desroches <ludovic.desroches@atmel.com>
Copyright (C) 2002, 2007 Red Hat, Inc. All Rights Reserved. Written by David Howells (dhowells@redhat.com)
Copyright (C) 2008 International Business Machines Corp. Author(s): Michael A. Halcrow <mahalcro@us.ibm.com>
Copyright (c) 2003-2004 Simtec Electronics Ben Dooks <ben@simtec.co.uk> http://armlinux.simtec.co.uk/
Copyright 2002 Christer Weingel <wingel@nano-system.com>;(c) Copyright 2000 Jakob Oestergaard <jakob@ostenfeld.dk>

LICENCE TERMS (cont.)

Copyright © 2015-2016 Intel Corporation
Copyright (C) 2009, 2016 Intel Corp. Huang Ying <ying.huang@intel.com>
Copyright (c) 2002-2007 Volkswagen Group Electronic Research All rights reserved.
Copyright (c) 2001 by Takashi Iwai <tiwai@suse.de> based on dmasound.c.
(C) Copyright 2012, Greg Ungerer <gerg@uclinux.com>
Copyright (C) 2010 Maxim Levitsky <maximlevitsky@gmail.com>
Copyright (C) 2007 IBM
Copyright (C) 1998 David A. Schleef <ds@schleef.org>
Copyright (C) 2012-2019 B.A.T.M.A.N. contributors:
Copyright (C) 2010 Jarod Wilson <jarod@redhat.com>
Copyright (C) 2012 - Virtual Open Systems and Columbia University Author: Christoffer Dall <c.dall@virtualopensystems.com>
Copyright (c) 2014 Romain Perier <romain.perier@gmail.com>
Copyright (C) 2018 Intel Corporation.
Copyright (C) 2000 Wolfgang Grandegger (wolfgang@ces.ch)
Copyright 2012-2013, Marco Porsch <marco.porsch@s2005.tu-chemnitz.de>
Copyright (C) 2015-2018 - ARM Ltd Author: Marc Zyngier <marc.zyngier@arm.com>
Copyright (c) 2002 Richard Zidlicky
Copyright (c) 2003 Pavel Machek
Copyright (C) 2008-2009 H Hartley Sweeten <hsweeten@visionengravers.com>
Copyright (C) 2017 Luis R. Rodriguez <mcgrof@kernel.org>
Copyright (C) 2006-2009 Red Hat, Inc.
Copyright: 2018 Cadence Design Systems, Inc.
Copyright 2019 NXP Dong Aisheng <aisheng.dong@nxp.com>
Copyright (C) 2003-2005 David Brownell
Copyright (C) 1997, 1998, 1999, 2000, 2009 Ingo Molnar, Hajnalka Szabo;(c) 1999, Multiple IO-APIC support, developed by Ken-ichi Yaku <yaku@css1.kbnes.nec.co.jp> and Hidemi Kishimoto <ksimoto@css1.kbnes.nec.co.jp>, further tested and cleaned up by Zach Brown <zab@redhat.com> and Ingo Molnar <mingo@redhat.com>
Copyright (C) International Business Machines Corp., 2009, 2013 Etersoft, 2012 Author(s): Steve French (sfrench@us.ibm.com) Pavel Shilovsky (pshilovsky@samba.org) 2012
Copyright (C) 2008-2010 Gabor Juhos <juhosg@openwrt.org>
Copyright (C) 2015 CompuLab Ltd. - http://www.complab.co.il/ Author: Dmitry Lifshitz <lifshitz@complab.co.il>
(c) Copyright 2004-2007 Wim Van Sebroeck <wim@iguana.be>.
Copyright IBM Corp. 2000, 2009 Author(s): Ingo Adlung <adlung@de.ibm.com>, Martin Schwidewsky <schwidewsky@de.ibm.com>, Cornelia Huck <cornelia.huck@de.ibm.com>, Heiko Carstens <heiko.carstens@de.ibm.com>
(C) 2018 Mojatau, Alexander Aring <aring@mojatau.com>
Copyright (C) 2013, Intel Corporation Author: Rafael J. Wysocki <rafael.j.wysocki@intel.com>
Copyright(C) 2001 Russell King;(C) 2003 Venkatesh Pallipadi <venkatesh.pallipadi@intel.com>;(C) 2003 Jun Nakajima <jun.nakajima@intel.com>;(C) 2009 Alexander Clouter <alex@digriz.org.uk>;(c) 2012 Viresh Kumar <viresh.kumar@linaro.org>
Copyright (C) 2004 Russell King.
Copyright (C) 2000,2001,2002,2003,2004 Broadcom Corporation
Copyright: |copy| 1996-2000 Vojtech Pavlik <vojtech@ucw.cz> - Sponsored by SuSE
Copyright (C) 2007-2013 Texas Instruments, Inc. Author: Vikram Pandita <vikram.pandita@ti.com> Author: Anand Gadiyar <gadiyar@ti.com> Author: Keshava Munegowda <keshava_mgowda@ti.com> Author: Roger Quadros <rogerq@ti.com>
Copyright 2011 Free Electrons
Copyright (C) 2012 Intel, Inc.
Copyright (c) by Francisco Moraes <fmoraes@nc.rr.com> Driver EMU10K1X chips
Copyright (C) 2015 Texas Instruments Author: Jyri Sarha <jsarha@ti.com>
Copyright (C) 1992, 1998 Linus Torvalds, Ingo Molnar
Copyright (C) 1996 David S. Miller
Copyright (C) 2013 Johan Hovold <jhovold@gmail.com>
Copyright (C) 2004 Nokia Corporation Written by Tuukka Tikkanen and Juha Yrjölä <juha.yrjola@nokia.com> Misc hacks here and there by Tony Lindgren <tony@atomide.com> Other hacks (DMA, SD, etc) by David Brownell
Copyright 2010 DENX Software Engineering, Stefan Roese <sr@denx.de>
(C) 2012 Google, Inc. Author: Kent Overstreet <koverstreet@google.com>
Copyright 2017, Nicholas Pigginn, IBM Corporation
Copyright (C) 2012 Alexander Block. All rights reserved.
(C) Copyright 2008 Intel Corporation
Copyright 2013 Realtek Semiconductor Corp. Author: Oder Chiou <oder_chiou@realtek.com>
Copyright © 2000-2010 David Woodhouse <dwmw2@infradead.org> Steven J. Hill <sjhill@realitydiluted.com> Thomas Gleixner <tglx@linutronix.de>
Copyright (C) 2009 Conexant Systems Inc. Authors <shu.lin@conexant.com>, <hieph.huynh@conexant.com>
(C) 2005 by Harald Welte <laforge@netfilter.org>
(C) DENX Software Engineering.
Copyright (C) 2009 Antonio Ospite <ospite@studenti.unina.it>
Copyright (c) 2013 Google, Inc
Copyright (C) 2008-2009 MontaVista Software, Inc. <source@mvista.com>
Copyright (C) 2004 Jeff Dike (jdike@addtoit.com)
Copyright (C) 2006 Mike Kravetz IBM Corporation
Copyright (c) 2006-2007 Silicon Graphics, Inc. All Rights Reserved.
Copyright (C) 2008-2016, VMware, Inc. All Rights Reserved.
Copyright 2008 Vitaly Mayatskikh <vmayatsk@redhat.com>
Copyright © 2010 STMicroelectronics. Ashish Priyadarshi Shiraz Hashim <shiraz.linux.kernel@gmail.com>
Copyright (C) 2019 NVIDIA Corporation.
Copyright (C) 2010 Juan Jesús García de Soria <skandalfo@gmail.com>
Copyright (c) 2010 Rafał Milecki <zajec5@gmail.com>
Copyright (C) 2010 IBM Corporation
Copyright (c) 2019 MediaTek Inc. Author: Bibby Hsieh <bibby.hsieh@mediatek.com>
Copyright (C) 2008-2009 ST-Ericsson AB
Copyright 2009-2015 VMware, Inc., Palo Alto, CA., USA
Copyright 2011 - 2014 Freescale Semiconductor Inc.
Copyright © Sebastian Claßen, 2007 Jan Engelhardt, 2007-2010
Copyright (C) 2011-2016 Freescale Semiconductor, Inc.
Copyright (C) 2015-2016 Zhang, Keguang <keguang.zhang@gmail.com>
Copyright (C) 2008, 2012 Texas Instruments, Inc.
Copyright (c) 2008,2009 Katalix Systems Ltd
Copyright (C) 2016-2017 Socionext Inc. Author: Masahiro Yamada <yamada.masahiro@socionext.com> Kunihiko Hayashi <hayashi.kunihiko@socionext.com>
Copyright (C) 2003, Intel Corporation
Copyright (C) 2016 Eduardo Valentin <edubezval@gmail.com>
Copyright (c) 2016 Linaro Ltd. <ard.biesheuvel@linaro.org>
Copyright (C) 2010-2011 Texas Instruments, Inc.
Copyright (C) 2007, 2008 Magnus Damm
Copyright (C) 2005-2009 Cavium Networks
Copyright (c) 1997 Dan Malek (dmalek@jlc.net)
Copyright (C) 1999 Juergen Peitz
Copyright 2012 DENX Software Engineering GmbH Heiko Schocher <hs@denx.de>
Copyright (C) STMicroelectronics 2018 - All Rights Reserved Author: David Hernandez Sanchez <david.hernandezsanchez@st.com> for STMicroelectronics.
Copyright (C) 2005 Martin Langer <martin-langer@gmx.de>
Copyright (c) 2000-2006, 2018, Ericsson AB
Copyright (c) 2013, NVIDIA CORPORATION. All rights reserved.
Copyright 2006 Simtec Electronics
Copyright (c) 2001-2004 Ben Fennema <bfennema@falcons.csc.calpoly.edu> All rights reserved.
Copyright (c) 2017 Theobroma Systems Design und Consulting GmbH
Copyright (c) 2014 EMAC Inc.
(C) 2012 by Pablo Neira Ayuso <pablo@netfilter.org>;(C) 2012 by Vyatta Inc. <http://www.vyatta.com>
Copyright (C) 2015 Texas Instruments Incorporated - http://www.ti.com/
Copyright (C) 1998-2002 Andre Hedrick <andre@linux-ide.org>
Copyright (C) 2012 ST-Ericsson
Copyright 2007 Wind River Systems Inc.
Copyright (C) 2012 Russell King

LICENCE TERMS (cont.)

Copyright 2000-2014 Avago Technologies. All rights reserved.
Copyright (C) 2006 GTCO CalComp
Copyright 2017 Tempo Semiconductor, Inc. Author: Steven Eckhoff <steven.eckhoff.opensource@gmail.com>
Copyright (c) 2006 - 2016 Intel Corporation. All rights reserved.
Copyright (C) 2018-2019 Netronome Systems, Inc.
Copyright (C) 2013 Texas Instruments Incorporated - <http://www.ti.com> Author: Kishon Vijay Abraham I <kishon@ti.com>
Copyright (C) 1995 Linus Torvalds Adapted from 'alpha' version by Gary Thomas Modified by Cort Dougan (cort@cs.nmt.edu) Modified by PPC64 Team, IBM Corp
Copyright (C) 2013 Daniel Tang <tangrs@tangrs.id.au>
Copyright (c) 2014 Oracle Co., Daniel Kiper
Copyright (C) 2009 Igor M. Liplianin (liplianin@me.by)
Copyright (C) 1998, 1999, 2001 Philip Blundell
Copyright 2019 Annaliese McDermond
Copyright (c) 2003-2008 Chelsio, Inc. All rights reserved.
Copyright (C) 2016 Oracle. All Rights Reserved. Author: Darrick J. Wong <darrick.wong@oracle.com>
Copyright 2014 Gateworks Corporation
Copyright (C) 2010 Matt Fleming
Copyright (C) 2005 Russell King. Data taken from include/asm-i386/serial.h
Copyright (c) 2010-2012, NVIDIA CORPORATION. All rights reserved.
Copyright (C) 2010-2012 Texas Instruments, Inc.
Copyright (c) 2012 - 2018 Microchip Technology Inc., and its subsidiaries All rights reserved.
Copyright 2019 NXP Author: Daniel Baluta <daniel.baluta@nxp.com>
Copyright (C) 2000, 2002, 2003 Jeff Dike (jdike@karaya.com)
Copyright (C) 2017 Cadence Design Systems - <http://www.cadence.com>
Copyright 2002-2005, Devicescape Software, Inc.
Copyright (c) 2005 Koninklijke Philips Electronics N.V.;(c) MontaVista Software, Inc.
Copyright (C) 2011 - 2016, Yann Collet. BSD 2 - Clause License (<http://www.opensource.org/licenses/bsd-license.php>) Redistribution and use in source and binary forms, with or without modification, are permitted provided that the following conditions are met:
Copyright (c) 2014 Samsung Electronics Co., Ltd.
Copyright 2002-2009, 2011-2013 Freescale Semiconductor, Inc.
Copyright (C) 2009, Intel Corp. Author: Huang Ying <ying.huang@intel.com>
(C) 2012 Michel Lespinasse <walken@google.com>
Copyright (C) 2019 Marek Behun <marek.behun@nic.cz>
Copyright 2008 Tensilica Inc.
Copyright (C) 2012-2019 NVIDIA Corporation. All rights reserved.
Copyright (c) 2003 Evgeniy Polyakov <zbr@ioremap.net>
Copyright (C) 2006 Harald Welte <laforge@openex.org>
Copyright (c) 2014 - 2018, NVIDIA CORPORATION. All rights reserved.
Copyright (C) 1996, 1999 David S. Miller (davem@redhat.com)
Copyright 2009 Sony Corporation
Copyright (C) Alex Holden <alex@linuxhacker.org> 1998, 1999.
Copyright (C) 2008, 2009 Intel Corporation Authors: Andi Kleen, Fengguang Wu
Copyright (C) 1998 Ingo Molnar
Copyright (C) 2012 Andrew Lunn
Copyright (c) 2018 Intel Corporation. All rights reserved.
Copyright 2007 (c) Ian Molton <spyro@f2s.com>
"Copyright (C) 2014 Texas Instruments Incorporated - <http://www.ti.com> Author: Sandeep Nair <sandeep_n@ti.com> Cyril Chemparathy <cyril@ti.com> Santosh Shilimkar <santosh.shilimkar@ti.com>"
Copyright (c) 2016 Huawei Limited.
Copyright (C) 2008 <srinivasa.deevi at conexant dot com> Based on cx88 driver
Copyright (C) 2011 Freescale Semiconductor, Inc.
Copyright IBM Corp. 2002, 2018
Copyright IBM Corp. 2001, 2006 Author(s): Carsten Otte <cotte@de.ibm.com> Tuan Ngo-Anh <ngoanh@de.ibm.com> Martin Schwidofsky <schwidofsky@de.ibm.com>
(C) 2007 Patrick McHardy <kaber@trash.net>
Copyright (C) 2011 Steve Glendinning <steve.glendinning@shawell.net>
Copyright 2009 Daniel Ribeiro <drwyrn@gmail.com>
Copyright (C) 2016 Cavium Inc.
Copyright (C) 2010-2017 Digital Devices GmbH Ralph Metzler <rjkm@metzlerbros.de> Marcus Metzler <mocm@metzlerbros.de>
Copyright (C) 2012 ST Microelectronics Shiraz Hashim <shiraz.linux.kernel@gmail.com>
Copyright (C) 2014 Ondrej Zary
Copyright Samuel Mendoza-Jonas, IBM Corporation 2018.
Copyright (C) ST-Ericsson SA 2011 Author: Lee Jones <lee.jones@linaro.org> for ST-Ericsson.
Copyright (C) 2013,2014 Samsung Electronics Krzysztof Kozlowski <krzk@kernel.org>
Copyright (c) 2004 Topspin Corporation. All rights reserved.
Copyright 2009 Larry Finger <Larry.Finger@lwfinger.net>
Copyright (C) 2010 Samsung Electronics Author: Michal Nazarewicz <mina86@mina86.com>
Copyright (c) 2007, Intel Corporation. All Rights Reserved.
Copyright 2014-2015 Freescale Semiconductor, Inc.
Copyright (c) 2012-2016 Synaptics Incorporated
Copyright (c) 2002-3 Patrick Mochel
Copyright (C) 2011-2013 Intel Corporation
Copyright (C) 2014-2018 Xilinx
Copyright (C) 1998-2005 Russell King
Copyright 2007, 2008 Siemens AG
Copyright (C) 2015-2019 Cirrus Logic, Inc. and Cirrus Logic International Semiconductor Ltd.
Copyright (C) 2016-2018 Texas Instruments Incorporated - <http://www.ti.com/>
Copyright (C) 1995, 1996 Olaf Kirch <okir@monad.swb.de>
Copyright 2000, 2001 (c) Trond Myklebust <trond.myklebust@fys.uio.no>
Copyright (c) 2016 MediaTek Inc. Author: Garlic Tseng <garlic.tseng@mediatek.com>
(c) 2007 MSC Vertriebsges.m.b.H, Manuel Lauss <mlau@msc-ge.com>
Copyright (C) ST-Ericsson 2010 - 2013 Author: Martin Persson <martin.persson@stericsson.com> Hongbo Zhang <hongbo.zhang@linaro.com>
Copyright (C) 2017 Maxim Integrated
Copyright 2009 Intel Corporation. Huang Ying <ying.huang@intel.com>
Copyright(c) 2015 Intel Corporation. All rights reserved.
Copyright (c) 2016 MediaTek Inc. Author: PC Chen <pc.chen@mediatek.com> Tiffany Lin <tiffany.lin@mediatek.com>
Copyright 2003 Tungsten Graphics, Inc., Cedar Park, Texas. All Rights Reserved.
Copyright (C) 2003-2010 PEAK System-Technik GmbH
(C) Copyright Linaro 2016v2
Copyright (C) 2001 Ben. Herrenschmidt (benh@kernel.crashing.org)
Copyright (C) 2001 RidgeRun, Inc. Author: Greg Lonnon <glonnon@ridgerun.com>
(C) 2005 Red Hat Inc;(C) 2011 Bartlomiej Zolnierkiewicz
Copyright (C) 2009 Albert Herranz
Copyright (C) 2000 Ralph Metzler <ralph@convergence.de> Marcus Metzler <marcus@convergence.de> for convergence integrated media GmbH
Copyright (C) Russell King.
Copyright (C) 2008 Yoichi Yuasa <yuasa@linux-mips.org>
Copyright 2017-2018 NXP.
Copyright (C) 2013 Kirill V Tkhai (tkhai@yandex.ru)
Copyright (C) 2016 Socionext Inc. Author: Masahiro Yamada <yamada.masahiro@socionext.com>
Copyright (C) 1996-1997 Paul H. Hargrove This file may be distributed
Copyright © 2001 Flaga hf. Medical Devices, Kári Davíðsson <kd@flaga.is>
Copyright 2018 NXP Author: Chenhui Zhao <chenhui.zhao@freescale.com>
Copyright (c) 2013 Alexey Degtyarev <alexey@renatasystems.org>
Copyright (C) 2002 Paul Mackerras, IBM Corp.
Copyright (C) 2009-2010 Marvell International Ltd.
Copyright (C) 2016 Broadcom Corporation
Copyright 2012-2015 Freescale Semiconductor, Inc.
Copyright (C) 2009 Net Insight AB

LICENCE TERMS (cont.)

Copyright (C) 2008 - 2014 Freescale Semiconductor Inc.
Copyright 2003,2004 Andi Kleen SuSE Labs
Copyright (C) 2005-2007 kogiidena
(C) Copyright David Gibson, IBM Corporation 2008.
Copyright 2001 MontaVista Software Inc. Author: MontaVista Software, Inc. stevel@mvista.com or source@mvista.com
Copyright 2013 Linaro
Copyright (C) 2006 Tensilica Inc.
Copyright(C) 2005-2006, Thomas Gleixner <tglx@linutronix.de>
Copyright (C) 2015 Rockchip Electronics Co., Ltd.
Copyright (c) 2005 Jim Cromie <jim.cromie@gmail.com>
Copyright (C) 2015, Intel Corporation Author: Rafael J. Wysocki <rafael.j.wysocki@intel.com>
Copyright (c) 2013 Carlo Caione 2012 Henrik Nordstrom;(c) Copyright 2010 Novell, Inc.
Copyright (C) 2009 VIA Technologies, Inc.
Copyright (c) 2003-2006 QLogic Corporation
Copyright (c) 2010-2014, The Linux Foundation. All rights reserved.
Copyright (C) 2017 Oracle. All rights reserved.
Copyright (c) 2017 NVIDIA Corporation.
Copyright (C) 1997, 1998, 1999, 2000, 2009 Ingo Molnar, Hajnalka Szabo Moved from arch/x86/kernel/apic/io_apic.c. Jiang Liu <jiang.liu@linux.intel.com>
Copyright (c) by Jaroslav Kysela <perex@perex.cz> Uros Bizjak <uros@kss-loka.si>
Copyright (C) 2000 Marc Boucher <marc@mbsi.ca>
Copyright 2018 Cadence Design Systems, Inc.
Copyright (C) 2000 Asit Mallick <Asit.K.Mallick@intel.com>
Copyright (C) 2012 Hans Verkuil <hans.verkuil@cisco.com>
Copyright (C) 2004,2005 ADDI-DATA GmbH for the source code of this module.
Copyright (C) 2015-2016 Texas Instruments Incorporated - http://www.ti.com/ Andrew F. Davis <afd@ti.com>
Copyright (c) 2011 Christian Strobel <christian.strobel@iis.fraunhofer.de>
Copyright (C) 2015, Intel Corporation Authors: Mathias Nyman <mathias.nyman@linux.intel.com> Mika Westerberg <mika.westerberg@linux.intel.com>
Copyright (C) 1997 Geert Uytterhoeven
Copyright (C) 2015 Freescale Semiconductor, Inc. All Rights Reserved.
Copyright 2011 Intel Corporation; author Matt Fleming
Copyright (C) 2004 - 2005 Nokia corporation Written by Tuukka Tikkanen <tuukka.tikkanen@elektrobit.com> Based on clocks.h by Tony Lindgren, Gordon McNutt and RidgeRun, Inc
Copyright (C) 2009 Valentin Longchamp, EPFL Mobots group
Copyright (c) 2011 Jiri Kosina
Copyright (C) Altera Corporation 1998-2001
Copyright (C) 2010 Patrick Boettcher, Kernel Labs Inc. PO Box 745, St James, NY 11780
Copyright (c) 2010, NVIDIA Corporation.
Copyright (C) 2007-2009 Sam Ravnborg <sam@ravnborg.org>
Copyright 2015, Cyril Bur, IBM Corp.
Copyright (c) 2007-2011, Intel Corporation. All Rights Reserved.
Copyright (C) 2011 Samsung Electronics Co.Ltd Authors: Joonyoung Shim <jy0922.shim@samsung.com>
Copyright (C) 2019, Red Hat, Inc.
(C) Copyright 2003, Greg Ungerer (gerg@snapgear.com)
Copyright 2012 Denis 'GNUtoo' Carikli <GNUtoo@no-log.org>
Copyright (C) 2012 Invensense, Inc.
Copyright (c) 1999 by Takashi Iwai <tiwai@suse.de>
Copyright 2014 - Hans de Goede hdegoede@redhat.com
中文版维护者: 钟宇 TripleX Chung <xxx.phy@gmail.com>
中文版翻译者: 钟宇 TripleX Chung xxx.phy@gmail.com, 时奎亮 Alex Shi <alex.shi@linux.alibaba.com>
中文版校译者: 李阳 Li Yang <leoyang.li@nxp.com>, 王聪 Wang Cong <xiyou.wangcong@gmail.com>
Linus Torvalds 是决定改动能否进入 Linux 内核的最终裁决者。他的 e-mail 地址是 torvalds@linux-foundation.org
Copyright [copyl] 2001-2004 Stelian Pop <stelian@popies.net>
Copyright (C) 2018 ARM Ltd.
Copyright (C) 2006 David S. Miller (davem@davemloft.net)

Copyright 2018 Andrej Shadura <andrew@shadura.me> Loosely based on drivers/hid/hid-led.c and drivers/usb/misc/chaoskey.c
Copyright (C) 2018 Arm Limited. All rights reserved.
Copyright (C) 2004-2010 Nokia Corporation
Copyright (c) 2008 Gerrit Renker <gerrit@erg.abdn.ac.uk>
Copyright (C) 2011 John Crispin <john@phrozen.org>
Copyright (C) 1989, 1992, 1993, 1994, 1995 Free Software Foundation, Inc.
Copyright (C) 2004-2005 Martin Langer <martin-langer@gmx.de>
Copyright (C) 2009-2010 Freescale Semiconductor, Inc. All Rights Reserved.
Copyright (C) 1994, 1996, 1997, 1998 Free Software Foundation, Inc.
Copyright (C) 2017, The Linux Foundation. All rights reserved.
(C) Copyright Linus Torvalds 1999;(C) Copyright Johannes Erdfelt 1999-2001;(C) Copyright Andreas Gal 1999;(C) Copyright Gregory P. Smith 1999;(C) Copyright Deti Fliegl 1999;(C) Copyright Randy Dunlap 2000;(C) Copyright David Brownell 2000-2002
Copyright 2013
Copyright (c) 2011 Frederick van der Wyck <fvanderwyck@gmail.com>
Copyright (C) 2005 Antonino Daplas <adaplas@pol.net>
Copyright (C) 2007 David S. Miller <davem@davemloft.net>
Copyright (c) 2007 Byron Bradley
Copyright (c) 2009-2013, 2016-2018, The Linux Foundation. All rights reserved.
Copyright (C) 2019 Arm Limited
Copyright 2006 Johannes Berg <johannes@sipsolutions.net>;(c) container_of(c, struct onyx, codec)
Copyright 1994, Drew Eckhardt
Copyright (C) 2016 Atmel Corporation
Copyright 2012 Free Electrons
Copyright (C) 2007 PA Semi, Inc;(C) Copyright IBM Deutschland Entwicklung GmbH 2005
Copyright (c) 2019 Robert Eshleman <bobbyeshleman@gmail.com>
Copyright (C) 2016 Texas Instruments Author: Jyri Sarha <jsarha@ti.com>
Copyright (C) 2015, Intel Corporation.
Copyright (C) 2013 secunet Security Networks AG
Copyright (c) Dmitry Torokhov <dtor@mail.ru>
Copyright (c) 2014 Intel Corporation. All rights reserved.
Copyright (C) 2012, Samsung Electronics, Co., Ltd. Sylwester Nawrocki <s.nawrocki@samsung.com> Andrzej Hajda <a.hajda@samsung.com>
Copyright 2009 Prodrive B.V..
Copyright © 2015 Intel Corporation
Copyright (C) 2014 Samsung Electronics Co.Ltd
Copyright (C) 2003 - 2008 Nokia Corporation Author: Juha Yrjölä <juha.yrjola@nokia.com> DMA channel linking for 1610 by Samuel Ortiz <samuel.ortiz@nokia.com> Graphics DMA and LCD DMA graphics tranformations by Imre Deak <imre.deak@nokia.com>
Copyright (c) 2003-2015 Broadcom Corporation
Copyright 2018 Realtek Semiconductor Corp. Author: Shuming Fan <shumingf@realtek.com>
Copyright (c) (2005-2007) Imagination Technologies Limited.
Copyright (C) 1995-1998 Linus Torvalds & author (see below)
Copyright (C) 2015 STMicroelectronics Limited. Author: Gabriel Fernandez <gabriel.fernandez@linaro.org>
Copyright (C) 2015 STMicroelectronics Ltd
Copyright (c) 2017-2018 The Linux Foundation. All rights reserved. */
Copyright (c) 2004 Kiran Kumar Immidi <immidi_kiran@yahoo.com>
Copyright(c) 2007 - 2016 Realtek Corporation.
Copyright (c) 2001 Chris Atenasio <chris@crud.net>
Copyright (C) 2016 Axentia Technologies AB
Copyright IBM Corp. 1999, 2009 Author(s): Martin Peschke <mpeschke@de.ibm.com> Martin Schwidefsky <schwidefsky@de.ibm.com>
Copyright 2002 Ryan Holm <ryan.holmQVist@idt.com>
Copyright (c) 2009 Richard Walmisley <richwalm@gmail.com>;(c) hid_map_usage(hi, usage, bit, max, EV_ABS, (c));(c) hid_map_usage(hi, usage, bit, max, EV_REL, (c))
Copyright 2019 Linaro Ltd. YAML 1.2

LICENCE TERMS (cont.)

Copyright (C) 2001 Russell King;(C) Copyright 1998 Linus Torvalds
Copyright (C) 2013 Imagination Technologies Ltd.
Copyright (c) 2016 MediaTek Inc. Author: Kevin Chen <kevin-cw.chen@mediatek.com>
Copyright (C) 2011-2012 ST Microelectronics Author: Vincenzo Frascino <vincenzo.frascino@st.com>
Copyright (C) STMicroelectronics 2017 - All Rights Reserved Author: Torgue Alexandre <alexandre.torgue@st.com>
for STMicroelectronics.
(C) Copyright IBM Corporation 2009
"Copyright (C) 2014 Texas Instruments Incorporated Authors: Sandeep Nair <sandeep_n@ti.com> Sandeep Paulraj <s-paulraj@ti.com> Cyril Chemparathy <cyril@ti.com> Santosh Shilimkar <santosh.shilimkar@ti.com> Wingman Kwok <w-kwok2@ti.com> Murali Karicheri <m-karicheri2@ti.com>"
Copyright (c) 2009, Microsoft Corporation.
Copyright (c) 2015 Heiko Stuebner <heiko@sntech.de>
Copyright (C) 2015 Alban Bedel <albeu@free.fr>
Copyright(c) 1999 - 2006 Intel Corporation.
Copyright (C) 2014 NVIDIA CORPORATION. All rights reserved.
Copyright (C) 2008 Intel Corp
Copyright (C) 2001 PPC64 Team, IBM Corp
Copyright (C) 1999 IBM Deutschland Entwicklung GmbH, IBM Corporation
Copyright (C) 2018-2019 Cadence Design Systems.
Copyright (C) 2006. Bob Jenkins (bob_jenkins@burtleburtle.net)
Copyright (C) 2001 James.Bottomley@HansenPartnership.com
Copyright 1999 Ben Pfaff <pfaffben@debian.org> and Petr Vandrovec <VANDROVE@vc.cvut.cz> Based on VGA info at <http://www.goodnet.com/~tinara/FreeVGA/home.htm>;(c) 1998 Gerd Knorr <kraxel@goldbach.in-berlin.de>
Copyright (c) 2017 Intel Deutschland GmbH
Copyright (C) 1999 Christoph Rohland;(c) 1999 Manfred Spraul <manfred@colorfullife.com> namespaces support.
2006 OpenVZ, SWsoft Inc. Pavel Emelianov <xemul@openvz.org>
Copyright (C) 2005-2007 Micronas
Copyright (C) 2002 - 2008 Jeff Dike (jdike@{addtoit,linux.intel}.com)
Copyright (C) 2017 Helge Deller <deller@gmx.de>
Copyright (C) 2014 Luca Ellero <luca.ellero@brickedbrain.com>
Copyright (c) 2018 Johannes Thumshirn, SUSE Linux GmbH
Copyright 2017-2018 Qiang Yu <yuq825@gmail.com>
Copyright 2013 Linaro Ltd. All rights reserved.
"Copyright: (c) 1998 Ben Greear"
Copyright (C) 1999 Hewlett-Packard Co
Copyright (C) 2017 William Breathitt Gray
Copyright (C) 2011 Atmel, 2011 Nicolas Ferre <nicolas.ferre@atmel.com>
Copyright (C) 2008 Henrik Rydberg (rydberg@euromail.se)
Copyright (c) 2009-2013 QLogic Corporation QLogic Linux qlcnic NIC Driver
Copyright (C) 2008 David S. Miller <davem@davemloft.net>
Copyright (C) 2013 Intel Corporation Author: Andy Shevchenko <andriy.shevchenko@linux.intel.com>
Copyright (C) 1992,1995,1997 | W. Metzenthien, 22 Parker St, Ormond, Vic 3163, | Australia. E-mail billm@suburbia.net |
Copyright (C) 2011-2016 Freescale Semiconductor, Inc. All Rights Reserved.
Copyright (C) 2009 emlix GmbH, Oskar Schirmer <oskar@scara.com>
Copyright (C) 2015-2017 Renesas Electronics Corporation
Copyright (C) 2014 Elan Microelectronics Corporation. Scott Liu <scott.liu@emc.com.tw>
Copyright (C) 2004 Silicon Graphics, Inc.
Copyright(c) 2008 John W. Linville <linville@tuxdriver.com>
Copyright (C) 2015 Ash Charles, Gumstix, Inc.
Copyright (C) 2005-2009 Rodolfo Giometti <giometti@linux.it>
Copyright (c) 2007 Rafael J. Wysocki <rjw@sisk.pl>
Copyright (C) 2000 Ani Joshi <ajoshi@unixbox.com>
Copyright (C) 2012 Russell King Rewritten from the dovefb driver, and Armada510 manuals.
Copyright 2017 BayLibre, SAS Author: Neil Armstrong <narmstrong@baylibre.com>
Copyright (C) 2009 Albin Tonnerre, Free Electrons <albin.tonnerre@free-electrons.com>
Copyright (C) 2004 Freescale Semiconductor, Inc.:(C) 2004 Intracom, S.A.:(C) 2006 MontaVista Software, Inc. Vitaly

Bordug <vbordug@ru.mvista.com>
Copyright (c) 2011-2015 Andrew Lutomirski
Copyright (C) 2018 Kirill Marinushkin <kmarinushkin@birdec.com>
Copyright (C) 2013 Chanh Min <chanho.min@lge.com>
Copyright (c) 2014 Samsung Electronics Co., Ltd. Author: Jaewon Kim <jaewon02.kim@samsung.com> Author: Hyunhee Kim <hyunhee.kim@samsung.com>
Copyright (C) 2019 Microsoft Corporation.
Copyright (C) 2009 Nokia Corporation Paul Walmsley
Copyright: |copy| 2019 Intel Corporation
"Copyright (C) Jay Lan SGI"
Copyright (C) 2004 Red Hat, Inc. All rights reserved.
Copyright 2005-2006 PMC-Sierra, Inc.
Copyright (C) 2003,2004 Hewlett-Packard Company
Copyright (c) 2019 Intel Corporation.
Copyright 2016 STMicroelectronics Inc.
Copyright © 2010 Luca Barbieri
(C) Copyright 1994 Linus Torvalds
Copyright (C) 2017 MIPS Tech, LLC
(C) 1997-1998 by Thomas Sailer, HB9JNX/AE4WA
Copyright (C) 2016 Joachim Eastwood <manabian@gmail.com>
"Copyright (C) 2014 Linaro Ltd. Author: Ashwin Chaugule <ashwin.chaugule@linaro.org>"
Copyright (C) 2000 Hewlett Packard (Paul Bame bame@puffin.external.hp.com)
Copyright (c) 2016-2017 Andreas Färber
Copyright (c) 2015, NVIDIA Corporation.
Copyright (c) 2013 Nicira, Inc.
(c) Copyright 2008 Wim Van Sebroeck <wim@iguana.be>.
(C) 2016 Pengutronix, Alexander Aring <aar@pengutronix.de>
Copyright 2017 Chen-Yu Tsai
Copyright (C) 2000 - 2008 Jeff Dike (jdike@{addtoit,linux.intel}.com)
Copyright (C) 2008-2011 Freescale Semiconductor, Inc. Author: Timur Tabi <timur@freescale.com>
Copyright (C) 2004 Texas Instruments, Inc.
Copyright (c) International Business Machines Corp., 2008 Author(s): Steve French (sfrench@us.ibm.com)
Copyright IBM Corp. 1999, 2010 Author(s): Cornelia Huck (cornelia.huck@de.ibm.com) Arnd Bergmann (arndb@de.ibm.com) Peter Oberparleiter <peter.oberparleiter@de.ibm.com>
Copyright (c) 2008 Rodolfo Giometti <giometti@linux.it>
Copyright (c) 2019, Jeffrey Hugo. All rights reserved.
Copyright (c) 2008, 2009 open80211s Ltd.
Copyright (c) 2018 Nuvoton Technology corporation.
Copyright Altera Corporation (C) <2014>. All rights reserved
Copyright (c) 2019 Facebook include <features.h>
Copyright (C) 1996, 1998, 1999, 2000, 2004 David S. Miller (davem@redhat.com)
Copyright (c) 2016, Jamal Hadi Salim
Copyright 2008-2013 Solarflare Communications Inc.
Copyright (C) 1998 Jakub Jelinek (jj@sunsite.mff.cuni.cz)
Copyright (C) 2012 Paul Parsons <lost.distance@yahoo.com>
Copyright (C) 2018 Author(s): Hendrik Brueckner <brueckner@linux.vnet.ibm.com>
Copyright (C) 2013 Emilio López <emilio@elopez.com.ar>
Copyright (c) 2014 Samsung Electronics Co., Ltd. Author: Andrey Ryabinin <ryabinin.a.a@gmail.com>
(c) Copyright 2005 Benjamin Herrenschmidt, IBM Corp. benh@kernel.crashing.org>;(c) container_of(c, struct wf_lm75_sensor, sens)
Copyright (C) 2014 LSI Corporation
Copyright 2006 Jake Moilanen <moilanen@austin.ibm.com>, IBM Corp.
Copyright (C) 2000 Matthew Wilcox (willy a debian . org)
Copyright (C) 2011 Prashant Shah, pshah.mumbai@gmail.com
Copyright (c) 2012-2017 Mentor Graphics Inc.
Copyright (c) 2001 by Hansjoerg Lipp <hlipp@web.de>, Tilman Schmidt <tilman@imap.cc>, Stefan Eilers.
Copyright (C) 2009-2010, Lars-Peter Clausen <lars@metafoo.de> JZ4740 platform IRQ support

LICENCE TERMS (cont.)

Copyright 2012, Anton Blanchard, IBM Corporation.
Copyright (C) 2018 Cogent Embedded, Inc.
Copyright (C) 2012 Benjamin Herrenschmidt, IBM Corp.
Copyright (C) 2016, STMicroelectronics - All Rights Reserved Author: Fabrice Gasnier <fabrice.gasnier@st.com>.
Copyright 2011 Linus Walleij <linus.walleij@linaro.org>
Copyright (c) 2013-2015, The Linux Foundation. All rights reserved.
Copyright(c) 2009 - 2018 Intel Corporation.
(c) 2006 Red Hat
Copyright 2000-2002 Andi Kleen, SuSE Labs.
Copyright (C) 2009 ST-Ericsson
Copyright (C) 1999 Mike Bernson <mike@mlb.org>
Copyright (C) 2016,2017 ARM Limited, All Rights Reserved. Author: Marc Zyngier <marc.zyngier@arm.com>
Copyright (c) 2015 MediaTek Inc. Author: Mars.C <mars.cheng@mediatek.com>
(C) Copyright 1998 Linus Torvalds;(C) Copyright 2005 Andi Kleen;(C) Copyright 2008 Glauber Costa
Copyright (C) 2007, 2008 Nippon Telegraph and Telephone Corporation.
(C) Copyright 1999, Greg Ungerer (gerg@snapgear.com);(C) Copyright 2000, Lineo Inc. (www.lineo.com)
Copyright (c) 1991,1992,1995 Linus Torvalds
Copyright (C) 2016-2018 Texas Instruments, Inc. Dave Gerlach <d-gerlach@ti.com>
Copyright 2015-2016 Collabora Ltd.
Copyright (c) 2002 ShuChen <shuchen@realtek.com.tw>
Copyright (C) 2008 Intel Corp.
Copyright © 2009 - Maxim Levitsky driver for Ricoh xD readers
Copyright (C) Freescale Semiconductor, Inc. 2006. All rights reserved.
(C) Copyright 2014-2015 Intel Corporation
Copyright (C) 2007 Alexey Starikovskiy <astarikovskiy@suse.de>
Copyright (c) 2019 Artur Rojek <contact@artur-rojek.eu>
Copyright (C) 2014-2018 Jonathan Morton <chromatix99@gmail.com>
Copyright © 1999-2010 David Woodhouse <dwmw2@infradead.org> et al.
Copyright (C) 1996, 2008 David S. Miller (davem@davemloft.net)
(c) 2007-2011 MSC Vertriebsges.m.b.H., Manuel Lauss <manuel.lauss@gmail.com>
Copyright (C) 1998 Dave Perks <dperks@ibm.net>
Copyright (C) 2007 Marvell Internation Ltd.
Copyright (C) 2016 Maxime Ripard <maxime.ripard@free-electrons.com>
(C) 2005 Red Hat (<http://www.redhat.com>) This file may be distributed
Copyright 2013 Greg Ungerer <gerg@uclinux.org>
Copyright (c) 2019 Hisilicon Limited.
Copyright (C) 2007-2010 Florian Fainelli <florian@openwrt.org>
Copyright (C) 2012 - 2018 Xilinx, Inc
Copyright (C) 2017 Icenowy Zheng <icenowy@aosc.xyz>
Copyright (C) 2004 Oracle. All rights reserved.
Copyright (C) 2009 Gabor Juhas <juhosg@openwrt.org>
Copyright (c) 2003-2005 Simtec Electronics Ben Dooks <ben@simtec.co.uk>
Copyright(c) 2016-2017 Realtek Semiconductor Corp. All rights reserved.
Copyright (C) 1996-98 Ingo Molnar, Gadi Oxman
Copyright (C) 2010 Samo Pogacnik
Copyright (C) 2009 Igor M. Liplianin <liplianin@me.by>
Copyright (C) 2006 8D Technologies inc.
Copyright (C) 2011 Carsten Emde <C.Emde@osadl.org>
Copyright 2015 IBM Corporation Author: Mahesh Salgaonkar <mahesh@linux.vnet.ibm.com>
Copyright 2015, Qualcomm Atheros, Inc.
Copyright (c) 2017 Chelsio Communications, Inc. All rights reserved.
(c) 2001 Michael Eskin, Tom Zakrajsek [Windows version];(c) 2002 Yuriy Sysoyev <yurij@naturesoft.net>;(c) 2003 Gerd Knorr <kraexel@bytestex.org>
Copyright (C) 2013-2015 Cogent Embedded, Inc.
Copyright (c) 2005 Misha Zhilin <misha@epiphany.com>
Copyright 2008 Wolfson Microelectronics PLC. Author: Liam Girdwood <lrg@slimlogic.co.uk>;(c) snd_soc_component_write(c, WM8990_RESET, 0)

Copyright (C) 2014-2015 STMicroelectronics SAS. All rights reserved.
Copyright (C) 2014 Regents of the University of California
Copyright (c) 2006 Luc Verhaegen (quirks list)
Copyright (C) 2016 - ARM Ltd Author: Marc Zyngier <marc.zyngier@arm.com>
Copyright (c) 2007 Mauro Carvalho Chehab <mchehab@kernel.org>
Copyright (c) 2003-2004, Keir Fraser & Steve Hand
Copyright (c) 2008, Intel Corporation.
Copyright (c) 2003 by Clemens Ladisch <clemens@ladisch.de> All rights reserved.
Copyright 2006 Free Software Foundation, Inc.
Copyright (C) 2005 Intel Corp.
Copyright (C) 2013 Fred Richter <frichter@hauppauge.com> driver structure based on lgdt3305.[ch] by Michael Krufky code based on LG3306_V0.35 API by LG Electronics Inc.
Copyright 2016 Tom van der Wiel
Copyright (c) 2014 Philipp Zabel <p.zabel@pengutronix.de>, Pengutronix
Copyright (C) 2007-2011 Freescale Semiconductor, Inc.
Copyright (c) 2004 Simtec Electronics <linux@simtec.co.uk> <http://www.simtec.co.uk/products/SWLINUX/>
Copyright (c) 2000 Jaroslav Kysela <perex@perex.cz> 2002 Takashi Iwai <tiwai@suse.de>
Copyright (C) 2015 Imre Kaloz <kaloz@openwrt.org>
Copyright (c) 2000 ATecoM GmbH
Copyright (C) Intel 2010
Copyright (C) 1999-2006 Moxa Technologies (support@moxa.com).
Copyright (C) 2001-2002 Will Dyson <will_dyson@pobox.com>
Copyright (2004) Linus Torvalds
Copyright (C) 2017 Sudip Mukherjee, All Rights Reserved.
Copyright(c) 2008-2018 Intel Corporation.
Copyright (c) 2017 Jesper Dangaard Brouer, Red Hat Inc.
Copyright (c) 2015-2017 Takashi Sakamoto <o-takashi@sakamocchi.jp>
Copyright (C) 2015 ARM Limited Author: Dave Martin <Dave.Martin@arm.com>
Copyright (c) 2017, Fuzhou Rockchip Electronics Co., Ltd All rights reserved.
Copyright (C) 2017 Atmel
Copyright (C) 2005 Kirk Lapray <kirk_lapray@bigfoot.com>
Copyright (C) 2003, 2004 Paul Mundt
Copyright 2017, Daniel Axtens, IBM Corporation. based on crc32c-vpmsum_glue.c
Copyright 2007, 2008 Wolfson Microelectronics PLC.
Copyright (c) 2002, Dr Brian Gladman <brg@gladman.me.uk>, Worcester, UK. All rights reserved.
Copyright (C) 2012-2018 Texas Instruments Incorporated - <http://www.ti.com/> Dave Gerlach, Vaibhav Bedia
Copyright (C) 2006 Qumranet, Inc.
(C) Copyright 2008 Applied Micro Circuits Corporation Victor Gallardo <vgallardo@amcc.com> Adam Graham <agraham@amcc.com>
Copyright (C) 2013 Linaro Limited. Author: Sandeepa Prabhu <sandeepa.prabhu@linaro.org>
Copyright IBM Corp. 2005, 2017 Author(s): Jan Glauber (jang@de.ibm.com) Sebastian Siewior (sebastian@breakpoint.cc) SW-Fallback Patrick Steuer <patrick.steuer@de.ibm.com> Harald Freudenberger <freude@de.ibm.com>
Copyright (C) 2014-2016 Zi Shen Lim <zlim.lnx@gmail.com>
Copyright (C) 2013 Aeroflex Gaisler AB
Copyright (C) 1999 Hewlett-Packard (Frank Rowand)
Copyright (C) 1996,1997 Fredrik Noring, Lars Brinkhoff & Tomas Berndtsson
Copyright (C) 2013 Politecnico di Torino, Italy TORSEC group -- <http://security.polito.it>
Copyright (C) 2011-2014 Freescale Semiconductor, Inc. All Rights Reserved.
Copyright (C) 2004 Rusty Russell IBM Corporation
(C) 2015 Pengutronix, Alexander Aring <aar@pengutronix.de>
Copyright (C) 2013 Hauke Mehrtens <hauke@hauke-m.de>
Copyright (C) 2012 ST Microelectronics Viresh Kumar <viresh.kumar@linaro.org>
Copyright (C) 2013 Fusion IO. All rights reserved.
Copyright (C) 2012 International Business Machines Inc.
Copyright (c) by Jaroslav Kysela <perex@perex.cz>, Isaku Yamahata <yamahata@private.email.ne.jp>, George Hansper <ghansper@apana.org.au>, Hannu Savolainen

LICENCE TERMS (cont.)

Copyright (C) 2017 - Cambridge Greys Ltd
Copyright 2004 Embedded Edge, LLC dan@embeddededge.com
Copyright (C) 1997-2000 Richard Gooch
Copyright (C) Intel 2011
Copyright (c) 2015 PLUMgrid, <http://plumgrid.com>
Copyright (C) Secret Lab Technologies Ltd. 2006. All rights reserved.
Copyright (c) 2017, Intel Corporation. All rights reserved.
Copyright (c) 2008 Herbert Xu <herbert@gondor.apana.org.au>
Copyright (c) 2015-2016, The Linux Foundation. All rights reserved.
Copyright (C) 2007 Lemote Inc. Author : jlliu, liujl@lemote.com
(C) 2012 by Lemonage GmbH Author: Lars Poeschel <poeschel@lemonage.de> All rights reserved.
Copyright (c) 2016 Jamal Hadi Salim <jhs@mojatatu.com>
Copyright (C) 2003 Krzysztof Halasa <khc@pm.waw.pl>
Copyright (C) 2009-2010 Texas Instruments Incorporated - <http://www.ti.com/> Nishanth Menon Kevin Hillman
Copyright (C) 2015 ST Microelectronics
Copyright (c) 2017 T-Chip Intelligent Technology Co., Ltd
Copyright (c) 2011, NVIDIA Corporation. Author: Jin Park <jinyoungp@nvidia.com>
Copyright (C) 2009 Samsung Electronics Kim Kyuwon <q1.kim@samsung.com>
Copyright 2014-2015 Freescale
Copyright (C) 2006 Greg Kroah-Hartman <gregkh@suse.de>
Copyright 1998 Red Hat corp --- All Rights Reserved
Copyright (c) 2010 by Jarod Wilson <jarod@redhat.com>
Copyright (C) 1999, 2005, 2010 Thomas Sailer (t.sailer@alumni.ethz.ch)
Copyright (c) 2010 Herbert Xu <herbert@gondor.apana.org.au>
Copyright: (C) 2012 Peter Senna Tschudin, INRIA/LIP6. URL: <http://coccinelle.lip6.fr/>
Copyright (c) 2016 Rockchip, Inc.
Copyright (c) 2017 Cadence Cadence PCIe controller driver. Author: Cyrille Pitchen <cyrille.pitchen@free-electrons.com>
Copyright (C) 2018 Microchip Technology Inc.
Copyright: 2011 Raumfeld GmbH Author: Johannes Stezenbach <js@sig21.net>
Copyright (C) 1998-2009 Texas Instruments. All rights reserved.
Copyright 1994-1998 Paul Mackerras.
Copyright (c) 2006 Simtec Electronics <http://armlinux.simtec.co.uk/> Ben Dooks <ben@simtec.co.uk>
Copyright (C) 2000-2001, 2003 Hewlett-Packard Co Stephane Eranian <eranian@hpl.hp.com>
Copyright (c) 2014, Applied Micro Circuits Corporation Authors: Iyappan Subramanian <isubramanian@apm.com>
Keyur Chudgar <kchudgar@apm.com>
Copyright (C) 2019 HUAWEI, Inc. <http://www.huawei.com/> Created by Gao Xiang <gaoxiang25@huawei.com>
Copyright © International Business Machines Corp., 2006
Copyright 2016 Free Electrons
(c) 1998-2002 Petr Vandrovec <vandrove@vc.cvut.cz>;(c) 1998 Gerd Knorr <kxrael@cs.tu-berlin.de>
Copyright 2010 - 2015 UNISYS CORPORATION All rights reserved.
Copyright (c) 2008-2009 Marvell Semiconductor
Copyright (c) 2004 Shannon Holland <holland@loser.net>
Copyright (C) 2011 Jarod Wilson <jarod@redhat.com>
Copyright (c) 2010 Cisco Systems, Inc.
© Scharfe Samuel Tardieu Shawn O. Pearce Steffen Prohaska Steve Haslam
(c) 1997-8 Grant R. Guenther <grant@torque.net> Under the terms of the GPL.
Copyright(c) 2005 Intel Corporation. All rights reserved.
Copyright (C) 2003-2014 STMicroelectronics (R&D) Limited Author: Srinivas Kandagatla <srinivas.kandagatla@st.com> Contributors: Giuseppe Cavallaro <peppe.cavallaro@st.com>
Copyright (C) 2001 - 2013 Tensilica Inc.
Copyright (C) 2001 Russell King;(C) 2002 - 2003 Dominik Brodowski <linux@brodo.de>
Copyright (C) 2004-2005 Borislav Deianov <borislav@users.sf.net>
(c) 1996 Hans-Joachim Wiedmaier - Rewritten;(C) 1993 Ray Burr - Modified for Amiga FFS filesystem.:(C) 1992 Eric Youngdale Modified for ISO9660 filesystem.:(C) 1991 Linus Torvalds - minix filesystem
Copyright (c) 2008 Tomasz Grobelny <tomasz@grobelny.oswiecienia.net>
Copyright (c) 2010, Code Aurora Forum. All rights reserved.

Copyright (C) 2014, Samsung Electronics Co. Ltd. All Rights Reserved.
Copyright(c) 2011 Intel Corporation. All rights reserved.
Copyright (C) 2014 Russell King
Copyright (c) 1997 by Procom Technology, Inc. 2001 by Arnaldo Carvalho de Melo <acme@conectiva.com.br>
Copyright (C) 2007 Carlos Corbacho <carlos@strangeworlds.co.uk>
(C) Copyright 1999 Roman Weissgaerber <weissg@vienna.at>;(C) Copyright 2000-2002 David Brownell <dbrownell@users.sourceforge.net>;(C) Copyright 2002 Hewlett-Packard Company;(C) Copyright 2005 Chris Humbert <mahadri-usb@drigon.com>;(C) Copyright 2007, 2008 Dmitry Baryshkov <dbaryshkov@gmail.com>;(C) Copyright 2004 Lineo Solutions, Inc.
Copyright (c) 2008 Adrian-Ken Rueegsegger <ken@codelabs.ch>
Copyright (C) 2017 Madhavan Srinivasan, IBM Corporation.:(C) 2017 Anju T Sudhakar, IBM Corporation.:(C) 2017 Hemant K Shaw, IBM Corporation.
Copyright (c) 2019 Kevin Darbyshire-Bryant <dir@darbyshire-bryant.me.uk>
Copyright 2015 IBM Corporation.
Copyright (C) 2006, 2009, 2010, 2011 Texas Instruments Incorporated Author: Aurelien Jacquot (aurelien.jacquot@jaluna.com)
Copyright Red Hat, Inc. 2013-2014
Copyright (C) 2012 Renesas Solutions Corp. Kuninori Morimoto <kuninori.morimoto.gx@renesas.com>
Copyright (C) 1999-2002 Vojtech Pavlik
Copyright 2001 Benjamin LaHaise.
Copyright(c) 2009 - 2014 Intel Corporation. All rights reserved.
Copyright 2009 Jerome Glisse.
Copyright (c) 2017 Rockchip Electronics Co. Ltd.
Copyright (c) 2018 MediaTek Inc. Author: Weiyi Lu <weiyi.lu@mediatek.com>
Copyright (c) 2015 ARM Ltd.
(C) Copyright 2002 Linus Torvalds Portions based on the vds0-randomization code from exec-shield:
Copyright (C) 2009 - 2016 STMicroelectronics
(C) Copyright 1999 Roman Weissgaerber <weissg@vienna.at>;(C) Copyright 2000-2002 David Brownell <dbrownell@users.sourceforge.net>
Copyright 2005-2015 Freescale Semiconductor, Inc. All Rights Reserved.
Copyright (C) 2009 Red Hat Inc, Steven Rostedt <ststedt@redhat.com>
Copyright (C) 2009 Jason Baron <jbaron@redhat.com>
Copyright (C) 2018 metux IT consult Author: Enrico Weigelt <info@metux.net>
Copyright (C) 2016 Intel Corporation
Copyright (C) 2011 Texas Instruments Inc.
Copyright (C) 2015 Microchip Technology, Inc.
Copyright 2008 Jerome Glisse. All Rights Reserved.
Copyright (C) 2007, 2008 MIPS Technologies, Inc.
Copyright (c) 2017 Manivannan Sathasivam <manivannanece23@gmail.com>
Copyright (C) 2005 - 2011 Paul Mundt
Copyright (C) 1999-2000 Thomas Sailer (sailer@ife.ee.ethz.ch)
Copyright (c) 2011 Wind River Systems, Inc.
Copyright (C) 2002 ARM Ltd. All Rights Reserved
Copyright (C) 1999-2004 Hewlett-Packard Co David Mosberger-Tang <davidm@hpl.hp.com>
Copyright (C) 2000 LASAT Networks A/S.
Copyright (c) 2016 Icenowy Zheng <icenowy@aosc.io>
Copyright (C) 2015 by Sang Engineering
"Copyright 2009 Johannes Berg <johannes@sipsolutions.net>"
(c) Copyright 2009 Google Inc., All Rights Reserved.:(c) Copyright 2000 kernel concepts <nils@kernelconcepts.de>, All Rights Reserved. <http://www.kernelconcepts.de>
Copyright (C) 2004 Amit S. Kale <amitkale@linsyssoft.com>
Copyright (C) 2013-15, Intel Corporation. All rights reserved.
Copyright (c) 2014 Applied Micro Circuits Corporation.
(C) 1998 Christian Schmidt <schmidt@digadd.de>;(C) 1998 Tom Lees <tom@lpsg.demon.co.uk> Minor reorganizations by David Hinds <dahinds@users.sourceforge.net>;(C) 2001, 2002 by: Alan Cox <alan@redhat.com> Thomas Hood Brian Gerst <bgerst@didntduck.org>;(C) 2002 by Adam Belay <ambx1@neo.rr.com>
Copyright (C) 1999 by Kaz Kojima

LICENCE TERMS (cont.)

Copyright (C) 2005 Stephen Street / StreetFire Sound Labs
Copyright (C) 2001,2003,2004 Dell <Matt_Domsch@dell.com>
Copyright(c) 2016-2018 Broadcom
Copyright (c) 2017 Synopsys, Inc. (www.synopsys.com)
Copyright (c) 2000,1 Compaq Computer Corporation. (Author: Jamey Hicks)
Copyright (C) 2004-2008 Cavium Networks
Copyright (C) 2006 Michael Ellerman, IBM Corporation.
Copyright 2006-2007 Pierre Ossman
Copyright 2012 Pavel Machek <pavel@denx.de>
Copyright (C) 1997 Eddie C. Dost (ecd@skynet.be)
Copyright (C) 1997 Cobalt Microserver
Copyright (C) 2004-2008, LINBIT Information Technologies GmbH.
Copyright (C) 2011 Marc Dietrich <marvin24@gmx.de>
(C) Copyright IBM Corporation 2005
Copyright 2018 Digi International, Inc.
Copyright (C) 2007 Rodolfo Giometti <giometti@linux.it>
Copyright © 2011 WORK Microwave GmbH
Copyright (C) 2006 David S. Miller <davem@davemloft.net>
Copyright: 2014 Raumfeld GmbH Author: Sven Brandau <info@brandau.biz>
Copyright (c) 2016 Laurent Pinchart <laurent.pinchart@ideasonboard.com>
Copyright (C) 2003 - 2009 NetXen, Inc.
Copyright (C) 2016 Red Hat, Inc. All Rights Reserved. Written by David Howells (dhowells@redhat.com)
Copyright (C) 2003 Samuel Rydh (samuel@ibrium.se)
Copyright (C) Paul Mackerras 2005 All Rights Reserved.
Copyright (C) 1997, 1998, 2005 David S. Miller (davem@davemloft.net)
Copyright (C) STMicroelectronics 2017 - All Rights Reserved Author: Alexandre Torgue <alexandre.torgue@st.com> for STMicroelectronics.
Copyright (C) 2010 Texas Instruments, Inc. - http://www.ti.com/
Copyright (C) 2013 Steffen Trumtrar <s.trumtrar@pengutronix.de>
Copyright (C) 2005-2007 Hans Verkuil <hverkuil@xs4all.nl>
Copyright (C) 2009 Chen Liqin <liqin.chen@sunplusct.com>
Copyright (c) 2017, Mellanox Technologies inc. All rights reserved.
Copyright (c) 2018 VMware
Copyright (C) 2005-2009 Texas Instruments Inc
Copyright (C) 2009-2010 Samsung Electronics Kyungmin Park <kyungmin.park@samsung.com> Marek Szymowski <m.szymowski@samsung.com>
Copyright 2007, 2008 Freescale Semiconductor Inc.
Copyright (C) 2009-2010, Lars-Peter Clausen <lars@metafoo.de> JZ4740 IRQ definitions
Copyright (C) 1999-2003, Greg Ungerer (gerg@snapgear.com)
Copyright (c) 2011 Google, Inc.
Copyright (c) 2001-2021, Huawei Tech. Co., Ltd. Author: chenjun <chenjun14@huawei.com>
Copyright (C) 2016-2019 Renesas Electronics Corporation
Copyright (C) 2008 Christian Kormacker <ckormacker@suse.de>
Copyright 2005 Pacific Digital Corporation. OSL/GPL code release authorized by Jalil Fadavi).
Copyright (C) 2009 David S. Miller (davem@davemloft.net)
Copyright (c) 2018, Ericsson AB All rights reserved.
Copyright 2007 Benjamin Herrenschmidt, IBM Corp. benh@kernel.crashing.org>;(c) 2003, Benjamin Herrenschmidt (benh@kernel.crashing.org);(c) 2004-2005, Eugene Surovegin <ebs@ebshome.net>
Copyright (C) 2019-present Lenovo
Copyright(c) 2014 - 2015 Google Inc. All rights reserved.
Copyright 2002, Jouni Malinen <jkmaline@cc.hut.fi>
Copyright (c) 2020 NXP.
Copyright (C) 2013 STMicroelectronics (R&D) Limited. http://www.st.com
Copyright (c) 2016-2017 Linaro Ltd.
Copyright 2013-2016 Freescale Semiconductor, Inc.
Copyright (C) 2016, Intel Corporation Author: Andy Shevchenko <andriy.shevchenko@linux.intel.com>
(C) 2006-2008 by Openmoko, Inc. All rights reserved.

Copyright (c) 2007 Steven Toth <stoth@linuxtv.org>
Copyright (C) 2008 Steven Toth <stoth@linuxtv.org>
Copyright (c) 2012 Qualcomm Atheros, Inc.
Copyright (c) 2009 Jussi Kivilinna <jussi.kivilinna@mbnet.fi>
Copyright (c) 2017 Niels Skou Olsen <nolsen@jabra.com>
(c) Copyright 2005 Benjamin Herrenschmidt, IBM Corp. benh@kernel.crashing.org>;(c) container_of(c, struct smu_ad_sensor, sens);(c) container_of(c, struct smu_cpu_power_sensor, sens)
Copyright (C) 2015 ARM Ltd. Author: Marc Zyngier <marc.zyngier@arm.com>
Copyright (C) 2006, 2008 Oracle. All rights reserved.
Copyright (C) 2002 Hewlett-Packard Company
Copyright (C) 2004-2006 Thomas Kleffel, All Rights Reserved.
Copyright (C) STMicroelectronics 2016
Copyright (C) 2014 Robert Jarzmik
Copyright (C) 2015 Russell King
Copyright 2005, Broadcom Corporation
Copyright (C) 2002-2004 Yoichi Yuasa <yuasa@linux-mips.org>
Copyright (C) 1995 Russell King
Copyright(c) 2015-17 Intel Corporation.
Copyright (c) 2002 [year of first publication] The Regents of the University of Michigan All Rights Reserved
Copyright (C) 2007 by Latchesar Ionkov <luchio@ionkov.net>
Copyright (C) 2014 Heiko Schocher <hs@denx.de>
Copyright 2008, Jouni Malinen <j@w1.fi>
Copyright (c) 2016-2019, NVIDIA CORPORATION. All rights reserved.
Copyright (C) 2012 MIPS Technologies, Inc. All rights reserved. Authors: Sanjay Lal <sanjayl@kymasys.com>
Copyright (C) 2001 Russell King.
Copyright (C) 2005 Rusty Russell <rusty@rustcorp.com.au>
Copyright (c) 2008 by: Ben Woodard <woodard@redhat.com> Mauro Carvalho Chehab
Copyright (C) 2004-2017 Cavium, Inc.
Copyright (C) 2006 Rusty Russell IBM Corporation
Copyright (c) 1995,1996 Bradford W. Johnson <johns393@maroon.tc.umn.edu>
Copyright 2013-2019 Analog Devices Inc. Author: Lars-Peter Clausen <lars@metafoo.de>
Copyright (C) 2005-2006 Texas Instruments, Inc.
Copyright (C) 2016 Linaro Ltd
Copyright (C) 2012 Numascale AS. All rights reserved.
Copyright 2002-2005 MontaVista Software Inc.
Copyright (C) 2010 Texas Instruments, Inc. Thara Gopinath <thara@ti.com>
Copyright 2009 Cyber Switching, Inc.
Copyright (c) 2014-2015 The Linux Foundation. All rights reserved.
Copyright (c) 2016 Rockchip Electronics Co. Ltd. Author: Elaine <zhangqing@rock-chips.com>
Copyright (C) 2013 Xenia Ragjadakou
Copyright (C) 1999-2000, 2002-2003, 2005 Hewlett-Packard Co David Mosberger-Tang <davidm@hpl.hp.com>
Copyright 2011 Intel Corporation
Copyright (c) 2005 Dirk Opfer
Copyright (c) 2013 Tony Prisk <linux@prisktech.co.nz>
Copyright (C) 2013 Shuah Khan <shuah.kh@samsung.com>
Copyright (c) 2008-2011 Freescale Semiconductor, Inc.
Copyright (c) 2013-2014 Samsung Electronics Co., Ltd http://www.samsung.com
Copyright (C) 2003, 2005 Oracle. All rights reserved.
Copyright (C) 2012 Atmel
Copyright (c) 2017, Applied Micro Circuits Corporation Author(s): Iyappan Subramanian <isubramanian@apm.com>
Copyright (C) 1999, 2000, 2001 by Michael Engel <engel@unix-ag.org>, Karsten Merker <merker@linuxtag.org>
Copyright (C) 1997 Markus Schroeder (schroedm@uni-duesseldorf.de) minor modifications by Ralph Metzler (rjkm@thp.uni-koeln.de)
Copyright (C) 2011 Oracle. All rights reserved.
Copyright 2011 Matt Evans <matt@ozlabs.org>, IBM Corporation
(c) Copyright Hewlett-Packard Development Company, L.P., 2007
Copyright 2001 - 2005 Tensilica Inc.

LICENCE TERMS (cont.)

Copyright (C) 2006 Intel Corp. Tom Long Nguyen (tom.l.nguyen@intel.com) Zhang Yanmin (yanmin.zhang@intel.com);(C) Copyright 2009 Hewlett-Packard Development Company, L.P. Andrew Patterson <andrew.patterson@hp.com>
Copyright (c) 2018 Martin Blumenstingl <martin.blumenstingl@googlemail.com>.
Copyright (C) 2007 Krzysztof Halasa <khc@pm.waw.pl>
Copyright (C) 2007-2008, 2012 Texas Instruments, Inc.
Copyright (C) 2007 Intel Corporation <linux-wimax@intel.com> Inaky Perez-Gonzalez <inaky.perez-gonzalez@intel.com>
(C) Copyright 2004, Greg Ungerer (gerg@snapgear.com)
Copyright (C) 2015 Ash Charles, Gumstix Inc.
Copyright (c) 2016-2018 Christoph Hellwig.
Copyright (C) 2019, Intel Corporation
Copyright (c) 1999-2008 LSI Corporation mailto:DL-MPTFusionLinux@lsi.com
Copyright IBM Corp 2019
(c) Copyright 2010 Novell, Inc.
Copyright (c) 2012 Cambridge Silicon Radio Limited, a CSR plc group company.
Copyright (C) 2014 Intel Corporation. All rights reserved. Contact: David Cohen <david.a.cohen@linux.intel.com>
Copyright (C) 2009 STMicroelectronics Ltd
Copyright (C) 2011 ST Microelectronics Viresh Kumar <vireshk@kernel.org>
Copyright 2015-2016, Aneesh Kumar K.V, IBM Corporation.
Copyright (C) 2002 by Ralf Baechle
Copyright (c) 2018 Mellanox Technologies
Copyright (c) 2016 FUKAUMI Naoki <naobsd@gmail.com>
Copyright © 2008-2018 Intel Corporation
Copyright (c) 2010 Novell, Inc. Author(s): Suresh Jayaraman <sjayaraman@suse.de>
Copyright (C) 1997-2011 AudioScience Inc. <support@audioscience.com>;(C) Copyright AudioScience Inc. 1998-2010
Copyright (C) 2012 Marvell International Ltd. Qiao Zhou <zhouqiao@marvell.com>
Copyright: [copy] 2006, 2007 Simtec Electronics
Copyright (c) 1999 Algorithmics Ltd
Copyright (C) 2015 - Ben Herrenschmidt, IBM Corp.
(c) 2009,2010 Dick Streefland <dick@streefland.net> Licensed
Copyright (C) 2013 STMicroelectronics Limited Author: Srinivas Kandagatla <srinivas.kandagatla@st.com>
Copyright 2010 Nokia Corporation Contact: Felipe Balbi <felipe.balbi@nokia.com>
Copyright: [copy] 2017 Intel Corporation
Copyright (c) 2012-2016,2018-2019, The Linux Foundation. All rights reserved.
Copyright (C) 2008 Compulab, Ltd. Mike Rapoport <mike@compulab.co.il>
"Copyright (C) Jay Lan, <jlan@sgi.com>"
Copyright (C) 1994 by Linus Torvalds Modifications for the OpenRISC architecture:
Copyright (c) 2008 Simtec Electronics http://armlinux.simtec.co.uk/ Ben Dooks <ben@simtec.co.uk>
Copyright (c) 2016 Amlogic, Inc. Author: Michael Turquette <mturquette@baylibre.com>
Copyright (C) 2015 Altera Corporation. All rights reserved.
Copyright (C) 2015 ARM Limited, All Rights Reserved. Author: Marc Zyngier <marc.zyngier@arm.com>
Copyright 2001, 2003-2005 MontaVista Software Inc.
Copyright (C) 2004 Intel
Copyright (C) 2014-2015 Marvell
Copyright © 2011 Tony Breeds IBM Corporation
Copyright (c) 2012, Intel Corporation. Author: Liu, Jinsong <jinsong.liu@intel.com>
Copyright (C) 2015 Stefan Agner
Copyright (c) 2017 Microsoft Corporation Author: Matthew Wilcox <willy@infradead.org>
Copyright (c) 2000-2010 Adaptec, Inc. 2010-2015 PMC-Sierra, Inc. (aacraid@pmc-sierra.com) 2016-2017 Microsemi Corp. (aacraid@microsemi.com)
Copyright 1993, 1994 Drew Eckhardt Visionary Computing Unix and Linux consulting and custom programming
Copyright (C) 1999-2009 Tensilica Inc.
Copyright © 2009 Intel Corporation
Copyright (C) 2010 Gyungoh Yoo <jack.yoo@maxim-ic.com>
Copyright (c) 2017 MediaTek Inc. Author: Kevin Chen <kevin-cw.chen@mediatek.com>

"Copyright: (C) 2011 Texas Instruments, Inc."
Copyright (C) 1993 -- 1997 Drew Eckhardt, Frederic Potter, David Mosberger-Tang
Copyright 2008, Broadcom Corporation
Copyright (C) 2011 Thomas Langer <thomas.langer@lantiq.com>
Copyright (C) 2013, Intel Corporation Authors: Andy Shevchenko <andriy.shevchenko@linux.intel.com> Mika Westerberg <mika.westerberg@linux.intel.com>
Copyright (C) 2015 CompuLab Ltd. - http://www.complab.co.il/ Author: Ilya Ledvich <ilya@compulab.co.il>
Copyright (c) 2011-2018, The Linux Foundation. All rights reserved.
(c) 2005 Benjamin Herrenschmidt <benh at kernel.crashing.org>, IBM Corp.:(c) 2005 Becky Bruce <becky.bruce at freescale.com>, Freescale Semiconductor, FSL SOC and 32-bit additions;(c) 2006 MontaVista Software, Inc. Flash chip node definition
Copyright (c) 2015 Oracle and/or its affiliates. All Rights Reserved.
Copyright (c) 2003 Mark M. Hoffman <mhoffman@lightlink.com>
Copyright IBM Corp. 2015 Author(s): Hendrik Brueckner <brueckner@linux.vnet.ibm.com>
Copyright 2009-2011 Christian Lamparter <chunkeey@googlemail.com>
Copyright (C) 2006 Benjamin Herrenschmidt, IBM Corp. benh@kernel.crashing.org
Copyright (C) 2013-2015 Corentin LABBE <clabbe.montjoie@gmail.com>
Copyright (C) 2009-2010 Freescale Semiconductor, Inc. Author: Becky Bruce
Copyright (c) 2014 MediaTek Inc. Author: Eddie Huang <eddie.huang@mediatek.com>
Copyright (c) 2003 Dave Engebretsen <engebret@us.ibm.com>
(C) Copyright 1999 Linus Torvalds
Copyright (C) 1993 Stephen Tweedie (sct@redhat.com) from
Copyright 2008-2013 Freescale Semiconductor, Inc. All Rights Reserved.
Copyright (c) 1999-2004 Vojtech Pavlik
Copyright (c) 2015 Qualcomm Atheros, Inc.
Copyright (c) 2013 Jie Liu. All Rights Reserved.
Copyright 2004-2006 Freescale Semiconductor, Inc. All Rights Reserved.
Copyright (c) 2009-2010 Micrel, Inc. Tristram Ha <Tristram.Ha@micrel.com>
Copyright (C) 2016 Intel Corporation Author: Felipe Balbi <felipe.balbi@linux.intel.com>
Copyright (C) 2009 picoChip Designs Ltd, Jamie Iles
Copyright © 2012-2013 Jussi Kivilinna <jussi.kivilinna@iki.fi>
Copyright 2015 Technexion Ltd.
Copyright 2006 Wolfson Microelectronics PLC. Author: Liam Girdwood <lrg@slimlogic.co.uk>
Copyright (c) 2019, Oracle and/or its affiliates. All rights reserved.
Copyright (C) STMicroelectronics SA 2015 Authors: Arnaud Pouliquen <arnaud.pouliquen@st.com> for STMicroelectronics.
Copyright (C) 2009-2014 Texas Instruments, Inc.
Copyright (C) 2002-2003 Marcel Holtmann <marcel@holtmann.org>
Copyright (c) 2006 Ralf Baechle (ralf@linux-mips.org)
Copyright (C) 2010 Tom Zanussi <tzanussi@gmail.com>
Copyright 2013 Realtek Semiconductor Corp. Author: Bard Liao <bardliao@realtek.com>
Copyright (C) 2002 Takayoshi Kochi <t-kochi@bq.jp.nec.com>
(C) Copyright IBM Corporation 2006. Author : Ram Pai (linuxram@us.ibm.com)
(c) Copyright 2002 Ryan Bradetich;(c) Copyright 2002 Hewlett-Packard Company
Copyright (c) 2017 Texas Instruments Incorporated Tero Kristo <t-kristo@ti.com>
Copyright 2007 Freescale Semiconductor, Inc. All Rights Reserved.
Copyright (C) 2002-2005 Eric Biederman <ebiederm@xmission.com>
Copyright (C) Purism SPC 2019
Copyright (C) 2006-2006 Harald Welte <laforge@netfilter.org>
Copyright (C) 2012 ST Ericsson Corporation
Copyright (C) 2016 Linaro Ltd.
Copyright (C) 2014-2018 Broadcom
Copyright: [copy] 2015, Intel Corporation Author: Lv Zheng <lv.zheng@intel.com>
Copyright (C) 2013,2014 Russell King
Copyright (C) 2012-2013 Jonas Gorski <jogo@openwrt.org>
Copyright (C) 2003, 2004 SUGIOKA Toshinobu
Copyright (C) 2017 Stafford Horne <shorne@gmail.com>

LICENCE TERMS (cont.)

Copyright (c) 2008-2009 Rodolfo Giometti <giometti@linux.it>
Copyright (c) 2011-2015 Samsung Electronics Co., Ltd. <http://www.samsung.com/>
Copyright (C) 2002 Joachim Wuttke <Joachim.Wuttke@icn.siemens.de>
Copyright (C) 2006 Benjamin Herrenschmidt, IBM Corp. benh@kernel.crashing.org and Arnd Bergmann, IBM Corp.
Copyright (c) 1994, 95, 96, 97, 98, 2000, 01 Ralf Baechle
Copyright (C) 2011 ARM Ltd. All Rights Reserved
Copyright (c) <year> <owner> . All rights reserved.
(C) Copyright 2000-2010, Greg Ungerer <gerg@snapgear.com>
Copyright (C) 2017 Chen-Yu Tsai Chen-Yu Tsai <wens@csie.org>
Copyright (C) 2018 ARM Limited, All Rights Reserved. Author: Marc Zyngier <marc.zyngier@arm.com>
Copyright (C) 2004-2005, 2008, 2013 Red Hat, Inc. All Rights Reserved. Written by David Howells (dhowells@redhat.com)
Copyright (C) 2006 FON Technology, SL.
Copyright (c) 2017 Robert Munteanu SPDX-License-Identifier: GPL-2.0+
Copyright (C) 2014 Filipe David Borba Manana <fdmanana@gmail.com>
Copyright (C) 2008 Thomas Chou <thomas@wytron.com.tw>
Copyright (C) 2003 Peter Milne, D-TACQ Solutions Ltd Peter dot Milne at D hyphen TACQ dot com>
Copyright 2011, ARM Ltd.
Copyright 2015 Maciej Szmigiero <mail@maciej.szmigiero.name>
Copyright (C) 2015 Cavium, Inc.
Copyright 2009-2017 Canonical Ltd.
Copyright (C) 2009 Lemote Inc. Author: Yanhua <yanh@lemote.com> Author: Wu Zhangjin <wuzhangjin@gmail.com>
Copyright (C) 2011 Samsung Electronics Co., Ltd. Author: HeungJun Kim <riverful.kim@samsung.com>
Copyright (C) 2015 Red Hat, Inc.
(C) 2005-2006 Red Hat Inc Alan Cox <alan@lxorguk.ukuu.org.uk>
Copyright (C) 2014 Casey Schaufler <casey@schaufler-ca.com>
Copyright (C) 1999 Cort Dougan <cort@cs.nmt.edu>
Copyright (c) 2016, Applied Micro Circuits Corporation Author: Loc Ho <lho@apm.com> Hoan Tran <hotran@apm.com>
Copyright (c) 2004-2005 Anton Altaparmakov
Copyright (c) 2010 Phillip Lougher <phillip@squashfs.org.uk>
Copyright (C) 2016 Parav Pandit <pandit.parav@gmail.com>
Copyright 2007 IBM Corp. Hugh Blemings <hugh@au.ibm.com> based off code by Josh Boyer <jwboyer@linux.vnet.ibm.com>, David Gibson <dwg@au1.ibm.com>
Copyright (C) 1997-2000 Jakub Jelinek (jakub@redhat.com)
Copyright IBM Corp. 1999, 2008 Author(s): Ingo Adlung (adlung@de.ibm.com) Cornelia Huck (cornelia.huck@de.ibm.com) Arnd Bergmann (arndb@de.ibm.com) Martin Schwidofsky (schwidofsky@de.ibm.com)
Copyright (C) 2009 - 2011 Michal Simek <monstr@monstr.eu>
Copyright (C) 2004-5 Patrick Boettcher (patrick.boettcher@posteo.de)
Copyright (C) 2018 Lucas A. M. Magalhães <lucmaga@gmail.com>
Copyright (C) 2004 Herbert Poetzi <herbert@13thfloor.at>
Copyright 2009-2014 VMware, Inc., Palo Alto, CA., USA
Copyright (C) 2016 Renesas Solutions Corp. Kuninori Morimoto <kuninori.morimoto.gx@renesas.com>
"Copyright (c) 2016 Mediatek Authors: Xiaolei Li <xiaolei.li@mediatek.com> Jorge Ramirez-Ortiz <jorge.ramirez-ortiz@linaro.org>"
Copyright (C) 2004-2008 Red Hat, Inc. All Rights Reserved. Written by David Howells (dhowells@redhat.com)
Copyright (C) 2013-2016 Red Hat Author: Rob Clark <robdclark@gmail.com>
Copyright (C) 1998 Russell King.
Copyright (C) 2015 Cypress Semiconductor, Inc.
Copyright 2012-2016 Freescale Semiconductor, Inc.
Copyright (C) 2008 Marvell International Ltd.
Copyright 2014 Martin Peres
Copyright (C) 2011 Texas Instruments. All rights reserved.
Copyright (C) 2006-2008 Nippon Telegraph and Telephone Corporation.
Copyright (C) 2007 Antti Palosaari <crope@iki.fi>
Copyright (C) 1995 Richard Hirst [richard@sleepie.demon.co.uk]
Copyright 2015 Samuel Pitoiset
Copyright (C) 2017 Impinj, Inc.
Copyright (C) IBM 2005
Copyright (c) 2015-2017, VeriSilicon Inc.
Copyright 1994 by Björn Brauel
Copyright (C) 2019 Pengutronix, Philipp Zabel
Copyright (C) 2000-2001 Richard Hirst <rhirst@parisc-linux.org>
Copyright (C) 2008 Janne Grunau (jj@jannau.net)
Copyright (C) 2000 Andrea Arcangeli <andrea@suse.de> SuSE
Copyright 2014 Martin Peres <martin.peres@free.fr>
Copyright (c) 2019 Pensando Systems, Inc
Copyright 2019 Collabora Ltd.
Copyright (C) 2008 Instituto Nokia de Tecnologia Contact: Eduardo Valentin <eduardo.valentin@indt.org.br>
Copyright (ST) 2012 Rajeev Kumar (rajeevkumar.linux@gmail.com)
Copyright (c) 2010-2015, NVIDIA Corporation.
Copyright (c) 2015--2017 Intel Corporation.
(C) 2012 Christoph Lameter <cl@linux.com>
Copyright (c) 2011 Ondrej Zary;(c) 2001-2002 Andrey Ulanov <drey@rt.mipt.ru> which was partially based on:(c) 1999 Ben Pfaff <pfaffben@debian.org> and Petr Vandrovec <VANDROVE@vc.cvut.cz>;(c) 1998-1999 Precision Insight, Inc., Cedar Park, Texas. i740fb by Patrick LERDA, v0.9;(c) 2011 Ondrej Zary <linux@rainbow-software.org>; MODULE_DESCRIPTION("fbdev driver for Intel740");
Copyright (c) 2014 Cadence Design Systems Inc.
Copyright (C) 2009 The GameCube Linux Team
Copyright (C) 2006 Micron Technology Inc.
Copyright 2003-2008, Jouni Malinen <jj@w1.fi>
(c) 2002-2007, Benjamin Herrenschmidt (benh@kernel.crashing.org)
Copyright (C) 2014 Samsung Electronics Author: Chanwoo Choi <cw00.choi@samsung.com>
Copyright (C) 2017 Raspberry Pi Trading Ltd.
Copyright (c) 2015 Markus Stockhausen <stockhausen@collogia.de>
Copyright (C) 2013 Ideas On Board SPRL
Copyright (C) 2008 Constantin Baranov <const@mimas.ru>
Copyright (c) 2004 Mellanox Technologies Ltd. All rights reserved.
Copyright (c) 2018-19, Linaro Limited
Copyright (C) 2002 Erich Focht <efocht@ess.nec.de>
Copyright IBM Corp. 1999 Author(s): Martin Schwidofsky (schwidofsky@de.ibm.com),
Copyright (c) 2003-2013 QLogic Corporation QLogic Linux iSCSI Driver
Copyright (C) 1991-2002 Linus Torvalds
Copyright (c) by Jaromir Koutek <miri@punknet.cz>, Jaroslav Kysela <perex@perex.cz>, Thomas Sailer <sailer@ife.ee.ethz.ch>, Abramo Bagnara <abramo@alsa-project.org>, Markus Gruber <gruber@eikon.tum.de>
Copyright (c) International Business Machines Corp., 2002,2013 Author(s): Steve French (sfrench@us.ibm.com)
Copyright (C) 2011 Atmel, Nicolas Ferre <nicolas.ferre@atmel.com>
Copyright (C) 2008, 2009 secunet Security Networks AG
Copyright (c) 2008 Marc Pignat <marc.pignat@hevs.ch>
(c) G. Liakhovetski <g.liakhovetski@gmx.de>
Copyright (C) 2009-2016 Cavium, Inc.
Copyright 2000-2001, 2006-2008 MontaVista Software Inc. Author: MontaVista Software, Inc. <source@mvista.com>
Copyright (C) 2014-2019 aQuantia Corporation.
Copyright (c) 2016-2019, The Linux Foundation. All rights reserved.
Copyright(C) 2010 Jarod Wilson <jarod@wilsonet.com> Portions based on the original lirc_imon driver,
Copyright 2006 Dave Airlie <airlied@linux.ie>
Copyright (C) 2005-2008 Yoshinori Sato
Copyright 2017, IBM Corporation cpufeatures is the new way to discover CPU features with /cpus/features devicetree.
Copyright (c) 2012, TAOS Corporation.
Copyright (c) 2013, 2014 Guenter Roeck <linux@roeck-us.net>
Copyright (C) 2005 Markus Rechberger <mrechberger@gmail.com> Ludovico Cavedon <cavedon@sss.it> Mauro Carvalho Chehab <mchehab@kernel.org>

LICENCE TERMS (cont.)

Copyright 2007-2008,2010 Freescale Semiconductor, Inc.
Copyright (C) 2006 C&C Technologies, Inc.
Copyright (C) 2010-2015 Freescale Semiconductor, Inc.
Copyright 2008 Rusty Russell IBM Corporation
Copyright (c) 2005-2008 Michael Buesch <m@bues.ch>
Copyright (C) BitBox Ltd 2010
Copyright (C) 2015 Mickaël Salaün <mic@digikod.net>
Copyright (C) 199x the Anonymous
Copyright (c) 2012 BTicino S.p.A.
Copyright (c) 2016 BayLibre, SAS Author: Neil Armstrong <narmstrong@baylibre.com>
Copyright (C) 2015 Facebook. All rights reserved.
Copyright 2011 Wolfson Microelectronics
Copyright (c) 2017 Ruslan Bilovol <ruslan.bilovol@gmail.com>
Copyright (c) 2006 Andriy Skulysch <askulysyh@gmail.com>
Copyright (C) IBM Corporation, 2002, 2004
(c) Copyright 2006-2011 Wim Van Sebroeck <wim@iguana.be>.
Copyright (C) 2018 Microchip Technology Inc. and its subsidiaries
"Copyright (C) 2014 Texas Instruments Incorporated Authors: Sandeep Nair <sandeep_n@ti.com> WingMan Kwok <w-kwok2@ti.com>"
Copyright (C) 2007 Yoichi Yuasa <yuasa@linux-mips.org>
Copyright (C) 2015, 2016 Zodiac Inflight Innovations
Copyright (C) 2011 Picochip, Jamie Iles
Copyright (c) 2003-2004, Jouni Malinen <jkmaline@cc.hut.fi>
Copyright (c) 2015, Applied Micro Circuits Corporation Author: lyappan Subramanian <isubramanian@apm.com>
Copyright (C) 2005-2006 Micronas USA Inc.
Copyright (C) 1998, 2001 by Ralf Baechle
Copyright (C) STMicroelectronics SA 2014 Author: Vincent Abriou <vincent.abriou@st.com> for STMicroelectronics.
Copyright (C) 2000 IBM Corporation Author(s): DJ Barrow (djbarrow@de.ibm.com,barrow_dj@yahoo.com) William Stearns <wstearns@pobox.com>
Copyright (c) 2015, 2018, The Linux Foundation. All rights reserved.
Copyright (C) 2007 Jan D. Louw <jd.louw@mweb.co.za>
Copyright (C) 2007 Alain Degreffe (eczema@ecze.com)
Copyright (C) 2013 Imagination Technologies Author: Paul Burton <paul.burton@mips.com>
Copyright (c) 2017 Radioavionica Corporation Author: Alex A. Mihaylov <minimumlaw@rambler.ru>
Copyright (C) 2002 David Howells (dhowells@redhat.com) Incorporating suggestions made by Linus Torvalds
Copyright (C) 2008-2010 Jonathan Cameron
Copyright (C) 2018 Red Hat, Inc., Arnaldo Carvalho de Melo <acme@redhat.com>
Copyright (C) 2017-2019 Broadcom. All Rights Reserved. The term
Copyright (c) 2016-2018 Oracle. All rights reserved.
Copyright (C) 2009 NetUP Inc.
Copyright 2007, 2008, 2009 Wolfson Microelectronics PLC.
(C) 2003 Marc Zyngier <maz@wild-wind.fr.eu.org> modified for SNI usage by Thomas Bogendoerfer
Copyright 2008 Red Hat Inc.
Copyright 2015 Broadcom
Copyright 2014 Texas Instruments, Inc. Santosh Shilimkar <santosh.shilimkar@ti.com>
Copyright (c) 2005 James Simmons
Copyright 2008 Cavium Networks Richard Liu <richard.liu@caviumnetworks.com>
Copyright (c) 2003-2015 Chelsio Communications, Inc. All rights reserved.
Copyright (C) 1997-2000 Russell King
Copyright (c) 2006, 2017 Oracle and/or its affiliates. All rights reserved.
Copyright (C) 2006 STMicroelectronics Limited Author: Carl Shaw <carl.shaw@st.com>
Copyright (C) 1999 David A. Schleef <ds@schleef.org>
Copyright (C) 1997 Eric Youngdale
Copyright (C) 2005-2007 David Brownell
Copyright 1997-1998 Transmeta Corporation -- All Rights Reserved
Copyright (c) 2014-2016, NVIDIA CORPORATION. All rights reserved.
Copyright IBM Corp. 2000, 2001

(C) Dominik Brodowski <linux@brodo.de> 2003 and contained the following comments:
Copyright (C) 1999-2007 Greg Ungerer (gerg@snapgear.com)
Copyright (C) 2015 Phytect Messtechnik GmbH Author: Teresa Remmet <t.remmet@phytec.de>
(C) 1999-2001 Paul `Rusty' Russell;(C) 2002-2006 Netfilter Core Team <coreteam@netfilter.org>;(C) 2011 Patrick McHardy <kaber@trash.net>
Copyright (C) 2009 DENX Software Engineering GmbH Heiko Schocher <hs@denx.de>
Copyright (C) 1997, 1999, 2000, 2001 Ralf Baechle
Copyright (C) 2013-2016 Freescale Semiconductor, Inc.
Copyright (C) 2012 Sonal Santan <sonal.santan@gmail.com>
Copyright (c) 2006-2014 Broadcom Corporation
Copyright 2011-2016 Freescale Semiconductor, Inc.
Copyright IBM Corp. 2013, 2018 Author(s): Hendrik Brueckner <brueckner@linux.vnet.ibm.com>
Copyright IBM Corp. 2004, 2009
Copyright (c) 2008 Silicon Graphics, Inc. All Rights Reserved.
Copyright (c) 2016 MediaTek Inc. Author: Koro Chen <koro.chen@mediatek.com>
Copyright 2014 Advanced Micro Devices, Inc. All Rights Reserved.
Copyright (C) 2004 Anton Blanchard <anton@au.ibm.com>, IBM Added mmcr[aslot] support:
Copyright (c) by Takashi Iwai <tiwai@suse.de> code based on dmasound.c.
Copyright (C) 2014 Carlo Caione <carlo@caione.org>
© Copyright 2011-2013 Datera, Inc.
Copyright (C) 2016,2019 Advanced Micro Devices, Inc.
Copyright (c) 2003-2008 Simtec Electronics Ben Dooks <ben@simtec.co.uk>
Copyright (C) 2010 Oracle. All rights reserved.
Copyright 1999 Ralf Baechle (ralf@gnu.org)
Copyright (C) 2004 - 2009 Ivo van Doorn <lvdoorn@gmail.com>
Copyright (C) 2011-2013 Texas Instruments, Inc. Santosh Shilimkar <santosh.shilimkar@ti.com> Rajendra Nayak <rnyak@ti.com>
(c) 2000-2004 Omnikey AG (http://www.omnikey.com/);(C) 2005-2006 Harald Welte <laforge@gnunox.org>
Copyright 2015 Karol Herbst <nouveau@karolherbst.de>
Copyright 2013 Google Inc. Author: Willem de Bruijn <willemb@google.com> Daniel Borkmann <dborkman@redhat.com>
"Copyright 2005 Openedhand Ltd.:(c) snd_soc_component_write(c, WM8750_RESET, 0)"
Copyright (c) 2003-2018, Intel Corporation. All rights reserved Intel Management Engine Interface (Intel MEI) Linux driver
Copyright (c) 2018 Quantenna Communications
Copyright (C) 2016 STMicroelectronics (R&D) Limited. Author: Patrice Chotard <patrice.chotard@st.com>
(c) 1996 Hans-Joachim Widmaier - Rewritten;(C) 1993 Ray Burr - Modified for Amiga FFS filesystem.:(C) 1991 Linus Torvalds - minix filesystem
Copyright (C) 1991, 1992 Linus Torvalds changes by Thomas Schoebel-Theuer
Copyright 2019 Ondrej Zary
Copyright (C) Miguel Ojeda Sandonis Date: 2006-10-31
Copyright (C) 2005, 06 by Ralf Baechle (ralf@linux-mips.org)
Copyright (C) 2016 Aleksei Mamlin <mamlinav@gmail.com>
Copyright 1999 Jeff Garzik <jgarzik@pobox.com>
Copyright (C) 2013,2018 Advanced Micro Devices, Inc.
"Copyright (C) 2008 Yoichi Yuasa <yuasa@linux-mips.org>"
Copyright (C) 2013-2014 Linaro Ltd. Author: Haojian Zhuang <haojian.zhuang@linaro.org>
Copyright 2017 David Lechner <david@lechner.com>
Copyright (c) 2000-2006, 2014, Ericsson AB
(c) Tundra Semiconductor Corp. Author: Alex Bounine (alexandreb@tundra.com) Author: Roy Zang (tie-fei.zang@freescale.com) Add pci interrupt router host
Copyright (C) 2004 Matthew Wilcox <matthew@wil.cx>
Copyright (C) 2005-2010 IBM Corporation
Copyright (C) 2005-2006 Jens Axboe <axboe@kernel.dk>
Copyright (C) 2018 Cadence.
Copyright 2010-2011 Picochip Ltd., Jamie Iles http://www.picochip.com
Copyright (C) 2007 Benjamin Herrenschmidt, IBM Corporation.

LICENCE TERMS (cont.)

Copyright (C) 1998 V. Roganov and G. Raiko
Copyright 2004 Antonino Daplas <adaplas@pol.net>
Copyright (C) 2015-2017 Broadcom
Copyright (c) 2013, 2015 The Linux Foundation. All Rights Reserved.
Copyright (c) 2013, Steffen Trumtrar <s.trumtrar@pengutronix.de>
Copyright (C) 1995, 1996,1997,1998 Russell King
Copyright (c) 2010 H Hartley Sweeten <hsweeten@visionengravers.com>
Copyright (C) 2018, Intel, Inc.
Copyright (C) 2008 Rodolfo Giometti <giometti@linux.it>
Copyright (C) 2014-2016, Intel Corporation
Copyright (C) 2015-2017 Cirrus Logic
Copyright (C) 2015 Imagination Technologies
Copyright IBM Corp. 1999 Author(s): Martin Schwidefsky (schwidefsky@de.ibm.com)
Copyright (C) 2002-2004 Eric Biederman <ebiederm@xmission.com>
Copyright 1997-1998 Transmeta Corporation - All Rights Reserved
Copyright (C) 2017 ARM Ltd. Author: Marc Zyngier <marc.zyngier@arm.com>
Copyright (c) 2018 Microsemi
Copyright 2010-2015 Samuel Thibault <samuel.thibault@ens-lyon.org>
Copyright (C) 2010-2011 Pengutronix Uwe Kleine-Koenig <u.kleine-koenig@pengutronix.de>
Copyright (c) Adrian McMenamin 2002 - 2009
Copyright (C) 2012 Thomas Langer <thomas.langer@lantiq.com>
Copyright (c) 1994-2002 Justin T. Gibbs.
Copyright (C) 2007 Red Hat, Inc. All rights reserved.
Copyright (c) 2000 Jaroslav Kysela <perex@perex.cz> Tjeerd.Mulder <Tjeerd.Mulder@fujitsu-siemens.com> 2002 Takashi Iwai <tiwai@suse.de>
Copyright (c) by Jaroslav Kysela <perex@perex.cz> Definitions for CS4231 & InterWave chips & compatible chips registers
Copyright 2012 Intel Corporation Author: Josh Triplett <josh@joshtriplett.org>
Copyright (C) 1990, 1991 Free Software Foundation, Inc. FIXME
Copyright (C) 2014 - 2015 CompuLab Ltd. - <http://www.complab.co.il/>
Copyright 2015-2018 Socionext Inc. Author: Kunihiko Hayashi <hayashi.kunihiko@socionext.com> Contributors: Motoya Tanigawa <tanigawa.motoya@socionext.com> Masami Hiramatsu <masami.hiramatsu@linaro.org>
Copyright (C) 2003, 04, 11 Ralf Baechle (ralf@linux-mips.org)
Copyright (c) 2005-2006, Christopher Clark
Copyright (C) 1998-1999, 2002-2004 Hewlett-Packard Co David Mosberger-Tang <davidm@hpl.hp.com>
Copyright (c) 2016 Maxime Ripard. All rights reserved.
Copyright (C) 2013-2016, Yann Collet.
Copyright 2018 NXP Author: Wang Dongsheng <dongsheng.wang@freescale.com>
Copyright (C) 2013 Andrew Lunn <andrew@lunn.ch>
Copyright 2008, 2011 Freescale Semiconductor, Inc.
Copyright 2013 Actions Semi Inc. Author: Actions Semi, Inc.
(C) 2004 Linux Networx (<http://lnxi.com>) This file may be distributed
Copyright (C) 2001 MandrakeSoft S.A.
Copyright (C) Fuzhou Rockchip Electronics Co.Ltd Zheng Yang <zhengyang@rock-chips.com> Yakir Yang <ykk@rock-chips.com>
Copyright (c) 2000 by Takashi Iwai <tiwai@suse.de>
Copyright (C) 1995, 1996, 1997 Olaf Kirch <okir@monad.swb.de>
Copyright (C) 2018 CMC NV
Copyright (c) 2018 Chelsio, Inc. All rights reserved.
Copyright 2004-2007, 2014 Freescale Semiconductor, Inc. All Rights Reserved.
Copyright 2001 Resilience Corporation <ebrower@resilience.com>
Copyright (C) 2004-2007 Hans Verkuil <hverkuil@xs4all.nl>
Copyright (c) 2005 Anton Altaparmakov
Copyright 2002 John Levon <levon@movementarian.org>
Copyright 2005 Red Hat Inc, all rights reserved.
Copyright (C) 2016 Linaro Viresh Kumar <viresh.kumar@linaro.org>
Copyright IBM Corp. 2015, 2018
Copyright (c) 2016 Laura Garcia <nevola@gmail.com>
(C) 1999-2003 Nemosoft Unv.:(C) 2004-2006 Luc Saillard (luc@saillard.org)
Copyright (C) 1996-1998, Olaf Kirch <okir@monad.swb.de>
Copyright 2006 Openedhand Ltd.
Copyright (c) 1997, 1998, 2000 Justin T. Gibbs.
Copyright(c) 2007 - 2015 Intel Corporation. All rights reserved.
Copyright (c) 2003, Dr Brian Gladman, Worcester, UK.
Copyright 2014 General Electric Company
Copyright (c) 2015 QLogic Corporation
Copyright (C) 2007 Hewlett-Packard Development Company, L.P.
Copyright (C) 2006-2009 by Openmoko, Inc. Authors: Harald Welte <laforge@openmoko.org> Andy Green <andy@openmoko.org> Werner Almesberger <werner@openmoko.org> All rights reserved.
Copyright (C) 2009 Freescale Semiconductor Inc. All rights reserved.
Copyright (C) IBM Corporation, 2018
Copyright (C) 2008, Thomas Gleixner <tgx@linutronix.de>
Copyright (c) 2019 NXP Semiconductor
Copyright (C) 2010-2011 Digital Devices GmbH
Copyright 2018 IBM Corporation.
(C) Copyright 2016 - 2018, Xilinx, Inc.
"Copyright: (C) 2012-2013 Linaro Limited"
Copyright (c) 2000-2001, 2010, Code Aurora Forum. All rights reserved.
Copyright (c) 2011-2013 NVIDIA Corporation.
Copyright (C) 2008-2009 Frederic Weisbecker <fweisbec@gmail.com>
Copyright (C)2003-2006 Helsinki University of Technology
Copyright 2005/2006 Red Hat Inc, all rights reserved.
Copyright (C) 2002 - 2006 Atom Create Engineering Co., Ltd.
Copyright(C) 2015 Pengutronix, Steffen Trumtrar <kernel@pengutronix.de>
Copyright (c) 2016 HGST, a Western Digital Company.
Copyright (C) 2016-2017 Glider bvba
Copyright (C) 2016 Shawn Lin <shawn.lin@rock-chips.com>
Copyright (c) 2018 Takashi Sakamoto
Copyright (c) 2017 Oliver Hartkopp <socketcan@hartkopp.net>
Copyright (c) 2013 Eric Leblond <eric@regit.org>
(C) Copyright 2001, 2002 Rusty Russell IBM Corporation
Copyright (C) 2013,2014 ARM Limited
Copyright (C) 2014-2015 The Linux Foundation. All rights reserved.
Copyright 2004 Koninklijke Philips Electronics NV
Copyright (c) 2010 Wind River Systems, Inc. All Rights Reserved.
Copyright (c) 2013 Dialog Semiconductor
Copyright (C) 2009 - 2011 Renesas Solutions Corp. Kuninori Morimoto <morimoto.kuninori@renesas.com> Paul Mundt <paul.mundt@renesas.com>
Copyright IBM Corp. 2003, 2008 Author(s): Michael Holzheu
Copyright (C) 2009, Red Hat Inc.
Copyright (C) 2018 KVASER AB, Sweden. All rights reserved.
Copyright (c) 2011 Jiri Pirko <jpirko@redhat.com>
Copyright (c) 2016 Cavium Inc. (support@cavium.com).
Copyright (C) 2008, 2009 Provigent Ltd.
Copyright 1994-2001 Stephen Rothwell (sfr@canb.auug.org.au)
Copyright (c) 2015 MediaTek Inc. Author: Henry Chen <henryc.chen@mediatek.com>
Copyright (c) 2001 The Regents of the University of Michigan. All rights reserved.
Copyright (C) 2012-2015 Altera Corporation
Copyright (C) 2016 Cadence Design Systems Inc.
Copyright (c) 2009 by Rafael Ignacio Zurita <rizurita@yahoo.com>
Copyright 2009 Sascha Hauer, Pengutronix <s.hauer@pengutronix.de>
Copyright (c) 2004 James Courtier-Dutton <James@superbug.demon.co.uk> Driver CA0106 chips. e.g. Sound Blaster Audigy LS and Live 24bit Version: 0.0.22
Copyright 2006 Rob Landley <rob@landley.net> and TimeSys Corporation.

LICENCE TERMS (cont.)

Copyright (C) 2012 Rusty Russell IBM Corporation
Copyright (c) 2008 Simtec Electronics Ben Dooks <ben@simtec.co.uk> <http://armlinux.simtec.co.uk/>
Copyright (C) 2013-2015 Chelsio Communications. All rights reserved.
Copyright 2002 Pete Zaitcev <zaitcev@yahoo.com>
Copyright 2018 NXP.
Copyright 2012-15 Advanced Micro Devices, Inc.cls
Copyright(C) 2010 Intel Corporation.
Copyright (C) 2014 STMicroelectronics (R&D) Limited
Copyright (C) 2016 Lorenzo Bianconi <lorenzo.bianconi83@gmail.com>
Copyright (c) 2006, Kyle McMartin <kyle@parisc-linux.org>;(c) Copyright 2002, 2003 Hewlett-Packard Development Company, L.P. Bjorn Helgaas <bjorn.helgaas@hp.com>
Copyright (C) 2010-2011 Marek Vasut <marek.vasut@gmail.com>
Copyright (c) 2006 Steven Toth <stoth@linuxtv.org>
Copyright (C) 2016 Bamvor Jian Zhang
Copyright 2000 Deep Blue Solutions Ltd
Copyright (C) 2015 QWERTY Embedded Design
Copyright (c) 2015 MediaTek Inc. Author: Hanyi Wu <hanyi.wu@mediatek.com> Sascha Hauer <s.hauer@pengutronix.de> Dawei Chien <dawei.chien@mediatek.com> Louis Yu <louis.yu@mediatek.com>
Copyright (C) 2018-2019 Rockwell Collins
Copyright (c) 2005 Ben Gardner <bgardner@wabtec.com>
Copyright (C) 2008 Matthew Garrett <mjg@redhat.com>
Copyright (C) 1999-2000, 2003 Hewlett-Packard Co David Mosberger-Tang <davidm@hpl.hp.com>
(c) 2001,02 Gerd Knorr <kxaxel@bytesex.org>
Copyright 2015 Martin Kepplinger <martink@posteo.de>
Copyright (C) 2006, 2007 Eugene Konev <ejka@openwrt.org>
Copyright (C) 2001 ARM Limited
Copyright (C) 2012 Google, Inc.
Copyright 2002 Andi Kleen, SuSE Labs. Thanks to Ben LaHaise for precious feedback.
Copyright (C) 2010 Tomoki Sekiyama (tomoki.sekiyama@gmail.com)
Copyright 2017 (C) Priti Laes <plaes@plaes.org>
Copyright (c) 2015 MediaTek Inc. Author: Andrew-CT Chen <andrew-ct.chen@mediatek.com>
(c) Copyright 2009-2013 Datera, Inc.
Copyright (c) 2003-2010 Cavium Networks (support@cavium.com). All rights reserved.
Copyright (c) 2016, NVIDIA CORPORATION. All rights reserved. Author: Neo Jia <cjia@nvidia.com> Kirti Wankhede <kwankhede@nvidia.com>
Copyright (C) 2013 Thomas Langer, Lantiq Deutschland
"Copyright 2003-2005 Devicescape Software, Inc."
Copyright (c) 2017 Pengutronix, Michael Grzeschik <m.grzeschik@pengutronix.de>
Copyright (C) 2005 by Thomas Winischhofer, Vienna, Austria
Copyright (c) 2019 Linaro Ltd. Author: Manivannan Sadhasivam <manivannan.sadhasivam@linaro.org>
Copyright (c) 2018 Chen-Yu Tsai
Copyright (C) 2015 Samsung Electronics Co., Ltd. Author: Jacek Anaszewski <j.anaszewski@samsung.com>
Copyright (C) 2019 Texas Instruments Incorporated - <http://www.ti.com/>
Copyright (C) 2011 Sascha Hauer, Pengutronix <s.hauer@pengutronix.de>
Copyright (C) 2012 STMicroelectronics Limited
Copyright (c) 2001-2002 by David Brownell
Copyright 2012 Sascha Hauer, Pengutronix
Copyright (C) 2012 Renesas Electronics Corporation
Copyright (C) 2004-2005 Yoichi Yuasa <yuasa@linux-mips.org>
Copyright (C) 2013 Noralf Tronnes
Copyright 2003-2005 Red Hat, Inc. All rights reserved.
Copyright (c) 1996-2001 Vojtech Pavlik
Copyright (C) 2008 Steven Noonan <steven@uplinklabs.net>
Copyright (c) 2008 Simtec Electronics Ben Dooks <ben@simtec.co.uk>
Copyright (c) 2008-2013 Chelsio Communications, Inc. All rights reserved.
Copyright (C) 2012 Chris Boot
Copyright (C) 2018-2019 Jens Axboe

(C) Steve Whitehouse 1999 derived from the ipv4 netfilter header file which is
Copyright (c) 2017 Intel Corporation
Copyright (c) 2017 Samsung Electronics Co., Ltd. <http://www.samsung.com/> Author: Andrzej Pietrasiewicz <andrzejtp2010@gmail.com>
Copyright © 2001 Red Hat UK Limited
Copyright (C) 2012 David S. Miller <davem@davemloft.net>
Copyright ST-Ericsson 2012.
Copyright (C) 2006 PA Semi, Inc
Copyright (C) 2003 Ladislav Michl
Copyright 2011-2016 Analog Devices Inc. Author: Lars-Peter Clausen <lars@metafoo.de>
Copyright (c) 2004, 2018 IBM Corp. Dave Engebretsen engebret@us.ibm.com Steven Royer seroyer@linux.vnet.ibm.com Adam Rezneck adrezneck@linux.vnet.ibm.com Bryant G. Ly <bryantly@linux.vnet.ibm.com>
Copyright 1994.
(C) 2002 by Harald Welte <laforge@netfilter.org>
Copyright (C) 2002 Trond Myklebust <trond.myklebust@fys.uio.no>
Copyright (C) 2013 by John Crispin <john@phrozen.org>
Copyright (C) 2008 Ilya Yanok, Emcraft Systems
Copyright 2013 - 2014 Freescale Semiconductor Inc.
Copyright (c) 2016-2018, NXP Semiconductors
Copyright by Adam Belay <ambx1@neo.rr.com>
Copyright (C) 1997 Paul Mackerras.
Copyright IBM Corp. 2012,2015
Copyright (c) 1994-2001 Justin T. Gibbs.
Copyright (c) 2014 Guenter Roeck
Copyright (C) 2006-2010 Freescale Semiconductor, Inc. All rights reserved.
Copyright (C) 2015 Aleksa Sarai <cyphar@cyphar.com>
Copyright (C) 2002, 2008 David S. Miller <davem@davemloft.net>
Copyright (C) 2013 Altera Corporation <www.altera.com>
Copyright (C) 1999 Phil Blundell
Copyright (c) 2015 TQ-Systems GmbH
Copyright (C) 2012-2013 Linaro Limited
Copyright (C) 1998 Dan Jacobowitz <dan@debian.org>
Copyright (C) 2011 Chris Boot <bootc@bootc.net>
Copyright (C) 2010 - 2014 Xilinx, Inc.
Copyright (C) BayLibre, SAS Author: Neil Armstrong <narmstrong@baylibre.com>
Copyright (c) 2016 MediaTek Inc. Author: PoChun Lin <pochun.lin@mediatek.com>
Copyright (C) 2002, 2003 Paul Mundt
Copyright (c) 2011 Jussi Kivilinna <jussi.kivilinna@mbnet.fi>
Copyright (C) 2003 Lineo uSolutions, Inc.
Copyright 2010-1 Wolfson Microelectronics plc
(C) Copyright 2013 IBM Corporation
Copyright (C) 2015 Heiko Schocher <hs@denx.de>
Copyright 2013 Matthew Garrett <mjg59@srcf.ucam.org>
Copyright (C) 2012 Samsung Electronics Chiwoong Byun <woong.byun@samsung.com> Jonghwa Lee <jonghwa3.lee@samsung.com>
Copyright (C) 2006-2009 Texas Instruments Inc
Copyright (C) 2006, 2007, 2008 David S. Miller (davem@davemloft.net)
Copyright (C) 2004-2016 Cavium, Inc.
Copyright (C) 2004 Trond Myklebust
Copyright (c) Alan Smithee.
Copyright (c) 2001-2002 Denis Oliver Kropp <dok@directfb.org> Sven Neumann <neo@directfb.org>;(c) 2001-2002 Denis Oliver Kropp <dok@directfb.org>
Copyright (C) 2015-2018 Xilinx, Inc.
Copyright (C) 2002 - 2012 Tensilica Inc.
(C) 1999-2001 Paul 'Rusty' Russell;(C) 2002-2006 Netfilter Core Team <coreteam@netfilter.org>;(C) 2003,2004 USAGI/WIDE Project <<http://www.linux-ipv6.org/>>;(c) 2005-2012 Patrick McHardy <kaber@trash.net>
Copyright (C) 2003 Kartikey Mahendra Bhatt <kartik_me@hotmail.com>.

LICENCE TERMS (cont.)

(C) Copyright Al Viro 2000, 2001
Copyright 2015 Andy Fleming
Copyright (C) 2003-2005,2008 David Brownell
Copyright (C) 2016, Intel Corporation Author: Mika Westerberg <mika.westerberg@linux.intel.com>
Copyright (C) 2018 Himanshu Jha <himanshujha199640@gmail.com>
Copyright (C) 2000 Deep Blue Solutions Ltd.
Copyright (c) 2007-8 Patrick Boettcher <pb@linuxtv.org>
Copyright (C) 2006 Tower Technologies Author: Alessandro Zummo <a.zummo@towertech.it>
Copyright (C) 2004-2007 Red Hat, Inc. All Rights Reserved. Written by David Howells (dhowells@redhat.com)
Copyright (c) 2012-2013 Hisilicon Limited.
Copyright (C) 2009-2010 Magnus Damm
Copyright (C) 2017 Stefan Roese <sr@denx.de>
Copyright (C) 2010 Stefan Ringel <stefan.ringel@arcor.de>
Copyright (c) 2018-2019, The Linux Foundation. All rights reserved.
(C) Copyright 2013-2015 Hewlett-Packard Development Company, L.P.;(C) Copyright 2013-2014,2018 Red Hat, Inc.:(C) Copyright 2015 Intel Corp.:(C) Copyright 2015 Hewlett-Packard Enterprise Development LP
Copyright (C) 2001 Rusty Russell.
Copyright (C) 1992,1993,1994,1995 | W. Metzenth, 22 Parker St, Ormond, Vic 3163, | Australia. E-mail billm@jacobi.maths.monash.edu.au |
Copyright (C) 1996 by Erik Stahlman
Copyright (c) 2013,2016 Qualcomm Atheros, Inc.
(c) Copyright 2002, 2005 Hewlett-Packard Development Company, L.P. David Mosberger-Tang <davidm@hpl.hp.com> Bjorn Helgaas <bjorn.helgaas@hp.com>
Copyright (c) 2010 LG Electronics Chan Jeong <chan.jeong@lge.com>
Copyright (C) 2012 Rafał Milecki <zajec5@gmail.com>
Copyright (C) 2014, Intel Corporation Authors: Aaron Lu <aaron.lu@intel.com>
(C) Copyright 2017, Angelo Dureghello <angelo@sysam.it>
Copyright (C) 2005-2019 Andes Technology Corporation include <linux/uaccess.h>
Copyright (C) 2015, SUSE
Copyright (C) 2007 Texas Instruments, Inc.
Copyright (C) 2011, 2012 by Wolfram Sang, Pengutronix e.K. same licence as the driver
Copyright (C) 2007-2013 Michal Simek <monstr@monstr.eu>
Copyright (c) 2014, ROCKCHIP CORPORATION. All rights reserved.
Copyright (C) 2015 Maxime Ripard
Copyright 2005-2008, Broadcom Corporation
Copyright (c) 2009 Intel Corp. Author: Huang Ying <ying.huang@intel.com> Vinodh Gopal Erdinc Ozturk Deniz Karakoyunlu
Copyright (C) 2015 Intel Corporation All Rights Reserved
Copyright (C) 2004 Nokia Corporation Author: Imre Deak <imre.deak@nokia.com> Adapted for OSK by <dirk.behme@de.bosch.com>
Copyright (C) 2004 Texas Instruments.
Copyright (C) 2003 Ralf Baechle
Copyright IBM Corp. 2006, 2010 Author(s): Martin Schwidefsky <schwidefsky@de.ibm.com>
Copyright (c) 2004-2010 Atheros Communications Inc.
Copyright (C) 2006, Intel Corp.
(C) 2010-2011 Thomas Graf <tgraf@redhat.com>;(C) 2010-2011 Red Hat, Inc.
Copyright(c) 2017 Broadcom. All rights reserved.
Copyright (c) 2016 BayLibre, Inc.
Copyright (C) 2012 MIPS Technologies, Inc. All rights reserved.
Copyright (c) 1996-1999 Distributed Processing Technology Corporation All rights reserved.
Copyright (c) 2019 BayLibre, SAS. Author: Neil Armstrong <narmstrong@baylibre.com>
(C) Copyright 2014, 2015 Linaro Ltd. Author: Ashwin Chaugule <ashwin.chaugule@linaro.org>
Copyright 2015 - Marcus Cooper <codekipper@gmail.com>
Copyright (C) 2005 IBM. Hex-dump auto generated from spu_restore.c. Do not edit!
Copyright (C) 2003 - 2004 Tresys Technology, LLC
Copyright (C) IBM Corporation, 2016
Copyright (C) 2017, Intel Corporation Author: Heikki Krogerus <heikki.krogerus@linux.intel.com>

Copyright 2002, Phil Karn
Copyright (C) 2013 Jonas Jensen
Copyright (C) 2018, Intel Corporation Copied from reset-sunxi.c
Copyright 2014 Red Hat Inc.
Copyright (c) 2012-2014 The Linux Foundation. All rights reserved.
Copyright 2013 Texas Instruments, Inc. Cyril Chemparathy <cyril@ti.com> Santosh Shillimkar <santosh.shillimkar@ti.com>
Copyright (C) 1994-1999 Russell King Moved from linux/arch/arm/kernel/debug.S by Ben Dooks
Copyright (C) 2011 Netlogic Microsystems
Copyright (C) 2013 - 2017 Linaro Ltd. <ard.biesheuvel@linaro.org>
Copyright (c) 2010-2014 Samsung Electronics Co., Ltd. http://www.samsung.com
Copyright (C) 2011 Marek Vasut <marek.vasut@gmail.com>
Copyright (C) 2008-2011 Texas Instruments, Inc.
"Copyright: (C) 2013 Linaro Limited"
Copyright (c) 2015 Ariel D'Alessandro <ariel@vanguardiasur.com>
Copyright 1992, Linus Torvalds.
Copyright 2017 Cirrus Logic, Inc.
Copyright (C) 1994-1998 Linus Torvalds & authors (see below)
Copyright (C) IBM Corporation, 2003, 2010
Copyright (C) 2000-2002 Joakim Axelsson <gozem@linux.nu> Patrick Schaaf <bof@bof.de> Martin Josefsson <gandalf@wlug.westbo.se>
Copyright (C) 2018-2019 Wen Yang, ZTE. Comments: Options: --no-includes --include-headers
Copyright: (C) 2009 MontaVista Software, Inc., <source@mvista.com>
Copyright (C) 2015 Red Hat, Inc. All Rights Reserved. Written by David Howells (dhowells@redhat.com)
Copyright (c) 2007 Patrick Boettcher <pb@linuxtv.org>
Copyright (C) 2016-2017 Cirrus Logic
Copyright 2012 Benjamin Herrenschmidt, IBM Corp.
Copyright (c) 2016 Avago Technologies. All rights reserved.
Copyright (c) 2014,2017 Qualcomm Atheros, Inc.
Copyright (c) 2004 Richard Purdie
Copyright (C) 2009, 2010 Intel Corp Jim Stanley <jim.stanley@intel.com>
"Copyright (C) 2017 Madhavan Srinivasan, IBM Corporation.:(C) 2017 Anju T Sudhakar, IBM Corporation.:(C) 2017 Hemant K Shaw, IBM Corporation."
Copyright (C) Abilis Systems 2012
Copyright (C) 2016 Maxim Integrated Products
Copyright (C) 2002 David Howells (dhowells@redhat.com) Incorporating suggestions made by Linus Torvalds and Dave Miller
Copyright (C) 2016-2017 Imagination Technologies Author: Paul Burton <paul.burton@mips.com>
Copyright 2002 H. Peter Anvin - All Rights Reserved
Copyright (C) 2000 Trond Myklebust
Copyright (C) 2001, 2002, 2003 Patrick Mochel
Copyright (C) International Business Machines Corp., 2000-2001
Copyright (c) 2011-2012 Samsung Electronics Co., Ltd. http://www.samsung.com
Copyright abandoned, 2000, Niels Kristian Bech Jensen <nkbj@image.dk>.
(C) 1996 P. Braam and M. Callahan:(C) 1997 Carnegie Mellon University
(C) 2000 David Brown <usb-storage@davidb.org>
Copyright (c) 2006 Marek Vasut
Copyright (c) 2013 Qualcomm Atheros, Inc.
Copyright (C) 2010 Brian King IBM Corporation
Copyright 2010 Michael Ellerman, IBM Corp.
Copyright (c) 2010-2012,2013, The Linux Foundation. All rights reserved.
Copyright 2013-2015 Maxim Integrated Products
Copyright (C) 2009 Daniel Hellstrom (daniel@gaisler.com) Aeroflex Gaisler AB
Copyright (c) 2004 James Courtier-Dutton <James@superbug.demon.co.uk> Driver CA0106 chips. e.g. Sound Blaster Audigy LS and Live 24bit Version: 0.0.18
Copyright (c) 2008 STMicroelectronics Limited
Copyright (C) 2006,2007 Alan Nisota (alannisota@gmail.com)

LICENCE TERMS (cont.)

Copyright (c) 2018 Intel Corporation
Copyright (C) 2005, 2006 Chuck Lever <cel@netapp.com>
Copyright (C) ST-Ericsson SA 2011
Copyright (C) 2017, Intel Corporation Authors: Andy Shevchenko <andriy.shevchenko@linux.intel.com> Mika Westerberg <mika.westerberg@linux.intel.com>
Copyright (C) 2007 Sylvain Munaut <tnt@246tNt.com>
Copyright (C) 2015-2017 Dialog Semiconductor
Copyright (C) 2015 Seagate
Copyright 2009, Broadcom Corporation
Copyright 2019 IBM Corp. include <linux/module.h> include "ocxl_internal.h"
Copyright (C) 1996 Paul Gortmaker (drivers/char/rtc.c)
Copyright (C) 2010 Thomas Langer <thomas.langer@lantiq.com>
Copyright 2005,2007 Simtec Electronics Ben Dooks <ben@simtec.co.uk>
Copyright (c) 2013, 2018, The Linux Foundation. All rights reserved.
Copyright (c) 2004 Simtec Electronics Ben Dooks <ben@simtec.co.uk>;(c) Copyright 1996 Alan Cox <alan@lxorguk.ukuu.org.uk>
Copyright (C) 2018 - 2019 Intel Corporation
Copyright (C) 2008, Red Hat Inc.
Copyright (C) 2010 Thomas Chou <thomas@wytron.com.tw>
Copyright (C) 2017 Spreadtrum, Inc. Author: Chunyan Zhang <chunyan.zhang@spreadtrum.com>
Copyright 2011-2012, Pavel Zubarev <pavel.zubarev@gmail.com>
(c) 1998 Andrew Apted <ajapted@netspace.net.au>
Copyright (C) 2014 Emilio López Emilio López <emilio@elopez.com.ar>
Copyright (C) 2008, 2009 NEC Corporation
Copyright 2019, IBM Corporation.
"Copyright (C) 1999 David A. Hinds. All Rights Reserved.:(C) 1999 David A. Hinds;(C) 2003 - 2008 Dominik Brodowski"
Copyright (C) 1994, 1995, 1997, 1998, 1999, 2000, 2001, 2002, 2003, 2004, 2005, 2006 Free Software Foundation, Inc.
Copyright (C) 2009 Neil Horman <nhorman@tuxdriver.com>
Copyright (C) 2009 Simon Guinot <sguinot@lacie.com>
Copyright (C) Hans Alblas PE1AYX <hans@esrac.ele.tue.nl>
Copyright (C) 2018 Joe Lawrence <joe.lawrence@redhat.com>
Copyright (C) 2010 Dmitry Eremin-Solenikov
Copyright (C) 2003 Paul Mundt
Copyright (C) 1994 by Linus Torvalds Adapted for PowerPC by Gary Thomas modified by Cort (cort@cs.nmt.edu)
Copyright 2000-2008 H. Peter Anvin - All Rights Reserved
Copyright (c) by Jaroslav Kysela <perex@perex.cz> GUS's memory access via proc filesystem
Copyright (C) 1999 Harald Koerfgen
Copyright (C) 2015 Intel Corp., Peter Zijlstra <peterz@infradead.org>
Copyright(c) 2003 - 2015 Intel Corporation. All rights reserved.
Copyright IBM Corp. 2008, 2018
(C) Copyright 2005 Tundra Semiconductor Corp. Kong Lai, <kong.lai@tundra.com>
Copyright 2010, 2011 Kent Overstreet <kent.overstreet@gmail.com>
Copyright (C) 2000 Chris R. Baugher <baugher@enteract.com>
Copyright (c) 2016 NVIDIA Corporation. All rights reserved.
(C) 2007 Red Hat Inc
Copyright (c) 2008 Wind River Systems, Inc.:(c) 2008 Wind River Systems, Inc.
Copyright (C) 2001 Lennert Buytenhek (buytenh@gnu.org)
(C) 1998 Dave Boynton;(C) 1998-2004 Ben Fennema;(C) 2000 Stelias Computing Inc
Copyright (C) 2011 Paul Parsons <lost.distance@yahoo.com>
Copyright 2009 Wolfson Microelectronics, plc
Copyright (C) 2015 STMicroelectronics R&D Limited
Copyright(c) 2004 - 2015 Intel Corporation.
Copyright (C) 2009 Crane Cai <crane.cai@amd.com>
Copyright (C) 2008 Christian Lamparter <chunkeey@web.de>
Copyright (c) 1994-2000 by Jaroslav Kysela <perex@perex.cz>
Copyright (C) 2018-2019 Cadence.
Copyright (C) 2003, Randy Dunlap <rdunlap@xenotime.net>
Copyright (C) 2013, Intel Corporation. All rights reserved.
Copyright (c) 2005-2006 Intel Corporation. All rights reserved.
Copyright (C) 2010 SUSE Linux Products GmbH. All rights reserved.
Copyright (c) 2006 Wolfson Microelectronics PLC. Graeme Gregory graeme.gregory@wolfsonmicro.com linux@wolfsonmicro.com
Copyright (C) 2017, STMicroelectronics - All Rights Reserved Authors: Amelie Delaunay <amelie.delaunay@st.com> Fabrice Gasnier <fabrice.gasnier@st.com>
Copyright (C) 2002 ARM Limited, All Rights Reserved.
Copyright(c) 2018 Intel Corporation. All rights reserved. ifndef _MM_SHUFFLE_H define _MM_SHUFFLE_H include <linux/jump_label.h>
(C) 2005 Harald Welte <laforge@netfilter.org>
Copyright (C) 2013 Luis Alves <ljalvs@gmail.com> July, 6th 2013 First release based on cx24116 driver by: Steven Toth and Georg Acher, Darron Broad, Igor Liplianin Cards currently supported: TBS6980 - Dual DVBS/S2 PCIe card TBS6981 - Dual DVBS/S2 PCIe card
Copyright (C) 2009-2010 Texas Instruments, Inc.
Copyright (C) 2016 ARM Limited
Copyright (C) 2012 Intel Corp.
(c) Copyright 1999,2000 Grant Grundler;(c) Copyright 1999,2000 Hewlett-Packard Company
(C) Copyright 2007-2018 Xilinx, Inc.:(C) Copyright 2007-2013 Michal Simek;(C) Copyright 2007-2012 PetaLogix Qld Pty Ltd
Copyright (C) 2003 IBM.
Copyright © 2016-2017 Broadcom
Copyright (C) 2004, 2005 Manu Abraham (manu@kromtek.com)
(c) Copyright 2003-2007 Xilinx Inc. All rights reserved.
Copyright 2009 Geert Uytterhoeven
Copyright (C) 2013 Texas Instruments Incorporated - http://www.ti.com/ Contact: Eduardo Valentin <eduardo.valentin@ti.com>
(C) 1992, 1993 Linus Torvalds, (C) 1997 Ingo Molnar
Copyright (c) 2015 Oracle and/or its affiliates. All rights reserved. Authors: Bob Picco <bob.picco@oracle.com>, Khalid Aziz <khalid.aziz@oracle.com>
Copyright (C) 1994 David S. Miller (davem@caip.rutgers.edu).
Copyright (c) 2016 Pablo Neira Ayuso <pablo@netfilter.org>
Copyright (C) 2014 Red Hat Inc. Authors: Vivek Goyal <vgoyal@redhat.com>
Copyright (c) 2017-2019 Borislav Petkov, SUSE Labs.
Copyright (c) 2009 Tobias Lorenz <tobias.lorenz@gmx.net>
Copyright (C) 2007 Mips Technologies, Inc.
Copyright 2012 Calxeda, Inc.
Copyright (C) 2005 John Lenz <lenz@cs.wisc.edu>
Copyright (C) 1999-2000, 2002 Hewlett-Packard Co David Mosberger-Tang <davidm@hpl.hp.com> Stephane Eranian <eranian@hpl.hp.com>
Copyright (C) 2006, Sascha Hauer, Pengutronix
Copyright (c) 2015 Collabora Ltd. Author: Sjoerd Simons <sjoerd.simons@collabora.co.uk>
"(C) 2003 - 2004 David Woodhouse;(C) 2003 - 2004 Dominik Brodowski"
Copyright (C) 1999 - 2006 Krzysztof Halasa <khc@pm.waw.pl>
Copyright (c) 2015 Red Hat, Inc
Copyright 2017-2018 HabanaLabs, Ltd. All Rights Reserved.
Copyright (C) 2008 Nokia Corporation.
Copyright 2011 Intel Corp. Author: Huang Ying <ying.huang@intel.com>
Copyright (C) 2003 by Andreas Gruenbacher, <a.gruenbacher@computer.org>
Copyright (C) 2003 SAN People
Copyright (C) 2001, 2002, 2003 Frank Mori Hess <fmhess@users.sourceforge.net>
(c) 2006 Simtec Electronics http://armlinux.simtec.co.uk/ Ben Dooks <ben@simtec.co.uk>
Copyright (C) 2014 STMicroelectronics R&D Ltd
Copyright (C) 2015 Samsung Electronics Author: Jaewon Kim <jaewon02.kim@samsung.com> Author: Beomho Seo <beomho.seo@samsung.com>

LICENCE TERMS (cont.)

Copyright (C) 2015 Samsung Electronics Co., Ltd.
Copyright (c) 2018 Daniel M. Lambea <dmlambea@gmail.com>
Copyright (c) 2010 Picochip Ltd., Jamie Iles
Copyright © 2011 Parrot S.A.
Copyright (C) 2015 Imagination Technologies Author: Alex Smith <alex.smith@imgtec.com>
Copyright (c) 2013 Daniel Mack <zonque@gmail.com>
Copyright (C) 2002 Neil Brown <neilb@cse.unsw.edu.au>
Copyright (c) 2015 Oracle. All rights reserved.
Copyright 2018 Linaro Limited
Copyright (C) 2018 Martin Blumenstingl <martin.blumenstingl@googlemail.com>
Copyright 2007-2008 Nouveau Project
Copyright (C) STMicroelectronics 2019 - All Rights Reserved Author: Alexandre Torgue <alexandre.torgue@st.com> for STMicroelectronics.
Copyright (C) 2005 John McCutchan
Copyright (C) 2014 Texas Instruments Incorporated - http://www.ti.com/
Copyright 2007-2009 DENX Software Engineering, Stefan Roese <sr@denx.de>
(c) Copyright 2002-2010, Ralink Technology, Inc.
(c) 2013 Daniel Mack <zonque@gmail.com>
Copyright (C) 2007 MIPS Technologies, Inc. All rights reserved.
Copyright (C) 2018 Synopsys, Inc.
Copyright (C) 1998-9 Tim Waugh <tim@cyberelk.demon.co.uk>
Copyright (C) 2012 Florian Vaussard, EPFL Mobots group
Copyright (c) 2016 Allwinnertech Co., Ltd.
Copyright (c) 2009 Mika Westerberg <mika.westerberg@iki.fi>
Copyright (C) 2008-2014 Mathieu Desnoyers
Copyright (C) 2009 Michael Hennerich, Analog Devices Inc.
Copyright 2015 Freescale Semiconductor York Sun <yorksun@freescale.com>
Copyright (C) 2006 G. Liakhovetski (g.liakhovetski@gmx.de);(C) 2002-2005 BUFFALO INC.
Copyright (C) 2012 Malcolm Priestley (tvboxspy@gmail.com)
Copyright 2010 Red Hat Inc.
Copyright (C) 1999-2003 Holger Waechter <holger@convergence.de>
Copyright (C) 1999, 2003 Hewlett-Packard Co Stephane Eranian <eranian@hpl.hp.com>
Copyright 2007 Andi Kleen, SUSE Labs.
copyrights of artists. Moreover, I think that if audio-tracks are supported, it should be done through the VFS and not via *ioctl()*s*. A problem here could be the fact that audio-frames are 2352 bytes long, so either the audio-file-system should ask for 75264 bytes at once the least common multipl
Copyright 2010 Red Hat, Inc.:(C) do {} while (0) endif
Copyright IBM Corp. 2013 Author(s): Eugene Crosser <eugene.crosser@ru.ibm.com>
Copyright 2013-2014 Freescale Semiconductor, Inc.
Copyright (c) 2007-2012 Nicira, Inc.
Copyright (c) by Jaroslav Kysela <perex@perex.cz> Abramo Bagnara <abramo@alsa-project.org>
Copyright (c) Copyright 2005-2006 Hewlett-Packard Development Company, L.P. Alex Williamson <alex.williamson@hp.com>
Copyright (C) 2001 Romain Dolbeau <dolbeau@irisa.fr>
Copyright (C) STMicroelectronics SA 2015 Authors: Hugues Fruchet <hugues.fruchet@st.com> Fabrice Lecoultrre <fabrice.lecoultrre@st.com> for STMicroelectronics.
Copyright (C) 2003 Benjamin Herrenschmidt (benh@kernel.crashing.org)
Copyright (C) 1994 by Hamish Macdonald
Copyright (c) 2016 Linaro Ltd
Copyright (C) 2005 by Ash Willis <ashwillis@programmer.net>
Copyright (C) 2013 - 2014 Texas Instruments, Inc.
Copyright 2012 Stefan Roese Stefan Roese <sr@denx.de>
Copyright (c) 2014 Marvell Technology Group Ltd.:(C) programmable clock divider controlled by <Select{1:n}> D) constant div-by-3 clock divider E) programmable clock divider bypass controlled by <Switch> F) constant div-by-3 clock mux controlled by <D3Switch> G) clock gate controlled by <Enable>
Copyright (C) 2006, Advanced Micro Devices, Inc.
Copyright 2012 Xyratex Technology Limited

Copyright (c) 2018 The Linux Foundation. All rights reserved.
Copyright (c) 2017 BayLibre, SAS Author: Neil Armstrong <narmstrong@baylibre.com> Author: Jerome Brunet <jbrunet@baylibre.com>
Copyright (C) 2016-2017 Maxim Integrated Products Author: Ryan Lee <ryans.lee@maximintegrated.com>
Copyright (C) 2001 Greg Kroah-Hartman (greg@kroah.com)
Copyright (C) 2006 Bob Copeland <me@bobcopeland.com>
Copyright (C) 1997, 1998 Ralf Baechle
Copyright (C) 2004, 2006, 2009, 2010 Texas Instruments Incorporated Author: Aurelien Jacquiot (aurelien.jacquiot@jaluna.com)
Copyright (c) 2017 Google, Inc.
Copyright (c) 2005-2006 Network Appliance, Inc. All rights reserved.
Copyright (C) 1995-1996 Russell King
Copyright (C) International Business Machines Corp., 2002, 2011 Etersoft, 2012 Author(s): Steve French (sfrench@us.ibm.com) Jeremey Allison (jra@samba.org) 2006 Pavel Shilovsky (pshilovsky@samba.org) 2012
Copyright IBM Corporation, 2007 Author: Mike Anderson <andmike@linux.vnet.ibm.com>
Copyright (c) 2017 MediaTek Inc. Author: Chen Zhong <chen.zhong@mediatek.com>
Copyright (C) 2009-2012 CERN (www.cern.ch) Author: Nicolas Serafini, EIC2 SA Author: Samuel Iglesias Gonsalvez <siglesias@igalia.com>
Copyright (c) 2013-2017 Hisilicon Limited.
Copyright (c) 2014, Patrik Jakobsson All Rights Reserved.
Copyright (C) 2015 ARM Ltd. Sudeep Holla <sudeep.holla@arm.com>
Copyright (C) 2003, 2004 IBM Corp. Ryan S. Arnold (rsa@us.ibm.com)
Copyright (c) Takashi Sakamoto <o-takashi@sakamocchi.jp>
Copyright (c) 2018, Sensor-Technik Wiedemann GmbH
Copyright (C) 2015-2017 Texas Instruments Incorporated - http://www.ti.com Andreas Dannenberg <dannenberg@ti.com> Andrew F. Davis <afd@ti.com>
Copyright 2015 Advanced Micro Devices, Inc. All Rights Reserved.
Copyright (c) 2017 Maciej S. Szmigiero <mail@maciej.szmigiero.name>
copyright (C) 1992 Michael K. Johnson Interrupt support added 1993 Nigel Gamble Removed 8255 status defines from inside __KERNEL__ Marcelo Tosatti
Copyright (C) 2009-2013 Texas Instruments, Inc.
Copyright: |copy| 2008 Intel Corporation <linux-wimax@intel.com >
Copyright (c) 2012 Florian Westphal <fw@strien.de>
Copyright (C) 2003 Deep Blue Solutions, Ltd, All Rights Reserved.
(C) 2009-2011 Rafael J. Wysocki <rjw@sisk.pl>, Novell Inc.:(C) 2010 Alan Stern <stern@rowland.harvard.edu>:(C) 2014 Intel Corp., Rafael J. Wysocki <rafael.j.wysocki@intel.com>
Copyright (c) 2004 Arnaud Patard
Copyright (C) 2013-2019 NVIDIA Corporation. All rights reserved.
Copyright (C) 2015 Anton Blanchard <anton@au.ibm.com>, IBM
Copyright (C) 2001-2011 Guan Xuetao
Copyright (C) 2018 Texas Instruments Author: Kishon Vijay Abraham I <kishon@ti.com>
Copyright (C) 2014 Carlo Caione Carlo Caione <carlo@caione.org>
Copyright (C) 2015 IBM Corp. <aik@ozlabs.ru>
Copyright IBM Corp. 1999, 2012 Author(s): Hartmut Penner (hp@de.ibm.com), Martin Schwidefsky (schwidefsky@de.ibm.com)
Copyright (C) 1992 David Giller, rafetmad@oxy.edu 1994, 1995 Eberhard Mönkeberg, emoenke@gwdg.de 1996 David van Leeuwen, david@tm.tno.nl 1997, 1998 Erik Andersen, anderssee@debian.org 1998-2002 Jens Axboe, axb
Copyright (C) 2001 by Harald Welte <laforge@gnumonks.org>
Copyright (c) 2013 - 2015 Linaro Ltd.
(c) 1997-2001 Gerd Knorr <kxaxel@bytesex.org>
Copyright (C) 2006 Mario Hlawitschka (dh1pa@amsat.org)
Copyright (c) 1998 by Frank van de Pol <fvdpol@coil.demon.nl> Jaroslav Kysela <perex@perex.cz>
Copyright (c) 2017 BayLibre, SAS. Author: Neil Armstrong <narmstrong@baylibre.com>
Copyright (C) 1997-2011 AudioScience Inc. <support@audioscience.com>
Copyright: (C) 2011 Texas Instruments, Inc.
Copyright (C) 2007 USAGI/WIDE Project, All Rights Reserved.
Copyright (c) 2016 Cirrus Logic Inc.

LICENCE TERMS (cont.)

Copyright (c) 2014 Samsung Electronics Co., Ltd. Author: Naveen Krishna Ch <naveenkrishna.ch@gmail.com>
Copyright (C) 2013 Pengutronix
Copyright (c) International Business Machines Corp., 2006, 2009 Author(s): Steve French (sfrench@us.ibm.com)
Copyright (C) 2016 Broadcom Limited
Copyright (C) 2008 Peter Griffin pgriffin@mpc-data.co.uk
Copyright 2011-2012 VMware, Inc., Palo Alto, CA., USA
Copyright 2009 Sascha Hauer <s.hauer@pengutronix.de>
Copyright 2004-2016 Freescale Semiconductor, Inc. All Rights Reserved.
Copyright (c) 2012 Bjørn Mork <bjorn@mork.no>
Copyright(c) 2017 - 2018 Intel Corporation.
(c) Copyright 2007 Étienne Bersac <bersace@gmail.com>;(c) Copyright 2005 Benjamin Herrenschmidt, IBM Corp. <benh@kernel.crashing.org>
Copyright (c) 2016-2017 Qualcomm Atheros, Inc. All rights reserved.
Copyright (c) 2009 Wind River Systems, Inc. All Rights Reserved.
Copyright (c) 2016 Matthew Wilcox <willy@infradead.org>
(c) 2005 Ben Dooks
Copyright (C) 2006/2007 Kristoffer Ericson <Kristoffer.Ericson@Gmail.com>
Copyright (C) Jernej Skrabec <jerne.j.skrabec@siol.net>
Copyright (C) 2001-2005 by Thomas Winischhofer, Vienna, Austria.
Copyright (c) 2011 Atmel Corporation Josh Wu, <josh.wu@atmel.com>
Copyright (c) 2005 Martin Langer <martin-langer@gmx.de>, Stefano Brivio <stefano.brivio@polimi.it> Michael Buesch <m@bues.ch> Danny van Dyk <kgulfang@gentoo.org> Andreas Jaggi <andreas.jaggi@waterwave.ch>
Copyright (C) 2017 NXP.
Copyright (c) 2009,2010 One Laptop per Child
Copyright 2011 Cisco Systems, Inc. All rights reserved.
Copyright (C) 2018, SECO SpA.
Copyright (C) 2017 Texas Instruments Incorporated - <http://www.ti.com/> Dave Gerlach
Copyright 1996-1997 David J. McKay
Copyright (C) 2011-2012 Synopsys, Inc. (www.synopsys.com)
Copyright (C) 2015 Amlogic, Inc. All rights reserved.
Copyright (C) 2015 ARM Ltd. Author: Lorenzo Pieralisi <lorenzo.pieralisi@arm.com>
(c) 1998 Gerd Knorr <kraxel@goldbach.in-berlin.de>
Copyright (c) 2007 TinCanTools David Anders <danders@amlt.com>
Copyright (C) 2008 Jochen Friedrich <jochen@scram.de>
Copyright (C) International Business Machines Corp., 2002,2010 Author(s): Steve French (sfrench@us.ibm.com)
Copyright (c) 2014 Samsung Electronics Co., Ltd;(c) container_of(c, struct exynos_dsi, connector)
Copyright 2007,2008 Kristoffer Ericson <Kristoffer.Ericson@gmail.com>
(C) Copyright IBM Corporation 2005. Author : Ram Pai (linuxram@us.ibm.com)
(C) 2006 Red Hat
Copyright (C) 2012 Samsung Electronics Co.Ltd
Copyright (C) 1999 David S. Miller (davem@redhat.com)
Copyright (c) 2003-2006 QLogic Corporation QLogic Linux Networking HBA Driver
Copyright (C) 1995-1997 Paul H. Hargrove;(C) 2003 Ardis Technologies <roman@ardistech.com> This file may be distributed
Copyright (C) 2002 Rory Bolt
Copyright (C) 1992 - 1997, 1999, 2000 Silicon Graphics, Inc.
Copyright (C) 2012, Steven King <sfking@fdwdc.com>
Copyright 2012 DENX Software Engineering, GmbH
Copyright (C) 2011-2012 Kathleen Nichols <nichols@pollere.com>
Copyright is a null terminated ASCII string containing the JR3
Copyright (C) Intel Corp.
Copyright (c) 2017 MediaTek Inc. Author: YT Shen <yt.shen@mediatek.com>
Copyright (C) 1999-2007 Tensilica Inc.
Copyright (C) 1995-06 ICP vortex, Achim Leubner See gdt.c for further informations and below for supported controller types
Copyright (C) 2018 Jacopo Mondi <jacopo@jmondi.org>
(C) Copyright IBM Corp. 2001, 2003

Copyright 2005, Paul Mackerras, IBM Corporation.
Copyright 1998 Ben Pfaff;(C) 1997 M. Kirkwood Converted to new API by Alan Cox <alan@lxorguk.ukuu.org.uk>
Various bugfixes and enhancements by Russell Kroll <rroll@exploits.org>
Copyright (C) 2000 Russell King
copyright_file_id [ISODCL (703, 739)]
Copyright 2008 Wind River Systems Inc.
(c) 2005-2008 MSC Vertriebsges.m.b.H, Manuel Lauss <mmlau@msc-ge.com>
Copyright (C) 2009 Conexant Systems Inc. Authors <shu.lin@conexant.com>, <hiep.huynh@conexant.com> Based on Steven Toth <stoth@linuxtv.org> cx23885 driver
Copyright (C) 2009,2012,2013 Imagination Technologies Ltd.
Copyright (C) 2008, 2009 Paul Mundt
Copyright (C) 2018 Cavium Inc. Author: Ganapatrao Kulkarni <gkulkarni@cavium.com>
Copyright IBM Corp. 2007 Author(s): Frank Pavlic <fpavlic@de.ibm.com>, Thomas Spatzier <tspat@de.ibm.com>, Frank Blaschka <frank.blaschka@de.ibm.com>
Copyright (c) 2018 Synopsys, Inc. and/or its affiliates.
Copyright (c) 2011 Atheros Communications Inc.
Copyright (C) 2002 David Howells (dhowells@redhat.com)
Copyright 2016 Free Electrons NextThing Co. Quentin Schulz <quentin.schulz@free-electrons.com>
Copyright 2014 Soeren Moch <smoch@web.de>
Copyright (C) 2002 Intel Corporation.
Copyright IBM Corp. 2002, 2009 Author(s): Cornelia Huck <cornelia.huck@de.ibm.com> Martin Schwidefsky <schwidefsky@de.ibm.com> Peter Oberparleiter <peter.oberparleiter@de.ibm.com>
Copyright (c) 2016 Texas Instruments Incorporated
Copyright 2009-12 Wolfson Microelectronics plc
Copyright IBM Corp. 2004, 2011 Author(s): Martin Schwidefsky <schwidefsky@de.ibm.com>, Holger Smolinski <Holger.Smolinski@de.ibm.com>, Thomas Spatzier <tspat@de.ibm.com>,
Copyright 2017 Nuvoton Technology Crop.
Copyright IBM Corp. 2007, 2010 Author(s): Peter Oberparleiter <peter.oberparleiter@de.ibm.com>
Copyright (C) 2015 Texas Instruments Incorporated - <http://www.ti.com> Author: Peter Ujfalusi <peter.ujfalusi@ti.com>
Copyright 2008 Paul Mackerras, IBM Corp.
Copyright (C) 2009 Lemote Inc. Author: Wu Zhangjin, wuzhangjin@gmail.com
Copyright (C) 2002 Ralph Metzler <rjkm@metzlerbros.de>
Copyright 2018 IBM Corporation Author: Anshuman Khandual <khandual@linux.vnet.ibm.com>
Copyright (C) 2013-2017 Texas Instruments Incorporated - <http://www.ti.com/>
Copyright (c) 2016, Microchip Technology Inc.
Copyright IBM Corporation, 2017
Copyright (C) 2016 Linaro, Ltd. <ard.biesheuvel@linaro.org>
Copyright (C) 2018 Jagan Teki <jagan@openedev.com>
Copyright (c) by Jaroslav Kysela <perex@perex.cz> Takashi Iwai <tiwai@suse.de>
Copyright 1995, 1996, 1998, 1999, 2000, 2003, 2004, 2005 Free Software Foundation, Inc.
Copyright(c) 1999-2018 Intel Corporation.
"Copyright (C) 2012 Renesas Electronics Corporation;(c) container_of(c, struct shmob_drm_crtc, crtc)"
Copyright (C) 2007-2009, OpenWrt.org, Florian Fainelli <florian@openwrt.org> GPIOLIB support for Alchemy chips.
Copyright: [copy] 1999-2001 Vojtech Pavlik <vojtech@ucw.cz> - Sponsored by SuSE
Copyright © 2008-2017 Intel Corporation
Copyright (C) 2018, Red Hat, Inc.
Copyright(c) 2012 - 2015 Intel Corporation. All rights reserved.
Copyright (c) 2015 Texas Instruments Inc. Benoit Parrot, <bparrot@ti.com>
Copyright (c) 2016 Advanced Micro Devices, Inc.
Copyright (C) 2013 Fujitsu.
Copyright (C) 1999 Colin J. Watson <cjw44@cam.ac.uk>.;(c) putchar(c); else utf8_error();
Copyright (C) 2018 ROHM Semiconductors
Copyright (C) 2019 Google, Inc.
(c) Copyright Hewlett-Packard Development Company, L.P., 2006, 2008;(c) Copyright Huw Davies <huw@codeweavers.com>, 2015
Copyright (C) 2009 Sunplus Core Technology Co., Ltd. Chen Liqin <liqin.chen@sunplusct.com> Lennox Wu <lennox.

LICENCE TERMS (cont.)

wu@sunplusct.com>
(C) 1999 Jérôme de Vivie <devivie@info.enserb.u-bordeaux.fr>;(C) 1999 Hervé Eychenne <eychenne@info.enserb.u-bordeaux.fr>;(C) 2006-2012 Patrick McHardy <kaber@trash.net>
Copyright (C) 2004 Richard Purdie
Copyright (C) 2016 Sean Young
Copyright (C) 1999-2000 Russell King
Copyright 2016 Nuvoton Technology Corp. Author: John Hsu <KCHSU0@nuvoton.com>
Copyright (c) 2001-2008 LSI Corporation.
Copyright (c) 2010 Xing Wei <weixing@hanwang.com.cn>
(C) 2004 VIA Technologies Inc.
Copyright (c) 2009 David T. L. Wong <davidtlwong@gmail.com>
Copyright (C) 2007-12 Wolfson Microelectronics PLC.
(c) 1995 Alan Cox, Building #3 <alan@lxorguk.ukuu.org.uk>
Copyright (c) 2011 - 2014 Cambridge Silicon Radio Limited, a CSR plc group company.
Copyright (C) 2008 Lemote Inc. Author: liujl <liujl@lemote.com>, 2008-03-14
Copyright (C) 1999, 2000, 2004 MIPS Technologies, Inc. All rights reserved. Authors: Carsten Langgaard <carstenl@mips.com> Maciej W. Rozycki <macro@mips.com>
Copyright 2015 Robert Jarzmik <robert.jarzmik@free.fr>
Copyright(c) 2018 - 2019 Intel Corporation.
Copyright IBM Corp. 2003, 2013
Copyright 2012-2015 VMware, Inc., Palo Alto, CA., USA
Copyright (c) Evgeniy Polyakov <zbr@ioremap.net> All rights reserved.
Copyright (C) 2016, DAQRI, LLC. Author: Tony Makkiel <tony.makkiel@daqri.com>
Copyright (C) 1997, Stephen Tweedie
Copyright (c) 2009 Nick Kossifidis <mickflemm@gmail.com>
Copyright (C) 2004-2013 Synopsys, Inc. (www.synopsys.com)
Copyright (C) 2002~2010 by Guan Xue-tao
Copyright (c) 2017, Microsoft Corporation.
Copyright (C) 1992,1993,1994,1997 | W. Metzenthien, 22 Parker St, Ormond, Vic 3163, | Australia. E-mail billm@suburbia.net |
© Copyright 2016 ATMEL
Copyright (C) 1997, 1999 Jakub Jelinek (jj@ultra.linux.cz)
Copyright (C) 1998, 2001, 03 by Ralf Baechle
Copyright (C) 2009 Adams.Xu <adams.xu@azwave.com.cn>
Copyright (C) 2009 by Jan Weitzel Phytex Messtechnik GmbH, armlinux@phytec.de>
"Copyright (C) ST-Ericsson AB 2011 Author: Sjur Brendeland"
Copyright (c) 2005, Keir Fraser
Copyright (C) 2004 Red Hat, Inc. All Rights Reserved. Written by David Howells (dhowells@redhat.com)
Copyright 2008 DENX Software Engineering, Stefan Roese <sr@denx.de>
Copyright (C) 2013-2016 Altera Corporation
Copyright (C) 2012 Federico Vaga <federico.vaga@gmail.com>
Copyright (C) 2010 Samsung Electronics Co.Ltd Author: Minkyu Kang <mk7.kang@samsung.com> Author: Joonyoung Shim <jy0922.shim@samsung.com>
Copyright(c) 2013-2016 Intel Corporation. All rights reserved.
Copyright (C) 2006 kogiidena
Copyright 2010 Wolfson Microelectronics, plc
Copyright (C) 2009 Theodore Kilgore
Copyright (C) 2006 Bob Copeland (me@bobcopeland.com) based on osf.c
Copyright 2019 (C) Pengutronix, Marco Felsch <kernel@pengutronix.de>
"Copyright (C) ST-Ericsson AB 2010 Author: Daniel Martensson / Daniel.Martensson@stericsson.com"
Copyright (C) 2017 Hans de Goede <hdegoede@redhat.com>
Copyright (C) 2017 Spreadtrum - http://www.spreadtrum.com
Copyright (C) 2006 Paul Mackerras, IBM Corp. <paulus@samba.org>
Copyright (C) 2016 Wang Nan <wangnan0@huawei.com>
Copyright (C) 2013 Linaro Limited.
Copyright (C) 2013 Xilinx, Inc.
Copyright (C) 2009 Oracle. All rights reserved.

Copyright 2011-2 Wolfson Microelectronics PLC. Author: Mark Brown <broonie@opensource.wolfsonmicro.com>
Copyright (C) 2014 Felix Fietkau <nbd@nbd.name>
Copyright(c) 2018 Intel Corporation.:(c) an RNR NAK has not already been scheduled
Copyright (c) 2014 STMicroelectronics Ltd. Author: Stuart Menefy <stuart.menefy@st.com>
Copyright (c) Matthew Wilcox 2001 for Hewlett-Packard
Copyright (c) Microsoft Corporation.
Copyright (C) 1998-2002 Russell King
Copyright (c) 2008 Wind River Systems, Inc.:(c) 2008 Wind River Systems, Inc
Copyright 2015 Realtek Microelectronics Author: Bard Liao <bardliao@realtek.com>
Copyright (c) 2011 Felix Fietkau <nbd@openwrt.org>
Copyright (C) AbsoluteValue Systems, Inc.
Copyright 2007 David Gibson <dwg@au1.ibm.com>, IBM Corporation.
Copyright (C) 2009 David T.L. Wong <davidtlwong@gmail.com>
Copyright (C) 2011 Nitin Gupta
Copyright © 2006 Keith Packard
Copyright 2004 James Cleverdon, IBM.
Copyright (C) 2000 Steven J. Hill (sjhill@realitydiluted.com) 2002-2006 Thomas Gleixner (tgx@linutronix.de)
Copyright (c) 2017-2018, The Linux Foundation. All rights reserved.
Copyright (c) 2016-2017, Elena Reshetova, Intel Corporation
Copyright IBM Corporation, 2007
Copyright 2019 ARM Ltd.
Copyright 2008 - 2015 Freescale Semiconductor Inc.
(c) 2007 Sebastian Siewior <bigeasy@linutronix.de>
Copyrighted (c) 2013 by Freescale Semiconductor, Inc.:(c) MontaVista Software, Inc.:(C) 2006 Montavista Software
Copyright (C) 2009-2010 Intel Corporation. All rights reserved.
Copyright 2008 by Andreas Eversberg <andreas@eversberg.eu>
Copyright (c) 2013-2014, NVIDIA CORPORATION. All rights reserved.
Copyright (C) 2005-2007 Atmel Corporation
Copyright 2008 ioogole, Inc. All rights reserved.
Copyright (C) 2013 Naveen Krishna Chatradhi <ch.naveen@samsung.com>
Copyright (C) 2016-17, Intel Corporation. Author: Guneshwor Singh <guneshwor.o.singh@intel.com>
Copyright (c) 2005 Intel Corporation. All rights reserved.
Copyright IBM Corporation, 2007-2012
Copyright (C) 2004, 2005 Nokia Corporation
Copyright (c) 2016 Quantenna Communications. All rights reserved.
Copyright © 2011-2016 Intel Corporation
Copyright (C) Canonical Ltd. <seth.forshee@canonical.com>
Copyright 1999-2000 Jeff Garzik
Copyright (C) 2013 Samsung Electronics Co., Ltd. Author: Beomho Seo <beomho.seo@samsung.com>
Copyright (c) 2013-2016 Jens Kuske <jenskuske@gmail.com>
Copyright (c) Clemens Ladisch
(c) 2014 Jeff Layton <jlayton@primarydata.com>
Copyright (C) 2017 Impinj
copyrighted 1992 by Mark Adler version c10p1, 10 January 1993
Copyright (C) 2001, 2002, 2003, 2004 David S. Miller (davem@redhat.com)
Copyright (C) 2014 Thomas Petazzoni <thomas.petazzoni@free-electrons.com>
Copyright (C) 2014-2017 Linaro Ltd. <ard.biesheuvel@linaro.org>
Copyright (C) 1999-2000 Moxa Technologies (support@moxa.com).
Copyright (C) 2007, 2008, 2009, 2010, 2011 Cavium Networks
Copyright (C) 2008-2011 Freescale Semiconductor, Inc. All rights reserved.
Copyright 2017 Cisco Systems, Inc. and/or its affiliates. All rights reserved.
Copyright (C) 2013 Marek Belisko <marek@goldelico.com>
Copyright (C) 2008, 2009 Cavium Networks, Inc.
Copyright (c) 2005 David Brownell
Copyright (C) 2008 Marvell Semiconductors
Copyright (C) 2011 Samsung Electronics Co.Ltd Author: Joonyoung Shim <jy0922.shim@samsung.com>
Copyright (c) 2018 Linaro Ltd. Author: Manivannan Sadhasivam <manivannan.sadhasivam@linaro.org>

LICENCE TERMS (cont.)

Copyright 2014 - Iain Paton <ipaton0@gmail.com>
Copyright (c) 2014, Applied Micro Circuits Corporation Authors: Iyappan Subramanian <isubramanian@apm.com>
Ravi Patel <rapatel@apm.com> Keyur Chudgar <kchudgar@apm.com>
Copyright (C) 2017 Marek Vasut <marek.vasut+renesas@gmail.com>
Copyright (C) 2012 Nokia Corporation Contact: Sakari Ailus <sakari.ailus@iki.fi>
Copyright (C) 2007 Luca Bigliardi (shammash@artha.org).
Copyright (C) 2008-2009 Gabor Juhos <juhosg@openwrt.org>
(c) 2007 Mauro Carvalho Chehab, <mchehab@kernel.org>;(c) 2001,02 Gerd Knorr <krxel@bytesex.org>;(c) 2006
Mauro Carvalho Chehab, <mchehab@kernel.org>;(c) 2006 Ted Walther and John Sokol
(C) 2007 Alexander Shishkin <virtuoso@slind.org>;(C) 2009 Valentin Sitdikov <v.sitdikov@gmail.com>;(C) 2009
Siemens AG
Copyright (C) 2002,2003 Takayoshi Kochi (t-kochi@bq.jp.nec.com)
Copyright (C) 1999,2000,2001 by Michael Engel <engel@unix-ag.org> and Karsten Merker <merker@linuxtag.org>.
This file is subject to the terms and conditions of the GNU General Public License. See the file COPYING in the main
directory of this archive for more
Copyright (C) 2012-2016, Yann Collet.
Copyright (C) 2009 Semihalf
Copyright (C) 2011 Atmel, 2011 Nicolas Ferre <nicolas.ferre@atmel.com>, 2012 Joachim Eastwood <manabian@
gmail.com>
Copyright (C) 2010 Broadcom
(c) Rebel.com, 1998-1999
Copyright (c) 2004-2006 Helge Deller <deller@gmx.de>
Copyright (c) 2006-2007 Tungsten Graphics, Inc., Cedar Park, TX., USA All Rights Reserved.
(c) Copyright 2005 Benjamin Herrenschmidt, IBM Corp. benh@kernel.crashing.org>
Copyright (c) 2000-2002 Vojtech Pavlik
(C) COPYRIGHT 2019 ARM Limited. All rights reserved. Author: James.Qian.Wang <james.qian.wang@arm.com>
Copyright © 2017 Amazon.com, Inc. or its affiliates.
Copyright (c) by Jaroslav Kysela <perex@perex.cz> Creative Labs, Inc.
Copyright (C) Paul Mackerras 2005
Copyright (C) 2009-2011 Florian Fainelli <florian@openwrt.org>
Copyright (C) 2006 Thumtronics Pty Ltd. Developed for Thumtronics by Grey Innovation Ben Williamson <ben.
williamson@greyinnovation.com>
Copyright (c) ARM Limited 2003. All rights reserved.
Copyright (C) 2018 Spreadtrum, Inc. Author: Chunyan Zhang <chunyan.zhang@unisoc.com>
Copyright (C) 2013-15 Synopsys, Inc. (www.synopsys.com)
Copyright (C) 2013 Tom Zanussi <tom.zanussi@linux.intel.com>
Copyright (C) 1998-2000, 2002 Hewlett-Packard Co David Mosberger-Tang <davidm@hpl.hp.com>
(c) Copyright 1995 Simon "Guru Aleph-Null" Janes NCM: Network and Communications Management, Inc.:(c)
Copyright 1999, Thomas Davis, tadavis@lbl.gov
Copyright (C) 2003 Coherent Imaging Systems
Copyright (C) 1995, 1996 Gero Kuhlmann <gero@gkminix.han.de>
Copyright (C) 2016 CoreOS, Inc
Copyright (c) 2014 Steffen Trumtrar <s.trumtrar@pengutronix.de>
Copyright (C) 2016 Raashid Muhammed <raashidmuhammed@zillogic.com>
Copyright (C) 1992,1993,1994,1997 | W. Metzenthien, 22 Parker St, Ormond, Vic 3163, Australia | E-mail billm@
suburbia.net |
Copyright (c) 2019 Takashi Sakamoto
Copyright (C) 2008-2013 Jozsef Kadlecsik <kadlec@netfilter.org>
Copyright (c) 2014 Oleksij Rempel <linux@rempel-privat.de>
Copyright (C) 2010, Lars-Peter Clausen <lars@metafoo.de> JZ4740 platform PWM support
Copyright (c) 2014 Imagination Technologies Ltd.
Copyright (C) 2007 Semihalf
Copyright (C) 2016 BayLibre SAS. Author: Neil Armstrong <narmstrong@baylibre.com> Synchronised with arm_
mhu.c from :
(c) Copyright 1999 Alex deVries for The Puffin Group;(c) Copyright 1999 Grant Grundler for Hewlett-Packard;(c)
Copyright 1999 Matthew Wilcox;(c) Copyright 2000 Helge Deller;(c) Copyright 2001 Matthew Wilcox for Hewlett-
Packard

Copyright (C) 1997-2014 AudioScience Inc. <support@audioscience.com>;(C) Copyright AudioScience Inc. 2007
(C) 2000 Red Hat. GPL'd.
Copyright (C) 2001-2002 Convergence Integrated Media GmbH
Copyright (C) 2008 IBM Corporation Author(s): Brian King (brking@linux.vnet.ibm.com),
Copyright (C) 1997 Geert Uytterhoeven;© Copyright 1995 Apple Computer, Inc. All rights reserved.
Copyright (C) 2001, 2002 M. R. Brown
Copyright (C) 2019 Dialog Semiconductor
Copyright (c) 2000 Eric Brower <ebrower@usa.net>
Copyright (C) 2008 <srinivasa.deevi at conexant dot com> Based on em28xx driver Based on Cx23885 driver
Copyright (C) 2008 Nokia Corporation Contact: Felipe Balbi <felipe.balbi@nokia.com>
Copyright (C) 2013, 2014 Linaro Ltd; <roy.franz@linaro.org>
(C) 2000 by R.E.Wolff@BitWizard.nl Copied snippets from zatm.c by Werner Almesberger, EPFL LRC/ICA
Copyright (C) 2006-2008 KeyStream Corp.
(C) 2003 Linux Networx (http://lnxi.com) This file may be distributed
Copyright (C) 2014 Broadcom Corporation Author: Kevin Cernekee <cernekee@gmail.com>
Copyright 2008-12 Wolfson Microelectronics
Copyright (c) 2014 Motorola Mobility
Copyright (c) 2002,2003,2004 Google, Inc. All rights reserved.
Copyright (C) ST-Ericsson SA 2010-2013 Author: Rickard Andersson <rickard.andersson@stericsson.com> for
ST-Ericsson. Author: Daniel Lezcano <daniel.lezcano@linaro.org> for Linaro.
Copyright (C) 2011, 2012 Cavium, Inc.
Copyright(c) 2012 Realtek Corporation.
Copyright (C) 2013-2015 Freescale Semiconductor, Inc. All Rights Reserved
Copyright 2007-2009 Freescale Semiconductor Inc.
Copyright (C) 2009 Texas Instrument Incorporated - http://www.ti.com/
(c) 2000, 2001 Robert Baruch (autophile@starband.net);(c) 2002 Andries Brouwer (aeb@cw.nl) Developed with the
assistance of:(c) 2002 Alan Stern <stern@rowland.org>
Copyright (C) 2011 Texas Instruments, Inc. Mike Turquette <mturquette@ti.com>
Copyright (C) 2018, Intel Corporation Author: Heikki Krogerus <heikki.krogerus@linux.intel.com>
Copyright (c) 2016 Samsung Electronics Co., Ltd. Chanwoo Choi <cw00.choi@samsung.com>
Copyright (C) 2016-2018 Broadcom
Copyright 2006 Dave Airlie
Copyright © 2009-2010, Intel Corporation and its suppliers.
Copyright (C) Fuzhou Rockchip Electronics Co.Ltd Zheng Yang <zhengyang@rock-chips.com>
Copyright(c) 2004 - 2009 Intel Corporation. All rights reserved.
Copyright (C) 2012 Texas Instruments Incorporated
Copyright (C) 2014 Intel Corp, Author: Lan Tianyu <tianyu.lan@intel.com>
(C) Copyright David Gibson <dwg@au1.ibm.com>, IBM Corporation. 2005.
Copyright (C) 2007 8D Technologies inc. Raphael Assenat <raph@8d.com>
"Copyright: (c) 1998-2003 Arnaldo Carvalho de Melo"
Copyright (c) 2019, Mellanox Technologies inc. All rights reserved.
Copyright 2005 Nicolai Haehle et al.
Copyright (C) 2016 Mellanox Technologies
Copyright (c) 2009 Dialog Semiconductor Written by David Chen <Dajun.chen@diasemi.com>
Copyright (c) 1999-2001 Vojtech Pavlik
Copyright (C) 2019 Rockchip Electronics Co., Ltd. ZhiChao Yu <zhihao.yu@rock-chips.com>
Copyright 2006 Freescale Semiconductor, Inc. All rights reserved.
Copyright 2010 Ben Dooks <ben-linux@at> fluff.org>
Copyright (C) 2019 ASPEED Technology Inc.
Copyright (C) 2012 ST-Ericsson SA Written on behalf of Linaro for ST-Ericsson This interface is used in the core to
keep track of pins.
Copyright 2002 Tungsten Graphics, Inc., Cedar Park, Texas. All Rights Reserved.
Copyright (c) 2005-7 The University of Waikato, Hamilton, New Zealand.
Copyright (C) 1997-2014 AudioScience Inc. <support@audioscience.com>
Copyright (c) 2007 Red Hat, Inc. Author(s): Jeff Layton (jlayton@redhat.com)
(C) Copyright IBM 2004, 2005, 2006, 2012v2
Copyright (c) 2010 Michael Poole <mdpooles@trouilous.org>

LICENCE TERMS (cont.)

Copyright (C) 2016 Jens Axboe <axboe@kernel.dk>
Copyright (C) 2016 Atmel,
Copyright (C) 2018 Johannes Thumshirn <jth@kernel.org>
(C) 2004 Bruno Ducrot <ducrot@poupinou.org>
Copyright (C) 2008-2010 Thomas Chou <thomas@wytron.com.tw>
Copyright (C) 1994-1999 Russell King
Copyright (C) 2011 Aeroflex Gaisler AB, Daniel Hellstrom
Copyright (c) 2016 - Savoir-faire Linux
Copyright (C) 1995, 1999 Ralf Baechle
Copyright (c) 2015 MediaTek Inc. Author: CK Hu <ck.hu@mediatek.com>
Copyright (c) 2006, Ian Campbell, XenSource Inc.
Copyright © 2012-2016 Intel Corporation
Copyright (C) 2008 Yoshihiro Shimoda
Copyright 2007 Simtec Electronics http://armlinux.simtec.co.uk/ Ben Dooks <ben@simtec.co.uk>
Copyright (c) 2016 Daniel Mack
Copyright (c) 2011 Zhang, Keguang <keguang.zhang@gmail.com>
(c) Copyright 2010-2013 Datera, Inc.
Copyright (C) 2013 - 2014 Xilinx
Copyright (C) M'boumba Cedric Madianga 2016
Copyright (c) 2016 Ryder Lee <ryder.lee@mediatek.com>
Copyright 2016 Intel Corporation
Copyright 2010 Maxim Integrated Products
Copyright (C) 2013-14 Intel Corp Author: Omair Mohammed Abdullah <omair.m.abdullah@intel.com> Vinod Koul <vinod.koul@intel.com>
Copyright (C) 2009 by Abhishek Kulkarni <adkulkar@umail.iu.edu>
Copyright 2004 (c) MontaVista, Software, Inc.
Copyright (C) 2015 Glider bvba
Copyright (C) 1997-2002 Russell King hacked for non-paged-MM by Hyok S. Choi, 2003.
Copyright (c) 2014 Samsung Electronics Co., Ltd. Author: Chanwoo Choi <cw00.choi@samsung.com>
Copyright 2014 Siarhei Siamashka <siarhei.siamashka@gmail.com>
Copyright (C) 2006-2009, Uri Shkolnik
Copyright (C) 2000-2002 Russell King
Copyright IBM Corp. 2007, 2011
Copyright (C) 2012 Iain Paton <ipaton0@gmail.com>
Copyright (C) 2014 - 2017 Linaro Ltd <ard.biesheuvel@linaro.org>
Copyright (C) 2013 Atmel, 2013 Ludovic Desroches <ludovic.desroches@atmel.com>
Copyright 2017 IBM Corp. include <linux/sched/mm.h> include <linux/mutex.h> include <linux/mm_types.h> include <linux/mmu_context.h> include <asm/copro.h> include <asm/pnv-ocxl.h> include <misc/ocxl.h> include "ocxl_internal.h" include "trace.h"
Copyright (C) 2009 Intel Corporation, Yu Zhao <yu.zhao@intel.com>
Copyright (C) 2008-2010
Copyright (c) 2010,2011 Code Aurora Forum. All rights reserved.
(C) 2008-2013 Christoph Lameter <cl@linux.com>
Copyright (c) 2018-2019 Pensando Systems, Inc. All rights reserved.
Copyright (C) 1999 Ralf Baechle
(c) 1995 David Mosberger (davidm@cs.arizona.edu)
Copyright (C) 2009, Greg Ungerer (gerg@snapgear.com)
Copyright (c) 2018 Vincent Pelletier
Copyright(c) 2016, Intel Corporation.
Copyright (C) 2004-2006 Atmel Corporation
Copyright (C) 2013 Maxime Hadjinlian <maxime.hadjinlian@gmail.com>
Copyright (C) 2009 Conexant Systems Inc. Authors <shu.lin@conexant.com>, <hiep.huynh@conexant.com> Based on SAA713x ALSA driver and CX88 driver
Copyright (C) 2005 International Business Machines Corporation
Copyright 2003 Kai Germaschewski
Copyright (C) 2013 Cavium Inc. Author: Vijaya Kumar K <vijaya.kumar@caviumnetworks.com>
(C) 2000 by Harald Welte <laforge@netfilter.org>
Copyright (c) 2006-2007 MontaVista Software, Inc.
Copyright (C) 1998 Philip Blundell <philb@gnu.org>
Copyright (C) 2002, Linus Torvalds
Copyright 2012 (C), Thomas Petazzoni <thomas.petazzoni@free-electrons.com>
(C) 2000 Marc Boucher <marc@mbsi.ca>
"Copyright (C) 1999 - 2001 Greg Kroah-Hartman <greg@kroah.com>"
"Copyright (c) 1999-2004 Vojtech Pavlik <vojtech@suse.cz>"
Copyright (C) 2013 STMicroelectronics (R&D) Limited. Author(s): Srinivas Kandagatla <srinivas.kandagatla@st.com>
Copyright (C) 2009 Wolfson Microelectronics plc
Copyright (c) 2010 Novell, Inc. Authors(s): Suresh Jayaraman (sjayaraman@suse.de)
Copyright (C) 2009-2010, Lars-Peter Clausen <lars@metafoo.de>
Copyright (C) 2005 Bob Copeland <me@bobcopeland.com>
Copyright (C) 2002 David J. McKay & Benedict Gaster
Copyright (C) 2009 Giuliano Pochini <pochini@shiny.it>
Copyright (C) 2004-2006, Advanced Micro Devices, Inc.
Copyright (c) 2013 Tomasz Figa <tomasz.figa@gmail.com>
Copyright (C) 2008-2009 The GameCube Linux Team
Copyright (c) 2016, Citrix Systems, Inc.
Copyright (C) 1996,97,98 Ralph Metzler (rjkm@thp.uni-koeln.de) Marcus Metzler (mocm@thp.uni-koeln.de);(c) 1999-2003 Gerd Knorr <kraxel@bytesex.org>
Copyright (C) 1992 by Jim Weigand and Linus Torvalds
Copyright (C) 2008 - 2013 by Tensilica Inc.
Copyright 2002 SuperH Ltd.
Copyright (C) 2001, 06 by Ralf Baechle (ralf@linux-mips.org)
Copyright (C) 2010, Lars-Peter Clausen <lars@metafoo.de> JZ4740 platform time support
Copyright Gavin Shan, IBM Corporation 2016.
Copyright (c) 1999 Ulf Carlsson <ulfc@bun.falkenberg.se>
Copyright Cavium, Inc. (C) 2015-2017. All rights reserved.
Copyright (C) 2017 Landen Chao <landen.chao@mediatek.com> Sean Wang <sean.wang@mediatek.com>
Copyright (C) 2016 Cadence Design Systems - http://www.cadence.com
Copyright (c) 2012 Extreme Engineering Solution, Inc. Author: Aaron Sierra <asierra@xes-inc.com>
Copyright (C) 2008 ARM Limited, All Rights Reserved.
Copyright 2015 Annapurna Labs Ltd.
Copyright (C) 2014, Arnaud EBALARD <arno@natisbad.org>
Copyright (C) 2011 - 2012 Cavium, Inc.
Copyright IBM Corp. 2014 Author(s): Alexey Ishchuk <aishchuk@linux.vnet.ibm.com>
Copyright (c) 2009 Fabio Checconi, Luigi Rizzo, and Paolo Valente.
Copyright (C) 2008 Cedric Bregardis <cedric.bregardis@free.fr> and Jean-Christian Hassler <jhassler@free.fr>
(C) Copyright 2002 David Brownell;(C) Copyright 2002,2004 Greg Kroah-Hartman;(C) Copyright 2002,2004 IBM Corp.
Copyright (C) 2009-2012 ST Microelectronics Viresh Kumar <vireshk@kernel.org>
Copyright 2008 Simtec Electronics http://armlinux.simtec.co.uk/ Ben Dooks <ben@simtec.co.uk>
Copyright (C) 2001-2004 Amit S. Kale
Copyright (c) 2015-2018 The Linux Foundation. All rights reserved.
Copyright (C) 2008 Rod Whitby <rod@whitby.id.au>
Copyright 2002 MontaVista Software Inc. Author: MontaVista Software, Inc. stevel@mvista.com or source@mvista.com
Copyright (C) 2009-2012 Oracle Corp. All rights reserved. Author: Dan Magenheimer
Copyright 2015 Timesys Corporation.
Copyright (C) 2017 Intel Corporation.
Copyright (C) 1996-1999 Jakub Jelinek (jakub@redhat.com)
Copyright (C) 2012-2013 Renesas Solutions Corp.
(C) Copyright 1999-2011, Greg Ungerer <gerg@snapgear.com>.
Copyright (C) 2014-2015 Freescale Semiconductor, Inc. All Rights Reserved
Copyright (C) 2010 SUSE Linux Products GmbH
Copyright (c) 2017-18 David Ahern <dsahern@gmail.com>

LICENCE TERMS (cont.)

Copyright (C) 1995-99 Simon G. Vogl With some changes from Kyösti Mälkki <malkki@cc.hut.fi> Mux support by Rodolfo Giometti <giometti@enneenne.com> and Michael Lawnick <michael.lawnick.ext@nsn.com>
Copyright (C) 2006 SWAPP Andrea Paterniani <a.paterniani@swapp-eng.it>
Copyright (C) 1994, 1995 by Waldorf Electronics, written by Ralf Baechle.
Copyright 1997 by Alain Malek
Copyright (C) 2014 Atmel
Copyright (C) 2009 Hong H. Pham <hong.pham@windriver.com>
(C) Copyright 2002 Alan Cox <alan@lxorguk.ukuu.org.uk>
Copyright (C) 1994, 95, 96, 97, 98, 99, 2000, 01, 02, 03 by Ralf Baechle
Copyright: [copy] 2008-2010 Rafi Rubin <rafi@seas.upenn.edu>
Copyright (c) 2015-2018, VeriSilicon Inc.
Copyright (C) 1996, 1997, 2007 David S. Miller (davem@davemloft.net)
Copyright (c) 2008-2013 Broadcom Corporation
Copyright (C) 2004, 2010 Nokia Corporation Written by Timo Teras <ext-timo.teras@nokia.com>
(C) 2008-2009 Pablo Neira Ayuso <pablo@netfilter.org>
Copyright 2008-2016 Freescale Semiconductor, Inc.
Copyright (C) 2001 by Andreas Gruenbacher, <a.gruenbacher@computer.org>
Copyright (C) 2010 Jean-Francois Moine (http://moinejf.free.fr)
Copyright (C) 2014, Intel Corporation
Copyright 2015 Solarflare Communications Inc.
Copyright 2001,2002 Jeff Garzik
Copyright 2015 - Maxime Coquelin <mcoquelin.stm32@gmail.com>
Copyright (C) 2014 Kamlakant Patel <kamlakant.patel@broadcom.com>
Copyright (c) 2004, Intel Corporation.
Copyright (c) 2011-2013 David Herrmann <dh.herrmann@gmail.com>
Copyright (C) 2012,2013 Alexander Shiyam <shc_work@mail.ru>
Copyright (C) 2012 Rabin Vincent <rabin at rab.in>
Copyright 2011 Freescale Semiconductor, Inc
Copyright (c) 2017 - 2018 Covalent IO, Inc. http://covalent.io
Copyright 2019 Analog Devices Inc.
Copyright 2003-2004 Red Hat, Inc. All rights reserved.
(C) Copyright IBM 2015
Copyright 2016 Noralf Trønnes
Copyright (C) 2017-2018 Corentin Labbe <clabbe@baylibre.com>
Copyright (C) 2013 Aeroflex Gaisler
Copyright (c) International Business Machines Corp., 2002,2009 Author(s): Steve French (sfrench@us.ibm.com)
Copyright (C) 2015 Infineon Technologies AG
Copyright (C) 2011 Jon Medhurst <tixy@yxit.co.uk>.
(c) Copyright 2005-2006 Red Hat
Copyright (C) 2010 - 2011 Texas Instruments
Copyright (c) 2014, Applied Micro Circuits Corporation Author: Loc Ho <lho@apm.com> Tuan Phan <tphan@apm.com> Suman Tripathi <stripathi@apm.com>
Copyright (C) 2017 Facebook Inc.
Copyright (C) 2004, 2006, 2009, 2010, 2011 Texas Instruments Incorporated Author: Aurelien Jacquot (aurelien.jacquot@jaluna.com)
Copyright 2015 Chen-Yu Tsai <wens@csie.org>
Copyright (C) 1998-2000 Russell King
Copyright 2015 - Ultimaker B.V. Author Olliver Schinagl <oliver@schinagl.nl>
Copyright (C) 2010 Samsung Electronics Co.Ltd
Copyright (c) 2014 Rockchip Electronics Co., Ltd. Hertz Wong <hertz.wong@rock-chips.com> Herman Chen <herman.chen@rock-chips.com>
Copyright (C) 2010 FUJITSU LIMITED
Copyright (C) 1998-2004 by David Mosberger-Tang <davidm@hpl.hp.com>
Copyright (C) 2002-2007 Kristian Høgsberg
Copyright (C) 2004 Benjamin Herrenschmidt, IBM Corp.benh@kernel.crashing.org>
Copyright (c) 2007 Alexey Starikovskiy
Copyright 2011-2012 Texas Instruments Inc.

Copyright (C) 2004 Greg Kroah-Hartman <greg@kroah.com>
Copyright 2003, 2007 Simtec Electronics http://armlinux.simtec.co.uk/ Ben Dooks <ben@simtec.co.uk>
Copyright (C) 2018 Icenowy Zheng
Copyright 2009-2012 Freescale Semiconductor, Inc. All Rights Reserved.
Copyright 2019, Michael Neuling, IBM Corporation.
Copyright (C) 1999, 2000 Niibe Yutaka
Copyright 2013-16 Advanced Micro Devices, Inc.
Copyright 2013 IBM Corporation Author: Mahesh Salgaonkar <mahesh@linux.vnet.ibm.com>
Copyright (c) 2007, 2008 Patrick McHardy <kaber@trash.net>
Copyright (C) 2007 Michael Krufky <mkrufky@linuxtv.org>
(c) 2008, Steven Rostedt <srostedt@redhat.com>
Copyright © 2008 Renesas Solutions Corp.
Copyright(C) 2011 Linaro Limited. All rights reserved. Author: Sumit Semwal <sumit.semwal@ti.com>
Copyright (C) 2000-2003 Russell King.
Copyright 2016 Realtek Semiconductor Corp. Author: Oder Chiou <oder_chiou@realtek.com>
Copyright (c) 2003-2005, K A Fraser
(C) 1993, Hamish Macdonald, see a2091.c for more info
Copyright (C) 2008, Intel Corp. Author: Huang Ying <ying.huang@intel.com> Vinodh Gopal <vinodh.gopal@intel.com> Kahraman Akdemir
Copyright (C) 2013-2018 Synopsys, Inc. (www.synopsys.com)
(C) 2014 by Pablo Neira Ayuso <pablo@netfilter.org>
Copyright 2008 Codehermit
(C) Copyright 2005 Greg Kroah-Hartman <gregkh@suse.de>
Copyright (C) 2005 by Eric Van Hensbergen <ericvh@gmail.com>
Copyright (c) 2017, Microchip Technology Inc. 2017 Cristian Birsan <cristian.birsan@microchip.com> 2017 Claudiu Beznea <claudiu.beznea@microchip.com>
Copyright (C) 2015 Martin Sperl
Copyright (C) 2017 Fuzhou Rockchip Electronics Co., Ltd
Copyright (c) 2003, Jouni Malinen <j@w1.fi>
Copyright (C) 2010 - NVIDIA, Inc.
Copyright (c) 2017-2019 Linaro, Ltd. <ard.biesheuvel@linaro.org>
Copyright (c) 2007 Igor Mammedov Author(s): Igor Mammedov (niallain@gmail.com) Steve French (sfrench@us.ibm.com) Wang Lei (wang840925@gmail.com) David Howells (dhowells@redhat.com)
Copyright (c) 2014-2015 MediaTek Inc. Author: Chaotian.Jing <chaotian.jing@mediatek.com>
Copyright (c) 2018, Oracle and/or its affiliates
Copyright (C) 2015, Intel Corp. Author: Mika Westerberg <mika.westerberg@linux.intel.com> Author: Rafael J. Wysocki <rafael.j.wysocki@intel.com>
Copyright (C) 1998-2003 Hewlett-Packard Co Stephane Eranian <eranian@hpl.hp.com> David Mosberger <davidm@hpl.hp.com>
Copyright 2007 Rusty Russell IBM Corporation
Copyright (C) 2002 NetChip Technology, Inc. (http://www.netchip.com)
Copyright (C) 2006-2010 Red Hat, Inc. All rights reserved.
Copyright (C) 1996, 97, 98, 2000, 03, 04, 06 Ralf Baechle (ralf@linux-mips.org)
Copyright (C) 2009 Texas Instruments Incorporated - http://www.ti.com
(C) 2017-2018 Synopsys, Inc. (www.synopsys.com)
Copyright (C) 2012-2013, Samsung Electronics, Co., Ltd. Andrzej Hajda <a.hajda@samsung.com>
Copyright (c) 2010 RidgeRun (todd.fischer@ridgerun.com)
Copyright (c) 2013-2015 SUSE Authors: Jiri Kosina Vojtech Pavlik Jiri Slaby
Copyright(C) 2005, Thomas Gleixner <tglx@linutronix.de>
Copyright (C) 2010 James Courtier-Dutton (James@superbug.co.uk)
Copyright (C) 2018 Florian Fainelli <f.fainelli@gmail.com>
Copyright (c) 2014 MediaTek Inc. Author: James Liao <jamesj.liao@mediatek.com>
Copyright (C) 2015-16 by Wolfram Sang, Sang Engineering <wsa@sang-engineering.com>
Copyright (C) 2002 Hewlett Packard Company.
Copyright (c) 2012 DENX Software Engineering, GmbH.
Copyright (C) 2007-2008, 2011 Texas Instruments, Inc.
Copyright (C) 2004 David Woodhouse, Duncan Sands, Roman Kagan

LICENCE TERMS (cont.)

Copyright (C) 2017 Dell, Inc.
Copyright (C) 2018 Linaro Ltd <ard.biesheuvel@linaro.org>
Copyright 2001 David Brownell
Copyright (C) 2013, Angelo Compagnucci Author: Angelo Compagnucci <angelo.compagnucci@gmail.com>
Copyright(c) 2018 Intel Corporation. All rights reserved. Intel specific definitions for NVDIMM Firmware Interface Table - NFIT
Copyright (C) 1999 John G. Dorsey. All Rights Reserved.
Copyright 2017, IBM Corporation.
Copyright [copy] 2009 Nokia Corporation
Copyright (c) 2013,2014 Uplogix, Inc. David Barksdale <dbarksdale@uplogix.com>
Copyright (c) 2010 Alexander Sverdlin <subaparts@yandex.ru>
Copyright (C) 2008 Nicholas Beck <nbeck@mpc-data.co.uk>
Copyright (C) 2011 Sigfox Author: Marc Vertes <marc.verts@sigfox.com> Based on a preliminary version from Harald Welte <HaraldWelte@viatech.com> Timer code by Wim Van Sebroeck <wim@iguana.be>
Copyright (C) 2010 One Laptop per Child Foundation.
Copyright (c) 2010-2012, NVIDIA Corporation. All rights reserved.
Copyright © 2007 Nokia Corporation. All rights reserved.
(c) 2004 Ian Molton <spyro@f2s.com>
Copyright (C) 2004-2008, 2009, 2010 Cavium Networks
Copyright 2018 Google Inc. Author: Eric Dumazet (edumazet@google.com)
(C) Copyright 2014 Intel Corporation
Copyright (c) 2007 Kevin O'Connor <kevin@koconnor.net>
Copyright (C) 2005, Freescale (www.freescale.com)
Copyright 2016 NXP Semiconductor;(c) MontaVista Software, Inc.
Copyright (c) 1999 Dan Malek (dmalek@jlc.net);(C) 2000-2001 Felix Domke (tmbinc@gmx.net), Gillem (htoa@gmx.net);(C) 2007 Montavista Software, Inc. Vitaly Bordug <vitb@kernel.crashing.org>;(C) 2007,2008 Jochen Friedrich <jochen@scram.de>
Copyright (C) 2015-2016 Red Hat
Copyright (C) 2008 Ben. Herrenschmidt (benh@kernel.crashing.org), IBM Corp.
Copyright (C) 2016-2017 Hans de Goede <hdegoede@redhat.com>
Copyright (C) 1999, 2000 Thomas Sailer (sailer@ife.ee.ethz.ch)
Copyright 2020 NXP.
(C) Copyright TOSHIBA CORPORATION 2005-2007
Copyright (C) 1999, 2002 Niibe Yutaka
Copyright (c) 2006 Dave Airlie <airlied@linux.ie>
Copyright (C) 2016 ARM Limited, All Rights Reserved. Author: Marc Zyngier <marc.zyngier@arm.com>
Copyright: (C) 2011 Julia Lawall, INRIA/LIP6.
Copyright (C) 2006-2010 by Marin Mitov * mitov@jssp.bas.bg *
Copyright (c) 2010 - 2017 Intel Corporation. All rights reserved.
Copyright (c) Yaegashi Takeshi, 2001
Copyright (c) 2018-2019 MediaTek Inc.
Copyright (c) 2012 Intel Corporation. All rights reserved.
Copyright (C) 1998-1999 ARM Limited.
Copyright (c) 2018, Linaro Limited.
Copyright (C) 2010,2017 Intel Corp
(C) 2000 Nicolas Pitre <nico@fluxnic.net>
Copyright 2007, 2008 Wolfson Microelectronics PLC
Copyright (C) 2002 Tapio Laxström (tapio.laxstrom@iptime.fi)
Copyright 2008 Nick Forbes <nick.forbes@incepta.com>
"Copyright (c) 1999 Armin Fuerst <fuerst@in.tum.de>"
Copyright (C) 2012 Simon Budig, <simon.budig@kernelconcepts.de> Daniel Wagener <daniel.wagener@kernelconcepts.de> (M09 firmware support) Lothar Waßmann <LW@KARO-electronics.de> (DT support)
Copyright (C) 2004-2007, David Dillow Written by David Dillow <dave@thedillows.org> Inspired by the Trident 4D-WaveDX/NX driver.
Copyright (c) <year> <copyright holders>
Copyright (C) STMicroelectronics 2017 Author: Yannick Fertre <yannick.fertre@st.com> for STMicroelectronics.
Copyright: (C) 2008 Mistral Solutions Pvt Ltd.,
Copyright (C) 1997, 1998, 1999, 2000 Ingo Molnar
Copyright (C) 2001, 2002 Frank Mori Hess <fmhess@users.sourceforge.net>
Copyright (C) 2007 Lemote Inc. Author: Fuxin Zhang, zhangfx@lemote.com
Copyright (c) 2010 by Igor M. Liplianin <liplianin@me.by>
Copyright 2008-2013 Freescale Semiconductor, Inc.
Copyright (C) 2004 Paul Mackerras (paulus@samba.org) and Benjamin Herrenschmidt (benh@kernel.crashing.org)
Copyright (C) STMicroelectronics SA 2017 Author: Fabien Dessenne <fabien.dessenne@st.com>
Copyright IBM Corp. 1999 Author(s): Hartmut Penner (hp@de.ibm.com), Martin Schwidefsky (schwidefsky@de.ibm.com)
Copyright 2014 Realtek Semiconductor Corp.
Copyright(c) 2011-2017 Intel Corporation. All rights reserved.
Copyright (c) 2006-2016 Herbert Xu <herbert@gondor.apana.org.au>
Copyright (C) 2008 Thomas Bogendoerfer <tsbogend@alpha.franken.de>
Copyright (c) 2003-2008 Simtec Electronics http://armlinux.simtec.co.uk/
Copyright (C) 2003 Linda Xie <lxie@us.ibm.com>
Copyright (C) 2001 by Ladislav Michl
Copyright 2016 Luxul Inc.
Copyright (C) 2016 Rafał Milecki <zajec5@gmail.com>
Copyright (c) 2017 MediaTek Inc. Author: Mars.C <mars.cheng@mediatek.com>
Copyright IBM Corp. 2007, 2011 Author(s): Martin Schwidefsky <schwidefsky@de.ibm.com>
Copyright 2010 Red Hat, Inc.
Copyright (C) 2004 BULL SA.
Copyright (C) 2016, Amazon.com, Inc. or its affiliates. All Rights Reserved.
Copyright (C) 2010 Texas Instruments, Inc. Thara Gopinath <thara@ti.com> Benoît Cousson
Copyright (c) 2001 Cliff Brake, Acceleant Systems Inc.
Copyright IBM Corp. 1999, 2000 Author(s): Hartmut Penner (hp@de.ibm.com) Martin Schwidefsky (schwidefsky@de.ibm.com)
Copyright 2001 MontaVista Software Inc. Author: Matt Porter <mporter@mvista.com>
Copyright (C) STMicroelectronics 2017 - All Rights Reserved
Copyright (c) 2003-2017 Cavium, Inc.
Copyright IBM Corp. 2007 Author(s): Michael Ernst <mernst@de.ibm.com>
Copyright © 2007 Anton Vorontsov 2004-2007 Matt Reimer 2004 Szabolcs Gyurko
Copyright (C) 2013 WindRiver
Copyright 2002,2003 Andi Kleen, SuSE Labs. Rest from unknown author(s). 2004 Andi Kleen. Rewrote most of it.
Copyright (c) 2004 Vojtech Pavlik
Copyright (C) 2018-19 Texas Instruments Incorporated - http://www.ti.com/
Copyright (C) 2005-2006 Intel Corporation
Copyright 2009 Albert Herranz <albert_herranz@yahoo.es>
Copyright (C) 2014 Sean Young <sean@mess.org>
(c) Copyright 2002, 2003, 2004 Hewlett-Packard Development Company, L.P. Khalid Aziz <khalid.aziz@hp.com>
Alex Williamson <alex.williamson@hp.com> Bjorn Helgaas <bjorn.helgaas@hp.com>
Copyright (C) 2017-2018, Intel Corporation
Copyright (c) 2007 Dave Airlie <airlied@linux.ie>
Copyright 2018, Breno Leitao, Gustavo Romero, IBM Corp.
(c) 1999, Rt-Control, Inc.
Copyright (C) STMicroelectronics 2019 - All Rights Reserved Author: Alexandre Torgue <alexandre.torgue@st.com>
Copyright (C) 2008 Guennadi Liakhovetski, DENX Software Engineering, <lg@denx.de>
Copyright (C) 2010 Philippe Rétoz
Copyright IBM Corporation 2004
"Copyright (C) 2016 Intel Corporation Authors: Sailaja Bandurupalli <sailaja.bandurupalli@intel.com> Ramesh Babu K V <ramesh.babu@intel.com> Vaibhav Agarwal <vaibhav.agarwal@intel.com> Jerome Anand <jerome.anand@intel.com>"
Copyright (C) 2005 - 2012 Cavium Inc.
Copyright (C) 2010-2014 STMicroelectronics Limited
Copyright (c) 2017, The Linux Foundation. All rights reserved.
Copyright 2018, 2019 Cisco Systems
(C) 2001 by Jay Schulist <jschlst@samba.org>;(C) 2002-2005 by Harald Welte <laforge@gnumonks.org>;(C)

LICENCE TERMS (cont.)

2005-2017 by Pablo Neira Ayuso <pablo@netfilter.org>
Copyright (C) 1998-2000, 2002 Tim Waugh <tim@cyberelk.net>
Copyright IBM Corp. 2017, 2019
Copyright 1995-1996 by Mylex Corporation All Rights Reserved
Copyright (C) 2013 Luis Alves <ljalvs@gmail.com> based on cx24116.h by Steven Toth
Copyright (c) 2000,2002-2003,2005 Silicon Graphics, Inc.
Copyright (c) 2017, Intel Corporation. Ricardo Neri <ricardo.neri-calderon@linux.intel.com>
Copyright (C) 1999 Richard Hirst <richard@sleeper.demon.co.uk>
Copyright (c) 2017 Synopsys, Inc. and/or its affiliates. stmmac Support for 5.x Ethernet QoS cores
Copyright (c) 2011, ST-Ericsson Author: Dmitry Tarnyagin <dmitry.tarnyagin@lockless.no>
Copyright IBM Corp. 2012 Author(s): Heiko Carstens <heiko.carstens@de.ibm.com>
Copyright (c) 2017 Mellanox Technologies Ltd. All rights reserved.
(c) 1997 Martin Mares <mj@atrey.karlin.mff.cuni.cz>;(c) 2000 Crutcher Dunnivant <crutcher+kernel@datastacks.com> overhauled to use key registration based upon discussions in irc://irc.openprojects.net/#kernelnewbies
Copyright (C) 2017, Intel Corporation. All rights reserved.
Copyright (C) 2013, LG Electronics, Kyungsik Lee <kyungsik.lee@lge.com>
Copyright (c) 2007 Daniel Mack <daniel@caiaq.de> Karsten Wiese <fzu@wemgehoertderstaat.de>
Copyright (C) 2005-2008 Red Hat, Inc. All rights reserved.
Copyright (C) 2007 Nokia Corporation
Copyright (C) 2001 Michael Anderson, IBM Corporation
Copyright (C) 1999 Ryan Drake <stiletto@mediaone.net>
Copyright (c) 2007 Dmitry Torokhov
Copyright © 2009 Paul Mackerras, IBM Corp. <paulus@au1.ibm.com>
Copyright (c) 2002 Hewlett-Packard Co/CERN Sverre Jarp <Sverre.Jarp@cern.ch>
Copyright (c) by Jaroslav Kysela <perex@perex.cz>, Cirrus Logic, Inc. Definitions for Cirrus Logic CS46xx chips
Copyright 2005 Lab126, Inc.
Copyright (C) 1998-2002 Paul Mackerras
Copyright 2016-2018 Advanced Micro Devices, Inc.
"Copyright 1999 Silicon Integrated System Corporation Revision: 1.08.10 Apr. 2 2006"
Copyright © 2015 Intel Corporation.
Copyright 2016-2018 Toradex AG
"Copyright (C) 2014 Texas Instruments Incorporated Authors: Sandeep Nair <sandeep_n@ti.com> Sandeep Paulraj <s-paulraj@ti.com> Cyril Chemparathy <cyril@ti.com> Santosh Shilimkar <santosh.shilimkar@ti.com> Murali Karicheri <m-karicheri2@ti.com> Wingman Kwok <w-kwok2@ti.com>"
Copyright (C) 2001-2008 Miklos Szeredi <miklos@szeredi.hu>
Copyright (C) 2014 Philippe Reynes
Copyright (c) 2013 Jiri Slaby
Copyright (c) 2014 Zhang, Keguang <keguang.zhang@gmail.com>
Copyright (C) 2018, Richtek Technology Corporation
Copyright (C) 2014 ARM Ltd. Author: Lorenzo Pieralisi <lorenzo.pieralisi@arm.com>
Copyright (C) 1995-1999 Gadi Oxman <gadio@netvision.net.il>
Copyright (c) 2014 Dialog Semiconductor
Copyright (C) 2001 David A. Hinds -- dahinds@users.sourceforge.net
Copyright (C) 2012 Jean-Francois Moine <http://moinejf.free.fr>
Copyright (c) 2016 Samsung Electronics Co., Ltd. Donghwa Lee <dh09.lee@samsung.com> Hyungwon Hwang <human.hwang@samsung.com> Hoegeun Kwon <hoegeun.kwon@samsung.com>
Copyright (C) 2010 Marvell International Ltd. Zhangfei Gao <zhangfei.gao@marvell.com> Kevin Wang <dwang4@marvell.com> Mingwei Wang <mwwang@marvell.com> Philip Rakity <prakity@marvell.com> Mark Brown <markb@marvell.com>
Copyright(C) 2009 Wolfson Microelectronics PLC.
(C) Copyright IBM Corporation 2005.
Copyright (C) 2001 Ralph Metzler for convergence integrated media GmbH
Copyright (C) 2007 Hans Verkuil
Copyright (C) 2004, 2005 MIPS Technologies, Inc. All rights reserved.
Copyright (C) 2013-2014 Alexander Shiyani <shc_work@mail.ru>
Copyright (c) 2006-2009 Red Hat Inc.
Copyright (C) 2015-2016 Josh Poimboeuf <jpoimboe@redhat.com>

Copyright (C) 2010 Google, Inc.
Copyright (c) 2015, Sony Mobile Communications AB.
Copyright (c) 2008-2014 Silicon Graphics, Inc. All Rights Reserved.
Copyright (C) 2000 John G Dorsey <john+@cs.cmu.edu>
Copyright 2009-2010 Analog Devices Inc.
Copyright (c) 2017 Cavium Inc.
Copyright 2009,2010 Jonathan Corbet <corbet@lwn.net>
Copyright (c) 2002 The Regents of the University of Michigan All Rights Reserved
(C) 2003 Dave Jones.
(c) 2003-2012 Advanced Micro Devices, Inc.:(C) 2003 Dave Jones on behalf of SuSE Labs;(C) 2004 Dominik Brodowski <linux@brodo.de>;(C) 2004 Pavel Machek <pavel@ucw.cz> Based upon datasheets & sample CPUs kindly provided by AMD.
Copyright (C) 2017 Texas Instruments, Inc.
Copyright (C) 2000, 2001, 2002, 2003 Broadcom Corporation
Copyright (C) 2017, Intel Corporation Authors: Amir Levy <amir.jer.levy@intel.com> Michael Jamet <michael.jamet@intel.com> Mika Westerberg <mika.westerberg@linux.intel.com>
Copyright (c) 2004 Michal Ludvig <michal@logix.cz>
Copyright 2017 Microsemi Corporation
Copyright (C) ST-Ericsson 2010-2012 Contact: Alexey Orishko <alexey.orishko@stericsson.com> Original author: Hans Petter Selasky <hans.petter.selasky@stericsson.com>
Copyright (C) 2007-2012 ST-Ericsson AB COH 901 571/3 - Used in DB3210 (U365 2.0) and DB3350 (U335 1.0) Author: Linus Walleij <linus.walleij@linaro.org> Author: Jonas Aberg <jonas.aberg@stericsson.com>
Copyright (C) 1997-1998 Inside Out Networks, Inc.
Copyright 1993, 1994 Drew Eckhardt Visionary Computing Unix and Linux consulting and custom programming) drew@Colorado.EDU 1 (303) 786-7975
Copyright (c) 2017 Linaro Limited. All rights reserved.
Copyright (c) 2012-2018, Intel Corporation. All rights reserved. Intel Management Engine Interface (Intel MEI) Linux driver
Copyright (c) 2004 Fetron GmbH
Copyright (c) 2019 Shenzhen Wesion Technology Co., Ltd. <https://www.khadas.com>)
Copyright (C) 2014-2018 Xilinx, Inc.
Copyright (C) 2009 Nokia
Copyright 2013-2014 Red Hat Inc.
Copyright (C) 2004-2008 Jean Delvare <jdelvare@suse.de> Based on the lm90 driver.
(C) Copyright 2016 Red Hat, Inc
Copyright 2017, Ram Pai, IBM Corporation.
Copyright (c) 2014-2015 Jiri Pirko <jiri@resnulli.us>
Copyright (C) 2001-2008 Stas Sergeev
Copyright (C) 2012-2014 LSI Corporation
Copyright (C) 2003 Bernardo Innocenti <bernie@develer.com> Based on former asm-ppc/div64.h and asm-m68knommu/div64.h
(c) 2005-2016 Advanced Micro Devices, Inc.
Copyright (C) 2006 Philipp Zabel <philipp.zabel@gmail.com>
(C) Copyright 2010 Intel Corporation
Copyright (C) 2005 Olav Kongas <ok@artecdesign.ee>
Copyright (C) 2009 STMicroelectronics
© 2005 Eptar srl Author: Claudio Lanconelli <lanconelli.claudio@eptar.com>
Copyright (C) 2013-2017 Oracle Corporation
Copyright (c) 2015 Imagination Technologies Author: Alex Smith <alex.smith@imgtec.com>
Copyright 2014 Wolfson Microelectronics plc
Copyright (C) 2015 Renesas Electronics Corporation Kuninori Morimoto <kuninori.morimoto.gx@renesas.com>
Copyright (C) 2004 Len Brown <len.brown@intel.com>
Copyright (C) 2014 Josh Poimboeuf <jpoimboe@redhat.com>
(C) Xilinx Inc.
Copyright (c) 2017 Cavium.
Copyright (c) 2017 BayLibre, SAS. Author: Jerome Brunet <jbrunet@baylibre.com>
Copyright (C) 2018 Marek Vasut <marek.vasut@gmail.com>

LICENCE TERMS (cont.)

Copyright 2007-2008 Pierre Ossman
Copyright (C) 2012 Intel Corporation Author: Liu Jinsong <jinsong.liu@intel.com> Author: Jiang Yunhong <yunhong.jiang@intel.com>
Copyright (C) 2004 by Thomas Rathbone
(C) Copyright David Gibson, IBM Corp. 2001-2003.
Copyright (C) 2003, 2004, 2007 Maciej W. Rozycki
Copyright (C) International Business Machines Corp., 2007 Author(s): Steve French (sfrench@us.ibm.com)
Copyright (C) 2016 Samsung Electronics Author: Chanwoo Choi <cw00.choi@samsung.com>
Copyright (C) 2007-2012 ST-Ericsson AB Author: Linus Walleij <linus.walleij@stericsson.com> Author: Jonas Aaberg <jonas.aaberg@stericsson.com>
Copyright IBM Corp. 2012 Author(s): Sebastian Ott <sebott@linux.vnet.ibm.com>
Copyright (c) 2001,2002 Christer Weinigel <wingel@nano-system.com>
Copyright 2010 DENX Software Engineering GmbH
Copyright 2012-2013 Analog Devices Inc. Author: Lars-Peter Clausen <lars@metafoo.de>
Copyright (c) 1998-2001 by Frank van de Pol <fvdpol@coil.demon.nl> Jaroslav Kysela <perex@perex.cz> Takashi Iwai <tiwai@suse.de>
Copyright (C) 2014 Facebook. All rights reserved.
(C) 1999-2001 Michal Ludvig <michal@logix.cz>
Copyright (c) 2008 Maciej W. Rozycki
Copyright (C) 2016-2018 Mellanox Technologies
(C) Copyright 2002-2004 Greg Kroah-Hartman <greg@kroah.com>;(C) Copyright 2002-2004 IBM Corp.:(C)
Copyright 2003 Matthew Wilcox;(C) Copyright 2003 Hewlett-Packard;(C) Copyright 2004 Jon Smirl <jonsmirl@yahoo.com>;(C) Copyright 2004 Silicon Graphics, Inc. Jesse Barnes <jbarnes@sgi.com>
Copyright (c) 2011-2013 MaxLinear, Inc. All rights reserved
Copyright (C) 2011, 2012 Cavium Inc.
(c) Copyright 2000-2001 Marek Michalkiewicz <marekm@linux.org.pl>
Copyright (C) IBM Corporation, 2002, 2004, 2009
Copyright (c) 2004-2006 Simtec Electronics Ben Dooks <ben@simtec.co.uk>
Copyright IBM Corp. 1999
Copyright (C) 2001 Holger Waechter for Convergence Integrated Media GmbH Marko Kohtala <marko.kohtala@luukku.com>
Copyright (C) 2006 Freescale - John Rigby
Copyright: (C) 2016 Protonic Holland.
Copyright (c) 2015 Zoltán Böszörményi <zboszor@pr.hu>
Copyright (C) International Business Machines Corp., 2002,2009 Author(s): Steve French (sfrench@us.ibm.com)
Copyright (C) 2016 Cadence Design Systems - <https://www.cadence.com/>
Copyright (C) 2019 Christian Hewitt <christianshewitt@gmail.com>
Copyright (C) 1999, 2000 Ralf Baechle (ralf@gnu.org)
Copyright (c) 2003-2016, Intel Corporation.
(c) Copyright 2001 Charles Howes <chowes@vsol.net>
(C) 2002 by Harald Welte <laforge@netfilter.org>;(C) 2000 by Matthew G. Marsh <mgm@paktronix.com>
Copyright (C) Original authors of ../asm-i386/checksum.h
Copyright 1999, 2000 Precision Insight, Inc., Cedar Park, Texas.
Copyright (C) 2014 STMicroelectronics —All Rights Reserved
Copyright (C) 2016 SiFive
Copyright (C) 1997 Free Software Foundation, Inc. This file is part of the GNU C Library.
Copyright (C) 2005 Mips Technologies Author: Chris Dearman, chris@mips.com derived from fpu.h
Copyright (c) 2008 Isaku Yamahata <yamahata at valinux co jp> VA Linux Systems Japan K.K.
Copyright (c) 2016 Sławomir Stepień
Copyright (C) 2006 Chris Dearman (chris@mips.com),
Copyright: |copy| 2016, Intel Corporation
Copyright (C) 2011 Rafael J. Wysocki <rjw@sisk.pl>, Novell Inc.
Copyright (C) 2005 Nathan Lynch
Copyright 2014 Bart Tanghe <bart.tanghe@thomasmore.be>
Copyright (C) 2009, Guennadi Liakhovetski <g.liakhovetski@gmx.de>
Copyright (c) 1999-2013 Petko Manolov (petkan@nucleusys.com)
Copyright (C) 1999-2000 Maxim Krasnyansky <max_mk@yahoo.com>

Copyright (C) 2004 Thomas Gleixner (tglx@linutronix.de)
Copyright (C) ST-Ericsson SA 2010 Author: Mattias Nilsson <matias.i.nilsson@stericsson.com> for ST Ericsson.
Copyright © 2007 David Airlie
Copyright IBM Corp. 2007,2020 Author(s): Gerald Schaefer <gerald.schaefer@de.ibm.com>
Copyright (C) 2002 Trond Myklebust
Copyright (C) 2006, 2008 David S. Miller <davem@davemloft.net>
Copyright 2004-2005 Simtec Electronics Ben Dooks <ben@simtec.co.uk>
Copyright (C) 2013-2015, Microchip Technology Germany II GmbH & Co. KG
Copyright (C) 2008 Mistral Solutions
Copyright 2018 DEVIALET
Copyright (C) 2007 Marvell International Ltd. 2007-08-21: eric miao <eric.miao@marvell.com> initial version
Copyright (c) 2015 Andrew Lutomirski
(C) using ARM CRC, NEON and Crypto Extensions instructions
Copyright (C) 2008 Nokia Corporation;(C) Texas Instruments.
Copyright (C) 1992,1993,1995,1997 | W. Metzenthien, 22 Parker St, Ormond, Vic 3163, Australia | E-mail billm@suburbia.net |
Copyright (c) 2004 Arnaud Patard <arnaud.patard@rtp-net.org>
Copyright (C) 2014 PHYTEC Messtechnik GmbH Author: Wadim Egorov <w.egorov@phytec.de>
Copyright IBM Corp. 2005, 2012 Author(s): Michael Holzheu <holzheu@de.ibm.com> Heiko Carstens <heiko.carstens@de.ibm.com> Volker Sameske <sameske@de.ibm.com>
Copyright (c) 2003 Silicon Graphics, Inc. All rights reserved.
Copyright (C) STMicroelectronics SA 2014 Authors: Vincent Abriou <vincent.abriou@st.com> Fabien Dessenne <fabien.dessenne@st.com> for STMicroelectronics.
Copyright (c) 2007 Takashi Iwai <tiwai@suse.de>
"(c) Copyright 1995 CymruNET Ltd Innovation Centre Singleton Park Swansea Wales UK SA2 8PP"
(C) Copyright 2005, Intec Automation (mike@steroidmicros.com)
Copyright IBM Corporation, 2001
Copyright 2014-2015 Solarflare Communications Inc.
Copyright 2016 Red Hat, Inc. and/or its affiliates.
Copyright (c) 2016 Red Hat Inc.
Copyright © 2005 Samsung Electronics Kyungmin Park <kyungmin.park@samsung.com>
(C) 2001-2002 Björn Stenberg (bjorn@haxx.se);(C) 2002 Alan Stern <stern@rowland.org>;(C) 2000 In-System Design, Inc. (support@in-system.com)
Copyright (C) 2016 Chen-Yu Tsai
Copyright (C) 2016-2018 Linaro, Ltd. <ard.biesheuvel@linaro.org>
Copyright (C) 2012 Marvell Technology Group Ltd. Author: Haojian Zhuang <haojian.zhuang@marvell.com>
Copyright (C) 2014-2015 ARM Limited
Copyright (C) 2008 Red Hat, Inc. All Rights Reserved. Written by David Howells (dhowells@redhat.com)
Copyright (C) 2012 Texas Instruments Inc.
Copyright (c) 2000-2007 PMC-Sierra INC.
Copyright (C) 2010 Renesas Electronics Corporation
Copyright (C) 2010 Samsung Electronics MyungJoo Ham <myungjoo.ham@samsung.com>
Copyright (C) 2001 Alessandro Rubini and Jonathan Corbet
Copyright 2008 Ben Gamari <bgamari@gmail.com>
Copyright (c) 2010 Samsung Electronics Co., Ltd. <http://www.samsung.com>
Copyright 2006-2013 Solarflare Communications Inc.
Copyright (c) Siemens AG, 2011-2013
Copyright(c) 2015 - 2017 Intel Corporation.
Copyright 2018 IBM Corporation
Copyright (C) 2007-2014 STMicroelectronics Ltd
Copyright (C) 2018 Linaro Ltd.
Copyright (C) 2017 BayLibre SAS
(C) 2005 Red Hat <alan@lxorguk.ukuu.org.uk>
Copyright (c) 1995, 1996 Daniel M. Eischen All rights reserved.
Copyright (C) 2007 Texas Instruments.
Copyright (C) 2017 Linaro, Ltd., Rob Herring <robh@kernel.org>
Copyright (C) IBM Corporation, 2006

LICENCE TERMS (cont.)

Copyright (C) 2014-2015 Freescale Semiconductor, Inc. All Rights Reserved.
Copyright (C) 2014 NXP Semiconductors All rights reserved.
Copyright (C) 2016-2017 Linaro Ltd., Rob Herring <robh@kernel.org>
Copyright (c) 2000-2001,2005 Silicon Graphics, Inc.
Copyright (C) 2010 Wolfram Sang, Pengutronix e.K. <w.sang@pengutronix.de>
Copyright (C) 2010,2011 Freescale Semiconductor Inc.
Copyright (C) 2003 Joerg Dorchain <joerg AT dorchain.net>
Copyright (C) 1998 Pauline Middelink <middelink@polyware.nl>
Copyright (C) 2009 Motorola, Inc.
Copyright 2012 Dialog Semiconductors Ltd.
Copyright (C) 2007, 2008 Wolfson Microelectronics PLC.
Copyright (C) 2017 Cadence Design Systems Inc.
Copyright (C) 2004 THE PACKAGE'S COPYRIGHT HOLDER
Copyright 2003 Benjamin Herrenschmidt <benh@kernel.crashing.org>
© Copyright 1995-2003 by Geert Uytterhoeven (geert@linux-m68k.org) Peter De Schrijver (p2@mind.be)
Copyright (C) 2004-2008 Yoichi Yuasa <yuasa@linux-mips.org>
Copyright (c) 2010-2011 by Samsung Electronics. Written by: Marek Szymowski <m.szymowski@samsung.com>
Michal Nazarewicz <mina86@mina86.com>
Copyright (c) 2010 CompuLab Ltd Author: Denis Turishev <denis@compulab.co.il>
Copyright (c) 2012 Freescale Semiconductor, Inc All rights reserved.
Copyright (C) 2018 Amarula Solutions Author: Jagan Teki <jagan@amarulasolutions.com>
Copyright (C) 2002-2014 MEV Ltd. <http://www.mev.co.uk/>
Copyright (C) 2012 David S. Miller (davem@davemloft.net)
Copyright (C) 1992 Krishna Balasubramanian
Copyright (c) 2004-2006, 2014-2017, Ericsson AB
Copyright (C) 2019 Google, Inc. modified from kernel/gcov/gcc_4_7.c
Copyright (C) 2006 by OpenMoko, Inc. Author: Harald Welte <laforge@openmoko.org> All rights reserved.
Copyright (C) 2016,2017 Advanced Micro Devices, Inc.
Copyright (C) 2009-2010 NXP Semiconductors
Copyright (C) 2005 Faraday Corp.
Copyright (C) 2006-2009 DENX Software Engineering.
Copyright (C) 2011 Sony Ericsson Mobile Communications Inc.
Copyright (c) International Business Machines Corp., 2002, 2011 Etersoft, 2012 Author(s): Steve French (sfrench@us.ibm.com) Pavel Shilovsky (pshilovsky@samba.org) 2012
Copyright (C) 2007 Secret Lab Technologies Ltd.
Copyright (C) 2013 Inktank Storage, Inc.
(C) 2004 Margit Schubert-White <margitw@t-online.de>
Copyright 2018 Socionext Inc. Author: Kunihiko Hayashi <hayashi.kunihiko@socionext.com>
(c) 2005 Hartmut Hackmann;(c) 2007 Michael Krufky
Copyright 2008 Freescale Semiconductor Inc.
Copyright (C) 2014 Varka Bhadram <varkab@cdac.in> Md.Jamal Mohiuddin <mjmohiuddin@cdac.in> P Sowjanya <sowjanya@cdac.in>
Copyright (C) 2005 Craig Shelley (craig@microtron.org.uk)
Copyright (c) 2015 6WIND S.A. Author: Nicolas Dichtel <nicolas.dichtel@6wind.com>
Copyright (C) 2019 Linus Walleij <linus.walleij@linaro.org>
Copyright (C) 2017-2018 MediaTek Inc. Author: Sean Wang <sean.wang@mediatek.com>
Copyright(c) 2017 Intel Corporation. All rights reserved.
Copyright (c) 2016-2018, NVIDIA CORPORATION. All rights reserved.
Copyright (c) 2019 MediaTek Inc. Author: Long Cheng <long.cheng@mediatek.com>
Copyright (C) 2011 Samsung Electronics Co., Ltd. http://www.samsung.com/
Copyright (C) 2009 Canonical Ltd. <jeremy.kerr@canonical.com>
Copyright (C) 2003 Red Hat, Inc. All Rights Reserved. Written by David Howells (dhowells@redhat.com)
Copyright 2008 Simtec Electronics Ben Dooks <ben@simtec.co.uk> http://armlinux.simtec.co.uk/
Copyright (C) 2017 Samsung Electronics
Copyright (c) 2008 Nissin Systems Co., Ltd., Yoshio Kashiwagi
Copyright (C) 2007-2009 Texas Instruments, Inc.
Copyright (C) 2018 Uladzislau Rezki (Sony) <urezki@gmail.com>

Copyright (c) 2015 Denys Vlasenko
Copyright (C) 2011, Intel Corporation Author: Mika Westerberg <mika.westerberg@linux.intel.com>
Copyright 2017 Texas Instruments
Copyright (C) 2007-2008 HTC Corporation.
Copyright (c) 2007-2016, Synaptics Incorporated
Copyright (C) 2005-2006 Andrey Volkov <avolkov@varma-el.com>, Varma Electronics Oy
(C) Copyright 2017 Intel Corporation
Copyright (C) 2017 Marvell Technology Group Ltd.
Copyright (C) 2004-6 Patrick Boettcher <patrick.boettcher@posteo.de>
(c) 2006-2008 MSC Vertriebsges.m.b.H., Manuel Lauss <mano@roarinelk.homelinux.net>;(c) 2008 Nobuhiro Iwamatsu <iwamatsu.nobuhiro@renesas.com>
(C) Copyright 2007, Greg Ungerer <gerg@snapgear.com>
Copyright (C) 2016 NextThing Co
Copyright (C) 2007-2008 Marvell Ltd.
Copyright 2001 MontaVista Software Inc.
Copyright 2014 Peter Meerwald <pmeerw@pmeerw.net>
"Copyright: (C) 2002 Rory Bolt"
Copyright 1995, 1996, 1998, 1999, 2000, 2003 Free Software Foundation, Inc.
Copyright (C) 2019 Luca Weiss <luca@z3ntu.xyz>
(C) Copyright 2005 Robert Love
Copyright (C) 2001 Andrea Arcangeli <andrea@suse.de> SuSE
Copyright 2001,2003 Jeff Garzik <jgarzik@pobox.com>
Copyright (c) 2018 Amlogic, Inc. All rights reserved. Author: Xingyu Chen <xingyu.chen@amlogic.com>
Copyright (C) 2018 Chengdu Haiguang IC Design Co., Ltd.
Copyright (C) 2006 Juergen Beisert, Pengutronix
(C) Copyright 1996, 97, 99, 2002, 03 Ralf Baechle;(C) Copyright 1999 Silicon Graphics, Inc.
Copyright 2012 Steffen Trumtrar <s.trumtrar@pengutronix.de>
Copyright (C) STMicroelectronics 2019. YAML 1.2
Copyright (c) 1997, 1998, 2000, 2001 Justin T. Gibbs.
Copyright 1998-2003 VIA Technologies, Inc. All Rights Reserved.
Copyright (C) 2011-2012 Texas Instruments Incorporated - http://www.ti.com/ Vaibhav Hiremath <hvaibhav@ti.com>
Copyright (C) 2002 Steve Underwood
Copyright (C) 2015-2016 Texas Instruments Incorporated - http://www.ti.com/ Tero Kristo <t-kristo@ti.com>
Copyright (C) 2015 Linaro Ltd.
Copyright (c) 2007-2009 VMware, Inc., Palo Alto, CA., USA All Rights Reserved.
Copyright (C) 2016-2019 Microchip Technology, Inc.
Copyright (C) 2005-2007 Cavium Networks
Copyright 2010, 2011 Texas Instruments Incorporated
Copyright (C) 2007-2008 Marvell Internation Ltd.
Copyright (c) 2011 Marvell Semiconductors Inc.
Copyright (c) 2012 Dmitry Eremin-Solenikov
Copyright (C) 2010-2012 by Bruno Prémont <bonbons@linux-vserver.org>
Copyright(c) 2013 - 2018 Intel Corporation.
Copyright(c) 2007, RealTEK Technology Inc. All Right Reserved.
Copyright (C) 2013 VTL Corporation
Copyright (C) 2008-2014 Altera Corporation. All rights reserved
Copyright (C) 2020 NXP
Copyright IBM Corp. 2007,2012
Copyright (C) 2012-2016 Freescale Semiconductor, Inc. All Rights Reserved.
Copyright IBM Corp. 2004, 2010 Interface implementation for communication with the z/VM control program
Copyright (C) 2010 Stefani Seibold <stefani@seibold.net>
Copyright (C) 2002,2004 Yoichi Yuasa <yuasa@linux-mips.org>
Copyright (C) 2012 Intel Corporation Author: H. Peter Anvin <hpa@linux.intel.com>
Copyright (C) 1995, 2007 David S. Miller (davem@davemloft.net)
Copyright (C) 2017 - 2018 Bosch Sensortec GmbH
Copyright (C) 2018 Pengutronix, Sascha Hauer <s.hauer@pengutronix.de>
Copyright (C) 1993 Greg Harp Atari Support by Bjoern Brauel, Roman Hodek

LICENCE TERMS (cont.)

Copyright 2014 Sukadev Bhattiprolu, IBM Corporation.
(c) 2002 Simon Munton
(C) 2009 - Peter Feuerer peter
Copyright 2014 Michal Sojka <sojka@merica.cz>
(C) Copyright 1995 1996 Linus Torvalds;(C) Copyright 2012 Regents of the University of California
(C) 2011 DENX Software Engineering, Anatolij Gustschin <agust@denx.de>
Copyright (c) 2006-2008 Intel Corporation
Copyright (C) 2014 Jason Baron <jbaron@akamai.com>
Copyright 2017 Tim Harvey <tharvey@gateworks.com>
Copyright (C) 2012 Jonas Gorski <jonas.gorski@gmail.com>
Copyright (C) 2009 Texas Instruments Inc
Copyright (c) 2012 Samsung Electronics Co., Ltd http://www.samsung.com
Copyright (C) 2001, 2002 Sistiina Software
Copyright (C) 2004 Andrew de Quincey
Copyright (c) 2015 MediaTek Inc. Author: Erin Lo <erin.lo@mediatek.com>
Copyright (C) 1999 Tetsuya Okada & Niibe Yutaka
Copyright (c) 2015 Chelsio Communications, Inc. All rights reserved.
Copyright (C) 2015 Martin Willi
Copyright (c) 2009 Samsung Electronics Co.Ltd Author: Joonyoung Shim <jy0922.shim@samsung.com>
(C) Copyright 1995 1996 Linus Torvalds;(C) Copyright 2001-2019 Helge Deller <deller@gmx.de>;(C) Copyright 2005
Kyle McMartin <kyle@parisc-linux.org>
(C) 2017 Helge Deller <deller@gmx.de>
Copyright (C) 2017 Ahmet Inan <inan@distec.de>
Copyright (C) 2007-2013 Bruce Chang (Mediatek)
Copyright (C) 2006 Texas Instruments. Original author: Purushotam Kumar
Copyright 2013-2014 Freescale Semiconductor Inc.
Copyright 2002 SYSGO Real-Time Solutions GmbH
Copyright (C) 1996, 1998 by Ralf Baechle
Copyright IBM Corp. 2007, 2012 Author(s): Peter Oberparleiter <peter.oberparleiter@de.ibm.com>
Copyright (C) 2019 Red Hat, Inc.
Copyright (c) 2019 Rockchip Electronics Co. Ltd. Author: Finley Xiao <finley.xiao@rock-chips.com>
Copyright © 2006-2015, Intel Corporation.
Copyright (c) 2013, Applied Micro Circuits Corporation Author: Feng Kan <fkan@apm.com> Author: Loc Ho <lho@apm.com>
Copyright 2006, 2008 Freescale Semiconductor Inc. 2006 Roy Zang <Roy Zang at freescale.com>.
Copyright (C) 2008 Alan Stern
Copyright (c) 2019 Microchip Technology Inc. and its subsidiaries
Copyright (C) 2013 Peter Chen
Copyright (C) 2011 Samsung Electronics Co.Ltd Authors: Joonyoung Shim <jy0922.shim@samsung.com> Inki Dae <inki.dae@samsung.com>
Copyright (c) by Jaroslav Kysela <perex@perex.cz> Creative Labs, Inc. Routines for control of EMU10K1 chips / PCM routines
Copyright 2014 Freescale Semiconductor, Inc.
Copyright (C) 2010, Philippe De Muyter <phdm@macqel.be>
Copyright (c) 2009 - 2010, Intel Corporation and its suppliers.
Copyright (c) 2005, Keir Fraser <keir@xensource.com>
Copyright (C) 2004, 2012 Texas Instruments, Inc.
Copyright (c) 2013, Intel Corporation
Copyright (C) 1999-2001 Naval Research Laboratory
Copyright (C) 2001 David A. Schleaf <ds@schleaf.org>
Copyright (C) 1997 by Digital Equipment Corporation, Maynard, Massachusetts. All rights reserved.
Copyright 2006-2007 Intel Corporation
Copyright (C) STMicroelectronics 2017 Author: Amelie Delaunay <amelie.delaunay@st.com>
Copyright (c) 2007 MontaVista Software, Inc.
Copyright (c) 2001, 2002 M. R. Brown <mrbrown@0xd6.org>
Copyright (C) 1999 Alpha Processor, Inc., David Daniel, Stig Telfer, Soohoon Lee)
Copyright (C) 2009 Renesas Solutions Corp. Kuninori Morimoto <morimoto.kuninori@renesas.com>

Copyright (c) 2002-2003 Patrick Mochel
Copyright (c) 2012 The Chromium OS Authors <chromium-os-dev@chromium.org> Author: Will Drewry <wad@chromium.org>
Copyright (C) 2007 Mattia Dongili <malattia@linux.it>
Copyright (C) 2016 Stefan Wahren <stefan.wahren@i2se.com>
Copyright 2003 Vivien Chappelier <vivien.chappelier@linux-mips.org>
(C) Copyright David Gibson <dwg@au1.ibm.com>, IBM Corporation. 2007.
Copyright 2009-2010 Integrated Device Technology, Inc. Alexandre Bounine <alexandre.bounine@idt.com>
Copyright (C) 2013 Newflow Ltd - http://www.newflow.co.uk/
Copyright: [copy] 2016 Intel Corporation
Copyright (C) 2013 Texas Instruments Inc. Murali Karicheri <m-karicheri2@ti.com> Santosh Shilimkar <santosh.shilimkar@ti.com>
Copyright (C) 2018 Synaptics Incorporated
Copyright (C) 1995 Linus Torvalds;(c) 1995-2002 Russell King
Copyright (c) 2019, Mellanox Technologies LTD.
Copyright (C) 2002 Tobias Hoffmann
Copyright (c) 2010-2015, The Linux Foundation. All rights reserved.
Copyright IBM Corp. 2000, 2009 Author(s): Utz Bacher <utz.bacher@de.ibm.com> Cornelia Huck <cornelia.huck@de.ibm.com> Jan Glauber <jang@linux.vnet.ibm.com>
"Copyright (C) 2007 Brian Murphy <brian@murphy.dk>"
Copyright 2008 Ben Herrenschmidt <benh@kernel.crashing.org> IBM Corp.
(C) Copyright 2005 Benjamin Herrenschmidt <benh@kernel.crashing.org>;(C) Copyright 2007 Paulo R. Zanoni <przanoni@gmail.com>;(C) Copyright 2007, 2009 Tiago Vignatti <vignatti@freedesktop.org>
Copyright 2006-2007 Advanced Micro Devices, Inc.
Copyright (C) 2004 Li Shaohua <shaohua.li@intel.com>
Copyright (c) 2007-2010 VMware, Inc., Palo Alto, CA., USA All Rights Reserved.
Copyright 2008-2010 Freescale Semiconductor, Inc.
Copyright (c) 2004,2005 Patrick McHardy, <kaber@trash.net>
Copyright (c) Vasily Khoruzhick Based on h1940_battery.c by Arnaud Patard
Copyright (c) 2009-2011, Intel Corporation. All Rights Reserved.
Copyright (C) 2016 Milo Kim <woogyom.kim@gmail.com>
Copyright 2016 IBM Corporation
(C) 2007 SoftwareBitMaker
Copyright (C) 2007 Rudolf Marek <r.marek@assembler.cz>
Copyright (C) 2014 Jonas Jensen
Copyright (C) 2011 Samsung Electronics Co., Ltd. http://www.samsung.com/ Kamil Debski, <k.debski@samsung.com>
Copyright (C) 1995, 1996, 1997, 1999, 2001 by Ralf Baechle
Copyright (c) 1998-2000 Andre Hedrick <andre@linux-ide.org>
Copyright (c) 1998-2000 Ilario Nardinocchi (nardinoc@CS.UniBO.IT)
Copyright (c) 2015 ROCKCHIP, Co. Ltd.
Copyright (c) 2011 ARM Ltd. Written by Will Deacon <will.deacon@arm.com>
Copyright (c) 2001-2004 Anton Altaparmakov
Copyright (C) 2013 Carlo Caione <carlo@caione.org>
Copyright 2010-2011 Calxeda, Inc.
Copyright (C) 2007 OpenVZ http://openvz.org, SWsoft Inc
Copyright 2005-2016 Freescale Semiconductor, Inc. All Rights Reserved.
Copyright (C) 2010 Texas Instruments Incorporated Contributed by Mark Salter <msalter@redhat.com>.
Copyright IBM Corporation, 2006-2007
Copyright (c) 2004-2009 Silicon Graphics, Inc. All Rights Reserved.
Copyright (c) 2006 Matt Callow
Copyright (C) IBM Corporation 2016
Copyright (C) 1998 Harald Koerfgen, Frieder Streffer and Paul M. Antoine
Copyright (C) 2004 Microtronix Datacom Ltd.
Copyright (C) 2012 - Virtual Open Systems and Columbia University Authors: Christoffer Dall <c.dall@virtualopensystems.com>
Copyright (C) 2003-2005 MontaVista Software, Inc.

LICENCE TERMS (cont.)

Copyright (C) 2015 Jakub Kicinski <kubakici@wp.pl>
Copyright (c) 2009 Hans de Goede <hdegoede@redhat.com>
Copyright (C) 2017 Renesas Electronics Corporation
Copyright (C) 2015 Samsung Electronics Co.Ltd Authors: Joonyoung Shim <jy0922.shim@samsung.com>
Hyungwon Hwang <human.hwang@samsung.com>
Copyright © 2005-2009 Samsung Electronics
Copyright (c) 2016 Free Electrons NextThing Co. Quentin Schulz <quentin.schulz@free-electrons.com>
Copyright 2009 Simtec Electronics
Copyright (c) 2013, 2016-2017 The Linux Foundation. All rights reserved.
Copyright 2002-2009 OProfile authors remark Read the file COPYING
Copyright(C) 2016 Linaro Limited. All rights reserved. Author: Mathieu Poirier <mathieu.poirier@linaro.org>
Copyright 2015 Yoshinori Sato <ysato@users.sourceforge.jp>
Copyright (C) 2012-2013 MundoReader S.L. Author: Heiko Stuebner <heiko@sntech.de>
Copyright 2011, Integrated Device Technology, Inc.
Copyright (C) 1998, 1999, 2000 by Ralf Baechle
Copyright (C) 2008, 2011 David S. Miller <davem@davemloft.net>
(C) 2013 Astaro GmbH & Co KG
Copyright 2004 Ben Dooks, Simtec Electronics
Copyright (C) 2006-2012 HighPoint Technologies, Inc. All Rights Reserved.
Copyright 1998, Michael Schmitz <mschmitz@lbl.gov>
Copyright (C) 2008, Jaya Kumar
(C) Copyright 1999 Roman Weissgaerber <weissg@vienna.at>;(C) Copyright 2000-2002 David Brownell <dbrownell@users.sourceforge.net>;(C) Copyright 2002 Hewlett-Packard Company
Copyright (c) 2009, Christoph Hellwig All Rights Reserved.
Copyright (C) 1997 Sigurdur Asgeirsson With additional hacking by Jeffrey Kuskin (jsk@mojave.stanford.edu)
Modified by Danilo Beuche 1998 Some register values added by Damien Doligez, INRIA Rocquencourt Various cleanups by Paul Mundt (lethal@chaoticdreams.org)
Copyright IBM Corporation, 2018 Author(s): Nayna Jain <nayna@linux.ibm.com>
Copyright (C) 1997 Richard Hirst [richard@sleepie.demon.co.uk]
Copyright (c) 2003 Dave Engebretsen Will Schmidt willschm@us.ibm.com
Copyright (C) 1996 Paul Mackerras (Paul.Mackerras@cs.anu.edu.au)
Copyright (C) 2014 Texas Instruments, Inc Tero Kristo (t-kristo@ti.com)
Copyright (C) 2018 John Crispin <john@phrozen.org>
Copyright (C) 2012 Texas Instruments Ltd Author: Archit Taneja <archit@ti.com>
Copyright (c) 2011, Sagrad Inc. Author: Solomon Peachy <speachy@sagrad.com>
Copyright (C) 2012 FUJITSU SEMICONDUCTOR LIMITED
Copyright (C) 2002 SOMA Networks, Inc.
Copyright (c) 2005 Silicon Graphics, Inc. All Rights Reserved.
Copyright (C) M'bomba Cedric Madianga 2015 Author: M'bomba Cedric Madianga <cedric.madianga@gmail.com>
Pierre-Yves Mordret <pierre-yves.mordret@st.com>
Copyright (C) 2002 Peter Bergner <bergner@vnet.ibm.com>, IBM
Copyright (C) 2014 STMicroelectronics
Copyright (c) 2004, 2005 Intel Corporation. All rights reserved.
Copyright © 2012-2013 Jussi Kivilinna <jussi.kivilinna@mbnet.fi>
Copyright 2018-2019 NXP Richard Zhu <hongxing.zhu@nxp.com>
Copyright (c) 2012 Freescale Semiconductor, Inc. All rights reserved.
Copyright © 1997-2003 by The XFree86 Project, Inc.
Copyright (C) 1999, 2000, 2004 David S. Miller (davem@redhat.com)
Copyright (C) 2014 Red Hat Author: Rob Clark <robdclark@gmail.com> Author: Vinay Simha <vinaysimha@inforcecomputing.com>
Copyright (c) 2011 Peter Korsgaard <jacmet@sunsite.dk>
Copyright IBM Corp. 1999 Author(s): Martin Schwidefsky <schwidefsky@de.ibm.com> Martin Peschke <peschke@fh-brandenburg.de>
Copyright (C) 1995
Copyright (C) 2008 IBM Corporation Author: Mimi Zohar <zohar@us.ibm.com>
Copyright (C) 1996-1997 Paul H. Hargrove
Copyright (C) 2015 Antti Palosaari <crope@iki.fi>

Copyright (c) 2015-2020, VeriSilicon Inc.
Copyright (C) 2002 Anton Blanchard, IBM Corp.
Copyright (C) 2013 Christian Vogelgsang Based on adafruit22fb.c by Noralf Tronnes
Copyright 2016 Google, Inc
Copyright(c) 2014 - 2019 aQuantia Corporation.
Copyright (C) International Business Machines Corp., 2002
Copyright (C) 2012 Daniel Schwierzeck <daniel.schwierzeck@googlemail.com>
Copyright (C) 2012 Marvell Technology Group Ltd. Authors: Zhou Zhu <zzhu3@marvell.com>
Copyright (C) 2015, Michael Lee <igvtee@gmail.com> MTK HSDMA support
Copyright (c) 2015 Clement Vuchener
Copyright (C) 2007 Panasas Inc. [year of first publication] All rights reserved.
Copyright (c) 2016 Quentin Schulz <quentin.schulz@free-electrons.com>
Copyright (C) 2010 Mauro Carvalho Chehab
Copyright (C) 2005-2008 KeyStream Corp.
Copyright (C) 2007 Texas Instruments, Inc. Rajendra Nayak <rnyak@ti.com> Lesly A M <x0080970@ti.com>
Copyright (C) Paul Mackerras 2005. All Rights Reserved.
Copyright 2006 IBM Corporation.
Copyright (C) 2000 VA Linux Co
Copyright (C) 2012 Marek Vasut <marex@denx.de>
Copyright (C) 2015, 2019 International Business Machines Inc.
Copyright (C) 2007-2008 Krzysztof Halasa <khc@pm.waw.pl>
Copyright 2010 Maurus Cuelenaere <mcuelenaere@gmail.com>
Copyright © 2006 Jaya Kumar <jayakumar.lkml@gmail.com>
Copyright (C) 2017 Samsung Electronics Co., Ltd. Jaehoon Chung <jh80.chung@samsung.com>
Copyright (c) 2006-2007 Simtec Electronics http://armlinux.simtec.co.uk/ Ben Dooks <ben@simtec.co.uk>
Copyright (c) 2005, 2007, 2008 Ian Molton
Copyright (C) 2012, Red Hat, Inc. Rafael Aquini <aquini@redhat.com>
Copyright 2015 Realtek Semiconductor Corp. Author: Bard Liao <bardliao@realtek.com>
Copyright (C) 2017 - 2018 Intel Corporation
Copyright (c) 2006-2009, Intel Corporation
Copyright (c) 2017, Ericsson AB All rights reserved.
Copyright (C) 2008, Christian Pellegrin <chripell@evolware.org>
Copyright (C) 2014 Kevin Cernekee <cernekee@gmail.com>
Copyright (c) 1999 by Jaroslav Kysela <perex@perex.cz>
Copyright (C) 2017,2018 Microchip Technology, Author: Eugen Hristev <eugen.hristev@microchip.com>
Copyright (C) 2007 Trent Piepho <xyzyzy@speakeasy.org>
"Copyright 2004 AMD Author: AMD"
Copyright (C) 2016 Samsung Electronics Co.Ltd Authors: Marek Szyprowski <m.szyprowski@samsung.com>
Copyright (C) 2013 Texas Instruments. Murali Karicheri <m-karicheri2@ti.com> Santosh Shilimkar <santosh.shilimkar@ti.com>
Copyright (C) 2000, 2002-2003 Hewlett-Packard Co David Mosberger-Tang <davidm@hpl.hp.com>
Copyright (C) 2004-2007 Greg Kroah-Hartman <greg@kroah.com>
Copyright (C) 2011-2013 ASIX
Copyright (c) 2006, 2007 Cisco Systems, Inc. All rights reserved.
Copyright (C) 2002, 2003, 06, 07 Ralf Baechle (ralf@linux-mips.org)
Copyright (C) 2005 - 2016 Broadcom All rights reserved.
Copyright 2011 Wolfson Microelectronics PLC.
Copyright (C) 2019 Arrikto, Inc. All Rights Reserved.
Copyright (c) by Jaroslav Kysela <perex@perex.cz> Definitions for CS4231 & InterWave chips & compatible chips
Copyright (c) 2018 Rockchip, Inc.
Copyright (C) 2012 Texas Instruments Author: Jon Hunter <jon-hunter@ti.com>
Copyright (c) 2010 Jiri Pirkko <jpirko@redhat.com>
Copyright (C) 2015 Masahiro Yamada <yamada.masahiro@socionext.com>
Copyright (C) 2015, 2017-2018 Author: Matt Ranostay <matt.ranostay@konsulko.com>
Copyright (C)2006-2007 USAGI/WIDE Project
Copyright (C) 2000 RidgeRun, Inc. Author: RidgeRun, Inc. Greg Lonnon glonnon@ridgerun.com or info@ridgerun.com

LICENCE TERMS (cont.)

Copyright (c) 2018, Linaro Ltd
Copyright (C) 2007,2008 Oracle. All rights reserved.
Copyright (c) 2017 Fuzhou Rockchip Electronics Co., Ltd.
Copyright 2001 - 2004 Tensilica Inc.
Copyright (C) 2005-2007 Jiri Slaby <jirislaby@gmail.com>
Copyright 2009-2012 Freescale Semiconductor Inc.
Copyright (c) by Jaroslav Kysela <perex@perex.cz> Routines for control of ESS ES1688/688/488 chip
Copyright (C) 2014-2015, Intel Corporation. All rights reserved.
Copyright (C) 2012-2015 Broadcom Corporation
Copyright(c) 2014 H Hartley Sweeten <hsweeten@visionengravers.com>
Copyright (C) 2015 Samsung Electronics Author: Chanwoo Choi <cw00.choi@samsung.com>
COPYRIGHT (c) 2008 The Regents of the University of Michigan ALL RIGHTS RESERVED
Copyright (C) 2005, 2006 Maciej W. Rozycki
(C) 2012 Sasha Levin <levinsasha928@gmail.com>
COPYRIGHT | IEC958_AES0_CON_EMPHASIS_NONE; cs[1] = IEC958_AES1_CON_GENERAL; cs[2] = IEC958_AES2_CON_SOURCE_UNSPEC | IEC958_AES2_CON_CHANNEL_UNSPEC; cs[3] = IEC958_AES3_CON_CLOCK_1000PPM | fs;
(c) 2003,04 Gerd Knorr <kxaxel@bytesex.org> [SUSE Labs]
Copyright (c) 2001,2002 Patrick Mochel
Copyright (c) 2009 RidgeRun (todd.fischer@ridgerun.com)
Copyright (C) 2018 Tony Lindgren <tony@atomide.com>
(C) Copyright 1997 Thomas Schoebel-Theuer, with heavy changes by Linus Torvalds
Copyright (C) 2010 Will Deacon, ARM Ltd.
Copyright (C) 2009-2015 Anton Blanchard, IBM
Copyright (C) 2001 Todd Inglett, IBM Corporation
Copyright (C) 2010 Freescale Semiconductor, Inc. All Rights Reserved.
Copyright (C) 2009 Yinghai Lu
Copyright (C) 2010 Ryan Mallon
Copyright 2000, 2007-2008 MontaVista Software Inc. Author: MontaVista Software, Inc. <source@mvista.com>
Copyright (C) 2009 Texas Instruments
Copyright (C) 2016 Laurent Pinchart
Copyright (c) 2016 Linaro Ltd.
Copyright (C) 2017 Spreadtrum Communications Inc.
Copyright (C) 2015 Linaro Ltd <ard.biesheuvel@linaro.org>
Copyright (C) 2011 Alexander Stein <alexander.stein@systec-electronic.com>
Copyright (c) 2003 Hans-Frieder Vogt <hfvogt@arcor.de>, Based on SMBus 2.0 driver for AMD-8111 IO-Hub
Copyright (C) 2007, CenoSYS (www.cenosys.com).
Copyright (C) 2018 Oleksij Rempel <linux@rempel-privat.de>
Copyright IBM Corp. 2004 All Rights Reserved.
Copyright (C)2003,2004 USAGI/WIDE Project
Copyright (C) 2006-2011 Hermann Kneissel herkne@gmx.de
Copyright (C) 2010-2011 Canonical Ltd <jeremy.kerr@canonical.com>
Copyright (C) 2010,2015 Broadcom
Copyright (c) 2019 Paul Cercueil <paul@crapouillou.net>
Copyright (c) 2010-2011 EIA Electronics, Pieter Beyens <pieter.beyens@eia.be>
Copyright (c) 2017-2018 Broadcom Limited
Copyright (C) 2008-2014, VMware, Inc. All Rights Reserved.
Copyright © 2009-2015 VMware, Inc., Palo Alto, CA., USA All Rights Reserved.
Copyright © 2007-2008 Intel Corporation Jesse Barnes <jesse.barnes@intel.com>
Copyright (C) 2020 Basler AG
Copyright (c) 2011-2015 Xilinx Inc.
Copyright (C) 1998 Olivier A. D. Lebaillif
Copyright (C) 2011 - 2012 Michal Simek <monstr@monstr.eu>
Copyright (C) 2012 Rob Herring
Copyright (C) 2011, 2012 Roland Stigge <stigge@antcom.de>
Copyright (c) 2017 MediaTek Inc. Author: Yong Wu <yong.wu@mediatek.com>
Copyright (C) 2010 Bruno Randolf <br1@einfach.org>

Copyright (C) 2004 Sascha Hauer, Synertronixx GmbH
Copyright © 2006 Advanced Micro Devices, Inc.
Copyright (C) 2006 Sylvain Munaut <tnt@246tnt.com>
Copyright (C) 2010 Samsung Electronics MyungJoo Ham <myungjoo.ham@samsung.com>
Copyright 2009 Janusz Krzysztofik <jkrzysz@tis.icnet.pl>
Copyright (C) 2001, 2003 Keith M Wesolowski
Copyright (C) 2011 Texas Instruments Incorporated - http://www.ti.com/ Author: Rob Clark <rob@ti.com> Andy Gross <andy.gross@ti.com>
Copyright (c) 2010-2018 Nikolai Kondrashov
Copyright (C) 2018 Marvell
Copyright (C) 2014 Rose Technology
Copyright 2019 Intel Corporation, Inc.
Copyright (C) 2016 Maxime Ripard
Copyright 2015 LG Electronics Inc.
(C) 2002 by Harald Welte <laforge@gnumonks.org>;(C) 2011 Patrick McHardy <kaber@trash.net>
Copyright 2017 IBM Corp. include <linux/sched/mm.h> include "trace.h" include "ocxl_internal.h"
Copyright (C) 2013 David Herrmann <dh.herrmann@gmail.com>
Copyright (c) 2014 Protonic Holland, David Jander
Copyright(c) 2015 - 2016 Intel Deutschland GmbH
Copyright 2008-2009, 2011 Freescale Semiconductor, Inc.
Copyright (C) 2014 John Crispin <john@phrozen.org>
Copyright (C) 2015-2016 Russell King
Copyright (C) STMicroelectronics SA 2014 Authors: Benjamin Gaignard <benjamin.gaignard@st.com> Vincent Abriou <vincent.abriou@st.com> for STMicroelectronics.
Copyright (c) 1996-2000 Russell King.
(c) Copyright 1999, 2001 Alan Cox
Copyright 2011-2012, Meador Inge, Mentor Graphics Corporation.
Copyright 2009, Michael Buesch <m@bues.ch>
Copyright (c) 2016 Renesas Electronics Corporation.
Copyright (C) 2000-2001,2005-2007 Toshiba Corporation;(c) MontaVista Software, Inc.
Copyright (c) 2010-2016, Focaltech Ltd. All rights reserved.
Copyright 2009 Red Hat Inc. Author: Steven Rostedt <srostedt@redhat.com> License: The GNU Free Documentation License, Version 1.2 dual v2) Reviewers: Mathieu Desnoyers, Huang Ying, Hidetoshi Seto, and Frederic Weisbecker.
Copyright (C) 2011 - 2012 Samsung Electronics Co., Ltd.
Copyright (C) 1994-1996 Scott Snyder <snyder@fnald0.fnal.gov>
Copyright (c) International Business Machines Corp., 2000,2002
Copyright (C) 2014 Olli Salonen <olli.salonen@iki.fi>
Copyright (c) Siemens AG, 2011, 2012
Copyright (c) 2017 Free Electrons
Copyright (c) 2018 Redpine Signals Inc.
Copyright (C) 2015 Texas Instruments Incorporated - http://www.ti.com/ Dave Gerlach <d-gerlach@ti.com>
Copyright (C) 2005 - 2010 Paul Mundt
Copyright (C) 2003 - 2005 Nokia Corporation
Copyright (C) 2017 Preet Laes <plaes@plaes.org>
Copyright 2017 IBM Corp. ifndef _ASM_PNV_OCXL_H define _ASM_PNV_OCXL_H
Copyright (c) 2008 Matthieu Castet (castet.matthieu@free.fr)
Copyright (C) 2006, 2007 Atmel Corporation
Copyright (C) Shérab <Sebastien.Hinderer@ens-lyon.org>
Copyright (C) 2001-2003 IBM Corp.
Copyright (C) 2011-2012 ST-Ericsson SA Written on behalf of Linaro for ST-Ericsson Based on bits of regulator core, gpio core and clk core
Copyright (C) 2001-2004 Greg Kroah-Hartman (greg@kroah.com)
Copyright 2014 Alexander Aring <aar@pengutronix.de>
Copyright (C) 2009-2011 Red Hat, Inc.
Copyright (c) 2002, 2003 The Regents of the University of Michigan. All rights reserved.
Copyright (C) 2012 Vayavya Labs Pvt. Ltd.

LICENCE TERMS (cont.)

Copyright (C) 1998-99 Kirk Reiser.
Copyright (c) 1999-2015 Cadence Design Systems Inc.
Copyright 2007 STMicroelectronics Ltd.
Copyright (C) 2010: YOSHIFUJI Hideaki <yoshifuji@linux-ipv6.org>
Copyright (c) 2017 Oracle. All rights reserved.
Copyright (C) 2013 Renesas Solutions Corp. Kuninori Morimoto <kuninori.morimoto.gx@renesas.com>
Copyright 2014 Realtek Semiconductor Corp. Author: Bard Liao <bardliao@realtek.com>
Copyright 2010 IBM Corp, Benjamin Herrenschmidt <benh@kernel.crashing.org>
Copyright 2018 IBM Corp
Copyright (c) 2010-2013 NVIDIA Corporation.
"Copyright: Jamal Hadi Salim (2002-13)"
Copyright (C) 2000 - 2006 Krzysztof Halasa <khc@pm.waw.pl>
Copyright (C) 2002, 2006 Intel Corp.
Copyright IBM Corp. 1999, 2009 Author(s): Martin Schwidfsky <schwidfsky@de.ibm.com>, Hartmut Penner <hp@de.ibm.com>, Denis Joseph Barrow,
Copyright (C) 2013-2018 Arm Ltd. Author: Punit Agrawal <punit.agrawal@arm.com>, Suzuki Poulouse <suzuki.poulouse@arm.com>
Copyright (C) 2003 - 2006 Paul Mundt
Copyright (C) 2006, Jaya Kumar This work was sponsored by CIS(M) Sdn Bhd
(C) 2007 Rafael J. Wysocki <rjw@sisk.pl>
Copyright (C) 2002-2018 KVASER AB, Sweden. All rights reserved.
Copyright (C) 2015-2017 Texas Instruments Incorporated - <http://www.ti.com/>
Copyright [copy] 2018 Intel Corporation
Copyright (C) 2010-2015 Freescale Semiconductor, Inc. All Rights Reserved.
Copyright (C) 2015 Olof Kindgren <olof.kindgren@gmail.com>
Copyright 2005-2014 Freescale Semiconductor, Inc. All Rights Reserved.
Copyright (C) 2010 Juergen Beisert, Pengutronix
Copyright: [copy] 2016, Intel Corporation Author: Lv Zheng <lv.zheng@intel.com>
Copyright (c) 2010-2011 Picochip Ltd., Jamie Iles
Copyright (c) 2016 Baylibre SAS. Author: Michael Turquette <mturquette@baylibre.com>
Copyright (C) 2005 Dmitry Yusupov
Copyright (C) 2008 - 2013 Tensilica Inc.
Copyright (C) 2014 Linaro Ltd. <ard.biesheuvel@linaro.org>
Copyright (C) 2017 Synopsys, Inc. (www.synopsys.com)
Copyright (c) 2015, National Instruments Corp.
Copyright (C) 2001,2002 Networks Associates Technology, Inc.
Copyright (C) 2007-2008 Marvell International Ltd.
Copyright (c) 2016, Linaro Limited
Copyright 2015-2018 Cirrus Logic
Copyright (C) 2012 Samsung Electronics Co., Ltd. Author: Sylwester Nawrocki <snawrocki@samsung.com>
Copyright (C) 2009 T. Mertelj <tomaz.mertelj@guest.arnes.si>
Copyright 2005-2006 Openedhand Ltd.
Copyright (C) 2010 Michal Simek <monstr@monstr.eu>
Copyright (C) 2012 Vista Silicon SL Javier Martin <javier.martin@vista-silicon.com> Xavier Duret
Copyright (C) 2017 Sean Young <sean@mess.org>
Copyright (C) 2008 Extreme Engineering Solutions, Inc. Based on MPC8572DS device tree from Freescale Semiconductor, Inc.
Copyright (c) 2007, 2008, 2009, 2010 Juerg Haefliger <juergh@gmail.com>
Copyright 1995, Russell King. Various bits and pieces copyrights include: Linus Torvalds (test_bit).
Copyright (c) 2019 HiSilicon Limited.
(C) Copyright 1999 Linus Torvalds;(C) Copyright 1999 Johannes Erdfelt;(C) Copyright 1999 Gregory P. Smith;(C)
Copyright 2001 Brad Hards (bhards@bigpond.net.au)
Copyright 2010-2011 Analog Devices Inc.
Copyright (C) 2001-2002 Antefacto Ltd, 181 Parnell St, Dublin 1, Ireland.
Copyright (C) 2012 MIPS Technologies, Inc.
Copyright (c) 2006, 2007 IBM Corp. Josh Boyer <jwboyer@linux.vnet.ibm.com>, David Gibson <dwg@au1.ibm.com>
Copyright (C) 2015, Vitaly Kuznetsov <vkuznets@redhat.com>

Copyright (c) 2018 Christian Hewitt
(C) 2004-2006 by Jan-Benedict Glaw <jbglaw@lug-owl.de>
Copyright (C) 2009 Steven Rostedt <srostedt@redhat.com>
Copyright (c) 2018 MediaTek Inc. Author: Jie Qiu <jie.qiu@mediatek.com>
Copyright 2008 Google Inc. Author: Robert Love
Copyright IBM Corp. 2007 Author(s): Heiko Carstens <heiko.carstens@de.ibm.com>
Copyright (C) 1989, 1991 Free Software Foundation, Inc. 51 Franklin Street, Fifth Floor, Boston, MA 02110-1301 USA Everyone is permitted to copy and distribute verbatim copies of this license document, but changing it is not allowed.
Copyright (c) 2001-2005 Silicon Graphics, Inc. All Rights Reserved.
Copyright (C) 2004 David Brownell
Copyright (C) 2002 Intrinsyc Software Inc.
Copyright (c) 1999-2001 Dan Malek <dan@embeddedalley.com>
Copyright 2003, 2015 Yoshinori Sato <ysato@users.sourceforge.jp>
Copyright (C) 2014 Samsung Electronics Chanwoo Choi <cw00.choi@samsung.com> Krzysztof Kozlowski <krzk@kernel.org>
Copyright (C) 2002, 2006, 2007 David S. Miller (davem@davemloft.net)
Copyright (C) 2013-2016 Marek Vasut <marek.vasut@gmail.com>
Copyright (C) 2008 Florian Fainelli <florian@openwrt.org>
Copyright (C) 2008 Hewlett-Packard Development Company, L.P. David Altobelli <david.altobelli@hpe.com>
Copyright © 2006 David Woodhouse <dwmw2@infradead.org>
Copyright (C) 2000 Andrew Henroid
Copyright (C) 2008-2017 Andes Technology Corporation
Copyright 2014 Elettra-Sincrotrone Trieste S.C.p.A.
Copyright (c) 2005-2008 KeyStream Corp.
Copyright (C) 2011 Martin Groszhauser <mgroszhauser@gmail.com>
Copyright 2009-2010 Freescale Semiconductor, Inc.
Copyright: [copy] 2006 Intel Corporation
Copyright (C) 2007-2008 Freescale Semiconductor, Inc. All rights reserved.
Copyright 1997 Transmeta Corporation - All Rights Reserved
Copyright 2012 by Oracle Inc Author: Konrad Rzeszutek Wilk <konrad.wilk@oracle.com>
Copyright (C) 2010 Willow Garage <<http://www.willowgarage.com>>
(C) 2006-2007 Venkatesh Pallipadi <venkatesh.pallipadi@intel.com> Shaohua Li <shaohua.li@intel.com> Adam Belay <abelay@novell.com>
Copyright (c) 2010 John Fastabend <john.r.fastabend@intel.com>
Copyright (C) 2015 - 2016 Cavium Inc.
Copyright (C) 1999, 2000, 2001 Ingo Molnar, Red Hat
Copyright 2004 Simtec Electronics
Copyright 2009 Freescale Semiconductor Inc.
Copyright (C) 2007-2009 Renesas Solutions Corp.
Copyright (C) 2012 Thomas Mair <thomas.mair86@gmail.com>
Copyright (C) 2006 Jonathan McDowell <noodles@earth.li>
(c) 2004 Simtec Electronics;(c) 2005 Thibaut VARENE <varenet@parisc-linux.org>
(c) Copyright 1995 Simon "Guru Aleph-Null" Janes NCM: Network and Communications Management, Inc.:(c)
Copyright 2002 David S. Miller (davem@redhat.com)
Copyright (C) 2012,2019 Intel Corporation
Copyright (C) 2007-2012 ST-Ericsson SA Core platform support, IRQ handling and device definitions. Author: Linus Walleij <linus.walleij@stericsson.com>
Copyright 2006, Red Hat, Inc., Dave Jones
Copyright (c) 1997 Justin T. Gibbs.
Copyright 2016 Axentia Technologies
Copyright (C) 1995,1996 by Paul M. Antoine, some code and definitions are by courtesy of Chris Fraser.
Copyright (c) 2009 Samsung Electronics Co., Ltd. Pawel Osciak, <pawel@osciak.com> Marek Szyprowski, <m.szyprowski@samsung.com>
Copyright (C) 2016 NVIDIA CORPORATION, All Rights Reserved.
Copyright (C) 2011 ST-Ericsson SA Written on behalf of Linaro for ST-Ericsson This interface is used in the core to keep track of pins.

LICENCE TERMS (cont.)

Copyright (C) 2003-2005 David Hollis <dholllis@davehollis.com>
Copyright (C) 2006-2007 Micronas
Copyright (c) 2011-2012 Lars-Peter Clausen <lars@metafoo.de>
Copyright (C) 2014 Freescale Semiconductor, Inc. Dong Aisheng <b29396@freescale.com>
Copyright (C) 2015, 2016 Cavium, Inc.
(C) Copyright 2016 Intel Corporation Author: Tim Chen <tim.c.chen@linux.intel.com>
Copyright 2012-2019 Red Hat
Copyright (C) 2012-2015 Linus Walleij
Copyright (c) by Jaroslav Kysela <perex@suse.cz>
Copyright 2017 NXP.
Copyright (C) 2004-2008 by Eric Van Hensbergen <ericvh@gmail.com>
Copyright 2010,2012 Freescale Semiconductor Inc.
Copyright (C) 2009 Extreme Engineering Solutions, Inc. Based on TQM8548 device tree
Copyright 2017, Anju T, IBM Corp.
Copyright (C) 2015 Intel Corporation Author: Heikki Krogerus <heikki.krogerus@linux.intel.com>
"Copyright (C) 2014 Texas Instruments Incorporated Authors: Sandeep Nair <sandeep_n@ti.com Cyril Chemparathy <cyril@ti.com Santosh Shilimkar <santosh.shilimkar@ti.com>"
Copyright (C) 2013 Simon Baatz <gmbnomis@gmail.com>
Copyright (C) 2014-2019 B.A.T.M.A.N. contributors:
Copyright (c) 2011 Jan Andersson <jan@gaisler.com>;(C) Copyright 1999 Linus Torvalds;(C) Copyright 1999-2002 Johannes Erdfelt, johannes@erdfelt.com;(C) Copyright 1999 Randy Dunlap;(C) Copyright 1999 Georg Acher, acher@in.tum.de;(C) Copyright 1999 Deti Fliegl, deti@fliegl.de;(C) Copyright 1999 Thomas Sailer, sailer@ife.ee.ethz.ch;(C) Copyright 1999 Roman Weissgaerber, weissg@vienna.at;(C) Copyright 2000 Yggdrasil Computing, Inc. (port of new PCI interface support from usb-ohci.c by Adam Richter, adam@yggdrasil.com).;(C) Copyright 1999 Gregory P. Smith (from usb-ohci.c);(C) Copyright 2004-2007 Alan Stern, stern@rowland.harvard.edu
Copyright 2015 Mentor Graphics Corporation.
Copyright (c) 1995-2001,2004 Silicon Graphics, Inc. All Rights Reserved.
Copyright (C) 2009-2011 Red Hat, Inc. All Rights Reserved. Written by David Howells (dhowells@redhat.com)
Copyright (C) 2018 Ravi Bangoria, IBM Corporation
Copyright (c) 2014, 2015 FUKAUMI Naoki <naobsd@gmail.com>
Copyright (c) 2015 NVIDIA Corporation. All rights reserved.
Copyright (C) 2016 Asahi Kasei Microdevices Corporation
(C) 1995-2001 Russell King v0.04
Copyright 2019 Hans de Goede <hdegoede@redhat.com>
Copyright (C) 2009 - 2015 Xilinx, Inc.
Copyright (C) 2012 Dialog Semiconductor GmbH
Copyright (C) 2018 Christophe Leroy CS Systemes d'Information.
Copyright (C) 2010, 2013 Texas Instruments, Inc.
Copyright 1997, Theodore Ts'o
Copyright (C) 2003,2004 Eric Biederman (ebiederm@xmission.com)
Copyright 2013 Realtek Microelectronics
Copyright (C) 2017-2019 Broadcom. All Rights Reserved. The term
Copyright (C) 2006 by Russ Cox <rsc@swtch.com>
Copyright (C) 2001-2003 MontaVista Software Inc. Author: Yoichi Yuasa <source@mvista.com>
Copyright (C) 2002 Benjamin Herrenschmidt (benh@kernel.crashing.org)
Copyright (C) 2001-2003 Ilya Volynets
Copyright (C) 2019 Paul Cercueil <paul@crapouillou.net>
Copyright (C) 2019 Laurent Pinchart <laurent.pinchart@ideasonboard.com>
(c) Jaroslav Kysela <perex@perex.cz>
Copyright: (C) 2009 Nokia Corporation
Copyright (C) 2009 David S. Miller <davem@davemloft.net>
Copyright (c) 2016, NVIDIA Corporation. Author: Laxman Dewangan <ldewangan@nvidia.com>
Copyright (c) 2004 Andras BALI <drewie@freemail.hu>
Copyright (C) 2017 Andrea Adami <andrea.adami@gmail.com>
Copyright (C) 2014 Hans de Goede <hdegoede@redhat.com>
Copyright (C) 2014 NovaTech LLC - http://www.novatechweb.com
Copyright (C) 2006 Jaya Kumar
Copyright (c) 2007 Sigmatel, Inc. Peter Hartley, <peter.hartley@sigmatel.com>
Copyright (C) 1997, 2001, 2003, 2004 Ralf Baechle (ralf@linux-mips.org)
Copyright 2015, Heiner Kallweit <hkallweit1@gmail.com>
Copyright (c) 2011-2012, NVIDIA CORPORATION. All rights reserved.
Copyright (C) 2013 Intel Corporation Author: Tim Chen <tim.c.chen@linux.intel.com>
Copyright (C) 2012 Simo Sorce <simo@redhat.com>
Copyright (C) 2009 Nokia Corporation.
Copyright (C) 2007-2008 by Nokia Corporation
Copyright (c) 2016, Zodiac Inflight Innovations
Copyright (C) 2017 Juergen Fitschen <me@jue.yt>
Copyright 2017 Red Hat Parts ported from amdgpu (fence wait code).
Copyright 2015 Toradex AG
Copyright 2007 Ralink Inc. (bruce_chang@ralinktech.com.tw)
Copyright (C) 1998-2005 Pavel Machek <pavel@ucw.cz>
Copyright (c) Realtek Semiconductor Corp. All rights reserved.
Copyright (c) YAEHASHI Takeshi, 2001
Copyright(c) 1999 - 2013 Intel Corporation.
Copyright 1994 - 2000, 2002 Ralf Baechle (ralf@gnu.org)
(c) 2004-2005 Simtec Electronics http://www.simtec.co.uk/products/SWLINUX/ Ben Dooks <ben@simtec.co.uk>
Copyright (C) 2011 Arnaldo Carvalho de Melo <acme@redhat.com>
Copyright 2007-2008 Freescale Semiconductor, Inc.
Copyright (C) 1992, 1993, 1994, 1995 Remy Card (card@masi.ibp.fr) Laboratoire MASI
Copyright (c) 2017-2018 Cirrus Logic, Inc. and Cirrus Logic International Semiconductor Ltd.
Copyright (C) 2007-2015 STMicroelectronics Ltd Author: Giuseppe Cavallaro <peppe.cavallaro@st.com>
Copyright (C) 1997 David S. Miller (davem@davemloft.net)
Copyright (C) 2014 Ulrich Hecht
Copyright (c) 2005 Intel Inc. All rights reserved.
Copyright (C) 1992 Krishna Balasubramanian and Linus Torvalds
Copyright (C) 2005 Thiemo Seufer
Copyright (C) 1994-1998 Linus Torvalds
Copyright 1996, Paul Mackerras.
Copyright Compulab Ltd., 2006,2007 Mike Rapoport <mike@compulab.co.il>
Copyright 2001 Red Hat, Inc.
Copyright (c) 2001-2007 Anton Altaparmakov
Copyright (c) 2012 Samsung Electronics Co., Ltd(http://www.samsung.com)
Copyright (C) 2004, 2005 Paul Mundt <lethal@linux-sh.org>
Copyright (C) 2004-5 Red Hat, Inc. All Rights Reserved. Written by David Howells (dhowells@redhat.com)
Copyright (C) 2010-2017 Cavium Networks
Copyright (C) 2013 Guenter Roeck <linux@roeck-us.net>
Copyright (C) 2014-2015 Broadcom Corporation
Copyright (c) 1999-2005 Joerg Heckenbach <joerg@heckenbach-aw.de> Dwaine Garden <dwainegarden@rogers.com>
Copyright (c) 2015 Kuninori Morimoto <kuninori.morimoto.gx@renesas.com>
(c) Rebel.COM, 1998,1999
Copyright (C) 2006 James Smart, Emulex Corporation
Copyright (c) 2008-2011 Jonathan Cameron
Copyright (C) 2015, Broadcom Corporation
Copyright (C) 2011 - 2012 Johan Hovold <jhovold@gmail.com>
Copyright 2003, Jouni Malinen <jkmaline@cc.hut.fi>
Copyright (C) 2005 Tensilica Inc.
Copyright 2012-2013 David Herrmann <dh.herrmann@gmail.com>
Copyright (C) 2017 Arasan Chip Systems Inc.
Copyright (C) 2009 - 2010 Renesas Solutions Corp.
Copyright (C) 2006, 2009 Oliver Endriss <o.endriss@gmx.de>
(c) 2007 Red Hat
Copyright (C) 2018 The Chromium OS Authors.
(C) 2000-2003 Dave Jones, Arjan van de Ven, Janne Pankkälä, , Dominik Brodowski.

LICENCE TERMS (cont.)

Copyright (C) 2018 Digital Devices GmbH Marcus Metzler <mocm@metzlerbros.de> Ralph Metzler <rjkm@metzlerbros.de>
Copyright (c) 2016, Mellanox Technologies inc. All rights reserved.
Copyright 2016 Alastair D'Silva, IBM Corporation.
Copyright (C) 2001 Will Dyson <will_dyson@pobox.com>
Copyright (C) 2009 Wolfram Sang, Pengutronix
Copyright (C) 2016-2018 Linaro Ltd.
Copyright IBM Corp. 2004, 2006 Author(s): Martin Schwidewsky (schwidewsky@de.ibm.com)
Copyright (C) 2008, 2009, 2010 Nitin Gupta 2012, 2013 Minchan Kim
Copyright (C) 2006-2007 Renesas Solutions Corp.
Copyright (c) 2004 Jaroslav Kysela <perex@perex.cz>
Copyright (C) 2018-2019 Cirrus Logic, Inc. and Cirrus Logic International Semiconductor Ltd.
Copyright (c) 2012-2013, Wind River Systems
Copyright (c) 2010 Rafael J. Wysocki <rjw@sisk.pl>, Novell Inc.
Copyright (c) 2007 Maciej W. Rozycki
Copyright 2013-2015 Emilio López
Copyright 2007,2008 Freescale Semiconductor Inc.
Copyright (C) 1999 - 2003 ARM Limited
Copyright (C) 2008 Option International Filip Aben <f.aben@option.com> Denis Joseph Barrow <d.barow@option.com> Jan Dumon <j.dumon@option.com>
Copyright (c) 2007-2008, Intel Corporation. All Rights Reserved.
Copyright 2016, Rashmica Gupta, IBM Corp.
Copyright (C) 1998-2004 Hewlett-Packard Co David Mosberger-Tang <davidm@hpl.hp.com> Stephane Eranian <eranian@hpl.hp.com>
(C) 1993, Hamish Macdonald, see a3000.c for more info
Copyright (c) 2016 Masaki Ota <masaki.ota@jp.alps.com>
Copyright © 2000 Netgem S.A.
Copyright (C) 2004-2009 Dominik Brodowski <linux@dominikbrodowski.de>
Copyright (c) 2016 Samsung Electronics Co., Ltd. <http://www.samsung.com> Author: Krzysztof Kozłowski <krzk@kernel.org>
Copyright (C) 2005-2009 Atmel Corporation
Copyright (C) 1999 - 2010 Intel Corporation.
Copyright (C) 2013,2019 Advanced Micro Devices, Inc.
Copyright 2017 IBM Corp. include <linux/sysfs.h> include "ocxl_internal.h"
Copyright (c) 2010 Samsung Electronics Co. Ltd <http://www.samsung.com/>
Copyright (c) 2007 Red Hat, Inc. Author(s): Jeff Layton (jlayton@redhat.com) Steve French (sfrench@us.ibm.com)
Copyright (C) 2007 Lemote Inc. & Institute of Computing Technology Author: Yanhua, yanh@lemote.com
Copyright (c) 2013 Cambridge Silicon Radio Limited, a CSR plc group company.
Copyright (C) 2004 - 2007 Paul Mundt
Copyright (C) 2009-2012 Jean-Francois Moine <<http://moinejf.free.fr>>
Copyright (C) 2010, Lars-Peter Clausen <lars@metafoo.de>
Copyright (C) 2017 Intel Corp Author: Subhransu S. Prusty <subhransu.s.prusty@intel.com>
Copyright (c) 2005 Michael Schmitz
Copyright (C) 2015 Wang Nan <wangnan0@huawei.com>
Copyright (C) 2004-2007 Pierre Ossman, All Rights Reserved.
Copyright (C) 2015 - 2016 Samsung Electronics Co., Ltd.
Copyright (C) 2011. Freescale Inc. All rights reserved.
Copyright 2017, Gustavo Romero, IBM Corp.
Copyright (C) 2012 Nobuhiro Iwamatsu <iwamatsu@nigauri.org>
Copyright (C) 2010-2013 LaCie
Copyright 1995 Linus Torvalds
Copyright (c) 2002-5 Patrick Mochel
Copyright © 2001-2007 Red Hat, Inc. All Rights Reserved.
(C) 2006 Red Hat Inc Alan Cox
(C) Copyright 1999-2006, Greg Ungerer <gerg@snapgear.com>;(C) Copyright 2000, Lineo Inc. (www.lineo.com)
Copyright (C) 2012 Texas Instruments, Inc. - <http://www.ti.com/>
Copyright 2004-2005 Red Hat, Inc. Jeff Garzik <jgarzik@pobox.com>

Copyright (c) 2018 BayLibre, SAS. Author: Neil Armstrong <narmstrong@baylibre.com> Author: Jerome Brunet <jbrunet@baylibre.com>
Copyright (C)2015-2016 Texas Instruments Incorporated - <http://www.ti.com>
Copyright (C) 2013 Marek Vasut <marex@denx.de>
Copyright (C) 2014, Broadcom Corporation
Copyright (C) 2017 Fuzhou Rockchip Electronics Co., Ltd.
(c) 2011 Manuel Lauss <manuel.lauss@googlemail.com>
Copyright (c) 2006, 2019 Oracle and/or its affiliates. All rights reserved.
Copyright (c) 2014 SGI. All rights reserved.
Copyright (C) 2006 Andrew de Quincey
Copyright (C) 2010 DENX Software Engineering
Copyright (c) 2014, Sony Mobile Communications AB.
Copyright (C) 2010 Texas Instruments Incorporated Written by Mark Salter (msalter@redhat.com)
Copyright (C) 2010 Texas Instruments, Inc
Copyright (c) International Business Machines Corp., 2000,2009
Copyright (c) 2006, 2007 IBM Corp. Josh Boyer <jwboyer@linux.vnet.ibm.com>
Copyright (c) 2018, DENX Software Engineering GmbH Author: Parthiban Nallathambi <pn@denx.de>
(C) 1999 Andrea Arcangeli, SuSE GmbH, andrea@suse.de Gerhard Wichert, Siemens AG, Gerhard.Wichert@pdb.siemens.de
Copyright (C) 2016 Intel Corp.
Copyright (C) 2008 Russell King.
Copyright (C) 2013 Stefan Kristiansson, stefan.kristiansson@saunalahti.fi
Copyright (C) 2014 Angelo Compagnucci <angelo.compagnucci@gmail.com>
Copyright (C) 1997, 1998, 1999, 2007 David S. Miller (davem@davemloft.net)
Copyright (c) 2009-2013 LSI Corporation
Copyright 2010 Ben. Herrenschmidt, IBM Corporation.
Copyright (C) 2006-2008 David Brownell
Copyright (c) 2009 - 2016 Freescale Semiconductor, Inc.
Copyright (C) 2011 Free Electrons
Copyright 2011 - 2012 Cavium, Inc.
Copyright (C) 2013 MundoReader S.L. Author: Heiko Stuebner <heiko@sntech.de>
Copyright (C) 2003 Christoph Hellwig.
Copyright (C) 2009 Matt Fleming <matt@console-pimps.org>
Copyright 2003 Thiemo Seufer <seufer@csv.ica.uni-stuttgart.de>
Copyright: |copy| 2016 Intel Corporation Authors: - Fenghua Yu <fenghua.yu@intel.com> Tony Luck <tony.luck@intel.com> Vikas Shivappa <vikas.shivappa@intel.com>
Copyright (C) 1992, 1993, 1994 Rick Sladkey
Copyright (C) 2014-2015 Cypress Semiconductor, Inc.
Copyright: |copy| 2013-2016, Intel Corporation
Copyright (c) 2018 Red Hat, Inc.
Copyright (C) 2010 IBM Corporation
Copyright IBM Corp. 2002, 2011 Author(s): Thomas Spatzier (tspat@de.ibm.com) Author(s): Mahesh Salgaonkar (mahesh@linux.vnet.ibm.com) Author(s): Heinz Graalfs (graalfs@linux.vnet.ibm.com) Author(s): Andreas Kriebel (kriebel@linux.vnet.ibm.com)
(C) 2007 EADS Astrium
Copyright (C) 2002 Richard Henderson.
Copyright (C) 2017 Red Hat, Inc. Author: Stefan Hajnoczi <stefanha@redhat.com>
Copyright 2018 Cisco Systems, Inc. and/or its affiliates. All rights reserved.
Copyright (c) by Chris Rankin
Copyright 2017~2018 NXP
Copyright (c), 2004-2005,2007-2010 Trident Microsystems, Inc. All rights reserved.
Copyright (C) 2002-2004 John Belmonte
Copyright (c) 2014 Patrik Jakobsson All Rights Reserved.
Copyright (C) 2012-2013 Marek Vasut <marex@denx.de>
Copyright (C) 2012, 2014 Jean Delvare <jdelvare@suse.de>
Copyright (C) 2006 Alex Dubov <oakad@yahoo.com>
Copyright (C) 2018 Collabora, Ltd.

LICENCE TERMS (cont.)

Copyright (c) by Jaroslav Kysela <perex@perex.cz> Originally the CS4232/CS4232A driver, modified for use on CS4231 by Tugrul Galatali <galatali@stuy.edu>
Copyright (c) 2013 ELAN Microelectronics Corp.
Copyright (C) 2000, 2004 Maciej W. Rozycki
Copyright (c) 2018 Broadcom. All Rights Reserved.
Copyright (c) 2016 Sargun Dhillon <sargun@sargun.me>
Copyright (c) 2004-2006, K A Fraser
Copyright (c) 2014-2016 Intel Corporation
Copyright (C) 1998-2000 Michel Aubry, Maintainer
Copyright (c) 2000 Nils Faerber
Copyright (c) 2006 Tensilica, Inc. All Rights Reserved.
Copyright (C) 2007-2017 Texas Instruments Incorporated - <http://www.ti.com/>
Copyright (C) 2016 Jason A. Donenfeld <Jason@zx2c4.com>. All Rights Reserved.
Copyright (C) 2001 Paul Diefenbaugh <paul.s.diefenbaugh@intel.com>
Copyright (C) 2014 - 2018 Linaro Ltd. <ard.biesheuvel@linaro.org>
Copyright (C) 2008 Texas Instruments Inc Author: Vaibhav Hiremath <hvaibhav@ti.com>
Copyright (C) 2001 PPC 64 Team, IBM Corp
Copyright (C) 2018 - Arm Ltd
Copyright (C) 2003 Jana Saout <jana@saout.de>
Copyright (C) 2016-2018 Cirrus Logic
Copyright 2011, Siemens AG written by Alexander Smirnov <alex.bluesman.smirnov@gmail.com>
Copyright (c) 2018 Cavium, Inc.
Copyright (C) 2003-2010 Jean Delvare <jdelvare@suse.de>
Copyright (C) 2003 Jozsef Kadlecsek <kadlec@netfilter.org>
Copyright (C) 2015 DH electronics GmbH
Copyright (C) 1999 SuSE GmbH Nuernberg
Copyright 2009 AMCC (AppliedMicro) <tnguyen@amcc.com>
Copyright (C) 2016-2017 Dmitry Osipenko <digetx@gmail.com> */ #ifndef _UAPI_TEGRA_VDE_H_ #define _UAPI_TEGRA_VDE_H_
Copyright (C) 2008-2009 ST-Ericsson AB Watchdog driver for the ST-Ericsson AB COH 901 327 IP core Author: Linus Walleij <linus.walleij@stericsson.com>
Copyright 2015-2017 Google, Inc
Copyright (c) 2016, Mellanox Technologies, Ltd. All rights reserved.
Copyright (c) 2006-2007, D G Murray.;(c) 2009 Gerd Hoffmann <kraxel@redhat.com>;(c) 2018 Oleksandr Andrushchenko, EPAM Systems Inc.
Copyright (c) 2014 Rockchip Electronics Co. Ltd. Author: Jianqun <jay.xu@rock-chips.com>
Copyright (C) STMicroelectronics SA 2016
(C) Copyright 1994 - 1997 Marco van Wieringen
Copyright (C) 2015 Red Hat
Copyright (c) 2016-2017 Micron Technology, Inc.
Copyright (C) 2009 Lemote Inc. & DSLab, Lanzhou University, China
Copyright (c) 2004 Nex Vision Guillaume GOURAT <guillaume.gourat@nexvision.tv>
Copyright (C) 2005, 2008 Texas Instruments Inc.
Copyright 2007-2009 Johannes Berg
Copyright (C) 2009-2010 Alexander Gordeev <lasaine@lvk.cs.msu.su>
Copyright (C) 2016 Linaro, Inc.
Copyright (C) 2011-2016, Yann Collet. BSD 2-Clause License (<http://www.opensource.org/licenses/bsd-license.php>)
Redistribution and use in source and binary forms, with or without modification, are permitted provided that the following conditions are met:
(C) Copyright 2002-2004 by David Brownell All Rights Reserved.
Copyright (C) 2011 Netlogic Microsystems.
(C) Copyright TOSHIBA CORPORATION 2007
Copyright IBM Corp. 2013 Author(s): Martin Schwidofsky <schwidofsky@de.ibm.com>
Copyright (c) 2005 Michael Buesch <m@buesch.ch>
Copyright (c) 2001-2002 Ben Fennema <bfennema@falcon.csc.calpoly.edu> All rights reserved.
Copyright (C) 2000, 2001 Kanoj Sarcar
"Copyright: (C) 2018 Socionext Inc."

Copyright (C) 2013-2014 Allwinner Tech Co., Ltd Author: Sugar <shuge@allwinnertech.com>
Copyright (c) 2015-2016 Google Inc.
Copyright (C) 2007, 2009 Oracle. All rights reserved.
Copyright (c) 2012, Code Aurora Forum. All rights reserved.
Copyright (c) 2002 LSI Logic Corporation.
Copyright (c) 2015 MediaTek Inc. Authors: YT Shen <yt.shen@mediatek.com> CK Hu <ck.hu@mediatek.com>
Copyright 2012 ST-Ericsson
Copyright (C) 2017 MediaTek Inc.
Copyright (C) 2016 Allied Telesis Labs NZ
Copyright (C) 2018 Chen-Yu Tsai <wens@csie.org>
Copyright (C) 2006 Secret Lab Technologies Ltd. Grant Likely <grant.likely@secretlab.ca>
Copyright (C) 2018 ARM Ltd, All Rights Reserved.
Copyright (C) 2002 Laurent Canet <canetl@esiee.fr>
Copyright (C) 2000-2001 Hewlett Packard Company
Copyright (C) 2005 by Latchesar Ionkov <luchio@ionkov.net>
Copyright (C) 2017, STMicroelectronics - All Rights Reserved Author: Fabrice Gasnier <fabrice.gasnier@st.com>.
Copyright (C) 2004 IBM Corporation Authors: Leendert van Doorn <leendert@watson.ibm.com> Dave Safford <safford@watson.ibm.com> Reiner Sailer <sailer@watson.ibm.com> Kylene Hall <kjhall@us.ibm.com>
Copyright (C) 2009 Intel Corp
Copyright (C) 2017 Dell Inc. All Rights Reserved.
Copyright (C) 2000 IBM Corporation */
Copyright 2017 Hannes Reinecke, SUSE Linux GmbH <hare@suse.com>
Copyright 2015 Free Electrons
Copyright (C) 2007 (davem@davemloft.net)
Copyright (c) 2006 Anssi Hannula <anssi.hannula@gmail.com>
Copyright (C) Secret Lab Technologies Ltd.
Copyright (C) 1999 Linus Torvalds.
Copyright (C) 2017 Zihao Yu
Copyright (C) 2006 AppSpec Computer Technologies Corp. Jeff Gibbons <jeff.gibbons@appspec.com>
Copyright (C) Fuzhou Rockchip Electronics Co.Ltd Author: Sandy Huang <hjc@rock-chips.com>;(c) container_of(c, struct rockchip_rgb, encoder)
Copyright (C) 2011-2013 Xilinx
Copyright (C) Fuzhou Rockchip Electronics Co., Ltd. Author: Andy Yan <andy.yan@rock-chips.com> Yakir Yang <ykk@rock-chips.com> Jeff Chen <jeff.chen@rock-chips.com>
(C) Copyright 2009 Marvell International Ltd. All Rights Reserved
Copyright 2017 Maxime Roussin-Bélanger expanded by Silvan Murer <silvan.murer@gmail.com>
Copyright (C) 2016 Red Hat, Inc.
Copyright (C) 2004-2007 by Daniel Ritz <daniel.ritz@gmx.ch>
Copyright (C) 2008, Guennadi Liakhovetski, DENX Software Engineering, <lg@denx.de>
Copyright (C) 2006-2010, 2012-2013 Freescale Semiconductor, Inc. All rights reserved.
(C) 1999-2001 Paul `Rusty` Russell
Copyright 2009 VMware, Inc.
Copyright (C) 2013 Seiji Aguchi <seiji.aguchi@hds.com>
Copyright (C) 2012 Pali Rohár <pali.rohar@gmail.com>
Copyright (C) 2000 Jens Axboe <axboe@suse.de>
Copyright (C) 2008-2010 Pavel Cheblakov <P.B.Cheblakov@inp.nsk.su>
Copyright 2012-2016 Advanced Micro Devices, Inc.
Copyright (C) 1995, 1996, 2008 David S. Miller (davem@davemloft.net)
"Copyright IBM Corp. 2001, 2007 Authors: Fritz Elfert (felbert@millenux.com) Peter Tiedemann (ptiedem@de.ibm.com)"
Copyright (C) 2008 Dmitry Baryshkov
Copyright (C) 1999-2002 Russell King
Copyright (c) 2013 Christian Ohm Heavily inspired by various other HID drivers that adjust the report descriptor.
Copyright 2009-2011 Wolfson Microelectronics PLC.
Copyright (c) 2010, 2015 Mathieu Desnoyers <mathieu.desnoyers@efficios.com>
Copyright 2009 Marcin Kościelnicki
Copyright (C) 2014-2018 MediaTek Inc.

LICENCE TERMS (cont.)

Copyright (c) 2016 MediaTek Inc. Author: Ming Hsiu Tsai <minghsui.tsai@mediatek.com> Rick Chang <rick.chang@mediatek.com>
Copyright (C) 2016 ARM Limited, All Rights Reserved.
Copyright 2011 Paul Mackerras, IBM Corp. <paulus@au1.ibm.com>
Copyright (C) 2008-2009 ST-Ericsson SA
Copyright [copy] 2009 Tobias Lorenz <tobias.lorenz@gmx.net>
Copyright (C) 2008 Silicon Graphics, Inc. All rights reserved.
Copyright (c) 2019 Christoph Hellwig.
Copyright (C) 2008 <srinivasa.deevi at conexant dot com> Based on em28xx driver
Copyright (C) 2003-2006 Hyok S. Choi <hyok.choi@samsung.com>
Copyright (c) 2006, 2007 IBM Corp.
Copyright (C) 2008 Patrick Boettcher <pb@linuxtv.org>
Copyright (C) 2016 Emcraft Systems
Copyright (C) 2007 MIPS Technologies, Inc.
Copyright (c) 2015 MediaTek Inc. Author: Koro Chen <koro.chen@mediatek.com> Sascha Hauer <s.hauer@pengutronix.de> Hidalgo Huang <hidalgo.huang@mediatek.com> Ir Lian <ir.lian@mediatek.com>
Copyright(c): 2009, Thomas Renninger <trenn@suse.de>, Novell Inc.
Copyright (C) 2014, Cisco Systems, Inc. All rights reserved.
Copyright (C) 2002, IBM Corp.
"Copyright 2005-2006 Jiri Benc <jbenc@suse.cz>"
Copyright (c) 2001-2002, SSH Communications Security Corp and Jouni Malinen j@w1.fi
Copyright (C) 1992, 1993 Krishna Balasubramanian Many improvements/fixes by Bruno Haible. Replaced `struct shm_desc' by `struct vm_area_struct', July 1994. Fixed the shm swap deallocation (shm_unuse()), August 1998
Andrea Arcangeli.;(c) 1999 Dragos Acostachioaie <dragos@iname.com> BIGMEM support, Andrea Arcangeli <andrea@suse.de> SMP thread shm, Jean-Luc Boyard <jean-luc.boyard@siemens.fr> HIGHMEM support, Ingo Molnar <mingo@redhat.com> Make shmmx, shmall, shmmni sysctl'able, Christoph Rohland <cr@sap.com>
Copyright (C) 2017 by Stafford Horne (shorne@gmail.com)
Copyright (c) 2014 Andy Lutomirski and others v2
Copyright (c) 1994-2000 Justin T. Gibbs.
Copyright (C) 2009 Texas Instruments Incorporated
Copyright (C) 2010-11 Texas Instruments Incorporated - http://www.ti.com/
Copyright (C) 2011 Kionix, Inc. Written by Chris Hudson <chudson@kionix.com>
Copyright (C) 2004 Fujitsu Siemens Computers GmbH Author: Bodo Stroesser (bodo.stroesser@fujitsu-siemens.com)
Copyright (C) 2004 Arcom Control Systems
Copyright (c) 2009-2011 Samsung Electronics Co., Ltd. http://www.samsung.com
(C) Copyright 2013-2015 Hewlett-Packard Development Company, L.P.:(C) Copyright 2015 Hewlett-Packard Enterprise Development LP
Copyright (C) 2014-2017 Broadcom
Copyright (C) 2016 STMicroelectronics
Copyright 2011-2013 Freescale Semiconductor, Inc.
Copyright 2016-2017 Google, Inc
Copyright (C) 2013 Maciej W. Rozycki
Copyright (C) 1994, 1996 Free Software Foundation, Inc.
Copyright (C) 2015 Samsung Electronics Ingi Kim <ingi2.kim@samsung.com>
Copyright (C) 2008-2011 Vision Engraving Systems H Hartley Sweeten <hsweeten@visionengravers.com>
Copyright (c) 2012 by Mauro Carvalho Chehab
Copyright (C) 2001-2003 Hewlett-Packard Co David Mosberger-Tang <davidm@hpl.hp.com>
Copyright (c) 2016 MediaTek Inc. Author: Daniel Hsiao <daniel.hsiao@mediatek.com> PoChun Lin <pochun.lin@mediatek.com>
Copyright 2002 Adam Belay <ambx1@neo.rr.com>
Copyright (C) 2010 Andy Walls <awalls@md.metrocast.net>
Copyright (C) 2010 Malcolm Priestley (tvboxspy@gmail.com)
Copyright (C) 2009 Marvell International Ltd. Haojian Zhuang <haojian.zhuang@marvell.com>
(c) 1999--2000 Martin Mares <mj@ucw.cz>
Copyright 2002, 2003 Andi Kleen, SuSE Labs.
Copyright (C) 2000 2001, The Delft University of Technology

(C) 2004 Hiroshi Miura <miura@da-cha.org>
Copyright 2010 Matt Turner.
Copyright 2003-2007 Red Hat Inc., Durham, North Carolina. All Rights Reserved.
Copyright (c) 2016 VMware
Copyright(c) 2015-2017 Intel Deutschland GmbH
Copyright (C) 2014-2016 Pratyush Anand <panand@redhat.com>
"Copyright IBM Corp. 2007, 2007 Authors: Peter Tiedemann (ptiedem@de.ibm.com)"
Copyright (C) 2016 Linaro Ltd. Author: Linus Walleij <linus.walleij@linaro.org> Loosely based on the previous BH1780 ALS misc driver
(c) Copyright 2009 Google Inc., All Rights Reserved.
Copyright (C) 2005-2007 Takahiro Hirofuchi
Copyright** [copy] 2015 Intel Corporation
Copyright (C) 2005 Sylvain Munaut <tnt@246tNt.com>
Copyright (c) 2007 The University of Aberdeen, Scotland, UK
Copyright (C) ST-Ericsson 2013 Author: Hongbo Zhang <hongbo.zhang@linaro.com>
(C) Copyright 1999-2006, Greg Ungerer (gerg@snapgear.com);(C) Copyright 2000, Lineo (www.lineo.com)
Copyright 2018 NXP Richard Zhu <hongxing.zhu@nxp.com>
Copyright (c) 2003 Patrick McHardy, <kaber@trash.net>
Copyright (c) 2004 by Hansjoerg Lipp <hjlipp@web.de>
Copyright (C) 2015 Imagination Technologies, Inc. written by Ralf Baechle <ralf@linux-mips.org>
Copyrights (C) IBM Corporation, 2011. Author: Suzuki Poulouse <suzuki@in.ibm.com>
Copyright (C) 2011-2015 Texas Instruments Incorporated - http://www.ti.com/ Santosh Shilimkar <santosh.shilimkar@ti.com> Sricharan <r.sricharan@ti.com>
Copyright 2007-2012 Freescale Semiconductor, Inc.
Copyright (c) 2007 Michael Buesch <m@bues.ch>
Copyright (c) 2015 Dialog Semiconductor Ltd.
Copyright (C) 2009 by Tom Zanussi
Copyright 2012-2013 (C) M2TECH S.r.l and Amarula Solutions B.V.
"(C) Copyright 1996 Linus Torvalds accelerated versions (and 21264 assembly versions) contributed by Rick Gorton <rick.gorton@alpha-processor.com>"
Copyright (C) 2001-2004 by Thomas Winischhofer, Vienna, Austria and sis310_accel.h which is
Copyright (C) 2012 Oliver Hartkopp <socketcan@hartkopp.net>
Copyright (C) 2018 Intel Corp
Copyright (c) 2009-2011, NVIDIA Corporation.
Copyright (C) 2008,2009,2010 Nokia Corporation. All rights reserved.
Copyright (C) Shailabh Nagar, IBM Corp. 2006
Copyright (C) 1991, 1992, 1993, 1994 Linus Torvalds Swap reorganised 29.12.95, Stephen Tweedie;(C) 1998 Stephen Tweedie
Copyright (C) 2010, 2011 Roland Stigge <stigge@antcom.de>
Copyright (C) 2009 Thadeu Lima de Souza Cascardo <cascardo@holoscopio.com>
Copyright 2008, Intel Corporation
(C) Copyright 1995 1996 Linus Torvalds;(C) Copyright 2005 - 2010 Paul Mundt
(C) Copyright Linaro, Ltd. 2018;(C) Copyright Arm Holdings. 2017;(C) Copyright David Gibson <dwg@au1.ibm.com>, IBM Corporation. 2005.
(c) 2006-2009 Secret Lab Technologies Ltd Grant Likely <grant.likely@secretlab.ca>
"Copyright (c) Marc A. Viredaz, 1998 DEC Western Research Laboratory, Palo Alto, CA Date January 1998 (April 1997) System StrongARM SA-1100 LanguageC or ARM Assembly Purpose Definition of constants related to the StrongARM SA-1100 microprocessor (Advanced R"
Copyright (C) 2003 Bernardo Innocenti <bernie@develer.com>
Copyright IBM Corp. 2009, 2011 Author(s): Peter Oberparleiter <peter.oberparleiter@de.ibm.com>
Copyright (C) 2006-2007,2009 MontaVista Software, Inc. <source@mvista.com>
Copyright (c) 2015, ROCKCHIP CORPORATION. All rights reserved.
Copyright (C) 2008 Hans Verkuil <hverkuil@xs4all.nl>
Copyright © 2015 Google Inc.
Copyright (C) 1994 Hamish Macdonald
Copyright(c) 2014-2017 aQuantia Corporation.
Copyright 2014 - 2015 Freescale Semiconductor Inc.

LICENCE TERMS (cont.)

Copyright (c) 2010 Marvell International Inc.
Copyright 2004 J. Mayer <l_indien@magic.fr>
(C) 2006 Rafael J. Wysocki <rjw@sisk.pl>
Copyright (C) 2018 Synopsys, Inc. (www.synopsys.com)
Copyright (c) 2016 MediaTek Inc. Author: Jungchang Tsao <jungchang.tsao@mediatek.com> Daniel Hsiao <daniel.hsiao@mediatek.com> Tiffany Lin <tiffany.lin@mediatek.com>
Copyright IBM Corp. 2001, 2009 Author(s): Carsten Otte <cotte@de.ibm.com> Michael Holzheu <holzheu@de.ibm.com> Tuan Ngo-Anh <ngoanh@de.ibm.com> Martin Schwidewsky <schwidewsky@de.ibm.com> Stefan Bader <shbader@de.ibm.com>;(C) 2001 IBM Deutschland Entwicklung GmbH by Carsten Otte and " Michael Holzheu (cotte@de.ibm.com,holzheu@de.ibm.com)"
Copyright(C) 2006 Elan Digital Systems Limited http://www.elandigitalsystems.com
Copyright (C) 2009,2012 ST Microelectronics Rajeev Kumar <rajeev-dlh.kumar@st.com> Viresh Kumar <vireshk@kernel.org>
Copyright (C) 2016 Gwenhael Goavec-Merou
Copyright (c) 2009 Jochen Friedrich <jochen@scram.de>
Copyright 2005-2009 Freescale Semiconductor, Inc.
Copyright (C) 2014 Claudio Leite <leitec@staticy.com>
Copyright (C) 2013-2014,2016 Michael Heimpold <mhei@heimpold.de>
Copyright (c) 2006-2010 BalaBit IT Ltd. Author: Balazs Scheidler, Krisztian Kovacs
(C) Nadia Yvette Chambers, April 2004
(C) 2008 Krzysztof Piotr Oledzki <ole@ans.pl>
Copyright (C) 2018 Author: Jeff LaBundy <jeff@labundy.com>
Copyright (c) 2017 MediaTek Inc. Author: Ryder Lee <ryder.lee@mediatek.com> Honghui Zhang <honghui.zhang@mediatek.com>
Copyright (C) 2014 Texas Instruments Author: Tomi Valkeinen <tomi.valkeinen@ti.com>
Copyright (C) 2012-2013 Avionic Design GmbH
Copyright (C) 2015 Altera Corporation. All rights reserved
Copyright (C) 2002, 2003 Philip Pokorny <ppokorny@penguincomputing.com>
Copyright (C) 2017 - Cambridge Greys Limited
Copyright (C) 2007-2010 ST-Ericsson Low-level core for exclusive access to the AB3100 IC on the I2C bus and some basic chip-configuration. Author: Linus Walleij <linus.walleij@stericsson.com>
Copyright (c) 2019, Linaro Ltd. Author: Georgi Djakov <georgi.djakov@linaro.org>
"Copyright: (C) MontaVista Software Inc."
Copyright 2014-2016 by Open Source Security, Inc., Brad Spengler <spender@grsecurity.net> and PaX Team <pageexec@freemail.hu> v2
Copyright (C) 2001 - 2006 Tensilica Inc.
Copyright (c) 2012 Hans Verkuil <hverkuil@xs4all.nl>
(C) 2000 IBM Corp. by Fritz Elfert (felfert@millenux.com)
Copyright IBM Corp. 2006, 2008 Author(s): Michael Holzheu <holzheu@de.ibm.com>
Copyright (C) 2009 Wolfson Microelectronics PLC.
Copyright (c) 2015 HGST, a Western Digital Company.
Copyright (C) 2018 PHYTEC Messtechnik GmbH Author: Enrico Scholz <enrico.scholz@sigma-chemnitz.de>
Copyright IBM Corp. 1999, 2012 Author(s): Martin Schwidewsky (schwidewsky@de.ibm.com), Hartmut Penner (hp@de.ibm.com), Denis Joseph Barrow (djbarrow@de.ibm.com,barrow_dj@yahoo.com), Heiko Carstens <heiko.carstens@de.ibm.com>
(C) 2007 www.douglaskthompson.com
Copyright (C) 2015 Juniper Networks, Inc.
Copyright 2017 - Vikas MANOCHA <vikas.manocha@st.com>
Copyright (C) 2001-2002 Hewlett-Packard Co David Mosberger-Tang <davidm@hpl.hp.com>
Copyright (C) 2001-2003 Ivan Martinez <imr@oersted.dtu.dk>
Copyright (C) 2010 - 2013 Johan Hovold (jhovold@gmail.com)
Copyright (c) 2010 Intel Corporation. All rights reserved.
Copyright 2017 Benjamin Herrenschmidt, IBM Corporation
(c) 2004 Simtec Electronics;(c) 2005 Thibaut VARENE <varenet@parisc-linux.org>;(c) 2009 Kristoffer Ericson <kristoffer.ericson@gmail.com>
(c) 1998 Martin Mares <mj@ucw.cz>
(c) 2004 Gerd Knorr <kraxel@bytesex.org> [SUSE Labs]

Copyright (C) 2007,2008 Thomas Bogendoerfer (tsbogend@alpha.franken.de)
(C) 1999 Andrea Arcangeli <andrea@suse.de>
Copyright (C) 2002 - 2012 Paul Mundt
Copyright (C) 2014-2017 aQuantia Corporation.
Copyright (C) 2005-2006 M. Amine SAYA, ATMEL Rousset, France Revision 2005 M. Nicolas Diremdjian, ATMEL Rousset, France Converted to ClockSource/ClockEvents by David Brownell.
Copyright (C) 2015-2016, ARM Ltd
Copyright (C) 2010 Hans Verkuil <hverkuil@xs4all.nl>
Copyright (c) 2013 Samsung Electronics Co., Ltd. Author: Mateusz Krawczuk <m.krawczuk@partner.samsung.com>
Copyright (C) 2006 Compulab, Ltd. Mike Rapoport <mike@compulab.co.il>
Copyright (c) 2018 Amlogic, Inc. All rights reserved. Author: Xingyu Chen <xingyu.chen@amlogic.com> Author: Yixun Lan <yixun.lan@amlogic.com>
Copyright (C) 2001-2005 Russell King
Copyright 2014-2015 Integrated Device Technology, Inc. Alexandre Bounine <alexandre.bounine@idt.com>
Copyright (c) 2003-2004 Fabrice Bellard
Copyright (c) 1989 Regents of the University of California. All rights reserved.
Copyright (c) 2017 United Western Technologies, Corporation
Copyright (C) 2013 Linaro Limited Matt Porter <mporter@linaro.org>
Copyright (C) 2007, 2008 Michael Krufky <mkrufky@linuxtv.org>
Copyright 2008-2011 DENX Software Engineering GmbH Author: Heiko Schocher <hs@denx.de>
Copyright 2000 by Carsten Paeth <calle@calle.de>
Copyright (C) 2018-2019 Renesas Electronics Corp.
Copyright (C) 2011-2015 Cypress Semiconductor, Inc.
Copyright (c) 2016 Red Hat, Inc.
Copyright (C) 2017, STMicroelectronics - All Rights Reserved Author(s): Amelie Delaunay <amelie.delaunay@st.com> for STMicroelectronics.
Copyright IBM Corp. 1999 Author(s): Martin Peschke <mpeschke@de.ibm.com> Martin Schwidewsky <schwidewsky@de.ibm.com>
Copyright (C) 2011-2012 Guennadi Liakhovetski <g.liakhovetski@gmx.de>
Copyright (C) 2004 Hollis Blanchard, IBM Corporation
(C) 2010 Pablo Neira Ayuso <pablo@netfilter.org>
Copyright (C) 1994 - 2003, 06, 07 by Ralf Baechle (ralf@linux-mips.org)
Copyright (c) 2015, 2017 Oracle. All rights reserved.
Copyright (C) 2018 Christoph Hellwig.
Copyright (c) 2004, 2011 Intel Corporation. All rights reserved.
Copyright 2019 NXP YAML 1.2
Copyright (C) 2006, 2019 Texas Instruments.
Copyright 2009, Roderick Colenbrander
Copyright (C) 2011-2012 Hans de Goede <hdegoede@redhat.com>
Copyright 2018, Michael Ellerman, IBM Corp.
Copyright (c) 2018 Dmitry Safonov, Arista Networks
Copyright (c) 2018 Oleksandr Andrushchenko, EPAM Systems Inc.
Copyright (C) 2005 Sven Luther <sl@bplan-gmbh.de> Thanks to : Dale Farnsworth <dale@farnsworth.org> Mark A. Greer <mgreer@mvista.com> Nicolas DET <nd@bplan-gmbh.de> Benjamin Herrenschmidt <benh@kernel.crashing.org> And anyone else who helped me on this.
Copyright © 2018 Intel Corporation.
Copyright (C) 2011 Micron Technology, Inc.
Copyright (C) 2010 Maurus Cuelenaere
Copyright (C) 2007 Steven Rostedt <rstrostedt@redhat.com>
Copyright (c) 2006 Ian Molton
Copyright 2003 mjander mjander@users.sourceforge.org
Copyright (C) 1994, 1995, 1997, 1998, 1999, 2000, 2001, 2002, 2003, 2004, 2005 Free Software Foundation, Inc.
Copyright (C) 2015, 2018 Author: Matt Ranostay <matt.ranostay@konsulko.com>
Copyright (C) 2001, 2008 David S. Miller (davem@davemloft.net)
Copyright (c) 1996-2000 Jonathan A. Buzzard (jonathan@buzzard.org.uk)
Copyright (C) 2016, Linaro Ltd - Daniel Lezcano <daniel.lezcano@linaro.org> define pr_fmt(fmt) "irq_timings: " fmt
Copyright (C) 2008-2009 Avionic Design GmbH

LICENCE TERMS (cont.)

(C) 2005-2006 Red Hat Inc
Copyright 2006 Stefan Roese <sr at denx.de>, DENX Software Engineering
Copyright (c) 2018 Nikolai Kondrashov
Copyright (C) Sam Ravnborg <sam@mars.ravnborg.org>, 2015
Copyright (c) 2017, Linaro Ltd. All rights reserved.
Copyright (C) 2012 Magnus Damm
(c) Copyright 2004 Google Inc.:(c) Copyright 2005 David Härdeman <david@2gen.com>
Copyright (C) 2016 Linaro Ltd. <ard.biesheuvel@linaro.org>
Copyright (C) 2015 Red Hat Inc. Hans de Goede <hdegoede@redhat.com>
(c) Copyright Hewlett-Packard Development Company, L.P., 2006:(c) Copyright Huw Davies <huw@codeweavers.com>, 2015
Copyright (C) 2019 Facebook
(C) 1999-2004 Nemosoft Unv.:(C) 2004-2006 Luc Saillard (luc@saillard.org):(C) 2011 Hans de Goede <hdegoede@redhat.com>
Copyright (c) 1998-1999 Ilario Nardinocchi (nardinoc@CS.UniBO.IT)
Copyright (C) 2006 Nokia Corporation Tony Lindgren <tony@atomide.com>
Copyright (c) 2012 Massachusetts Institute of Technology
Copyright (c) 2014 Takashi Sakamoto
Copyright 2017 Armadeus Systems <support@armadeus.com>
Copyright (c) 2010, Intel Corporation.
Copyright (C) 1994 - 1999, 2000, 03, 04 Ralf Baechle
Copyright (c) 2007 Nokia Siemens Networks - Mikko Herranen <mh1@iki.fi>
Copyright IBM Corp. 1999, 2016 Author(s): Martin Schwidofsky <schwidofsky@de.ibm.com>, Denis Joseph Barrow, Arnd Bergmann,
Copyright (C) 2018 Facebook Author: Yonghong Song <yhs@fb.com>
Copyright (c) 2006 Andrzej Zaborowski <balrog@zabor.org>
Copyright (C) 2009-2012 Texas Instruments, Inc.
Copyright IBM Corp. 2002, 2004
Copyright (C) 2001 Ingo Molnar <mingo@redhat.com>
(C) Copyright 2007 Hewlett-Packard Development Company, L.P.
(c) 2017, Jonathan Corbet <corbet@lwn.net> sayli karnik <karniksayli1995@gmail.com>
Copyright (C) 1996, 1999, 2003, 2006, 2008 David S. Miller (davem@davemloft.net)
"Copyright (C) 2012 ARM Ltd. Authors: Catalin Marinas <catalin.marinas@arm.com> Will Deacon <will.deacon@arm.com>"
Copyright (C) 2012 Sascha Hauer, Pengutronix
Copyright (C) IBM Corporation, 2008-2012 Authors: Srikar Dronamraju Jim Keniston
Copyright Red Hat, 2009
Copyright 2005-2006 Erik Waling
Copyright (c) 2016, Intel Corporation Authors: Salvatore Benedetto <salvatore.benedetto@intel.com>
Copyright (C) 1994-2006 Linus Torvalds
Copyright 2016 Icenowy Zheng <icenowy@aosc.xyz>
(c) Copyright 2005-2013 Datera, Inc.
Copyright (C) 2017 Jagan Teki <jagan@amarulasolutions.com>
Copyright (C) 2001 MontaVista Software, Inc.
Copyright © 2006-2010 Intel Corporation
Copyright (C) 1992 W. Metzenthien, 22 Parker St, Ormond, Vic 3163, | Australia. E-mail billm@vaxc.cc.monash.edu.au |
Copyright (C) 1992,1993 | W. Metzenthien, 22 Parker St, Ormond, Vic 3163, | Australia. E-mail billm@vaxc.cc.monash.edu.au |
Copyright 2008 Cavium Networks Scott Shu
Copyright (C) 2000-2001 John Marvin <jsm at parisc-linux.org>
Copyright (C) 2014 Oleksij Rempel <linux@rempel-privat.de>
Copyright (C) 2015-2017 Glider bvba
Copyright 2012 CirrusLogic, Inc.
Copyright (C) 2005 Wilson Michaels <wilsonmichaels@earthlink.net>
Copyright (C) 2016 Red Hat Inc. All Rights Reserved
Copyright (C) 2007 Ralf Baechle (ralf@linux-mips.org)
Copyright © 2012 Red Hat
Copyright 2018 Marty E. Plummer <hanetzer@startmail.com> */
Copyright (c) 2005 Keir Fraser
Copyright (C) 1998 - 2002 Frodo Looijaard <frodol@dds.nl>, Philip Edelbrock <phil@netroedge.com>, Mark D. Studebaker <mdsxyz123@yahoo.com>
Copyright (C) 2016 Paul Kocialkowski <contact@paulk.fr>
Copyright (c) 2010-2012, NVIDIA Corporation.
Copyright (C) 2009 Yoichi Yuasa <yuasa@linux-mips.org>
Copyright (C) 2016 Oleksij Rempel <linux@rempel-privat.de>
Copyright (c) 2005 Adaptec, Inc. All rights reserved.
Copyright 2018 Linaro Ltd. YAML 1.2
Copyright (C) 2019, Microsoft, Inc.
Copyright (c) 2016 Dmitry Safonov Suggested-by: Andrew Lutomirski
Copyright (c) 2003 Matthias Brukner, Trajet GmbH, Rebenring 33, 38106 Braunschweig, GERMANY
Copyright (c) 2015 Pablo Neira Ayuso <pablo@netfilter.org>
Copyright 2015, Anton Blanchard, IBM Corp.
Copyright (C) 2019 Icenowy Zheng <icenowy@aosc.io>
Copyright (C) 2006 Georg Acher, BayCom GmbH, acher (at) baycom (dot) de for Reel Multimedia
Copyright (C) 2008 <srinivasa.deevi at conexant dot com> Based on em28xx driver Based on cx23885 driver Based on cx88 driver
Copyright (C) 2011 Samsung Electronics http://www.samsung.com/
Copyright (C) 2013 Oracle Inc.
(C) Copyright 1995-2003 by Geert Uytterhoeven <geert@linux-m68k.org>:(C) Copyright 1995 by Geert Uytterhoeven, Peter De Schrijver
Copyright (C) 2012-2014 Intel Corporation. All rights reserved.
Copyright (C) 2013-2014 Google, Inc Simon Glass <sjg@chromium.org>
Copyright (C) 2009 Freescale Semiconductor Inc.
Copyright (C) 1996 Martin von Löwis original #1-checking implemented by tytso.
Copyright 2008 Analog Devices Inc.
Copyright (c) 2012 Linaro Limited.
Copyright (C) 2006 Chris Boot <bootc@bootc.net>
Copyright (c) 2006-2009 VMware, Inc., Palo Alto, CA., USA All Rights Reserved.
Copyright (C) 2000, 2001 Keith M Wesolowski
Copyright (C) 2007 Akamai Technologies, Inc. Shamelessly copied from: Intel D82875P Memory Controller kernel module:(C) 2003 Linux Networx (http://lnxi.com)
Copyright (c) 2009 Michael Buesch <m@buesch.ch>
Copyright (C) 2011 Texas Corporation Felipe Balbi <balbi@ti.com> Santosh Shilimkar <santosh.shilimkar@ti.com> Sricharan <r.sricharan@ti.com>
Copyright (C) 2010 Texas Instruments Incorporated - http://www.ti.com
Copyright (C) 1996, 1997, 2004, 05 by Ralf Baechle (ralf@linux-mips.org)
Copyright (c) 2011, The Linux Foundation. All rights reserved.
Copyright (C) 2004 Chris Kennedy <c@groovy.org>
Copyright (c) 2009, 2014 Intel Corporation.
Copyright (C) 2009 William M. Brack
Copyright 2003-2005 Red Hat, Inc.
Copyright (c) 2011-2013 QLogic Corporation
Copyright (c) 1998, 2000 Harald Koerfgen
Copyright (C) 2014 Marvell Author: Gregory CLEMENT <gregory.clement@free-electrons.com>
Copyright (C) 2010 ST Microelectronics Shiraz Hashim <shiraz.linux.kernel@gmail.com>
Copyright (C) 2003 Geert Uytterhoeven
Copyright (c) 2016, Intel Corporation Authors: Weigang Li <weigang.li@intel.com> Giovanni Cabiddu <giovanni.cabiddu@intel.com>
Copyright (C) 2013-2015 ARM Limited Author: Liviu Dudau <Liviu.Dudau@arm.com>
Copyright (C) 1998-2000 Andre Hedrick <andre@linux-ide.org>
Copyright (C) 2009-2012 Florian Fainelli <florian@openwrt.org>
Copyright (c) 2013 - 2014 Cambridge Silicon Radio Limited, a CSR plc group company.
Copyright (c) 2000-2002 Ghazlane Toumi <gtoumi@laposte.net>:(c) 2000,2002 Ghazlane Toumi <gtoumi@laposte.net>

LICENCE TERMS (cont.)

net>"); MODULE_DESCRIPTION("FBDev driver for 3dfx Voodoo Graphics and Voodoo2 based video boards");
Copyright 1995 David S. Miller (davem@caip.rutgers.edu)
Copyright (c) by 2007 Joachim Foerster <JOFT@gmx.de>
Copyright (C) 2007 Advanced Micro Devices, Inc.
Copyright © 2012 Micron Technology, Inc.
Copyright (C) 2008, 2009, 2010 Marvell Semiconductor Inc.
Copyright (C) 2012 ST Microelectronics Deepak Sikri <deepak.sikri@st.com>
Copyright (C) 2003 Benjamin Herrenschmidt (benh@kernel.crashing.org)
Copyright (c) 2017-2019 Mellanox Technologies. All rights reserved */
Copyright (c) 2013 Lubomir Rintel All rights reserved.
Copyright 2000-2002 Jeff Garzik
Copyright (C) 2013 Samsung Electronics Co., Ltd. Tomasz Figa <t.figa@samsung.com>
Copyright (C) 2015 Microchip Technology, Inc. All rights reserved.
Copyright 2006-2012 Solarflare Communications Inc.
"Copyright (C) 2003-2004 by Jan-Benedict Glaw <jbglaw@lug-owl.de>;(C) 2001 by Karsten Merker <merker@linuxtag.org> and Maciej W. Rozycki <macro@ds2.pg.gda.pl> Later on, I had access to the device's documentation (referenced below)."
Copyright (C) 2016-2017 Istituto Italiano di Tecnologia - RBCS - EDL Robotics, Brain and Cognitive Sciences department Electronic Design Laboratory
Copyright (C) 2000, 2001, 2002 Jeff Dike (jdike@karaya.com)
Copyright (C) 1994, 95, 96, 99, 2001 Ralf Baechle
Copyright (C) 2008, cozybit Inc.
Copyright (C) 2003 - 2009 Paul Mundt
Copyright 2009, 2010 Wolfson Microelectronics. PLC.
Copyright (C) 2010 Novell. All rights reserved.
Copyright 2014 Google, Inc.
Copyright (C) 2004 Takashi Iwai <tiwai@suse.de>
Copyright (C) 2011 DENX Software Engineering GmbH Heiko Schocher <hs@denx.de>
Copyright (C) 2019 Ondřej Jirman <megous@megous.com>
Copyright (c) 2019 Facebook include <linux/bpf.h> include "bpf_helpers.h" define ATTR__attribute__((noinline)) include "test_jhash.h"
Copyright (c) 2018-2019 Hisilicon Limited.
Copyright (c) 2007, Intel Corporation.
Copyright (C) 2001, 2002 Ralf Baechle
Copyright (c) 2006-2007 Ondrej Zajicek <santiago@crfreenet.org>;(c) 2006-2007 Ondrej Zajicek <santiago@crfreenet.org>); MODULE_DESCRIPTION("fbdev driver for S3 Trio/Virge");
Copyright 2013 CompuLab Ltd.
(C) 2005 Finn Thain;(C) 1996,1998 by Thomas Bogendoerfer (tsbogend@alpha.franken.de);(C) 1995 by Andreas Busse (andy@waldorf-gmbh.de)
Copyright (c) 2019 Vitaly Chikunov <vt@altlinux.org>
Copyright (C) 2000 Greg Banks, Mitch Davis C API to interface to the standard LinuxSH BIOS usually from within the early stages of kernel boot.
Copyright (C) 2003-2005 Ben. Herrenschmidt (benh@kernel.crashing.org)
Copyright 2017, Michael Ellerman, IBM Corporation.
Copyright 2007 IBM Corporation.
Copyright (C) 2013-2017 Oracle Corporation This file is based on ast_mode.c
(C) Neil Horman <nhorman@tuxdriver.com>
Copyright (c) 2011 by Jarod Wilson <jarod@redhat.com>
Copyright (c) 2016 BayLibre, SAS. Author: Neil Armstrong <narmstrong@baylibre.com>
Copyright (C) 2015 Jakub Kicinski <kubakici@wp.pl>
Copyright (C) 2007 Eugene Konev <ejka@openwrt.org>
Copyright (C) 2009-2010 Florian Fainelli <florian@openwrt.org>
Copyright (C) 1997 Martin Mares <mj@atrey.karlin.mff.cuni.cz>
Copyright (C) 2008 Jiri Hladky <hladky_dot_jiri_at_gmail_dot_com>
Copyright (C) 2005, 2007, 2008, 2009 Maciej W. Rozycki
Copyright (C) 2006 Ralf Baechle (ralf@linux-mips.org)
Copyright (C) 2008, 2009 Cavium Networks, Inc.

Copyright (C) 2011 MIPS Technologies, Inc.
Copyright (C) 2008 Florian Fainelli <florian@openwrt.org>
Copyright (C) 2012 Jonas Gorski <jonas.gorski@gmail.com>
Copyright (C) 2006 Benjamin Herrenschmidt, IBM Corporation
Copyright (C) 2016 Felix Fietkau <nbd@nbd.name>
Copyright (C) 2001 Hewlett-Packard (Grant Grundler)
Copyright 2019 NXP
Copyright 2012 Red Hat Inc. Authors: Dave Airlie <airlied@redhat.com> Michael Thayer <michael.thayer@oracle.com>, Hans de Goede <hdegoede@redhat.com>
Copyright (C) 2003, 2004 Ralf Baechle
Copyright (C) 2004 Maciej W. Rozycki
Copyright (c) 2007 Michel Ludwig <michel.ludwig@gmail.com> Fix SMBus Read Byte command
Copyright (C) 2004 by Daniel Ritz
Copyright (C) by Todd E. Johnson (mtouchusb.c)
Copyright (C) 2008-2010 Gabor Juhos <juhosg@openwrt.org>
Copyright (C) 2008 Imre Kaloz <kaloz@openwrt.org>
Copyright (C) 2005, 2007 Maciej W. Rozycki
Copyright (C) 2012, 2013 MIPS Technologies, Inc. All rights reserved.
Copyright (C) 2011 National Semiconductor
Copyright (C) 2015 QWERTY Embedded Design
Copyright (C) 2015 EMAC Inc.
Copyright (C) 1999 Asit Mallick <asit.k.mallick@intel.com>
Copyright (C) 1999 Don Dugger <don.dugger@intel.com>
Copyright 2007 Nuova Systems, Inc. All rights reserved.
Copyright (C) 2000, 2001, 2002 Andi Kleen SuSE Labs
Copyright: 2016 Barix AG Author: Petr Kulhavy <petr@barix.com>
Copyright (C) 2005 Patrick Boettcher <patrick.boettcher@posteo.de>
Copyright 2009 Pengutronix, Sascha Hauer <s.hauer@pengutronix.de>
Copyright (c) 2000-2001 ConnectCom Solutions, Inc.
Copyright (c) 2007 Matthew Wilcox <matthew@wil.cx>
Copyright (c) 2014 Hannes Reinecke <hare@suse.de> All Rights Reserved.
Copyright (c) 2008 Alistair John Strachan <alistair@devzero.co.uk>
Copyright (C) 1999 by Ralf Baechle
Copyright (C) 2002 ARM Ltd. All Rights Reserved
Copyright(c) Copyright 2003 Red Hat Inc <jgarzik@redhat.com>
Copyright(c) Copyright 2001 Red Hat Inc
Copyright 2000,2001 Jeff Garzik <jgarzik@pobox.com>
Copyright 2000,2001 Philipp Rumpf <prumpf@mandrakesoft.com>
Copyright (C) 1999-2000 Takashi Iwai <tiwai@suse.de>
Copyright (C) 2005-2010 Jean Delvare <jdelvare@suse.de>
Copyright (c) 2005 Herbert Xu <herbert@gondor.apana.org.au>
Copyright (c) 2018-2019, The Linux Foundation. All rights reserved.
Copyright (C) 2014 - 2020 Vivante Corporation
Copyright (C) 2005 Thomas Kaiser thomas@kaiser-linux.li
Copyright (C) 2009-2010 Márton Németh <nm127@freemail.hu>
Copyright (c) 2007 Freescale Semiconductor, Inc.
Copyright (c) 1999-2001 Motorola, Inc.
Copyright (c) 2001-2002 International Business Machines, Corp.
Copyright (c) 2001 Intel Corp.
Copyright (c) 2001 Nokia, Inc.
Copyright (c) 2001 La Monte H.P. Yarroll
Copyright (C) 2016 Michael Heimpold <mhei@heimpold.de>
Copyright (C) 2006 Atmark Techno, Inc.
Copyright (c) 2015 Ben Dooks <ben.dooks@codethink.co.uk> for Codethink Ltd Based on origin by Carlo Caione <carlo@endlessm.com>
Copyright (C) 2005 Nokia Corporation Author: Juha Yrjölä <juha.yrjola@nokia.com>
Copyright (C) 2012 Intel, Inc.

LICENCE TERMS (cont.)

Copyright (C) 2013 Intel, Inc. Author: Mike Lockwood <lockwood@android.com>
Copyright (C) 2001, 2002 M. R. Brown
Copyright (C) 2010 Texas Instruments, Inc.
copyright you can redistribute it and/or modify it under the terms of version 2 of the GNU General Public License as published by the Free Software Foundation.
Copyright(c) 2014 Intel Corporation. Redistribution and use in source and binary forms, with or without modification, are permitted provided that the following conditions are met:
COPYRIGHT you can redistribute it and/or modify it under the terms of version 2 of the GNU General Public License as published by the Free Software Foundation.
Copyright you can redistribute it and/or modify it under the terms of version 2 of the GNU General Public License as published by the Free Software Foundation.
Copyright (C) 2008 Juergen Beisert
Copyright: (C) 2012 Gilles Muller, INRIA/LIP6. URL: <http://coccinelle.lip6.fr/> Comments:
Copyright (c) 2014, I2SE GmbH
Copyright (C) 2000 Kazumoto Kojima
Copyright (C) 2003 Takashi Kusuda <kusuda-takashi@hitachi-ul.co.jp>
Copyright (C) 2006 Paul Mundt
Copyright (C) 2002 Mark D. Studebaker <mdsxyz123@yahoo.com>
Copyright (C) 2004 Jean Delvare <jdelvare@suse.de>
Copyright (c) 2009 Promwad Innovation Company Yauhen Kharuzhy <yauhen.kharuzhy@promwad.com>
Copyright (C) 2012 Marek Vasut <marex@denx.de> on behalf of DENX Software Engineering GmbH
Copyright (C) 2013-2015 Lantiq Beteiligungs-GmbH & Co.KG
Copyright (C) 2012 - NVIDIA, Inc.
Copyright (C) 2014-2017 Cogent Embedded, Inc.
Copyright (c) 2009 MontaVista Software, Inc.
Copyright (C) 2007 MontaVista Software, Inc.
Copyright (C) 2018 Paul Kocialkowski <paul.kocialkowski@bootlin.com>
Copyright (C) 2018 Bootlin
Copyright (c) 2009-2010 Samsung Electronics Co., Ltd. Pawel Osciak, <pawel@osciak.com> Marek Szyprowski, <m.szyprowski@samsung.com>
Copyright (c) 2011, Javier Lopez <jlopez@gmail.com>
Copyright (c) 2016 - 2017 Intel Deutschland GmbH
Copyright (C) 2018 Intel Corporation
Copyright (C) 2004 Daniel Mack <daniel@qanu.de> and Holger Waechter <holger@qanu.de>
Copyright © 2004 Micron Technology Inc.
Copyright © 2004 David Brownell
Copyright (C) 2013-2014 Renesas Solutions Corp.
Copyright (C) 2014 Cogent Embedded, Inc.
Copyright(c) 2010 Larry Finger. All rights reserved.
Copyright (C) 2004 Alan Modra (amodra@au.ibm.com), IBM Corp.
Copyright (c) 2001, 2003, 2005, 2006, 2018 Maciej W. Rozycki
Copyright (c) 2005 James Simmons
Copyright (C) 1999-2000 David Mosberger-Tang <davidm@hpl.hp.com>
Copyright (C) 1999 Geert Uytterhoeven
Copyright (C) 2003-2013 Jozsef Kadlec <kadlec@netfilter.org>
Copyright (C) 2003-2005 MontaVista Software, Inc.
Copyright (C) 2008 Novell, Inc.
Copyright (C) 2008 Greg Kroah-Hartman <gregkh@suse.de>
Copyright (C) 2018 IVI Foundation, Inc.
Copyright (c) 2011-2012 Qualcomm Atheros, Inc.
Copyright (C) 2000 Deep Blue Solutions Ltd. hacked for non-paged-MM by Hyok S. Choi, 2003.
Copyright (C) 2005 Luben Tuikov <luben_tuikov@adaptec.com>
Copyright (C) 1999, 2000 Jakub Jelinek (jakub@redhat.com)
Copyright (C) 2016 Red Hat Author: Rob Clark <robdclark@gmail.com>
Copyright (C) 1999 Silicon Integrated Systems, Inc.
Copyright(c) 1998 Gerd Knorr <kraxel@goldbach.in-berlin.de>
Copyright (C) 2001-2005 Thomas Winischhofer/n

Copyright (C) 2017 NXP
Copyright (c) 1999-2000 Cisco, Inc.
Copyright (C) 2012-2013 Allwinner Ltd.
Copyright(c) 2005 - 2014 Intel Corporation. All rights reserved. All rights reserved.
Copyright (C) 1999 Precision Insight, Inc.
Copyright (C) 1999 Xi Graphics, Inc.
Copyright (C) 2008 Matthias Schwarzott <zzam@gentoo.org>
Copyright 2007 Sony Corp.
Copyright(c) 2013 - 2015 Intel Mobile Communications GmbH
Copyright(c) 2016 - 2017 Intel Deutschland GmbH
Copyright(c) 2012 - 2014 Intel Corporation. All rights reserved.
Copyright(c) 2016 - 2017 Intel Deutschland GmbH All rights reserved.
Copyright (C) 2015 Microchip Technology Inc. All rights reserved.
Copyright (C) MIPS Technologies, Inc. written by Ralf Baechle <ralf@linux-mips.org>
Copyright 2008 Emerson
Copyright 2008 GE Intelligent Platforms Embedded Systems, Inc.
Copyright (c) 2003-2007 Network Appliance, Inc. All rights reserved.
Copyright 2012 Free Electrons
Copyright (C) 2001, 2002, 2003 by Liam Davies (ldavies@agile.tv)
Copyright (c) 2014 QLogic Corporation All rights reserved
Copyright (C) 1999 VA Linux Systems
Copyright (C) 1999 Walt Drummond <drummond@valinux.com>
Copyright (c) 2006-2008 Nick Kossifidis <mickflemm@gmail.com>
Copyright (c) 2007-2008 Luis Rodriguez <mcgrof@winlab.rutgers.edu>
Copyright (c) 2007-2008 Pavel Roskin <proski@gnu.org>
Copyright (c) 2007-2008 Jiri Slaby <jirislaby@gmail.com>
Copyright(c) 2005-2011 by Mauro Carvalho Chehab Added support for a separate Radio tuner Major rework and cleanups at the code
Copyright (c) 2013 Red Hat, Inc. All Rights Reserved.
Copyright (C) 2012 ARM Ltd.
Copyright (C) 2014 Regents of the University of California
Copyright (c) 2019 Christian Hewitt <christianshewitt@gmail.com>
Copyright (C) 2003 Matjaz Breskvar <phoenix@bsemi.com>
Copyright (C) 2010-2011 Jonas Bonn <jonas@southpole.se> et al.
Copyright (C) 1997-1999 Jakub Jelinek (jj@sunsite.mff.cuni.cz)
Copyright (C) 2004 Advanced Micro Devices, Inc.
Copyright (C) 2012 - Virtual Open Systems and Columbia University Author: Christoffer Dall <c.dall@virtualopensystems.com>
Copyright (C) 2010,2013, NVIDIA Corporation
Copyright 2006 Marcin Juskiewicz openembedded@hrw.one.pl>
Copyright (C) 1999 David A. Hinds. All Rights Reserved.
Copyright (c) 2005 Enrik Berkhan <Enrik.Berkhan@akk.org>
Copyright (c) 2001,2002 Christer Weinigel <wingel@nano-system.com>
Copyright(c) 2018 - 2019 Intel Corporation
Copyright(c) 2003 - 2014 Intel Corporation. All rights reserved.
Copyright(c) 2018 - 2019 Intel Corporation All rights reserved.
Copyright (C) 2000-2002 Andre Hedrick <andre@linux-ide.org>
Copyright (C) 2001-2002 Klaus Smolin IBM Storage Technology Division
Copyright (C) 2003-2004, 2007 Bartłomiej Zolnierkiewicz
Copyright (C) 2004-2006 Silicon Graphics, Inc.
Copyright Rusty Russell IBM Corporation 2007.
Copyright (C) 2005 Phil Chang <pchang23@sbcbglobal.net>
Copyright (C) 2006 James Painter <jamie.painter@iname.com>
Copyright (c) 2002-2003 TiVo Inc.
Copyright (C) 2006-2007 Till Harbaum (Till@Harbaum.org)
Copyright (C) 2017 Cogent Embedded, Inc.
Copyright (C) 2004-2016 Emulex. All rights reserved. * EMULEX and SLI are trademarks of Emulex. * www.

broadcom.com *
Copyright (C) 2004-2005 Christoph Hellwig *
Copyright (C) 2005 by MIPS Technologies, Inc.
Copyright (C) 2012 National Instruments Corp.
Copyright (C) 2007 Nobuhiro Iwamatsu
Copyright 2014-2015 Linaro Ltd.
Copyright (C) 2012 John Crispin <john@phrozen.org>
Copyright (C) 2017 - 2019 Hauke Mehrtens <hauke@hauke-m.de>
Copyright (C) 2004, 2010-2011 Red Hat, Inc. All rights reserved.
Copyright 2017-2019 Qiang Yu <yuq825@gmail.com>
Copyright (C) 2008-2010, 2012 Texas Instruments, Inc. Paul Walmsley Rajendra Nayak <rnyak@ti.com>
Copyright (c) 2001-2002, 2007 Johann Deneux <johann.deneux@gmail.com>
Copyright 2008 Ben Dooks <ben-linux@fluff.org>
Copyright 2009 Simtec Electronics <linux@simtec.co.uk>
Copyright (c) 1987-1999 Carnegie Mellon University All Rights Reserved
Copyright 1993 by OpenVision Technologies, Inc.
Copyright(c) 2015 Intel Corporation.
Copyright(C) Copyright 2000-2002 David Brownell <dbrownell@users.sourceforge.net>
Copyright(C) Copyright 2002 Hewlett-Packard Company
Copyright (C) 2004 Simtec Electronics
Copyright (C) 1994 - 1999 by Ralf Baechle Modified for R3000 by Paul M. Antoine, 1995, 1996 Complete output from die() by Ulf Carlsson, 1998
Copyright (C) 1999 Silicon Graphics, Inc.
Copyright (C) 2001 - 2013 Tensilica Inc.
Copyright 1992--1999 Drew Eckhardt, Frederic Potter, David Mosberger-Tang, Martin Mares
Copyright 2002-2007 H. Peter Anvin
Copyright (C) 2002 Marcel Holtmann <marcel@holtmann.org>
Copyright (C) 2007 Sascha Hauer, Marc Kleine-Budde, Pengutronix <s.hauer@pengutronix.de> Simon Kallweit, intefo AG <simon.kallweit@intefo.ch>
Copyright(C) 2007 by Hans J. Koch <hjk@hansjkoeh.de>
Copyright(C) 2008, 2009 by Marc Kleine-Budde <kernel@pengutronix.de>
Copyright (c) 2018, The Linux Foundation. All rights reserved.
Copyright (C) 2001, 2002 Paul Diefenbaugh <paul.s.diefenbaugh@intel.com>
Copyright (C) 2002 - 2004 Dominik Brodowski <linux@brodo.de>
Copyright (C) 2006 Denis Sadykov <denis.m.sadykov@intel.com>
Copyright © 2006-2007 Advanced Micro Devices, Inc.
Copyright © 2009 VIA Technology, Inc.
Copyright (c) 2010 Andres Salomon <dilinger@queued.net>
Copyright 2012 Freescale Semiconductor, Inc.
Copyright 2011 Linaro Ltd.
Copyright (c) 2016 BayLibre, Inc. Author: Kevin Hilman <khilman@kernel.org>
Copyright (C) 2002 by Ron Minnich <rminnich@lanl.gov>
Copyright (C) 2009 Lemote, Inc. Author: Wu Zhangjin, wuzhangjin@gmail.com
Copyright (C) 2009 Wind River Systems Inc Implemented by fredrik.markstrom@gmail.com and ivarholmqvist@gmail.com
Copyright (C) 2004 Microtronix Datacom Ltd.
Copyright (C) 2004 Karen Spearel
Copyright (C) 2008 Michael H. Schimek <mschimek@gmx.at>
Copyright (c) 2005 ASPEED Technology Inc.
Copyright (C) 2014 Wolfram Sang, Sang Engineering <wsa@sang-engineering.com>
Copyright (C) 2012 Freescale Semiconductor, Inc.
Copyright (C) 2012 Linaro Ltd.
Copyright (C) 1999 David A. Hinds
Copyright (C) 2004-2010 Dominik Brodowski
Copyright (C) 2011 matt mooney <mfm@muteddisk.com> 2005-2007 Takahiro Hirofuchi
Copyright (c) 2016 Michael Shych <michaels@mellanox.com>
Copyright: (C) 2009-2010 Gilles Muller, INRIA/LiP6.

Copyright: (C) 2017 Himanshu Jha URL: <http://coccinelle.lip6.fr/rules/kzalloc.html>
Copyright (C) 2003, 2004 SuperH, Inc.
Copyright (C) 2004, 2005 Paul Mundt
Copyright (c) Andrew McDonald <andrew@mcdonald.org.uk>
Copyright (c) 2002 James Morris <jmorris@intercode.com.au>
Copyright 2007 Intel Corporation <jonathan.lynch@intel.com>
Copyright (c) 2018 Linaro Ltd. Author: Manivannan Sadhasivam <manivannan.sadhasivam@linaro.org>
Copyright 2012 Linaro Ltd.
Copyright (C) 2014 Chen-Yu Tsai <wens@csie.org>
Copyright (C) 2014 Maxime Ripard <maxime.ripard@free-electrons.com>
Copyright (c) 2013-2014 Hisilicon Limited.
Copyright 2001-2008 S3 Graphics, Inc. All Rights Reserved.
Copyright (c) 2015 Lukas Wunner <lukas@wunner.de>
Copyright (C) 2001-2002 Alcôve <www.alcove.com>
Copyright (C) 2000 Andrew Tridgell <tridge@valinux.com>
Copyright (C) 1997,1998 Jakub Jelinek (jj@ultra.linux.cz)
Copyright 2007 rPath, Inc. - All Rights Reserved
Copyright (c) 2005 Cisco Systems. All rights reserved.
Copyright (c) 2005 Mellanox Technologies. All rights reserved.
Copyright (C) 2009 Sascha Hauer, Pengutronix
Copyright 2009 Sascha Hauer <s.hauer@pengutronix.de>
Copyright (C) 2011 Freescale Semiconductor, Inc.
Copyright (C) 2006 Lennert Buytenhek <buytenh@wantstofly.org>
Copyright (C) 2006 Applied Data Systems
Copyright (C) 2017 Zhi Mao <zhi.mao@mediatek.com>
Copyright (C) 2016-2017 Glider bvba
Copyright (c) 2006 Tejun Heo <teheo@suse.de>
Copyright (C) 2012 Javier Martinez Canillas <javier@dowhile0.org>
Copyright (C) 2010 Politecnico di Torino, Italy TORSEC group -- <http://security.polito.it>
Copyright (C) 2004-2006 Red Hat, Inc. All rights reserved.
Copyright (c) 2002 ARM Limited.
Copyright (C) 2000-2003 Paul Bame <bame at parisc-linux.org>
Copyright (C) 2001 Thomas Bogendoerfer <tsbogend at parisc-linux.org>
Copyright (C) 1999-2014 Helge Deller <deller@gmx.de>
Copyright 2016 Linaro Ltd.
Copyright (C) 2003 - 2008 Paul Mundt
Copyright (C) 1999, 2000 Kaz Kojima & Niibe Yutaka
Copyright (C) 2008 by Nokia Corporation
Copyright (C) 2009 Wind River Systems Inc Implemented by fredrik.markstrom@gmail.com and ivarholmqvist@gmail.com
Copyright (c) 2005-2007 Vladimir Lebedev <vladimir.p.lebedev@intel.com>
Copyright (c) 2005 Rich Townsend <rhd@bartol.udel.edu>
Copyright (C) 2018 Diego Rondini <diego.rondini@kynetics.com>
Copyright (C) 2016 NextThing Co
Copyright (C) SAN People
Copyright (c) 2003, 2004 Jeff Garzik <jgarzik@pobox.com>
Copyright (c) 2003, 2004, 2005 Francois Romieu <romieu@fr.zoreil.com>
Copyright (C) 2004 Pekka Pietikainen (pp@ee.oulu.fi)
Copyright (C) 2004 Florian Schirmer (jolt@tuxbox.org)
Copyright (C) 2006 Felix Fietkau (nbd@openwrt.org)
Copyright (C) 2006 Broadcom Corporation.
Copyright (C) 2007 Michael Buesch <m@bues.ch>
Copyright (C) 2013 Hauke Mehrtens <hauke@hauke-m.de>
Copyright (c) 2007 Ujjwal Pande <ujjwal@kenati.com>, Kenati Technologies Pvt Ltd.
Copyright (C) 2015 Linaro Ltd. Author: Jassi Brar <jaswinder.singh@linaro.org>
Copyright (C) 2018 Linaro Ltd.
Copyright (C) 2008 Andy Walls <awalls@md.metrocast.net>

LICENCE TERMS (cont.)

Copyright (C) 2009 Alban Browaeys <prahal@yahoo.com>
Copyright (C) 2009 Felix Fietkau <nbd@openwrt.org>
Copyright (C) 2009 Luis Correia <luis.f.correia@gmail.com>
Copyright (C) 2009 Mattias Nissler <mattias.nissler@gmx.de>
Copyright (C) 2009 Mark Asselstine <asselsm@gmail.com>
Copyright (C) 2009 Xose Vazquez Perez <xose.vazquez@gmail.com>
Copyright (C) 2009 Bart Zolnierkiewicz <bzolnier@gmail.com> <http://rt2x00.serialmonkey.com>
Copyright 2018 David Lechner <david@lechnology.com>
Copyright 2016 Noralf Trønnes
Copyright (C) 2015 Adafruit Industries
Copyright (C) 2013 Christian Vogelgsang
Copyright (C) 2012 ARM Ltd. Author: Catalin Marinus <catalin.marinus@arm.com>
Copyright (C) 2011 Steffen Klassert <steffen.klassert@secunet.com>
Copyright 2007 MontaVista Software, Inc.
Copyright (c) 2016, EPAM Systems
Copyright (C) 1999, 2000 Silicon Graphics, Inc.
Copyright (C) 2004 Chris Kennedy <c@groovy.org>
Copyright (C) 2005-2007 Hans Verkuil <hverkuil@xs4all.nl>
Copyright(c) 2005 - 2014 Intel Corporation. All rights reserved.
Copyright (C) 2014 Hannes Reinecke <hare@suse.de>
Copyright 2015 Linaro Ltd.
Copyright (C) 2005-2006 by Texas Instruments
Copyright (C) 2006-2007 Nokia Corporation
Copyright (c) 2001 Dave Engebretsen
Copyright (C) 2002 Anton Blanchard <anton@au.ibm.com>, IBM
Copyright (C) 2017 Chris Brandt
Copyright (c) 2017 Beckhoff Automation GmbH & Co. KG
Copyright (C) STMicroelectronics SA 2017 Authors: Maxime Coquelin <mcoquelin.stm32@gmail.com> Gerald Baeza <gerald_baeza@yahoo.fr>
Copyright (c) Alan Smithee.
Copyright (c) Jean-Francois Dive <jef@linuxbe.org>
Copyright (c) Mathias Krause <minipli@googlemail.com>
Copyright (c) Chandramouli Narayanan <mouli@linux.intel.com>
Copyright (C) 2006 Kyle McMartin <kyle@parisc-linux.org>
Copyright 2017-2018 NXP
Copyright (C) 2012 Antti Palosaari <crope@iki.fi>
Copyright (C) 2000 Richard Hirst <rhirst with parisc-linux.org>
Copyright (C) 2001 Matthieu Delahaye <delahaym at esiee.fr>
Copyright (C) 2003 Randolph Chung <tausq with parisc-linux.org>
Copyright (C) 2017 Helge Deller <deller@gmx.de>
Copyright (C) 2017 John David Anglin <dave.anglin@bell.net>
Copyright (C) 2006-07 Tower Technologies Author: Alessandro Zummo <a.zummo@towertech.it>
Copyright (C) 2008 Imre Kaloz <kaloz@openwrt.org>
Copyright (C) 2013 John Crispin <john@phrozen.org>
Copyright (c) 2003, 2004, 2005, 2006 PathScale, Inc. All rights reserved.
Copyright (C) 2010 Samsung Electronics Co. Ltd. Jaswinder Singh <jassi.brar@samsung.com>
Copyright 2008 Ian Kent <raven@themaw.net>
Copyright (c) 2004-2008 Ben Dooks
Copyright (C) 2014 SUSE
Copyright (C) 1996,1997 Jakub Jelinek (jj@sunsite.mff.cuni.cz)
Copyright (C) 2004 - 2009 Ivo van Doorn <lvdoorn@gmail.com>
Copyright (c) 2013 by Robin Gareus <robin at gareus.org>
Copyright (c) 2002 by Takashi Iwai <tiwai at suse.de>
Copyright (c) 2014 by Chris J Arges <chris.j.arges at canonical.com>
Copyright (C) 2004-2005 Yoichi Yuasa <yuasa@linux-mips.org>
Copyright 2017 NXP
Copyright (C) 2014 Maxime Ripard

Copyright (C) 2011 Freescale Semiconductor, Inc. All Rights Reserved
Copyright (C) 2009-2010 Motorola, Inc.
Copyright (C) 2007-2008 Steven Rostedt <ststedt@redhat.com>
Copyright (c) 2014 Red Hat, Inc., Mark Salter <msalter@redhat.com>
Copyright (C) 2014 NetUP Inc.
Copyright (C) 2014 Sergey Kozlov <serjk@netup.ru>
Copyright (C) 2014 Abylay Ospan <aospan@netup.ru>
Copyright (C) 2004 Ulf Eklund <ivtv at eklund.to>
Copyright (C) 2005 Hans Verkuil <hverkuil@xs4all.nl>
Copyright (C) 1996 Jay A Estabrook
Copyright (C) 1998, 1999 Richard Henderson
Copyright 1993 United States Government as represented by the Director, National Security Agency. This software may only be used and distributed according to the terms of the GNU General Public License as modified by SRC, incorporated herein by reference.
Copyright (C) 2005 - 2008 Jean Delvare <jdelvare@suse.de>
Copyright 2011 Analog Devices Inc
Copyright 2012 CS Systemes d'Information
Copyright (C) 2013 Texas Instruments Incorporated - <http://www.ti.com/> Nishanth Menon
Copyright (c) 2006, 2007 IBM Corp. Josh Boyer <jwboyer@linux.vnet.ibm.com>, David Gibson <dwg@au1.ibm.com>
Copyright 2000 VA Linux Systems, Inc., Sunnyvale, California.
Copyright (c) 2009-2010, Code Aurora Forum. All rights reserved.
Copyright (C) 2008-2009 PetaLogix
Copyright (C) 2003 John Williams <jwilliams@itee.uq.edu.au>
"Copyright (C) 2001,2002 NEC Corporation"
"Copyright (C) 2001,2002 Miles Bader <miles@gnu.org> "
Copyright (C) 2010,2011 Igor M. Liplianin <liplianin@netup.ru>
Copyright (C) 2003 - 2007 Jeff Dike (jdike@{addtoit,linux.intel}.com) Licensed under the GPL
Copyright (C) 2008-2009 Avionic Design GmbH
Copyright (C) 2011-2015 Freescale Semiconductor, Inc. Based on max8903_charger.h
Copyright 2009-2010 Canonical Ltd.
Copyright (C) 2001 IBM
Copyright (C) 1997,1998 Jakub Jelinek (jj@sunsite.mff.cuni.cz)
Copyright (C) 1997 David S. Miller (davem@caip.rutgers.edu)
Copyright (C) 1991, 1992 Linus Torvalds 1997-11-28 Modified for POSIX.1b signals by Richard Henderson
Copyright (C) 2017 Linaro Ltd.
Copyright (C) 2009 Hewlett-Packard Development Company, L.P.
Copyright (c) 2005 Stefano Brivio <stefano.brivio@polimi.it>
Copyright (c) 2005-2007 Michael Buesch <m@bues.ch>
Copyright (c) 2005 Danny van Dyk <kugelfang@gentoo.org>
Copyright (c) 2005 Andreas Jaggi <andreas.jaggi@waterwave.ch>
Copyright 1997 Linus Torvalds
Copyright 2002 Andi Kleen <ak@suse.de>
Copyright (C) 2005 Torsten Koschorrek <koschorrek at synertronixx.de>
Copyright (C) 2005 Matthias Blaschke <blaschke at synertronixx.de>
Copyright (C) 2007 RightHand Technologies, Inc.
Copyright (C) 2008 Darius Augulis <darius.augulis at teltonika.lt>
Copyright 2013 Freescale Semiconductor, Inc.
Copyright (C) 2003 MontaVista, Software, Inc.
Copyright 2016 Freescale Semiconductor, Inc.
Copyright (c) 2014 Samsung Electronics Co., Ltd.
Copyright (C) 2015 Linaro Ltd.
Copyright 2017 Linaro Ltd.
Copyright 2008 Red Hat Inc.
Copyright 2009 Jerome Glisse.
Copyright 2008 Simtec Electronics Ben Dooks <ben@simtec.co.uk> <http://armlinux.simtec.co.uk/>
Copyright 2009 Kwangwoo Lee Kwangwoo Lee <kwangwoo.lee@gmail.com>
Copyright (c) 2005-2008, 2011-2013, Wind River Systems All rights reserved.

LICENCE TERMS (cont.)

Copyright (C) IBM Corporation, 2009
Copyright (C) 2009, Frederic Weisbecker <fweisbec@gmail.com>
Copyright (C) 2005 Nguyen Anh Quynh <aquynh@gmail.com>
Copyright (C) 2005 Guillaume Thouvenin <guillaume.thouvenin@bull.net>
Copyright 2009-2017 Canonical Ltd.
Copyright (c) 2016, NVIDIA CORPORATION. All rights reserved. Author: Neo Jia <cjia@nvidia.com> Kirti Wankhede <kwankhede@nvidia.com>
Copyright (c) 2016 Maxime Ripard. All rights reserved.
Copyright (C) 2013 Kuninori Morimoto <kuninori.morimoto.gx@renesas.com>
Copyright (C) 2013 Cogent Embedded, Inc.
Copyright (C) 2005 XenSource Ltd.
Copyright (c) 2019 Advantech Author: Amy Shih <amy.shih@advantech.com.tw>
Copyright (c) 2007 Eric Biederman (ebiederm@xmission.com)
Copyright (c) 2007 Vivek Goyal (vgoyal@in.ibm.com)
Copyright (c) 2010 Kees Cook (kees.cook@canonical.com)
Copyright: (C) 2012 Gilles Muller, INRIA/LiP6. URL: <http://coccinelle.lip6.fr/> Comments:
Copyright (C) 2013 Eduardo Valentin <eduardo.valentin@ti.com>
Copyright (C) 1999 Silicon Graphics, Inc.
Copyright (C) 2015 Intel Corporation
Copyright 2012 Laurent Cans <laurent.cans@gmail.com>
Copyright 2011 Freescale Semiconductor, Inc.
Copyright (C) 2012 Roland Stigge
Copyright 2007 Andrea Merello <andrea.merello@gmail.com>
Copyright 2005 Andrea Merello <andrea.merello@gmail.com>, et al.
Copyright (c) 2017-19 David Ahern <dsa@cumulusnetworks.com>
Copyright (C) 2011 Johan Hovold <jhovold@gmail.com>
Copyright (C) 2011 Tobias Klauser <tklauser@distanz.ch>
Copyright (C) 2008 Thomas Chou <thomas@wytron.com.tw>
Copyright (C) 2007 Greg Ungerer <gerg@snapgear.com>
Copyright (C) 2004 Rick Bronson Converted to 2.6 by Andrew Victor <andrew@sanpeople.com>
Copyright (C) 2000 Philip Edelbrock <phil@stimpynet.roedge.com>
Copyright (C) 1998 Kenneth Albanowski <kjahds@kjahds.com> The Silver Hammer Group, Ltd.
Copyright (C) 2006 Paul Mundt
Copyright (C) 2007 Magnus Damm
Copyright (C) 2000 Deep Blue Solutions Ltd
Copyright 2006-2007,2010 Freescale Semiconductor, Inc. All Rights Reserved.
Copyright 2008 Juergen Beisert, kernel@pengutronix.de
Copyright 2009 Ilya Yanok, Emcraft Systems Ltd, yanok@emcraft.com
Copyright (C) 2011 Wolfram Sang, Pengutronix e.K.
Copyright (c) 2013 Samsung Electronics Co., Ltd. <http://www.samsung.com> Author: Andrzej Pietrasiewicz <andrzejtp2010@gmail.com>
Copyright 2010-2012 Freescale Semiconductor, Inc.
Copyright (c) 2011, Code Aurora Forum. All rights reserved.
Copyright 2013 Analog Devices Inc.
Copyright (C) 2000 Russell King
Copyright (c) 2017 Samsung Electronics Co., Ltd. All rights reserved.
Copyright (C) 2008 Nokia Corporation
Copyright (c) 2011-2012 Qualcomm Atheros Inc.
Copyright (C) Joerg Reuter DL1BKE (jreuter@yaina.de)
Copyright (C) 2012 Alexandra Chin <alexandra.chin@tw.synaptics.com>
Copyright (C) 2012 Scott Lin <scott.lin@tw.synaptics.com>
Copyright (c) 2017 National Instruments Erik Hons <erik.hons@ni.com> Brandon Streiff <brandon.streiff@ni.com>
Dane Wagner <dane.wagner@ni.com>
Copyright (C) 2001, 2002, 2003 Maciej W. Rozycki
Copyright: (C) 2010-2012 Julia Lawall, INRIA/LiP6.
Copyright: (C) 2010-2012 Gilles Muller, INRIA/LiP6. URL: <http://coccinelle.lip6.fr/> Comments:
Copyright Red Hat, Inc. 2014

Copyright (C) 1999-2002 by Massimo Piccioni <dafastidio@libero.it>
Copyright (C) 2005 Ralf Baechle (ralf@linux-mips.org)
Copyright (c) 2000-2005 Vojtech Pavlik <vojtech@suse.cz>
Copyright (c) 2005 Michael Haboustak <mike-@cinci.rr.com> for Concept2, Inc
Copyright (c) 2006-2007 Jiri Kosina
Copyright (C) 2010, Guennadi Liakhovetski <g.liakhovetski@gmx.de>
Copyright (C) 2006-7 Jonathan Corbet <corbet@lwn.net>
Copyright 2018 Google, Inc.
Copyright 2006 Sony Corp.
Copyright 2008 Openmoko, Inc.
Copyright 2008 Simtec Electronics Ben Dooks <ben@simtec.co.uk> <http://armlinux.simtec.co.uk/>
Copyright (c) 2004, 2005 Zultys Technologies. Eugene Surovegin <eugene.surovegin@zultys.com> or <ebs@ebshome.net>
Copyright 2002 MontaVista Software Inc.
Copyright (c) 2006-2007 Jiri Kosina
Copyright (c) 2007 Paul Walmsley
Copyright 2015-2016 Linaro Ltd.
Copyright 2018 NXP
Copyright (c) 2005, 2006 PathScale, Inc. All rights reserved.
Copyright EMC Corporation, 2008 Author.....: Nigel Hislop <hislop_nigel@emc.com>
Copyright (C) 2014 HGST, Inc., a Western Digital Company.
Copyright (C) Mike Christie, 2004 - 2005
Copyright (C) Dmitry Yusupov, 2004 - 2005
Copyright (C) Alex Aizman, 2004 - 2005
Copyright (C) 2015 Amlogic, Inc. All rights reserved.
Copyright (C) 2000 John Marvin <jsm at parisc-linux.org>
Copyright (C) 2000 Michael Ang <mang with subcarrier.org>
Copyright (C) 2002 Randolph Chung <tausq with parisc-linux.org>
Copyright (C) 2003 James Bottomley <jeb with parisc-linux.org>
Copyright (C) 2006-2013 Helge Deller <deller@gmx.de>
Copyright (c) Dimitri Sivanich
Copyright (c) 2000-2010 Adaptec, Inc. 2010-2015 PMC-Sierra, Inc. (aacraid@pmc-sierra.com) 2016-2017 Microsemi Corp. (aacraid@microsemi.com)
Copyright (C) 1999 Ralf Baechle (ralf@gnu.org)
Copyright (c) 2004 James Morris <jmorris@redhat.com>, Red Hat Inc.
Copyright (c) 1999 Silicon Graphics, Inc.
Copyright (C) 2001 Lineo
Copyright (C) 2001 Hewlett-Packard
ESAS2R_COPYRIGHT_YEARS "\n" <http://www.attotech.com>\n
Copyright (C) IBM Corporation, 2004. All rights reserved
Copyright © 2013 Alistair Popple IBM Corporation
Copyright (C) Paul Mackerras 1997.
Copyright 2002-2005 MontaVista Software Inc.
Copyright (c) 2003, 2004 Zultys Technologies
Copyright 2007 David Gibson, IBM Corporation.
Copyright 2010 Ben. Herrenschmidt, IBM Corporation.
Copyright © 2011 David Kleikamp IBM Corporation
Copyright (C) 2004 ATMEL
Copyright (C) Rick Bronson
Copyright (C) 2014 Free Electrons
Copyright 2016-2018 NXP
Copyright 2017~2018 NXP
Copyright 2005-2012 Freescale Semiconductor, Inc. All Rights Reserved.
Copyright (C) 2013 Red Hat, Inc. Mark Salter <msalter@redhat.com>
Copyright (C) 2004 Aurelien Alleaume <slts@free.fr>
Copyright (C) 2014, 2015 Intel Corporation
Copyright (C) 2004-2008 Red Hat, Inc. All rights reserved.

LICENCE TERMS (cont.)

Copyright (C) 2019 Hao Dong <halbertdong@gmail.com>
Copyright (C) 2004 Jean-Frederic Clere.
Copyright (C) 2004 Ian Campbell.
Copyright (C) 2004 Jeff Lackey.
Copyright (C) 1999 Eric A. Thomas which in turn is
Copyright (C) Russell King.
Copyright (C) 2004, Intel Corporation
Copyright (C) 2006-2008 Marvell International Ltd. All Rights Reserved
Copyright 2011 Linaro Ltd.
Copyright (C) 2014 Sebastian Andrzej Siewior
Copyright (c) 2001 Patrick Mochel <mochel@osdl.org>
Copyright (C) 2017 Jerome Brunet <jbrunet@baylibre.com>
Copyright (c) 2016 Samsung Electronics Co., Ltd.
Copyright © 2007 Anton Vorontsov <cbou@mail.ru>
Copyright © 2004 Szabolcs Gyurko
Copyright © 2003 Ian Molton <spyro@f2s.com>
"Copyright 2002 Alchemy Semiconductor Author: Alchemy Semiconductor, MontaVista Software"
Copyright (C) 2002-2003 Eric Biederman <ebiederm@xmission.com>
Copyright (C) 2004 Albert Herranz
Copyright (C) 2007 Ilyes Gouta. Based on the m5603x Linux Driver Project.
Copyright (C) 2005 m5603x Linux Driver Project <m5602@x3ng.com.br>
Copyright (c) 2006 Willem Duinker v4l2 interface modeled after the V4L2 driver for SN9C10x PC Camera Controllers
Copyright (c) 2018 The Linux Foundation. All rights reserved.
Copyright 2017-2019 NXP
Copyright (c) 2004-2005 Atheros Communications, Inc.
Copyright (c) 2006 Devicescape Software, Inc.
Copyright (c) 2007 Jiri Slaby <jirislaby@gmail.com>
Copyright (c) 2007 Luis R. Rodriguez <mcgrof@winlab.rutgers.edu>
Copyright (c) 2010 Bruno Randolf <br1@einfach.org>
copyright notice, this list of conditions and the following disclaimer, without modification. 2. Redistributions in binary form must reproduce at minimum a disclaimer similar to the "NO WARRANTY" disclaimer below ("Disclaimer and any redistribution must be conditioned up
Copyright (c) 2012 Smith Micro Software, Inc.
Copyright (c) 2012 Bjørn Mork <bjorn@mork.no>
Copyright (c) 2001 Matthew Wilcox for Hewlett Packard
Copyright (c) 2001 Helge Deller <deller@gmx.de>
Copyright (c) 2001,2002 Ryan Bradetich
Copyright (c) 2004-2005 Thibaut VARENE <varenet@parisc-linux.org>
Copyright(c) 2015 Intel Corporation. Redistribution and use in source and binary forms, with or without modification, are permitted provided that the following conditions are met:
Copyright (C) 2002 - 2009 Paul Mundt
Copyright (C) 2007 Herbert Valerio Riedel <hvr@gnu.org>
Copyright (C) 2009 Douglas Landgraf <douglslan@redhat.com>
Copyright (c) 2003 Open Source Development Lab
Copyright (c) 2013 Greg Kroah-Hartman
Copyright (c) 2013 The Linux Foundation
Copyright (C) 2014 ARM Ltd.
Copyright (c) 2011 Unixphere
Copyright (C) 1991, 1992 Linus Torvalds
Copyright (c) by James Courtier-Dutton <James@superbug.co.uk> Added EMU 1010 support.
Copyright (c) 2018 Fuzhou Rockchip Electronics Co., Ltd.
Copyright (c) 2018 Linaro Ltd.
Copyright 2005 Simtec Electronics\n
Copyright (c) 1992 Orest Zborowski
Copyright (C) 1998-99 Frodo Looijaard <frodol@dds.nl>
Copyright (C) 2003 Greg Kroah-Hartman <greg@kroah.com>
Copyright (C) 2003 David Borowski.
Copyright 1998-2000 Jonathan Teh Soon Yew)
Copyright (2628/1.25=2102.4)
Copyright (2628/1.67=1573.7)
Copyright (2628/2.60=1010.8)
Copyright (c) 2013 Linaro Ltd. Author: Thomas Abraham <thomas.ab@samsung.com>
Copyright (C) 2015 Linaro Ltd Andy Green <andy.green@linaro.org>
Copyright (C) 2017 SiFive
Copyright (C) 2013-2014 Jens Axboe
Copyright (C) 2004 by Ralf Baechle (ralf@linux-mips.org)
Copyright (c) by Abramo Bagnara <abramo@alsa-project.org>
Copyright (C) 2008-2009 by Jussi Kivilinna <jussi.kivilinna@iki.fi>
Copyright (C) 2003-2005 Pontus Fuchs, Giridhar Pemmasani http://ndiswrapper.sourceforge.net/
Copyright (C) 1998 Eddie C. Dost <ecd@skynet.be>
"Copyright (C) 1999-2000 Andre Hedrick <andre@linux-ide.org>"
Copyright (C) 2004 Grant Grundler <grundler at parisc-linux.org>
Copyright (C) 2018 Pengutronix, Philipp Zabel
Copyright 2007 OpenVZ SWsoft Inc Author: Pavel Emelianov <xemul@openvz.org>
Copyright (C) 2009 Nokia Corporation Author: Kirill A. Shutemov
Copyright (C) 2012 Parallels Inc. and Google Inc. Authors: Glauber Costa and Suleiman Souhla
Copyright (C) 2015 Red Hat, Inc., Johannes Weiner
Copyright (C) 1998 David A. Schleeff <ds@schleeff.org>
Copyright (C) 1993 Hamish Macdonald
Copyright 2003 Simtec Electronics (linux@simtec.co.uk)
Copyright (C) 2002 Shane Nay (shane@minirl.com)
Copyright (C) 2018 Renesas Electronics Corp.
Copyright (C) 2015 Glider bvba
Copyright (C) 2015 Renesas Electronics Corp.
Copyright (C) 1995-1996 Gary Thomas (gdt@linuxppc.org)
Copyright (C) 1996 Paul Mackerras Amiga/APUS changes by Jesper Skov (jskov@cygnus.co.uk).
Copyright (C) 1991, 1992, 1993, 1994 Linus Torvalds
Copyright (C) 2011, 2012 Renesas Solutions Corp.
Copyright (C) 2018, Linaro Ltd.
Copyright Matt Mackall <mpm@selenic.com>, 2003, 2004, 2005
Copyright Theodore Ts'o, 1994, 1995, 1996, 1997, 1998, 1999. All rights reserved.
Copyright (C) 2006 Lennart Poettering <mzxreary (at) 0pointer (dot) de>
Copyright (C) 2014 Antti Palosaari <crope@iki.fi>
Copyright (c) 2016-2017, Dave Watson <davejwatson@fb.com>. All rights reserved.
Copyright (c) 2016-2017, Lance Chao <lancerchao@fb.com>. All rights reserved.
Copyright (c) 2016, Fridolin Pokorny <fridolin.pokorny@gmail.com>. All rights reserved.
Copyright (c) 2016, Nikos Mavrogiannopoulos <nnav@gnutls.org>. All rights reserved.
Copyright (c) 2018, Covalent IO, Inc. http://covalent.io
Copyright (C) 2009 Contec Steuerungstechnik & Automation GmbH Hubert Feurstein <hubert.feurstein@contec.at>
Copyright (c) 2001 Matrox Graphics Inc.
Copyright(c) 1998 Gerd Knorr <kxaxel@cs.tu-berlin.de>
Copyright(c) 1998-2002 Petr Vandrovec <vandrove@vc.cvut.cz>
Copyright(c) 2018 NXP. All rights reserved.
Copyright (C) 2008 by IBM, Corp.
Copyright (C) 2000 Philipp Rumpf <prumpf@tux.org>
Copyright (C) 1999 Tetsuya Okada & Niibe Yutaka
Copyright (C) 1996 Paul Gortmaker
Copyright 2012, Kurt Van Dijck <kurt.van.dijck@eia.be>
Copyright (C) 2016 Maxime Ripard <maxime.ripard@free-electrons.com>
Copyright (C) 2013 Ideas On Board SPRL
Copyright (C) Jonathan Naylor G4KLX (g4klx@g4klx.demon.co.uk)
Copyright (C) Steven Whitehouse GW7RRM (steveuw@acm.org)
Copyright (C) Joerg Reuter DL1BKE (jreuter@yaina.de)
Copyright (C) Hans-Joachim Hetscher DD8NE (dd8ne@bnv-bamberg.de)

LICENCE TERMS (cont.)

Copyright (C) Frederic Rible F1OAT (frible@teaser.fr)
Copyright (C) 2018, Intel Corporation
Copyright (C) 2006 Filip Zyzniewski <filip.zyzniewski@tefnet.pl>
Copyright (C) 2003 Fruhwirth Clemens <clemens@endorphin.org>
Copyright (C) 2003 Richard Curnow
Copyright (c) 2009 Gabor Juhos <juhosg@openwrt.org>
Copyright (c) 2009 Imre Kaloz <kaloz@openwrt.org>
Copyright (C) 2010 Tobias Klausner <tklausner@distanz.ch>
Copyright (C) 2004 Microtronix Datacom Ltd
Copyright 2017 Icenowy Zheng <icenowy@aosc.io>
Copyright (c) 2008-2009, NVIDIA Corporation.
Copyright (C) 2014 - 2016 Cadence Design Systems Inc.
Copyright 2010 Freescale Semiconductor, Inc.
Copyright 2007-2008 OpenedHand Ltd.
Copyright (C) ST-Ericsson SA 2010
Copyright (C) 2011 Red Hat, Inc. All rights reserved.
Copyright (C) 2011 Mike Christie
Copyright (C) 2014 Atmel
Copyright 2011 Microsoft
Copyright 2006 Microsoft Corporation.
Copyright (C) 2004-2007 Red Hat, Inc. All rights reserved.
Copyright (C) 2009 by Holger Schurig <hs4233@mail.mn-solutions.de>
Copyright 2005 MontaVista Software, Inc. Matt Porter <mporter@kernel.crashing.org>
Copyright 2004 MontaVista Software, Inc. Matt Porter <mporter@kernel.crashing.org>
Copyright (c) 2005 Eugene Surovegin <ebs@ebshome.net>
Copyright (C) 2016-19 Sang Engineering, Wolfram Sang
Copyright (C) 2017 Horms Solutions, Simon Horman
Copyright (C) 2010-2011 Guennadi Liakhovetski
Copyright (C) 1996 Eddie C. Dost (ecd@skynet.be)
Copyright (C) 2005 Mike Wray, Hewlett-Packard
Copyright (C) 2005, 2006 XenSource Ltd
Copyright 2000 Deep Blue Solutions Ltd
Copyright 2008 Cavium Networks
Copyright (C) 2016-2017 Pengutronix, Philipp Zabel <kernel@pengutronix.de>
Copyright (c) 2002-2004 Anton Altaparmakov
Copyright 2019 NXP
Copyright 2005, Devicescape Software, Inc.
Copyright (c) 2006 Jiri Benc <jbenc@suse.cz>
Copyright(c) 1999 - 2005 Intel Corporation. All rights reserved.
Copyright(C) 2003 Ardis Technologies <roman@ardistech.com>
Copyright (C) 1991, 1992 Linus Torvalds
Copyright (C) 1997 Linus Torvalds
Copyright © CC Computer Consultants GmbH, 2007
Copyright 2005-2006, Devicescape Software, Inc.
Copyright (c) 2006 Jiri Benc <jbenc@suse.cz>
Copyright 2008, Johannes Berg <johannes@sipsolutions.net>
Copyright 2013-2014 Intel Mobile Communications GmbH
Copyright (c) 2016 Intel Deutschland GmbH
Copyright (c) 2011 Eric Dumazet <eric.dumazet@gmail.com>
Copyright (C) 2008 Dmitri Vorobiev
Copyright 2008 Pierre Ossman
Copyright (C) 2009 STMicroelectronics
Copyright (C) 2001 Deep Blue Solutions Ltd.
Copyright (C) 2011 Google, Inc.
Copyright (c) 2006, 2007, 2008, 2009 QLogic Corporation. All rights reserved.
Copyright (c) 2014-2018 Broadcom Limited
Copyright (c) 2018-2019 Broadcom Inc.

Copyright (C) ST Microelectronics
Copyright (C) 2001 MIPS Technologies, Inc.
Copyright (C) 2004 Thiemo Seufer
Copyright (C) 2014 Imagination Technologies Ltd.
Copyright (C) 2008 Analog Devices, Inc
Copyright (c) 2003 VIA Networking Technologies, Inc
Copyright (C) 2018 Bootlin
Copyright (C) 2009-11 Texas Instruments Added OMAP4 support - Santosh Shilimkar <santosh.shilimkar@ti.com>
Copyright (c) 2014-2016 Hisilicon Limited.
Copyright 2011 Hauppauge Computer works drivers/staging/media/lirc/lirc_zilog.c
Copyright (c) 2000 Gerd Knorr <kxaxel@goldbach.in-berlin.de> Michal Kochanowicz <mkochano@pld.org.pl>
Christoph Bartelmus <lirc@bartelmus.de> Ulrich Mueller <ulrich.mueller42@web.de> Stefan Jahn <stefan@lkcc.org> Jerome Brock <jbrock@users.sourceforge.net>
Copyright (C) 2011 Andy Walls <awalls@md.metrocast.net>
Copyright 2002 Alchemy Semiconductor Author: Alchemy Semiconductor
Copyright (C) 2017 Intel Corporation
Copyright (C) 2013 Xilinx, Inc.
Copyright (c) 2006-2007 Sylvain Munaut <tnt@246tNt.com>
Copyright (C) 2006 Freescale - John Rigby
Copyright (C) 2001-2003 Pavel Machek <pavel@ucw.cz>
Copyright (C) 2001 Christoph Hellwig
Copyright (C) 2005 SGI, Christoph Lameter
Copyright (C) 2006 Nick Piggin
Copyright (C) 2012 Konstantin Khlebnikov
Copyright (C) 2016 Intel, Matthew Wilcox
Copyright (C) 2016 Intel, Ross Zwisler
Copyright (C) 2007 Google, Inc. Author: Robert Love <rlove@google.com>
Copyright (C) 2014 Dariusz Rad <dariusz@bluespec.com>
Copyright (c) 2018 Linaro Ltd. Author: Manivannan Sadhasivam <manivannan.sadhasivam@linaro.org>
Copyright (c) 2018 LSI-TEC - Caninos Loucos Author: Edgar Bernardi Righi <edgar.righi@sitec.org.br>
Copyright (c) 2003 David Glance <davidgsf@sourceforge.net> 2001 Juergen Stuber <stuber@loria.fr>
Copyright (c) 2001 Greg Kroah-Hartman (greg@kroah.com)
Copyright (C) 2007 Felix Fietkau <nbd@openwrt.org>
Copyright (C) 2007 John Crispin <john@phrozen.org>
Copyright (C) 2010 Thomas Langer, <thomas.langer@lantiq.com>
Copyright (C) 2000,2001 J.I. Lee <jung-ik.lee@intel.com>
Copyright (C) 2001,2002 Paul Diefenbaugh <paul.s.diefenbaugh@intel.com>
Copyright(c) 2014 Intel Corporation.
Copyright (C) 2007 Red Hat, Inc., Peter Zijlstra
Copyright (c) 2001 Intel Corp.
Copyright 2016 Noralf Trønnes
Copyright (C) 2013, Obsidian Research Corp. Jason Gunthorpe <jgunthorpe@obsidianresearch.com>
Copyright (C) 2005, 2006 Michael H. Schimek <mschimek@gmx.at> Sponsored by OPQ Systems AB
Copyright (C) 2019 Renesas Electronics Corporation Kuninori Morimoto <kuninori.morimoto.gx@renesas.com>
Copyright (C) 1998, 2000 Richard Henderson
"Copyright (C) 2004-2006 Joern Engel <joern@wh.fh-wedel.de> "
Copyright 2018-2019 NXP
Copyright (C) 2000-2002 Inside Out Networks
Copyright (C) 2001-2002 Greg Kroah-Hartman
Copyright 2007-2009 DENX Software Engineering, Stefan Roese <sr@denx.de>
Copyright © 2004-2010 David Woodhouse <dwmw2@infradead.org>
Copyright (c) 2016 Endless Computers, Inc. Author: Carlo Caione <carlo@endlessm.com>
Copyright (C) 2002,2003 Suresh Siddha <suresh.b.siddha@intel.com>
Copyright (c) 2000 Jeroen B. Vreeken (pe1rxq@amsat.org)
Copyright (C) 2006 David Brownell (new RTC framework)
Copyright (C) 2014 Johan Hovold <johan@kernel.org>
Copyright (C) 2013 Sebastian Reichel

LICENCE TERMS (cont.)

Copyright (C) 2009 Magnus Damm
Copyright (C) 2005 Nokia Corporation Author: Lauri Leukkunen <lauri.leukkunen@nokia.com> PWM and clock framework support by Timo Teras.
Copyright (C) 2007 MontaVista Software, Inc. <source@mvista.com>
Copyright (C) 2014 Endless Mobile
Copyright (c) 2013-2014 Takashi Sakamoto
Copyright 2013 Eukréa Electromatique <denis@eukrea.com>
Copyright (c) 2016 Jiri Pirko <jiri@mellanox.com>
Copyright (C) 2016 NextThing Co.
Copyright (C) 2003 - 2004 Tresys Technology, LLC
Copyright (C) 2001 Greg Kroah-Hartman (greg@kroah.com)
Copyright (C) 2001 IBM Corp.
Copyright (C) 2003-2004 Intel Corporation
Copyright (C) 2017 Icenowy Zheng <icenowy@aosc.io>
Copyright (C) 2018 Renesas Electronics Corp.
Copyright © 2000-2010 David Woodhouse <dwmw2@infradead.org>
Copyright (c) 2007 SUSE Linux Products GmbH
Copyright (c) 2007, 2013 Tejun Heo <tj@kernel.org>
Copyright (C) 2012 MIPS Technologies, Inc. All rights reserved.
Copyright (C) 2017 ARM Ltd.
Copyright (c) 2014- QLogic Corporation. All rights reserved www.qlogic.com
Copyright (C) 2008 Cambridge Silicon Radio Ltd.
Copyright (C) 2019 Intel Corporation
Copyright (C) 2003 - 2008 Paul Mundt
Copyright (C) 2001-2003 Jochen Eisinger <jochen@penguin-breeder.org>
Copyright 2017 Savoir-faire Linux
Copyright (c) 2013-2014 Linaro Limited.
Copyright (C) 1996, 1997, 1998, 1999 Jakub Jelinek (jj@ultra.linux.cz)
Copyright (c) 2013 Eric Leblond <eric@regit.org>
Copyright (C) 2014 Intel Corp.
Copyright (C) 2018 Intel Corp.
Copyright (c) 2001-2002, SSH Communications Security Corp and Jouni Malinen j@w1.fi>
Copyright (c) 2002-2003, Jouni Malinen <j@w1.fi>
Copyright (c) 2004, Intel Corporation
Copyright 2006-2012 Solarflare Communications Inc.
Copyright 2003 NVIDIA, Corporation. All rights reserved.
Copyright 2020 NXP
Copyright (C) 2016 Intel Corporation
Copyright** [copy] 2016 : Hans Verkuil
Copyright (c) 2007, 2008 Mellanox Technologies. All rights reserved.
Copyright (c) 2005-2007 Patrick McHardy <kaber@trash.net>
Copyright (C) 2003-2004, Paul Clements, SteelEye Technology, Inc.
Copyright (C) 2007 Kristoffer Ericson <Kristoffer_e1@hotmail.com>
Copyright (C) 1997 David S. Miller (davem@caip.rutgers.edu)
Copyright (C) 2002, 2003, 2004 Paul Mundt
Copyright (C) 2002 M. R. Brown <mrbrown@linux-sh.org>
Copyright (C) 2002, Rohit Seth <rohit.seth@intel.com>
Copyright (C) 2015 Free Electrons
Copyright (C) 2015 NextThing Co
Copyright (c) 2013, 2014, 2015 Guenter Roeck
Copyright (c) 2015 Linear Technology
Copyright (c) 2018 Analog Devices Inc.
Copyright (C) 1997-2001 Geert Uytterhoeven
Copyright (C) 1998 Bernd Harries
Copyright (C) 1998 Eddie C. Dost (ecd@skynet.be)
Copyright (C) 1996 Paul Mackerras
Copyright (C) 1997 Michael AK Tesch

Copyright (C) 2006 MontaVista Software Inc. Author: Vitaly Wool <vwool@ru.mvista.com>
Copyright (C) 2007 David Gibson, IBM Corporation.
Copyright © 2000 Nicolas Pitre <nico@cam.org>
Copyright © 2005-2009 Analog Devices Inc.
Copyright (C) 2011-2012 Intel Corporation
Copyright (C) 2015 Texas Instruments Incorporated - http://www.ti.com Author: Peter Ujfalusi <peter.ujfalusi@ti.com>
Copyright (c) 2001,2002 Richard Russon
Copyright (c) 2001-2014 Anton Altaparmakov and Tuxera Inc.
Copyright ifdef DEBUG module_param(debug_msgs, bint, 0)
Copyright (C) 2010-2011 ST Microelectronics
Copyright 2005 Wolfson Microelectronics PLC.
Copyright 2005 Openedhand Ltd.
Copyright (c) 2009, 2013 H Hartley Sweeten <hsweeten@visionengravers.com>
Copyright (C) 2010-2011 Jonas Bonn <jonas@southpole.se>
Copyright (C) 2000 by Silicon Graphics, Inc.
Copyright (C) 2004 by Christoph Hellwig
Copyright (C) 2007 MontaVista Software, Inc., <source@mvista.com>
Copyright (C) 2007 John Williams
Copyright 2001 by Intel Corp, taken from http://www.embedded.com/showArticle.jhtml
Copyright 2005-2013 Solarflare Communications Inc.
Copyright (C) 2015 Wang Nan <>wangnan0@huawei.com>
Copyright (C) 2015 Huawei Inc.
Copyright 2010 Cisco Systems, Inc. All rights reserved. Author: Tom Lyon, pugs@cisco.com
Copyright (C) 2001, 2002 Niibe Yutaka
Copyright (c) 2009 Alberto Panizzo <maramaopercheseimorto@gmail.com> Inspired by Marek Vasut work in I4f00242t03.c
"Copyright 2006-2007 Jiri Benc <jbenc@suse.cz>"
"Copyright 2007 Johannes Berg <johannes@sipsolutions.net>"
Copyright (C) 2018, 2020 Intel Corporation
Copyright (C) 2009 Matthias Fuchs <matthias.fuchs@esd-electronics.com>.
Copyright (C) 2007 MontaVista Software, Inc.
Copyright (C) 2005 Nokia Corporation Author: Paul Mundt <paul.mundt@nokia.com> Juha Yrjölä <juha.yrjola@nokia.com> OMAP Dual-mode timer framework support by Timo Teras
Copyright (C) 2004-2009 Texas Instruments, Inc.
Copyright (c) 2016 Pablo Neira Ayuso <pablo@netfilter.org>
Copyright 2013 Michael Ellerman, IBM Corporation.
Copyright (C) 2016 Hubert Denkmaier
Copyright (C) 2017 Imagination Technologies Ltd.
Copyright (C) 2006,2007 Eugene Konev <ejka@openwrt.org>
Copyright IBM Corporation, 2013
Copyright LG Electronics Inc., 2014 Written by: Marek Szyprowski <m.szyprowski@samsung.com> Michal Nazarewicz <mina86@mina86.com> Aneesh Kumar K.V <aneesh.kumar@linux.vnet.ibm.com> Joonsoo Kim <iamjoonsoo.kim@lge.com>
Copyright(c) 2015 Intel Mobile Communications GmbH
Copyright(c) 2017 Intel Deutschland GmbH
Copyright(c) 2018 - 2019 Intel Corporation
Copyright (C) 2004 IBM Corp.
Copyright (C) 2005 R Sharada (sharada@in.ibm.com)
Copyright (C) 2006 Mohan Kumar M (mohan@in.ibm.com)
Copyright (C) 2016 IBM Corporation
Copyright (C) 2011 Texas Instruments Inc.
Copyright (C) 2013-2017 Helge Deller <deller@gmx.de>
Copyright (C) 1991, 1997, 2003 Free Software Foundation, Inc.
Copyright 2000 VA Linux Systems, Inc., Sunnyvale, California. All Rights Reserved.
Copyright (c) 2016 Rockchip Electronics Co. Ltd. Author: Xing Zheng <zhengxing@rock-chips.com>
Copyright (c) 2013 Samsung Electronics Co., Ltd.

LICENCE TERMS (cont.)

Copyright (c) 2004 Takashi Iwai <tiwai@suse.de> PeiSen Hou <pshou@realtek.com.tw>
Copyright © 2010 Freescale Semiconductor
Copyright (C) 1997, 2007 David S. Miller (davem@davemloft.net)
Copyright 2000 Jakub Jelinek (jakub@redhat.com)
Copyright (c) 2013, The Linux Foundation. All rights reserved.
Copyright (C) 2011,2018 Michael Schmitz (schmitz@debian.org) for migration to ESP SCSI core
Copyright (C) 2013 Tuomas Vainikka (tuomas.vainikka@aalto.fi) for Blizzard 1230 DMA and probe function fixes
Copyright 2000 VA Linux Systems, Inc., Sunnyvale, California. All rights reserved.
Copyright (c) 2009 Nokia Corporation Roger Quadros <ext-roger.quadros@nokia.com>
Copyright 2016 NXP
Copyright (c) 2017 SUSE Linux GmbH Author: Andreas Färber
Copyright 2017 NXP.
Copyright (C) 2009 Wind River Systems Inc
Copyright (C) 1994, 95, 96, 97, 98, 99, 2000, 2003 Ralf Baechle
Copyright (C) 1999, 2000, 2001 Silicon Graphics, Inc.
Copyright (c) 2016 BayLibre, SAS. Author: Jerome Brunet <jbrunet@baylibre.com>
Copyright (C) 2013-2018 by the following authors: Rob Clark <robdclark@gmail.com> (robclark) Ilia Mirkin <imirkin@alum.mit.edu> (imirkin)
copyright(C) 1999-2000 Kurt Garloff
Copyright (C) 2014 Free Electrons Author: Boris BREZILLON <boris.brezillon@free-electrons.com>
Copyright (C) 2009 Texas Instruments, Inc.
Copyright (C) 2000 Inside Out Networks, All rights reserved.
Copyright (C) 2001-2002 Greg Kroah-Hartman <greg@kroah.com>
Copyright (C) 2007 Maciej W. Rozycki
Copyright (C) 1999-2008, Philipp Reisner <philipp.reisner@linbit.com>.
Copyright (C) 2002-2008, Lars Ellenberg <lars.ellenberg@linbit.com>.
Copyright (C) 2017 Amarula Solutions B.V. Author: Jagan Teki <jagan@amarulasolutions.com>
Copyright (C) 2014 Alexander Bersenev <bay@hackerdom.ru>
Copyright (C) 2007-2012 Daniel Wang Allwinner Technology Co., Ltd. <www.allwinnertech.com>
Copyright 2005 Openedhand Ltd.
"Copyright(c) snd_soc_component_write(c, WM8988_RESET, 0) "
Copyright (C) 2017-2018 NXP
Copyright (C) 2008 Florian Fainelli <florian@openwrt.org>
Copyright (C) 2010 Nokia Corporation Benoît Cousson Paul Walmsley Rajendra Nayak <rnayak@ti.com>
Copyright (c) 2012 Linaro Ltd http://www.linaro.org
Copyright (c) 2011-2016, NVIDIA CORPORATION. All rights reserved.
Copyright (c) 2002, 2003 Philip Pokorny <ppokorny@penguincomputing.com>
Copyright (c) 2003 Margit Schubert-While <margitsw@t-online.de>
Copyright (c) 2004 Justin Thiessen <jthiessen@penguincomputing.com>
Copyright (C) 2007--2014 Jean Delvare <jdelvare@suse.de>
Copyright (C) 2003 Paul Mundt
Copyright (C) 2004 Richard Cumow
Copyright (C) 2002 Shane Nay (shane@minirl.com)
Copyright 2006-2007 Freescale Semiconductor, Inc. All Rights Reserved.
Copyright (C) 2014 Stefan Roese <sr@denx.de>
Copyright(c) 1996 Kars de Jong */ Based on the ide driver from 1.2.13pl8 */
Copyright (c) 2006, 2007 Cisco Systems, Inc. All rights reserved.
Copyright (c) 2003, 2004 Zultys Technologies
Copyright 2008 Marvell. <kewei@marvell.com>
Copyright 2009-2011 Marvell. <yuxiangl@marvell.com>
Copyright (C) 2008 Thomas Gleixner <tglx@linutronix.de>
Copyright (C) 2008-2009 Red Hat, Inc., Ingo Molnar
Copyright (C) 2009 Jaswinder Singh Rajput
Copyright (C) 2009 Advanced Micro Devices, Inc., Robert Richter
Copyright (C) 2008-2009 Red Hat, Inc., Peter Zijlstra
Copyright (C) 2009-2016 Felix Fietkau <nbd@openwrt.org>
Copyright (C) 2013-2016 Michael Lee <igttee@gmail.com>
Copyright (C) 1999-2001 Nicolas Pitre
Copyright (C) 2011 RICOH COMPANY,LTD
Copyright (C) 2009-2010 Nokia Corporation
Copyright (C) 2012 Jeremy Kerr <jeremy.kerr@canonical.com>
Copyright (C) 2012 Frank Schäfer <fschaefer.oss@googlemail.com>
Copyright (C) 2001 by Stanislav Brabec <utx@penguin.cz>
Copyright (C) 2000-2001 Toshiba Corporation
Copyright (C) 2006-2007 Pavel Pisa (ppisa@pikron.com)
Copyright (C) 2008 Juergen Beisert (kernel@pengutronix.de)
Copyright (C) 2010 Freescale Semiconductor, Inc. All Rights Reserved.
Copyright (C) 2000 - 2001 by Silicon Graphics, Inc.
Copyright (c) 2001-2012 Anton Altaparmakov
Copyright (C) 2001,2002 Jakob Kemi <jakob.kemi@telia.com>
Copyright (C) 2006, 2007 University of Szeged, Hungary
Copyright 2004 Koen Kooi <koen@vestingbar.nl>
Copyright (C) 2006-2007 by OpenMoko, Inc. Author: Harald Welte <laforge@openmoko.org>
Copyright (C) 2012 Kuninori Morimoto <kuninori.morimoto.gx@renesas.com>
Copyright (C) 2014 Glider bvba
Copyright (C) 2011 Magnus Damm
Copyright (c) 2004-2005 Simtec Electronics Ben Dooks <ben@simtec.co.uk>
Copyright (c) Dirk Opfer 2005. Modifications developed from sharps code but NOT containing any, ported onto lans base.
Copyright (c) Chris Humbert 2005
Copyright (c) Dmitry Baryshkov 2008 Minor fixes
Copyright (C) 2009, Wind River Systems Inc
Copyright (C) 1999-2002, Greg Ungerer (gerg@snapgear.com)
Copyright (C) 1998 D. Jeff Dionne <jjeff@lineo.ca>, Kenneth Albanowski <kjahds@kjahds.com>,
Copyright (C) 2000 Lineo Inc. (www.lineo.com)
Copyright (C) 2007 Andrew Sharp <andy.sharp@lsi.com>
Copyright 2011 Freescale Semiconductor Inc.
Copyright (c) 2000-2003 Adaptec Inc. All rights reserved.
Copyright (c) 2010 Manuel Stahl <manuel.stahl@iis.fraunhofer.de>
Copyright (c) 2008 Jonathan Cameron
Copyright (C) 2002 Ralf Baechle DO1GRB (ralf@gnu.org)
Copyright (C) 2010 Freescale Semiconductor, Inc.
Copyright (c) 2012 Qualcomm Atheros, Inc.
Copyright (c) 2018 David Ahern <dsa@cumulusnetworks.com>
Copyright 2007 SBS Technologies GmbH & Co. KG And: mpc8641_hpcn.dts (MPC8641 HPCN Device Tree Source)
Copyright 2006 Freescale Semiconductor Inc.
Copyright (C) 1994 - 2001, 2003, 07 Ralf Baechle
Copyright (c) 2005 Amaldo Carvalho de Melo <acme@ghostprotocols.net>
Copyright (c) 2017 Sysam, Angelo Dureghello <angelo@sysam.it>
Copyright 2007 rPath, Inc. - All Rights Reserved
Copyright 2009 Intel Corporation
Copyright (C) 2000 David A. Schleef <ds@schleef.org>
Copyright (C) 2006,2007 Alan Nisota (alannisota@gmail.com)
Copyright (C) 2017 T-Platforms All Rights Reserved.
Copyright (C) 2015 EMC Corporation. All Rights Reserved.
Copyright 2011-2012 Julian Squires <julian@cipht.net>
Copyright(C) Copyright 2000-2001, Lineo (www.lineo.com)
Copyright (c) 1997 Dan Malek (dmalek@jlc.net).
Copyright (c) 2011,2012 Toradex Inc.
Copyright (C) 1997,1998,1999 Jakub Jelinek (jj@ultra.linux.cz)
Copyright (C) 2009 Hewlett-Packard Development Company, L.P. Nagananda Chumbalkar <nagananda.chumbalkar@hp.com>
Copyright (C) International Business Machines Corp., 2006 Authors: Artem Bityutskiy 2008 Author(s): Igor Mammedov (niallain@gmail.com) Steve French (sfrench@us.ibm.com)

LICENCE TERMS (cont.)

Copyright (C) 2014 ZTE Corporation.
Copyright (C) 2014 Rose Technology Allan Bendorff Jensen <abj@rosetechnology.dk> Soren Andersen <san@rosetechnology.dk>
Copyright (C) 2015 Bert Vermeulen <bert@biot.com>
Copyright (C) 2001 Ralf Baechle
Copyright (C) 2013 Imagination Technologies Ltd.
Copyright (C) 2003 Robert Schwebel, Pengutronix
Copyright (C) 2003 Benedikt Spranger, Pengutronix
Copyright (C) 2003 David Brownell
Copyright (C) 2003 Joshua Wise
Copyright (C) 2006 Applied Data Systems
Copyright (C) 2009 Ryan Mallon <rmallon@gmail.com>
Copyright 2011 Simtec Electronics Ben Dooks <ben@simtec.co.uk>
Copyright (c) 2016-2018 Christoph Hellwig.
Copyright (C) 2002 Vivien Chappelier <vivien.chappelier@linux-mips.org>
Copyright 2008,2012,2015 Freescale Semiconductor, Inc.
Copyright(c) 2016 Intel Deutschland GmbH
Copyright (C) 2012-2013 Martin Liska <marxin.liska@gmail.com>
Copyright (C) 2013-2014 Marek Vasut <marex@denx.de>
Copyright (C) 2015 Gabriele Mazzotta <gabriele.mzt@gmail.com>
Copyright (C) 2012 Broadcom Corporation
Copyright (C) 2006-2007 PA Semi, Inc
Copyright (c) 2009, Bartlomiej Zolnierkiewicz
Copyright (c) 2009, Joao Ramos <joao.ramos@inov.pt> INESC Inovacao (INOV)
Copyright (C) 2007 Lennert Buytenhek <buytenh@wantstofly.org>
Copyright (C) 2006 Tower Technologies
Copyright 2007 Sebastian Siewior
Copyright (C) 2008-2010 Jonathan Cameron
Copyright (C) 2002-2004 Stefan Eletzhofer
Copyright (C) 2011 Texas Instruments Incorporated - <http://www.ti.com/>
Copyright (c) 2011 Picochip Ltd., Jamie Iles
Copyright (C) 2006-2008, Lars Ellenberg <lars.ellenberg@linbit.com>.
Copyright (C) 2006-2008, Philipp Reisner <philipp.reisner@linbit.com>.
Copyright(C) or pretend (B,A) that the write was successfully written on the peer.
Copyright (c) 2013 Linaro Ltd.
Copyright (C) 2011 Intel Corporation
Copyright (C) 2008 Nobuhiro Iwamatsu <iwamatsu.nobuhiro@renesas.com>
Copyright (c) 2001 Vojtech Pavlik
"Copyright 2008-2011 Luis R. Rodriguez <mccgr@qca.qualcomm.com>"
Copyright 2017 Intel Deutschland GmbH
Copyright (C) 2018 - 2019 Intel Corporation
Copyright (C) 1998 - 2014 Douglas Gilbert
Copyright (c) 2012-2013 Red Hat, Inc. All rights reserved.
Copyright (C) 1993 Turtle Beach Systems, Inc.
Copyright (C) 2010 Simon Guinot <sguinot@lacie.com>
Copyright © 2007 STMicroelectronics Pvt. Ltd.
Copyright © 2009 Alessandro Rubini
Copyright (C) 2012 Mike Sinkovsky <msink@permonline.ru>
Copyright 2007, Werner Cornelius <werner@cornelius-consult.de>
Copyright 2009, Boris Hajduk <boris@hajduk.org>
Copyright (C) 2013 Red Hat
Copyright (C) 2009 NXP Semiconductors
Copyright (c) 2011, 2017 Intel Corporation.
Copyright (C) 1995 - 1999 Ralf Baechle
Copyright (C) 1996 Paul M. Antoine Modified for DECStation and hence R3000 support by Paul M. Antoine Further modifications by David S. Miller and Harald Koefgen
Copyright (C) 2009-2010 Gabor Juhos <juhosg@openwrt.org>

Copyright: (C) 2012, 2015 Gilles Muller, INRIA. URL: <http://coccinelle.lip6.fr/>
Copyright 2017-2018 NXP.
Copyright (C) 2009 PetaLogix
Copyright (c) 2014 Hisilicon Limited.
Copyright (C) 1998, 1999, 2001 David Mosberger-Tang <davidm@hpl.hp.com>
Copyright (C) 2011-2013 Red Hat, Inc.
Copyright (C) 2009-2010 Douglas Landgraf <douglslan@redhat.com>
Copyright (C) 2005-2006 Thomas Gleixner
Copyright (C) 2008 Riku Voipio
Copyright(c) container_of(c, struct pca9532_led, ldev)
Copyright (C) 2019, Red Hat, Inc.
Copyright (c) 2015 CMC Electronics, Inc.
Copyright (c) 2017 Savoir-faire Linux, Inc.
Copyright (C) 2007-2014 Jean Delvare <jdelvare@suse.de>
Copyright (C) 2016 Hauke Mehrtens <hauke@hauke-m.de>
Copyright (C) 2001-2002 Greg Kroah-Hartman <greg@kroah.com>
Copyright (C) 2001 Networks Associates Technology, Inc <ssmalley@nai.com>
Copyright (C) 2016 Mellanox Technologies
Copyright 2001-2008 S3 Graphics, Inc. All Rights Reserved.
Copyright 2009-2010 Jonathan Corbet <corbet@lwn.net>
Copyright 2010 Florian Tobias Schandinat <Florian.Schandinat@gmx.de>
Copyright (C) 2015-2016 Altera Corporation by Alan Tull <atull@opensource.altera.com>
Copyright (C) 2008 Eric Piel
Copyright (C) 2008-2009 Pavel Machek
Copyright (C) 2013-2015 Xilinx, Inc.
Copyright (C) 2016 Michael Lee <igttee@gmail.com>
Copyright (C) 2018 Jan Breuer <jan.breuer@jaybee.cz>
Copyright(C) 2014 Sittisak <sittisaks@hotmail.com>
Copyright (C) 2017 Tony Lindgren <tony@atomide.com>
Copyright(C) 2005-2006, Red Hat, Inc., Ingo Molnar
Copyright (C) 2002 - 2010 Paul Mundt
Copyright (C) 2016 Engicam S.r.l.
Copyright (c) 2013 Andrew Lunn <andrew@lunn.ch>
Copyright (C) 2019 Mellanox Technologies. All rights reserved
Copyright (c) 1998-2000 Ilario Nardinocchi (nardinoc@CS.UniBO.IT)
Copyright (c) 1999 Jakub Jelinek (jakub@redhat.com)
Copyright (C) 2013 Maxime Ripard <maxime.ripard@free-electrons.com>
Copyright (c) 2017 Facebook
Copyright (c) 2018 Covalent IO, Inc. <http://covalent.io>
Copyright (C) 2006-2007 Daniel Drake <dsd@gentoo.org>
copyright(C) 1999 Benjamin Reed. All Rights Reserved. Permission to use code in the Developer's manual was granted for this driver by Aironet.
Copyright (C) 1999 David A. Hinds. All Rights Reserved.
Copyright(C) 1999 Benjamin Reed. All Rights Reserved. Permission to use code in the Developer's manual was granted for this driver by Aironet.
Copyright (C) 2003 TimeSys Corporation
Copyright: (C) 2012 Julia Lawall, INRIA/LIP6.
Copyright (C) 2006 Randy Dunlap
Copyright (c) 2006 Herbert Xu <herbert@gondor.apana.org.au>
Copyright (C) 2014 Cadence Design Systems Inc.
Copyright (c) 2018-2020 Oracle Author: Matthew Wilcox <willy@infradead.org>
Copyright (C) 2004 Albert Herranz
Copyright (C) 2011, IBM Corporation Author: Suzuki Poulose <suzuki@in.ibm.com>
Copyright 2001-2012 IBM Corporation.
"Copyright 2015-2017 Intel Deutschland GmbH"
Copyright (C) 2018-2019 Intel Corporation
Copyright (C) 2005-2007 Hans Verkuil <hverkuil@xs4all.nl>

LICENCE TERMS (cont.)

Copyright (c) 2009-2010, NVIDIA Corporation. Scott Peterson <speterson@nvidia.com> Vijay Mali <vmali@nvidia.com>
Copyright (C) 2010 Google, Inc. Iliyan Malchev <malchev@google.com>
Copyright (C) 2008 WonderMedia Technologies, Inc.
Copyright (c) 2017-2019 Pengutronix, Marc Kleine-Budde <kernel@pengutronix.de>
Copyright (c) 2017-2019 Pengutronix, Oleksij Rempel <kernel@pengutronix.de>
Copyright (C) 2019 Amarula Solutions B.V. Author: Jagan Teki <jagan@amarulasolutions.com>
"Copyright (C) 2003-2012 ARM Ltd. Authors: Catalin Marinas <catalin.marinas@arm.com> Will Deacon <will.deacon@arm.com> "
Copyright (C) 1995-1996 Gary Thomas (gdt@linuxppc.org)
Copyright (c) 1999-2001 Motorola, Inc.
Copyright (c) 2016-2017 Savoir-faire Linux Inc. Vivien Didelot <vivien.didelot@savoirfairelinux.com>
Copyright (c) 2017 National Instruments Brandon Streiff <brandon.streiff@ni.com>
Copyright (C) 2015-2016 Samsung Electronics Igor Kotrasinski <i.kotrasinski@samsung.com>
Copyright (C) 2013-2016, Linaro Ltd. Author: Hanjun Guo <hanjun.guo@linaro.org>
Copyright (C) 2013 Maxime Ripard
Copyright (C) 2010-2015, Shanghai Sileadinc Co.Ltd
Copyright (C) 2006-2008 Red Hat GmbH
Copyright (C) 2011 - 2013 Samsung Electronics Co., Ltd.
Copyright (C) 2015-2016 Freescale Semiconductor, Inc. All Rights Reserved.
Copyright 2019 NXP Author: Sylwester Nawrocki <s.nawrocki@samsung.com>
Copyright (C) 2004-2005 Christoph Hellwig *
Copyright(c) link attention events can be processed (fcp ring only) d) IOCB processing is not blocked by the outstanding mbox command.
Copyright (C) 2019 Bruno Thomsen <bruno.thomsen@gmail.com>
Copyright (C) 1993, 1994, 1995 Eric Youngdale
Copyright (C) 2002-2003 Christoph Hellwig
Copyright (C) 1995 Linus Torvalds
Copyright (c) 2010-2012 Mauro Carvalho Chehab Driver modified by in order to work with upstream drxk driver, and tons of bugs got fixed, and converted to use dvb-usb-v2.
Copyright 2015 SUSE Linux GmbH
Copyright(c) 2014 Intel Mobile Communications GmbH All rights reserved.
Copyright (C) 1999 Arun Sharma <arun.sharma@intel.com>
Copyright (C) 2000 VA Linux Co
Copyright (C) 2000 Don Dugger <n0ano@valinux.com>
Copyright (C) 2000 Hewlett-Packard Co.
Copyright (C) 2000 David Mosberger-Tang <davidm@hpl.hp.com>
Copyright (C) 2000 Gerhard Tonn (ton@de.ibm.com)
Copyright (C) 2000-2002 Andi Kleen, SuSE Labs (x86-64 port)
Copyright (C) 2000 Silicon Graphics, Inc.
Copyright (C) 2004 IBM Deutschland Entwicklung GmbH, IBM Corporation
Copyright (C) 2004 Arnd Bergmann (arnd@arndb.de)
Copyright (C) 1999 Ingo Molnar <mingo@redhat.com>
Copyright 2008 IBM, Inc. by Konrad Rzeszutek <konrad@linux.vnet.ibm.com>
Copyright 2008 by Konrad Rzeszutek <ketuzsezr@damok.org>
copyrights. (v0.4.9)
Copyright (C) 2001 by Harald Welte <laforge@gnumonks.org>
Copyright (C) 2001 Lennert Buytenhek (buytenh@gnu.org) and James Leu (jleu@mindspring.net).
Copyright (C) 2001 by various other people who didn't put their name here.
Copyright (C) 2004 IBM Corp.
Copyright (C) 2017 Glider bvba
Copyright (C) 2007 Wolfgang Grandegger <wg@grandegger.com>
Copyright (C) 2010 Takashi Yoshii
Copyright (C) 2006 Filip Zyzniewski <filip.zyzniewski@tefnet.pl>
Copyright (C) 2005 Michael Gernoth <michael@gernoth.net>
Copyright (C) 2007 Alex Dubov <oakad@yahoo.com>
Copyright (C) 2006 Red Hat, Inc., Markus Armbruster <armbru@redhat.com>

Copyright (c) 2001-2002 Silicon Graphics, Inc. All Rights Reserved.
Copyright (c) 2004 Red Hat, Inc., James Morris <jmorris@redhat.com>
Copyright (C) 2011-2013 NVIDIA Corporation
Copyright 2012 Linaro Ltd. Anton Vorontsov <anton.vorontsov@linaro.org>
Copyright (c) 2017 Samsung Electronics Co., Ltd. http://www.samsung.com
Copyright (C) 2009 Daniel Hellstrom (daniel@gaisler.com) Aeroflex Gaisler AB
Copyright (C) 2009 Konrad Eisele (konrad@gaisler.com) Aeroflex Gaisler AB
Copyright (C) 2016-17 Horms Solutions, Simon Horman
Copyright (C) 2009 Magnus Damm
Copyright 2001 Compaq Computer Corporation.
Copyright 2004-2005 Phil Blundell
Copyright (c) 2003, 2004 Maciej W. Rozycki
Copyright (C) 2010 DENX Software Engineering GmbH Heiko Schocher <hs@denx.de>
Copyright (C) 2011 LAPIS Semiconductor Co., Ltd.
Copyright (C) 2016-2018 Linaro Ltd.
Copyright (C) 2018 Cryptera A/S
Copyright (C) 2012 Google, Inc. Will Drewry <wad@chromium.org>
Copyright (c) 1998-2003 InnoSys Incorporated. All Rights Reserved
Copyright 2010 Cavium Networks
Copyright (C) IBM Corporation, 2002, 2004
Copyright 2006, Devicescape Software, Inc.
Copyright Alan Cox GW4PTS (alan@lxorguk.ukuu.org.uk)
Copyright Tomi Manninen OH2BNS (oh2bns@sral.fi)
Copyright (C) 2005-2017 Andes Technology Corporation
Copyright (C) 2008-2009 PetaLogix
Copyright (c) 2007 - 2008 Jacob Jun Pan <jacob.jun.pan@intel.com>
Copyright (C) 2009-11 Texas Instruments.
Copyright (C) 1997, 1998 Jay Estabrook
Copyright (C) 1998, 1999, 2000 Richard Henderson
Copyright 2006 Felix Fietkau <nbd@openwrt.org>
Copyright (C) 2008 Hans Verkuil <hverkuil@xs4all.nl>
Copyright (C) 2008 Red Hat, Inc. Steven Rostedt <srstedt@redhat.com>
Copyright (C) 2004 Andrew de Quincey
Copyright (C) 1999-2003 Ralph Metzler & Marcus Metzler for convergence integrated media GmbH
Copyright (C) 2015, Motorola Mobility.
Copyright (c) 2003 Felix Domke <tmbinc@elitedvb.net>
Copyright (C) 2005-6 Patrick Boettcher <pb@linuxtv.org>
Copyright 2007 Steven Rostedt, Red Hat, Inc.
Copyright 2007,2014 Andrea Merello <andrea.merello@gmail.com>
Copyright 2004-2005 Andrea Merello <andrea.merello@gmail.com>, et al.
Copyright Realtek corp. available in drivers/staging/rtl8187se directory of Linux 3.14) other GPL, unpublished (until now), Linux driver code,
Copyright (C) 2016 T-Platforms. All Rights Reserved.
Copyright (C) 2016 Advanced Micro Devices, Inc. All Rights Reserved.
Copyright (c) 2005, 2006, 2007, 2008 Mellanox Technologies. All rights reserved.
Copyright IBM Corp. 2001, 2018
Copyright (C) 1996 Cort Dougan <cort@cs.nmt.edu> Adapted for Power Macintosh by Paul Mackerras. Low-level exception handlers and MMU support rewritten by Paul Mackerras.
Copyright (C) 1996 Paul Mackerras.
Copyright © 1997-1999 Janos Farkas <chexum@shadow.banki.hu>
Copyright © 1991, 1992 Linus Torvalds
Copyright © 1993 Ray Burr
Copyright © 1996 Hans-Joachim Widmaier
Copyright(C) 2007 Red Hat, Inc
Copyright (c) 2011-2013 MaxLinear, Inc. All rights reserved which was released under GPL V2
Copyright 1999 D. Jeff Dionne <jeff@rt-control.com>
Copyright 2006 Greg Ungerer <gerg@snapgear.com>

LICENCE TERMS (cont.)

Copyright 2014 Freescale Semiconductor, Inc.
Copyright (C) 2016 CNEX Labs Initial release: Javier Gonzalez <javier@cnexlabs.com> Matias Bjorling <matias@cnexlabs.com>
Copyright (C) 2004 Luis R. Rodriguez <mcgrof@ruslug.rutgers.edu>
Copyright (c) Logic Product Development, Inc. 2007 Peter Barada <peterb@logicpd.com>
Copyright (c) MontaVista Software, Inc. 2008. Anton Vorontsov <avorontsov@ru.mvista.com>
Copyright 2012 Benjamin Herrenschmidt, IBM Corporation
Copyright (c) 2015 System Fabric Works, Inc. All rights reserved.
Copyright (C) 2008 Wolfram Sang, Pengutronix
Copyright (c) 2010 NVIDIA Corporation.
Copyright (C) 2016 Linaro Ltd.
Copyright (c) 2019, Linaro Limited
Copyright (C) 1995-2000 Russell King.
Copyright (C) 2004-2005 Nokia Corporation. Dynamic Tick Timer written by Tony Lindgren <tony@atomide.com> and Tuukka Tikkanen <tuukka.tikkanen@elektrobit.com>.
Copyright (C) 2000, 2001 Silicon Graphics, Inc.
Copyright (C) 2008 Hewlett-Packard Development Company, L.P. Bjorn Helgaas <bjorn.helgaas@hp.com>
Copyright (C) 2011 Tobias Klauser <tklauser@distanz.ch>
Copyright (c) BayLibre, SAS. Author : Neil Armstrong <narmstrong@baylibre.com>
Copyright (C) 2004 Arcom Control Systems Ltd <linux@arcom.com>
Copyright (C) 2005 MontaVista Software Inc. <source@mvista.com>
Copyright (c) 2017 Vadim Pasternak <vadimp@mellanox.com>
Copyright (C) 2008 Atmel
Copyright (c) 2011-2014 PLUMgrid, <http://plumgrid.com>
Copyright 2017 Google Inc.
Copyright 2017 Samuel Holland <samuel@sholland.org>
Copyright (c) 2008 - 2012 QLogic Corporation. All rights reserved.
Copyright 2007 Freescale Semiconductor Inc.
Copyright 2008 Simtec Electronics <http://armlinux.simtec.co.uk/> Ben Dooks <ben@simtec.co.uk>
Copyright (C) 2000-2001 Deep Blue Solutions Ltd.
Copyright 2006, 2007, Michael Buesch <m@buesch>
Copyright 2011, 2012, Hauke Mehrtens <hauke@hauke-m.de>
Copyright (C) 2018 Song Qiang <songqiang1304521@gmail.com>
Copyright (c) 2016 Ivan Vecera <cera@cera.cz>
Copyright (C) 2013-2014 Linaro Ltd.
Copyright (c) by Takashi Iwai <tiwai@suse.de>
Copyright (c) by Scott McNab <sdm@fractalgraphics.com.au>
Copyright (C) 2010 Magnus Damm
Copyright (C) 2008 Yoshihiro Shimoda
Copyright(C) 1996 David S. Miller
Copyright(C) 1996 Eddie C. Dost
Copyright(C) 1996,1998 Jakub Jelinek
Copyright (c) 2005, 2010-2011, Wind River Systems All rights reserved.
Copyright (C) 2014 Google, Inc.
Copyright (C) 2012 Ivaylo Dimitrov <freemangordon@abv.bg>
Copyright (C) 2013 Pali Rohár <pali.rohar@gmail.com>
Copyright (c) 2011 Mircea Gherzan <mgherzan@gmail.com>
Copyright (C) 2006 -2008 Gerard Klaver <gerard at gkall dot hobby dot nl>
Copyright (C) 2007 Sam Revitch <samr7@cs.washington.edu>
copyright notice, this list of conditions and the following disclaimer in the documentation and/or other materials provided with the distribution. 3. Neither the name of the University nor the names of its contributors may be used to endorse or promote products derived from this
Copyright 2004 MontaVista Software Inc.
Copyright 2007 IBM Corporation
Copyright 2008 Giuseppe Coviello <gicoviello@gmail.com>
Copyright (C) 2007 MontaVista Software Inc.
Copyright (C) 2009 Provigent Ltd.

Copyright (C) 2004-2010 Nokia Corporation
Copyright (C) 2003 Al Borchers (alborchers@steinerpoint.com)
Copyright (C) 2008 by David Brownell
Copyright (c) 2003 ARM Limited All Rights Reserved
Copyright (c) 2016 Krzysztof Blazkowski All rights reserved.
Copyright (C) 2015 Thomas Meyer (thomas@m3y3r.de)
Copyright (C) 2000 - 2007 Jeff Dike (jdike@{addtoit,linux.intel}.com)
Copyright 2003 PathScale, Inc.
Copyright (C) 2010 SUSE Linux Products GmbH
Copyright (C) 2010 Tejun Heo <tj@kernel.org>
Copyright (C) 2003 Red Hat
"Copyright (C) 2007-2008 MontaVista Software, Inc."
"Copyright (C) 2007-2008 Bartlomiej Zolnierkiewicz "
Copyright (C) 2013, Samsung Electronics Co., Ltd.
Copyright (c) 2011-2017 Qualcomm Atheros, Inc.
Copyright (C) 2001 Utz-Uwe Haus <haus@uuhaus.de>
Copyright (c) 2007-2010 Vasily Khoruzhick
Copyright 2009 Secret Lab Technologies Ltd.
Copyright 2007 Ben. Herrenschmidt <benh@kernel.crashing.org>, IBM Corp.
Copyright (C) 2012 Intel Corp
Copyright (C) 2012 Durgadoss R <durgadoss.r@intel.com>
Copyright (C) 2012 Linaro, Inc.
Copyright (C) 2017 Free Electrons, Quentin Schulz <quentin.schulz@free-electrons.com>
Copyright (C) 2000 LASAT Networks A/S.
Copyright 2003 Simon Kelley.
copyright(C) Benjamin Reed,
copyright(C) David Hinds.
Copyright(C) Benjamin Reed,
Copyright(C) David Hinds.
Copyright (C) 2000, 2004 Intel Corp Rohit Seth <rohit.seth@intel.com> Suresh Siddha <suresh.b.siddha@intel.com>
Gordon Jin <gordon.jin@intel.com>
Copyright (C) 1999 Walt Drummond <drummond@valinux.com>
Copyright (C) 2016 Luc Maranget <luc.maranget@inria.fr> for Inria
Copyright (C) 2017 Alan Stern <stern@rowland.harvard.edu>, Andrea Parri <parri.andrea@gmail.com>
Copyright (C) 2009 Axel Kollhofer <rain_maker@root-forum.org> <http://rt2x00.serialmonkey.com>
Copyright 2012 Roland Stigge <stigge@antcom.de>
Copyright (C) 2005 Michel Xhaard mxhaard@magic.fr
Copyright 2016-2017 Cisco Systems, Inc. and/or its affiliates. All rights reserved.
Copyright (c) 2005 Sun Microsystems, Inc. All rights reserved.
Copyright (C) 2013 Intel Corporation Author: Tim Chen <tim.c.chen@linux.intel.com>
Copyright (C) 2001 Sun Microsystems, Inc.
Copyright (C) 2003 Red Hat Inc
"Copyright (C) 2005-2010 MontaVista Software, Inc. "
Copyright (c) 2016-2018 Christoph Hellwig.
Copyright (C) 2017 Oracle. All Rights Reserved.
Copyright (c) 2003 Adrian Sun (asun@darksunrising.com)
Copyright (C) 2009 Hans de Goede <hdegoede@redhat.com>
Copyright (c) 1999-2006 Mark W. McClelland
Copyright (c) 2003 Joerg Heckenbach Many improvements by Bret Wallach <bwallac1@san.rr.com> Color fixes by Orion Sky Lawlor <olawlor@acm.org> (2/26/2000) OV7620 fixes by Charl P. Botha <cpbotha@ieee.org>
Changes by Claudio Matsuoka <claudio@conectiva.com>
Copyright (c) 2004-2007 Romain Beauxis <toots@rastageeks.org> Support for OV7670 sensors was contributed by Sam Skipsey <aoanla@yahoo.com>
Copyright(c) 2015 - 2017 Intel Deutschland GmbH
Copyright 2000 VA Linux Systems, Inc., Fremont, California. All rights reserved.
Copyright © 2013 Jussi Kivilinna <jussi.kivilinna@iki.fi>
Copyright 2009 Wolfson Microelectronics plc

LICENCE TERMS (cont.)

Copyright (C) 2000-2004 Netfilter Core Team <coreteam@netfilter.org>
Copyright (C) 2005 Andriy Skulysch
Copyright (C) 2003-2005 PLX Technology, Inc.
Copyright (C) 2014 Ricardo Ribalda - Qtechnology/AS
Copyright (C) 2019 Renesas Electronics Corp.
Copyright (C) 2004,2007 Bartlomiej Zolnierkiewicz
Copyright (c) 2007-2009, Christian Lamparter <chunkeey@web.de>
Copyright 2004-2006 Jean-Baptiste Note <jbnote@gmail.com>, et al. stlc45xx driver
Copyright (C) 2008 Nokia Corporation and/or its subsidiary(-ies).
Copyright (c) 2014 Intel Corporation Author: Tomasz Bursztyka <tomasz.bursztyka@linux.intel.com>
Copyright(c) 2019 - 2020 Intel Corporation
Copyright(c) 2019 - 2020 Intel Corporation All rights reserved.
Copyright (C) 2006-2008 Red Hat, Inc., Markus Armbruster <armbru@redhat.com>
Copyright (C) 2017 Broadcom
Copyright 2018-2020 NXP
Copyright (C) 2006 Oliver Endriss
Copyright (c) 2008-2010 Intel Corporation. All rights reserved.
Copyright (c) 2006 ATI Technologies Inc.
Copyright (c) 2008 NVIDIA Corp. All rights reserved.
Copyright (c) 2008 Wei Ni <wni@nvidia.com>
Copyright (c) 2004 Topspin Corporation. All rights reserved.
Copyright (c) 2004, 2005 Voltaire Corporation. All rights reserved.
COPYRIGHT(c) LAP send messages
Copyright(c) LAP send messages
Copyright (C) 2000 Linuxcare, Inc.
Copyright 2009 Christian Pellegrin EVOL S.r.l.
Copyright 2007 Raymarine UK, Ltd. All Rights Reserved.
Copyright 2006 Arcom Control Systems Ltd.
Copyright (C) 2016-2017 EPAM Systems Inc.
Copyright (c) 2005 Intel Corporation. All rights reserved.
Copyright (C) 2018 Lorenzo Bianconi <lorenzo.bianconi83@gmail.com>
Copyright (C) 2018 Stanislaw Gruszka <stf_xl@wp.pl>
Copyright 2012 Armadeus Systems <support@armadeus.com>
Copyright 2012 Sascha Hauer, Pengutronix
Copyright (C) 2016 Cogent Embedded, Inc.
Copyright 2006-2015 Solarflare Communications Inc.
Copyright (c) 2006 - 2012 QLogic Corporation. All rights reserved.
Copyright (C) 1997, 1998 Martin Mares <mj@atrey.karlin.mff.cuni.cz>
Copyright 2007 IBM, Inc. by Konrad Rzeszutek <konrad@linux.vnet.ibm.com>
Copyright 2008 by Konrad Rzeszutek <ketuzsezr@damok.org>
Copyright 2010 Silicon Turnkey Express LLC.
Copyright (C) 2007 Dmitry Torokhov
Copyright 2009 Johannes Berg <johannes@sipsolutions.net>
Copyright (C) 2009 Embedian Inc.
Copyright (C) 2009 TMT Services & Supplies (Pty) Ltd.
Copyright (C) 2017 - 2018 Hauke Mehrkens <hauke@hauke-m.de>
Copyright (C) 2010 LSI Corporation.
Copyright (c) 2008 Wind River Systems, Inc.
Copyright (C) 2011 Antti Palosaari <crope@iki.fi>
Copyright (C) 2012 Thomas Mair <thomas.mair86@googlemail.com>
copyright (c) 2001,2002 Sun Microsystems (thockin@sun.com) Further contributions from Cesar Barros, Erik Gilling, Tim Hockin and Wim Van Sebreeck.
Copyright (C) 2005 Jeff Dike (jdike@karaya.com)
Copyright (C) 1998 by the FundsXpress, INC.
Copyright (C) 2008 Koninklijke Philips Electronics NV.
Copyright 2005-2007 Freescale Semiconductor
Copyright (c) 2009 Alberto Panizzo <maramaopercheseimorto@gmail.com>

Copyright (C) 2009 Valentin Longchamp, EPFL Mobots group
Copyright (C) Andrew Tridgell 2001
Copyright (c) 2002 Mark D. Stuebaker <midxyz123@yahoo.com> With assistance from Trent Piepho <xzyzy@speakeasy.org>
Copyright (C) 2012 Texas Instruments Inc.
Copyright (C) 1999 D. Jeff Dionne
Copyright (C) 2001 Georges Menie, Ken Desmet
Copyright(c) 2001 Lineo, Inc
Copyright (C) 2007 Bartlomiej Zolnierkiewicz
Copyright (C) 2015 Huawei Inc.
Copyright (C) 2017 Nicira, Inc.
Copyright (C) 2019 Isovalent, Inc.
Copyright (C) 2005 Varma Electronics Oy, by Andrey Volkov <avolkov@varma-el.com>)
Copyright (C) 2003-2004 MontaVista, Software, Inc. by Dale Farnsworth <dfarnsworth@mvista.com>)
Copyright (c) 2017, Linaro Ltd.
Copyright (c) 2003-2004, M Williamson, K Fraser
Copyright (c) 2005 Dan M. Smith, IBM Corporation
Copyright (c) 2010 Daniel Kiper
Copyright (C) 2018 Cogent Embedded, Inc.
Copyright (C) 2019, Intel Corporation
Copyright 2001 Patrick Mochel <mochel@osdl.org>
Copyright (C) 2013 Linaro.
Copyright (C) 2004 by Symmetric Systems Ltd (NZ)
Copyright (C) 2006-2007 Jiri Kosina
Copyright (C) 2007 David Sterba
Copyright (c) 2013 Samsung Electronics Co., Ltd. Author: Padmavathi Venna <padma.v@samsung.com>
Copyright (C) 2006 Mike Christie
Copyright (C) 2008 Hannes Reinecke <hare@suse.de>
Copyright(C) 1994-2001 Russell King
Copyright (C) 2010 Devin Heitmueller <dheitmueller@kernellabs.com>
Copyright (C) 2004 Hyok S. Choi
Copyright © 2003 Kartikey Mahendra Bhatt <kartik_me@hotmail.com>
Copyright © 2012 Jussi Kivilinna <jussi.kivilinna@mbnet.fi>
Copyright (C) 1996 Paul Mackerras (paulus@samba.org)
Copyright (C) 2009 Thomas Chou <thomas@wytron.com.tw>
Copyright (C) 2008 Henrik Kurelid <henrik@kurelid.se>
Copyright 2013 IBM Corp.
Copyright by Michal Miroslaw, 2008-2009
Copyright (C) 2000 by Colin Ngam
Copyright (c) 2014 Linaro Ltd.
Copyright (C) 2006 STMicroelectronics Pvt. Ltd.
Copyright (C) 2004 Markus Schulz <msc@antzsystem.de> Support for TDA10021
Copyright (c) 2016,2017 Facebook
Copyright (c) 2009 Cyber Switching, Inc. Author: Chris Verges <chrisv@cyberswitching.com>
Copyright (c) 2006-2011 Michael Hennerich <michael.hennerich@analog.com>
Copyright (c) 2001-2002 Intel Corp.
Copyright (c) 2002 Nokia Corp.
Copyright (c) 2009 Daniel Mack <daniel@caiaq.de>
Copyright (C) 2004 Texas Instruments
Copyright (C) 2004 David Brownell
Copyright (c) 2016, Mellanox Technologies. All rights reserved.
Copyright (C) 2010 Jean Delvare <jdelvare@suse.de>
Copyright (C) 2013-2019 Texas Instruments Incorporated - <http://www.ti.com>
Copyright (c) 2004 Joerg Albert <joerg.albert@gmx.de>
Copyright (c) 2004 Nick Jones
Copyright (c) 2004 Balint Seeber <n0_5p4m_p13453@hotmail.com>
Copyright (c) 2007 Guido Guenther <agx@sigxcpu.org>

LICENCE TERMS (cont.)

Copyright (c) 2007 Kalle Valo <kalle.valo@iki.fi>
Copyright (c) 2010 Sebastian Smolorz <sesmo@gmx.net>
Copyright(C) 1999 Benjamin Reed
Copyright(c) case (c): return #c static const char *at76_get_cmd_string(u8 cmd_status)
"Copyright(c) case (c): return #c static const char *at76_get_cmd_status_string(u8 cmd_status) "
Copyright (C) 2015 Cadence Design Systems Inc.
Copyright (C) 2001-2004 Stony Brook University
Copyright (C) 2004-2007 International Business Machines Corp. Author(s): Michael A. Halcrow <mahalcro@us.ibm.com> Michael C. Thompson <mcthomps@us.ibm.com>
Copyright(C) Copyright 1997-1998 DAVICOM Semiconductor,Inc. All Rights Reserved.
Copyright: (C) 2010 Julia Lawall, DIKU.
Copyright: (C) 2010 Gilles Muller, INRIA/LiP6. URL: http://coccinelle.lip6.fr/ Comments:
Copyright (C) 2004 IBM Corporation. All rights reserved.
Copyright (C) 2007 Florian Fainelli <florian@openwrt.org>
Copyright (C) 2008 Mistral Solutions
Copyright © 2010 David Woodhouse <dwmw2@infradead.org>
Copyright (C) 2014, Freescale Semiconductor, Inc.
Copyright © 2013 Tom St Denis <tstdenis@elliptictech.com> Based on crypto/xcbc.c:
Copyright © 2006 USAGI/WIDE Project, Author: Kazunori Miyazawa <miyazawa@linux-ipv6.org>
Copyright(c) 2009 Intel Corporation. All rights reserved.
Copyright (C) 2007 Secret Lab Technologies Ltd.
Copyright (C) 2013 Magnus Damm
Copyright (C) 2014 Ulrich Hecht
Copyright (C) 1999 The Puffin Group
Copyright (C) 2009, 2010 Arnaldo Carvalho de Melo <acme@redhat.com>
Copyright 1993 United States Government as represented by the Director, National Security Agency.
Copyright (c) 2004 Jaroslav Kysela <perex@perex.cz>
Copyright (c) 2012 Hans de Goede <hdegoede@redhat.com>
Copyright: (C) 2012 Gilles Muller, INRIA/LiP6. URL: http://coccinelle.lip6.fr/
Copyright(c) Stefan Eletzhofer (stefan.eletzhofer@inquant.de) 2003,4
Copyright (C) 1999 John G. Dorsey.
Copyright 2019 Vladimir Oltean <olteanv@gmail.com>
Copyright 2009 Holger Schurig, hs4233@mail.mn-solutions.de
Copyright (C) 2014 Maxime Ripard Maxime Ripard <maxime.ripard@free-electrons.com>
Copyright (C) 2015 Azael Avalos <coproscefalo@gmail.com>
Copyright (c) 2013 Hisilicon Limited.
Copyright (C) 2004-2005 Red Hat, Inc. All rights reserved.
Copyright (C) STMicroelectronics 2017 Author: Maxime Coquelin <mcoquelin.stm32@gmail.com>
Copyright (C) 2013 Andrey Smirnov
Copyright 2009-2011 Christian Lamparter <chunkeey@googlemail.com>
Copyright (c) 2007-2008 Atheros Communications, Inc.
Copyright (C) 1999 AbsoluteValue Systems, Inc. All Rights Reserved.
Copyright (C) 2016 PHYTEC Messtechnik GmbH
Copyright (C) 1992, 1998 Linus Torvalds, Ingo Molnar
Copyright (C) 2000, 2001 Ralf Baechle (ralf@gnu.org)
Copyright (C) 2007 Lemote Inc. & Institute of Computing Technology Author: Fuxin Zhang, zhangfx@lemote.com
Copyright 2006, 2007 Sony Corporation
Copyright (C) 2004 Stefan Holst (mail@s-holst.de), Uni-Stuttgart
Copyright (C) 2009 Daniel Hellstrom (daniel@gaisler.com),Konrad Eisele (konrad@gaisler.com) Aeroflex Gaisler AB
"Copyright (C) 1999 Martin Mares <mj@ucw.cz> "
Copyright (c) 2011-2017 Qualcomm Atheros, Inc.
Copyright (C) 2003, 2004 Paul Mundt
Copyright (c) 2014 Mathias Gottschlag <mgottschlag@gmail.com>
Copyright (C) Alan Cox GW4PTS (alan@lxorguk.ukuu.org.uk)
Copyright (C) Terry Dawson VK2KTJ (terry@animats.net)
Copyright (C) Tomi Manninen OH2BNS (oh2bns@sral.fi)
Copyright (C) 2000 Deep Blue Solutions Ltd.

Copyright (C) 1999 Stephane Eranian <eranian@hpl.hp.com>
Copyright 2014-2015 PMC-Sierra, Inc.
Copyright 2000,2009-2015 Hewlett-Packard Development Company, L.P.
Copyright 2006, 2007 Sony Corporation
Copyright (C) 2010 Hector Martin <hector@marcansoft.com>
Copyright (C) 2011 Andre Heider <a.heid@gmail.com>
Copyright(c) 2006 - 2007 Chris Snook <csnook@redhat.com>
Copyright(c) 2006 - 2008 Jay Cliburn <jcliburn@gmail.com>
Copyright 2019 Linaro, Ltd, Rob Herring <robh@kernel.org> */
Copyright(C) COPYRIGHT 2010-2018 ARM Limited. All rights reserved.
Copyright(c) 2008 - 2011 Intel Corporation. All rights reserved. All rights reserved.
Copyright (C) 2006-2011 Analog Devices, Inc.
Copyright (c) 2017 Western Digital Corporation or its affiliates.
Copyright (c) 2018 Oracle Corporation Author: Matthew Wilcox <willy@infradead.org>
copyright(C) 1999 Benjamin Reed. All Rights Reserved. Permission to use code in the Developer's manual was granted for this driver by Aironet. Major code contributions were received from Javier Achirica achirica@users.sourceforge.net> and Jean Tourrilhes <jt@hpl.hp.com>. Code was also int
Copyright (C) 2010 Steffen Klassert <steffen.klassert@secunet.com>
Copyright(c) 2013 - 2014 Intel Mobile Communications GmbH
Copyright (C) 2018 Intel Corporation
Copyright(c) 2013 - 2014 Intel Corporation. All rights reserved.
Copyright (C) 2018 Intel Corporation All rights reserved.
Copyright(c) 2005 - 2011 Intel Corporation. All rights reserved. All rights reserved.
Copyright (c) 1996 Cort Dougan <cort@cs.nmt.edu> Rewritten for PReP
Copyright (c) 1996 Paul Mackerras <paulus@cs.anu.edu.au> Low-level exception handlers, MMU support, and rewrite.
Copyright (c) 1997 Dan Malek <dmalek@jlc.net> PowerPC 8xx modifications.
Copyright (c) 1998-1999 TiVo, Inc. PowerPC 403GCX modifications.
Copyright (c) 1999 Grant Erickson <grant@lcase.umn.edu> PowerPC 403GCX/405GP modifications.
Copyright 2000 MontaVista Software Inc. PPC405 modifications PowerPC 403GCX/405GP modifications. Author: MontaVista Software, Inc. frank_rowand@mvista.com or source@mvista.com debbie_chu@mvista.com
Copyright (C) 2016 Cogent Embedded, Inc., <source@cogentembedded.com>
Copyright (c) 2007 Greg Kroah-Hartman <gregkh@suse.de>
Copyright (C) 2013 Marvell Inc. Author: Chao Xie <xiechao.mail@gmail.com>
Copyright (C) 1999, 2000, 01, 2002 Silicon Graphics, Inc.
Copyright (C) 2002 Broadcom, Inc. memcopy/copy_user author: Mark Vandevoorde
Copyright (C) 1992, 1993, 1994, 1995 Remy Card (card@masi.ibp.fr) Laboratoire MASI - Institut Blaise Pascal Universite Pierre et Marie Curie (Paris VI)
Copyright (C) 2016 Florian Fainelli <f.fainelli@gmail.com>
Copyright (C) 2013, 2014 Red Hat, Inc.
Copyright (C) 2008 Magnus Damm
Copyright (C) 2006, Sascha Hauer, Pengutronix
Copyright (C) 2008, Guennadi Liakhovetski <kernel@pengutronix.de>
Copyright (c) 2012-2013 Linaro Ltd.
Copyright 2012 Simon Arlott, Chris Boot, Stephen Warren
Copyright (C) 2009, 2012 Cavium, Inc.
Copyright (C) 2000 Silicon Graphics, Inc.
Copyright (C) 2007 Marvell International Ltd.
Copyright (C) 2014 Enric Balletbo i Serra <eballetbo@gmail.com>
Copyright (C) 2001 RidgeRun, Inc (glonnon@ridgerun.com)
Copyright (c) 2017 Amlogic, Inc. All rights reserved. Author: Xingyu Chen <xingyu.chen@amlogic.com>
Copyright (c) 2008-2010 Arnaud Patard <apatard@mandriva.com>
Copyright (c) 2013 Hongbing Hu <huhb@lemote.com>
Copyright (c) 2014 Huacai Chen <chenhc@lemote.com>
Copyright 2001 Jeff Garzik <jgarzik@pobox.com>
Copyright 2001 Sun Microsystems (thockin@sun.com)
Copyright 2002 Intel (eli.kupermann@intel.com, christopher.leech@intel.com, scott.feldman@intel.com)

LICENCE TERMS (cont.)

Copyright (C) Sun Microsystems 2008
Copyright IBM Corporation, 2007
Copyright IBM Corporation, 2007
Copyright 2007-2009 Stuart Bennett
Copyright (C) 1994 Martin Schaller
Copyright 2012, Hauke Mehrkens <hauke@hauke-m.de>
Copyright (c) 2016 BayLibre, Inc. Author: Neil Armstrong <narmstrong@kernel.org>
Copyright (C) 2003-2005 Yoichi Yuasa <yuasa@linux-mips.org>
Copyright (c) 2015 Takashi Sakamoto <o-takashi@sakamocchi.jp>
Copyright (c) 2009 - 2010 Guo-Fu Tseng <cooldavid@cooldavid.org>
Copyright (C) 2012-2018 ARM Ltd.
Copyright (C) 2013 Renesas Solutions Corp.
Copyright (C) 2002-2004 Sensoray Co., Inc.
Copyright (C) 1998 David S. Miller (davem@redhat.com)
Copyright(c) 2018 Intel Corporation
Copyright(c) 2018 Intel Corporation All rights reserved.
Copyright (C) 1997 Paul Mackerras.
Copyright (C) 1996 Paul Mackerras.
Copyright (C) 1998 Jon Howell
Copyright (C) 2011-2015 Freescale Semiconductor, Inc.
Copyright (C) 1996,2008 David S. Miller (davem@davemloft.net)
Copyright (C) 1996, 1997 Jakub Jelinek (jj@sunsite.mff.cuni.cz)
Copyright (C) 2018 Western Digital Corporation
Copyright © 2011-2013 Jussi Kivilinna <jussi.kivilinna@iki.fi>
Copyright(c) 2015 Bryan O'Donoghue <pure.logic@nexus-software.ie>
Copyright (C) 2008 STMicroelectronics.
Copyright (C) 2009 ST-Ericsson. Author: Srinidhi Kasagar <srinidhi.kasagar@stericsson.com>
Copyright (c) Andi Shyti <andi@etezian.org>
Copyright (C) 2007 Anti Sullin <anti.sullin@artecdesign.ee>
Copyright (c) 2009 Wind River Systems, Inc. All Rights Reserved.
Copyright 2001 MontaVista Software Inc.
Copyright (C) 2010 Texas Instruments, Inc. (Teerth Reddy et al.) <https://lkml.org/lkml/2010/6/18/4> <https://lists.linux-foundation.org/pipermail/linux-pm/2010-June/027422.html> <https://patchwork.kernel.org/patch/96442/>
Copyright (C) 2006 Rafael J. Wysocki <rjw@sisk.pl>
Copyright (C) 2008-2009 Red Hat, Inc., Peter Zijlstra
Copyright (C) 2009 Intel Corporation, <markus.t.metzger@intel.com>
Copyright (C) 2009 Google, Inc., Stephane Eranian
Copyright 2014 Tiler Corporation. All Rights Reserved.
Copyright (C) 2018 Andes Technology Corporation
Copyright line includes x86 and tile ones.
Copyright (c) 2014-2016 Advanced Micro Devices, Inc. All rights reserved.
Copyright 2008 Michael Wu <flamingice@sourmilk.net>
Copyright 2008 Luis Carlos Cobo <luisca@cozybit.com>
Copyright 2008 Michael Buesch <m@bues.ch>
Copyright 2008, 2009 Luis R. Rodriguez <lrodriguez@atheros.com>
Copyright 2008 Jouni Malinen <jouni.malinen@atheros.com>
Copyright 2008 Colin McCabe <colin@cozybit.com>
Copyright 2008 Sascha Hauer, kernel@pengutronix.de
Copyright (c) 2011-2016 Qualcomm Atheros, Inc.
Copyright (C) 2007-2009 PetaLogix
Copyright (C) 2003 John Williams <jwilliams@itee.uq.edu.au>
Copyright (c) 2017-2018 Linaro Limited.
Copyright 2012 Freescale Semiconductor Inc.
Copyright (c) 2007 - 1012 Jean Delvare <jdelvare@suse.de>
Copyright 2019, Hari Bathini, IBM Corporation.
Copyright (c) 2014 Open Grid Computing, Inc. All rights reserved.
Copyright (c) 2005-2007 Network Appliance, Inc. All rights reserved.
Copyright (C) 2012 Nobuhiro Iwamatsu <nobuhiro.iwamatsu.yj@renesas.com>
Copyright 2016-2019 NXP
Copyright (c) 2002 Jean-Francois Dive <jef@linuxbe.org>
Copyright (c) 2007 Nokia Siemens Networks
Copyright (c) 2010, Intel Corporation.
Copyright (c) Siemens AG, 2016-2020
Copyright (C) 2012 Regents of the University of California
Copyright (C) 2004 Lothar Wassmann
Copyright (C) 2004 Psion Teklogix
Copyright (C) 2004-2014 Emulex. All rights reserved. * EMULEX and SLI are trademarks of Emulex. * www.broadcom.com *
Copyright: (C) 2013 Gilles Muller, INRIA/LIP6. URL: <http://coccinelle.lip6.fr/> Comments:
Copyright (C) 2004 Alex Aizman
Copyright (C) 2005 Mike Christie based on code maintained by open-iscsi@googlegroups.com
Copyright (c) 2004, 2005, 2006 Voltaire, Inc. All rights reserved.
Copyright (c) 2005, 2006 Cisco Systems. All rights reserved.
Copyright (c) 2013-2014 Mellanox Technologies. All rights reserved.
Copyright 2015 Jonas Gorski <jogo@openwrt.org>
Copyright (c) 2014,2017 The Linux Foundation. All rights reserved.
Copyright (c) 2019, The Linux Foundation. All rights reserved.
Copyright (c) 2004-2007, 2010-2013, Wind River Systems All rights reserved.
Copyright (C) 2008-2011, Red Hat, Inc., Ingo Molnar
Copyright (C) 2008-2011, Red Hat, Inc., Peter Zijlstra
Copyright (C) 2015-2016 Samsung Electronics Igor Kotrasinski <i.kotrasinski@samsung.com> Krzysztof Opasiak <k.opasiak@samsung.com>
Copyright 2010 Freescale Semiconductor, Inc.
Copyright (c) 2009 MontaVista Software, Inc. Author: Anton Vorontsov <avorontsov@ru.mvista.com>
Copyright (c) 2013 Guenter Roeck
Copyright (C) 2004 - 2008 Red Hat, Inc. All rights reserved.
Copyright (c) 2018 Google, Inc.
Copyright (C) 2002 Paul Mundt
Copyright (c) 1996 John Shifflett, GeoLog Consulting
Copyright (c) 1996 John Shifflett, GeoLog Consulting
Copyright (c) 2011-2012,2017 Qualcomm Atheros, Inc.
Copyright (c) 2016-2017 Erik Stromdahl <erik.stromdahl@gmail.com>
Copyright (C) 2006 Yoshinori Sato
Copyright (C) 2005 Paul Mundt
Copyright 2002 by Kai Gernaschewski <kai@gernaschewski.name>
Copyright (C) 2017 Stafford Horne <shorne@gmail.com>
Copyright (C) 2007-2016 Mauro Carvalho Chehab Port to work with the in-kernel driver Cleanups, fixes, alsa-controls, etc.
Copyright (C) 2006 Markus Rechberger
Copyright (C) 2007-2016 Mauro Carvalho Chehab
Copyright(c) Daniel Phillips, 2001
Copyright (c) 2014-2015 QLogic Corporation. All rights reserved.
Copyright 2001 Intel San Luis Obispo
Copyright 2000,2001 MontaVista Software Inc.
Copyright (C) 1996 by Paul M. Antoine
Copyright (C) 1999 Silicon Graphics
Copyright (C) 2000 MIPS Technologies, Inc.
Copyright 2008 Intel Corporation remark
Copyright (C) 1998, 1999 Phil Blundell
Copyright (c) 2013, Carlo Caione <carlo.caione@gmail.com>
Copyright (c) 2018, Linaro Limited
Copyright (C) 2016 Jagannathan Teki <jteki@openedev.com>
Copyright (C) 1996 Paul Mackerras PPC44x/36-bit changes by Matt Porter (mporter@mvista.com)
Copyright (c) 2006 Dave Airlie <airlied@linux.ie>

LICENCE TERMS (cont.)

Copyright (C) 2005-2017 Andes Technology Corporation ifndef __ASM_VDSO_DATAPAGE_H define __ASM_VDSO_DATAPAGE_H
Copyright (c) 2008 Peter W. Morreale <pmorreale@novell.com>
Copyright (c) 2015 BMW Car IT GmbH
Copyright (C) 2005-2009 Freescale Semiconductor, Inc.
Copyright (C) 1999, Anthony Tong <atong@uiuc.edu>
Copyright (C) 2005 IBM Corporation.
Copyright (c) 2003 Kyle McMartin <kyle@debian.org>
Copyright (c) 2015 Essensium NV
Copyright (c) 2015 Melexis
Copyright (C) 2002 Dominik Brodowski <devel@brodo.de>
Copyright(c) Copyright 2008 Hewlett-Packard Development Company, L.P. Bjorn Helgaas <bjorn.helgaas@hp.com>
Copyright(C) 2007 Bartlomiej Zolnierkiewicz
Copyright (C) 2004 Red Hat
Copyright (C) 2000,2003 Grant Grundler (grundler at parisc-linux.org)
Copyright (C) 2002 Matthew Wilcox (willy at parisc-linux.org)
Copyright (C) 2000 David A. Schleef <ds@schleef.org>
Copyright (C) Christoph Hellwig, 2001-2002
Copyright (c) 2016 Facebook
Copyright 2004-2005 Andrea Merello <andrea.merello@gmail.com>, et al.
Copyright (C) 2016 Martin Blumenstingl <martin.blumenstingl@googlemail.com>
Copyright (c) 2014, QLogic Corporation
Copyright 2014 QLogic Corporation All rights reserved
Copyright (c) 2019, Martin Kelly.
Copyright 2006-2007 Pierre Ossman
Copyright(c) MontaVista Software, Inc. This program is licensed "as is" without any warranty of any kind, whether express or implied.
Copyright(c) 2015 Intel Deutschland GmbH
Copyright(c) 2018 Intel Corporation
Copyright 2013 Linaro Limited
Copyright (C) 2005 by Digi International Inc. All rights reserved.
Copyright (c) 2010-2011 Samsung Electronics Co., Ltd. http://www.samsung.com
Copyright (c) 2010-2011 Linaro Ltd. www.linaro.org
Copyright (C) 2015 Boris Barbulovski <bbarbulovski@gmail.com>
Copyright (C) 2002 Roman Zippel <zippel@linux-m68k.org>.\n"
Copyright (C) 2015 Boris Barbulovski <bbarbulovski@gmail.com>.\n\n" Bug reports and feature request can also be entered at http://bugzilla.kernel.org/\n"
Copyright (C) 2010-2011 ST Microelectronics
Copyright (C) 2013,2018 Intel Corporation
Copyright (C) 2006 by Ole Andre Vadla Ravnas (ActiveSync)
Copyright (C) 2002-2004 Timesys Corporation
Copyright (C) 2003-2004 Amit S. Kale <amitkale@linsyssoft.com>
Copyright (C) 2004 Pavel Machek <pavel@ucw.cz>
Copyright (C) 2004-2006 Tom Rini <trini@kernel.crashing.org>
Copyright (C) 2004-2006 LinSysSoft Technologies Pvt. Ltd.
Copyright (C) 2005-2009 Wind River Systems, Inc.
Copyright (C) 2008 Red Hat, Inc., Ingo Molnar <mingo@redhat.com>
Copyright (C) 1999 Johannes Erdfelt
Copyright (C) 1999 Gregory P. Smith
Copyright (C) 2001 Brad Hards (bhards@bigpond.net.au)
Copyright (C) 2012 Intel Corp (tianyuan.lan@intel.com)
Copyright(c) 2012 Intel Corporation. All rights reserved.
Copyright (c) 2004 Freescale Semiconductor, Inc
Copyright (C) 2008 by Nokia Corporation
Copyright (C) 2009 by Samsung Electronics Author: Michal Nazarewicz (mina86@mina86.com)
Copyright(c) worry about locking.
Copyright (C) 2000-2008 Silicon Graphics, Inc.

Copyright (c) 2006 MontaVista Software, Inc.
Copyright (C) 2001-2003 Andreas Gruenbacher, <agruen@suse.de>
Copyright (C) 2009 NetUP Inc.
Copyright (C) 2009 Igor M. Liplianin <liplianin@netup.ru>
Copyright (C) 2008 Marvell International Ltd. Eric Miao <eric.miao@marvell.com>
Copyright 2007 OProfile authors author Philippe Elie
Copyright 2010 Julia Lawall <julia@diku.dk>
Copyright 2010 Gilles Muller <Gilles.Muller@lip6.fr>
Copyright (c) 2003 Neil Brown <neilb@cse.unsw.edu.au>
Copyright (c) 2003-2005 Peter Osterlund <petero2@telia.com>
Copyright (c) 2004 Dmitry Torokhov <dtor@mail.ru>
Copyright (c) 2005 Vojtech Pavlik <vojtech@suse.cz>
Copyright (C) 2008, 2011 Nokia Corporation Kalle Jokiniemi Paul Walmsley
Copyright (C) 2001,2002,2003 Frank Mori Hess <fmhess@users.sourceforge.net>
Copyright (C) 2004 Salvador E. Tropea <set@users.sf.net> <set@ieee.org>
Copyright (C) 1995, 1996, 1997, 1998, 1999, 2001, 2002, 2003 Ralf Baechle
Copyright (C) 1996 Paul M. Antoine
Copyright (C) 1999, 2000 Silicon Graphics, Inc.
Copyright (c) 2016 Petr Kulhavy <petr@barix.com>
Copyright (C) 2007-2011 Emulex. All rights reserved. * EMULEX and SLI are trademarks of Emulex. * www.broadcom.com *
Copyright (C) 2009 Provigent Ltd.
Copyright (C) 2011, 2015, 2016 Intel Corporation.
Copyright (C) 2008 Nicolas Schichan <nschichan@freebox.fr>
Copyright (C) 2002 Peter Hettkamp <peter.hettkamp@htp-tel.de>
Copyright (C) 1999-2001 Ralph Metzler & Marcus Metzler for convergence integrated media GmbH
Copyright (C) 1998,1999 Christian Theiss <mistert@rz.fh-augsburg.de>
Copyright (c) 2016-2017, Microsemi Corporation
Copyright (c) 2017, Christoph Hellwig
Copyright (c) 2018, Eideticom Inc.
Copyright (C) 2014 Free Electrons
Copyright (C) 2001-2003 Stony Brook University
Copyright (C) 2004-2007 International Business Machines Corp. Author(s): Michael A. Halcrow <mahalcro@us.ibm.com> Michael C. Thompson <mcthomps@us.ibm.com> Tyler Hicks <tyhicks@ou.edu>
Copyright (C) 2003 Kartikey Mahendra Bhatt <kartik_me@hotmail.com>.
Copyright (c) 2000 Guillaume Delvit based on Gerd Knorr source and Eric Sandeen
Copyright(c) 2005-2008 Mauro Carvalho Chehab Some cleanups, code fixes, etc Convert it to V4L2 API
Copyright (C) 2006-2009 PetaLogix
Copyright (c) 2008 Jiri Slaby
Copyright (c) 2010 Don Prince <dhrince.devel@yahoo.co.uk>
Copyright 2013 Chen-Yu Tsai Chen-Yu Tsai <wens@csie.org>
Copyright (C) 2004 Olof Johansson <olof@lixom.net>, IBM Corporation
Copyright (c) 2002-2003, Jouni Malinen <jkmaline@cc.hut.fi>
Copyright (c) 2006 Cisco Systems. All rights reserved.
Copyright (c) 2003-2010 Cavium Networks (support@cavium.com). All rights reserved.
Copyright 2010, 2011 David Jander <david@protonic.nl>
Copyright 2015 Andrew Lunn <andrew@lunn.ch>
Copyright(c) container_of(c, struct tlc591xx_led, ldev)
Copyright (C) 2010 Alessandro Rubini
Copyright (C) 2010 Linus Walleij for ST-Ericsson
Copyright 2007 DENX Software Engineering, Stefan Roese <sr@denx.de>
Copyright (c) 2005 Cisco Systems. All rights reserved. Roland Dreier <rolandd@cisco.com>
Copyright (C) 2014 SUSE
Copyright (C) 2015 Josh Poimboeuf <jpoimboe@redhat.com>
"Copyright (C) 2001-2002 Andre Hedrick <andre@linux-ide.org>"
Copyright (C) 2003 Red Hat <alan@redhat.com>
Copyright (C) 2016-2019 Renesas Electronics Corp.

LICENCE TERMS (cont.)

Copyright (C) 2015 Renesas Electronics Corporation
Copyright(c) the licenses granted in Sections 2.2(a) and 2.2(b) are effective on the date Contributor first makes Commercial Use of the Covered Code.
Copyright(c) Representations. Contributor represents that, except as disclosed pursuant to Section 3.4(a) above, Contributor believes that Contributor's Modifications are Contributor's original creation(s) and/or Contributor has sufficient rights to grant the rights
Copyright (C) _____ All Rights Reserved.
Copyright 2007 Michael Buesch <m@bues.ch>
Copyright 1999 Roman Weissgaerber
Copyright 2000-2002 David Brownell
Copyright 1999 Linus Torvalds
Copyright 1999 Gregory P. Smith
Copyright 2005-2011 Broadcom Corporation
Copyright(c) 1999-2002 Gerd Knorr <kraxel@bytesex.org>
Copyright(c) 2000 Justin Schoeman <justin@suntiger.ee.up.ac.za>
Copyright(c) 2005-2006 Nickolay V. Shmyrev <nshmyrev@yandex.ru>
Copyright(c) 2006 Mauro Carvalho Chehab <mchehab@kernel.org>
Copyright (C) 2004 Andrew de Quincey (wol support)
Copyright (C) 2004 Carl-Daniel Haifinger (invalid MAC handling, insane IRQ rate fixes, bigendian fixes, cleanups, verification)
Copyright (c) 2004,2005,2006,2007,2008,2009 NVIDIA Corporation
Copyright (C) 2013 Freescale Semiconductor, Inc.
Copyright(c) 2012-2017 Intel Corporation. All rights reserved.
Copyright (C) 2004-2010 Freescale Semiconductor, Inc. All Rights Reserved.
Copyright (C) 2001 - 2005 Tensilica Inc.
Copyright (C) 2016 Marcel Hasler mahasler--a.t--gmail.com>
Copyright (C) 2010 R.M. Thomas rmthomas--a.t--sciulus.org>
Copyright (C) 2005 Calin A. Culianu <calin@ajvar.org>
Copyright (C) 2012-2013, NVIDIA Corporation
Copyright (C) 2006 FON Technology, SL.
Copyright (C) 2006 Imre Kaloz <kaloz@openwrt.org>
Copyright (C) 2006-2009 Felix Fietkau <nbd@openwrt.org>
Copyright (C) 1994, 1995, 1996, 1997, 1998 Ralf Baechle
Copyright (C) 1999 SuSE GmbH (Philipp Rumpf, prumpf@tux.org)
Copyright (C) 1999-2000 Grant Grundler
Copyright (c) 2005 Matthew Wilcox
Copyright (C) 2013-2014 Silicon Image, Inc.
Copyright (C) 2004 Olof Johansson, IBM Corporation and Ben. Herrenschildt, IBM Corporation
Copyright (C) 1992 Remy Card (card@masi.ibp.fr)
Copyright (C) 1992 Doug Evans
Copyright (C) 1993 Pascal Haible, Bruno Haible
Copyright (C) 1993 Bruno Haible
Copyright (C) 2009 Marek Vasut <marek.vasut@gmail.com>
Copyright (C) 2008 Renesas Solutions Corp. Kuninori Morimoto <morimoto.kuninori@renesas.com>
Copyright 2006-7 Jonathan Corbet <corbet@lwn.net>
Copyright (C) 2008, Guennadi Liakhovetski <kernel@pengutronix.de>
Copyright (C) 2006 Matt Callow
Copyright (C) 2003 David Brownell
Copyright (c) 2003-2005 Matthew Wilcox <matthew@wil.cx>
Copyright (C) 1998-2000 Gerard Roudier
Copyright (C) 1994 Wolfgang Stanglmeier
Copyright (C) 1997 Richard Waltham <dormouse@farsrobt.demon.co.uk>
Copyright (C) 1999 - 2001 Greg Kroah-Hartman (greg@kroah.com)
Copyright (C) 2013-2014 Christoph Hellwig
Copyright (C) 2002 STMicroelectronics Limited Author : Stuart Menefy
Copyright (C) 1995,1996 Olaf Kirch <okir@monad.swb.de>
Copyright (C) 2009 Roberto De Ioris <roberto@unbit.it>
Copyright (C) 2009 Jaya Kumar <jayakumar.lkml@gmail.com>
Copyright (C) 2009 Bernie Thompson <bernie@plugable.com>
Copyright 2003-2004 (c) MontaVista, Software, Inc.
Copyright (C) 2005, 2006 XenSource Ltd
Copyright (C) 2007 Solarflare Communications, Inc.
Copyright (C) 2012 Phil Edworthy
Copyright 2013 Maxime Ripard <maxime.ripard@free-electrons.com>
Copyright (C) 1997 Sten Wang
Copyright (c) 2017 Andi Shyti <andi@etezian.org>
Copyright 2005-06 Tower Technologies
Copyright 2005, Embedded Alley Solutions, Inc. Matt Porter <mporter@embeddedalley.com>
Copyright (C) 2008, 2009 Cavium Networks, Inc.
Copyright (C) 2015 Imagination Technologies
Copyright (C) 1999, 2000 Philipp Rumpf <prumpf@tux.org>
Copyright (C) 2001 Hewlett-Packard <bame@debian.org>
Copyright (c) 2000 Nokia Research Center Tampere, FINLAND
Copyright (c) 2006-2009 Red Hat Inc.
Copyright (c) 2006-2008 Intel Corporation Jesse Barnes <jesse.barnes@intel.com>
Copyright (c) 2007 Dave Airlie <airlied@linux.ie>
Copyright (C) 2018, Aidilab Srl.
Copyright (c) 1999-2016 Intel Corporation."
Copyright (c) 2008 Secret Lab Technologies Ltd.
Copyright (C) 1999,2000 MIPS Technologies, Inc. All rights reserved.
Copyright (c) 2001-2002, SSH Communications Security Corp and Jouni Malinen jkmaline@cc.hut.fi>
copyright 1999 The Puffin Group Inc.
Copyright (c) 2007 MontaVista Software, Inc. <source@mvista.com>
Copyright 1999 Derrick J Brashear (shadow@dementia.org)
Copyright (C) 2009 Wind River Systems, written by Ralf Baechle <ralf@linux-mips.org>
Copyright 2016 ZTE Corporation.
Copyright (C) 2009 Texas Instruments Incorporated - http://www.ti.com/
Copyright (C) 2000, Lineo (www.lineo.com) Yaroslav Vinogradov yaroslav.vinogradov@freescale.com
Copyright Freescale Semiconductor, Inc 2006
Copyright (c) 2006, emlix, Sebastian Hess <shess@hessware.de>
"Copyright 2014 Intel Corporation (Author: Johannes Berg)"
Copyright (C) 2005 Pekka Enberg
Copyright 2005 Andi Kleen <ak@suse.de>
Copyright 2004 Pavel Machek <pavel@suse.cz>
Copyright (C) 2012 Marvell Chao Xie <xiechao.mail@gmail.com>
Copyright: |copy| 1998 Andree Borrmann <a.borrmann@tu-bs.de>
Copyright (C) 2000, 2002-2003 Intel Co Asit Mallick <asit.k.mallick@intel.com> Suresh Siddha <suresh.b.siddha@intel.com> Kenneth Chen <kenneth.w.chen@intel.com> Fenghua Yu <fenghua.yu@intel.com>
Copyright (C) 2005 Hewlett-Packard Co Dan Magenheimer <dan.magenheimer@hp.com> Xen paravirtualization
Copyright (c) 2008 Isaku Yamahata <yamahata at valinux co jp> VA Linux Systems Japan K.K. pv_ops. Yaozu (Eddie) Dong <eddie.dong@intel.com>
Copyright (C) 2015 Industrial Research Institute for Automation and Measurements PIAP
Copyright (c) 2001,2002 Christer Weinigel <wingel@nano-system.com>,
Copyright IBM Corporation 2007
Copyright (c) 2018-2019 Linaro Ltd.
Copyright (C) 2004 Bruno Ducrot <ducrot@poupinou.org>
Copyright (C) 2006 Thomas Tuttle <linux-kernel@ttuttle.net>
Copyright (C) 2019 Micro Crystal AG Author: Alexandre Belloni <alexandre.belloni@bootlin.com>
Copyright(c) 2007 - 2011 Realtek Corporation. All rights reserved.
Copyright (c) IBM Corporation, 1998-2004.
Copyright (c) 2002, 2003 Tuukka Toivonen
Copyright (c) 2008 Erik Andr n
Copyright (c) 2013-2014 Hisilicon Ltd.
Copyright (c) 2013-2014 Linaro Ltd.

LICENCE TERMS (cont.)

Copyright (c) 2017 Andreas Färber
Copyright (c) 2018 Manivannan Sadhasivam
Copyright (c) 2005-2007, 2010-2013, Wind River Systems All rights reserved.
Copyright © 2015 Broadcom Corporation
Copyright (C) 2006 Arnd Bergmann <arnd@arndb.de>
Copyright (C) 2003-2005 David Hollis <dholllis@davehollis.com>
Copyright (C) 2005-2008 ARM
Copyright (C) 2006 Tower Technologies
Copyright (C) 2008 Paul Mundt
Copyright (c) 2006 by Mauro Carvalho Chehab , Ted Walther , John Sokol <sokol--a.t--videotechnology.com> http://v4l.videotechnology.com/
Copyright (c) 2010, Google Inc.
Copyright (C) 2003-2006 David Hollis <dholllis@davehollis.com>
Copyright 2009 Integrated Device Technology, Inc. Alex Bounine <alexandre.bounine@idt.com> Added Port-Write message handling Added Machine Check exception handling
Copyright (C) 2007, 2008, 2010, 2011 Freescale Semiconductor, Inc. Zhang Wei <wei.zhang@freescale.com> Lian Minghuan-B31939 <Minghuan.Lian@freescale.com> Liu Gang <Gang.Liu@freescale.com>
Copyright (C) 2004 Paul Mundt
Copyright © 1999-2010 David Woodhouse <dwmw2@infradead.org>
Copyright (C) 2013 Magnus Damm
Copyright (c) 2014 Advanced Micro Devices, Inc. All rights reserved.
Copyright (c) 2016, The Linux Foundation. All rights reserved.
Copyright (C) 2016 Zodiac Inflight Innovations
Copyright (C) 2002 Dag Arne Osvik <osvik@ii.uib.no> 2003 Herbert Valerio Riedel <hvr@gnu.org>
Copyright (C) 2011 - 2013 Samsung Electronics Co., Ltd.
Copyright (C) 2016 Toradex AG
Copyright (C) 2014 Fujitsu. All rights reserved.
Copyright (C) 2001-2002 Benjamin Herrenschmidt
Copyright (C) 2006-2007 Johannes Berg
Copyright (C) 2009 Paul Mundt
Copyright (C) 2004-2009 Red Hat, Inc. All rights reserved.
Copyright (C) 2004 Ladislav Michl
Copyright (C) 2009 Nuvoton PS Team
Copyright 2018 Google LLC.
Copyright 2012-2013, cozybit Inc.
Copyright (c) 2002 Vojtech Pavlik
Copyright 2017-2020 NXP
Copyright (c) 2004 Gerd Knorr
Copyright (c) 2004, 2005 Chris Pascoe
Copyright (C) 2006 George Kashperko <george@chas.com.ua>
Copyright (C) 2007 Herbert Valerio Riedel <hvr@gnu.org>
Copyright (C) 2006 Infosys Technologies Limited Toufeeq Hussain <toufeeq_hussain@infosys.com>
Copyright (C) 2001,2003 Greg Kroah-Hartman (greg@kroah.com)
Copyright (C) 2001 IBM Corp.
Copyright (C) 2006 Craig W. Nadler
Copyright 2007-2012 Siemens AG
Copyright (C) 2009 Nokia Corporation Contact: Felipe Balbi <felipe.balbi@nokia.com>
Copyright (C) 2013 Intel, Inc.
Copyright (C) 2014 Linaro Limited
Copyright (C) 2011-2016 Google, Inc.
Copyright (c) by James Courtier-Dutton <James@superbug.demon.co.uk>
Copyright (C) 2011 ARM Ltd. Author: Catalin Marinas <catalin.marinas@arm.com> based on arch/arm/mm/proc-v7-2level.S
"Copyright 2008-2010 Johannes Berg <johannes@sipsolutions.net>"
Copyright (C) 1999 Niibe Yutaka
Copyright (C) 1997, 1998, 1999, 2000, 2001, 2002, 2003 Ralf Baechle
Copyright (C) 2012 Rusty Russell IBM Corporation
Copyright (C) 2009 Greg Kroah-Hartman <gregkh@suse.de>
Copyright (C) 2009 Novell Inc.
Copyright (C) 2010,2011 NetUP Inc.
Copyright (c) 2014 SUSE LINUX Products GmbH
Copyright (C) 2000, 2001, 2002 Andi Kleen, SuSE Labs
"Copyright (C) 2011 Don Zickus Red Hat, Inc. "
Copyright (C) 2000-2005 Netfilter Core Team <coreteam@netfilter.org>
Copyright (c) 2006-2010 Patrick McHardy <kaber@trash.net>
Copyright 2002 Andi Kleen, SuSE Labs.
Copyright 2008 SigmaTel, Inc
Copyright 2008 Embedded Alley Solutions, Inc
Copyright (C) 2004-2007 International Business Machines Corp. Author(s): Michael A. Halcrow <mhalcrow@us.ibm.com> Michael C. Thompson <mcthomps@us.ibm.com>
Copyright (C) 2008-2011 Nokia Corporation
Copyright (C) 2008, Sascha Hauer <s.hauer@pengutronix.de>
Copyright (C) 2010, Baruch Siach <baruch@tkos.co.il>
Copyright (C) 2008 Intel Corp
Copyright (C) 2008 Zhang Rui <rui.zhang@intel.com>
Copyright (C) 2008 Sujith Thomas <sujith.thomas@intel.com>
Copyright (C) 2010 Nokia Corporation
Copyright (C) 2009, 2010 Paul Mundt
Copyright (c) 2008 Ryan Mallon
Copyright (C) 2005 Stefano Brivio <stefano.brivio@polimi.it>
Copyright (C) 2005, 2006 Michael Buesch <m@bues.ch>
Copyright (C) 2005 Danny van Dyk <kugelfang@gentoo.org>
Copyright (C) 2005 Andreas Jaggi <andreas.jaggi@waterwave.ch>
Copyright (c) 2004-2005, Wind River Systems All rights reserved.
Copyright (C) 2005-2007 MontaVista Software, Inc.
Copyright (C) 1999 Promise Technology, Inc. Author: Frank Tiernan (frankt@promise.com) Released under terms of General Public License
Copyright (C) 2012-2019 Linaro Ltd.
Copyright (c) 2005 Topspin Communications. All rights reserved.
Copyright (c) 2005 Open Grid Computing, Inc. All rights reserved.
Copyright (C) All BPF authors and contributors from 2014 to present. See git log include/uapi/linux/bpf.h in kernel tree for details.
Copyright (C) 2001 Ben. Herrenschmidt (benh@kernel.crashing.org) Modifications for ppc64:
Copyright (C) 2003 Dave Engebretsen <engebret@us.ibm.com>
Copyright (C) 2005 Stephen Rothwell, IBM Corporation
Copyright 2006 IBM Corporation.
Copyright (C) 2010 Paul Mundt
Copyright (c) 2009-2010, NVIDIA Corporation. Scott Peterson <speterson@nvidia.com>
Copyright (C) 1999-2002 Hewlett-Packard Co. David Mosberger-Tang <davidm@hpl.hp.com> Stephane Eranian <eranian@hpl.hp.com>
Copyright (C) 2005-2008 Intel Co. Fenghua Yu <fenghua.yu@intel.com> Bibo Mao <bibo.mao@intel.com>
Chandramouli Narayanan <mouli@linux.intel.com> Huang Ying <ying.huang@intel.com>
Copyright (C) 2011 Novell Co. Jan Beulich <JBeulich@suse.com>
Copyright (C) 2011-2012 Oracle Co. Liang Tang <liang.tang@oracle.com>
Copyright (c) 2014 Oracle Co., Daniel Kiper
Copyright(c) 2015-2017 Intel Deutschland GmbH
Copyright (c) 2016 Krzysztof Kozlowski
Copyright (C) 2015 Cadence Design Systems Inc. remark Read the file COPYING
Copyright (C) 2009 Daniel Ribeiro <drwyrn@gmail.com>
Copyright 2008 Simtec Electronics
Copyright (C) 2010-17 Digital Devices GmbH\n
Copyright (C) 2012 Texas Instruments
Copyright (C) 2007 Richard Betts, All Rights Reserved.
copyright (c) 2005 SDG Systems, LLC and,

LICENCE TERMS (cont.)

copyright (C) 2005-2006 Pierre Ossman
Copyright 2014 Andrea Merello <andrea.merello@gmail.com>
Copyright 2007 Michael Wu <flamingice@sourmilk.net>
Copyright 2007 Andrea Merello <andrea.merello@gmail.com>
Copyright (C) 2009 Texas Instruments, Inc
Copyright (c) 2002-3 Open Source Development Labs
Copyright (c) 2007 Greg Kroah-Hartman <gregkh@suse.de>
Copyright (c) 2007 Novell Inc.
Copyright (C) 2014 Amlogic, Inc.
Copyright (C) 1999, Trond Myklebust <trond.myklebust@fys.uio.no>
Copyright 2016-2020 NXP
Copyright (C) 1992, 1993, 1994, 1995 Remy Card (card@masi.ibp.fr) Laboratoire MASI - Institut Blaise pascal
Universite Pierre et Marie Curie (Paris VI)
Copyright (C) 1991, 1992 Linux Torvalds
Copyright (C) 2011-2012 Stephane Grosjean <s.grosjean@peak-system.com>
Copyright (C) 2003 Dave Engebretsen <engebret@us.ibm.com>
Copyright (C) 2002 MontaVista Software, Inc.
Copyright (C) 2004 Nokia Corporation by Tony Lindrgen <tony@atomide.com>
Copyright (C) 2004 Nokia Corporation by Imre Deak <imre.deak@nokia.com>
Copyright (C) 2009 Michael Buesch <m@buesch>
Copyright (C) 2018 Lorenzo Bianconi <lorenzo.bianconi83@gmail.com>
Copyright (c) 2018 Vitaly Chikunov <vt@altlinux.org>
Copyright (C) 2014 Intel Corporation
Copyright (c) 2005 James Simmons
Copyright (c) 2006 Maciej W. Rozycki
Copyright (C) 2011 Nobuhiro Iwamatsu
Copyright (C) 2001 Ian da Silva, Jeremy Siegel Based largely on io_se.c.
Copyright (C) 2015 Jens Kuske <jenskuske@gmail.com>
Copyright (C) 2002 - 2007 Jeff Dike (jdike@{addtoit,linux.intel}.com)
Copyright 1993 by OpenVision Technologies, Inc.
Copyright(C) 2005-2007, Red Hat, Inc., Ingo Molnar
Copyright(C) 2006-2007 Timesys Corp., Thomas Gleixner
Copyright (C) 2010 One Laptop per Child Author: Harald Welte <HaraldWelte@viatech.com> All rights reserved.
Copyright (C) 2009 Florian Fainelli <florian@openwrt.org>
Copyright (C) 2007 Patrick McHardy <kaber@trash.net>
Copyright (C) 2000 Goutham Rao <goutham.rao@intel.com>
Copyright (C) 2000, 2003 Hewlett-Packard Co David Mosberger-Tang <davidm@hpl.hp.com>
Copyright (C) 1994 Florian La Roche
Copyright (c) 2012 Guenter Roeck
Copyright (c) 2011 Manuel Stahl <manuel.stahl@iis.fraunhofer.de>
Copyright (c) 2012 Thorsten Nowak <thorsten.nowak@iis.fraunhofer.de>
Copyright (C) 1995 Eddie C. Dost (ecd@skynet.be)
Copyright (C) 1998 Jakub Jelinek (jj@sunsite.mff.cuni.cz)
Copyright (C) 2000 Anton Blanchard (anton@samba.org)
Copyright (C) 2010 NetUP Inc.
Copyright (C) 2010 Igor M. Liplianin <liplianin@netup.ru>
Copyright (c) 2008, Tungsten Graphics Inc. Cedar Park, TX., USA. All Rights Reserved.
Copyright (C) 2002 Dominik Brodowski <devel@brodo.de>
Copyright (c) 2014 FUKAUMI Naoki <naobsd@gmail.com>
Copyright [copy] 2001-2002 Alcôve <www.alcove.com>
Copyright [copy] 2000 Andrew Tridgell <tridgell@samba.org>
Copyright (C) 2000 Hewlett-Packard Co
Copyright (C) 2000 David Mosberger-Tang <davidm@hpl.hp.com>
Copyright (c) 2005 Andrea Bittau <a.bittau@cs.ucl.ac.uk>
Copyright (C) 2006-2010 Patrick McHardy <kaber@trash.net>
Copyright (C) 2014 Oleksij Rempel <linux@rempe-privat.de> Add Alphascale ASM9260 support.
Copyright (c) 2014 MundoReader S.L. Matthias Brugger <matthias.bgg@gmail.com>
Copyright (c) 2014, Sony Mobile Communications AB.
Copyright 1997-1999 Martin Mares <mj@ucw.cz>
Copyright (c) 2007 Intel Corp. Zhang Yanmin (yanmin.zhang@intel.com) Shaohua Li (shaohua.li@intel.com)
Copyright (c) 2014 Chelsio, Inc. All rights reserved.
Copyright 2007 Wind River Systems Inc.
Copyright 2005 Freescale Inc.
Copyright (C) 2004-2007 Texas Instruments, Inc. Merged to support both OMAP1 and OMAP2 by Tony Lindgren <tony@atomide.com>
Copyright (C) 2001 RidgeRun, Inc.
Copyright (C) 2009 Texas Instruments Added OMAP4 support - Santosh Shilimkar <santosh.shilimkar@ti.com>
Copyright (C) 2010 Texas Instruments Incorporated - http://www.ti.com/ Converted DMA library into DMA platform driver. G. Manjunath Kondaiah <manjugk@ti.com>
Copyright (c) 2007, Intel Corporation. All Rights Reserved.
Copyright (c) 2004-2012 Patrick McHardy <kaber@trash.net>
Copyright (c) 2002-2004 Bryan W. Headley <bwhheadley@earthlink.net>
Copyright (C) 2015-2016 Samsung Electronics Krzysztof Opasiak <k.opasiak@samsung.com>
Copyright 2008 Florian Fainelli <florian@openwrt.org>
Copyright: (C) 2012 Gilles Muller, INRIA/LiP6. URL: http://coccinelle.lip6.fr/ Comments: Options:
Copyright (C) 2002 Pete Zaitcev (zaitcev@yahoo.com)
Copyright (C) 2007 David S. Miller (davem@davemloft.net)
Copyright (C) 2017-2019 NXP
Copyright (C) 2009-2010 Jozsef Kadlec (kadlec@blackhole.kfki.hu)
"Copyright (c) 2018-2019 Intel Corporation "
Copyright (C) 2008-2009 Ralph Metzler <rjkm@metzlerbros.de>
Copyright (C) 2005-2007 Micronas\n
Copyright (C) 1997 Michael A. Griffith (grif@acm.org)
Copyright (C) 2015 John Horan (knasher@gmail.com)
Copyright (C) 2008 Scott Shawcroft (scott.shawcroft@gmail.com)
Copyright (C) 2001-2004 Greg Kroah-Hartman (greg@kroah.com)
Copyright (C) 2005 Johannes Berg (johannes@sipsolutions.net)
Copyright (C) 2005 Stelian Pop (stelian@popies.net)
Copyright (C) 2005 Frank Arnold (frank@scirocco-5v-turbo.de)
Copyright (C) 2005 Peter Osterlund (petero2@telia.com)
Copyright (C) 2005 Michael Hanselmann (linux-kernel@hansmi.ch)
Copyright (C) 2006 Nicolas Boichat (nicolas@boichat.ch)
Copyright (C) 1989, 1991 Free Software Foundation, Inc. 51 Franklin Street, Fifth Floor, Boston, MA 02110-1301 USA
Copyright (c) 2010-2012 Stephane Chatty <chatty@enac.fr>
Copyright (c) 2010-2012 Benjamin Tissoires <benjamin.tissoires@gmail.com>
Copyright (c) 2010-2012 Ecole Nationale de l'Aviation Civile, France
Copyright (c) 2012 Benjamin Tissoires <benjamin.tissoires@gmail.com>
Copyright (c) 2012 Ecole Nationale de l'Aviation Civile, France
Copyright (c) 2012 Red Hat, Inc
Copyright (C) 2002-2003 Dave Jones
Copyright (C) 1999 Jeff Hartmann
Copyright (C) 2004, Intel Corporation <jketreno@linux.intel.com>
Copyright (c) 2002 Pavel Machek <pavel@ucw.cz>
Copyright (C) 2000, 2001 Ralf Baechle <ralf@gnu.org>
Copyright (C) 2005 Ilya A. Volynets-Evenbakh <ilya@total-knowledge.com> swiped from i386, and cloned for MIPS by Geert, polished by Ralf. IP32 changes by Ilya.
Copyright (C) 2010 Cavium Networks, Inc.
Copyright (C) 1996-2005 Markus Franz Xaver Johannes Oberhumer All Rights Reserved.
Copyright (c) 1999-2008 Intel Corporation.
Copyright (C) 2015 Amlogic, Inc. All rights reserved.
Copyright (C) 2004 Novell, Inc. All rights reserved.
Copyright (C) 2004 IBM, Inc. All rights reserved.
copyright (c) 2001,2002 Sun Microsystems (thockin@sun.com)

LICENCE TERMS (cont.)

Copyright (C) 2003, 2004 Richard Curnow
Copyright (C) 2001 RidgeRun, Inc. Author: RidgeRun, Inc. Greg Lonnon (glonnon@ridgerun.com) or info@ridgerun.com
Copyright (c) 2008 Eurotech S.p.A. <info@eurotech.it>
Copyright (C) 2018 - 2019 Intel Corporation Authors: Luis Carlos Cobo <luisca@cozybit.com> Javier Cardona <javier@cozybit.com>
Copyright (c) 2018 IBM Corp.
Copyright (C) 1997 Jakub Jelinek (jakub@redhat.com)
copyright(C) Copyright ..." is shown in the HTML footer. Default is True. html_show_copyright = True
Copyright (C) 1996 David S. Miller (davem@caip.rutgers.edu)
Copyright 2004-2006 Jean-Baptiste Note <jbnote@gmail.com>, et al.
Copyright(c) Copyright 2000 Oleg Drokin <green@crimea.edu> Based on SoftDog driver by Alan Cox <alan@lxorguk.ukuu.org.uk>
Copyright (c) 2004 Texas Instruments. 1. Modified to support OMAP1610 32-KHz watchdog timer 2. Ported to 2.6 kernel
Copyright (c) 2005 David Brownell Use the driver model and standard identifiers
Copyright 2006-2007 Michael Ellerman, IBM Corp.
Copyright (C) 2000 Dave Kennedy
Copyright (c) 2019 BayLibre, SAS. Author: James Liao <jamesjj.liao@mediatek.com>
Copyright 2015, Anshuman Khandual, IBM Corporation.
Copyright 2011 - 2012 Bryan Wu <bryan.wu@canonical.com>
Copyright (C) 1998 Dave Perks <dperks@ibm.net>
Copyright (C) 2000 Serguei Miridonov <mirsev@cicese.mx>
Copyright (c) 1994 Alan Modra
Copyright (c) 1995 Markus Kuhn
Copyright (c) 1996 Ingo Molnar
Copyright (c) 1998 Andrea Arcangeli
Copyright (c) 2002,2006 Vojtech Pavlik
Copyright (c) 2003 Andi Kleen
Copyright 2012 Google, Inc
Copyright (c) 2003 - 2007 Francois Romieu <romieu@fr.zoreil.com>
Copyright (c) a lot of people too. Please respect their work.
Copyright (C) 2004-2007 Vladimir Lebedev <vladimir.p.lebedev@intel.com>
Copyright (C) 2001, 2002 Andy Grover <andrew.grover@intel.com>
Copyright (C) 2001, 2002 Paul Diefenbaugh <paul.s.diefenbaugh@intel.com>
Copyright (C) 2015-2018 Toke Høiland-Jørgensen <toke@toke.dk>
Copyright (C) 2014-2018 Dave Täht <dave.taht@gmail.com>
Copyright (C) 2015-2018 Sebastian Moeller <moeller0@gmx.de>
Copyright(C) 2015-2018 Kevin Darbyshire-Bryant <kevin@darbyshire-bryant.me.uk>
Copyright (C) 2017-2018 Ryan Mounce <ryan@mounce.com.au>
Copyright (C) 1999 Wolfgang Scherr <scherr@net4you.net>
Copyright (C) 2000 Serguei Miridonov <mirsev@cicese.mx> some corrections for Pinnacle Systems Inc. DC10plus card.
Copyright (c) 2005-2008 Christer Weinigel <christer@weinigel.se>
Copyright (C) 2004-2008 Ingo Molnar <mingo@redhat.com>
Copyright (C) 2007 Arnaldo Carvalho de Melo <acme@redhat.com>
Copyright (C) 2004-2006 Ingo Molnar
Copyright (C) 2004 Nadia Yvette Chambers
Copyright (C) 2004 Compulab Ltd.
Copyright (C) 2013-2015 Renesas Solutions Corp.
Copyright (c) 2007-2008 Intel Corporation Jesse Barnes <jesse.barnes@intel.com>
Copyright 2010 Red Hat, Inc.
Copyright (C) 2006 Dennis Munsie <dmunsie@cecropia.com>
Copyright (c) 2005, Christopher Clark
Copyright (C) 2005 Randy Dunlap
Copyright (C) 2006 SUSE Linux Products GmbH
Copyright (C) 2006 Hannes Reinecke

Copyright 2018 Cisco Systems, Inc. and/or its affiliates. All rights reserved.
Copyright (C) 2006-2008 Jiri Slaby <jirislaby@gmail.com>
Copyright (C) 1999 Makoto Kato (m_kato@ga2.so-net.ne.jp)
Copyright (2004, 2005) Ingo Molnar
Copyright (C) 2017 Free Electrons
Copyright (C) 2006 Texas Instruments, Inc
Copyright 2008 SlimLogic Ltd.
Copyright (C) 1999-2002 Hewlett-Packard Co. David Mosberger-Tang <davidm@hpl.hp.com> Stephane Eranian <eranian@hpl.hp.com>
Copyright 2010 Red Hat, Inc. and/or its affiliates.
Copyright 2008 DENX Software Engineering
Copyright (c) 2006-2008 Nick Kossifidis <mickflemm@gmail.com>
Copyright (C) 1999 Philipp Rumpf <prumpf@tux.org>
Copyright (C) 1999 SuSE GmbH
Copyright (C) 2007 Netfilter Core Team <coreteam@netfilter.org>
Copyright (C) 2007 USAGI/WIDE Project <http://www.linux-ipv6.org>
Copyright (c) 2015 Nordic Semiconductor. All Rights Reserved.
Copyright (C) 2011 - 2014 Cisco Systems Inc
Copyright (C) 2000 - 2007 Jeff Dike (jdike@{addtoit,linux.intel}.com)
Copyright (c) 2002 Patrick Mochel
Copyright 2006 Freescale Semiconductor, Inc. All rights reserved.
Copyright (C) 1999 David Mosberger-Tang <davidm@hpl.hp.com>
Copyright 2010 Red Hat, Inc. and/or its affiliates.
Copyright(C) 2015 Intel Corporation.
Copyright (C) 2010 Nokia Corporation. Eduardo Valentin
Copyright 2005-2007 Freescale Semiconductor, Inc. All Rights Reserved.
Copyright (C) 2009 Daniel Mack <daniel@caiaq.de>
Copyright (C) 1996,1997,1999 Jakub Jelinek (jakub@redhat.com)
Copyright (c) 2003 Felix Domke <tmbinc@elitedvb.net>
Copyright (C) 2007 Sascha Hauer, Marc Kleine-Budde, Pengutronix <s.hauer@pengutronix.de> Simon Kallweit, intefo AG <simon.kallweit@intefo.ch>
Copyright (c) 2010 Daniel Kiper
Copyright (c) 2018 Oleksandr Andrushchenko, EPAM Systems Inc.
Copyright (C) 2008-2010 Nokia Corporation
Copyright (C) 2004 Intel Corporation Ashok Raj <ashok.raj@intel.com>
Copyright 2016 NextThing Co
Copyright (c) 2013 Florian Fainelli <florian@openwrt.org>
Copyright (c) 2016 Andrew Lunn <andrew@lunn.ch>
Copyright (C) 2015 Glider bvba
Copyright (C) 2006-2009 Henrique de Moraes Holschuh <hmh@hmh.eng.br>
Copyright 2020 NXP
Copyright (C) 2004 Jamey Hicks <jamey.hicks@hp.com>
Copyright (c) 2015 Hisilicon Limited.
Copyright (C) 2009 Google, Inc., Stephane Eranian
Copyright (c) 2006 Greg Kroah-Hartman <gregkh@suse.de>
Copyright (c) 2006 Novell, Inc.
Copyright 2001, 2002 Red Hat.
Copyright(C) 2016 Intel Deutschland GmbH
Copyright (C) 2010 Matt Fleming
Copyright (c) 2012 David Dillow <dave@thedillows.org>
Copyright (c) 2006-2013 Jiri Kosina
Copyright (c) 2013 Colin Leitner <colin.leitner@gmail.com>
Copyright (c) 2014-2016 Frank Praznik <frank.praznik@gmail.com>
Copyright (c) 2010 Richard Nauber <Richard.Nauber@gmail.com>
Copyright (c) 2016 Yuxuan Shui <yshuiv7@gmail.com>
Copyright (c) 2018 William Whistler <wtbw@wtbw.co.uk>
Copyright (C) 2003 Fenghua Yu <fenghua.yu@intel.com> Change pt_regs_off() to make it less dependent on pt_

LICENCE TERMS (cont.)

regs structure.
Copyright (C) 2015 by Renesas Electronics Corporation
Copyright (C) 2009 Intel Corporation. All rights reserved.
Copyright (C) 2000-2001 VERITAS Software Corporation.
Copyright (C) 2002 Andi Kleen, SuSE Labs
Copyright (C) 2004 LinSysSoft Technologies Pvt. Ltd.
Copyright (C) 2007-2008 Jason Wessel, Wind River Systems, Inc.
Copyright (C) 2004 Intel Corporation <matthew.e.tolentino@intel.com>
Copyright (C) 2013 Tom Gundersen <teg@jklm.no>
Copyright (c) 2009 Dmitry Artamonow <mad_soft@inbox.ru>
Copyright (C) 2002 Jungo Software Technologies.
Copyright (C) 2003 MontaVista Software, Inc.
Copyright (C) 2012-2015 Altera Corporation
Copyright (C) 1998-1999 Pete Zaitcev (zaitcev@yahoo.com)
Copyright (C) 1997, 2003 Ralf Baechle
Copyright (C) 2001-2003 Liam Davies (ldavies@agile.tv)
Copyright (C) 2007 Yoichi Yuasa <yuasa@linux-mips.org>
Copyright (C) 2004-2008, Philipp Reisner <philipp.reisner@linbit.com>.
Copyright (C) 2004-2008, Lars Ellenberg <lars.ellenberg@linbit.com>.
Copyright (C) 2010 Google, Inc.
Copyright (C) 2007 Eurotech S.p.A. <info@eurotech.it>
Copyright © 2011, 2012 Roland Stigge
Copyright (C) 2009 - QLogic Corporation. All rights reserved.
Copyright © CC Computer Consultants GmbH, 2007 - 2008 Jan Engelhardt <jengelh@medozas.de>
Copyright (C) 2000, 2001, 2002 Andi Kleen, SuSE Labs
Copyright (C) 2001-2003, SnapGear Inc. (www.snapgear.com)
Copyright (c) 2018, Linaro Ltd. Author: Manivannan Sadhasivam <manivannan.sadhasivam@linaro.org>
Copyright(c) 2014 - 2015 Linaro Ltd. All rights reserved.
Copyright 2003, Instant802 Networks, Inc.
Copyright (c) 2016-2017 HiSilicon Technologies Co., Ltd.
Copyright (C) 2005-2006 Micronas USA Inc.*/ static int go7007_usb_vendor_request(struct go7007 *go, u16 request, u16 value, u16 index, void *transfer_buffer, int length, int in)
Copyright (C) 2005-2006 Micronas USA Inc.*/
Copyright (c) 2007, 2009 Anssi Hannula <anssi.hannula@gmail.com>
Copyright (c) 2008 Lukasz Lubojanski <lukasz@lubojanski.info>
Copyright 2009 Jonathan Corbet <corbet@lwn.net>
Copyright (C) 2004-2011 Red Hat, Inc. All rights reserved.
Copyright 2006, 2007, Michael Buesch <m@bues.ch>
Copyright (C) 1999, 2000 Niibe Yutaka & Kaz Kojima
Copyright (C) 2006 Lineo Solutions Inc. support SH4A UBC
Copyright (C) 2002 - 2008 Paul Mundt
Copyright (C) 2004 by Eric Van Hensbergen <ericvh@gmail.com>
Copyright (C) 1999 Andrew R. Baker (andrewb@uab.edu) - Indigo2 changes
Copyright (C) 2003 Ladislav Michl (ladis@linux-mips.org)
Copyright (C) 2004 Peter Fuerst (pf@net.alphadv.de)
Copyright (C) 2008 Ingo Molnar <mingo@redhat.com>
Copyright (C) 2005 XenSource Ltd
Copyright (c) by Kai Svahn <kai.svahn@nokia.com>
Copyright (c) 2003-2005 Zultys Technologies
Copyright 2007 David Gibson <dwg@au1.ibm.com>, IBM Corporation.
Copyright (C) 2008 Nokia Corporation Kalle Jokiniemi
Copyright (C) 2007 Texas Instruments, Inc. Lesly A M <x0080970@ti.com>
Copyright (c) 2008 Dmitry Baryshkov
Copyright (c) 2006-2007 Herbert Xu <herbert@gondor.apana.org.au>
Copyright (c) Evgeniy Polyakov <johnpol@2ka.mipt.ru> All rights reserved.
Copyright (C) 2013 Google, Inc
Copyright 2008 Atmel
Copyright (c) 2005 Maciej W. Rozycki
Copyright (C) 1998 Jakub Jelinek (jj@ultra.linux.cz)
Copyright 2017 Cadence Design Systems Inc.
Copyright (C) 2007-2008 Nokia Corporation
Copyright 2004 (c) MontaVista, Software, Inc.
Copyright (C) 2000 Oleg Drokin <green@crimea.edu>
Copyright (C) 2007 John Williams <john.williams@petalogix.com> based on v850 version which was
Copyright (C) 2001,02,03 NEC Electronics Corporation
Copyright (C) 2001,02,03 Miles Bader <miles@gnu.org>
Copyright (c) 2010-2011 EIA Electronics, Pieter Beyens <pieter.beyens@eia.be>
Copyright (C) 2001 MIPS Technologies, Inc. All rights reserved.
Copyright (C) 1999 - 2003 ARM Limited
Copyright (C) 2000 Deep Blue Solutions Ltd
Copyright (C) 2004 - 2006 Mike Christie
Copyright (C) 2004 - 2005 Dmitry Yusupov
Copyright (C) 2004 - 2005 Alex Aizman
Copyright (C) 2006-2008 Marvell International Ltd. Eric Miao <eric.miao@marvell.com>
Copyright (c) 2018 Amlogic, inc. Author: Qiufang Dai <qiuqiang.dai@amlogic.com> Author: Jian Hu <jian.hu@amlogic.com>
Copyright (C) 2004 by Ralf Baechle (ralf@linux-mips.org)
Copyright(C) Copyright TOSHIBA CORPORATION 2000-2001, 2004-2007
Copyright (c) 2009 Rafael J. Wysocki <rjw@sisk.pl>, Novell Inc.
Copyright (C) Tom Long Nguyen (tom.l.nguyen@intel.com)
Copyright (c) 2000 Mark Fletcher
Copyright 1997--2000 Martin Mares <mj@ucw.cz>
Copyright (C) 2018 Hauke Mehrtens <hauke@hauke-m.de>
Copyright (C) 2012, NVIDIA CORPORATION. All rights reserved.
Copyright (C) 1997 -- 2000 Martin Mares <mj@ucw.cz>
Copyright (C) 2003 -- 2004 Greg Kroah-Hartman <greg@kroah.com>
Copyright 2008, Michael Buesch <m@bues.ch>
Copyright (C) 1992 Remy Card (card@masi.ibp.fr) Laboratoire MASI - Institut Blaise Pascal Universite Pierre et Marie Curie (Paris VI) from
Copyright (c) 2005, 2006, 2007 Cisco Systems, Inc. All rights reserved.
Copyright (c) 2004 Voltaire, Inc. All rights reserved.
Copyright (C) 2008 by Sascha Hauer <kernel@pengutronix.de>
Copyright (C) 2009 by Valentin Longchamp <valentin.longchamp@epfl.ch>
Copyright (c) 2006 Herbert Xu <herbert@gondor.apana.org.au> CTR part based on code (crypto/ctr.c) by:
Copyright(C) Copyright IBM Corp. 2007 - Joy Latten <latten@us.ibm.com>
Copyright (c) 2003 ARM Limited.
Copyright 2008 Juergen Beisert, kernel@pengutronix.de
Copyright (C) 2006-2012 Patrick McHardy <kaber@trash.net>
Copyright (C) 1999 Paul 'Rusty' Russell & Michael J. Neuling
Copyright (C) 2000-2005 Netfilter Core Team <coreteam@netfilter.org>
Copyright (C) 2010-2011 Jaiganesh Narayanan <jnarayanan@atheros.com>
Copyright (C) 2008-2011 Gabor Juhos <juhosg@openwrt.org>
Copyright (C) 2010 Hitoshi Mitake <mitake@dcl.info.waseda.ac.jp>
Copyright (c) 2008-2009 Eurotech S.p.A. <info@eurotech.it>
Copyright (c) 2009-2010 NSN GmbH & Co KG <michael.lawnick.ext@nsn.com>
Copyright (c) 2004 Google, Inc. i2c-virtual.c from Brian Kuschak <bkuschak@yahoo.com>
Copyright (C) 2002 Frank Mori Hess <fmhess@users.sourceforge.net>
Copyright (c) 2000 by Silicon Graphics, Inc.
Copyright (c) 2001 MIPS Technologies, Inc.
Copyright (C) 2016 Icenowy Zheng Icenowy Zheng <icenowy@aosc.xyz>
Copyright (C) 2014 Chen-Yu Tsai Chen-Yu Tsai <wens@csie.org>
Copyright (C) 2014 Boris Brezillon Boris Brezillon <boris.brezillon@free-electrons.com>
Copyright 2007-2008 Michael Buesch <m@bues.ch>
Copyright (C) 2010 One Laptop per Child

LICENCE TERMS (cont.)

Copyright (C) 2006 Red Hat, Inc.
Copyright (C) 2006 Advanced Micro Devices, Inc.
Copyright (c) 2006 Ben Dooks
Copyright (c) 2006 Simtec Electronics Ben Dooks <ben@simtec.co.uk>
copyright IBM Corp. 2007
Copyright 2006 Stefan Roese, DENX Software Engineering
Copyright 2008 Sean MacLennan, PIKA Technologies
Copyright 2008 Frank Edelhaeuser, Spansion Inc.
Copyright (C) 2009 Samsung Electronics Co., Ltd. Author: Dongsoo Nathaniel Kim <dongsoo45.kim@samsung.com>
Copyright 2004 Motorola Inc.
Copyright (C) 2018 Cadence Design Systems Inc.
Copyright (C) 2011 Intel, Inc.
Copyright (C) 2013 Intel, Inc.
Copyright (C) 2014 Intel Corporation.
Copyright (C) 2009-2016 Emulex. All rights reserved. * EMULEX and SLI are trademarks of Emulex. * www.broadcom.com *
Copyright 2008 Simtec Electronics Ben Dooks <ben@simtec.co.uk>
Copyright (C) 1997 Martin Mares
Copyright (C) 2007 H. Peter Anvin
Copyright (C) 2001,2002 Andi Kleen, SuSE Labs
Copyright (C) 2003 Pavel Machek (pavel@ucw.cz)
Copyright (C) 2005 Stephen Street / StreetFire Sound Labs
Copyright (C) 2007 John Williams <john.williams@petalogix.com>
Copyright (C) 2007 - 2011 PetaLogix
Copyright (C) 2004 Amaury Demol for DiBcom
Copyright © 2019 Collabora Ltd.
Copyright (C) 1998 Phil Blundell
Copyright (C) 2006-2007 Nokia Corporation
Copyright (C) 2008-2009 MontaVista Software, Inc. <source@mvista.com>
Copyright (c) 2011-2014, Google Inc.
Copyright (C) 2001 Dave Kennedy
Copyright (C) 2001 Paul Bame <bame at parisc-linux.org>
Copyright (C) 2001-2003 Grant Grundler <grundler with parisc-linux.org>
Copyright (C) 2002-2003 Matthew Wilcox <willy at parisc-linux.org>
Copyright (C) 2002 Randolph Chung <tausq at parisc-linux.org>
Copyright (C) 2002-2007 Helge Deller <deller with parisc-linux.org>
Copyright 2008 Embedded Alley Solutions, Inc.
Copyright (C) 2000 Pavel Machek <pavel@suse.cz>
Copyright (C) 2000 Karsten Keil <kkeil@suse.de>
Copyright (C) 2001,2002 Andi Kleen <ak@suse.de>
Copyright (C) 2005 Eric Biederman <ebiederm@xmission.com>
Copyright (c) 2005, 2006, 2007 Cisco Systems. All rights reserved.
Copyright (c) 2005 PathScale, Inc. All rights reserved.
Copyright (c) 2006 Mellanox Technologies. All rights reserved.
Copyright (C) 1995,2002 Pete Zaitcev (zaitcev@yahoo.com)
Copyright (C) 1996 Eddie C. Dost (ecd@skynet.be)
Copyright (C) 1997,1998 Jakub Jelinek (jj@sunsite.mff.cuni.cz)
Copyright (C) 2009 Albert Herranz
Copyright 2004, Instant802 Networks, Inc.
Copyright 2007, Michael Wu <flamingice@sourmilk.net>
Copyright 2009, Johannes Berg <johannes@sipsolutions.net>
Copyright(c) 2018-2019 Intel Corporation
Copyright (C) 2011 Ed Wildgoose <kernel@wildgooses.com> and Philip Prindle <philipp@redfish-solutions.com>
Copyright (c) 2004 Infinicon Corporation. All rights reserved.
Copyright (c) 2004 Intel Corporation. All rights reserved.
Copyright (c) 2004-2007 Voltaire Corporation. All rights reserved.

Copyright (C) 2004 Silicon Graphics, Inc. Jesse Barnes <jbarnes@sgi.com>
Copyright (C) 2008 Jack Ren <jack.ren@marvell.com>
Copyright (C) 2008 Eric Miao <eric.miao@marvell.com>
Copyright (C) 2015 Linus Walleij <linus.walleij@linaro.org>
Copyright (C) 2013 Paratronic, Richard Genoud <richard.genoud@gmail.com>
Copyright (C) 2008, 2009 Steffen Klassert <steffen.klassert@secunet.com>
Copyright (c) 2013 Hisilicon Limited.
Copyright (C) 2002 ARM Ltd.
Copyright 2008 Freescale Semiconductor, Inc.
Copyright (C) 2006-2009 Patrick McHardy <kaber@trash.net>
Copyright(C) 2004 Venky Raju(dev@venky.ws)
Copyright © 2006-2007 Intel Corporation Jesse Barnes <jesse.barnes@intel.com>
Copyright (C) 2005 AXE,Inc.
Copyright (c) 2017-2018 Brian Masney <masneyb@onstation.org>
Copyright (C) 2008, 2010 Davide Rizzo <elpa.rizzo@gmail.com>
Copyright (c) 1997 Dan error_act (dmalek@jlc.net)
Copyright (c) 1999-2001 Dan Malek <dan@embeddedalley.com>
Copyright (c) 2000 MontaVista Software, Inc (source@mvista.com)
Copyright(c) MontaVista Software, Inc. Vitaly Bordug <vbordug@ru.mvista.com>
Copyright (C) 2008 Embedded Alley Solutions, Inc.
Copyright (C) 2002 Maciej W. Rozycki
Copyright (c) 2018 Amllogic, inc. Author: Qiufang Dai <qiuqiang.dai@amlogic.com>
Copyright (C) 2012 Javier Martinez Canillas <javier@dowhile0.org>
Copyright (C) 2013 Cypress Semiconductor
Copyright (C) 2011-2012 Tobias Klauser <tklauser@distanz.ch>
Copyright (C) 2004 Microtronix Datacom Ltd
Copyright (C) Hitachi Ltd., 2012
Copyright (C) Huawei Inc., 2014
Copyright 2015, Freescale Semiconductor, Inc.
Copyright (C) 1998 by Harald Koerfgen
Copyright (C) 2002, 2005 Maciej W. Rozycki
Copyright (C) 2006 Juan Carlos Borrás
Copyright (c) 2002-3 Open Source Development Labs
Copyright (C) 2009-2015 Emulex. All rights reserved. * EMULEX and SLI are trademarks of Emulex. * www.broadcom.com *
Copyright (c) 2005-2006 Network Appliance, Inc. All rights reserved.
Copyright (C) 2009 Igor M. Liplianin <liplianin@netup.ru>
Copyright (C) 2009 Abylay Ospan <aospan@netup.ru>
Copyright 2010 MontaVista Software, LLC. Anton Vorontsov <avorontsov@mvista.com>
Copyright (C) 2009 MontaVista Software, Inc. <source@mvista.com>
Copyright 1999-2000 Jeremy Fitzhardinge <jeremy@goop.org>
Copyright 2001-2006 Ian Kent <raven@themaw.net>
Copyright (C) 1998,1999 D. Jeff Dionne <jeff@uclinux.org> Copyleft (()) 2000 James D. Schettine {james@telos-systems.com}
Copyright (C) 1998 Kenneth Albanowski <kjahds@kjahds.com>
Copyright (C) 1995 Hamish Macdonald
Copyright (C) 2001 Lineo, Inc. <www.lineo.com>
Copyright(C) 1998,1999 Kenneth Albanowski, D. Jeff Dionne
Copyright 2006-2007 Secret Lab Technologies Ltd.
Copyright (C) 2000, 2001, 06 Ralf Baechle <ralf@linux-mips.org> swiped from i386, and cloned for MIPS by Geert, polished by Ralf.
Copyright 2008 Embedded Alley Solutions, Inc
Copyright (C) 2014 Pali Rohár <pali.rohar@gmail.com>
Copyright (c) 2014-2015 QLogic Corporation
Copyright (C) 2006-2007 Will Schmidt <willschm@us.ibm.com>, IBM
Copyright (c) 2012-2013 by Tensilica Inc.
Copyright 1999 Silicon Graphics, Inc.

LICENCE TERMS (cont.)

Copyright (C) 2004 - 2009 Felix Fietkau <nbdf@openwrt.org> <http://rt2x00.serialmonkey.com>
Copyright (C) 2011-2012 Linaro Ltd <mturquette@linaro.org>
Copyright (C) 2005 MIPS Technologies, Inc.
Copyright 2013-2015 Intel Mobile Communications GmbH
Copyright (C) 2015-2017 Intel Deutschland GmbH
Copyright (C) 2018-2019 Intel Corporation
Copyright (C) 2013 Ma Haijun <mahaijuns@gmail.com>
Copyright (C) 2004 Intel Corp.
Copyright (C) 2005-2006 Linus Torvalds <torvalds@osdl.org>
Copyright (C) 2006 Ingo Molnar <mingo@elte.hu>
Copyright (C) 1996-1998 Linus Torvalds & authors (see below)
Copyright (C) 2003 David Gibson, IBM Corporation.
Copyright (c) 2008 Jiri Slaby <jirislaby@gmail.com>
Copyright (c) 2006 Michael Hanselmann <linux-kernel@hansmi.ch>
Copyright (c) 2013,2014 Samsung Electronics Co., Ltd. <http://www.samsung.com> Author: Marek Szyprowski <m.szyprowski@samsung.com> Author: Josh Cartwright <joshc@codeaurora.org>
Copyright (C) 2008 Eurotech S.p.A. <info@eurotech.it>
Copyright (C) 2010-2011 Lars-Peter Clausen <lars@metafoo.de>
Copyright (C) 2011 Pali Rohar <pali.rohar@gmail.com>
Copyright (C) 2017 Liam Breck <kernel@networkimprov.net>
Copyright (C) 2008 Texas Instruments, Inc.
Copyright (C) 2002 Frank Mori Hess <fmhess@users.sourceforge.net>
Copyright (C) 1994 Linus Torvalds
Copyright (C) 2018 Pengutronix, Lucas Stach <kernel@pengutronix.de>
Copyright 2005-2006 Ian Kent <raven@themaw.net>
Copyright (c) 2005-2007 Stefano Brivio <stefano.brivio@polimi.it>
Copyright (c) 2005-2008 Michael Buesch <m@bues.ch>
Copyright (c) 2005, 2006 Danny van Dyk <kugelfang@gentoo.org>
Copyright (c) 2005, 2006 Andreas Jaggi <andreas.jaggi@waterwave.ch>
Copyright (c) Paul Mundt 2001
Copyright (C) 2012 John Crispin <john@phrozen.org>
Copyright 2012 Red Hat, Inc <mjg@redhat.com> Author: Matthew Garrett
Copyright (C) 2006-2007 Texas Instruments.
Copyright (C) 2008-2009 Deep Root Systems, LLC
Copyright (C) 2011 Wind River Systems, written by Ralf Baechle <ralf@linux-mips.org>
Copyright (c) 2004-2005, K A Fraser
Copyright (C) STMicroelectronics SA 2017 Authors: Maxime Coquelin <mcoquelin.stm32@gmail.com> Gerald Baeza <gerald.baeza@st.com>
Copyright 2007 Simtec Electronics
Copyright (c) 2016-2017 Andreas Färber
Copyright (c) 2005 Voltaire, Inc. All rights reserved.
COPYRIGHT(c) Write the new GID
Copyright(c) Write the new GID
Copyright (C) 2010 ARM Ltd., Will Deacon <will.deacon@arm.com>
Copyright (C) 2005 - 2006 Mike Christie
Copyright (C) 2006 Red Hat, Inc. All rights reserved. maintained by open-iscsi@googlegroups.com
Copyright(C) Copyright 2002 Red Hat Inc <alan@redhat.com>
Copyright (C) 2006 Atmark Techno, Inc. Changes for MMU support:
Copyright (C) 2007 Xilinx, Inc. All rights reserved.
Copyright (c) 2001, 2002 Adaptec Inc. All rights reserved.
Copyright(c) 2005 - 2015 Intel Corporation. All rights reserved.
Copyright (c) 2006 Rik Snel <rsnel@cube.dyndns.org>
Copyright (c) 2003, Dr Brian Gladman, Worcester, UK. All rights reserved.
Copyright (C) 2003 - 2004 Tresys Technology, LLC
Copyright (C) 2004 Red Hat, Inc., James Morris <jmorris@redhat.com>
Copyright (C) 2013 Sirius Electronic Systems
Copyright (C) 2015-2016 Freescale Semiconductor, Inc.

Copyright (C) 2008 Ben Backx <ben@bbackx.com>
Copyright: (C) 2012 ARM Limited
Copyright (C) 2008 Steven Rostedt <srostedt@redhat.com>
Copyright (C)2003-2006 USAGI/WIDE Project
Copyright(c) 2013 - 2014 Intel Mobile Communications GmbH All rights reserved.
Copyright(c) 2003- 2015 Intel Corporation" define DRV_AUTHOR "<linuxwifi@intel.com>
"COPYRIGHT ""Copyright(c) 2003- 2015 Intel Corporation"" define DRV_AUTHOR ""<linuxwifi@intel.com>""
"
"copyright ""Copyright(c) 2003- 2015 Intel Corporation"" define DRV_AUTHOR ""<linuxwifi@intel.com>"" "
Copyright (C) 2004 - 2007 Paul Mundt
Copyright(C) SEIKO EPSON CORPORATION 2013. All rights reserved.
Copyright (C) 2016 ROCKCHIP, Inc.
Copyright (C) 2007 Paul Mundt
Copyright (C) 2009, Arnaldo Carvalho de Melo <acme@redhat.com>
Copyright Darryl Miles G7LED (d1m@g7led.demon.co.uk)
Copyright(C) 2005 Frank Rowand (frowand@mvista.com)
Copyright(C) 2004 Tom Rini (trini@mvista.com)
Copyright(C) 2003 John Whitney (john.whitney@timesys.com)
Copyright(C) 1998 Michael Tesch (tesch@cs.wisc.edu)
Copyright (C) 1995 David S. Miller (davem@caip.rutgers.edu) Author: Tom Rini <trini@kernel.crashing.org>
Copyright (C) 2004, 2005 by Andriy Skulysh)
Copyright (c) by Francisco Moraes <fmoraes@nc.r.com>
Copyright (C) 2017 Pengutronix, Lucas Stach <kernel@pengutronix.de>
Copyright(C) 2010-2011 Corentin Chary <corentin.chary@gmail.com>
Copyright (C) 2005 Miloslav Trmac <mitr@volny.cz>
Copyright (C) 2005 Bernhard Rosenkraenzer <bero@arklinux.org>
Copyright (C) 2005 Dmitry Torokhov <dtor@mail.ru>
Copyright 2004 ARM Limited
Copyright 2014 Peter Meerwald <pmeerw@pmeerw.net>
Copyright 2016-2017 NXP
Copyright 2018 (C) Pengutronix, Michael Grzeschik <mgr@pengutronix.de>
Copyright 2019 (C) Pengutronix, Marco Felsch <kernel@pengutronix.de>
"Copyright (c) 2006 Jiri Benc <jbenc@suse.cz>"
Copyright (C) 2018 - 2020 Intel Corporation
Copyright (c) 2010 Baruch Siach <baruch@tkos.co.il>, Orex Computed Radiography
Copyright (C) 1991, 1992 Linus Torvalds 1995 Jay Estabrook
Copyright (c) 2018 Bootlin
Copyright (C) 2011, Matt Porter
Copyright (C) 2008, Jaya Kumar
Copyright 2003-2005 Jeff Garzik
Copyright (C) 2013 Stephen Warren
Copyright (C) 2015 Martin Sperl
Copyright (C) 2009-2011 Gabor Juhos <juhosg@openwrt.org>
Copyright (C) 2006 Atmel Corporation
Copyright (c) 2018-2019 Christoph Hellwig
Copyright © 2001-2010 David Woodhouse <dwmw2@infradead.org>
Copyright (C) 2004 Ralf Baechle
Copyright 1991, 1992, 1993, and by Julian Cowley, Copyright 1994.
Copyright (c) 2018-2019, Vladimir Oltean <olteanv@gmail.com>
Copyright (c) 2000-2001 Adaptec Inc. All rights reserved.
Copyright (C) 1998, 1999 Frodo Looijaard <frodol@dds.nl> and Philip Edelbrock <phil@netroedge.com>
Copyright (C) 1996, 1997, 1998 Derrick J Brashear (shadow@andrew.cmu.edu) and also sound/isa/cs423x/cs4231_ lib.c which is:
Copyright (c) by Jaroslav Kysela <perex@perex.cz>
Copyright (c) 2019 Andrew Lunn <andrew@lunn.ch>
Copyright (C) 1998 Paul Mackerras
Copyright (C) 1997 Fabio Riccardi. And from the frame buffer device for Open Firmware-initialized devices:

LICENCE TERMS (cont.)

Copyright (C) 1997 Geert Uytterhoeven.
Copyright (C) 1996 Paul Mackerras
Copyright (C) 2000-2002 Deep Blue Solutions Ltd.
Copyright (C) 2006, 2007 Akio Idehara
Copyright (C) 1995 David S. Miller (davem@caip.rutgers.edu)
Copyright (C) 1996 Miguel de Icaza (miguel@nucleu.unam.mx)
Copyright (C) 1997 Eddie C. Dost (ecd@skynet.be)
Copyright (c) Jean-Francois Dive <jef@linuxbe.org>
Copyright 2010 - 2014 Freescale Semiconductor Inc.
Copyright (C) 2003-2004 Robert Schwebel, Benedikt Spranger
Copyright (C) 2006-2008 Intel Corporation
Copyright (C) 2007 Amos Lee <amos_lee@storlinksemi.com>
Copyright (C) 2007 Dave Airlie <airlied@linux.ie>
Copyright (C) 2011 Texas Instruments
Copyright (C) 2017 Eric Anholt
Copyright (C) 2003 Konrad Eisele <eiselekd@web.de>
Copyright (C) 2006 Daniel Hellstrom <daniel@gaisler.com>, Aeroflex Gaisler AB
Copyright (C) 2008 Gilead Kutnick <kutnickg@zin-tech.com>
Copyright (C) 2009 Kristoffer Glembo <kristoffer@gaisler.com>, Aeroflex Gaisler AB
Copyright (C) 2002 Intel Corporation.
Copyright (C) 2003-2004 MontaVista Software, Inc.
Copyright (c) 2012-2013 Linaro Limited.
Copyright (c) 2016 ARM Ltd.
Copyright (C) 2011-2013 Texas Instruments Inc.
Copyright (C) 2016 Xilinx, Inc. All rights reserved.
Copyright(c) 2007 Atheros Corporation. All rights reserved.
Copyright (C) 2004 Silicon Graphics, Inc.
Copyright (C) 2007 Nokia Corporation
Copyright (C) 2012-2013 Xilinx, Inc.
Copyright 2006-2008, Michael Buesch <m@bues.ch>
Copyright (c) 2011 Qualcomm Atheros, Inc.
Copyright 2009, 2010, Christian Lamparter <chunkey@googlemail.com>
Copyright (C) 2003 Ralf Baechle
Copyright (c) 2013 Cisco Systems, Inc.
Copyright (C) 2010 NXP Semiconductors
Copyright (C) 2004-2010 Red Hat, Inc. All rights reserved.
Copyright 2002, Yoshinori Sato
Copyright (C) 2003-2005, 2007 Bartlomiej Zolnierkiewicz
Copyright: (C) 2009 Texas Instruments, India
Copyright (C) 2003, 2004 Paul Mundt
Copyright (C) 2017 Renesas Electronics Corporation
Copyright (c) 2008 Cisco. All rights reserved.
Copyright (C) 2005 Oracle. All rights reserved.
Copyright (c) 2011-2012 Linaro Ltd. www.linaro.org
Copyright 2009 Luis R. Rodriguez <mcgrof@gmail.com>
Copyright message. 0.0.17 Add iec958 file in proc file system to show status of SPDIF in. 0.0.18 Implement support for Line-in capture on SB Live 24bit.
Copyright if (status[0] & IEC958_AES0_CON_NOT_COPYRIGHT) { snd_iprintf(buffer, "permitted\n")
Copyright (C) 2006,2007 Genpix Electronics (genpix@genpix-electronics.com)
Copyright (C) 2006 AppSpec Computer Technologies Corp. Jeff Gibbons <jeff.gibbons@appspec.com>
Copyright 2006, 2007, Michael Buesch <mb@bu3sch.de>
Copyright 2010, Bernhard Loos <bernhardloos@googlemail.com>
Copyright 2011, Hauke Mehrtens <hauke@hauke-m.de>
Copyright (C) 2006 David Brownell (convert to new framework)
Copyright (C) 2010 John Crispin <john@phrozen.org>
Copyright 2005,2007 Simtec Electronics\n"
Copyright(c) 2002-2010 Exar Corp
Copyright (C) 2018 - 2019 Intel Corporation All rights reserved.
Copyright (C) 2006 Qumranet, Inc.
Copyright 2011-2012, Marco Porsch <marco.porsch@s2005.tu-chemnitz.de>
Copyright 2011-2012, cozybit Inc.
Copyright(c) 1995-1998 Patrick Caulfield.
Copyright(c) 2000 Edward Betts <edward@debian.org>
Copyright (C) 2006, 2007 Hewlett-Packard Development Company, L.P.
Copyright (C) 2004-2006 Trusted Computer Solutions, Inc.
Copyright (C) 2003 - 2004, 2006 Tresys Technology, LLC
Copyright (C) 2003 Red Hat, Inc., James Morris <jmorris@redhat.com>
Copyright (C) 2004, 05 Ralf Baechle DL5RB <ralf@linux-mips.org>
Copyright (C) 2004, 05 Thomas Osterried DL9SAU <thomas@x-berg.in-berlin.de>
Copyright (C) 2006 Carlos Munoz <carlos@kenati.com>
Copyright (C) 2009 Lemote Inc. & DSLab, Lanzhou University Author: Wu Zhangjin <wuzhangjin@gmail.com>
Copyright (C) 2007, 2008, 2010, 2011 Freescale Semiconductor, Inc. Zhang Wei <wei.zhang@freescale.com>
Copyright (C) 2018 Cogent Embedded, Inc.
Copyright (C) 2000 Jim Pick <jim@jimpick.com>
Copyright (C) 2001 Steven J. Hill (sjhill@realitydiluted.com)
Copyright (C) 2000-2002 Toshiba Corporation
Copyright(c) 2003 - 2015 Intel Corporation. All rights reserved.
Copyright (C) 2008 Nokia Corporation Author: Tomi Valkeinen <tomi.valkeinen@ti.com>
Copyright (C) 2006-2007 OpenMoko, Inc. Author: Harald Welte <laforge@openmoko.org>
Copyright 2012 Google, Inc.
Copyright (c) 2015 Linaro Ltd.
Copyright (C) 1995-1996 Linus Torvalds & authors (see driver)
Copyright (C) 2001 - 2007 Jeff Dike (jdike@{addtoit,linux.intel}.com)
Copyright 2010-2011 Freescale Semiconductor, Inc.
Copyright (c) 2007, 2004-2005 Simtec Electronics http://armlinux.simtec.co.uk/ Ben Dooks <ben@simtec.co.uk>
Copyright (C) 2013, NVIDIA Corporation. All rights reserved.
Copyright (C) 2012 Kevin Cernekee <cernekee@gmail.com>
Copyright (C) 1998 Jakub Jelinek (jj@sunsite.mff.cuni.cz)
Copyright (C) 2005 Richard Purdie <rpurdie@openedhand.com>
Copyright (C) 2016, Robert Jarzmik <robert.jarzmik@free.fr>
Copyright (C) 1996,1998 Jakub Jelinek (jj@ultra.linux.cz)
Copyright (c) 2015 Benjamin Tissoires
Copyright (C) 2004, 2005 Manu Abraham (manu@kromtek.com)
Copyright (C) 2016-2017 Oracle. All rights reserved.
Copyright (C) 2003 ATMEL
Copyright (C) 2004 Intel Corporation <matthew.e.tolentino@intel.com>
Copyright (C) 2006-2007 Daniel Drake <dSD@gentoo.org>
Copyright (C) 2006-2007 Michael Wu <flamingice@sourmilk.net>
Copyright (C) 2007-2008 Luis R. Rodriguez <mCGrof@winlab.rutgers.edu>
Copyright (C) 2017-2018 Bootlin
Copyright 2006-2013 Solarflare Communications Inc.
Copyright(c) Copyright 2004, Red Hat Inc. <alan@lxguk.ukuu.org.uk> Additional fixes and clean up: Francois Romieu
Copyright (c) 1996, 2003 VIA Networking Technologies, Inc. All rights reserved.
Copyright (c) 2002, 2003 VIA Networking Technologies, Inc
Copyright (c) 2004 Red Hat Inc
Copyright (C) 2003-2007 Oliver Endriss <o.endriss@gmx.de>
Copyright (C) 2019 Sean Young <sean@mess.org>
Copyright (c) 2017 Oracle and/or its affiliates. All rights reserved.
Copyright (C) 2001 Sven Luther, <luther@dpt-info.u-strasbg.fr>
Copyright (C) 1997 Paul Mackerras (paulus@samba.org)
Copyright (C) 2002,2011 Greg Ungerer <gerg@snapgear.com>
Copyright (C) 2018 Hao Zhang <hao5781286@gmail.com>
Copyright 2003 by Hans-Joerg Frieden and Thomas Frieden

LICENCE TERMS (cont.)

Copyright (C) 2007 Andres Salomon <dilinger@debian.org>
Copyright (C) 2009 Andres Salomon <dilinger@collabora.co.uk>
Copyright (C) 2001,2002 IBM Corp.
Copyright (C) 1999 SuSE GmbH
Copyright (C) 1999-2001 Hewlett-Packard Company
Copyright (C) 1999-2001 Grant Grundler
Copyright (C) 2012 ARM Ltd. Modified by Will Deacon <will.deacon@arm.com>
Copyright (c) 2017 Linaro Limited.
Copyright (C) 2010 Nokia Corporation Benoît Cousson Paul Walmsley
copyright (c) 2004 Evgeniy Polyakov <zbr@ioremap.net>
Copyright (C) 2009-2011 Nokia Corporation
Copyright 2011 David Gibson, IBM Corporation <dwg@au1.ibm.com>
Copyright 2016 Alexey Kardashevskiy, IBM Corporation <aik@au1.ibm.com>
Copyright (C) 2006 Jamie Lenehan
Copyright(c) 1998 Gerd Knorr <kraxel@cs.tu-berlin.de>
Copyright (c) 2007 Michel Ludwig (michel.ludwig@gmail.com) frontend interface
Copyright (C) 2012 Intel, Inc.
Copyright (C) 1995, Linus Torvalds
Copyright (c) 2000-2002 Adaptec Inc. All rights reserved.
Copyright (C) 2001 - 2007 Jeff Dike (jdike@{addtoit,linux.intel}.com)
Copyright (C) 2006 Marco Gittler (g.marco@freenet.de)
Copyright(c) dh1pa@amsat.org
Copyright(c) g.marco@freenet.de
Copyright MODULE_DESCRIPTION("Driver for Opera1 DVB-S device
Copyright MODULE_VERSION("0.1
Copyright (c) 2011-2016 Qualcomm Atheros, Inc.
Copyright (c) 2016-2017 Savoir-faire Linux Inc. Vivien Didelot <vivien.didelot@savoirfairelinux.com>
Copyright (c) Realtek Semiconductor Corp. All rights reserved.
Copyright 2019 NXP */
Copyright (c) 2005, Devicescape Software, Inc.
Copyright (c) 2006, Michael Wu <flamingice@sourmilk.net>
Copyright (c) 2013 - 2014 Intel Mobile Communications GmbH
Copyright (c) 2018 - 2019 Intel Corporation
Copyright (C) 2003-2005 by David Brownell
Copyright (c) 2015 The Linux Foundation. All rights reserved.
Copyright (C) 2012 Roland Stigge <stigge@antcom.de>
Copyright (C) 2006 jornada 720 kbd driver by Filip Zyzniewsk <Filip.Zyzniewski@tefnet.plx
Copyright(C) 2004 jornada 720 kbd driver by Alex Lange <chicken@handhelds.org>
Copyright (C) 2012 Renesas Solutions Corp.
Copyright (C) 2012 Kuninori Morimoto <kuninori.morimoto.gx@renesas.com>
Copyright (C) 1999 David A. Hinds.
Copyright (c) 2012 Canonical Ltd.
Copyright (C) 2009 PetaLogix
Copyright (C) 2007 LynuxWorks, Inc.
Copyright (C) 2015 Regents of the University of California
Copyright 2000 John Ankcom <jca@ics.mit.edu>
Copyright(C) 2007,2011 Bartłomiej Zolnierkiewicz
"Copyright (C) 1999-2002 Andre Hedrick <andre@linux-ide.org> 865/865R fixes for Macintosh card version
from a patch to the old driver by Thibaut VARENE <varenet@parisc-linux.org> When setting the PCI latency we must
set 0x80 or higher for burst performance Alessandro Zummo <alessandro.z >
Copyright (C) 1999, 2000 Ralf Baechle (ralf@gnu.org)
copyright (C) 2003 Russell King, PXA MMCI Driver
copyright (C) 2004-2005 Pierre Ossman, W83L51xD SD/MMC driver
Copyright 2008 Embedded Alley Solutions, Inc.
Copyright 2009-2011 Freescale Semiconductor, Inc.
Copyright (C) 2011-2012 Van Jacobson <van@pollere.net>
Copyright (C) 2012 Michael D. Taht <dave.taht@bufferbloat.net>

Copyright (C) 2012,2015 Eric Dumazet <edumazet@google.com>
Copyright (C) 2003 2004 Michel Xhaard mxhaard@magic.fr
Copyright(C) 2004
Copyright (C) 2010, Laurent Pinchart <laurent.pinchart@ideasonboard.com>
Copyright (c) 2009 Mauro Carvalho Chehab <mchehab@kernel.org>
Copyright (c) Cisco 1999,2000
Copyright (c) Motorola 1999,2000,2001
Copyright (c) La Monte H.P. Yarroll 2001
Copyright 2009, Benjamin Herrenschmidt, IBM Corporation.
Copyright 2015-2016, Aneesh Kumar K.V, IBM Corporation.
Copyright (C) 2008, 2009 Matt Fleming
Copyright (c) 2002 Pete Zaitcev (zaitcev@yahoo.com) Incorporating suggestions made by Linus Torvalds and Dave
Miller
Copyright 2008 Xilinx, Inc.
Copyright (C) 2003 Greg Ungerer <gerg@snapgear.com>
Copyright (C) 1999-2002 Ralph Metzler Marcus Metzler for convergence integrated media GmbH
Copyright (c) 2005 Dmitry Torokhov
Copyright (C) 2015 Martin Willi
Copyright 2005 Hewlett-Packard Development Company, L.P.
Copyright 2005 IBM Corporation
Copyright (C) 2015 Google, Inc.
Copyright(c) 2012 - 2015 Intel Corporation. All rights reserved.
Copyright (c) 2016 Advanced Micro Devices, Inc. All rights reserved.
Copyright (C) 2018 ZTE.
Copyright (C) 2008 Dmitry Baryshkov
Copyright (c) 2018, Sensor-Technik Wiedemann GmbH
Copyright (c) 2004-2005, K A Fraser
Copyright (c) 2008 Isaku Yamahata <yamahata at valinux co jp> VA Linux Systems Japan. Split out x86 specific part.
Copyright(c) 1998, 1999, 2000, 2009 Ingo Molnar <mingo@redhat.com>
Copyright 2001 Andi Kleen, SuSE Labs.
Copyright (C) 2005 Nokia Corporation Author: Lauri Leukkunen <lauri.leukkunen@nokia.com> PWM and clock
framework support by Timo Teras.
Copyright (C) 2016 Red Hat, Inc.
Copyright (C) 2007 Marvell Ltd.
copyright© Copyright 2016 Free Electrons
Copyright © 2003 Rick Bronson
Copyright © 2001 Thomas Gleixner (gleixner@autronix.de)
Copyright © 2000 Steven J. Hill (sjhill@cotw.com)
Copyright © 2007
copyright© Copyright 2006 ATMEL Rousset, Lacrosonniere Nicolas
copyright© Copyright 2012 ATMEL, Hong Xu
copyright© Copyright 2013 ATMEL, Josh Wu (josh.wu@atmel.com)
Copyright© Copyright 2016 Free Electrons
Copyright© Copyright 2006 ATMEL Rousset, Lacrosonniere Nicolas
Copyright© Copyright 2012 ATMEL, Hong Xu
Copyright© Copyright 2013 ATMEL, Josh Wu (josh.wu@atmel.com)
Copyright (C) 2006 David S. Miller <davem@davemloft.net>
"Copyright 2007-2008 Johannes Berg <johannes@sipsolutions.net>"
Copyright 2018-2020 Intel Corporation
Copyright (C) 2008 IBM Corporation find_last_bit' is written by Rusty Russell <rusty@rustcorp.com.au> Inspired by
David Howell's find_next_bit implementation)
Copyright (C) 2010 Steven King <sfking@fdwdc.com>
Copyright (C) 2017 Intel Corporation
Copyright (C) 2010 Nobuhiro Iwamatsu
Copyright (C) Theodore Kilgore.
Copyright (C) 2013-2015 Intel Corporation. All rights reserved.
Copyright (C) 2016 Huawei Inc.

LICENCE TERMS (cont.)

copyright 2008 Magnus Damm
Copyright (c) Randolph Chung 2001 <tausq@debian.org>
Copyright (C) 2001 Bradley D. LaRonde <brad@lrc.com>
Copyright (C) 2002 Denis Oliver Kropp <dok@directfb.org>
Copyright (C) 2012, 2013 Minchan Kim
Copyright (C) 2000-2001 Toshiba Corporation static const char *version = tc35815.c:v.00.00 26/07/2000 by Toshiba Corporation
Copyright(C) Copyright TOSHIBA CORPORATION 2004-2005 All Rights Reserved.
Copyright © 2007-2008 Dave Airlie
Copyright © 2007-2008 Intel Corporation Jesse Barnes <jesse.barnes@intel.com>
Copyright (c) 2014-2015 Thomas Graf <graf@suug.ch>
Copyright (c) 2008-2014 Patrick McHardy <kaber@trash.net>
Copyright (C) 2012 Regents of the University of California
Copyright (C) 2015, Motorola Mobility
Copyright (C) 2014-15, Intel Corporation.
Copyright (C) 2010-2012 Andreas Heider <andreas@meet.de>
Copyright (C) 2015 Lukas Wunner <lukas@wunner.de>
Copyright (C) 2016 Florent Revest <florent.revest@free-electrons.com>
Copyright (C) 2018 Paul Kocikowski <paul.kocikowski@bootlin.com>
Copyright (c) 2014 Takashi Sakamoto
"copyrighted 1990 Mark Adler */"
Copyright (C) 2001, 2002, 2003 Jeff Garzik (jgarzik@pobox.com)
Copyright (C) 2004 Sun Microsystems Inc.
Copyright (C) 2005-2016 Broadcom Corporation.
Copyright (C) 2016-2017 Broadcom Limited.
Copyright (C) 2018 Broadcom. All Rights Reserved. The term "Broadcom" refers to Broadcom Inc. and/or its subsidiaries.
Copyright (C) 2000-2016 Broadcom Corporation.
Copyright (C) 2016-2017 Broadcom Ltd.
Copyright 2003 PathScale, Inc. Licensed under the GPL
Copyright (C) 2009 Simon Guinot <sguinot@lacie.com>
Copyright (c) 2007 Jiri Slaby <jirislaby@gmail.com>
Copyright IBM Corp. 2007-2008
Copyright 2017-2018,2020 NXP
Copyright 2000 MontaVista Software Inc. PPC405 modifications PowerPC 403GCX/405GP modifications. Author: MontaVista Software, Inc. frank_rowand@mvista.com or source@mvista.com debbie_chu@mvista.com
Copyright 2002-2005 MontaVista Software, Inc. PowerPC 44x support, Matt Porter <mporter@kernel.crashing.org>
Copyright (C) 2002 Hiroshi Aono (h-aono@ap.jp.nec.com)
Copyright (C) 2002,2003 NEC Corporation
Copyright (C) 2003-2005 Matthew Wilcox (willy@infradead.org)
Copyright (C) 2003-2005 Hewlett Packard
Copyright (C) 2005 Rajesh Shah (rajesh.shah@intel.com)
Copyright (C) 2005 Intel Corporation
Copyright (C) 2012 Stephen Warren
Copyright (C) 2016 Neil Armstrong <narmstrong@baylibre.com>
Copyright (c) 2002 Laurent Canet <canetl@esiee.fr>
Copyright (c) 2002 Thibaut Varene <varenet@parisc-linux.org>
Copyright (c) 1999 Alex deVries <alex@onefishtwo.ca>
Copyright (c) 1999-2000 Philipp Rumpf <prumpf@tux.org>
Copyright (c) 2000 Xavier Debacker <xdebacker@esiee.fr>
Copyright (c) 2000-2001 Thomas Marteau <marteau@esiee.fr>
Copyright (C) 1996-2002 Russell King
Copyright (c) by James Courtier-Dutton <James@superbug.co.uk> Added EMU 1010 support.
Copyright (C) Alan Hourihane 2005 All Rights Reserved.
Copyright (C) 2010 Tanguy Bouzeloc <tanguy.bouzeloc@efixo.com>
Copyright (C) 2011 Daniel Mack <zonque@gmail.com>
Copyright (C) 2008 Bryan Wu <cooloney@kernel.org>

Copyright (C) 2008 Analog Devices, Inc
Copyright (C) 2006 Thumtronics Pty Ltd. Ben Williamson <ben.williamson@greyinnovation.com>
Copyright (C) 1997-8 David A. Schleef <ds@schleef.org>
Copyright (C) 2017 Google, Inc. Matthew Garrett <mjg59@google.com> Thiebaud Weksteen <tweek@google.com>
Copyright (c) 2013 Vista Silicon S.L. Author: Javier Martin <javier.martin@vista-silicon.com>
Copyright (c) 2013 Carlo Caione 2012 Henrik Nordstrom
Copyright (C) 2013-2015 Fujitsu Semiconductor Ltd.
Copyright (C) 2002 by Peter Schildmann <peter.schildmann@web.de>
Copyright (C) 2002 Felix Domke <tmbinc@elitedvb.net> Andreas Oberitter <obi@linuxtv.org>
Copyright (C) 2003 Vadim Catana <skystar@moldova.cc>:
Copyright (C) 2004 Andrew de Quincey <adq_dvb@lidskialf.net>
Copyright (C) 2002, 2003 Paul Mundt
Copyright (C) 2009 Johannes Berg <johannes@sipsolutions.net>
Copyright (C) 1995-1999 Madge Networks Ltd
Copyright (C) 2009 Renesas Technology Corp.
Copyright (C) 2016 Sang Engineering, Wolfram Sang
Copyright 2011-2012 NVIDIA, Inc.
Copyright (c) 2014 Jaegeuk Kim <jaegeuk@kernel.org>
Copyright (C) 2011 ProFUSION Embedded Systems
Copyright (c) 2019 Vivien Didelot <vivien.didelot@gmail.com>
Copyright (C) 2004 - 2006 Paul Mundt
Copyright (c) 2010, ST-Ericsson Author: Ajitpal Singh <ajitpal.singh@stericsson.com>
Copyright (c) 2002-2003, Jouni Malinen <jkmaline@cc.hut.fi>
Copyright (C) 2012-2013 Texas Instruments, Inc. Andrii Tseglytskyi <andrii.tseglytskyi@ti.com> Nishanth Menon <nm@ti.com>
Copyright 2007 Maarten Maathuis
Copyright (C) 2008 Freescale Semiconductor, Inc.
Copyright 2008 Advanced Micro Devices, Inc.
Copyright (C) 2007 Hewlett-Packard Development Company, L.P.
Copyright (C) 2004-2005 Trusted Computer Solutions, Inc.
Copyright (C) 2009 Renesas Solutions Corp. Cleanups by Kuninori Morimoto <morimoto.kuninori@renesas.com>
Copyright (C) 2019 Google, Inc. Tomasz Figa <tfiga@chromium.org>
Copyright (C) 2016 Glider bvba
Copyright (C) 2019 IBM Corp. */
Copyright (c) 2007 The University of Aberdeen, Scotland, UK
Copyright (c) 2003 Nils-Erik Mattsson, Joacim Haggmark, Magnus Erixson
Copyright (c) 2005 Arnaldo Carvalho de Melo <acme@conectiva.com.br>
Copyright (c) 2014 QLogic Corporation
Copyright (c) 2010 Chase Douglas <chase.douglas@canonical.com>
Copyright (C) 2010-2011 Nokia Corporation. Eduardo Valentin Paul Walmsley
Copyright (C) 1985 MIPS Computer Systems, Inc.
Copyright (C) 1990 - 1992, 1999 Silicon Graphics, Inc.
Copyright (c) 2015, Sony Mobile Communications AB
Copyright (C) STMicroelectronics 2017 Author: M'boumba Cedric Madianga <cedric.madianga@gmail.com>
Copyright (C) 2004-2005 David Brownell
Copyright (C) 2013 Ideas On Board SPRL
Copyright (C) 2012 ARM Ltd.
Copyright (C) 2015 Huawei Futurewei Technologies.
Copyright 2015 Karsten Merker <merker@debian.org>
Copyright 2015 Chen-Yu Tsai <wens@csie.org>
Copyright (C) 2010 Urs Fleisch <urs.fleisch@sensirion.com>
Copyright (C) 2011 Advanced Micro Devices,
Copyright (c) 2011,2012 Intel Corp.
Copyright (C) 2002 - 2007 Paul Mundt
Copyright (C) 2004-2009 Emulex. All rights reserved. * EMULEX and SLI are trademarks of Emulex. * www.broadcom.com *
Copyright(c) 2015 - 2017 Intel Deutschland GmbH All rights reserved.

LICENCE TERMS (cont.)

Copyright (C) 2006 Trusted Computer Solutions, Inc.
Copyright 2002-2004 Rusty Russell, IBM Corporation
Copyright 2006-2008 Sam Ravnborg Based in part on module-init-tools/depmod.c,file2alias
Copyright (C) 2001, 2002 Andi Kleen, SuSE Labs.
Copyright (C) 2008-2009, Red Hat Inc., Ingo Molnar
Copyright(c) 1999-2002 Petr Vandrovec <vandrovec@vc.cvut.cz>
Copyright MODULE_DESCRIPTION("Matrox G200/G400 Matrox MGA-TVO driver
Copyright © CC Computer Consultants GmbH, 2007 - 2008
"Copyright (C) 1999, 2000 Brian Warner <warner@lothar.com>"
Copyright (C) 2000 Al Borchers <borchers@steinerpoint.com>
Copyright (c) 2004 Peter Nelson <rufus-kernel@hackish.org>
Copyright (C) 2011, Maarten ter Huurne <maarten@treewalker.org> JZ4740 setup code
Copyright (C) 2003 - 2007 Paul Mundt
Copyright (C) 2002,2003 Takayoshi Kochi (t-kochi@bq.jp.nec.com)
Copyright (C) 2003-2005 Hewlett Packard
Copyright 2017-2018 NXP
Copyright (C) 2008,2009 Albert Herranz
Copyright (C) 1992,1993 by Michael K. Johnson Thanks much to Gunter Windau for pointing out to me where the error checking ought to be.
Copyright (C) 1993 by Nigel Gamble (added interrupt code)
Copyright (C) 1994 by Alan Cox (Modularised it) LPCAREFUL, LPABORT, LPGETSTATUS added by Chris Metcalf, metcalf@lcs.mit.edu Statistics and support for slow printers by Rob Janssen, rob@knoware.nl
Copyright (C) 2000 by Tim Waugh (added LPSETTIMEOUT ioctl)
Copyright (C) 2001 MIPS Technologies, Inc.
Copyright (c) 2001, 2002, 2003 Ladislav Michl <ladis@linux-mips.org>
Copyright (C) 2013 Pengutronix
Copyright (c) 2012 Paolo Valente.
Copyright (C) 2008 Wind River Systems, Inc.
Copyright (C) 1994 - 99, 2003, 06 Ralf Baechle
Copyright (C) 1999 Silicon Graphics, Inc. Kevin Kissell, kevink@mips.com and Carsten Langgaard, carstenl@mips.com
Copyright (C) 2000 MIPS Technologies, Inc. All rights reserved.
Copyright (C) 2003-2004 MontaVista Software, Inc. based on nslu2-power.c:
Copyright (C) 2005 Tower Technologies based on nslu2-io.c:
Copyright 2015 General Electric Company
Copyright (C) 1998 Eddie C. Dost (ecd@skynet.be)
Copyright (C) 2008 PetaLogix
Copyright (C) 2009, 2010 DSI Lab, Lanzhou University, China Author: Wu Zhangjin <wuzhangjin@gmail.com>
Copyright 2006 Phil Sutter <n0-1@freewrt.org>
Copyright 2007 Florian Fainelli <florian@openwrt.org>
Copyright (C) 2013-2017 Wolfram Sang <wsa@the-dreams.de>
Copyright (C) 2007 David Brownell (simplification, cleanup)
Copyright (C) 1999 by Silicon Graphics, Inc.
Copyright: [copy] 2009-2010 Stephane Chatty
Copyright (C) 1996 David Sitsky (David.Sitsky@anu.edu.au)
Copyright (C) 1997, 1998 Jakub Jelinek (jj@sunsite.mff.cuni.cz)
Copyright (C) 1997 Miguel de Icaza (miguel@nuclecu.unam.mx)
Copyright (c) 2014-2016 QLogic Corporation
Copyright (c) 2016-2017 Cavium Inc.
Copyright (C) 2015-2016 Bamvor Jian Zhang <bamv2005@gmail.com>
Copyright (C) 2017 Bartosz Golaszewski <brgl@bgdev.pl>
Copyright (C) 2006 Qumranet Avi Kivity <avi@qumranet.com> Yaniv Kamay <yaniv@qumranet.com>
Copyright 2003-2004 Jeff Garzik
Copyright(c) 2015 Intel Deutschland GmbH
Copyright (C) 2010 Slimlogic Ltd.
Copyright (C) 2010 Texas Instruments Inc.
Copyright (C) 2016 STMicroelectronics SAS

"Copyright (C) 1998-2000 Andre Hedrick <andre@linux-ide.org>"
Copyright (C) 2017 Dennis Zhou <dennisz@fb.com>
Copyright 2008 Wolfgang Grandegger <wg@denx.de>
Copyright (c) 2014 Huawei Ltd.
Copyright (C) 2011-2014 Atmel Corporation
Copyright (C) 2012 Google, Inc.
Copyright (C) 2014 Google, Inc. Tomasz Figa <tfiga@chromium.org>
Copyright (C) 2010 Tomohiro Kusumi <kusumi.tomohiro@jp.fujitsu.com>
Copyright (C) 1995 Linus Torvalds (Linus.Torvalds@helsinki.fi)
Copyright (C) 1996 David S. Miller (davem@caip.rutgers.edu)
Copyright (C) 1996 Jakub Jelinek (jj@sunsite.mff.cuni.cz)
Copyright (C) 2002-2003 Patrick Mochel <mochel@osdl.org>
Copyright (C) 2002-2003 Open Source Development Labs
Copyright (C) 2003 Paul Mundt
Copyright (C) 2014 Jackie Hwang
Copyright (C) 2014 Chen-Yu Tsai
Copyright (c) 2011, Javier Lopez <jlopex@gmail.com>
Copyright (c) 2010, Intel Corporation.
Copyright(C) in bits (*128) MOVQ_R64_XMM %r12, %xmm1
Copyright (c) 2009 MontaVista Software, Inc. Author: Anton Vorontsov <avorontsov@ru.mvista.com>
Copyright (c) 2016 Facebook
Copyright 1997-1998 DAVICOM Semiconductor, Inc. All Rights Reserved.
Copyright (c) 2004-2007, Michael Wu <flamingice@sourmilk.net>
copyright (c) 2003 by David Young <dyoung@pobox.com> and used with permission.
Copyright (C) 2011 Google, Inc.
Copyright (C) 1999 Don Dugger <don.dugger@intel.com>
Copyright (C) 1999-2000 VA Linux Systems
Copyright (C) 1999-2000 Walt Drummond <drummond@valinux.com>
Copyright 2018 Omnibond Systems, L.L.C.
Copyright (C) 2006,2007 Thomas Bogendoerfer (tsbogend@alpha.franken.de)
Copyright(C) 2005, Red Hat, Inc., Ingo Molnar
Copyright (C) 2007 Alain Degreffe (eczema@ecze.com)
Copyright (C) 2006 Juan Carlos Borrás
Copyright (C) 2011 Peter Zijlstra
Copyright (C) 2008 Texas Instruments.
Copyright (C) 2015-16 by Renesas Electronics Corporation
Copyright (C) 2004 MontaVista Software, Inc.
Copyright (c) 2017 Ksenija Stanojevic <ksenija.stanojevic@gmail.com>
Copyright (C) 2007-2011 Nokia Corporation
Copyright (C) 2005 Duncan Sands, Roman Kagan (rkagan % mail ! ru)
Copyright (C) 2007 Simon Arlott
Copyright (C) 2009 Simon Arlott
Copyright (C) 2014 Felix Fietkau <nbd@openwrt.org>
Copyright 2007 Intel Corporation Author: Matthew Wilcox <willy@linux.intel.com>
Copyright (C) 2018 Lubomir Rintel <lkundrak@v3.sk>
Copyright (C) 2015 Jakub Kicinski <kubakici@wp.pl>
Copyright (c) 2007 Philipp Zabel <philipp.zabel@gmail.com>
Copyright (C) 2005, Intec Automation (mike@steroidmicros.com)
Copyright (C) 1999-2007, Greg Ungerer (gerg@snapgear.com)
Copyright (C) 2015 Lyude Paul <thatslyude@gmail.com>
Copyright (C) 2005 Takahiro Hirofuchi names_free() is added.
Copyright (C) 1996, 1997, 1998 by Ralf Baechle and i386 version.
Copyright (c) 2007-2008 Intel Corporation Jesse Barnes <jesse.barnes@intel.com>
Copyright: (C) 2011 Gilles Muller, INRIA/LiP6. URL: http://coccinelle.lip6.fr/ Comments:
Copyright (c) 2008, 2009 QLogic Corporation. All rights reserved.
Copyright (c) Adrian McMenamin, 2008 - 2009
Copyright © 2006 Red Hat UK Limited

LICENCE TERMS (cont.)

Copyright (c) by Takashi Iwai <tiwai@suse.de>
Copyright (C) 2007-2009 John Williams <john.williams@petalogix.com>
Copyright (c) 2006 PathScale, Inc. All rights reserved.
Copyright (c) Russ Anderson <rja@sgi.com>
Copyright (C) 2004 Google, Inc. (Ken Harrenstien)
"Copyright (c) 1999 Pavel Machek <pavel@ucw.cz>"
"Copyright (c) 1999 Johannes Erdfelt <johannes@erdfelt.com>"
"Copyright (c) 2000 Vojtech Pavlik <vojtech@suse.cz>"
"Copyright (c) 2004 Oliver Neukum <oliver@neukum.name>"
"Copyright (c) 2005 David Kubicek <dave@awk.cz>"
"Copyright (c) 2011 Johan Hovold <jhovold@gmail.com> "
Copyright © 2006-2009 Intel Corporation
Copyright (C) 1994, Linus Torvalds
Copyright(C) Copyright IBM Corp. 2005
Copyright (C) 2003, 06 Ralf Baechle (ralf@linux-mips.org)
Copyright (c) 2004-2006 Silicon Graphics, Inc. Modified by Paul Jackson <pj@sgi.com> Modified by Christoph Lameter <cl@linux.com> Modified by Paul Menage <menage@google.com> Modified by Hidetoshi Seto <seto.hidetoshi@jp.fujitsu.com>
Copyright (C) 2010 Nokia Corporation Paul Walmsley
Copyright (C) 2009 Lemote, Inc. Author: Wu Zhangjin <wuzhangjin@gmail.com>
Copyright (C) 2004-2016 Emulex. All rights reserved. * EMULEX and SLI are trademarks of Emulex. * www.broadcom.com *
Copyright (C) 2015 - 2017 Intel Deutschland GmbH
Copyright 2008 Intel Corporation Author: Andi Kleen
Copyright 2006 Johannes Berg <johannes@sipsolutions.net>
Copyright (C) 2004 Jan M. Hochstein hochstein@algo.informatik.tu-darmstadt.de>
Copyright (C) 1999 Ingo Molnar <mingo@redhat.com>
Copyright(c) 2009 IBM Corp.
Copyright (c) 2007 Jakob Bornecrantz <wallbraker@gmail.com>
Copyright (c) 2008 Red Hat Inc.
Copyright (c) 2007-2008 Tungsten Graphics, Inc., Cedar Park, TX., USA
Copyright (c) 2007-2008 Intel Corporation
Copyright (c) 2002 Richard Russon
copyright(C) 2005 Thomas Winischhofer.
Copyright(c) 2016 Intel Deutschland GmbH All rights reserved.
Copyright (C) Darryl Miles G7LED (dlm@g7led.demon.co.uk)
Copyright (C) Hans Alblas PE1AYX (hans@esrac.ele.tue.nl)
Copyright 2017 Savoir-Faire Linux
Copyright 2004-2007 Freescale Semiconductor, Inc. All Rights Reserved.
Copyright (C) 2008 Compulab, Ltd. Mike Rapoport <mike@compulab.co.il>
Copyright Linas Vepstas <linas@austin.ibm.com> 2004
Copyright (C) 2008 Wind River Systems
Copyright (C) 2019 Intel Corporation Author: Luis Carlos Cobo <luisca@cozybit.com>
Copyright 1995-1996 by Mylex Corporation. All Rights Reserved
Copyright 2015 Maxime Ripard
Copyright (C) 2006 Nokia Corporation Author: Imre Deak <imre.deak@nokia.com>
Copyright (C) 2011-2015 Freescale Semiconductor, Inc. Based on max8903_charger.c This program is free software
Copyright either version 2 of the License, or
Copyright (C) 1997 Geert Uytterhoeven.
Copyright 2011 Analog Devices Inc (from AD7923 Driver)
Copyright 2012 CS Systemes d'Information
Copyright (C) 2003-2005 Bartlomiej Zolnierkiewicz
Copyright 1993 United States Government as represented by the Director, National Security Agency. This software may be used and distributed according to the terms of the GNU General Public License, incorporated herein by reference. Donald Becker may be reached at becker@scylid.com
Copyright (C) 2008-2009 microdia project <microdia@googlegroups.com>
Copyright (C) 2009 Brian Johnson <brijohn@gmail.com>

Copyright 2009 Cam Macdonell <cam@cs.ualberta.ca>
Copyright 1999-2001 Jeff Garzik
Copyright 2001-2004 Jeff Garzik
Copyright (C) 2009 Siemens AG
Copyright (C) 2009 Valentin Sidikov
Copyright (c) 2006-2008 Intel Corporation
Copyright (c) 2007 Dave Airlie <airlied@linux.ie>
Copyright (c) 2010-2012 NVIDIA Corporation. All rights reserved.
Copyright (c) 2012-2013, The Linux Foundation. All rights reserved.
Copyright (c) 2013-2016 Broadcom
Copyright 2018-2019 NXP Semiconductors
Copyright (C) 2010 Texas Instruments Incorporated Author: Erik Gilling <konkers@android.com>
Copyright (c) 2005 Ian Molton
Copyright (C) 2009-2010 Texas Instruments
Copyright (c) 2018, Intel Corporation.
Copyright 2014 Intel Corporation
Copyright (c) 2014-2015 Scott Feldman <sfeldma@gmail.com>
Copyright (C) 2013-2015 Avago Technologies mailto: MPT-FusionLinux.pdl@avagotech.com)
Copyright (C) 2006-2015 Nicolas Pitre
Copyright (C) 2004 Psion Teklogix (for NetBook PRO)
Copyright (C) 2004 David Brownell
Copyright (C) 1999 Roman Weissgaerber
Copyright (C) 2011 ST-Ericsson SA Authors: Mian Yousaf Kaukab <mian.yousaf.kaukab@stericsson.com> Praveena Nadahally <praveen.nadahally@stericsson.com> Rajaram Regupathy <ragupathy.rajaram@stericsson.com>
Copyright (C) 2002 Andy Grover <andrew.grover@intel.com>
Copyright (C) 2010 Sameer Ahmad, Lantiq GmbH
Copyright (C) 2014 Seth Jennings <sjenning@redhat.com>
Copyright (C) 2017 Joe Lawrence <joe.lawrence@redhat.com>
Copyright 2009 Red Hat Inc.
Copyright 2007 Holger Schurig
Copyright 2016 Advanced Micro Devices, Inc.
Copyright (C) 2005 by HP Labs
Copyright (C) 2005 by David Brownell
Copyright (C) 2001 Daniel Barlow
Copyright (c) 2007 Michel Ludwig <michel.ludwig@gmail.com> DVB-T support
Copyright 2005 MontaVista Software Inc.
Copyright 2007 Freescale Semiconductor, Inc.
Copyright (C) 2016-2018 Vadim Pasternak <vadimp@mellanox.com>
copyright(c) Copyright 1996 Alan Cox <alan@lxorguk.ukuu.org.uk>, All Rights Reserved.
copyright(c) Copyright 1995 Alan Cox <alan@lxorguk.ukuu.org.uk>
Copyright (C) 2004 IBM Inc.
Copyright (C) 1992, Linus Torvalds
Copyright (C) 2003-2004 Alexey Fisher <fishor@mail.ru> Jean Delvare <khali@linux-fr.org>
Copyright (C) 2006 Sylvain Munaut <tnt@246tNt.com>
Copyright (c) 2010 Adam Bennett)
Copyright (C) 1999, 2000 Silicon Graphics, Inc.
Copyright (C) 2004 Christoph Hellwig.
Copyright (C) 2016 Red Hat, Inc. All rights reserved. Author: Alex Williamson <alex.williamson@redhat.com>
copyright(c) Copyright 2000-2001 Marek Michalkiewicz <marekm@linux.org.pl>
Copyright 2001 MontaVista Software Inc.
Copyright (C) 1996-1999 Russell King
Copyright © 2006-2007 Intel Corporation
Copyright 2017 VMware Inc. Steven Rostedt Converted to rst format - Changbin Du <changbin.du@intel.com>
Copyright (C) 2005 IBM Corporation
Copyright 2002 Phil Karn, KA9Q
Copyright (C) 2009 Hewlett-Packard Development Company, L.P. Paul Moore <paul@paul-moore.com>
Copyright (C) 2010 Nokia Corporation

LICENCE TERMS (cont.)

Copyright (C) 2011 Intel Corporation.
Copyright 2004 Simtec Electronics\n
Copyright (C) 2017 VMware, Inc. All Rights Reserved.
Copyright (C) 2016 Linaro Ltd <ard.biesheuvel@linaro.org>
Copyright 2012 Xyratex Technology Limited
Copyright 2011,2016 Freescale Semiconductor, Inc.
Copyright (C) 1999 G. Allen Morris III <gam3@acm.org> Extensive rewrite by Neil Brown <neilb@cse.unsw.edu.au>
Southern-Spring 1999 and again Southern-Winter 2001 to support export_operations
Copyright (C) 2001 Georges Menie, Ken Desmet
Copyright (C) Egbert Eich 2003,2004
Copyright (C) Dave Airlie 2005 All Rights Reserved.
Copyright © 2000-2005 Thomas Gleixner <tglx@linuxtronix.de>
Copyright 2007 Sony Corporation
Copyright (C) 2007-2008 Pierre Ossman
Copyright (C) 2010 Linus Walleij
Copyright (C) 2013-2014 Avago Technologies mailto: MPT-FusionLinux.pdl@avagotech.com)
"Copyright (C) 2015-2017 Intel Deutschland GmbH"
Copyright (C) 2009-2012 Texas Instruments Added OMAP4/5 support - Santosh Shilimkar <santosh.shilimkar@ti.com>
Copyright (C) 2015 Martin Willi
Copyright (C) 2007 Rudolf Marek <r.marek@assembler.cz>
Copyright (c) 2014-2015 MediaTek Inc.
Copyright 2009 MontaVista Software, Inc.
Copyright (C) 2015 Intel Corporation.
Copyright (c) 2014 Samsung Electronics Co., Ltd Derived from drivers/video/backlight/l9040.c
Copyright (C) 2009 Matt Fleming
Copyright (C) 2002 - 2012 Paul Mundt
Copyright (C) 2001 O'Reilly & Associates
Copyright (c) 2018 Red Hat, Inc. All rights reserved.
Copyright (C) 1998 Deborah Wallach (updates for SA1100/Brutus).
Copyright (C) 1999 Nicolas Pitre (full GPIO irq isolation)
Copyright (C) 2015 Dave Penkler <dpenkler@gmail.com>
Copyright (c) 2018 Todd Kelner
Copyright (C) 2004 Dmitry Torokhov
Copyright (c) 2019 Cloudflare
Copyright (C) 2007 Nokia Corporation.
Copyright (C) 2000-2001 Qualcomm Incorporated
Copyright (C) 2002-2003 Maxim Krasnyansky <maxk@qualcomm.com>
Copyright (C) 2004-2005 Marcel Holtmann <marcel@holtmann.org>
Copyright (C) Fujitsu, 2012
Copyright (C) 2012 Intel Corporation. All rights reserved.
Copyright (c) 2012-2015, The Linux Foundation. All rights reserved.
Copyright (c) 1985, 1986 The Regents of the University of California. All rights reserved.
Copyright 2006 Sony Corp.
Copyright 2003, 2004 (c) MontaVista Software, Inc.
Copyright (C) 2014 Freescale Semiconductor, Inc.
Copyright (C) 2009 Daniel Mack <daniel@caiaq.de>
Copyright (C) 2017 Sebastian Reichel <sre@kernel.org>
Copyright 2013 Philipp Zabel, Pengutronix
Copyright (C) 1998 Alan Cox & Andi Kleen
Copyright(c) 1999 Dragos Acostachioaie <dragos@iname.com>
Copyright(c) 1999 Manfred Spraul <manfred@colorfullife.com>
Copyright (c) 2004, Intel Corporation.
Copyright (C) 2018 - 2019 Intel Corporation
Copyright (C) 2013 ARM Ltd.
Copyright (C) 2008-2009 Paulius Zaleckas <paulius.zaleckas@teltonika.lt>
Copyright (C) 1995-1999 Russell King

Copyright (C) 2014 ROCKCHIP, Inc.
Copyright (C) 2009-2010 Gabor Juhos <juhosg@openwrt.org>
Copyright (C) 2010 Antti Seppälä, <a.seppala@gmail.com>
Copyright (C) 2010 Roman Yeryomin <roman@advem.lv>
Copyright (C) 2011 Colin Leitner <colin.leitner@googlemail.com>
Copyright (c) 2005-2006 DENX Software Engineering Stefan Roese <sr@denx.de>
Copyright 2004 Freescale Semiconductor Inc.
Copyright 2002 (C) Intel Corporation
Copyright 2003-2004 (C) MontaVista, Software, Inc.
Copyright (C) Deepak Saxena <dsaxena@plexity.net>
Copyright (C) 1998 Andrew Veliath
Copyright (C) 1998 Andrew Veliath
Copyright (c) 2005-2008 DLA Systems, David H. Lynch Jr. <dhlii@dlasys.net>
Copyright (c) 2008-2009 Secret Lab Technologies Ltd.
Copyright (C) 2007-2010 Nokia Corporation Paul Walmsley
Copyright (C) 2013-2015 Freescale Semiconductor, Inc.
Copyright (C) 2008-2009 Wolfgang Grandegger <wg@grandegger.com>
Copyright (C) 2008-2009 Pengutronix <kernel@pengutronix.de>
Copyright (C) 2016-2019 Bootlin
Copyright (C) 2000-2001 Toshiba Corporation
Copyright (C) 2007 MIPS Technologies, Inc.
Copyright (C) 2007 Ralf Baechle <ralf@linux-mips.org>
Copyright (C) 2017 Collabora Ltd.
Copyright (C) 2012 Dmitry Torokhov <dmitry.torokhov@gmail.com>
Copyright (C) 2010, Lars-Peter Clausen <lars@metafoo.de>
Copyright 1994, 1995 Digital Equipment Corporation. [de4x5.c]
copyright 1994-2001 by Donald Becker. [tulip.c]
Copyright 1994, 1995 Digital Equipment Corporation.
Copyright (C) 2008 Guennadi Liakhovetski, Pengutronix
Copyright (C) 2009 Wolfram Sang, Pengutronix
Copyright 2012 Yuanhan Liu All Rights Reserved
Copyright 2002 H. Peter Anvin - All Rights Reserved
Copyright (C) 2017 Linaro Ltd. <ard.biesheuvel@linaro.org>
Copyright (c) 2015 Kuninori Morimoto <kuninori.morimoto.gx@renesas.com>
Copyright 2001-2003 S3 Graphics, Inc. All Rights Reserved.
Copyright (C) 2010 Alexey Charkov <alchark@gmail.com>
Copyright (C) 2013 SKTB SKIT, http://www.skittlab.ru/
Copyright 2005 (c) MontaVista Software, Inc. with the majority of the code coming from:
Copyright (C) 2009 by Rick L. Vinyard, Jr. <rvinyard@cs.nmsu.edu> *
Copyright (c) 2013 - 2018 Intel Corporation."
Copyright (C) 1997, 1998, 1999, 2000 Ralf Baechle
Copyright (C) 2001, 2003 Ladislav Michl
Copyright (C) 2016 Freescale Semiconductor, Inc
Copyright (c) 2016 Maxime Ripard <maxime.ripard@free-electrons.com>
Copyright (c) 2014 The Linux Foundation. All rights reserved.
Copyright (C) 1996-1999 Jakub Jelinek (jj@sunsite.mff.cuni.cz)
Copyright (C) 1997 Anton Blanchard (anton@progsoc.uts.edu.au)
Copyright (C) 2018 Himanshu Jha <himanshujha199640@gmail.com>
Copyright (C) 1998, 1999, 2003 Ralf Baechle
Copyright (c) 2016 Intel Corporation
Copyright (C) 2014 Lad, Prabhakar <prabhakar.csengg@gmail.com>
Copyright (C) 2006 Atmark Techno, Inc.
Copyright (c) 1995-1996 Gary Thomas <gdt@linuxppc.org> Initial PowerPC version.
Copyright 2007-2008 rPath, Inc. - All Rights Reserved
Copyright (C) 2002 - 2009 Paul Mundt
Copyright Distributed Processing Technology, Corp. 140 Candace Dr. Maitland, FL 32751 USA Phone: (407) 830-5522 Fax: (407) 260-5366 All Rights Reserved

LICENCE TERMS (cont.)

Copyright (C) 2013-2016 John Crispin <john@phrozen.org>
Copyright (c) 2002, 2006, 2008 David S. Miller (davem@davemloft.net)
Copyright (C) 2009 David Brownell
Copyright (C) 1996 David S. Miller (davem@davemloft.net)
Copyright (c) 1998 Harald Koerfgen
Copyright 2009 Integrated Device Technology, Inc. Alex Bounine <alexandre.bounine@idt.com> Added Port-Write/ Error Management initialization and handling
Copyright 2009 Sysgo AG Thomas Moll <thomas.moll@sysgo.com> Added Input- Output- enable functionality, to allow full communication
Copyright (C) 2000-2004 Netfilter Core Team <coreteam <at> netfilter.org>
Copyright (C) 2008 Red Hat, Inc., James Morris <jmorris <at> redhat.com>
Copyright (C) 2010 Rafael J. Wysocki, Novell Inc.
Copyright (c) 2016-2018 Microsemi Corporation
Copyright (c) 2016 PMC-Sierra, Inc.
Copyright (C) 2015 Gerhard Bertelsmann All rights reserved.
Copyright (C) 2014 Oliver Hartkopp <oliver.hartkopp@volkswagen.de>
Copyright (C) 2007 Wolfgang Grandegger <wg@grandegger.com>
Copyright (C) 2002-2007 Volkswagen Group Electronic Research
Copyright (C) 2003 Matthias Brukner, Trajet Gmbh, Rebenring 33, 38106 Braunschweig, GERMANY
Copyright (c) Lee Revell <lrevell@joe-job.com>
copyright(C) in bits (*128) vmovq %r12, %xmm1 vpslldq \$8, %xmm15, %xmm15 # xmm15 = len(A)||
0x0000000000000000
Copyright (C) 1999-2001 Naval Research Laboratory
Copyright (C) 1997 by Digital Equipment Corporation, Maynard, Massachusetts. All rights reserved.
Copyright (C) Intel Corporation, 2005
Copyright (c) 2002 Paul Mundt <lethal@chaoticdreams.org>
Copyright (c) 2002-2003 Open Source Development Labs
Copyright (c) 2006-2008 Greg Kroah-Hartman <greg@kroah.com>
Copyright (c) 2006-2008 Novell Inc.
Copyright (c) 2013 Tomasz Figa <tomasz.figa@gmail.com>
Copyright (C) 2001-2005 Stelian Pop <stelian@popies.net>
Copyright (C) 2005 Narayanan R S <nars@kadamba.org>
Copyright (C) 2001 Michael Ashley <m.ashley@unsw.edu.au>
Copyright (C) 2001 Junichi Morita <jun1m@mars.dti.ne.jp>
Copyright (C) 2000 Takaya Kinjo <t-kinjo@tc4.so-net.ne.jp>
Copyright 2008 Thomas Bogendoerfer <tsbogend@alpha.franken.de>
Copyright 1999 Silicon Graphics, Inc. All rights reserved.
Copyright (c) 2013 - 2019 Intel Corporation."
Copyright (c) 2018 Protonic, Robin van der Gracht <robin@protonic.nl>
Copyright(C) 2003 Christoph Jungegger <disdos@traum404.de>
Copyright (C) 2001 Daniel Barlow Some of this code is borrowed from orinoco_pci.c
Copyright (C) 2001 Jean Tourrilhes Some of this code is "inspired" by linux-wlan-ng-0.1.10, but nothing has been copied from it. linux-wlan-ng-0.1.10 is originally :
Copyright (C) 1997 Eddie C. Dost (ecd@skynet.be)
copyright(C) 1999 Helge Deller <deller@gmx.de>
copyright 1999 SuSE GmbH (Philipp Rumpf)
copyright 2000 Martin K. Petersen <mkp@mkp.net>
copyright 2000 Philipp Rumpf <prumpf@tux.org>
copyright 2001 Ryan Bradetich <rbradetich@uswest.net>
Copyright (C) 1998-2002 Linux ATA Development Andre Hedrick <andre@linux-ide.org>
Copyright (C) 1999 by Silicon Graphics, Inc.
Copyright (c) 1995-1998 Mark Lord
Copyright (C) 2008 Andy Walls <awalls@md.metrocast.net>
Copyright (c) 2015 Linaro Ltd. www.linaro.org
Copyright (c) 2010 Janusz Krzysztofik
Copyright (C) 2014 Daniel Golle <daniel@makrotopia.org>
Copyright (C) 2012 John Crispin <blogic@openwrt.org>

Copyright (C) 2000, 2002 Maciej W. Rozycki
Copyright (C) 2006, 2007 Motorola Inc.
Copyright (c) 2001 Jean-Fredric Clere, Nikolas Zimmermann, Georg Acher Mark Cave-Ayland, Carlo E Prezl, Dick Streefland
Copyright (c) 2002, 2003 Tuukka Toivonen
Copyright © 2007 Nokia Corporation
Copyright 1997–1999 Martin Mares <mj@ucw.cz>
Copyright (C) 1996, 1997, 1998, 1999 by Ralf Baechle
Copyright (C) 2010 Barnes & Noble, Inc. Author: Pieter Truter<p.truter@intrinsyc.com>
Copyright (C) 2007 by Maciej W. Rozycki
Copyright (C) 2011, 2012 MIPS Technologies, Inc.
Copyright (c) 2008 Herbert Xu <herbert@gondor.apana.org.au>
Copyright (c) 2019 Google LLC
Copyright (C) 2017 T-Platforms. All Rights Reserved.
Copyright 1995, Russell King
Copyright (c) 2014, Inforce Computing. All rights reserved.
Copyright (C) 2013 Mark Salter <msalter@redhat.com>
Copyright (c) 2003 Will Schmidt IBM Corporation.
Copyright (c) 2004 Will Schmidt IBM Corporation. Nathan Lynch nathanl@austin.ibm.com
Copyright (C) 2004 Nathan Lynch IBM Corporation.
Copyright (C) 2004, 2005, 2007 Maciej W. Rozycki
Copyright (c) 2010, ST-Ericsson Author: Dmitry Tarnyagin <dmitry.tarnyagin@lockless.no>
Copyright (C) 2010 Emulex. All rights reserved. * EMULEX and SLI are trademarks of Emulex. * www.broadcom.com *
Copyright (C) 2005 Benjamin Herrenschmidt <benh@kernel.crashing.org>, IBM Corp.
Copyright (c) 2004 Valtaire Corporation. All rights reserved.
Copyright (C) 2018 Vasily Khoruzhick <anarsoul@gmail.com>
Copyright (c) 2007-2008 Oliver Neukum
Copyright (c) 2006-2010 Jiri Kosina
Copyright (C) 2001-2003 IBM Corp.
Copyright © 2007 Dave Airlie
Copyright 2005-2006 Luc Verhaegen
Copyright (c) 2001, Andy Ritger aritger@nvidia.com
Copyright (C) 1995 Michael Dreher
Copyright (c) 2017 Oscar Campos
Copyright (c) 2017 Aaron Bottegall
Copyright (C) 2017 Quentin Schulz <quentin.schulz@free-electrons.com>
Copyright (C) 2009 Renesas Technology Corp.
Copyright (C) 2010 Texas Instruments, Inc. Thara Gopinath <thara@ti.com>
"Copyright (C) 1997,1998 Jakub Jelinek (jj@sunsite.mff.cuni.cz)"
"Copyright (C) 2000,2001,2002 Andi Kleen, SuSE Labs (x86-64 port) "
Copyright (C) 2006-2009 Felix Fietkau <nbd@openwrt.org>
Copyright (C) 2012 Alexandros C. Couloumbis <alex@ozo.com>
Copyright (C) 2014 - 2018 Linaro Ltd. <ard.biesheuvel@linaro.org>
Copyright 2007 Wolfson Microelectronics PLC. - linux@wolfsonmicro.com Graeme Gregory - graeme.gregory@wolfsonmicro.com
Copyright © 2007-2008 Andres Salomon <dilinger@debian.org>
Copyright (c) Nokia Corporation, 2006, 2007
Copyright (C) 2001 Russell King, All Rights Reserved.
Copyright 2009 Sascha Hauer, s.hauer@pengutronix.de
Copyright 2012 Philippe Retornaz, philippe.retornaz@epfl.ch
Copyright (c) 2000 by Abramo Bagnara <abramo@alsa-project.org>
Copyright (C) 2005 Kirk Lapray <kirk_lapray@bigfoot.com>
Copyright (C) 2002 & pcHDTV, inc.
Copyright (C) 2015 Sony Mobile Communications Inc
Copyright (C) 2000 Vinh Truong (vinh.truong@eng.sun.com) VT - The implementation is to support Sun Microelectronics (SME) platform environment monitoring. SME platforms use pcf8584 as the i2c bus controller to

LICENCE TERMS (cont.)

access pcf8591 (8-bit A/D and D/A converter) and pcf8571
Copyright (C) 2007 Novell Inc.
Copyright (C) 2007 MIPS Technologies, Inc. written by Ralf Baechle (ralf@linux-mips.org)
Copyright (c) 2004 Jaroslav Kysela <perex@perex.cz>
Copyright (C) 2013, Intel Corporation. All rights reserved.
Copyright (C) 1999 Oystein Svendsen <svendsen@pvv.org>
Copyright (C) 2012 Samsung Electronics Author: Donggeun Kim <dg77.kim@samsung.com> Author: MyungJoo Ham <myungjoo.ham@samsung.com>
Copyright (C) 2008 Google, Inc. Author: Mike Lockwood <lockwood@android.com>
Copyright (c) 2007-2008 Matthew W. S. Bell <mentor@madwifi.org>
Copyright (C) 2003 Adaptec, Inc. */
COPYRIGHT_STRING "(C) Copyright IBM Corp. 1994, 2002. All Rights Reserved."
COPYRIGHT_STRING "(c) Copyright Adaptec, Inc. 2002 to 2004. All Rights Reserved."
COPYRIGHT_STRING "(c) Copyright Dell 2004. All Rights Reserved."
COPYRIGHT_STRING "(C) Copyright IBM Corp. 1994, 2002."
copyright_STRING "(C) Copyright IBM Corp. 1994, 2002. All Rights Reserved."
copyright_STRING "(c) Copyright Adaptec, Inc. 2002 to 2004. All Rights Reserved."
copyright_STRING "(c) Copyright Dell 2004. All Rights Reserved."
copyright_STRING "(C) Copyright IBM Corp. 1994, 2002."
Copyright (c) 2004 Silicon Graphics, Inc.
Copyright (c) 2007 Tejun Heo <teho@suse.de>
Copyright (c) Nokia Corporation, 2006
Copyright (C) 2009 Simplemachines MMC support by Peter Ivanov <ivanovp@gmail.com>, 2007
Copyright (C) 2010 Nokia Corporation Tony Lindgren <tony@atomide.com> Added OMAP4 support - Santosh Shilimkar <santosh.shilimkar@ti.com>
Copyright (C) 2016 Renesas Electronics Corporation
Copyright (c) 2002 Vojtech Pavlik
Copyright (C) 2009, Bollere telecom (www.bolloretelecom.eu).
Copyright (C) 2011-2012 Mike Turquette, Linaro Ltd <mturquette@linaro.org>
Copyright (C) 2012 Stephen Warren
Copyright 2008-2009 Embedded Alley Solutions, Inc All Rights Reserved.
Copyright (c) 2010-2011 EIA Electronics, Kurt Van Dijk <kurt.van.dijk@eia.be>
Copyright (C) 2014 Cogent Embedded Inc.
Copyright (c) 2015, National Instruments Corp.
Copyright (C) 2004, 2006 Maciej W. Rozycki
Copyright (c) 2012 Wind River Systems, Inc.
Copyright (C) 2013 Pengutronix e.K.
Copyright (C) 2013 Xilinx Inc.
Copyright (c) 2007 Freescale Semiconductor, Inc.
Copyright (C) 2015 Linaro Ltd. <ard.biesheuvel@linaro.org>
Copyright 2002-2004 H. Peter Anvin - All Rights Reserved
Copyright (C) 2009 Uwe Kleine-Koenig, Pengutronix
Copyright (C) 2002- 2007 Jeff Dike (jdike@{addtoit,linux.intel}.com)
Copyright (c) 2007, 2010 Intel Corporation Jesse Barnes <jesse.barnes@intel.com>
Copyright (C) 2005 Ilya A. Volynets <ilya@total-knowledge.com>
Copyright history from vga16fb.c:
Copyright 1999 Ben Pfaff and Petr Vandrovec Based on VGA info at <http://www.osdever.net/FreeVGA/home.htm>
copyright(c) 1998 Gerd Knorr
copyright(c) 1993 Tommy Frandsen */
Copyright 1993 Harm Hanemaayer */
copyrighted (C) 1993 by Hartmut Schirmer */
Copyright(c) 1998 Gerd Knorr
Copyright(c) 1993 Tommy Frandsen */
Copyright (c) 2013 Martin Rusko
Copyright (C) 2006-2007 Freescale Semiconductor
Copyright (c) 2016, Intel Corporation Author: Giovanni Cabiddu <giovanni.cabiddu@intel.com>
Copyright (c) 2006-2012 Patrick McHardy <kaber@trash.net>
Copyright (C) 2014-2017 Pengutronix, Marc Kleine-Budde <kernel@pengutronix.de>
Copyright(c) Copyright 2001 Red Hat Inc.
Copyright (C) 2008 Krzysztof Halasa <khc@pm.waw.pl>
Copyright 2007, Broadcom Corporation
Copyright (C) 2000 Martin K Petersen <mkp at mkp.net>
Copyright (C) 2000 David Huggins-Daines <dhd with pobox.org>
Copyright (C) 2000 Philipp Rumpf <prumpf with tux.org>
Copyright (C) 2000 David Kennedy <dkennedy with linuxcare.com>
Copyright (C) 2000 Grant Grundler <grundler with parisc-linux.org>
Copyright (C) 2001 Alan Modra <amodra at parisc-linux.org>
Copyright (C) 2001-2002 Ryan Bradetich <rbrad at parisc-linux.org>
Copyright (C) 2001-2014 Helge Deller <deller@gmx.de>
Copyright (C) 2002 Randolph Chung <tausq with parisc-linux.org>
Copyright (C) 1996-1998 Erik Andersen <andersee@debian.org>
Copyright (C) 1998-2000 Jens Axboe <axboe@suse.de>
Copyright (C) 2005, 2007-2009 Bartłomiej Zolnierkiewicz
Copyright (C) 2004 - 2008 Nokia Corporation Written by Tuukka Tikkanen <tuukka.tikkanen@elektrobit.com>
Copyright (C) 2012 Texas Instruments, Inc. Written by Tony Lindgren <tony@atomide.com>
Copyright (c) by Francisco Moraes <fmoraes@nc.rr.com>
Copyright (C) 2012 NVIDIA CORPORATION. All rights reserved.
Copyright (C) 2005-2008 Johannes Berg (johannes@sipsolutions.net)
Copyright (C) 2005-2008 Stelian Pop (stelian@popies.net)
Copyright (C) 2006 Nicolas Boichat (nicolas@boichat.ch)
Copyright (C) 2007-2008 Sven Anders (anders@anduras.de)
Copyright (C) 2006 MontaVista Software, Inc.
Copyright (C) 2003 David Borowski.
Copyright (C) 2015: Linus Lüssing <linus.luessing@c0d3.blue>
Copyright (C) 2002, 2006 Ken Chen <kenneth.w.chen@intel.com>
Copyright 2014 Cisco Systems, Inc. and/or its affiliates. All rights reserved.
Copyright (C) 2010 Matthias Fuchs <matthias.fuchs@esd.eu>, esd gmbh
Copyright (C) 2012 Olivier Sobrie <olivier@sobrie.be>
Copyright (C) 2015 Valeo S.A.
Copyright 2017-2019 NXP
Copyright 2008-2015 Freescale Semiconductor, Inc. All Rights Reserved.
Copyright 2008 Embedded Alley Solutions, Inc All Rights Reserved.
Copyright (C) 1999, 2002-2003 Hewlett-Packard Co. David Mosberger-Tang <davidm@hpl.hp.com> Stephane Eranian <eranian@hpl.hp.com>
Copyright (c) 2017 Amlogic, inc. Author: Qiufang Dai <qiuqiang.dai@amlogic.com>
Copyright © 2000-2003 Nicolas Pitre <nico@fluxnic.net>
Copyright (C) 2005 Alex Aizman maintained by open-iscsi@googlegroups.com
Copyright (C) 2003-2008 Red Hat, Inc., James Morris <jmorris@redhat.com> Eric Paris <eparis@redhat.com>
Copyright (C) 2004-2005 Trusted Computer Solutions, Inc. dgoeddel@trustedcs.com>
Copyright (C) 2006, 2007, 2009 Hewlett-Packard Development Company, L.P. Paul Moore <paul@paul-moore.com>
Copyright (C) 2007 Hitachi Software Engineering Co., Ltd. Yuichi Nakamura <ynakam@hitachisoft.jp>
Copyright (c) 2014, The Linux Foundation. All rights reserved.
Copyright (C) 2001-2008, Philipp Reisner <philipp.reisner@linbit.com>.
Copyright (C) 2001-2008, Lars Ellenberg <lars.ellenberg@linbit.com>.
Copyright (C) 2010-2012, NVIDIA CORPORATION. All rights reserved.
Copyright (C) 2007 Hans J. Koch <hjk@hansjkoch.de>
Copyright (C) 2010 PetaLogix
Copyright (C) 2005 John Williams <jwilliams@itee.uq.edu.au>
Copyright(c) 2000-2002 Petr Vandrovec <vandrove@vc.cvut.cz>
Copyright 2001, Nicolas Pitre reworked by rmk.
Copyright (C) 2003-2010 Julian Anastasov
Copyright 2016 Samsung Electronics Co., Ltd.
Copyright (c) 2000 MontaVista Software, Inc (source@mvista.com) 2.3.99 Updates
Copyright(c) MontaVista Software, Inc. Vitaly Bordug <vbordug@ru.mvista.com> Merged to arch/powerpc from arch/

LICENCE TERMS (cont.)

ppc/syslib/cpm2_common.c
Copyright 2014, Intel Corporation
Copyright 2014 Intel Mobile Communications GmbH
Copyright 2015 - 2016 Intel Deutschland GmbH
Copyright (C) 2007 Chase Douglas <chasedouglas@gmail>
Copyright (C) 2006 Lennert Buytenhek <buytenh@wantstofly.org>
Copyright (C) 2015-2018 Linaro Ltd.
Copyright (c) 2012 Linaro Ltd <http://www.linaro.org>
Copyright (c) 2017 Krzysztof Kozlowski <krzk@kernel.org>
Copyright 2009 Freescale Semiconductor Inc.
Copyright (C) 2011 Antti Palosaari <crope@iki.fi>
Copyright 2005-2006,2013,2017-2018 Ian Kent <raven@themaw.net>
Copyright (C) 2010 Ivo van Doorn <IvDoorn@gmail.com>
Copyright (C) 2009 Bartlomiej Zolnierkiewicz <bzolnier@gmail.com>
Copyright (C) 2009 Gertjan van Wingerde <gwingerde@gmail.com>
Copyright (C) 2009 Xose Vazquez Perez <xose.vazquez@gmail.com> <http://rt2x00.serialmonkey.com>
Copyright (C) 1996, 1997, 1998 Ingo Molnar, Miguel de Icaza, Gadi Oxman
Copyright(C) 2003-2004 Paul Clements, SteelEye Technology: persistent bitmap code
Copyright 2010 Ilya Yanok, Emcraft Systems, yanok@emcraft.com
Copyright (C) 2012-2014 Antti Palosaari <crope@iki.fi>
Copyright 2013 Free Electrons
Copyright (c) 2000 Adaptec Inc. All rights reserved.
Copyright (C) 2008 Nokia Corporation
Copyright (C) 2009 EF Johnson Technologies
Copyright (C) 2002, 2003, 2005 Maciej W. Rozycki
Copyright (C) 2003-2004 MontaVista Software, Inc. based on nslu2-power.c
Copyright (C) 2005 Tower Technologies
Copyright (C) 2002-2003 TiVo Inc.
Copyright (C) 2017-2018 ASIX
Copyright (C) 2018 Aquantia Corp.
Copyright (C) 2018-19 Texas Instruments Incorporated - <http://www.ti.com/>
Copyright 1999-2001 Jeff Garzik <jgarzik@pobox.com>
Copyright © CC Computer Consultants GmbH, 2007 - 2008
Copyright 2002-2003, Stephen Frost, 2.5.x port by laforge@netfilter.org
Copyright (C) 2001 Greg Kroah-Hartman <greg@kroah.com>
Copyright (C) 2001 James Morris <jmorris@intercode.com.au>
Copyright (C) 2001 Silicon Graphics, Inc. (Trust Technology Group)
Copyright (C) 2015 Intel Corporation.
Copyright (C) 2015 Casey Schaufler <casey@schaufler-ca.com>
Copyright (C) 2016 Mellanox Technologies
Copyright (C) 2002 David S. Miller (davem@redhat.com)
Copyright (C) 1998 Richard Henderson
Copyright (C) 1999 Alpha Processor, Inc., David Daniel, Stig Telfer, Soohoon Lee)
Copyright (c) 2001-2003 Intel Corp.
Copyright (c) 2011, Code Aurora Forum. All rights reserved. Author: Brian Swetland <swetland@google.com>
Copyright (c) 2015 FUJITSU LIMITED"
Copyright (C) 2017, NXP
Copyright (C) 2007 John Williams <jwilliams@itee.uq.edu.au>
Copyright (C) 2014 Red Hat Inc.
Copyright (C) 2004-2005 by Latchesar Ionkov <lucho@ionkov.net>
Copyright (C) 2004-2008 by Eric Van Hensbergen <ericvh@gmail.com>
Copyright (C) 1997-2002 by Ron Minnich <rminnich@sarnoff.com>
Copyright 2003 Adam Belay <ambx1@neo.rr.com>
Copyright (C) 2002 SHARP
Copyright (c) 2011, Google, Inc.
Copyright 2008 Freescale Semiconductor, Inc. All Rights Reserved.
Copyright 2008 Embedded Alley Solutions, Inc All Rights Reserved.

Copyright 2011 Wolfram Sang, Pengutronix e.K.
Copyright (c) 2007-2016, Synaptics Incorporated
Copyrights (c) 1994,1995,1996 by M.Hipp (hippm@informatik.uni-tuebingen.de)
Copyright 2016 Advanced Micro Devices, Inc.
Copyright (c) Adrian McMenamin, 2007 - 2009
Copyright 2000 Silicon Graphics, Inc.
Copyright (C) 2014 Marvell International Ltd.
Copyright (C) 1998 Eddie C. Dost (ecd@skynet.be) Adaptation from sparc64 version to sparc by Pete Zaitcev.
Copyright (c) 2005-2006 Voltaire, Inc. All rights reserved.
Copyright (c) 2014 Intel Corporation. All rights reserved.
Copyright (C) 2002 Andi Kleen
"Copyright (C) 2005 MIPS Technologies, Inc. All rights reserved. Author: Maciej W. Rozycki <macro@mips.com> "
Copyright (C) 2005, 2007 Bartlomiej Zolnierkiewicz
Copyright (C) 2009 Freescale Semiconductor, Inc. All rights reserved.
Copyright 2011 Red Hat, Inc., Peter Zijlstra
Copyright 2004-2008 Simtec Electronics Ben Dooks <ben@simtec.co.uk> <http://armlinux.simtec.co.uk/>
Copyright (C) 2009 Samsung Electronics Author: Michal Nazarewicz (mina86@mina86.com)
Copyright (C) 2012, 2013 Guenter Roeck <linux@roeck-us.net>
Copyright (c) 2007, 2008 Red Hat, Inc. All rights reserved.
Copyright (c) 2007, 2008 Mike Christie
Copyright (c) 2015 Rockchip Electronics Co. Ltd. Author: Xing Zheng <zhengxing@rock-chips.com>
Copyright (C) 2011 Martin Jansen <martin.jansen@opticon.com>
Copyright (C) 2008 - 2009 Greg Kroah-Hartman <gregkh@suse.de>
Copyright (C) 2008 - 2009 Novell Inc.
Copyright (c) 2008 Erik Andr n
Copyright (c) 2008 Chia-I Wu
Copyright (C) 1997, 1998, 1999, 2000, 2001, 2002 Ralf Baechle (ralf@gnu.org)
Copyright (c) 2010 - Mauro Carvalho Chehab Ported the driver to use rc-core IR raw event decoding is now done at rc-core Code almost re-written
"Copyright 2009 Johannes Berg <johannes@sipsolutions.net>"
Copyright (C) 2014 Sony Mobile Communications AB
Copyright (c) 2017, Ericsson AB All rights reserved.
Copyright (c) 2000, 2001, 2002, 2003, 2004 Broadcom Corporation
Copyright (C) 2005-2007 Freescale Semiconductor, Inc. All Rights Reserved.
Copyright IBM Corp. 2001, 2012
Copyright (C) 2007 Andrew Bird (Sphere Systems Ltd) ajb@spheresystems.co.uk>
Copyright (C) 2008 Novell, Inc.
Copyright (C) 2003 Intel Co Suresh Siddha <suresh.b.siddha@intel.com> Fenghua Yu <fenghua.yu@intel.com>
Arun Sharma <arun.sharma@intel.com>
Copyright (C) 2004-2005 David Brownell
Copyright 2016 Toradex AG
Copyright (C) 2010 OKI SEMICONDUCTOR Co., LTD.
Copyright (C) 2008 by Digi International Inc. All rights reserved.
Copyright (C) 2009 Lemote Inc. Author: Wu zhangjin, wuzhangjin@gmail.com
Copyright (C) 2004 2005 2006 Michel Xhaard mxhaard@magic.fr
Copyright (c) 2000-2001 Vojtech Pavlik
"Copyright(c) ERRNO_OFFSET(BPF_LOADER_ERRNO_##c) define NR_ERRNO (__BPF__
LOADER_ERRNO__END - __BPF_LOADER_ERRNO__START) "
Copyright (c) 2007-2009 Greg Kroah-Hartman <gregkh@suse.de>
Copyright (c) 2007-2009 Novell Inc.
Copyright (C) 2010 Abylay Ospan <aospan@netup.ru>
Copyright 2010 MontaVista Software, LLC. Anton Vorontsov <avorontsov@ru.mvista.com>
Copyright (C) 2014 - 2020 Vivante Corporation
Copyright © 2012-2013 Jussi Kivilinna <jussi.kivilinna@iki.fi>
Copyright (C) Johannes Schindelin, 2005
Copyright 2018 NXP.
Copyright 2013 Michael Ellerman, IBM Corporation.

LICENCE TERMS (cont.)

Copyright 2016 Madhavan Srinivasan, IBM Corporation.
Copyright (C) 2017 Intel Deutschland GmbH
Copyright (C) 1998, 1999 Eddie C. Dost (ecd@skynet.be)
Copyright (C) 1999 Jakub Jelinek (jakub@redhat.com)
Copyright (c) 2013-2016 Avago Technologies
Copyright (c) 2016-2018 Broadcom Inc.
Copyright 2007 David Gibson, IBM Corporation.
Copyright 2009 John F. Reiser <jreiser@BitWagon.com>. All rights reserved.
Copyright 2010 Steven Rostedt <rstedt@redhat.com>, Red Hat Inc.
Copyright (C) 2010 ROCKCHIP, Inc.
Copyright 2016 Maciej W. Rozycki <macro@linux-mips.org>
Copyright (c) 2005, 2006 Cisco Systems, Inc. All rights reserved.
Copyright (C) 2003-2006 Yoichi Yuasa <yuasa@linux-mips.org>
Copyright (C) 1996 Olaf Kirch 04 Aug 1998 Ion Badulescu <ionut@cs.columbia.edu> FIFO's need special handling in NFSv2
Copyright 2002-2011 OProfile authors
Copyright (C) 1996-2001 Cort Dougan <cort@fslabs.com>
Copyright (C) 2018 Google, Inc.
Copyright (C) 2008 Philip Langdale
Copyright (C) 2010 Pierre Duroquet
Copyright (C) 2014-2016 Azael Avalos
Copyright (C) 2011-2012 Wolfram Sang, Pengutronix e.K.
Copyright (C) 2009-2010 Freescale Semiconductor, Inc. All Rights Reserved.
Copyright (C) 2018 Rockchip Electronics Co., Ltd. Alpha Lin <Alpha.Lin@rock-chips.com> Jeffy Chen <jeffy.chen@rock-chips.com>
Copyright 2018 Google LLC. Tomasz Figa <tfiga@chromium.org>
Copyright (C) 2010-2011 Samsung Electronics Co., Ltd.
Copyright (C) 2018 Rene Kjellerup <rk.katana.steel@gmail.com>
copyright (c) 2011-2012 Cypress Semiconductor, Inc.
copyright (c) 2011-2012 Google, Inc.
Copyright (C) 2003, 07 Ralf Baechle (ralf@linux-mips.org)
Copyright (C) 1998-2000 Andrzej Krzysztofowicz, Maintainer
Copyright (C) 1999-2000 CJ, cjtstai@ali.com.tw, Maintainer
Copyright (C) 1998-2000 Andre Hedrick (andre@linux-ide.org) May be copied or modified under the terms of the GNU General Public License
Copyright (C) 2002 Alan Cox ALi (now ULi M5228) support by Clear Zhang <Clear.Zhang@ali.com.tw>
Copyright (C) 2007 MontaVista Software, Inc. <source@mvista.com>
Copyright (C) 2007-2010 Bartlomiej Zolnierkiewicz
Copyright (C) 2001 PPC64 Team, IBM Corp
Copyright(C) 2006 Michael Ellerman, IBM Corp
Copyright (c) 2017 Oleg <balbes-150@yandex.ru>
Copyright (C) 2017 Zodiac Inflight Innovations
Copyright (c) 2011 Jon Smirl <jonsmirl@gmail.com>
Copyright (c) 2008, Swedish Institute of Computer Science. All rights reserved.
Copyright (C) 2018 Marek Vasut <marex@denx.de>
Copyright (C) 2000 Grant Grundler, Hewlett-Packard
Copyright (c) 2015 Collabora Ltd. Author: Sjoerd Simons <sjoerd.simons@collabora.co.uk>
Copyright (C) 2015 Lyude (Stephen Chandler Paul) <cpaul@redhat.com>
Copyright (C) 2008 Lineo Solutions, Inc.
Copyright (C) 2010 DSLab, Lanzhou University, China Author: Wu Zhangjin <wuzhangjin@gmail.com>
Copyright (C) 2005, 2008 Nokia Corporation
Copyright (C) 2014 Sebastian Reichel <sre@kernel.org>
Copyright (C) 2011 DENX Software Engineering GmbH Heiko Schocher <hs@denx.de>
Copyright (C) 2007 Semihalf Marian Balakowicz <m8@semihalf.com>
"COPYRIGHT(c) BUILD_BUG_ON(!()) "
Copyright (C) 2000, 2001 Ralf Baechle
Copyright (C) 2000, 2001 Silicon Graphics, Inc.

Copyright (C) 2000, 2001, 2003 Broadcom Corporation
"Copyright: (C) 2015 Linaro Ltd. "
Copyright (c) 2017, Open Grid Computing, Inc. */
Copyright (c) 2002 Red Hat, Inc. All rights reserved. fixes speed-ups (list handling fixes, issued_list, optimizations.) lots of cleanups.
Copyright (c) 2003 Christoph Hellwig <hch@lst.de> new-style, hotplug-aware pci probing and scsi registration
Copyright (C) Hitachi Ltd., 2012
Copyright (C) 2004 Sylvain Munaut <tnt@246tNt.com>
Copyright (C) 2002 Thibaut Varene <varenet@parisc-linux.org>
Copyright (C) 2000 John Marvin
Copyright (C) 2001 Matthew Wilcox
Copyright (C) 2014 Helge Deller <deller@gmx.de>
Copyright (C) 2004-2008 by Eric Van Hensbergen <ericvh@gmail.com>
Copyright (C) 2013 Obsidian Research Corp Jason Gunthorpe <jgunthorpe@obsidianresearch.com>
Copyright (C) 2002,2003 Adaptec, Inc. */
Copyright 1998-2001 by Leonard N. Zubkoff <lnz@dandelion.com>
Copyright 2002 by Mylex (An IBM Business Unit)
Copyright 2015 NextThing Co
Copyright (c) 2006 Dmitry Torokhov <dtor@mail.ru>
Copyright (C) 2004 Dominik Brodowski <linux@brodo.de>
Copyright (C) 2004 Anil S Keshavamurthy <anil.s.keshavamurthy@intel.com> Added processor hotplug support
Copyright (C) 2013, Intel Corporation Rafael J. Wysocki <rafael.j.wysocki@intel.com>
Copyright (c) 2004 Freescale Semiconductor, Inc.
Copyright(C) 2002-2006 Netfilter Core Team <coreteam@netfilter.org>
Copyright (c) 2011 Patrick McHardy <kaber@trash.net>
Copyright (C) 2001-2004 Peter Osterlund <petero2@telia.com>
Copyright (C) 2006 Thomas Maier <balagi@justmail.de>
Copyright(C) 2006 Thomas Maier <balagi@justmail.de>
Copyright (C) 2004 Microtronix Datacom Ltd.
Copyright (C) 2001 Vic Phillips
Copyright (C) 2008 Markus Plessing <plessing@ems-wuensche.com>
Copyright (C) 2008 Sebastian Haas <haas@ems-wuensche.com>
Copyright (C) 1997, 1998 Jakub Jelinek (jj@sunsite.mff.cuni.cz)
Copyright SUSE Linux Products GmbH 2009
Copyright (C) 2009 Sergey Tyurin <forum.free-x.de> Updated 2012 by Jannis Achstetter <jannis_achstetter@web.de>
Copyright (C) 2015 Jemma Denson <jdenson@gmail.com>
Copyright (C) 2019 Collabora Ltd.
Copyright (c) 2016, Linaro Limited
"Copyright 2006 Johannes Berg <johannes@sipsolutions.net> "
Copyright (c) 2004-2005, Intel Corporation
Copyright (c) 1997-1999 Doug Ledford
Copyright (c) 2002 Monta Vista Software, Inc.
Copyright (C) 2008 Pengutronix
Copyright (C) 1998, 2000 Free Software Foundation, Inc.
Copyright (C) 2001 Standard Microsystems Corporation Developed by Simple Network Magic Corporation
Copyright (C) 2003 Monta Vista Software, Inc. Unified SMC91x driver by Nicolas Pitre
Copyright (c) 2017 Jiri Pirkko <jiri@mellanox.com>
Copyright (C) 2003 - 2007 Paul Mundt
Copyright (C) 2004 Sean McGoogan
Copyright(C) 2004 NTT DATA Intellilink Co. http://www.intellilink.co.jp/
Copyright(C) YOKOTA Hiroshi <yokota (at) netlab. is. tsukuba. ac. jp>
Copyright(C) 2004 David Bronaugh <dbronaugh>
Copyright(C) 2006-2008 Harald Welte <laforge@gnumonks.org>
Copyright (C) 2002-2004 John Belmonte
Copyright 2012 Red Hat
Copyright(c) 2015-2017 Intel Deutschland GmbH

LICENCE TERMS (cont.)

Copyright (C) 2018-2019 Intel Corporation All rights reserved.
Copyright (C) 2010 Texas Instruments Author: Hemanth V <hemanthv@ti.com>
Copyright (C) 2003 - 2012 Paul Mundt
Copyright (c) 2005-2017 Mellanox Technologies. All rights reserved.
Copyright (c) 2005-7 The University of Waikato, Hamilton, New Zealand.
Copyright (c) 2005-7 Ian McDonald <ian.mcdonald@jandi.co.nz>
Copyright (c) 1997-1999 Carnegie Mellon University. All Rights Reserved.
Copyright 2008-2009 MontaVista Software, Inc.
Copyright (C) 2005 by David Brownell
Copyright (C) 2010 - 2014 Xilinx, Inc.
Copyright (C) 2001-2004 by Thomas Winischhofer, Vienna, Austria
"Copyright (c) 2002-2003 Patrick Mochel"
"Copyright (c) 2002-2003 Open Source Development Labs"
Copyright (c) 2010 Bruno Randolf <br1@einfach.org>
Copyright (C) 2009 by Jan Weitzel Phytex Messtechnik GmbH, armlinux@phytec.de>
Copyright (C) 2018 Nuvoton Technology Corp
Copyright (C) 2006 Felix Fietkau <nbd@openwrt.org>
Copyright (c) 2001-2007 Anton Altaparmakov
Copyright (c) 2000-2001 Vojtech Pavlik
Copyright (C) 1999 Hewlett-Packard Co
Copyright © 2014 Jussi Kivilinna <jussi.kivilinna@iki.fi>
Copyright (C) 2004 Greg Ungerer <gerg@uclinux.com>
Copyright 2005 Benjamin Herrenschmidt, IBM Corp.
Copyright(c) 2005 Benjamin Herrenschmidt, IBM Corp."
Copyright(c) 2008 Red Hat, Inc. All rights reserved.
Copyright(c) 2008 Mike Christie
Copyright (C) 2005-2008 Red Hat, Inc. All rights reserved.
Copyright (C) 2015-2017 I2SE GmbH <info@i2se.com>
Copyright (C) 2013 Sebastian Reichel <sre@kernel.org>
Copyright (C) 2001-2007 Miklos Szeredi. All rights reserved.
Copyright (C) 2012 NVIDIA CORPORATION. All rights reserved.
Copyright (C) 2012 Analog Device Inc.
Copyright (C) 2004 Justin Thiessen <jthiessen@penguincomputing.com>
copyright(C) 2010 Bartlomiej Zolnierkiewicz
Copyright (C) 1998-2000 Michel Aubry
Copyright (C) 1998-2000 Andrzej Krzysztofowicz
Copyright (C) 1998-2000 Andre Hedrick <andre@linux-ide.org>
copyright (c) 2001 Sun Microsystems
Copyright(C) 2010 Bartlomiej Zolnierkiewicz
Copyright (C) 2003 Luis R. Rodriguez <mcgrof@ruslug.rutgers.edu>
Copyright(C) 2006-2007, Timesys Corp., Thomas Gleixner
Copyright (C) 2004-2007 Hans Verkuil <hverkuil@xs4all.nl>
Copyright (C) 2001,2002 Frank Mori Hess <fmhess@users.sourceforge.net>
Copyright (C) 1997-8 David A. Schleef <ds@schleef.org>
Copyright (C) 1999 - 2002 Greg Kroah-Hartman (greg@kroah.com)
Copyright (C) 2002 M. R. Brown
Copyright (C) 2004-2007 Atmel Corporation
Copyright (C) 2002 Marius Gröger (mag@sysgo.de)
Copyright (c) 2001 Thomas Gleixner (gleixner@autonix.de)
Copyright (c) 2013-2016, The Linux Foundation. All rights reserved.
Copyright 2014-2015 Prodrive Technologies Andre van Herk <andre.van.herk@prodrive-technologies.com> Jerry Jacobs <jerry.jacobs@prodrive-technologies.com>
Copyright (C) 2014 Texas Instruments Incorporated Aurelien Jacquiot <a-jacquiot@ti.com>
Copyright (c) 2007 Intel Corporation
Copyright 2009 Red Hat, Inc. and/or its affiliates.
Copyright (C) 2011-2012 Google, Inc.
Copyright (C) 2000, Lineo (www.lineo.com)

Copyright (C) 2009 Nobuhiro Iwamatsu <iwamatsu.nobuhiro@renesas.com>
Copyright (C) 2009 Renesas Solutions, Inc. All rights reserved.
Copyright (C) 2007 Freescale Semiconductor, Inc. All rights reserved.
Copyright(c) container_of(c, struct shdma_chan, dma_chan) define to_shdma_dev(d) container_of(d, struct shdma_dev, dma_dev)
Copyright (C) 2004 IBM Corporation
Copyright (c) 2016 Ksenija Stanojevic <ksenija.stanojevic@gmail.com>
Copyright (C) 2007 MIPS Technologies, Inc.
Copyright 2000 VA Linux Systems, Inc., Fremont, California.
Copyright 2002 Tungsten Graphics, Inc., Cedar Park, Texas.
Copyright 2014 Advanced Micro Devices, Inc.
Copyright (C) 2013 Intel Corporation
Copyright (C) 2009 Integrated Device Technology, Inc.
Copyright (c) 2007,2008 Dmitry Baryshkov
Copyright (C) 2011 Richard Zhao, Linaro <richard.zhao@linaro.org>
Copyright (C) 1998-2000 Anton Blanchard (anton@samba.org)
Copyright (c) 2015 Azael Avalos <coproscefalo@gmail.com>
Copyright (c) 2008 PIKA Technologies Sean MacLennan <smaclennan@pikatech.com>
Copyright (c) 2008 Spansion Inc. Frank Edelhaeuser <frank.edelhaeuser@spansion.com> converted to "new style" I2C driver model, removed checkpatch.pl warnings)
Copyright 2006 Tower Technologies, Alessandro Zummo <a.zummo@towertech.it>
Copyright (C) Linus Torvalds <torvalds@linux-foundation.org>, 2015
Copyright (C) 2008 SuSE Linux Products GmbH Thomas Renninger <trenn@suse.de>
Copyright (c) 2008 Patrick McHardy <kaber@trash.net>
Copyright (C) 2012-2016 NVIDIA CORPORATION. All rights reserved.
Copyright (C) 2000, 2002 Maciej W. Rozycki
Copyright (C) 1990, 1999, 2000 Silicon Graphics, Inc. 2004 pf
Copyright 2010 MontaVista Software, LLC.
Copyright (C) 2007 Samuel Thibault.
Copyright (C) 2015-2016 Samsung Electronics Igor Kotrasinski <i.kotrasinsk@samsung.com>
Copyright (C) 2003-2005 Alan Stern
Copyright (C) 2011-2017 NVIDIA Corporation
Copyright (C) 2011-2012 Red Hat, Inc., Peter Zijlstra
Copyright IBM Corporation, 2009
Copyright 2006 Stephane Marchesin
Copyright (C) 2004 - 2008 Paul Mundt
Copyright 2012 Maxime Ripard <maxime.ripard@free-electrons.com>
Copyright 2013 Hans de Goede <hdegoede@redhat.com>
Copyright (C) 2004 Intel Corporation.
Copyright (C) 2000 Sam Creasey <sammy@sammy.net>
Copyright (C) 2001 Richard Hirst <rhirst@parisc-linux.org>
Copyright (C) 2003 James Bottomley <jejb@parisc-linux.org>
Copyright (C) 2002 Hewlett-Packard Development Group, L.P. Author: Torben Mathiasen <torben.mathiasen@hp.com>
Copyright 2019 Collabora Ltd. */
Copyright (C) 2006 Qumranet
Copyright (C) 2007 - 2012 Jean Delvare <khali@linux-fr.org>
Copyright (C) 2010 Intel Corporation David Woodhouse <dwmw2@infradead.org>
Copyright (C) 2014-2018 Daktronics Matt Sickler <matt.sickler@daktronics.com>, Jordon Hofer <jordon.hofer@daktronics.com>
Copyright (c) 2011 Google, Inc. Author: Colin Cross <ccross@android.com> Gary King <gking@nvidia.com>
Copyright 2005-2007 Freescale Semiconductor, Inc. All Rights Reserved.
Copyright (c) 2005 Luben Tuikov <luben_tuikov@adaptec.com>
Copyright (c) 2002-2007 Volkswagen Group Electronic Research All rights reserved.
Copyright (C) 1997 Jakub Jelinek (jj@sunsite.mff.cuni.cz)
Copyright (C) 2006 Polycom, Inc.
Copyright (C) 2008 TurboSight.com, <bob@turbosight.com>

LICENCE TERMS (cont.)

Copyright (C) 2008 Igor M. Liplianin <liiplianin@me.by> Removed stb6000 specific tuner code and revised some procedures.

Copyright (c) Ahmet Ç-nan <ainan at matematik.uni-freiburg.de>

Copyright (c) Jaroslav Kysela <perex@perex.cz>

Copyright (C) 2012 Samsung Electronics Chiwoong Byun <woong.byun@samsung.com> Jonghwa Lee <jonghwa3.lee@samsung.com>

Copyright (C) 1997 Jim Paradis

Copyright (c) 2009 Janine Kropp <nin@directfb.org>

Copyright (c) 2009 Denis Oliver Kropp <dok@directfb.org>

Copyright (c) 2009 Gábor Stefanik <netrolller.3d@gmail.com>

Copyright (C) 2002-2004 Dave Jones

Copyright (C) 2014 Hans Verkuil <hverkuil@xs4all.nl>

Copyright 2003 Benjamin Herrenschmidt

Copyright (C) 1995-1998 Mark Lord

Copyright (C) 2007-2009 Bartłomiej Zolnierkiewicz

Copyright 2003 (c) MontaVista, Software, Inc.

Copyright 2017 - 2018 NXP

Copyright 1996 Eddie C. Dost (ecd@skynet.be)

Copyright 2001 Anton Blanchard (anton@samba.org)

Copyright (C) 2006 Arcom Control Systems Ltd.)

Copyright (C) 2010, Novell, Inc. Author : K. Y. Srinivasan <ksrinivasan@novell.com>

Copyright (C) 2008 Openmoko, Inc.

Copyright (C) 2004-2008 Simtec Electronics Ben Dooks <ben@simtec.co.uk> <http://armlinux.simtec.co.uk/>

Copyright (C) 2016 Nicolae Rosia <nicolae.rosia@gmail.com>

Copyright 2003 PathScale, Inc. Derived from include/asm-i386/pgtable.h

Copyright (C) 1994, 1995, 1996 Paul M. Antoine.

Copyright (C) 2003-2006, Marvell International Ltd.

Copyright (C) 2001 Dustin McIntire

Copyright (C) 2001 Paul Mackerras <paulus@au.ibm.com>, IBM

Copyright (C) 2004 Benjamin Herrenschmidt <benh@kernel.crashing.org>, IBM Corp.

Copyright (C) 2007 Freescale Semiconductor, Inc. All rights reserved.

Copyright (c) 2007 Dmitry Baryshkov

Copyright 2012 Red Hat Inc. Parts based on xf86-video-ast

Copyright (c) 2005 ASPEED Technology Inc. Authors: Dave Airlie <airlied@redhat.com> Michael Thayer <michael.thayer@oracle.com>, Hans de Goede <hdegoede@redhat.com>

Copyright (C) 2008 Paul Mundt <lethal@linux-sh.org>

Copyright(C) 1995 Miguel de Icaza

Copyright(C) 1997 Jakub Jelinek

Copyright 2008 Freescale Semiconductor Inc.

Copyright (c) 2005 MontaVista Software

Copyright (c) 2013 Scott Feldman <sfeldma@cumulusnetworks.com>

Copyright (C) 2011 Magnus Damm

Copyright (C) 2009 Paulius Zaleckas <paulius.zaleckas@teltonika.lt>

Copyright 2012 Calxeda, Inc.

Copyright 1995 by the Massachusetts Institute of Technology. All Rights Reserved.

Copyright (C) 2005-2007 Derek Smithies <derek@indranet.co.nz> Sponsored by Indranet Technologies Ltd

Copyright (c) 2005 John Bicket All rights reserved.

copyright notice, this list of conditions and the following disclaimer, without modification. 2. Redistributions in binary form must reproduce at minimum a disclaimer similar to the "NO WARRANTY" disclaimer below ("Disclaimer and any redistribution must be cond

Copyright (C) 2015 Renesas Solutions Corp.

Copyright (C) 2015-2017 Cogent Embedded, Inc. <source@cogentembedded.com>

Copyright (C) 1992, 1993, 1994, 1995 Remy Card (card@masi.ibp.fr) Laboratoire MASI - Institut Blaise Pascal

Universite Pierre et Marie Curie (Paris VI)

Copyright (c) 2008 Herbert Xu <herbert@gondor.apana.org.au>

Copyright (C) 2010 ST-Ericsson SA

Copyright(c) 2005 Dirk Opfer

Copyright(c) 2005 Ian Molton <spyro@f2s.com>

Copyright(c) 2007 Dmitry Baryshkov

Copyright (C) 2009 Paul Mundt

Copyright (C) 2002 Richard Russon

Copyright (C) 1997 - 2002 Ralf Baechle (ralf@gnu.org)

Copyright (C) 2004 Ralf Baechle (ralf@linux-mips.org)

Copyright (C) 1994 - 2006 Ralf Baechle

Copyright (C) 2003, 2004 Maciej W. Rozycki

Copyright (C) 2001, 2004, 2011, 2012 MIPS Technologies, Inc.

Copyright (c) 2008 QUALCOMM Incorporated.

Copyright (c) 2008 QUALCOMM USA, INC.

Copyright (c) 2004 Topspin Communications. All rights reserved.

copyrighted 1=Stream is copyrighted

Copyright (c) 2011-2012 Qualcomm Atheros, Inc.

Copyright (C) 2008 Yoshihiro Shimoda

copyright(c) 2009, 2010 Nvidia Graphics Pvt. Ltd.

Copyright 2007 Wolfson Microelectronics PLC. Author: Graeme Gregory graeme.gregory@wolfsonmicro.com or linux@wolfsonmicro.com

Copyright(c) 2009, 2010 Nvidia Graphics Pvt. Ltd.

Copyright (C) 2004 convergence GmbH

Copyright (c) 2012, Michal Simek <monstr@monstr.eu>

Copyright (c) 2012, PetaLogix

Copyright (c) 2011, Texas Instruments, Inc.

Copyright (C) 2012-2016 by the following authors: Wladimir J. van der Laan <laanwj@gmail.com> Christian Gmeiner <christian.gmeiner@gmail.com> Lucas Stach <l.stach@pengutronix.de> Russell King <rmk@arm.linux.org.uk>

Copyright (C) 2011 - 2014 Intel Corporation. All rights reserved.

Copyright (C) 1998, 1999 Free Software Foundation, Inc.

Copyright (C) 2006 Steven Toth <stoth@linuxtv.org> Functions: mxl5005s_reset() mxl5005s_writereg() mxl5005s_writeregs() mxl5005s_init() mxl5005s_reconfigure() mxl5005s_AssignTunerMode() mxl5005s_set_params() mxl5005s_get_frequency() mxl5005s_get_bandwidth() mxl5005s_release() mxl500

Copyright (C) 2008 Realtek

Copyright (C) 2008 Jan Hoogenraad Functions: mxl5005s_SetRfFreqHz()

Copyright (C) 2008 Jan Hoogenraad This code is placed under the terms of the GNU General Public License

Copyright (C) 2008 MaxLinear

Copyright (C) 2008 Steven Toth <stoth@linuxtv.org>

Copyright 2009-2012 Canonical Ltd.

Copyright (C) 2014 Michael Hope (adapted for the TLS8204)

Copyright 2007 Jon Loeliger

"Copyright: [copy] 2008 Scott Shawcroft (scott.shawcroft@gmail.com)"

"Copyright: [copy] 2001-2004 Greg Kroah-Hartman (greg@kroah.com)"

Copyright: [copy] 2005 Johannes Berg (johannes@sipsolutions.net)

Copyright: [copy] 2005 Stelian Pop (stelian@popies.net)

Copyright: [copy] 2005 Frank Arnold (frank@sciocco-5v-turbo.de)

Copyright: [copy] 2005 Peter Osterlund (petero2@telia.com)

Copyright: [copy] 2005 Michael Hanselmann (linux-kernel@hansmi.ch)

Copyright: [copy] 2006 Nicolas Boichat (nicolas@boichat.ch)

Copyright (c) 2010 Voltaire Inc. All rights reserved.

Copyright (C) 2007-2008 Bartłomiej Zolnierkiewicz

Copyright 2001 by Intel Corp.

Copyright (c) 2016 David Herrmann

Copyright 2015 Maxime Ripard Maxime Ripard <maxime.ripar@free-electrons.com>

Copyright (C) 2013 Richard Weinberger <richrd@nod.at>

Copyright (c) 2017 Andrew Lunn <andrew@lunn.ch>

Copyright (c) 2015-2016 Hisilicon Limited.

"Copyright (C) 2002 Gary Brubaker (xavyer@ix.netcom.com)"

"Copyright (C) 2010 Johan Hovold (jhovold@gmail.com) "

Copyright (C) 2010 Nokia Corporation Tony Lindgren <tony@atomide.com> Santosh Shilimkar <santosh.shilimkar@

LICENCE TERMS (cont.)

ti.com>
Copyright (C) 2008 Sujith Thomas <sujith.thomas@intel.com>
Copyright (C) 2013 Texas Instruments
Copyright 1999 The Puffin Group, (Alex deVries, David Kennedy)
Copyright 2003 Grant Grundler <grundler@parisc-linux.org>
Copyright 2003,2004 Ryan Bradetich <rbrad@parisc-linux.org>
Copyright 2004,2006 Thibaut VARENE <varenet@parisc-linux.org>
Copyright (c) Cryptoapi developers.
Copyright (c) 2002 David S. Miller (davem@redhat.com)
Copyright (c) 2002 James Morris <jmorris@intercode.com.au>
Copyright (C) 1998 David A. Schleeff <ds@schleeff.org> http://www.comedi.org/
Copyright (C) 2016 Intel
Copyright (C) 2009 Gabor Juhos <juhosg@openwrt.org>
Copyright (C) 2009 Marc Kleine-Budde, Pengutronix
Copyright (C) 2011 Meprolight, Ltd. Alex Gershgorin <alexg@meprolight.com>
Copyright (C) 2019 Purism SPC
Copyright (c) 2007, 2011 Freescale Semiconductor, Inc.
Copyright 2011 Denis 'GNUtoo' Carikli <GNUtoo@no-log.org>
Copyright (C) 2004-2007 John Williams <john.williams@petalogix.com>
Copyright (C) 2002,03 NEC Electronics Corporation
Copyright (C) 2002,03 Miles Bader <miles@gnu.org>
Copyright (C) 1992 Ross Biro
Copyright (C) Linus Torvalds
Copyright (C) 1994, 95, 96, 97, 98, 2000 Ralf Baechle
Copyright (C) 1996 David S. Miller Kevin D. Kissell, kevink@mips.com and Carsten Langgaard, carstenl@mips.com
Copyright (C) 1999 MIPS Technologies, Inc.
Copyright (c) 2011 H Hartley Sweeten <hsweeten@visionengravers.com>
Copyright IBM Corp. 2007,2008 Author(s): Christian Borntraeger <borntraeger@de.ibm.com>
Copyright (C) 2013 Corentin LABBE <clabbe.montjoie@gmail.com>
Copyright (C) 2009 Wing Linux
Copyright (C) linwizard.sourceforge.net Author: Angelo Arrifano <miknix@gmail.com> Based on lcd_h4 by Imre Deak <imre.deak@nokia.com>
Copyright : Ian Molton <spyro@f2s.com> Andrew Zabolotny <zap@homelink.ru>
Copyright (c) 2009 MontaVista Software, Inc.
Copyright (c) 2010 Pengutronix e.K. Author: Wolfram Sang <w.sang@pengutronix.de>
Copyright 2019 Linaro, Ltd., Rob Herring <robh@kernel.org> */ #ifndef __PANFROST_ISSUES_H__ #define __PANFROST_ISSUES_H__
Copyright (C) 1995, 1996 Russell King.
Copyright (C) 2008-2009 Nokia Corporation
Copyright(c) 2003 - 2004 Intel Corporation.
Copyright (C) 1995 Adrian M. Rodriguez (adrian@remus.rutgers.edu)
Copyright (C) 2004 Texas Instruments
Copyright (C) 2004-2007 Silicon Graphics, Inc.
Copyright (C) 2006 Google, Inc
Copyright (c) 2001-3 Patrick Mochel
Copyright (c) 2008 Dave Chinner All Rights Reserved.
Copyright (C) 2003-2006 Hyok S. Choi
Copyright (c) 2017, Xilinx Inc
Copyright (C) 2018 Amarula Solutions B.V. Author: Jagan Teki <jagan@amarulasolutions.com>
Copyright (C) 2007-2011 Hans de Goede <hdegoede@redhat.com> *
Copyright (C) 2008 Peter Gruber <nokos@gmx.net>
Copyright (C) 2008 Tony Vroon <tony@linx.net> Based on earlier work:
Copyright (C) 2003 Shane Spencer <shane@bogomip.com> Adrian Yee <brewt-fujitsu@brewt.org>
Copyright (C) 2010 Nuno Goncalves <nunojpg@gmail.com>
Copyright (C) 2007 Yoichi Yuasa <yoichi_yuasa@tripeaks.co.jp>
Copyright 2005 Phil Blundell
Copyright (C) 2018 Chris Brandt
Copyright (C) 1996 by ACN S.A
"COPYRIGHT ""Copyright (c) 1999-2008 LSI Corporation""
Copyright (C) 2007 Red Hat, Inc., Peter Zijlstra
Copyright (c) 2006 Red Hat, Inc., Ingo Molnar
Copyright 2000,2004 (c) Grant Grundler <grundler()nahspam.parisc-linux.org>
Copyright 2003-2004 Simon Kelley.
copyright(C) David Hinds and the Linux wireless
copyright(C) Jean Tourrilhes.
Copyright 2003 Matthew T. Russotto
Copyright(C) David Hinds and the Linux wireless
Copyright(C) Jean Tourrilhes.
Copyright (C) 1999, 2000, 2001, 2002 - Karim Yaghmour (karim@opersys.com)
Copyright 2019 Pursim SPC
Copyright 2008 Stuart Bennett
Copyright (C) 2017 Martin Blumenstingl <martin.blumenstingl@googlemail.com>
Copyright (c) 2003 Eric Wong <eric@yhbt.net>
Copyright (C) 2005-2007 Richard Purdie <rpurdie@openedhand.com>
Copyright © 2004 Thomas Gleixner <tglx@linutronix.de>
Copyright (C) 2001 Patrick Mochel <mochel@osdl.org>
Copyright (c) 2001-2007, Ericsson AB
Copyright (c) 2005-2008, 2011, Wind River Systems All rights reserved.
Copyright (C) 2002 - 2005 Benjamin Herrenschmidt <benh@kernel.crashing.org> and Markus Demleitner <msdemlei@cl.uni-heidelberg.de>
Copyright (C) 2015 Intel Corporation Author: Ramakrishna Pallala <ramakrishna.pallala@intel.com>
Copyright (c) 2006 Intel Corporation. All rights reserved.
Copyright (c) 2018 Amlogic, inc. Author: Qiufang Dai <qiuqiang.dai@amlogic.com> Author: Yixun Lan <yixun.lan@amlogic.com>
Copyright (c) 2004 Open Source Development Labs
Copyright (C) 2012 Intel Corp. All rights reserved.
Copyright (C) 2011-2012 Texas Instruments
Copyright (C) 2005 - 2008 Paul Mundt
Copyright (c) 2009-2010, Code Aurora Forum. All rights reserved.
Copyright © 2014 Intel Corporation Daniel Vetter <daniel.vetter@ffwll.ch>
Copyright (C) 2011-2012 Avionic Design GmbH
Copyright (C) 2001 Thiemo Seufer.
Copyright (C) 2002 Maciej W. Rozycki
Copyright (c) 2001 Matrox Graphics Inc.
Copyright (C) 2001 Russell King, and on early_printk.c by Andi Kleen.
Copyright (c) 2008, 2007, 2004-2005 Simtec Electronics http://armlinux.simtec.co.uk/ Ben Dooks <ben@simtec.co.uk>
Copyright (C) 1996,1997 Thomas K. Dyas (tdyas@eden.rutgers.edu)
Copyright (C) 2009 - 2012 Paul Mundt
Copyright 2013 Cisco Systems, Inc. and/or its affiliates.
copyright(C) Copyright 2001-2006 Alex Zeffertt, Cambridge Broadband Ltd, ajz@cambridgebroadband.com Re-worked by Ben Greear <greearb@candelatech.com>
Copyright (c) 2009-2010 Intel Corporation
Copyright 2000 Grant Grundler (grundler@cup.hp.com)
Copyright © 2006-2008,2010 Intel Corporation Jesse Barnes <jesse.barnes@intel.com>
Copyright (c) 2016-2018 Broadcom Limited
Copyright (c) 2005 Simtec Electronics http://armlinux.simtec.co.uk/ Ben Dooks <ben@simtec.co.uk>
Copyright (c) 2009 H Hartley Sweeten <hsweeten@visionengravers.com>
Copyright (c) 2003 - 2006 Zultys Technologies
Copyright: (C) 2009, 2010 Julia Lawall, DIKU.
Copyright: (C) 2009, 2010 Gilles Muller, INRIA/LiP6. URL: http://coccinelle.lip6.fr/ Options:
Copyright (C) 1997 Geert Uytterhoeven
Copyright 2017 Manivannan Sadhasivam <manivannanece23@gmail.com>
Copyright (C) 2010 Thomas Chou <thomas@wytron.com.tw>

LICENCE TERMS (cont.)

Copyright (C) 2010 Cisco Systems Inc. <dediao@cisco.com>
copyright(C) 1999-2008 Helge Deller <deller@gmx.de>
Copyright (C) 2007 Sylvain Munaut <tnt@246tNt.com>
Copyright (C) 2003-2004 MontaVista, Software, Inc.
copyright 2001 Steven Whitehouse <steve@chygwyn.com>
Copyright (C) 2003 Agilent Technologies
Copyright (C) 1991,92,1995-99,2002,2004 Free Software Foundation, Inc. This file is part of the GNU C Library.
Copyright (C) 2000 Anton Blanchard (anton@linuxcare.com.au)
Copyright (C) 2007 Kyle McMartin (kyle@parisc-linux.org)
Copyright (C) 2000 Philipp Rumpf <prumpf@tux.org>.
Copyright 2008, 2009 Wolfson Microelectronics PLC. Author: Mark Brown <broonie@opensource.wolfsonmicro.com>
Copyright (C) 2008 Nokia Corporation Mikko Ylinoen <mikko.k.ylinoen@nokia.com>
Copyright (C) 2000 Stephane Eranian <eranian@hpl.hp.com>
copyright (C) 2003 Intel Corporation.
Copyright (C) 2005 Stephen Rothwell, IBM Corporation
Copyright (c) 2011-2013 MiraMEMS Sensing Technology Co., Ltd.
Copyright (c) 2015 Shrijeet Mukherjee <shm@cumulusnetworks.com>
Copyright (c) 2015 David Ahern <dsa@cumulusnetworks.com>
Copyright (C) 2003 Richard.Curnow@superh.com
Copyright 2008 Wolfson Microelectronics PLC.
Copyright (C) 2008 Juergen Beisert (kernel@pengutronix.de)
Copyright (C) 2008-2012 Renesas Solutions Corp.
Copyright (C) 2002-2006 Thibaut VARENE <varenet@parisc-linux.org>
Copyright © 2016 Collabora Ltd
Copyright (C) 2002 MontaVista Software Inc. Author: jsun@mvista.com or jsun@junsun.net
Copyright (C) 2014 Stefan Kristansson <stefan.kristansson@saunalahti.fi>
Copyright (C) ST-Ericsson SA 2008-2010 Author: Per Forlin <per.forlin@stericsson.com>
Copyright © 2005 Jan Harkes <jaharkes@cs.cmu.edu>
Copyright (c) 2008 Marvell Semiconductor
Copyright 2017 Noralf Trønnes
Copyright 2017 NXP
Copyright(c) 2003-2011 Intel Corporation
Copyright 2017 - Steven Rostedt, VMware, Inc.
Copyright (C) 2005 by Ivan Kokshaysky
Copyright (C) 2006 by SAN People
Copyright (C) 1999 Promise Technology, Inc.
Copyright (C) 1998 Andrea Arcangeli 1999-03-10 Improved NTP compatibility by Ulrich Windl 2002-05-31
Copyright (C) 2000, 2001, 2002 Ingo Molnar Designed by David S. Miller, Alexey Kuznetsov and Ingo Molnar
Copyright (c) 2013-2017 Samsung Electronics Co., Ltd. http://www.samsung.com
Copyright Dave Engebretsen & Todd Inglett 2001
Copyright Linas Vepstas 2005, 2006
Copyright (c) 2003 Erik Thyren <erth7411@student.uu.se>
Copyright (C) 2012 Red Hat, Inc. All rights reserved. Author: Alex Williamson <alex.williamson@redhat.com>
Copyright © 1999 Machine Vision Holdings, Inc.
Copyright © 1999 David Woodhouse <dwmw2@infradead.org>
Copyright (C) Red Hat, Inc., 2011 Author(s): Steve French (sfrench@us.ibm.com)
Copyright (c) 2003-2007 Network Appliance, Inc. All rights reserved.
Copyright (C) 2004, 06 Ralf Baechele <ralf@linux-mips.org>
Copyright(c) 2003-2011 Intel Corporation define DRV_AUTHOR "<ilw@linux.intel.com>"
Copyright (C) 2017 Hauke Mehrtens <hauke@hauke-m.de> Based on EP93xx wdt driver
Copyright (c) 2014 Johan Hovold <johan@kernel.org>
Copyright (C) 2004 IBM Inc.
Copyright (C) 2019 Linux Foundation <gregkh@linuxfoundation.org>
Copyright 2008, Freescale Semiconductor, Inc. All rights reserved.
Copyright 2011, Dmitry Eremin-Solenikov
Copyright (C) 2008 Jiri Hladky <hladky_dot_jiri_at_gmail_dot_com>
Copyright (C) 2013 Helge Deller <deller@gmx.de>
Copyright (C) 2002 David Howells <dhowells@redhat.com>
Copyright 2009 Simtec Electronics
Copyright 2009 Sascha Hauer, Pengutronix <s.hauer@pengutronix.de>
Copyright (C) 2005-2008 Auvitek International, Ltd.
copyright(c) 2003,2004 Joerg Albert <joerg.albert@gmx.de>
copyright(c) 2007 Guido Guenther <agx@sigxcpu.org>
Copyright (C) 2001, 2002 Ryan Holm <ryan.holm@qvident.com>
Copyright (c) 2014 Joachim Eastwood <manabian@gmail.com>
Copyright (c) 2012 NeilBrown <neilb@suse.de> Heavily based on earlier code which is:
Copyright (c) 2010 Grant Erickson <marathon96@gmail.com>
Copyright (C) 2002,2003 Suresh Siddha <suresh.b.siddha@intel.com>
Copyright (C) 2005,2006 Hongjiu Lu <hongjiu.lu@intel.com>
Copyright (C) 2002 Helge Deller <deller@gmx.de>
Copyright (C) 1991, 1992 Linus Torvalds 1995 Jay Estabrook
Copyright (C) 1995 Geert Uytterhoeven
Copyright (C) 1993 Bjoern Brauel Roman Hodek
Copyright (C) 1993 Hamish Macdonald Greg Harp
Copyright (C) 1994 David Carter [carter@compsci.bristol.ac.uk]
Copyright 2012 Steffen Trumtrar <s.trumtrar@pengutronix.de>, Pengutronix
Copyright (C) 2005 Ralf Baechele (ralf@linux-mips.org)
Copyright (C) 2009 Jiajie Chen (chenjiajie@cse.buaa.edu.cn)
Copyright (C) 2012 Huacai Chen (chenhc@lemote.com)
Copyright (c) 2013 Hauke Mehrtens <hauke@hauke-m.de>
"Copyright (C) 2005 Intel Corp Zou Nan hai <nanhai.zou@intel.com>"
Copyright (c) 2017, General Electric Company
Copyright (C) 1996,1998 Jakub Jelinek (jj@sunsite.mff.cuni.cz)
Copyright (C) 2001 Greg Banks <gnb@alphalink.com.au>
Copyright (C) 2001 Jan-Benedict Glaw <jbglaw@lug-owl.de>
Copyright (C) 2003 Geert Uytterhoeven <geert@linux-m68k.org>
Copyright (C) 1997, 1998 Ralf Baechele (ralf@gnu.org)
Copyright (C) 2013 Huawei Tech. Co., Ltd. Jiang Liu <jiang.liu@huawei.com>
Copyright (C) 1998-2000 Michel Aubry, Maintainer
Copyright (C) 2002 Alan Cox <alan@redhat.com> ALI (now ULI M5228) support by Clear Zhang <Clear.Zhang@ali.com.tw>
Copyright 2003 Andi Kleen, SuSE Labs.
Copyright (C) 2013 Simon Horman
Copyright (c) 2008 Jiri Slaby
Copyright 2018 Intel Corporation
Copyright (C) 2017, Intel Corporation Authors: Michael Jamet <michael.jamet@intel.com> Mika Westerberg <mika.westerberg@linux.intel.com>
Copyright (c) 2017-2018, Linaro Limited
Copyright (C) 2015 Collabora Ltd.
Copyright (C) 2014 Cogent Embedded, Inc.
Copyright (C) 2015-2016 Renesas Electronics Corporation
Copyright (C) 2001 Andrea Arcangeli <andrea@suse.de> SuSE
Copyright (c) 2014 Christoph Hellwig. All Rights Reserved.
Copyright (C) 1997-2000 Jakub Jelinek (jakub@redhat.com)
Copyright (C) 2012 Steven Toth <stoth@kernellabs.com>
Copyright (C) 2007 Hans Verkuijl
Copyright (C) 1997-2001 David Woodhouse
Copyright (C) 2001-2008 Stas Sergeev
Copyright (C) 2011 Kuninori Morimoto <kuninori.morimoto.gx@renesas.com>
Copyright 2014-2015, Qualcomm Atheros, Inc.
Copyright (C) 2013 Linaro Ltd <ard.biesheuvel@linaro.org>
Copyright (c) 2014 Red Hat Inc.
Copyright (C) 2004-2006 International Business Machines Corp. Author(s): Michael A. Halcrow <mahalcro@us.ibm.com>

LICENCE TERMS (cont.)

com>

Copyright (C) 2009, 2010 Imagination Technologies Ltd.
Copyright 2004 MontaVista Software, Inc.
Copyright (C) 2009 - 2011 Paul Mundt
copyright of original i386 version is:
Copyright (C) 2002 David Howells (dhowells@redhat.com) Incorporating suggestions made by Linus Torvalds and Dave Miller
Copyright (C) 2007 - 2009 Motorola, Inc.
Copyright 1993 United States Government as represented by the Director, National Security Agency.
Copyright (C) 2010 Markus Plessing <plessing@ems-wuensche.com> Rework for mainline by Oliver Hartkopp <socketcan@hartkopp.net>
Copyright 2010 (c) ST-Ericsson AB
Copyright (C) 1998-2000 InnoSys Incorporated. All Rights Reserved
Copyright (C) 2011 Dmitry Artamonov <mad_soft@inbox.ru>
Copyright (C) 2004 Hidetoshi Seto <seto.hidetoshi@jp.fujitsu.com>
Copyright (C) 1997, 1998, 1999, 2000 Ralf Baechle ralf@gnu.org Carsten Langgaard, carstenl@mips.com
Copyright (C) 2002 MIPS Technologies, Inc. All rights reserved.
Copyright (C) 2004-2009 Nokia Corporation
Copyright (C) 2007 by Latchesar Ionkov <luchio@ionkov.net>
Copyright (C) 2007 Pierre Ossman
copyright(C) Copyright Linus Torvalds 1999
copyright(C) Copyright Johannes Erdfelt 1999-2001
copyright(C) Copyright Andreas Gal 1999
copyright(C) Copyright Gregory P. Smith 1999
copyright(C) Copyright Deti Fliegl 1999 (new USB architecture)
copyright(C) Copyright Randy Dunlap 2000
copyright(C) Copyright David Brownell 2000-2004
copyright(C) Copyright Yggdrasil Computing, Inc. 2000 usb_device_id matching changes by Adam J. Richter)
copyright(C) Copyright Greg Kroah-Hartman 2002-2003
Copyright (C) 1992 Linus Torvalds Adapted from arch/i386 by Gary Thomas
Copyright (C) 1995-1996 Gary Thomas (gdt@linuxppc.org) Updated and modified by Cort Dougan <cort@fslmlabs.com>
Copyright (C) 1996-2001 Cort Dougan Adapted for Power Macintosh by Paul Mackerras
Copyright (C) 1996 Paul Mackerras (paulus@cs.anu.edu.au)
Copyright (c) 2007 - 2009, Christian Lamparter <chunkeey@web.de>
Copyright 2004-2006 Jean-Baptiste Note <jbnote@gmail.com>, et al.
Copyright (C) 2007 Conexant Systems, Inc.
Copyright (C) 2012 MIPS Technologies, Inc.
Copyright (C) 2012 Ralf Baechle <ralf@linux-mips.org>
Copyright (C) 2003,2004 Greg Kroah-Hartman <greg@kroah.com>
Copyright 2018 NXP
Copyright (C) 1999-2000 Andre Hedrick <andre@linux-ide.org>
Copyright (C) 2004, 2007 Bartlomiej Zolnierkiewicz
Copyright (C) 2012 Samsung Electronics MyungJoo Ham <myungjoo.ham@samsung.com>
Copyright (C) 2016 Renesas Electronics
Copyright 1997 Comtrol Corporation.
Copyright Theodore Ts'o, 1995-1997
Copyright (C) 2009 - 2010 Paul Mundt
Copyright (C) Red Hat, Inc., 2009, 2010, 2011
Copyright (C) Amit Shah <amit.shah@redhat.com>, 2009, 2010, 2011
Copyright (C) 2006 Thilo Cestonaro thilo.cestonaro.external@fujitsu-siemens.com>
Copyright (C) 2004, 2005 Stefan Ott <stefan@desire.ch>
Copyright (C) 2003, 2004 Reinhard Nissl <missl@gmx.de>
Copyright (c) 2001 Martin Knoblauch <mkn@teraport.de, knobi@knobisoft.de>
Copyright (C) 2000 Hermann Jung <hej@odn.de>
Copyright (C) 2002 Ralph Metzler <rjkm@metzlerbros.de>
Copyright (C) 2005 Nokia Corporation Written by Tony Lindgren <tony@atomide.com>

Copyright (C) 2001 Russell King
Copyright (C) 2007-2008 Texas Instruments, Inc. Updated to support OMAP3 Rajendra Nayak <rnayak@ti.com>
Copyright © 2015 Intel Corporation.
Copyright © 2016 Hewlett Packard Enterprise Development LP
Copyright (C) 2011 Jean-Christophe PLAGNIOL-VILLARD <plagnioj@jrcrosoft.com>
Copyright (c) 2014 Intel Corp. Author: Denis Turishev <denis@compulab.co.il>
Copyright (C) 1990, 1999, 2000 Silicon Graphics, Inc.
Copyright (c) 2005-2007 Michael Buesch <m@bues.ch>
Copyright (C) 2009 Lemote, Inc. Author: Wu Zhangjin, wuzhangjin@gmail.com
Copyright (C) 2011 Igalia, S.L. Author: Javier M. Mellid <jmunhoz@igalia.com>
Copyright (C) 1994 - 2000, 2006 Ralf Baechle
Copyright (C) 2016, Imagination Technologies Ltd.
Copyright(c) 2016-2017 Intel Deutschland GmbH
Copyright(c) 2013 - 2015 Intel Mobile Communications GmbH All rights reserved.
Copyright (C) 2009 Texas Instruments Incorporated. Nishanth Menon
Copyright (C) 2009 Nokia Corporation Paul Walmsley
Copyright (C) 2008 Thomas Bogendoerfer
Copyright (C) 2016 Lubomir Rintel
Copyright (C) 2005 Pavel Machek
Copyright 2012 Red Hat Inc. Authors: Dave Airlie <airlied@redhat.com>, Michael Thayer <michael.thayer@oracle.com, Hans de Goede <hdegoede@redhat.com>
Copyright (C) 2007 John Williams <john.williams@petalogix.com>
Copyright (C) 2015, Google, Inc.
Copyright 2011 Linaro Limited
Copyright (C) 1997 Jakub Jelinek (jj@sunsite.mff.cuni.cz)
Copyright © 2008 Intel Corporation
Copyright Red Hat, Inc. 2019
Copyright Red Hat 2003
Copyright (c) 2007-2008 MontaVista Software, Inc.
Copyright (C) 2003 Red Hat, Inc., James Morris <jmorris@redhat.com>
Copyright (C) 2003 Herbert Valerio Riedel <hvr@gnu.org>
Copyright (C) 2004, 2007-2010, 2011-2012 Synopsys, Inc. (www.synopsys.com)
Copyright (C) 2006, Mohan Kumar M, IBM Corporation
Copyright (C) 2013, Anton Blanchard, IBM Corporation
Copyright 2012 Denis 'GNUtoo' Carikli <GNUtoo@no-log.org>
Copyright (c) 2009 Wind River Systems, Inc. All Rights Reserved. 03/02/13 added new 2.5 kallsyms <xavier.bru@bull.net>
Copyright (C) 2019 Sunil Mohan Adapa <sunil@medhas.org>
Copyright (C) 2010-2012 Texas Instruments, Inc. Paul Walmsley Benoît Cousson
Copyright: |copy| 2010 Alan Stern <stern@rowland.harvard.edu>
Copyright: |copy| 2016 Intel Corporation
Copyright (C) 2002 Benedict Gaster
Copyright (C) 2003 Richard Curnow
Copyright 2014-2016 Linaro Ltd.
Copyright (c) 2015 Herbert Xu <herbert@gondor.apana.org.au>
Copyright (C) 2003 Paul Mundt <lethal@linux-sh.org>
Copyright (C) 2000 Kazumoto Kojima
Copyright (c) 2007 Eurotech S.p.A. <info@eurotech.it>
Copyright 2007-2008 MontaVista Software, Inc.
Copyright (C) 2010-2012 Stephane Grosjean <s.grosjean@peak-system.com>
Copyright (C) 2003 MontaVista Software, Inc.
Copyright (C) 2004-2006 Emulex. All rights reserved. * EMULEX and SLI are trademarks of Emulex. * www.broadcom.com *
Copyright (C) 2017-19 Renesas Electronics Corporation
Copyright (C) 2000 Silicon Graphics, Inc. Modified for further R[236]000 support by Paul M. Antoine, 1996. Kevin D. Kissell, kevink@mips.com and Carsten Langgaard, carstenl@mips.com
Copyright (C) 2000, 07 MIPS Technologies, Inc.

LICENCE TERMS (cont.)

Copyright (C) 2003, 2004 Maciej W. Rozycki
Copyright (c) 2016-2017 Broadcom Limited
Copyright (C) 1995, 1999, 2000, 2001 by Silicon Graphics, Inc.
Copyright (C) 2006-2007 Corentin Chary
Copyright (C) 2011 Wind River Systems
Copyright (c) 2016-2019 Broadcom Limited
copyright(C) 2003 Ardis Technologies <roman@ardistech.com>
copyright 1986, 1989, 1990 by Abacus Research and Development, Inc.
Copyright (C) 2003,2004 John Williams <jwilliams@itee.uq.edu.au>
Copyright (C) 2001 NEC Corporation
Copyright (C) 2001 Miles Bader <miles@gnu.org>
Copyright (C) 1999,2000 Niibe Yutaka & Kaz Kojima
Copyright (C) 1991,1992 Linus Torvalds
Copyright (C) 2006-2012 Nobuhiro Iwamatsu
Copyright (C) 2008-2014 Renesas Solutions Corp.
Copyright (C) 2013-2017 Cogent Embedded, Inc.
Copyright (C) 2014 Codethink Limited
Copyright (c) 2007 Nokia Siemens Networks
Copyright (C) 2001 SGI - Silicon Graphics, Inc <linux-xfs@oss.sgi.com>
Copyright (c) 2006 - 2012 QLogic Corporation. * All rights reserved.
Copyright Red Hat, Inc. 2011
Copyright (C) Russell King.
Copyright (C) 1997, 2001 by Geert Uytterhoeven and others
Copyright (C) 2006-2008 Intel Corporation Author: Ashok Raj <ashok.raj@intel.com> Author: Shaohua Li <shaohua.li@intel.com> Author: Anil S Keshavamurthy <anil.s.keshavamurthy@intel.com>
Copyright (c) 2002-2005, Jouni Malinen <j@w1.fi>
Copyright (c) 2010, Vladimir Fonov
Copyright (c) by Pavel Hofman <pavel.hofman@ivitera.com>,
Copyright (C) 2017-2018 Red Hat, Inc. All rights reserved.
Copyright (c) 2002 by Takashi Iwai <tiwai@suse.de>
Copyright (C) 2015, 2016 Roger Shimizu <rogershimizu@gmail.com>
Copyright 2006 (c) MontaVista Software, Inc.
Copyright (C) ITE Tech Inc.
Copyright (C) 1999,2000 Anton Blanchard (anton@samba.org)
Copyright (C) 2013 Intel Corporation. All rights reserved.
Copyright(c) 1999 Steve Ratcliffe <steve@parabola.demon.co.uk>
Copyright (C) 1999-2000 Takashi Iwai <tiwai@suse.de>
Copyright (c) 2006-2009 Nick Kossifidis <mickflemm@gmail.com>
Copyright (C) 2007 Greg Kroah-Hartman <gregkh@suse.de>
Copyright (C) 2013 Cavium, Inc. Authors: Sanjay Lal <sanjayl@kymasys.com>
Copyright (C) 2007 Yoshihiro Shimoda
Copyright (C) 2008, 2009 Nobuhiro Iwamatsu
Copyright (C) 1992, 1993, 1994, 1995, 1996, 1997, 1998, 1999 Theodore Ts'o
Copyright 2014 - 2015 Freescale Semiconductor Inc.
Copyright (C) 2004,2005 Milton D Miller II, IBM Corporation
Copyright (c) 2014 The Linux Foundation
Copyright (C) 2005 Olav Kongas <ok@artecdesign.ee>
Copyright (C) 2009-2012 TurboSight.com
Copyright (c) 2014 Takashi Sakamoto"
Copyright (c) 2003 Michal Sojka, for high-speed iso transfers
Copyright (C) 2007 Ralf Baechle (ralf@linux-mips.org)
Copyright (C) 1993 Bruno Haible
Copyright (C) 1997, 1998 Krzysztof G. Baranowski
Copyright (c) 2015 Samsung Electronics Co., Ltd. http://www.samsung.com
Copyright 2003-2006 Jeff Garzik
Copyright (c) 2016 Mentor Graphics Inc.
Copyright (C) 1997 Geert Uytterhoeven
Copyright (C) 1999,2000 Martin Lucina, Tom Zerucha
Copyright (C) 2002 Richard Henderson
Copyright (C) 2006, 2007 Maciej W. Rozycki
Copyright (C) 2008 Wind River Systems, Inc. updated by Tiejun Chen <teijun.chen@windriver.com>
Copyright (c) 1999-2000 Takashi Iwai <tiwai@suse.de>
Copyright (c) 2005 Jim Cromie <jim.cromie@gmail.com>
Copyright (c) 2017-2018, Ericsson AB All rights reserved.
Copyright (c) 2012-2013 Google (c)
Copyright (c) 2013-2014 Red Hat Inc.
Copyright (c) 2010, 2012-2013, NVIDIA Corporation. All rights reserved.
Copyright Digital Equipment Corporation 1996.
Copyright (C) 2001 Frank Mori Hess <fmhess@users.sourceforge.net>
Copyright (c) 2013 Florian Fainelli <florian@openwrt.org>
Copyright (C) 2017 Linus Walleij
Copyright (C) 2006 by Thiemo Seufer
Copyright (C) 2003 Anton Blanchard <anton@au.ibm.com>, IBM
Copyright (C) 2012 Atmel, 2012 Nicolas Ferre <nicolas.ferre@atmel.com>
Copyright (C) 1999 Silicon Graphics Kevin D. Kissell, kevink@mips.org and Carsten Langgaard, carstenl@mips.com
"Copyright 2007-2010 Johannes Berg <johannes@sipsolutions.net>"
Copyright (C) 2002 Ken Chen <kenneth.w.chen@intel.com>
Copyright (C) 2015 Martin Blumenstingl <martin.blumenstingl@googlemail.com>
Copyright (C) 2017 Hauke Mehrtens <hauke@hauke-m.de>
Copyright © 2009 IBM Corporation
Copyright (c) 2007-2014 Intel Corporation."
Copyright 2018 Google LLC. */
Copyright (c) 2016 Linaro Ltd.
Copyright (C) 2001 - 2008 Jeff Dike (jdike@{addtoit,linux.intel}.com)
Copyright (C) 2018-2019 Renesas Electronics Corp.
Copyright (C) 2006 Red Hat GmbH
Copyright (C) 2003 - 2007 Jeff Dike (jdike@{addtoit,linux.intel}.com)
Copyright (C) 2010-2011 - NVIDIA, Inc.
Copyright 2008 Freescale Semiconductor Inc. Port to powerpc added by Kumar Gala
Copyright 2011 Michal Simek <monstr@monstr.eu>
Copyright 2011 PetaLogix Qld Pty Ltd Port to Microblaze
Copyright (C) 2014 Zi Shen Lim <zlim.lnx@gmail.com>
Copyright (C) 2002, 2003, 2004 Maciej W. Rozycki
Copyright (C) 2008, 2009 Elina Pasheva, Matthew Safar, Rory Filer linux@sierrawireless.com>
Copyright (C) 2006, Timesys Corp., Thomas Gleixner <tglx@timesys.com>
Copyright(c) 2015 - 2016 Intel Deutschland GmbH
Copyright(c) 2012 - 2014, 2019 Intel Corporation. All rights reserved.
Copyright(c) 2015 - 2016 Intel Deutschland GmbH All rights reserved.
Copyright 2012 Benjamin Herrenschmidt, IBM Corporation.
Copyright 2012 Red Hat Inc. Authors: Dave Airlie <airlied@redhat.com> Michael Thayer <michael.thayer@oracle.com>
Copyright (C) 2008-2009 Red Hat, Inc.
Copyright (C) 2015 Red Hat, Inc.
Copyright (C) 2009 Lemote, Inc. Author: Yan hua (yanhua@lemote.com) Author: Wu Zhangjin (wuzhangjin@gmail.com)
Copyright 2013 Red Hat Inc. Authors: Dave Airlie Alon Levy Michael Thayer <michael.thayer@oracle.com, Hans de Goede <hdegoede@redhat.com>
Copyright (C) 2009 Samsung Electronics Author: Michal Nazarewicz <mina86@mina86.com> All rights reserved.
Copyright (c) 2004-2009 Greg Kroah-Hartman <gregkh@suse.de>
Copyright (c) 2008-2009 Novell Inc.
Copyright (C) 2011, Texas Instruments, Incorporated - http://www.ti.com/
Copyright (C) 2007 Carlos Munoz <carlos@kenati.com>
Copyright 2006-2009 Wolfson Microelectronics PLC. Based on wm8974 and wm8990 by Liam Girdwood <lrg@slimlogic.co.uk>

LICENCE TERMS (cont.)

Copyright (C) 2013, Intel Corporation
Copyright (c) 1997, 1998 Erik Andersen <andersee@debian.org>
Copyright (c) 1998, 1999 Jens Axboe <axboe@image.dk>
Copyright (c) 2018 LSI-TEC - Caninos Loucos
Copyright (C) 2003 Herbert Valerio Riedel <hvr@gnu.org>
Copyright (C) Mike Christie, 2004 - 2006
Copyright (C) 2004 Thiemo Seufer
Copyright (C) 2014-2015 Lucas Stach <dev@lynxeye.de>
Copyright (C) 2012 Avionic Design GmbH
Copyright 2009-2010 Pengutronix Uwe Kleine-Koenig <u.kleine-koenig@pengutronix.de>
Copyright IBM Corp. 2008
Copyright (C) 2005, 06 Ralf Baechle (ralf@linux-mips.org)
Copyright (C) 2015
Copyright (C) 2011 Texas Instruments, Inc.
Copyright (c) 2019, Linaro Ltd.
Copyright (c) <2017> Linaro Ltd. <http://www.linaro.org>
Copyright (c) 2009 HNR Consulting. All rights reserved.
Copyright (C) 2006 Frank Mori Hess <fmhess@users.sourceforge.net>
Copyright (C) 1999,2002,2003 David A. Schleeff <ds@schleeff.org>
Copyright 2010 OKI Semiconductors Ltd.
Copyright 2011 Wind River Systems, Inc.
Copyright (C) 2014 Red Hat, Inc.
Copyright (C) 2015 Arrikto, Inc.
Copyright (C) 2017 Chinamobile, Inc.
Copyright 2004 Pavel Machek <pavel@ucw.cz>
Copyright 2006 Bob Copeland <me@bobcopeland.com>
Copyright (C) 1999 SuSE GmbH Nuernberg
Copyright (C) 2000 Hewlett-Packard (John Marvin)
Copyright (C) 1999 Hewlett-Packard (Frank Rowand)
Copyright (C) 2012 Magnus Damm
Copyright (c) 2006-2009 Nick Kossifidis <mickflemm@gmail.com>
Copyright (c) 2007-2008 Jiri Slaby <jirislab@yandex.ru>
Copyright (c) 2008-2009 Felix Fietkau <nbd@openwrt.org>
Copyright (C) 2016 Linaro Ltd Author: Sumit Semwal <sumit.semwal@linaro.org>
Copyright (C) 2015 Richard Weinberger (richard@nod.at)
Copyright (C) 2003-2009 Jean Delvare <jdelvare@suse.de>
Copyright (C) 2004 - 2007 Jeff Dike (jdike@{addtoit,linux.intel}.com) Licensed under the GPL
Copyright © 2011 Intel Corporation
Copyright (C) 2009, Wind River Systems Inc Implemented by fredrik.markstrom@gmail.com and ivarholmqvist@gmail.com
Copyright 2010 Tlera Corporation. All Rights Reserved.
Copyright 2015 Regents of the University of California, Berkeley
Copyright (c) 2018 Netronome Systems, Inc. */
Copyright (C) 2008 Pylone, Inc. By: Masashi YOKOTA <yokota@pylone.jp> Originally found here: http://downloads.pylone.jp/src/virtual_battery/virtual_battery-0.0.1.tar.bz2
Copyright (C) 2009 Anders Blomdell (anders.blomdell@control.lth.se)
Copyright (C) 2008 Thomas Champagne (lafeuil@gmail.com)
Copyright (C) 1999, 2000 by Ralf Baechle
Copyright (c) 2009 VMware, Inc., Palo Alto, CA., USA,
copyright(c) 2004 Gerd Knorr <kraxel@bytesex.org>
copyright(c) 2008 Steven Toth <stoth@linuxtv.org> CX23885/7/8 support
COPYRIGHT(c) 2004 Gerd Knorr <kraxel@bytesex.org>
COPYRIGHT(c) 2008 Steven Toth <stoth@linuxtv.org> CX23885/7/8 support
"Copyright 2000 Ani Joshi <ajoshi@kernel.crashing.org>"
Copyright 2000 ATI Technologies Inc., Markham, Ontario, and VA Linux Systems Inc., Fremont, California.
Copyright (C) 2015-2016 Cogent Embedded, Inc. <source@cogentembedded.com>
Copyright (c) 2014 sigma star gmbh Author: Richard Weinberger <richard@nod.at>

Copyright (C) 2009 Siemens AG Written by: Dmitry Eremin-Solenikov <dmitry.baryshkov@siemens.com>
Copyright (c) 2011 Richard Sharpe <realrichardsharpe@gmail.com>
Copyright (c) 2011 Stefan Schmidt <stefan@datenfreihafen.org>
Copyright (c) 2011 Werner Almesberger <werner@almesberger.net>
Copyright (c) 2013 Alexander Aring <alex.aring@gmail.com>
Copyright (c) 2017 Josef Filzmaier <j.filzmaier@gmx.at>
Copyright (C) 2004-2007 Texas Instruments, Inc.
Copyright (C) 2010 Texas Instruments Incorporated - <http://www.ti.com/> Converted DMA library into platform driver
G, Manjunath Kondaiah <manjugk@ti.com>
Copyright (c) 1999-2002 Matthew Dharm (mdharm-usb@one-eyed-alien.net)
Copyright (c) 1999 Michael Gee (michael@linuxspecific.com)
Copyright (C) 2009 Texas Instruments Added OMAP4 support - Santosh Shilimkar <santosh.shilimkar@ti.com>
Copyright (C) 2007-2009 Andres Salomon <dilinger@collabora.co.uk>
Copyright (C) 2012 National Instruments
Copyright (C) 2010 Secret Lab Technologies, Ltd.
Copyright (C) 2009 - 2011 David Härdeman <david@hardeman.nu>
Copyright (C) 2003 Ralph Metzler <rjkm@metzlerbros.de>
Copyright (c) 2003 Dimitromanolakis Apostolos <apostol@cs.utoronto.ca>
Copyright (C) 1998 Ingo Molnar.
Copyright (C) 2009 Jeremy Kerr <jeremy.kerr@canonical.com>
Copyright (C) 2004 ARM Limited
Copyright Matthew Wilcox for Intel Corp, 2010
Copyright Sarah Sharp for Intel Corp, 2010
Copyright (C) 2015 Regents of the University of California
Copyright (C) 2012, Analog Device Inc. Author: Lars-Peter Clausen <lars@metafoo.de>
Copyright (C) 2015, Intel Corporation
Copyright (c) 2013, NVIDIA Corporation. All rights reserved.
Copyright (C) 2005-2006 Jan Rychter <jan@rychter.com>
Copyright (C) 1999, 2002-2003 Asit Mallick <Asit.K.Mallick@intel.com> Don Dugger <Don.Dugger@intel.com>
Suresh Siddha <suresh.b.siddha@intel.com> Fenghua Yu <fenghua.yu@intel.com>
Copyright (c) 2008 Isaku Yamahata <yamahata at valinux co jp> VA Linux Systems Japan K.K. pv_ops.
Copyright (C) 2007 Bartłomiej Zolnierkiewicz
"Copyright (C) 2005-2009 MontaVista Software, Inc. "
Copyright (c) 2008, John W. Linville <linville@tuxdriver.com>
Copyright(c) 2011 Google, Inc. All rights reserved.
Copyright (c) 2007 Paul Walmsley
"Copyright (C) 2010 Andy Walls <awalls@md.metrocast.net> "
Copyright (C) Chandra Seetharaman, IBM Corp. 2007
Copyright (c) 2019 Baylibre SAS. Author: Neil Armstrong <narmstrong@baylibre.com>
Copyright (C) 2017 NextThing Co
Copyright (C) 2009 Wind River Systems Written by Ralf Baechle <ralf@linux-mips.org>
Copyright (C) 2006 Rafael J. Wysocki <rjw@sisk.pl>
Copyright (C) 2010-2012 Bojan Smojver <bojan@rexusive.com>
Copyright (C) 2008 Wind River Systems, written by Ralf Baechle
Copyright (C) 2009-2010 Marvell International Ltd.
Copyright (C) 1998 David S. Miller (davem@redhat.com)
"Copyright (C) 1999-2002 Andre Hedrick <andre@linux-ide.org>"
"Copyright (C) 2007-2010 Bartłomiej Zolnierkiewicz"
"Copyright (C) 2007,2009 MontaVista Software, Inc. <source@mvista.com> "
Copyright (C) 2004-2005 Deep Blue Solutions Ltd.
Copyright 2018 Google LLC
Copyright 2006, Segher Boessenkool, IBM Corporation.
Copyright 2006-2007, Michael Ellerman, IBM Corporation.
Copyright(c) clean the page again and return 1 to cause the writeback.
Copyright: (C) 2009 Texas Instruments, India
Copyright (C) 2002 Deep Blue Solutions Ltd.
Copyright (c) 2001 Tony Luck <tony.luck@intel.com>

LICENCE TERMS (cont.)

Copyright (c) 2002 NEC Corp.
Copyright (c) 2002 Kimio Suganuma <k-suganuma@da.jp.nec.com>
Copyright (c) 2004 Silicon Graphics, Inc Russ Anderson <rja@sgi.com> Jesse Barnes <jbarnes@sgi.com> Jack Steiner <steiner@sgi.com>
Copyright (C) 2000 MIPS Technologies, Inc.
Copyright (C) 1999, 2001 Silicon Graphics, Inc.
Copyright (C) 2013-2015 Lantiq Beteiligungs-GmbH & Co.KG
Copyright (C) 2016 Martin Blumenstingl <martin.blumenstingl@googlemail.com>
Copyright (c) 2006 Rick Koch <n1gp@hotmail.com>
Copyright (c) 2004 Vojtech Pavlik and Dan Streetman <dddstreet@ieee.org>
Copyright 2017 NXP.
Copyright (C) 1994 - 2000 Ralf Baechle
Copyright (C) 2013 Texas Instruments Incorporated Author: Tomi Valkeinen <tomi.valkeinen@ti.com>
Copyright (C) 2001-2004, SnapGear Inc. (www.snapgear.com)
Copyright (C) 1999 Andrew R. Baker (andrewb@uab.edu)
Copyright (C) 2001 Florian Lohoff (flo@rfc822.org)
Copyright (C) 2004 Paul Mundt
Copyright (C) 2004-2009 Texas Instruments, Inc.
Copyright (C) 2015 Texas Instruments Incorporated - http://www.ti.com
Copyright (C) 2007 Ian Molton
Copyright (C) 2004 Ian Molton
Copyright(C) 2009-2010 Bartlomiej Zolnierkiewicz
Copyright(C) 2012 MontaVista Software, LLC <source@mvista.com>
"Copyright (C) 1999-2002 Andre Hedrick <andre@linux-ide.org> "
Copyright (C) 2014 Pavel Machek <pavel@ucw.cz>
Copyright (C) 2014 Kevin Cernekee <cernekee@gmail.com>
Copyright (C) 2006-2008 Intel Corporation Author: Anil S Keshavamurthy <anil.s.keshavamurthy@intel.com>
Copyright (C) 2005-2012 Jean Delvare <jdelvare@suse.de>
Copyright (C) 2006 Yuan Mu (Winbond), Rudolf Marek <r.marek@assembler.cz> David Hubbard <david.c.hubbard@gmail.com> Daniel J Blueman <daniel.bluman@gmail.com>
Copyright (C) 2010 Sheng-Yuan Huang (Nuvoton) (PS00)
Copyright (C) 2003 Mark Studebaker
Copyright 2015 Felix Fietkau <nbd@openwrt.org>
Copyright (c) 2005-2006, 2010-2013, Wind River Systems All rights reserved.
Copyright (C) 1999 RG Studio s.c. Written by Krzysztof Halasa <khc@rgstudio.com.pl>
Copyright(C) SBE Inc., used by permission.
Copyright 2007-2008 Jaime Velasco Juan <jsagarribay@gmail.com>
Copyright (C) 2016 Pengutronix, Michael Tretter <kernel@pengutronix.de>
Copyright (C) 1999, 2000, 04 Ralf Baechle (ralf@linux-mips.org)
Copyright 2006-12 Wolfson Microelectronics, plc
Copyright (c) 2007, 2008 Mellanox Technologies. All rights reserved.
Copyright (C) 1991, 1992 Linus Torvalds. Made endianness-clean by Andrew Stribblehill <ads@wompom.org>, 2005.
Copyright (c) 2010-17: Borislav Petkov <bp@alien8.de> Advanced Micro Devices Inc.
Copyright (c) 2004-2006 Voltaire Corporation. All rights reserved.
Copyright (c) 2017 Pengutronix, Oleksij Rempel <kernel@pengutronix.de>
Copyright 2004 (c) MontaVista, Software, Inc.
Copyright (C) 2002 Maxim Yevtyushkin <max@linuxmedialabs.com>
Copyright (c) 2005-2006 Mauro Carvalho Chehab <mchehab@kernel.org>
Copyright (c) 2011-2014,2016-2017 Qualcomm Atheros, Inc.
Copyright (c) 2007 Ujjwal Pande <ujjwal@kenati.com>,
Copyright (C) 2015 Google, Inc.
Copyright(C) 2011 The Chromium OS Authors
Copyright 2013 Ideas On Board SPRL
Copyright (c) 2002 Adaptec Inc. All rights reserved.
Copyright (c) 2005, Keir Fraser <keir@xensource.com>
Copyright (c) 2010 David Chinner.

Copyright (c) 2011 Christoph Hellwig. All Rights Reserved.
Copyright 2008 Thomas Bogendoerfer <tsbogend@franken.de>
Copyright (C) 2000 Lineo, Inc. (www.lineo.com)
Copyright (C) 1995 Hamish Macdonald
Copyright (c) 2003-2004 Christoph Hellwig All rights reserved.
Copyright (C) 2011 Kees Cook <keescook@chromium.org>
Copyright (C) 2014 Red Hat, Inc. Author: Michael S. Tsirkin <mst@redhat.com>
Copyright (C) 1998 Pete Zaitcev <zaitcev@yahoo.com>
Copyright (C) 2012 Peter Schildmann <linux@schildmann.info>
Copyright (C) 2019 Intel Corporation
Copyright (C) 2019 Intel Corporation All rights reserved.
Copyright (C) 2001,2002,2003 Broadcom Corporation
Copyright (C) 1995-2000 Simon G. Vogl
Copyright (C) 2007 - 2014 Jean Delvare <jdelvare@suse.de>
Copyright (C) 2010 Intel Corporation, David Woodhouse <dwmw2@infradead.org>
Copyright (C) 2015 Broadcom Corporation
Copyright (C) 2009 Andre Prendel <andre.prendel@gmx.de>
Copyright (c) 2013 Guenter Roeck <linux@roeck-us.net>
Copyright (C) 2002, 2007 Maciej W. Rozycki
Copyright (C) 2001, 2012 MIPS Technologies, Inc. All rights reserved.
Copyright (c) 2015, Prodrive Technologies
Copyright (c) 2015, Texas Instruments Incorporated
Copyright (c) 2015, RapidIO Trade Association All rights reserved.
Copyright (C) 2010-2015 Emulex. All rights reserved. * EMULEX and SLI are trademarks of Emulex. * www.broadcom.com *
Copyright 2007, 2011, Broadcom Corporation
Copyright (C) 2004-2008 Jean Delvare <jdelvare@suse.de>
Copyright (c) 2013, The Linux Foundation. All rights reserved. Author: Bjorn Andersson <bjorn.andersson@sonymobile.com>
Copyright (C) 2012 Tomasz Figa <tomasz.figa@gmail.com>
Copyright © 2007 Eugeny Boger <eugenyboger@dgap.mipt.ru>
Copyright (C) 2004 MontaVista Software, Inc.
Copyright (C) 2010 Texas Instruments.
Copyright (C) 2019, Paul Cercueil <paul@crapouillou.net>
Copyright (C) 2010, Frederic Weisbecker <fweisbec@gmail.com>
Copyright (C) 2012, Jiri Olsa <jolsa@redhat.com>
Copyright (c) 2008 Samuel Thibault
Copyright (c) 2009, 2010 the Speakup Team
Copyright (C) 2000,2001,2002 Free Software Foundation, Inc.
Copyright (c) YEAR YOUR NAME. Permission is granted to copy, distribute and/or modify this document under the terms of the GNU Free Documentation License, Version 1.2 or any later version published by the Free Software Foundation
Copyright (C) 2016 Spencer E. Olson <olsonse@umich.edu>
Copyright (C) 2016 Spencer E. Olson <olsonse@umich.edu>
Copyright(C) 2005 John Williams
Copyright (C) 1995-1996 Gary Thomas <gdt@linuxppc.org> Initial PowerPC version.
Copyright (C) 1996 Cort Dougan <cort@cs.nmt.edu> Rewritten for PReP
Copyright (C) 1996 Paul Mackerras <paulus@cs.anu.edu.au> Low-level exception handlers, MMU support, and rewrite.
Copyright (C) 1997 Dan Malek <dmalek@jlc.net> PowerPC 8xx modifications.
Copyright (C) 1998-1999 TiVo, Inc. PowerPC 403GCX modifications.
Copyright (C) 1999 Grant Erickson <grant@lcse.umn.edu> PowerPC 403GCX/405GP modifications.
Copyright (C) 2004 Xilinx, Inc.
Copyright 2000-2003 MontaVista Software Inc.
Copyright (C) 2001-2003 Andreas Gruenbacher <agruen@suse.de>
Copyright (C) 2003 Ralf Baechle <ralf@linux-mips.org>
Copyright (C) 2001-2002 IBM Corp.

LICENCE TERMS (cont.)

Copyright (c) 2017 Maxime Ripard.
Copyright (c) 2017 Jonathan Liu.
Copyright (C) 2004 - 2010 Ivo van Doorn <ivDoorn@gmail.com> http://rt2x00.serialmonkey.com>
Copyright 2013 Maxime Ripard
Copyright (c) 2005 Network Appliance, Inc. All rights reserved.
Copyright (c) 2009-2012,2014, The Linux Foundation. All rights reserved.
Copyright(c) 2017 Intel Deutschland GmbH All rights reserved.
Copyright (C) 1995-2004 Russell King
Copyright 2017 MicroSys Electronics GmbH
Copyright (C) 2005 - 2007 Paul Mundt
Copyright : Ian Molton <spyro@f2s.com> Andrew Zabolotny <zap@homelink.ru> Russell King <rmk@arm.linux.org.uk>
Copyright 2017 ARM Ltd.
Copyright (c) 2005 David Brownell
Copyright (c) 2006 Nokia Corporation corgi_ts.c
Copyright (C) 2004-2005 Richard Purdie omap_ts.[hc], ads7846.h, ts_osk.c
Copyright (C) 2002 MontaVista Software
Copyright (C) 2005 Dirk Behme
Copyright (C) 2019 Western Digital Corporation or its affiliates.
Copyright (C) 2011 Texas Instruments, Inc. Paul Walmsley
Copyright(c) 2012 - 2014, 2018 - 2020 Intel Corporation
Copyright(c) 2012 - 2014, 2018 - 2020 Intel Corporation All rights reserved.
Copyright (C) 2010 Thomas Langer <thomas.langer@lantiq.com>
Copyright (C) 1997 Jes Sorensen
Copyright (C) 1996 Frank Neumann
Copyright 1999,2000 Jeff Garzik <jgarzik@pobox.com>
Copyright (C) 2012 Stephane Grosjean <s.grosjean@peak-system.com>
Copyright (C) 2001-2006 PEAK System-Technik GmbH
Copyright (C) 2008-2010 Nokia Corporation Paul Walmsley
Copyright (c) 2013 Samsung Electronics Co., Ltd. http://www.samsung.com
Copyright (C) 2001-2004 Jes Sorensen, Wild Open Source Inc.
Copyright (C) 2003-2004 Christoph Hellwig
Copyright (c) 2002 M. R. Brown
Copyright (C) 2003, 04 Ralf Baechle (ralf@linux-mips.org)
Copyright (C) 1998 Kenneth Albanowski <kjahds@kjahds.com>,
Copyright(c) 2018 - 2020 Intel Corporation
Copyright(c) 2018 - 2020 Intel Corporation All rights reserved.
Copyright 2015 Linaro Limited.
Copyright (C) 2018 Oleh Kravchenko <oleg@kaa.org.ua>
Copyright (C) 2012 Renesas Electronics Corp. Author: Guennadi Liakhovetski <g.liakhovetski@gmx.de>
Copyright(c) Benjamin Herrenschmidt <benh@kernel.crashing.org>, IBM Corp,\ and Scott Wood <scottwood@freescale.com>
Copyright (C) 2008 Constantin Baranov <const@mimas.ru>
Copyright (C) 2006 Rusty Russell IBM Corporation
Copyright 2006-2009 Simtec Electronics Ben Dooks <ben@simtec.co.uk>
Copyright (C) 2000, Goutham Rao <goutham.rao@intel.com>
Copyright (c) 2016 by Mauro Carvalho Chehab <mchehab+samsung@kernel.org>.
Copyright 2008 Red Hat <mjg@redhat.com>
Copyright (c) 2003 Maciej W. Rozycki
Copyright (c) Nokia Corporation, 2007
"Copyright (C) 2008, 2005 Rusty Russell rusty@rustcorp.com.au"
Copyright (c) 2001 - 2008 Paul Mundt <lethal@linux-sh.org>
Copyright (c) 2018, Oleksandr Andrushchenko, EPAM Systems Inc.
Copyright (C) 2016 Marek Vasut <marex@denx.de>
Copyright (C) 2005-2007 Freescale Semiconductor, Inc.
Copyright(c) container_of(c, struct idmac_channel, dma_chan)
Copyright (C) 2016 Renesas Electronics Corp.

Copyright (C) 2015 Felix Fietkau <nbd@openwrt.org>
Copyright(c) 2004 Jean-Philippe Andriot, <jean-philippe.andriot@6WIND.com> 6WIND, Paris, France
Copyright (C)2007,2008 USAGI/WIDE Project YOSHIFUJI Hideaki <yoshifuji@linux-ipv6.org>
Copyright (C) 2009. SUSE Linux Products GmbH. All rights reserved.
Copyright (C) 2001 Andrea Arcangeli <andrea@suse.de> SuSE
Copyright (C) 2006 Secret Lab Technologies Ltd. Grant Likely <grant.likely@secretlab.ca>
Copyright (C) 2004-2006 Sylvain Munaut <tnt@246tnt.com>
Copyright (C) 2005 Maxime Bizon <mbizon@freebox.fr>
Copyright (C) 2004 - 2005 Leonid Stoljar
Copyright (C) 2006 Nathaniel Clark <nate@misrule.us>
Copyright (C) 2006 - 2010 ID7 Ltd.
Copyright (C) 2010-2013 Nicholas A. Bellinger <nab@kernel.org>
Copyright (c) 2017-2018 Microsemi Corporation
Copyright (c) 2016 Microsemi Corporation
Copyright (c) 2016 PMC-Sierra, Inc. mailto:esc.storage@microsemi.com)
Copyright (C) 2011 Guennadi Liakhovetski
Copyright(c) 2007 - 2008 Chris Snook <csnook@redhat.com>
Copyright(c) 1999 - 2005 Intel Corporation. All rights reserved.
Copyright (c) 2007 Atheros Corporation."
Copyright 2008, Jouni Malinen <j@w1.fi>
Copyright (C) 2016-2017 Intel Deutschland GmbH
Copyright 2004, Matt Porter <mporter@kernel.crashing.org>
Copyright 2011 Lars-Peter Clausen <lars@metafoo.de>
Copyright (C) 1999-2003 Ralph Metzler Marcus Metzler for convergence integrated media GmbH
Copyright Acxiom Corporation, 2005.
Copyright (C) 2012 Enric Balletbo i Serra <eballetbo@gmail.com>
Copyright (C) 2001 Greg Kroah-Hartman (greg@kroah.com)
Copyright (c) 2009 Wu Zhangjin <wuzhangjin@gmail.com>
Copyright 2005 (C) MontaVista Software, Inc.
Copyright (c) 2017 BayLibre, SAS Author: Neil Armstrong <narmstrong@baylibre.com>
Copyright (c) 2010 CompuLab Ltd. Mike Rapoport <mike@compulab.co.il>
Copyright (c) 2004-2007, Matt Reimer <mreimer@vpop.net>
Copyright(c) 2004 Szabolcs Gyurko
Copyright return platform_driver_register(&ds1wm_driver)
Copyright (C) 2010 Miguel Gaio <miguel.gaio@efixo.com>
Copyright (C) 2008 Atmel
Copyright 2006 Endrelia Technologies Inc.
"Copyright: (C) 2004 MontaVista Software, Inc. "
Copyright 2006 Dave Airlie
Copyright (c) 2010 Ben Cropley <bcropley@internode.on.net>
Copyright (c) 1999 Andreas Gal
Copyright (C) 2009 Eric Paris <Red Hat Inc>
Copyright © 2014 The Chromium OS Authors
Copyright (C) 2016 Altera Corporation. All rights reserved
Copyright (C) 2005 Arthur Huillet (ahuillet@users.sf.net)
Copyright (C) 2005 Thomas Hergenahn <thomas.hergenahn@suse.de>
Copyright (C) 2009 Outpost Embedded, LLC
Copyright (C) 2010 Zilogic Systems <code@zillogic.com>
Copyright (C) 2013 Wei Shuai <cpuwolf@gmail.com>
Copyright (C) 2013 Linux Foundation
Copyright 2004-2005 Simtec Electronics http://armlinux.simtec.co.uk/ Ben Dooks <ben@simtec.co.uk>
Copyright (C) 1994, 1995, 1996, by Andreas Busse
Copyright (C) 2000 MIPS Technologies, Inc. written by Carsten Langgaard, carsten@mips.com
Copyright (C) 2012 - Virtual Open Systems and Columbia University Authors: Christoffer Dall <c.dall@virtualopensystems.com>
Copyright(C) Copyright 2003 Red Hat Inc, All Rights Reserved
Copyright(C) Copyright 2003, 2004 Jamie Lokier

LICENCE TERMS (cont.)

Copyright(C) Copyright 2006 Red Hat Inc, All Rights Reserved Thanks to Thomas Gleixner for suggestions, analysis and fixes.

Copyright (C) 2006 Red Hat, Inc., Ingo Molnar <mingo@redhat.com>

Copyright (C) 2006 Timesys Corp., Thomas Gleixner <tglx@timesys.com>

Copyright (C) 2007 Eric Dumazet <dada1@cosmosbay.com>

Copyright (C) IBM Corporation, 2009 Thanks to Thomas Gleixner for conceptual design and careful reviews.

Copyright (c) 2007 Microchip Technology Inc. likely to be covered by the MLPL as found at: <http://msdn.microsoft.com/en-us/cc300389.aspx#MLPL>. For use only on Windows operating systems.

Copyright (C) 2009 Wolfram Sang, Pengutronix <w.sang@pengutronix.de>

Copyright (C) 1995, 2008 David S. Miller (davem@davemloft.net)

Copyright (C) Alex Williamson (alex_williamson@hp.com)

Copyright (c) 2005-2008, 2010-2011, Wind River Systems All rights reserved.

Copyright (C) 1994 - 1999, 2000, 03 Ralf Baechle

Copyright 2009 Secret Lab Technologies Ltd.

Copyright (C) 2002 Dell Inc.

Copyright (C) Matt Domsch <Matt_Domsch@dell.com>

Copyright (C) 2002 Intel

Copyright (C) Jenna Hall <jenna.s.hall@intel.com>

Copyright (C) 2001 Intel

Copyright (C) Fred Lewis <frederick.v.lewis@intel.com>

Copyright (C) 2000 Intel

Copyright (C) Chuck Fleckenstein <cfleck@co.intel.com>

Copyright (C) 1999, 2004-2008 Silicon Graphics, Inc.

Copyright (C) Vijay Chander <vijay@enr.sgi.com>

Copyright (C) 2006 FUJITSU LIMITED

Copyright (C) Hidetoshi Seto <seto.hidetoshi@jp.fujitsu.com>

Copyright (c) 2017-2018 Icenowy Zheng <icenowy@aosc.io>

Copyright (C) 2000 Mark Lord <mlord@pobox.com>

Copyright (C) 1995 Miguel de Icaza (miguel@nuclecu.unam.mx)

Copyright (C) 1995 Pete A. Zaitcev (zaitcev@yahoo.com)

Copyright (C) 1996 Dave Redman (djhr@tadpole.co.uk)

Copyright 2002-2005 MontaVista Software Inc.

Copyright 2012-2013 Jonas Gorski <jogo@openwrt.org>

Copyright (C) 2004 Pete Trapps

Copyright (C) 2006 Matt Callow

Copyright (C) 2010 Janusz Krzysztofik

Copyright 2002 Adam Belay <ambx1@neo.rr.com>

Copyright (c) 2002 Erich Focht <efocht@ess.nec.de>

Copyright (c) 2002 Kimio Suganuma <k-suganuma@da.jp.nec.com>

Copyright (C) 2012 Texas Instruments, Inc. Paul Walmsley

Copyright (C) 2004 Red Hat, Inc. All rights reserved.

Copyright 2018 INPHI

Copyright (c) 2013, NVIDIA CORPORATION. All rights reserved.

Copyright (c) 2003-2004, MontaVista Software, Inc.

Copyright (C) 1998, 1999 Ralf Baechle

Copyright (C) 2018 Amarula Solutions B.V.

Copyright (C) 2019 Renesas Electronics Corp.

Copyright (c) 2013-2014 Texas Instruments, Inc.

Copyright (C) 1999-2000 Naval Research Laboratory

Copyright (C) 2005 Simtec Electronics

Copyright (C) 2008 Greg Kroah-Hartman <greg@kroah.com>

Copyright (C) 2008 Novell Inc.

Copyright (C) 2010, 2012 Bastien Nocera <hadess@hadess.net>

Copyright (C) 2013 Benjamin Tissoires <benjamin.tissoires@gmail.com>

Copyright (C) 2013 Red Hat Inc. All Rights Reserved

Copyright (c) 2014, The Linux Foundation, Laura Abbott.

Copyright(C) Copyright 2008 Intel Corporation, Arjan van de Ven.

Copyright (c) 2006-2009 VMware, Inc., Palo Alto, CA., USA All Rights Reserved.

Copyright (C) 2008 - 2011 Bart Van Assche <bvanassche@acm.org>.

Copyright (C) 2008-2009 Eric Piel

Copyright (C) 2007-2009 Nokia Corporation

Copyright (C) 1996 Cort Dougan <cort@fsmllabs.com> Adapted for Power Macintosh by Paul Mackerras.

Copyright (C) 1997 Dan Malek (dmalek@jlc.net).

Copyright (C) 2006 Felix Fietkau <nbd@openwrt.org>

Copyright (c) 2006 Anssi Hannula <anssi.hannula@gmail.com>

Copyright 2019 Google LLC

Copyright (C) 2013 - ARM Ltd

Copyright (C) 2016 Alexander Kurz <akurz@blala.de>

Copyright (C) Amazon Technologies Inc. All rights reserved. Manish Lachwani (lachwani@lab126.com)

Copyright 2012 Emerson

Copyright (C) 2012 Ryan Mallon <rmallon@gmail.com>

Copyright (C) 2012 - Virtual Open Systems and Columbia University Authors: Rusty Russell <rusty@rustcorp.com.au> Christoffer Dall <c.dall@virtualopensystems.com>

Copyright (C) 2001 Paul Mundt

Copyright (C) 2003 Guido Guenther <agx@sigxcpu.org>

Copyright (C) 2003, 2004 Ralf Baechle (ralf@linux-mips.org)

Copyright (C) 2005 Thiemo Seufer

Copyright (c) 2005-6 The University of Waikato, Hamilton, New Zealand.

Copyright (c) 2005-6 Ian McDonald <ian.mcdonald@jandi.co.nz>

Copyright (c) 2005 Arnaldo Carvalho de Melo <acme@conectiva.com.br>

Copyright (c) 2003 Nils-Erik Mattsson, Joacim Haggmark, Magnus Erixson

Copyright (C) 2006 - 2007 Paul Mundt

Copyright (C) 2008 Nokia Corporation Contact: Felipe Balbi <felipe.balbi@nokia.com>

Copyright (c) 2019 Jeff Layton

Copyright (C) 2011 Jean Delvare <jdelvare@suse.de>

Copyright (C) 2013, 2014 Guenter Roeck <linux@roeck-us.net>

Copyright (C) 2014, 2015 Pali Rohar <pali.rohar@gmail.com>

Copyright (C) 2005, 2006 IBM Corporation All Rights Reserved.

Copyright 2003 SuSE Linux AG.

Copyright (C) 2016 Nextfour Group

Copyright (C) 2012 Red Hat

Copyright (c) 2017 Vadim Pasternak <vadimp@mellanox.com>

Copyright(c) 1999-2001 Gerd Knorr <kraxel@goldbach.in-berlin.de>

Copyright (C) 2003 John Klar <linpvr at projectplasma.com>

Copyright (C) 2015-2016 Nobuo Iwata

Copyright (C) 1996, 1999 Jay A Estabrook

Copyright (C) 1998, 1999 Richard Henderson

Copyright (C) 1999 Iain Grant

Copyright(c) 2003 - 2006 Intel Corporation. All rights reserved.

Copyright (C) 2003 Pavel Machek (pavel@ucw.cz)

Copyright (C) 2005 Philippe De Muyter (phdm@macqel.be)

Copyright (c) 2007, 2013 Tejun Heo <teheo@suse.de>

Copyright 2017-2019 NXP.

Copyright 2003 ICT CAS Author: Michael Guo <guoyi@ict.ac.cn>

Copyright (C) 2007 Lemote Inc. & Institute of Computing Technology Author: Fuxin Zhang, zhangfx@lemote.com

Copyright (C) 2009 Lemote Inc. Author: Wu Zhangjin, wuzhangjin@gmail.com

Copyright (C) 2004-2011 Emulex. All rights reserved. * EMULEX and SLI are trademarks of Emulex. * www.broadcom.com *

Copyright (C) Christoph Hellwig, 2002

Copyright (C) 2007-2010 Bartlomiej Zolnierkiewicz

Copyright (C) 2017-2018 Samuel Holland <samuel@sholland.org>

Copyright (C) 2006 Michael Hanselmann (linux-kernel@hansmi.ch)

Copyright (c) 2018 Fuzhou Rockchip Electronics Co., Ltd.

Copyright (C) 2004-2006 Marcel Holtmann <marcel@holtmann.org>

LICENCE TERMS (cont.)

Copyright (C) 2019 Google LLC <ebiggers@google.com>
Copyright (c) 2013, Intel Corporation
Copyright (C) 2006 Nokia Corporation
Copyright (C) 2001, 2004 MIPS Technologies, Inc.
"Copyright (C) 2004 Maciej W. Rozycki "
Copyright (C) 2019, Texas Instruments
Copyright (C) 2004, 2005 Dominik Brodowski <linux@brodo.de>
Copyright(C) 2006-2007 Venkatesh Pallipadi <venkatesh.pallipadi@intel.com> Shaohua Li <shaohua.li@intel.com>
Adam Belay <abelay@novell.com>
Copyright (C) 2006-2008, Uri Shkolnik
Copyright 2018 Christoph Hellwig.
Copyright (C) 2006-2007 Georg Acher
Copyright (C) 2007-2008 Darron Broad March 2007 Fixed some bugs.
Copyright (C) 2008 Igor Liplianin September
Copyright (C) 2017, Intel Corporation
Copyright (C) 2012-2014 Cisco Systems
Copyright 2008 Freescale Semiconductor, Inc. Written By Michael Meissner
Copyright (c) 2004, 2005 Voltaire, Inc. All rights reserved.
Copyright (c) 2018 Collabora Ltd.
Copyright (C) 1994-1999 Russell King
Copyright (c) 2010-2010 Analog Devices Inc.
Copyright 2003 Leif Delgass. All Rights Reserved.
Copyright 2007,2008 Freescale Semiconductor, Inc.
Copyright (C) 2008 PetaLogix
Copyright (C) 2007 Xilinx, Inc. All rights reserved.
Copyright (C) 2005-2007 Pierre Ossman, All Rights Reserved.
Copyright (C) 2006 Philip Langdale, All Rights Reserved.
Copyright (C) 2012 Fenghua Yu <fenghua.yu@intel.com> H Peter Anvin" <hpa@zytor.com>
Copyright(C) 2015 Borislav Petkov <bp@alien8.de>
Copyright (c) 2007 Michel Ludwig <michel.ludwig@gmail.com> Fixed module load/unload
Copyright (C) 2011-2012 Gabor Juhos <juhosg@openwrt.org>
Copyright (c) 2015, The Linux Foundation. All rights reserved.
Copyright (C) 2019 Facebook
Copyright 2004 Digeo, Inc., Palo Alto, CA, U.S.A. All Rights Reserved.
Copyright 2004 The Unichrome project. All Rights Reserved.
Copyright (c) 2004-2006 Silicon Graphics, Inc.
Copyright (c) 2006 Silicon Graphics, Inc. by Greg Banks <gnb@melbourne.sgi.com>
Copyright (C) 2004 Greg Kroah-Hartman <greg@kroah.com>
Copyright (C) 2013, 2013 Red Hat, Inc. Dave Young <dyoung@redhat.com>
Copyright (C) 2000-2004 Russell King
Copyright (c) 2015 Pengutronix, Philipp Zabel <p.zabel@pengutronix.de>
Copyright (C) 1993 Paul B. Monday
Copyright (c) 2012-2014 Pablo Neira Ayuso <pablo@netfilter.org>
Copyright (C) 2003-2004 MontaVista Software, Inc. based on nas100d-power.c:
Copyright (C) 2005 Tower Technologies based on nas100d-io.c
Copyright (C) 1999-2002 Hewlett-Packard Co.
Copyright (C) 2005-2008 Intel Co.
Copyright (C) 2013 SuSE Labs
Copyright (C) 2003 - 2008 Nokia Corporation
Copyright (C) 2013 Frank Schäfer <fschaefer.oss@googlemail.com>
Copyright (C) 2002-2005 Pavel Roskin <proski@gnu.org> Portions based on information in wl_lkm_718 Agere driver
COPYRIGHT (C) 2001-2004 by Agere Systems Inc. All Rights Reserved
copyright (C) 2001-2004 by Agere Systems Inc. All Rights Reserved
Copyright (c) 2002-2005 Sam Leffler, Ermo Consulting
Copyright (C) 2008 Alexey Starikovskiy <astarikovskiy@suse.de>
Copyright (C) 2008 Fabio Checconi <fabio@gandalf.sssup.it> Paolo Valente <paolo.valente@unimore.it>
Copyright (C) 2009 Vivek Goyal <vgoyal@redhat.com> Nauman Rafique <nauman@google.com>
Copyright (c) 2004 VIA Networking Technologies, Inc
Copyright (c) 2004 Simtec Electronics http://armlinux.simtec.co.uk/ Written by Ben Dooks, <ben@simtec.co.uk>
Copyright (C) 2012 ST Microelectronics Shiraz Hashim <shiraz.linux.kernel@gmail.com>
Copyright (C) 2009 Renesas Solutions Corp. Kuninori Morimoto <morimoto.kuninori@renesas.com>
Copyright (C) 2008 Kuninori Morimoto <morimoto.kuninori@renesas.com>
Copyright (C) 2008, Robert Jarzmik <robert.jarzmik@free.fr>
Copyright (C) 2010 Henrik Rydberg <rydberg@euromail.se>
Copyright (C) 2005 Robert Love <rml@novell.com>
Copyright (C) 2005 Jesper Juhl <jj@chaosbits.net>
Copyright (C) 2006 Hendrik Holtmann <holtmann@mac.com>
Copyright (C) 2003 - 2012 Paul Mundt
Copyright (c) 2014, Sony Mobile Communications Inc.
Copyright (c) 1999 Intel Corporation"
Copyright 2010 Arnaud Patard <arnaud.patard@rtp-net.org>
Copyright (C) 2016 Andrew Lunn <andrew@lunn.ch>
Copyright (c) 2006-2010 Jiri Kosina
Copyright (c) 2003-2018 Avago Technologies.
Copyright (c) 2003-2018 Broadcom Inc.
Copyright (c) 2015 Linaro Limited.
Copyright 2002-2005, Instant802 Networks, Inc.
Copyright 2007-2010, Intel Corporation
Copyright 1999 SuSE GmbH (Philipp Rumpf, prumpf@tux.org)
Copyright 1999 Hewlett Packard Co.
Copyright (c) 2011 Texas Instruments Incorporated
Copyright (C) 2003 STMicroelectronics Limited
Copyright (C) 1999, 2000 Silicon Graphics, Inc. Kevin D. Kissell, kevink@mips.com and Carsten Langgaard, carstenl@mips.com
Copyright 2015 - Marcus Cooper <codekipper@gmail.com>
"Copyright (C) 2005-2007 E.M. Smith"
"Copyright (C) 2007-2008 Carlos Corbacho <cathectic@gmail.com> "
Copyright (C) 2019 Linux Foundation
Copyright: (C) 2012 Gilles Muller, INRIA/LiP6. URL: http://coccinelle.lip6.fr/ Requires: 1.0.0 Options:
Copyright 2016 Crestez Dan Leonard <leonard.crestez@intel.com>
Copyright 2011 Linaro
Copyright (C) 2004 Anil S Keshavamurthy <anil.s.keshavamurthy@intel.com> Added processor hotplug support
Copyright (C) 2011 James Nuss <jamesnuss@nanometrics.ca>
Copyright 2016-2017, 2019 NXP
Copyright 2017 NXP Semiconductor, Inc.
Copyright (c) 2012 Ecole Nationale de l'Aviation Civile, France
"Copyright (C) 2005-2017 Andes Technology Corporation ifndef _ASM_CACHECTL define _ASM_CACHECTL "
Copyright (c) by Phil Poole 2013
Copyright (C) 2007 MontaVista Software, Inc., <source@mvista.com>
Copyright (C) 2008 Nokia Corporation Contact: Jarkko Nikula <jarkko.nikula@bitmer.com> Peter Ujfalusi <peter.ujfalusi@ti.com>
Copyright 2007-2010 Freescale Semiconductor, Inc.
Copyright (C) 2010 by Mauro Carvalho Chehab
Copyright(c) 2007 xiong huang <xiong.huang@atheros.com>
Copyright (C) 2006 Tomasz Michal Lukaszewski (FIXME: add e-mail)
Copyright (C) 2003 IBM Corp.
Copyright (c) 2003 Intracom S.A. by Pantelis Antoniou <panto@intracom.gr>
Copyright (C) 2011 Samsung Electronics Donggeun Kim <dg77.kim@samsung.com> Amit Daniel Kachhap <amit.kachhap@linaro.org>
Copyright (C) 2004 Ian Molton, All Rights Reserved.
Copyright (C) 2005-2008 Pierre Ossman, All Rights Reserved.
Copyright 2000 - 2001 Kanoj Sarcar (kanoj@sgi.com)
Copyright (C) 2009 Wind River Systems Inc

LICENCE TERMS (cont.)

Copyright (C) 2000, 2001, 2002 Andi Kleen SuSE Labs
Copyright (C) 2000 Pavel Machek <pavel@suse.cz>
Copyright (C) 2000, Rohit Seth <rohit.seth@intel.com>
Copyright (C) 2003 Silicon Graphics, Inc. All rights reserved.
Copyright (C) 2016 Bamvor Jian Zhang
Copyright (C) 2003 Mipsys - Benjamin Herrenschmidt
Copyright (c) 2014 Samsung Electronics Co., Ltd. Author: Thomas Abraham <thomas.ab@samsung.com>
Copyright (C) STMicroelectronics SA 2017
Copyright (C) 2015 Mentor Graphics Corporation.
Copyright (C) 2001 by Liam Davies (ldavies@agile.tv)
Copyright (C) 2011 Texas Instruments
Copyright 2019 Collabora Ltd.
Copyright 2000, Axis Communications AB Ethereal - Network traffic analyzer By Gerald Combs <gerald@ethereal.com>
Copyright 1998 Gerald Combs
"COPYRIGHT" ""Copyright(c) 2003-2006 Intel Corporation"
COPYRIGHT MODULE_FIRMWARE("ipw2200-ibss.fw
COPYRIGHT ifdef CONFIG_IPW2200_MONITOR MODULE_FIRMWARE("ipw2200-sniffer.fw
COPYRIGHT endif MODULE_FIRMWARE("ipw2200-bss.fw
Copyright(c) 2003-2006 Intel Corporation
Copyright (C) 2012-2017 by the following authors: Wladimir J. van der Laan <laanwj@gmail.com> Christian Gmeiner <christian.gmeiner@gmail.com> Lucas Stach <l.stach@pengutronix.de> Russell King <rmk@arm.linux.org.uk>
Copyright (C) 1999 Matthew Wilcox <willy@infradead.org>
Copyright (C) 1999-2007 Helge Deller <deller@gmx.de>
Copyright (C) 2009 Jason Wessel <jason.wessel@windriver.com>
Copyright 2011 Florian Tobias Schandinat <FlorianSchandinat@gmx.de>
Copyright (C) 2000, 2002, 2003, 2005 Maciej W. Rozycki
Copyright (C) 2010 EF Johnson Technologies
Copyright (c) 2014 Imagination Technologies Ltd. Author: Markos Chandras <markos.chandras@imgtec.com>
Copyright 2016 Christopher Spinrath
Copyright 2013 CompuLab Ltd. Author: Valentin Raevsky <valentin@compulab.co.il>
Copyright (C) 2003 Greg Kroah-Hartman (greg@kroah.com)
Copyright (C) 1999 D. Jeff Dionne
Copyright (C) 2010 - 2013 Texas Instruments Inc.
Copyright (c) 2006 Intel Corporation
Copyright (c) 2007 Keir Fraser, XenSource Inc
Copyright (c) 2008 Intel Corporation
Copyright(c) 2017 T-Platforms. All Rights Reserved.
Copyright(c) 2015 Intel Corporation. All rights reserved.
Copyright (C) 2001 Ronny Strutz <3des@elitedvb.de>
Copyright (C) 2002 Dennis Noermann <dennis.noermann@noernet.de>
Copyright (C) 2002-2003 Andreas Oberitter <obi@linuxtv.org>
Copyright (C) 2019 Michael Shych <mshych@mellanox.com>
Copyright (C) 2016 Freescale Semiconductor Inc.
Copyright (C) 2004-2006 Red Hat, Inc. All rights reserved.
Copyright © 2012 Roland Stigge
Copyright (C) 2009 Nokia Corporation
Copyright (C) 1990, 1999 by Silicon Graphics, Inc.
Copyright (c) 2006, 2006 Michael Buesch <m@bues.ch>
Copyright (C) 2005 Maciej W. Rozycki
Copyright (c) 2010 Hendrik Iben
Copyright (c) by James Courtier-Dutton <James@superbug.co.uk> Added support for Audigy 2 Value. Added EMU 1010 support. General bug fixes and enhancements.
Copyright (C) 2002-2004 by Luca Risolia <luca.risolia@studio.unibo.it>
Copyright (c) 2009 Lemote Inc. Author: Wu Zhangjin, wuzhangjin@gmail.com
Copyright (C) 2015 Engicam S.r.l.
Copyright 2013-2017 Lothar Waßmann <LW@KARO-electronics.de>

Copyright (C) 2008, Paulius Zaleckas <paulius.zaleckas@teltonika.lt>
Copyright (C) 1999 David S. Miller (davem@redhat.com)
Copyright (c) 2017 Cadence Design Systems, Inc.
Copyright (C) 1996,97,98 Ralph Metzler Marcus Metzler
Copyright(c) 1999-2002 Gerd Knorr
Copyright(c) 2000 Justin Schoeman
Copyright(c) 2005-2006 Nickolay V. Shmyrev
Copyright(c) 2006 Mauro Carvalho Chehab
Copyright (C) 2005, 2006 Michael H. Schimek Sponsored by OPQ Systems AB
Copyright (c) 2002 Johann Deneux
Copyright (c) 2014 Collabora Ltd.
Copyright(c) Intel Research Cambridge
Copyright (c) 2004, Christian Limpach
Copyright (c) 2004, Andrew Warfield
Copyright (c) 2005, Christopher Clark
Copyright (c) 2005, XenSource Ltd
Copyright (C) 2015, Huawei Inc.
Copyright (C) 2011, Javier Martin <javier.martin@vista-silicon.com>
Copyright (C) 2011, Guennadi Liakhovetski <g.liakhovetski@gmx.de>
Copyright (C) 2008 Helge Deller <deller@gmx.de>
Copyright 2009 Pavel Machek <pavel@ucw.cz>
Copyright 2012 Sonal Santan
Copyright 2014 Pali Rohár <pali.rohar@gmail.com>
Copyright** |copy| 2010 : Laurent Pinchart
Copyright** |copy| 2015-2016 : Mauro Carvalho Chehab
Copyright (C) 2016 Tom Tsai (Tom_Tsai@fintek.com.tw)
Copyright (C) 2016 Peter Hong (Peter_Hong@fintek.com.tw)
Copyright (c) 2006, 2007, 2008, 2009, 2010 QLogic Corporation. All rights reserved.
Copyright Linas Vepstas <linas@linas.org> 2004, 2005
Copyright (C) 2003 Paul Mundt <lethal@linux-sh.org>
Copyright 2018 Lubomir Rintel <lkundrak@v3.sk>
Copyright (C) 2014-2015 Allwinner
Copyright (c) 2014-2016 Jiri Pirko <jiri@mellanox.com>
Copyright (c) 2007 Deep Root Systems, LLC
Copyright(C) General Electric Company 2015
Copyright 2019-2020 NXP
Copyright (C) 2005-2006 Thomas Bogendoerfer (tsbogend@alpha.franken.de)
Copyright 2014 Google, Inc.
Copyright © 2011-2013 Intel Corporation
Copyright © 2015 Intel Corporation Daniel Vetter <daniel.vetter@ffwll.ch>
Copyright (C) 2006-2009 NEC Corporation.
Copyright(C) Copyright IBM Corp. 2004,2005 All Rights Reserved.
Copyright (C) 1999 Intel Corp.
Copyright (C) 1999 Asit Mallick <Asit.K.Mallick@intel.com>
Copyright (C) 1999 Don Dugger <Don.Dugger@intel.com>
Copyright (C) 2002 Fenghua Yu <fenghua.yu@intel.com>
Copyright (C) 2004 Ashok Raj <ashok.raj@intel.com> Support for CPU Hotplug
Copyright (C) 2015-2017 Sebastian Reichel <sre@kernel.org>
Copyright (C) 2009, Guennadi Liakhovetski <g.liakhovetski@gmx.de>
Copyright (C) 2015 Sony Mobile Communications Inc. Author: Werner Johansson <werner.johansson@sonymobile.com>
Copyright 2003 by Texas Instruments Incorporated
Copyright (C) 2000, 2001, 2002, 2003, 2004, 2005, 2007 Maciej W. Rozycki
Copyright (C) 1996 Paul Mackerras (Paul.Mackerras@cs.anu.edu.au)
Copyright (C) 1995 David S. Miller (davem@caip.rutgers.edu)
Copyright (C) 2010 NISHIMOTO Hiroki
Copyright (c) 1999-2001 Paul Davis

LICENCE TERMS (cont.)

Copyright (C) 1996 Cort Dougan <cort@cs.nmt.edu> Low-level exception handlers and MMU support rewritten by Paul Mackerras.
Copyright (C) 1996 Paul Mackerras. MPC8xx modifications by Dan Malek
Copyright IBM Corporation, 2008
Copyright 2005-2007 PMC-Sierra, Inc
Copyright (c) 2010 Baruch Siach <baruch@tkos.co.il>, Orex Computed Radiography
Copyright (C) 2010-2013 Freescale Semiconductor, Inc
Copyright (C) 2006-2008 Nokia Corporation
Copyright (C) 2006 Koninski Artur takeshi87@o2.pl
Copyright (C) 2006 Michel Xhaard
Copyright (C) 2006 Filip Zyzniewski <filip.zyzniewski@tefnet.pl> based on HP Jornada 56x touchscreen driver by Alex Lange <chicken@handhelds.org>
Copyright (C) 2005, 2006 David S. Miller <davem@davemloft.net>
Copyright (C) 2012-2013 Tieto Poland
Copyright 2010 Creative Product Design
Copyright (c) 2003-2004 Dmitry Torokhov
Copyright (c) 2017 Amlogic, inc. Author: Yixun Lan <yixun.lan@amlogic.com>
Copyright (C) 1999-2008, Greg Ungerer <gerg@snapgear.com>
Copyright 1997 Comtrol Corporation.
Copyright (C) 2003 Sylvain Munaut <tnt@246tNt.com> Kjell Claesson <keyson@users.sourceforge.net>
Copyright 2006 Felix Fietkau <nbd@openwrt.org>
Copyright 2008 Florian Fainelli <florian@openwrt.org>
Copyright 2017 Roman Yeryomin <roman@advem.lv>
Copyright (C) 2009, 2010 Paul Mundt
Copyright 2008 by Karsten Keil (kkeil@suse.de)
Copyright 2008 by Andreas Eversberg (jolly@eversberg.eu)
Copyright (C) 2015 John Crispin <john@phrozen.org>
Copyright (C) Ronen Shitrit <rshitrit@marvell.com>
Copyright (c) <2013-2014> Linaro Ltd. http://www.linaro.org
Copyright (C) 2016 Bryant G. Ly <bryantly@linux.vnet.ibm.com> IBM Corp.
Copyright (C) 2011 Taehun Kim <kth3321 <at> gmail.com>
Copyright (c) 2006 Willem Duinker v4l2 interface modeled after the V4L2 driver for SN9C10x PC Camera Controllers
Copyright (C) 2008, Robert Jarzmik <robert.jarzmik@free.fr>
Copyright NXP 2016
Copyright (C) 1994 by Hamish Macdonald Taken from linux/kernel/ptrace.c and modified for M680x0. linux/kernel/ptrace.c is by Ross Biro 1/23/92, edited by Linus Torvalds
Copyright (C) 2000, 1 Tim Waugh <twaugh@redhat.com> ##
Copyright (C) 2001 Simon Huggins ##
Copyright (C) 2005-2012 Randy Dunlap ##
Copyright (C) 2012 Dan Luedtke ##
Copyright (c) 2000 MontaVista Software, Inc. ##
Copyright (C) 2004 MontaVista Software Inc. Author: Manish Lachwani (mlachwani@mvista.com)
Copyright (c) 2017 Chao Yu <chao@kernel.org>
Copyright (C) 2005 Hans Verkuil <hverkuil@xs4all.nl> Cleanup
Copyright (C) 2009 Eduardo Moscoso Rubino <moscoso@TopoLogica.com>
Copyright IBM Corp. 2004 All Rights Reserved.\n" tape_class.c"
Copyright (c) 2014,2015, Linaro Ltd.
Copyright (c) 2001 Matthew Wilcox for Hewlett-Packard
Copyright (C) 2004-2006 Macq Electronique SA. (www.macqel.com)
Copyright (c) 2012 Benjamin Tissoires <benjamin.tissoires@gmail.com>
Copyright (c) 2010 Altera Corporation, San Jose, California, USA.
Copyright (c) 2010 Arrow Electronics, Inc.
Copyright (C) 2005 Gyorgy Jeney <nog@bsemi.com>
Copyright (C) 2007 Hewlett-Packard Development Company, L.P. Paul Moore <paul@paul-moore.com>
Copyright (c) 2007 Eurotech S.p.A. <info@eurotech.it>
Copyright(C) 2007 Rodolfo Giometti\n
Copyright (C) 2000 Deep Blue Solutions Ltd.

Copyright (C) 2002 RidgeRun, Inc.
Copyright (C) 2002-2003 MontaVista Software, Inc.
Copyright (C) 2004 Nokia Corporation by Tony Lindgren <tony@atomide.com>
Copyright (C) 2005 International Business Machines
copyright(c) Copyright 2001 Charles Howes <chowes@vsol.net>
Copyright (C) 2004-5 Patrick Boettcher (patrick.boettcher@posteo.de)
copyright (C) 2010 Novell. All rights reserved.
Copyright (c) 2008-2009, NVIDIA Corporation
Copyright (c) 2008 Simtec Electronics Ben Dooks <ben@simtec.co.uk>, <ben-linux@fluff.org>
Copyright (c) 2013 Tomasz Figa <tomasz.figa@gmail.com>
Copyright (c) 2017 Samsung Electronics Co., Ltd.
Copyright (c) 2008 Sascha Hauer <s.hauer@pengutronix.de>, Pengutronix
Copyright 2018 Ladislav Michl <ladis@linux-mips.org>
Copyright (c) 2011-2015 Stephan Brumme. All rights reserved. Slicing-by-16 contributed by Bulat Ziganshin
Copyright (c) 2007 Samuel Ortiz <samuel@sortiz.org> which is in turn partly based on the wireless netlink code:
Copyright 2006 Johannes Berg <johannes@sipsolutions.net>
Copyright (C) 2009-2010 Frederic Weisbecker <fweisbec@gmail.com>
Copyright (c) 2012-2018, The Linux Foundation. All rights reserved.
Copyright (C) 2013 Texas Instruments. Murali Karicheri <m-karicheri2@ti.com> Santosh Shilimkar <santosh.shilimkar@ti.com>
Copyright (C) 2006 Texas Instruments.
Copyright 2019 Linaro, Ltd., Rob Herring <robh@kernel.org>
Copyright(C) 1996, 2000 David S. Miller
Copyright (c) 2008-2009 Rodolfo Giometti <giometti@linux.it>
Copyright (c) 2008-2009 Eurotech S.p.A. <info@eurotech.it>
Copyright (c) 2005 Dan M. Smith, IBM Corporation
Copyright 2017 ZTE Corporation.
Copyright (C) 2003-2004 Dennis Noermann <dennis.noermann@noernet.de>
Copyright (c) 2016 Hisilicon Limited.
Copyright (C) 2012 Oracle Inc Author: Konrad Rzeszutek Wilk <konrad.wilk@oracle.com>
Copyright (c) 2004 Dmitry Torokhov
Copyright (c) 1998, 1999 Frodo Looijaard <frodol@dds.nl>
Copyright (c) 2003-2004 Jean Delvare <jdelvare@suse.de>
Copyright (c) 2005 Aspen Systems, Inc.
Copyright (c) 2006 Carsten Emde, Open Source Automation Development Lab
Copyright (c) 2007 Hans J. Koch, Linutronix GmbH
Copyright (C) 2007 - 2009 Shaohua Li <shaohua.li@intel.com>
Copyright (C) 2009 Rafael J. Wysocki <rjw@sisk.pl>, Novell Inc.
Copyright (C) 2011 - 2013 Samsung Electronics Co., Ltd. Author: Sylwester Nawrocki <s.nawrocki@samsung.com>
Copyright (c) 2006 Matt Callow
Copyright (C) 2008-2009, Red Hat Inc, Ingo Molnar <mingo@redhat.com>
Copyright (C) 2011, Red Hat Inc, Arnaldo Carvalho de Melo <acme@redhat.com>
Copyright (c) 2018 Vadim Pasternak <vadimp@mellanox.com>
Copyright (C) 2015 Andrej Krutak <dev@andree.sk>
Copyright (C) 2017 Hans P. Moller <hmoller@uc.cl>
Copyright (c) 2013 Synaptics Incorporated
Copyright (c) 2014 Benjamin Tissoires <benjamin.tissoires@gmail.com>
Copyright (c) 2014 Red Hat, Inc
Copyright (C) 1996, 97, 2001, 04 Ralf Baechle (ralf@linux-mips.org)
Copyright (C) 2005 Gilbert Wu <gilbert_wu@adaptecc.com>
Copyright 2001,2005, Scott J. Bertin <scottbertin@yahoo.com>
Copyright 2012 Stefan Roese <sr@denx.de>
Copyright (C) 2008 MIMOMax Wireless Ltd.
Copyright (c) 2010 Rafał Milecki <zajec5@gmail.com>
Copyright (C) Red Hat Inc., 2014. All rights reserved. Authors: Vivek Goyal <vgoyal@redhat.com>
Copyright (C) 2017 Jonathan Liu <net147@gmail.com>
Copyright (C) 2007 Mattia Dongili <malattia@linux.it>

LICENCE TERMS (cont.)

Copyright (c) 2016-2018 Christoph Hellwig. All Rights Reserved.
Copyright Motorola 1984 (!). It was written to be part of the Linux operating system.
Copyright (c) 2009, Shen Feng <shen@cn.fujitsu.com>
Copyright (c) 2018 Collabora Ltd.
Copyright (c) 2019 Arm Ltd.
Copyright © 2005 Agere Systems Inc. All rights reserved.
Copyright (C) 1998,1999 Kenneth Albanowski <kjahds@kjahds.com>, The Silver Hammer Group, Ltd.
Copyright (C) 2002 James Simmons
Copyright 2016-2017,2019 NXP
Copyright (C) 2011 Sascha Hauer, Pengutronix <s.hauer@pengutronix.de>
Copyright 2009-2013 Canonical Ltd.
Copyright (C) 2005 ARM Ltd.
Copyright (c) 2007 Larry Finger <Larry.Finger@lwfinger.net>
Copyright(C) 2006-2012 Patrick McHardy <kaber@trash.net>
Copyright (c) 2015, Sony Mobile Communications Inc.
Copyright (C) 2005 BULL SA.
Copyright (c) 2007 Ilyes Gouta. Based on the m5603x Linux Driver Project.
Copyright (c) 2005 m5603x Linux Driver Project <m5602@x3ng.com.br>
Copyright 2018, Michael Ellerman, IBM Corporation.
Copyright © YEAR YOUR NAME.
Copyright (c) 2011, 2012 Anssi Hannula <anssi.hannula@iki.fi>
Copyright (c) 2004 Torrey Hoffman <thoffman@arnor.net>
Copyright (c) 2002 Vladimir Dergachev
Copyright (c) 2003-2004 Paul Miller <pmiller9@users.sourceforge.net>
Copyright (c) 2007 allank
Copyright (c) 2004 Takashi Iwai <tiwai@suse.de>
Copyright (C) 2008-2009 Ralph Metzler <rjkm@metzlerbros.de>
Copyright (C) 2009 Janos Laube <janos.dev@gmail.com>
Copyright (C) 2009 Paulius Zaleckas <paulius.zaleckas@teltonika.lt> Based on SL2312 PCI controller code
Copyright(C) 2003
Copyright 2016 Icenowy Zheng <icenowy@aosc.xyz>
Copyright (C) 2016 Tomas Hlavacek <tmshlvkc@gmail.com>
copyright 2011-2014, ARM Ltd.
Copyright (C) 2014 Google, Inc
Copyright 2006 Hewlett-Packard Development Company, L.P.
Copyright (C) 2009 Eric Paris <Red Hat Inc> inotify was largely rewritten to make use of the fsnotify infrastructure
Copyright (c) 2006 Arnaldo Carvalho de Melo <acme@conectiva.com.br>
Copyright (c) 2004-2008 Reyk Floeter <reyk@openbsd.org>
Copyright (c) 2007-2008 Michael Taylor <mike.taylor@apprion.com>
Copyright (C) 1994 - 2000 Ralf Baechle
Copyright (C) 2006 Thomas Bogendoerfer
Copyright (C) 2004-2007 James Smart, Emulex Corporation Rewrite
Copyright (c) by Pavel Hofman <pavel.hofman@ivitera.com>
Copyright (c) <2013-2017> Linaro Ltd. http://www.linaro.org
Copyright (C) 2014 Huawei Ltd.
Copyright (c) 2018 Baylibre, SAS. Author: Jerome Brunet <jbrunet@baylibre.com>
Copyright (C) 2019 BayLibre, SAS Author: Neil Armstrong <narmstrong@baylibre.com>
Copyright (C) 2015 Imagination Technologies Author: Alex Smith <alex.smith@imgtec.com>
Copyright 2008 Freescale Semiconductor Inc. Port to powerpc added by Kumar Gala
Copyright (C) 2005, 2006 by Eric Van Hensbergen <ericvh@gmail.com>
copyright(C) 2003 Ardis Technologies <roman@ardistech.com>
Copyright (C) 1991-2018 Unicode, Inc. All rights reserved. Distributed
Copyright(C) 2003 Ardis Technologies <roman@ardistech.com>
Copyright(C) 2018 - 2019 Intel Corporation
copyright (C) 1996 okir@monad.swb.de
Copyright 2016-2018 Socionext Inc.
Copyright (C) 2016 Atmel Bo Shen <voice.shen@atmel.com>

Copyright (C) 2010-2011 Freescale Semiconductor, Inc. All Rights Reserved.
copyright (C) by Hannu Savolainen 1993-1996
Copyright (c) 1999, 2000 Silicon Graphics, Inc.
Copyright (C) 1997 Rudolf Koenig (rfkoenig@immd4.informatik.uni-erlangen.de)
Copyright (C) 1998, 1999 Brent Baccala (baccala@freesoft.org)
Copyright (C) 2008 Janne Grunau (j@jannau.net)
Copyright (C) 2008 John Poet
Copyright (C) 2001 Rusty Russell.
Copyright (C) 2007-2010 Florian Fainelli <florian@openwrt.org>
Copyright (C) 2005 Takahiro Hirofuchi names_deinit() is added.
Copyright (C) 2005-2006, Thomas Gleixner, Russell King
Copyright (C) 2003-2011 Jozsef Kadlecsik <kadlec@netfilter.org>
Copyright (C) 2015 Altera Corporation
Copyright (C) 2000, 2001, 2002, 2003, 2005 Maciej W. Rozycki
Copyright (C) 1998 Harald Koerfgen
Copyright (c) 2005 Giorgio Padrin <giorgio@mandarinlogiq.org>
Copyright (C) 2002-2011 Hugh Dickins.
Copyright (C) 2011 Google Inc.
Copyright (C) 2002-2005 VERITAS Software Corporation.
Copyright (C) 2004 Andi Kleen, SuSE Labs
Copyright (c) 2004, Luke Kenneth Casson Leighton <lkcl@lkcl.net>
Copyright (c) 2004 Red Hat, Inc., James Morris <jmorris@redhat.com>
Copyright (c) 2004, 2008 Matt Mackall <mpm@selenic.com>
Copyright (C) 2000, 2001 by Nicolas Pitre
Copyright (C) 2004-2012 Emulex. All rights reserved. * EMULEX and SLI are trademarks of Emulex. * www.broadcom.com *
Copyright (C) 2001 Tensilica Inc.
Copyright (c) 2007-2008 Jim Paris <jim@jtan.com> Added support RSX DMA Vivien Chappelier <vivien.chappelier@free.fr>
Copyright (c) 2009 LaCie
"Copyright Distributed Processing Technology, Corp. 140 Candace Dr. Maitland, Fl. 32751 USA Phone: (407) 830-5522 Fax: (407) 260-5366 All Rights Reserved "
Copyright IBM Corporation, 2007 Authors: Anthony Liguori <aliguori@us.ibm.com>
Copyright (C) 1998 Ralf Baechle
Copyright (c) 2006 Herbert Xu <herbert@gondor.apana.org.au>
Copyright (c) 2002 Kazunori Miyazawa <miyazawa@linux-ipv6.org> / USAGI
Copyright 2008 IBM Corp.
Copyright (c) 2018 Jonathan Marek <jonathan@marek.ca>
Copyright (C) 2009-2014 LGE, Inc.
Copyright (c) 2011 Samsung Electronics Co., Ltd.
Copyright (C) 1999 David Mosberger-Tang <davidm@hpl.hp.com>
Copyright (C) 2001,2004 Grant Grundler <grundler@parisc-linux.org>
Copyright (C) 2009 Vivek Goyal <vgoyal@redhat.com> Nauman Rafique <nauman@google.com>
Copyright (C) 2015 Paolo Valente <paolo.valente@unimore.it> Arianna Avanzini <avanzini.arianna@gmail.com>
Copyright (C) 2010 PMC-Sierra, Inc.
Copyright (C) 2008 Qumranet, Inc.
Copyright IBM Corporation, 2008
Copyright (C) 1996 David S. Miller (davem@davemloft.net)
Copyright (c) 2008 Atom Create Engineering Co., Ltd.
Copyright (c) 2006-2007 Freescale Semiconductor
Copyright (C) 2006 bplan GmbH
Copyright (C) 2004 Sylvain Munaut <tnt@246tNt.com>
Copyright (C) 2003 Montavista Software, Inc
Copyright (C) 2004 MontaVista Software Inc. Manish Lachwani, mlachwani@mvista.com
Copyright (C) 1994, 95, 99, 2003 by Ralf Baechle
Copyright (C) 1990 - 1992, 1999 Silicon Graphics, Inc.
Copyright (C) 2011 Wind River Systems, written by Ralf Baechle <ralf@linux-mips.org>

LICENCE TERMS (cont.)

Copyright (C) 2006-2008 Marvell International Ltd.
Copyright (C) 2008 Compulab Ltd.
Copyright (C) 2006 ST Microelectronics Ltd. (denorm support)
Copyright 2011-2012 Hauke Mehrrens <hauke@hauke-m.de>
Copyright 2014 Hans de Goede <hdegoede@redhat.com>
Copyright 1999 Gregory P. Smith
Copyright (C) Freescale Semiconductor, Inc 2004 Author: Andy Fleming
Copyright (C) 2001 RidgeRun, Inc. Greg Lonnon <glonnon@ridgerun.com>
Copyright (C) 2011 Becky Bruce, Freescale Semiconductor
Copyright 2017-2018 NXP Author: Dong Aisheng <aisheng.dong@nxp.com>
Copyright (c) 2006 Sam Leffler, Ermo Consulting
Copyright (c) 2007 Christoph Hellwig <hch@lst.de>
Copyright (c) 2008-2009 Weongyo Jeong <weongyo@freebsd.org>
Copyright (c) 2012 Pontus Fuchs <pontus.fuchs@gmail.com>
Copyright(c) 1999-2006 Intel Corporation"
Copyright (C) 2016 Shuah Khan <shuahkh@osg.samsung.com>
Copyright (C) 2006-2010 Nokia Corporation
Copyright (c) 2016 Intel Corporation.
Copyright (C) 2010 Broadcom
Copyright 2012 Marvell International Ltd.
Copyright (C) 2002 David S. Miller
Copyright (C) Pekka Pietikainen
Copyright (C) 2012 - Virtual Open Systems and Columbia University Authors: Rusty Russell <rusty@rustcorp.au>
Christoffer Dall <c.dall@virtualopensystems.com>
Copyright 2007-11 Wolfson Microelectronics, plc
Copyright (c) 2009 Daniel Ribeiro <drwyrn@gmail.com>
Copyright (c) 2003-2005 Motorola
Copyright 2008 by Karsten Keil <kkeil@novell.com>
Copyright (C) 2016 BayLibre, SAS. All rights reserved. Author: Neil Armstrong <narmstrong@baylibre.com>
Copyright (C) 2012 Linux Foundation
Copyright (C) 2010-2018 Red Hat, Inc. All rights reserved.
Copyright (C) 2005, 07 Ralf Baechle (ralf@linux-mips.org)
Copyright (C) 1993 Linus Torvalds
Copyright 2007 IBM Corporation Josh Boyer <jwboyer@linux.vnet.ibm.com>
Copyright(c) MontaVista, Software, Inc. This program is licensed "as is" without any warranty of any kind, whether express or implied.
Copyright (c) 2001-2003 International Business Machines, Corp.
Copyright (C) Hans-Joachim Hetscher DD8NE (dd8ne@bnv-bamberg.de)
Copyright (c) 2006 Carlos Munoz <carlos@kenati.com>
Copyright (C) 2016 Milo Kim <woogyom.kim@gmail.com>
Copyright (c) 2006 ARM Ltd.
Copyright (c) 2010 ST-Ericsson SA
Copyright 2008 Freescale Semiconductor Inc.
Copyright (C) 1999 MIPS Technologies, Inc.
Copyright (C) 2000 Ulf Carlsson
Copyright (c) 2008 Magnus Damm
Copyright (c) 2007 Ujjwal Pande <ujjwal@kenati.com>
Copyright (C) 2013 NVIDIA Corporation
Copyright (C) 2009 - 2013 NVIDIA Corporation
Copyright 2011,2012 Toradex Inc.
Copyright 2006 Openedhand Ltd.
Copyright (c) 2002-2005, Network Appliance, Inc. All rights reserved.
Copyright (c) 1999-2005, Mellanox Technologies, Inc. All rights reserved.
Copyright (c) 2005-2006 Intel Corporation. All rights reserved.
Copyright (C) 2004 Hong-Gunn Chew <hglinux@gunnet.org> and Jean Delvare <jdelvare@suse.de>
Copyright (c) 2009,2010 Rising Tide, Inc.
Copyright (c) 2009,2010 Linux-iSCSI.org

Copyright (c) 2009,2010 Nicholas A. Bellinger <nab@linux-iscsi.org>
Copyright (C) 2008-2009 Texas Instruments Inc
Copyright © 2012 Johannes Goetzfried Johannes.Goetzfried@informatik.stud.uni-erlangen.de>
Copyright (c) 2006, 2007 Cisco Systems. All rights reserved.
Copyright 2002 H. Peter Anvin
Copyright (c) 2016-2017, Dave Watson <davejwatson@fb.com>. All rights reserved.
Copyright (C) Tino Reichardt, 2012
Copyright (C) 2014 Regents of the University of California
Copyright (C) 2017 Cogent Embedded, Inc. <source@cogentembedded.com>
Copyright (c) 2012 Domintech Technology Co., Ltd
Copyright 2016-2017 Cisco Systems, Inc. and/or its affiliates. All rights reserved.
Copyright (C) 2015 Joachim Eastwood <manabian@gmail.com>
Copyright (C) 2008 SGI Christoph Lameter <cl@linux.com>
Copyright (c) 2007 - 2008 Jean Delvare <jdelvare@suse.de>
Copyright 2005: EMC Corporation, all rights reserved.
Copyright 2005 Red Hat, Inc. All rights reserved.
Copyright 2018 Mesih Kilinc <mesihkilinc@gmail.com>
Copyright (c) 2016 Herbert Xu <herbert@gondor.apana.org.au>
Copyright (C) 2008, Intel Corp. Author: Huang Ying <ying.huang@intel.com>
Copyright (C) 2004 Texas Instruments and
Copyright (C) by Kai Svahn <kai.svahn@nokia.com>
Copyright (C) 2005, 2006 Nokia Corporation
Copyright (C) 2014 by Maciej W. Rozycki
Copyright (c) 2015 Rockchip Electronics Co. Ltd. Author: Xing Zheng <zhengxing@rock-chips.com>
Copyright 2007, Red Hat Inc. Peter Zijlstra
Copyright (C) 2005-2007 Pierre Ossman, All Rights Reserved.
Copyright © 2002 Thomas Gleixner <gleixner@linutronix.de>
Copyright (c) 2004-2005, 2010-2011, Wind River Systems All rights reserved.
Copyright (C) 2010 Mike Christie
Copyright 2005 Simtec Electronics"
Copyright(c) 2013 - 2019 Intel Corporation."
Copyright (C) 2004 LynuxWorks, Inc., Igor Manylov, Bill Huey
Copyright (C) 2006 Esben Nielsen
Copyright (C) 2006 Kihon Technologies Inc., Steven Rostedt <rostedt@goodmis.org>
Copyright (c) 2002-2005 Richard Russon
Copyright (C) 2012-2013 NVIDIA CORPORATION. All rights reserved.
Copyright (C) 2003 Luis R. Rodriguez <mcgrof@ruslug.rutgers.edu>
Copyright (C) 2003 Aurelien Alleaume <slts@free.fr>
Copyright (C) 2005 Benjamin Herrenschmidt (benh@kernel.crashing.org) IBM, Corp.
Copyright (c) 2019 Zhou Yanjie <zhouyanjie@zoho.com>
Copyright (C) 2009 Motorola, Inc.
Copyright (c) 1999-2006 Intel Corporation."
copyright(c) SoL/IDER session is active
Copyright (C) 2001 Richard Zidlicky <rz@linux-m68k.org>
Copyright (c) 2010, Code Aurora Forum. All rights reserved.
Copyright (c) 2002 Intel Corp.
Copyright (C) 2006 Komal Shah <komal_shah802003@yahoo.com>
Copyright (c) 2007-2008 Intel Corporation. All rights reserved.
Copyright 2010 Cavium Networks
Copyright 2017 Free Electrons
Copyright 2003 Rick Bronson
Copyright 2001 Thomas Gleixner (gleixner@autronix.de)
Copyright 2000 Steven J. Hill (sjhill@cotw.com)
Copyright 2007
Copyright 2006 ATMEL Rousset, Lacrosonniere Nicolas
Copyright 2012 ATMEL, Hong Xu
Copyright 2013 ATMEL, Josh Wu (josh.wu@atmel.com)

LICENCE TERMS (cont.)

Copyright (C) 2003 Krzysztof Halasa <khc@pm.waw.pl>\n"
Copyright (C) Carnegie Mellon University
Copyright (C) 2017 Marcus Cooper <codekipper@gmail.com>
Copyright (C) 2015-2017 Glider bvba
Copyright (C) 1995 - 2000 by Ralf Baechle
Copyright (C) 2014 by Renesas Electronics Corporation
Copyright (C) 2011-2012 Texas Instruments, Inc.
Copyright (C) 2005 Ilya A. Volynets (Total Knowledge)
Copyright (c) 2009 Bob Copeland <me@bobcopeland.com>
Copyright (C) 2001, 2004-2005 Intel Corp Rohit Seth <rohit.seth@intel.com> Suresh Siddha <suresh.b.siddha@intel.com> Gordon Jin <gordon.jin@intel.com> Ashok Raj <ashok.raj@intel.com>
Copyright (c) 2010-2012 Broadcom. All rights reserved.
Copyright (C) 2003 by Ralf Baechle
Copyright (C) 2010 Ericsson AB.
copyright (c) 2002 Romain Lievin <roms@lpg.ticalc.org>.\n" Based on the source code from Roman Zippel.\n"
Copyright 2004 James Cleverdon, IBM.
Copyright(c) 1995 Alan Cox, Building #3 <alan@redhat.com>
Copyright(c) 1998-99, 2000 Ingo Molnar <mingo@redhat.com>
Copyright(c) 2002,2003 Andi Kleen, SuSE Labs.
Copyright (c) 2004 Amstrad Plc
Copyright (C) 2001 RidgeRun, Inc.
Copyright (c) 2003-2008 Herbert Xu <herbert@gondor.apana.org.au>
Copyright (C) 2004 MontaVista Software Inc. Author: Manish Lachwani, mlachwani@mvista.com
Copyright (C) 2004 Hidetoshi Seto <seto.hidetoshi@jp.fujitsu.com>
Copyright (C) 2005 Silicon Graphics, Inc
Copyright (C) 2005 Keith Owens <kaos@sgi.com>
Copyright (C) 2006 Russ Anderson <rja@sgi.com>
Copyright (c) 2016 Akinobu Mita <akinobu.mita@gmail.com>
Copyright (C) 2010-2017 Intel Corporation. All rights reserved.
Copyright (c) 2010 Silicon Hive www.siliconhive.com.
Copyright (c) 2003 Pavel Machek
Copyright (c) 2005 Mellanox Technologies Ltd. All rights reserved.
Copyright (c) 2014,2018 Intel Corporation. All rights reserved.
Copyright (C) 2007-2015 Emulex. All rights reserved. * EMULEX and SLI are trademarks of Emulex. * www.broadcom.com *
Copyright (C) 2008 Sascha Hauer, Pengutronix <s.hauer@pengutronix.de>
Copyright 2009 Alberto Panizzo <maramaopercheseimorto@gmail.com>
Copyright (C) 2002, 2003, 2005 Ilya A. Volynets
Copyright (C) 2006 Ralf Baechle <ralf@linux-mips.org>
Copyright (C) 2012-2013 Linaro Ltd.
Copyright (C) 1999-2005 - Karim Yaghmour (karim@opersys.com)
Copyright (c) 2003-2004 Greg Kroah-Hartman
Copyright (c) 2003-2004 IBM Corp.
Copyright (C) 2008, 2009 Wind River Systems written by Ralf Baechle <ralf@linux-mips.org>
Copyright (C) 2013 Regents of the University of California
Copyright (c) 2015 Samsung Electronics Authors: Jaegeuk Kim <jaegeuk@kernel.org> Chao Yu <chao2.yu@samsung.com>
Copyright (C) 2007 Aurelien Jarno <aurelien@aurel32.net>
Copyright (C) 2010-2012 Hauke Mehrtens <hauke@hauke-m.de>
Copyright (C) 2009 IXXAT Automation, GmbH
Copyright (C) 2009, 2010, 2011 Red Hat, Inc.
Copyright (C) 2009, 2010, 2011 Amit Shah <amit.shah@redhat.com>
Copyright © 2009-2015 VMware, Inc., Palo Alto, CA., USA All Rights Reserved.
Copyright (c) 2016, General Electric Company
Copyright (c) 2014 Christian Gmeiner <christian.gmeiner@at> gmail.com>
"Copyright: 2011 Azimut Ltd. <http://azimutrzn.ru/> "
Copyright (C) 2016 Intel Deutschland GmbH
Copyright (c) 2017 Takashi Iwai <tiwai@suse.de>
Copyright (C) 2008 Paul Hays <Paul.Hays@cattail.ca>
Copyright (C) 2008-2009 Ira W. Snyder <iws@ovro.caltech.edu>
Copyright (C) 2012 Lothar Felten <l-felten@ti.com> Thanks to Jan Volkering
Copyright (c) 2011 Samsung Electronics Co., Ltd. http://www.samsung.com
Copyright (c) 2008 Fabio Belavenuto <belavenuto@gmail.com>
COPYRIGHT (c) 2013, Intel Corporation.
Copyright (c) 2006 Jiri Kosina
Copyright (c) 2007-2008, Realsil Wlan\n
Copyright rtl8192_proc_module_init()
Copyright return usb_register(&rtl8192_usb_driver)
Copyright (C) 2008 Wind River Systems, Inc. written by Ralf Baechle <ralf@linux-mips.org>
Copyright (C) 2010, Paul Cercueil <paul@crapouillou.net> JZ4740 SoC RTC driver
Copyright (C) 2010, Guennadi Liakhovetski <g.liakhovetski@gmx.de>
Copyright 2005-2006 Red Hat Inc, all rights reserved.
Copyright (C) 2014 Renesas Electronics Inc. Author: Laurent Pinchart <laurent.pinchart@ideasonboard.com>
Copyright(c) container_of(c, struct usb_dmac_chan, vc.chan)
"Copyright (c) 2000 Randy Dunlap <rdunlap@xenotime.net>"
"Copyright (c) 2001 Pete Zaitcev <zaitcev@redhat.com>"
"Copyright (c) 2001 David Paschal <paschal@rcsis.com>"
"Copyright (c) 2006 Oliver Neukum <oliver@neukum.name> "
"Copyright (c) 2007,2008 Dmitry Baryshkov "
Copyright (c) 2012-2013 by Tensilica Inc
Copyright (c) 2002 Monta Vista Software, Inc.
"Copyright 2007 Johannes Berg <johannes@sipsolutions.net> "
Copyright (c) 2002, 2003, 2004 Paul Mundt <lethal@linux-sh.org>
Copyright (c) 2010 Linux-iSCSI.org
"Copyright (C) 2015 Intel Deutschland GmbH "
Copyright (C) 2009 Frederic Weisbecker
Copyright (C) 2009 Jon Smirl, Digispaker
Copyright (C) 2005-2007 by Texas Instruments
Copyright (C) 2011-2012 NVIDIA CORPORATION. All Rights Reserved.
Copyright (c) 2018 FriendlyElec Computer Tech. Co., Ltd. http://www.friendlyarm.com)
Copyright (C) 2005 Hans Verkuil <hverkuil@xs4all.nl> Cleanup V4L2 API update sound fixes
Copyright (C) 2007 Maciej W. Rozycki
Copyright (C) 2014, Imagination Technologies Ltd.
Copyright (C) 2004 - 2010 Ivo van Doorn <IvDoorn@gmail.com>
Copyright (C) 2004 - 2009 Gertjan van Wingerde <gwingerde@gmail.com> http://rt2x00.serialmonkey.com>
Copyright 2010 ARM Ltd. remark Read the file COPYING
Copyright (c) 2014 Scott Feldman <sfeldma@gmail.com>
Copyright (C) 2012 ARM Limited
Copyright (C) 2005-8 Patrick Boettcher <pb@linuxtv.org>
Copyright (c) 2009-15 Advanced Micro Devices, Inc.
Copyright (C) 2008 Wolfgang Grandegger <wg@grandegger.com>
Copyright (c) 2015, Intel Corporation.
Copyright (C) 2012 Google Finland Oy.
Copyright (C) 1999, 2001 Ralf Baechle (ralf@gnu.org)
Copyright (C) 2008 Jordan Crouse <jordan@cosmicpenguin.net>
Copyright (C) 2008 Hans de Goede <hdegoede@redhat.com>
Copyright (C) 2009 Jean Delvare <jdelvare@suse.de>
Copyright 2013 IBM Corporation
Copyright (C) 2003-2004 Ken Chen <kenneth.w.chen@intel.com>
Copyright (C) 2012-2013 Altera Corporation <www.altera.com>
Copyright 2012 Intel Corporation
Copyright (c) 2012 Aeroflex Gaisler AB. Author: Andreas Larsson <andreas@gaisler.com>
Copyright (C) 2012 Robin Gareus <robin@gareus.org>
Copyright (C) 2012 Damien Zammit <damien@zamaudio.com>

LICENCE TERMS (cont.)

Copyright (C) 2007 Ralf Baechle <ralf@linux-mips.org>
Copyright (C) 2007 MIPS Technologies, Inc. written by Ralf Baechle <ralf@linux-mips.org>
Copyright (c) 2009 Mauro Carvalho Chehab
Copyright (C) 2006 Ralf Baechle (ralf@linux-mips.org)
Copyright (C) 2006-2014 Michael Krufky <mkrufky@linuxtv.org> based on nxt2002 by Taylor Jacob <rtjacob@earthlink.net> and nxt2004 by Jean-Francois Thibert <jeanfrancois@sagetv.com>
Copyright (C) 2008 Filip Aben <f.aben@option.com> Denis Joseph Barrow <d.barow@option.com> Jan Dumon <j.dumon@option.com>
Copyright (C) 2009, 2010 Intel Corp Russ Gorby <russ.gorby@intel.com>
Copyright (C) 2005 Peter Fuerst (pf@net.alphadv.de)
Copyright (C) 2009 Konstantin Dimitrov.
Copyright (C) 2004, 2005 Ralf Baechle
Copyright (c) Mathias Krause <minipli@googlegmail.com>
Copyright 2007 Pierre Ossman
Copyright 2006 Tejun Heo <teheo@novell.com>
Copyright (C) 1999 David S. Miller (davem@redhat.com)
Copyright 2017-2018 NXP Anson Huang <Anson.Huang@nxp.com>
Copyright (C) 2015 Jan Henrik Weinstock <jan.weinstock@rwth-aachen.de>
Copyright (C) 2019 Jeroen Hofstee <jhofstee@victronenergy.com>
Copyright (c) 2005 Arnaldo Carvalho de Melo <acme@mandriva.com>
Copyright (C) 1998-2000 Jens Axboe <axboe@suse.de>
Copyright (C) 2011-2013 Freescale Semiconductor, Inc.
Copyright (C) 2008-2011 Red Hat, Inc., Ingo Molnar
Copyright (C) 2008-2011 Red Hat, Inc., Peter Zijlstra
Copyright © 2009 Paul Mackerras, IBM Corp. <paulus@au1.ibm.com>
Copyright (C) 1999, 2000 Ingo Molnar, Red Hat
Copyright (c) 2002-2003, Jouni Malinen <j@w1.fi>
Copyright (C) 2006 Michael Ellerman, IBM Corporation
Copyright (C) 2013-2019 Wolfram Sang <wsa@the-dreams.de>
Copyright (c) 2011-2014, 2016 Qualcomm Atheros, Inc.
Copyright 2007-2008 Freescale Semiconductor, Inc.
Copyright 2008-2010 Simtec Electronics Ben Dooks <ben@simtec.co.uk> <http://armlinux.simtec.co.uk/>
Copyright (C) 2017 NXP. Robin Gong <yibin.gong@freescale.com>
Copyright (c) 2017-2019, Linaro Ltd.
Copyright (C) 2009 Sascha Hauer (kernel@pengutronix.de)
Copyright (C) 2016 - 2017 Intel Deutschland GmbH
Copyright (c) 2018 Vadim Pasternak <vadimp@mellanox.com>
Copyright (C) 2016 Sang Engineering
Copyright (C) 1999, 2000 Jeff Wiedemeier
Copyright (C) 2013 Texas Instruments Incorporated - <http://www.ti.com/> Author: Tomi Valkeinen <tomi.valkeinen@ti.com>
Copyright (c) 2015, Google Inc.
Copyright (C) 2005 Benjamin Herrenschmidt <benh@kernel.crashing.org>, IBM Corporation
Copyright (C) 2001 Mike Corrigan & Dave Engebretsen, IBM Corporation
Copyright © 2013 Alistair Popple IBM Corporation
Copyright (C) Ashok Raj <ashok.raj@intel.com>
Copyright (C) Shaohua Li <shaohua.li@intel.com>
Copyright (C) 2009-2011 Marek Vasut <marek.vasut@gmail.com>
Copyright (c) 2006-2007 Nick Kossifidis <mickflemm@gmail.com>
Copyright 2011 Freescale Semiconductor, Inc.
Copyright(c) 2019 Intel Corporation
Copyright(c) 2019 Intel Corporation All rights reserved.
Copyright (C) Semihalf 2009
Copyright (C) Ilya Yanok, Emcraft Systems 2010
Copyright (C) Alexander Popov, Promcontroller 2014
Copyright (C) Mario Six, Guntermann & Drunck GmbH, 2016
Copyright (C) 2000 David Gibson, Linuxcare Australia. With some help from :

Copyright (C) 2001 Jean Tourrilhes, HP Labs
Copyright (C) 2001 Benjamin Herrenschmidt
Copyright (c) 2000 Ericsson Radio Systems AB.
Copyright (c) 2001-2005 Greg Ungerer (gerg@snapgear.com)
Copyright (c) 2004-2006 Macq Electronique SA.
Copyright (C) 2010-2011 Freescale Semiconductor, Inc.
Copyright (C) 2016 - 2018 Linaro Ltd <ard.biesheuvel@linaro.org>
Copyright (C) 2012 Renesas Solutions Corp.
Copyright (c) 2005, Wind River Systems All rights reserved.
Copyright (C) 2004-2007 Jean Delvare <jdelvare@suse.de> Ported to Linux 2.6 by Gabriele Gorla <gorlik@yahoo.com> and Jean Delvare
Copyright (C) 2008 Cezary Jackiewicz cezary.jackiewicz (at) gmail.com>, based on MSI driver
Copyright (C) 2003, Duncan Sands, SolNegro, Josep Comas
Copyright (C) 2004, David Woodhouse
Copyright (C) 2011-2013 Renesas Solutions Corp.
Copyright (C) 2013 Cogent Embedded, Inc., <source@cogentembedded.com>
Copyright (C) 2004 Matthias Badaire
Copyright (C) 2006 Ian Armstrong <ian@iarmst.demon.co.uk>
Copyright (C) Jean-Francois Moine (<http://moinejf.free.fr>)
Copyright (C) 2014 Philipp Zabel, Pengutronix
copyright (C) 2005, Chuck Lever <cel@netapp.com>
Copyright(c) 2016 Linaro Ltd. All rights reserved.
Copyright (C) 2016 Advanced Micro Devices, Inc. Authors: Gustavo Padovan <gustavo@padovan.org> Christian König <christian.koenig@amd.com>
Copyright (C) 2009 PetaLogix. All rights reserved.
Copyright (C) 2017 - 2018 Sandvik Mining and Construction Oy
Copyright (C) 2015 Cogent Embedded, Inc.
Copyright (C) 2009 - 2010 Bart Van Assche <bvanassche@acm.org>.
Copyright (C) 2008 Simtec Electronics <ben-linux@fluff.org>
Copyright (C) 2007 Intel Corp Fenghua Yu <fenghua.yu@intel.com> Add multiple ptc.g/ptc.ga instruction support in global tlb purge.
copyright(c) Philip Blundell, 1998-1999
Copyright (C) 2006-7 Jonathan Corbet <corbet@lwn.net>
Copyright (C) 2016, Synopsys, Inc.
Copyright (c) by Jaroslav Kysela <perex@perex.cz>
Copyright 2007 Raymarine UK, Ltd. All Rights Reserved. Written under contract by: Chris Elston, Katalix Systems, Ltd.
Copyright (C) 1995 - 2000, 01, 03 by Ralf Baechle
Copyright 2013 Google, Inc
Copyright (C) 2007,2008,2009 Albert Herranz
Copyright 2005 Thomas Hellstrom. All Rights Reserved.
Copyright © 1999-2010 David Woodhouse <dwmw2@infradead.org>
Copyright © 2002-2003 Greg Ungerer <gerg@snapgear.com>
Copyright © 2002-2003 SnapGear Inc
Copyright (C) 1997, 1999 Jakub Jelinek (jj@ultra.linux.cz)
Copyright 2015 Nuvoton Technology Corp. Co-author: Meng-Huang Kuo <mhkuo@nuvoton.com>
Copyright (C) 2010 IBM Corporation
Copyright (C) 2002, 2003, 2004, 2005 Maciej W. Rozycki
Copyright (C) 2017 Cadence Design Systems, Inc.
Copyright(C) 2011 Omnibond Systems
Copyright (C) 2013, Obsidian Research Corp. Jason Gunthorpe <jgunthorpe@obsidianresearch.com>
Copyright (C) 2011-2013 Stephane Grosjean <s.grosjean@peak-system.com>
Copyright (C) 1993, 1994, 1995, 1999 Eric Youngdale
Copyright (C) 1992 Drew Eckhardt Linux scsi disk driver by Drew Eckhardt <drew@colorado.edu>
Copyright SysKonnect 1998,1999.
Copyright © 2004-2010 David Woodhouse <dwmw2@infradead.org>
Copyright © 2004 Ferenc Havasi <havasi@inf.u-szeged.hu>, University of Szeged, Hungary

LICENCE TERMS (cont.)

Copyright (C) 2002 SGI - Silicon Graphics, Inc <linux-xfs@oss.sgi.com>
Copyright (C) 2004-2011 Nokia Corporation
Copyright (C) 2013 Advanced Micro Devices, Inc.
Copyright (c) 2018 Martin Blumenstingl <martin.blumenstingl@googlemail.com>
Copyright (C) 1998-99 Frodo Looijaard <frodol@dds.nl>
Copyright (C) 2010 Juergen Beisert, Pengutronix
Copyright (C) 2008-2009 Freescale Semiconductor, Inc. All Rights Reserved.
Copyright (C) 2008 Embedded Alley Solutions, Inc All Rights Reserved.
Copyright (C) 1992,1993 Brad McLean brad@saturn.gaylord.com or brad@bradpc.gaylord.com.
Copyright 2011 Freescale Semiconductor, Inc. All Rights Reserved.
Copyright(c) Copyright 2000 Grant Grundler
Copyright(c) Copyright 2000 Philipp Rumpf <prumpf@tux.org>
Copyright(c) Copyright 2000 John Marvin
Copyright (c) 2015 Jaegeuk Kim <jaegeuk@kernel.org>
Copyright (c) 2003-2004 Greg Kroah-Hartman <greg@kroah.com>
Copyright (C) 2010 Jason Wang <jason77.wang@gmail.com>
Copyright (c) 2006 Hartmut Birr (e9hack at gmail dot com)
Copyright (C) 1999 Convergence Integrated Media GmbH <ralph@convergence.de>
Copyright (C) 2003 Megasolution Inc. <matsu@megasolution.jp>
Copyright(c) 2009 Intel Corporation
Copyright 2009 Krzysztof Helt <krzysztof.h1@wp.pl>
Copyright (C) 2010 Dan Williams <dcbw@redhat.com>
Copyright 2019 Purism SPC
Copyright (C) 2001, 2006, 2008 MontaVista Software, <source@mvista.com> Copied and modified Carsten Langgaard's time.c
Copyright 2003-2009 Red Hat Inc. All Rights Reserved.
Copyright 2005 Andi Kleen, SUSE Labs.
Copyright 2007 Jiri Kosina, SUSE Labs.
Copyright 2010-2012 Hauke Mehrtens <hauke@hauke-m.de>
Copyright (c) 2000-2004 by David Brownell
Copyright (C) 2007-2010 Nokia Corporation
Copyright (c) 2001, 2007 Johann Deneux <johann.deneux@gmail.com>
Copyright (C) 1997-2002 Russell King
Copyright 1997 -- 2000 Martin Mares <mj@ucw.cz>
Copyright 1998-2001 by Jes Sorensen, <jes@trained-monkey.org>.
Copyright (C) 1997, 1998, 1999, 2000 Ralf Baechle
Copyright (C) 2016-2017 Renesas Electronics Corp.
Copyright (c) 2014 Takashi Sakamoto <o-takashi@sakamocchi.jp>
Copyright (C) 2016 Tony Lindgren <tony@atomide.com>
Copyright (C) 2015, Intel Corporation. All rights reserved.
Copyright (C) 2005 Mike Christie
Copyright (c) 2005, 2006 Voltaire, Inc. All rights reserved.
Copyright (c) 2013-2014 Mellanox Technologies. All rights reserved. maintained by openib-general@openib.org
Copyright (C) 2003 Richard Curnow <richard.curnow@superh.com>
Copyright (C) 2000 - 2001 by Silicon Graphics, Inc.
Copyright (C) 2000, 2001, 2002 Ralf Baechle
Copyright (C) 2000, 2001 Broadcom Corporation
Copyright (C) 1998, 1999, 2000 Harald Koerfgen
Copyright (C) 1998 Gleb Raiko & Vladimir Roganov
Copyright (C) 2001, 2004, 2007 Maciej W. Rozycki
Copyright (C) 1995 Waldorf Electronics
Copyright (C) 1994, 95, 96, 97, 98, 99, 2000, 01, 02, 03 Ralf Baechle
Copyright (C) 1996 Stoned Elipot
Copyright (C) 2000, 2001, 2002, 2007 Maciej W. Rozycki
Copyright(c) 2014 Intel Mobile Communications GmbH
Copyright(C) 2018 - 2019 Intel Corporation All rights reserved.
Copyright (c) 2014 Stefan Roese <sr@denx.de>

Copyright (c) 2018, NVIDIA CORPORATION. All rights reserved.
Copyright (C) 2013 Cogent Embedded, Inc.
Copyright (C) 2015 Ulrich Hecht
Copyright (C) 2011 Renesas Solutions Corp.
Copyright 2008 Jon Loeliger, Freescale Semiconductor, Inc.
Copyright (c) 2011 Yu Ke ke.yu@intel.com
Copyright (c) 2010-2013 Benjamin Tissoires <benjamin.tissoires@gmail.com>
Copyright (c) 2012-2013 Red Hat, Inc
Copyright (c) 2010 Stephane Chatty <chatty@enac.fr>
Copyright (c) 2010 Henrik Rydberg <rydberg@euromail.se>
Copyright (c) 2010 Canonical, Ltd.
Copyright (c) 2009-2010 Stephane Chatty <chatty@enac.fr>
Copyright (C) 2009
Copyright (C) 2001,2002 Richard Russon <ldm@flatcap.org>
Copyright (C) 2001,2002 Jakob Kemi <jakob.kemi@telia.com>
Copyright (C) 2015 Andrew Lutomirski
copyright find . -type f ! -path './DEBIAN/*' -printf "%P0' \ xargs -r0 md5sum > DEBIAN/md5sums"
Copyright (C) 2012 Tomasz Figa <tomasz.figa@gmail.com>
Copyright (C) 2010 - 2012 Samsung Electronics Co., Ltd.
Copyright (C) 2013 Samsung Electronics Co., Ltd. Author: Sylwester Nawrocki <s.nawrocki@samsung.com>
Copyright (C) 2011-2012 LAPIS SEMICONDUCTOR Co., LTD.
Copyright 2006 IBM Corp., Christian Krafft <krafft@de.ibm.com>
Copyright (c) 2012 Sony Mobile Communications AB
Copyright (C) 2005 Khalid Aziz <khalid.aziz@hp.com>
Copyright (C) 2005 Intel Corp, Zou Nan hai <nanhai.zou@intel.com>
Copyright 2009 Semihalf.
Copyright (c) 2006, Rik Snel <rsnel@cube.dyndns.org>
Copyright (C) 2007 Conexant Systems, Inc.
Copyright (C) 2001 Intersil Americas Inc.
Copyright (C) 2005 Nokia Corporation (taken from islsm_pda.h) */
Copyright (c) 2004,2006 Simtec Electronics Ben Dooks, <ben@simtec.co.uk> http://armlinux.simtec.co.uk/
Copyright (C) 2002 Ralf Baechle
Copyright (C) 2010-2012 - NVIDIA, Inc.
Copyright (C) 2011 The AC100 Kernel Team <ac100@lists.lauchpad.net>
Copyright 2007 Wolfson Microelectronics PLC.
Copyright 2017 Google LLC
Copyright (C) 2002 STMicroelectronics
Copyright Linas Vepstas <linas@austin.ibm.com> 2007
Copyright 2008 Michael Ellerman, IBM Corporation.
Copyright (C) 1996 Paul Mackerras and Mark Abene.
Copyright (C) 1999 Niibe Yutaka
Copyright (c) 2001 Nokia, Inc.
Copyright (Computer Programs) Regulations 1992 (S.I. 1992 No.3233).
Copyright (c) 2001-2002 Intel Corp.
Copyright (C) 2019 Christoph Hellwig
Copyright 2017~2020 NXP
Copyright (C) 2010 Steffen Klassert <steffen.klassert@secunet.com>
"Copyright 2006-2010 Johannes Berg <johannes@sipsolutions.net">
Copyright 2013-2014 Intel Mobile Communications GmbH
Copyright (C) 2012 Canonical Ltd Authors: Rob Clark <robdclark@gmail.com> Maarten Lankhorst <maarten.lankhorst@canonical.com>
Copyright (C) 2006-2007 Hans Verkuil <hverkuil@xs4all.nl>
Copyright (C) 2002 Russell King.
Copyright (C) 2008, 2009 Nobuhiro Iwamatsu <iwamatsu.nobuhiro@renesas.com>
Copyright (C) 2014, Sebastian Andrzej Siewior <bigeasy@linutronix.de>
Copyright (c) 2015-2018 Terry Junge <terry.junge@plantronics.com>
Copyright(c) 2004 Olivier Gournet <ogournet@anevia.com> & Andrew de Quincey <adq_dvb@lidskialf.net>

LICENCE TERMS (cont.)

Copyright 2008 Johannes Berg <johannes@sipsolutions.net>
Copyright (C) 2002 Toshinobu Sugioka
Copyright (C) 2002 Deep Blue Solutions Ltd.
Copyright 2012 Advanced Micro Devices, Inc., Robert Richter
Copyright (C) 2007 Texas Instruments
Copyright (C) 2016 Pavel Machek <pavel@ucw.cz>
Copyright 2006 Applied Micro Circuits Corporation
COPYRIGHT (C) 2005 SYNOPSIS, INC. ALL RIGHTS RESERVED
copyright (C) 2005 SYNOPSIS, INC. ALL RIGHTS RESERVED
Copyright (c) 2017 Andreas Färber
Copyright 2018 NXP Semiconductors
Copyright 2006, Michael Buesch <m@bues.ch>
Copyright (c) 2016 Endless Computers, Inc. Author: Carlo Caione <carlo@endlessm.com>
Copyright (c) 2016 BayLibre, SAS. Author: Neil Armstrong <narmstrong@baylibre.com>
Copyright (C) 2006 Michael Buesch <m@bues.ch>
Copyright (C) 2010 Waldemar Brodkorb <wbx@openadk.org>
Copyright (c) 2002 International Business Machines, Corp.
Copyright (c) 2005-2006, 2010-2014, Wind River Systems All rights reserved.
Copyright 2016 by Gaurav Minocha
Copyright (C) 2000 Franz Sirl.
Copyright 2017-2018 NXP Dong Aisheng <aisheng.dong@nxp.com>
Copyright (c) 2013 U-MoBo Srl Pierluigi Passaro <p.passaro@u-mobo.com> sx8650.c
Copyright (c) 2009 Wayne Roberts tsc2007.c
Copyright (c) 2008 Kwangwoo Lee ads7846.c
Copyright (C) 2008, Florian Fainelli <florian@openwrt.org>
Copyright (c) 2009 STMicroelectronics Limited Author: Stuart Menefy <stuart.menefy:st.com>
Copyright (C) 2006 Alan Cox
Copyright (C) 2009-2010 Gustavo F. Padovan <gustavo@padovan.org>
Copyright (C) 2010 Google Inc.
Copyright (C) 2014 Christoph Hellwig
Copyright (C) 2014 Thomas Petazzoni <thomas.petazzoni@free-electrons.com> Based on the board file arch/arm/mach-orion5x/lsmiini-setup.c,
Copyright (C) 2008 Alexey Kopytko <alexey@kopytko.ru>
Copyright (C) 2013-2015 NVIDIA CORPORATION, All rights reserved.
Copyright (C) 2011,2012 Renesas Solutions Corp.
Copyright (c) 2017 Roopa Prabhu <roopa@cumulusnetworks.com>
Copyright (C) 1998 Kenneth Albanowski <kjahds@kjahds.com>, The Silver Hammer Group, Ltd.
Copyright (C) 2005 Ralf Baechle <ralf@linux-mips.org>
Copyright (C) 2016 Mylene Josserand <mylene.josserand@free-electrons.com>
Copyright (C) 2007 Dmitri Vorobiev <dmitri.vorobiev@gmail.com>
Copyright 2007 Oliver Jowett <oliver@opencloud.com>
Copyright 2005-2006 Openedhand Ltd. Author: Richard Purdie <rpurdie@openedhand.com>
Copyright(C) Copyright David Gibson, IBM Corp. 2001-2003.
Copyright (c) 2014 Gabriele Mazzotta <gabriele.mzt@gmail.com>
Copyright (c) 2014 Pali Rohár <pali.rohar@gmail.com>
Copyright (c) 2017 Dell Inc.
Copyright (C) 2002-2005 by David Brownell
Copyright (c) 1998, 1999 Frodo Looijaard <frodol@dds.nl> and Philip Edelbrock <phil@netroedge.com>
Copyright (C) 2008 by Sascha Hauer <kernel@pengutronix.de>
Copyright (C) 2006-2007 Renesas Solutions Corp.
Copyright (C) 2006-2010 Paul Mundt
Copyright (C) 1999 - 2001 Kanoj Sarcar
Copyright (c) 2011 Neratec Solutions AG
Copyright: 1991 - 2018 Linus Torvalds and others.
Copyright: (C) 2017 Himanshu Jha Comments:
Copyright © 2006 David Woodhouse <dwmw2@infradead.org>
Copyright (c) 2018 Guenter Roeck
Copyright (C) 2004-2007 Greg Kroah-Hartman <greg@kroah.com>
Copyright (C) Freescale Semicondutor, Inc. 2007, 2008.
Copyright (C) Alexander Popov, Promcontroller 2014
Copyright 2020 NXP, Peng Fan <peng.fan@nxp.com>
Copyright (C) 2007, 2014 Maciej W. Rozycki
"Copyright (C) 2000-2001 Greg Kroah-Hartman (greg@kroah.com)"
Copyright (C) 2010 Johan Hovold (jhovold@gmail.com)
Copyright (C) 2002 - 2008 Paul Mundt
Copyright (C) 2002 M. R. Brown
Copyright (C) 2004 by Christoph Hellwig <hch@lst.de>
Copyright (C) 2003, 2004 gcs - Global Communication & Services GmbH. and Department of Scientific Computing Paris Lodron University of Salzburg. Hilmar Linder <hlinder@cosy.sbg.ac.at> and Wolfram
Copyright (C) 2016 PEAK System-Technik GmbH
Copyright (C) 2001 Anton Blanchard <anton@au.ibm.com>, IBM
Copyright (C) 2002 Dave Engebretsen <engebret@us.ibm.com>, IBM Rework to support virtual processors
Copyright (C) 1999, 2001 Silicon Graphics, Inc.
Copyright (C) 1995, 1996, 1997, 1998 David S. Miller (davem@redhat.com)
"Copyright (C) 1995, 1996, 1997, 1998 Jakub Jelinek (jj@ultra.linux.cz) "
Copyright (c) 2004, Steven Smith
Copyright (C) Srinivasa Thirumalachar <sprasad@enr.sgi.com>
Copyright (C) Russ Anderson <rja@sgi.com>
Copyright (c) 2018, Intel Corporation.
Copyright (C) 2004 Clemens Fruhwirth <clemens@endorphin.org>
Copyright (C) 2006-2017 Red Hat, Inc. All rights reserved.
Copyright (C) 2013-2017 Milan Broz <gmazyland@gmail.com>
Copyright (c) 2011 ST Microelectronics (Alessandro Rubini, Davide Ciminaghi)
Copyright: (C) 2010 Gilles Muller, INRIA/LiP6. URL: http://coccinelle.lip6.fr/ Comments: -I ... -all_includes can give more complete results Options:
Copyright (C) 2004 - 2007 Jeff Dike (jdike@{addtoit,linux.intel}.com)
copyright (c) 1997-2003 Jean Tourrilhes jt@hpl.hp.com>
copyright (c) Alan Cox
"copyright ""Copyright(c) 2003-2006 Intel Corporation""
Copyright (c) 2004 Dmitry Torokhov
Copyright (c) 2003 Daniele Bellucci
Copyright (C) 2002 by Theodore Ts'o
Copyright (c) 2000-2003 David McCullough <davidm@snapgear.com>
Copyright (c) 2000-2001 D Jeff Dionne <jeff@uclinux.org>
Copyright (c) 2002 Greg Ungerer <gerg@snapgear.com>
Copyright (c) 2007-2010 Paul Mundt <lethal@linux-sh.org>
Copyright 2009 Christian König.
Copyright (C) 2012-2018 Linaro Limited.
Copyright © 2002-2010 David Woodhouse <dwmw2@infradead.org>
Copyright (C) 2004-2013 Emulex. All rights reserved. * EMULEX and SLI are trademarks of Emulex. * www.broadcom.com *
Copyright (c) 2016-2019 by Mauro Carvalho Chehab <mchehab+samsung@kernel.org>.
Copyright (C) 2018-2019 SiFive
Copyright (c) 2000-2002 Vojtech Pavlik
"Copyright (c) 2000 Andreas Bach Aen <abach@stofanet.dk>"
Copyright (c) 2000 Clifford Wolf <clifford@clifford.at>
Copyright (c) 2000 Sam Mosel <sam.mosel@computer.org>
Copyright (c) 2000 James E. Blair <corvus@gnu.org>
Copyright (c) 2000 Daniel Egger <egger@suse.de>
Copyright (c) 2001 Frederic Lepied <flepiet@mandrakesoft.com>
"Copyright (c) 2004 Panagiotis Issaris <panagiotis.issaris@mech.kuleuven.ac.be>"
Copyright (c) 2002-2011 Ping Cheng <pingc@wacom.com>
"Copyright (c) 2014 Benjamin Tissoires <benjamin.tissoires@redhat.com> "
Copyright (C) 2009,2011 Novell Inc.

LICENCE TERMS (cont.)

Copyright: (C) 2012 Gilles Muller, INRIA/LiP6. URL: <http://coccinelle.lip6.fr/>
Copyright (c) 2004, 2005 Zultys Technologies Eugene Surovegin <eugene.surovegin@zultys.com> or <ebs@ebshome.net>
Copyright (c) 2010-2011 Rafał Milecki <zajec5@gmail.com>
Copyright (C) 1998 Jakub Jelinek <jj@ultra.linux.cz>
Copyright (C) 2001 Christoph Hellwig <hch@infradead.org>
Copyright (C) 2006 Thomas Bogendoerfer (tsbogend@alpha.franken.de)
Copyright (c) 2002 Adam J. Richter <adam@yggdrasil.com>
Copyright (c) 2004 Jean-Luc Cooke <jlcooke@certaintkey.com>
Copyright (c) 2007 Herbert Xu <herbert@gondor.apana.org.au>
Copyright 2005, Devicescape Software, Inc.
Copyright (C) 2015 Texas Instruments
Copyright (C) 2005-2012 Tai-hwa Liang, Sentelic Corporation.
Copyright (C) 2018 Maciej W. Rozycki
Copyright (c) 2011 Free Electrons
Copyright (c) International Business Machines Corp., 2006
Copyright (c) Nokia Corporation, 2007 Authors: Artem Bityutskiy, Frank Haverkamp
Copyright (c) 2006 Mauro Carvalho Chehab <mchehab@kernel.org>
Copyright(c) 1998
Copyright 2005 Alessandro Zummo
Copyright (C) 2006 Nobuhiro Iwamatsu
Copyright (C) 2001 IBM
Copyright (C) 2009 Sitdikov Valentin
Copyright (C) 2002, 2003, 2006 Paul Mundt
Copyright (C) 2014-2016 Zi Shen Lim <zlim.lnx@gmail.com>
Copyright (C) 2001, 2002 Paul Mundt
Copyright (C) 2002 TimeSys Corp.
Copyright (C) 2003-2008 Yoichi Yuasa <yuasa@linux-mips.org>
Copyright © 2008 by Sander Huijsen <Shuijsen@optelecom-nkf.com> Troy Kisky <troy.kisky@boundarydevices.com> Dirk Behme <Dirk.Behme@gmail.com>
Copyright 2002-2004 MontaVista Software Inc.
Copyright (C) 2005 Andreas Jaggi <andreas.jaggi@waterwave.ch>
Copyright (C) 2007 Larry Finger <Larry.Finger@lwfinger.net>
Copyright (c) 2010 Vasily Khoruzhick <anarsoul@gmail.com>
Copyright (C) 2012 ARM Limited
Copyright (C) 2000 Chris R. Baugher <baugher@enteract.com>
Copyright (C) 2001,2002 Frank Mori Hess <fmhess@users.sourceforge.net>
Copyright 2013, 2014 Horms Solutions Ltd.
"Copyright (c) 2005 Maarten Deprez <maartendeprez@users.sourceforge.net> "
Copyright (c) 2017 Pengutronix, Marc Kleine-Budde <kernel@pengutronix.de>
Copyright (C) 2013-2014 Aaro Koskinen <aaro.koskinen@iki.fi>
Copyright (C) 2007 Instituto Nokia de Tecnologia - INdT
Copyright (C) 2016, Sven Schmidt <4sschmid@informatik.uni-hamburg.de>
Copyright (C) 2011-2016, Yann Collet. BSD 2-Clause License (<http://www.opensource.org/licenses/bsd-license.php>)
Redistribution and use in source and binary forms, with or without modification, are permitted provided that the following conditions are met:
Copyright (C) 2007 Thomas Bogendoerfer
Copyright (c) 2008 Eurotech S.p.A. <info@eurtech.it>
Copyright (C) 2000 YAEGASHI Takeshi
copyright(c) 2005-2006 Mauro Carvalho Chehab <mchehab@kernel.org> video_ioctl2 conversion
Copyright (c) 2015 Hans de Goede <hdegoede@redhat.com>
Copyright (c) 2008-2009 Atheros Communications, Inc.
Copyright (C) 2006 Compulab, Ltd. Mike Rapoport <mike@compulab.co.il> Creation of driver
Copyright 2006 One Laptop Per Child Association, Inc.
Copyright 2006-7 Jonathan Corbet <corbet@lwn.net>
Copyright (C) 2001 Jun Nakajima <jun.nakajima@intel.com>
Copyright (C) 2007 Eugene Konev <ejka@openwrt.org>

Copyright (C) 2004 S.Hauer, Pengutronix
Copyright (C) 2002 Paul Mundt
Copyright(C) 2002 Atom Create Engineering Co., Ltd.
Copyright (C) 2005-2007 kogiidena
Copyright (c) 2017 Huawei Corporation."
Copyright (c) 2003 Open Source Development Lab
"Copyright 2017 Intel Deutschland GmbH "
Copyright (C) 1998 Alan Cox <alan@lxorguk.ukuu.org.uk>
Copyright (C) 2004, 2005, 2006 Nokia Corporation
Copyright 2008 Christian Lamparter <chunkeey@web.de>
Copyright (c) 2014, Linaro Limited
Copyright 2009 Red Hat Inc.
Copyright (C) 2003-2008, Philipp Reisner <philipp.reisner@linbit.com>.
Copyright (C) 2003-2008, Lars Ellenberg <lars.ellenberg@linbit.com>.
Copyright (C) 2001 Thomas Bogendoerfer <tsbogend@alpha.franken.de>
Copyright (C) 2000 Philipp Rumpf <prumpf@tux.org> based on skeletonfb, which was Created 28 Dec 1997 by Geert Uytterhoeven HP Xhp cfb-based X11 window driver for XFree86
Copyright 1992 Hewlett-Packard Co.
Copyright (C) 2003 MontaVista Software Inc. Author: Jun Sun, jsun@mvista.com or jsun@junsun.net
Copyright (C) 2004-2005 MontaVista Software Inc. Author: Manish Lachwani, mlachwani@mvista.com or manish@koffee-break.com
Copyright (C) 2007-2008 Wind River Systems, Inc. Author/Maintainer: Jason Wessel, jason.wessel@windriver.com
Copyright (c) 2015, Red Hat, Inc.
Copyright (c) 2015, 2016 Linaro Ltd.
Copyright (C) 2002 Randy Dunlap <rdunlap@xenotime.net>
Copyright (C) 2002 Al Stone <aahs3@fc.hp.com>
Copyright (C) 2002 Hewlett-Packard Company
Copyright (C) 2001, 2002 David S. Miller (davem@redhat.com) [tg3.c]
Copyright (C) 2000, 2001 David S. Miller (davem@redhat.com) [sungem.c]
Copyright 2001 Manfred Spraul [natsemi.c]
Copyright 1999-2001 by Donald Becker. [natsemi.c] Written 1997-2001 by Donald Becker. [8139too.c]
Copyright 1998-2001 by Jes Sorensen, <jes@trained-monkey.org>. [acenic.c]
Copyright (C) 2014 Renesas Solutions Corp.
Copyright (c) 2001 by MontaVista Software, Inc. (Nico, your code rocks!)
Copyright (C) 2010 Willow Garage <<http://www.willowgarage.com>>
Copyright (C) 1993, 1994, 1995, 1998, 1999 Eric Youngdale generic SCSI package header file by Initial versions: Drew Eckhardt Subsequent revisions: Eric Youngdale
Copyright (c) 2001-2006 Anton Altaparmakov
Copyright (c) 2006 Nokia Corporation Various changes: Imre Deak <imre.deak@nokia.com>
Copyright (C) 2008-2011 Florian Fainelli <florian@openwrt.org>
Copyright (C) 2004 Nokia Corporation by Tony Lindgren <tony@atomide.com>
Copyright (C) 2005-2006, P.Christeas <p_christ@hol.gr>
Copyright (C) 2007, Gabor Juhos <juhosg@openwrt.org> Felix Fietkau <nbd@openwrt.org> Florian Fainelli <florian@openwrt.org>
Copyright (c) 2012 Code Aurora Forum. All rights reserved.
Copyright (c) 2002 Russell King
Copyright (c) 2014-2015 Linaro Limited.
Copyright (C) 2008-2011 Texas Instruments, Inc. Paul Walmsley Rajendra Nayak <rnayak@ti.com>
Copyright (c) 2005 Intel Corp.
Copyright 2007 Andy Wilcox, Jon Loeliger
Copyright 2005 Wolfson Microelectronics PLC.
Copyright 2008 Wolfgang Grandegger <wg@grandegger.com>
Copyright (c) 2014 NVIDIA Corporation
Copyright (C) 2019 Andy Newell <newella@fb.com>
Copyright (C) 2007-2008, 2010 Nokia Corporation
Copyright (C) 2013-2014 Lubomir Rintel
Copyright (C) 2013 Craig McGeachie

LICENCE TERMS (cont.)

Copyright 2007 Juergen Beisert @ Pengutronix (j.beisert@pengutronix.de)
Copyright (C) 1997-2002 Russell King
Copyright (c) 2001-2003 International Business Machines Corp.
Copyright (C) 1998-2000 Phil Blundell
Copyright 2018-2019 NXP
Copyright (C) 2003 Richard Curnow (/proc/tlb, bug fixes)
Copyright(C) 1994, 1995, 1996,1997 Russell King
Copyright (C) 1999 SuSE GmbH, (Philipp Rumpf, prumpf@tux.org)
Copyright (C) 2008 Sirius International (Hong Kong) Limited Timothy Lee <timothy.lee@siriushk.com> (for initial work on LGS8GL5)
Copyright(c) Pierre Ossman\n
"COPYRIGHT ""(C) 1999-2004 Max Krasnyansky <maxk@qualcomm.com>""
Copyright (C) 1998-2000 Jens Axboe
Copyright(C) 2001 Johannes Erdfeldt <jerdfeldt@valinux.com>
Copyright(C) 2001 NeilBrown <neilb@cse.unsw.edu.au>
Copyright Micro Memory Inc 2001-2002. All rights reserved.
Copyright (c) Steven Rostedt <srostedt@redhat.com>
Copyright 2005-2007 Freescale Semiconductor, Inc. All Rights Reserved. add MX31 specific definitions
Copyright(c) MontaVista Software, Inc.
Copyright (C) 2008 Nokia Corporation Author: Texas Instruments
Copyright (C) 1995-2000 Simon G. Vogl With some changes from: Frodo Looijaard <frodol@dds.nl> Kyösti Mälkki <kmalkki@cc.hut.fi>
Copyright (c) 2004 James Morris <jmorris@redhat.com>, Red Hat Inc. ea-in-inode support by Alex Tomas <alex@clusterfs.com> aka bzzz and Andreas Gruenbacher <agruen@suse.de>.
Copyright (c) 2010 Cisco Systems, Inc
Copyright (C) 2011 Becky Bruce, Freescale Semiconductor
Copyright (C) 2009, Dongsoo Nathaniel Kim <dongsoo45.kim@samsung.com>
Copyright (C) 2015-17 Renesas Electronics Corporation
Copyright 2010-2011 Analog Devices Inc.
Copyright 2012 Lothar Felten <l-felten@ti.com>
Copyright (c) 2005 Vojtech Pavlik
"Copyright (c) 2000-2001 Lineo Canada Corp. <www.lineo.ca>"
Copyright (C) 1999 Vladimir Gurevich <vgurevic@cisco.com> Bare & Hare Software, Inc. Based on include/asm-m68knommu/MC68332.h
Copyright (C) 2008, Intel Corp. Author: Huang Ying <ying.huang@intel.com>
Copyright (C) 2004-2007 International Business Machines Corp. Author(s): Michael A. Halcrow <mahalcro@us.ibm.com>
Copyright (C) 2002-2007 KVASER AB
Copyright (C) 2004 Pavel Pisa
Copyright (C) 2001 Arnaud Westenberg
Copyright (c) 2002-2007 Volkswagen Group Electronic Research
Copyright (c) 2003 Matthias Brukner, Trajet GmbH, Rebenring 33, 38106 Braunschweig, GERMANY
Copyright (C) 2013 Alistair Popple, IBM Corp
Copyright (C) 2012 STRATO. All rights reserved.
Copyright (C) 2018 Kontron Electronics GmbH
Copyright (c) 2019 Krzysztof Kozłowski <krzk@kernel.org>
Copyright (c) 2011-2012 Qualcomm Atheros, Inc. All rights reserved.
Copyright 2009 Red Hat, Inc.
Copyright (C) 2001 Keith M Wesolowski
Copyright(c) 2014 - 2015 Intel Mobile Communications GmbH
Copyright(c) 2014 Intel Corporation. All rights reserved.
Copyright (C) 2001, 2002, 2003 Liam Davies (ldavies@agile.tv)
Copyright (C) 1998, 1999, 2000, 2001 Free Software Foundation, Inc.
Copyright 2008-2009 Paul Mackerras, IBM Corporation
Copyright (C) 2014 Linaro. Viresh Kumar <viresh.kumar@linaro.org>
Copyright 2019 Renato Lui Geh
Copyright (c) 1995 - 2000 Kungliga Tekniska Högskolan Royal Institute of Technology, Stockholm, Sweden). All

rights reserved.
Copyright (c) 2013 Michael Stapelberg <michael@stapelberg.de>
Copyright (c) 2017-2019 Ronald Tschalär
Copyright (C) 2000 RidgeRun, Inc. Author: Greg Lonnon <glonnon@ridgerun.com>
Copyright (c) 2004 Li Shaohua <shaohua.li@intel.com>
Copyright (C) 2014 Pavel Machek <pavel@denx.de>
Copyright (C) 2001-2013 Helge Deller <deller@gmx.de>
Copyright (C) 2001-2002 Thomas Bogendoerfer <tsbogend@alpha.franken.de>
Copyright (C) 2007 kogiidena
Copyright (C) 2004-2005 Nokia Corporation. Dynamic Tick Timer written by Tony Lindgren <tony@atomide.com> and Tuukka Tikkanen <tuukka.tikkanen@elektrobit.com>.
Copyright (C) 2002-2003 Dave Jones.
Copyright (C) 1999 Jeff Hartmann.
Copyright (c) 2019 Mellanox Technologies. All rights reserved
Copyright (C) 2004 MontaVista Software - IPMI Powerdown via sys_reboot\n
Copyright (c) 2014, Intel Corporation.
Copyright (c) by James Courtier-Dutton <James@superbug.demon.co.uk>
Copyright (c) 2011-2015,2017 Qualcomm Atheros, Inc.
Copyright (C) 2003 StorLine, Inc <jason@storlink.com.tw>
Copyright (C) 2010 Frederic Pecourt <opengemini@free.fr>
Copyright (C) 2011 Tobias Waldvogel <tobias.waldvogel@gmail.com>
Copyright (c) 2016-2017 Brian Masney <masneyb@onstation.org>
Copyright (C) 2005, 2006 by Ralf Baechle (ralf@linux-mips.org)
Copyright (C) 2015 Glider bvba Modified to support SH7720 SCIF. Markus Brunner, Mark Jonas (Jul 2007).
Copyright (C) 1999, 2000 Niibe Yutaka
Copyright (C) 2000 Sugioka Toshinobu Modified to support multiple serial ports. Stuart Menefy (May 2000). Modified to support SecureEdge. David McCullough (2002) Modified to support SH7300 SCIF. Takashi Kusuda (Jun 2003). Removed SH7300 support (Jul 2007).
Copyright (C) 2009 Philippe Vachon <philippe@cowpig.ca>
Copyright (C) 2009 Zhang Le <r0bertz@gentoo.org>
Copyright 2005-2008 Pierre Ossman
Copyright (c) 2001-2003 Intel Corp.
Copyright (c) 2001-2002 Nokia, Inc.
Copyright (C) 1999, 2000 Silicon Graphics, Inc. Kevin Kissell, kevink@mips.com and Carsten Langgaard, carstenl@mips.com
Copyright (c) 2010-2012, The Linux Foundation. All rights reserved.
Copyright (C) 2018 Red Hat, Inc. All Rights Reserved.
Copyright (c) 2002 Joe Burks (jburks@wavicle.org), Chris Cheney (chris.cheney@gmail.com), Pavel Machek (pavel@ucw.cz), John Tyner (jtyner@cs.ucr.edu), Monroe Williams (monroe@pobox.com)
Copyright (C) 2006 Michael Hanselmann <linux-kernel@hansmi.ch>
Copyright (c) 2013 Noralf Trønnes
Copyright (C) 2012 Konstantin Khlebnikov
Copyright (c) 2007-2010 Bartłomiej Zolnierkiewicz
Copyright (c) 2004, 2005 Infinicon Corporation. All rights reserved.
Copyright (c) 2004, 2005 Intel Corporation. All rights reserved.
Copyright (c) 2004, 2005 Topspin Corporation. All rights reserved.
Copyright (C) 2002 Toshiba Corporation
Copyright (C) 2003 MontaVista Software (source@mvista.com)
Copyright 2008 Martin Fuzzey, mfuzzey@gmail.com
Copyright (C) 2013-2016 Steven Rostedt, Red Hat, Inc. <srostedt@redhat.com>
Copyright (C) 2012 Linaro Ltd.
Copyright (C) 2013 Renesas Solutions Corp.
Copyright (c) 2005 Kenan Esau <kenan.esau@conan.de>
Copyright (c) 2004-2005 Stephane VOLTZ <svoltz@numericable.fr>
Copyright (C) 2002 Greg Ungerer <gerg@snapgear.com>
Copyright (C) 2002 SnapGear, by Paul Dale <pauli@snapgear.com>
Copyright (C) 2000, 2001 Lineo, by David McCullough <davidm@lineo.com> based heavily on:

LICENCE TERMS (cont.)

Copyright (C) 1991, 1992, 1996 Linus Torvalds linux/fs/binfmt_flat.c for 2.0 kernel
Copyright (C) 1998 Kenneth Albanowski <kjahds@kjahds.com> JAN/99 -- coded full program relocation (gerg@snapgear.com)
Copyright (C) 2018 embedded brains GmbH
Copyright (C) 2001-2004 Greg Kroah-Hartman (greg@kroah.com)
Copyright (C) 2013, Imagination Technologies
Copyright (C) 2017 SiFive
Copyright (C) 2018 Christoph Hellwig
Copyright (C) 2002 David S. Miller.
Copyright 1999 SuSE GmbH (Philipp Rumpf)
Copyright 1999 Philipp Rumpf (prumpf@tux.org)
Copyright 2000 Hewlett Packard (Paul Bame, bame@puffin.external.hp.com)
Copyright (C) 2001 Grant Grundler (Hewlett Packard)
Copyright (C) 2004 Kyle McMartin <kyle@debian.org>
Copyright (C) 2001 Helge Deller <deller at parisc-linux.org>
Copyright (C) 2010 Guy Martin <gmsoft at tuxicom.be>
Copyright (C) 2006 Nokia Corporation Tony Lindgren <tony@atomide.com>
Copyright (C) 2001 Vic Phillips, Microtronix Datacom Ltd.
Copyright (C) 2016-17 Jacopo Mondì
Copyright (C) 2013 Intel Corporation Author: Tim Chen <tim.c.chen@linux.intel.com>
Copyright (C) 2006 Trusted Computer Solutions, Inc. <dgoeddel@trustedcs.com>
Copyright (C) 2006 IBM Corporation, Timothy R. Chavez <tinytim@us.ibm.com>
Copyright (C) 2003 David Glance <advidgsf@sourceforge.net> 2001-2004 Juergen Stuber <starblue@users.sourceforge.net>
Copyright 2019 Linaro, Ltd, Rob Herring <robh@kernel.org> */
Copyright (c) 2005 Palmsource, Inc.
Copyright (c) 2018 Akash Gajjar <Akash_Gajjar@mentor.com>
Copyright (C) 1999 Srinivasa Prasad Thirumalachar <sprasad@sprasad.engr.sgi.com>
Copyright (C) 2008 Silicon Graphics, Inc. (SGI)
Copyright (C) 2017-2019 Broadcom. All Rights Reserved. The term Broadcom refers to Broadcom Inc. and/or its subsidiaries.
Copyright (c) 2013 by Cisco Systems, Inc. All rights reserved.
Copyright (c) 2010 - 2012 Xilinx, Inc. All rights reserved.
Copyright (c) 2005-6 Ian McDonald <ian.mcdonald@jandi.co.nz>
Copyright (C) 2007 Texas Instruments, Inc. Karthik Dasu <karthik-dp@ti.com>
Copyright (C) 2006 Nokia Corporation Tony Lindgren <tony@atomide.com>
Copyright (C) 2005 Texas Instruments, Inc. Richard Woodruff <r-woodruff2@ti.com>
Copyright (C) 2016 Savoir-Faire Linux
Copyright (C) 2010 One Laptop per Child
Copyright (C) 2018 IBM Corporation.
Copyright (C) 2017 Linus Walleij <linus.walleij@linaro.org>
Copyright (C) 2017 Martin Kaiser <martin@kaiser.cx>
Copyright (C) 2008 Wolfram Sang & Juergen Beisert, Pengutronix
Copyright (C) 2007-2009 Mattia Dongili <malattia@linux.it>
Copyright (c) 2008-2009, MontaVista Software, Inc. <source@mvista.com>
Copyright (C) 2004-2005 Intel Corporation <jketreno@linux.intel.com>
Copyright (C) 2017 Alexander Graf <agraf@suse.de>
Copyright (C) 2011 - 2014 Xilinx
Copyright (C) 2019 Renesas Electronics Corporation
Copyright (C) 2012-2018 by the following authors: Wladimir J. van der Laan <laanwj@gmail.com> Christian Gmeiner <christian.gmeiner@gmail.com> Lucas Stach <l.stach@pengutronix.de> Russell King <rmk@arm.linux.org.uk>
Copyright (C) 2011 Yadwinder Singh (yadi.brar01@gmail.com) Jaswinder Singh (jaswinder.singh@linaro.org)
Copyright (c) 2015 Samsung Electronics Co., Ltd. Bartlomiej Zolnierkiewicz <b.zolnierki@samsung.com>
Copyright (c) Russ Anderson
Copyright(c) 2008 Daniel Mack <daniel@caiaq.de>
Copyright (C) 2013 Nandita Dukkkipati <nanditad@google.com>
Copyright (C) 2018 Robert Bosch Power Tools GmbH

Copyright (C) 2016 ARM Ltd.
Copyright (C) 2006, 2007 Rusty Russell, IBM Corporation
Copyright (C) 2002, 2006 David S. Miller (davem@davemloft.net)
Copyright © 2007 David Gibson, IBM Corporation.
Copyright (C) John H Terpstra 1996-2000
Copyright (C) Luke Kenneth Casson Leighton 1996-2000
Copyright (C) Paul Ashton 1998-2000
Copyright(C) 2007 Mike Galbraith <efault@gmx.de>
Copyright(C) 2007 Dmitry Adamushko <dmitry.adamushko@gmail.com>
Copyright IBM Corporation, 2007 Author: Srivatsa Vaddagiri <vatsa@linux.vnet.ibm.com>
Copyright (C) 2007, Thomas Gleixner <tglx@linutronix.de>
Copyright 2008 (C) Eurotech S.p.A. <info@eurotech.it>
Copyright (C) 2002 Rabeeh Khoury <rabeeh@galileo.co.il> Rabeeh Khoury <rabeeh@marvell.com>
Copyright (C) 2003 PMC-Sierra, Inc., written by Manish Lachwani
Copyright (C) 2003 Ralf Baechle <ralf@linux-mips.org>
Copyright (C) 2004-2006 MontaVista Software, Inc. Dale Farnsworth <dale@farnsworth.org>
Copyright (C) 2004 Steven J. Hill <sjhill1@rockwellcollins.com> sjhill@realitydiluted.com>
Copyright (C) 2007-2008 Marvell Semiconductor Lennert Buytenhek <buytenh@marvell.com>
Copyright (C) 2013 Michael Stapelberg <michael@stapelberg.de>
Copyright (c) 2010-2011 Ericsson AB
Copyright (C) 2000 RidgeRun, Inc. Author: RidgeRun, Inc. glonnon@ridgerun.com, skranz@ridgerun.com, stevej@ridgerun.com
Copyright 2001 MontaVista Software Inc. Author: jsun@mvista.com or jsun@junsun.net
Copyright 2002 MontaVista Software Inc. Author: Michael Pruznick, michael_pruznick@mvista.com
Copyright 2012, Intel Inc.
Copyright (C) 2004 Nokia Corporation Written by Tuukka Tikkanen and Juha Yrjölä <juha.yrjola@nokia.com> Misc hacks here and there by Tony Lindgren <tony@atomide.com> Other hacks (DMA, SD, etc) by David Brownell
Copyright (C) 2003, Duncan Sands
Copyright (C) 2004, David Woodhouse
copyright (C) 2001, Benoit Papillault
Copyright (c) 2015, Christoph Hellwig <hch@lst.de>.
Copyright (c) 2015, Boaz Harrosh <boaz@plexistor.com>.
Copyright (C) 2011 Richard Cochran <richardcochran@gmail.com>
Copyright 2007 Pengutronix Juergen Beisert <j.beisert@pengutronix.de>
Copyright (C) 2013 Red Hat, Inc. All Rights Reserved. Written by David Howells (dhowells@redhat.com)
Copyright (C) 1996, 1997, 1998 Ingo Molnar, Miguel de Icaza, Gadi Oxman
Copyright (C) 2018 Stanislaw Gruszka <stf_xl@wp.pl>
Copyright (C) 2012 Hans-Frieder Vogt <hfvogt@gmx.net>
Copyright (C) 2001-2006 PEAK System-Technik GmbH
Copyright (c) 2008 Andres Salomon <dlinger@debian.org>
Copyright (C) 1997-2007 David A. Schleeff <ds@schleeff.org>
Copyright (C) 2010, Arnaldo Carvalho de Melo <acme@redhat.com>
Copyright (C) 2003 ATI Inc. <hyu@ati.com>
Copyright (C) 2004 Bartlomiej Zolnierkiewicz
Copyright 2004-2011 Red Hat, Inc.
Copyright 2012 Red Hat Inc. Authors: Dave Airlie <airlied@redhat.com> Michael Thayer <michael.thayer@oracle.com>
Copyright (C) 1999 Jakub Jelinek (jj@ultra.linux.cz)
Copyright (C) 1996 Frank Neumann
Copyright (C) 2013 Texas Instruments Author: Tomi Valkeinen <tomi.valkeinen@ti.com>
Copyright (C) 1999, 2000, 2001 Silicon Graphics, Inc.
Copyright (c) 2011, Code Aurora Forum. All rights reserved. Author: Dima Zavin <dima@android.com>
Copyright (C) 2011 Google, Inc. All rights reserved.
Copyright IBM Corporation 2001, 2005, 2006
Copyright Linas Vepstas 2005, 2006
Copyright 2001,2002 Jeff Garzik <jgarzik@mandrakesoft.com> [8139cp.c.tg3.c]
Copyright (C) 2001, 2002 David S. Miller (davem@redhat.com)[tg3.c]

LICENCE TERMS (cont.)

Copyright 1996-1999 Thomas Bogendoerfer [pcnet32.c] Derived from the lance driver written 1993,1994,1995 by Donald Becker.
Copyright 1993 United States Government as represented by the Director, National Security Agency.[pcnet32.c] Carsten Langgaard, carstenl@mips.com [pcnet32.c]
Copyright (C) 2009 Devin Heitmueller <dheitmueller@kernellabs.com>
Copyright (C) 2006 Mike Christie
Copyright (c) 2010 ST-Ericsson SA
Copyright(c) 2017 Linaro Ltd.
Copyright (C) 2005 Venkatesh Pallipadi <venkatesh.pallipadi@intel.com> Added support for C3 on SMP
Copyright (c) 2007 - 2012 QLogic Corporation. All rights reserved.
Copyright (c) 2005, 2006 Michael Buesch <m@bues.ch>
Copyright (c) 2005 Andreas Jaggi <andreas.jaggi@waterwave.ch>
Copyright (C) 2005-2011 FUJITA Tomonori <tomof@acm.org>
Copyright (C) 2010 Nicholas A. Bellinger <nab@kernel.org>
Copyright (C) 2015-2018, EfficiOS Inc., Mathieu Desnoyers <mathieu.desnoyers@efficios.com>
Copyright © 2010 Francisco Jerez <currojerez@riseup.net>
Copyright (C) 2006 David Brownell
Copyright (C) 2008, 2010 Embecosm Limited
Copyright (C) 2007 Hans Verkuil <hverkuil@xs4all.nl>
Copyright (C) 2013-2017 Texas Instruments Incorporated - <http://www.ti.com/>
Copyright (C) 2010-2011 Jonas Bonn <jonas@southpole.se>
Copyright (c) 2009 by Krzysztof Helt Routines for control of MPU-401 in UART mode
Copyright(c) 2018 Alexei Starovoitov. All rights reserved.
Copyright(c) 2018 Intel Corporation. All rights reserved.
Copyright (C) 2004, 2013 Maciej W. Rozycki
Copyright (C) 1995, 1996 Andreas Busse
Copyright (C) 1995, 1996 Stoned Elipot
Copyright (C) 1995, 1996 Paul M. Antoine.
Copyright (C) 2009 Zhang Le
Copyright (C) 2007 Atmel Corporation.
Copyright (C) 2011-2019 Renesas Electronics Corporation
Copyright (C) 2012-14 Renesas Solutions Corp. Kuninori Morimoto <kuninori.morimoto.gx@renesas.com>
Copyright(c) 2005-2008 MSC Vertriebsges.m.b.H, Manuel Lauss <mmlau@msc-ge.com>
"Copyright 2017 Intel Deutschland GmbH"
Copyright (C) 2017 Peter Meerwald-Stadler <pmeerw@pmeerw.net>
Copyright (C) 2001 - 2018 Douglas Gilbert
Copyright (C) 2012 Variscite Ltd. - <http://www.variscite.com>
Copyright (C) 2010 Michał Mirosław <mirq-linux@rere.qmqq.pl>
Copyright(C) 2017 Linus Walleij <linus.walleij@linaro.org>
Copyright (C) 2003-2004 David Brownell.
Copyright (C) 2002 by Takashi Iwai.
Copyright (C) 2002-2005 Clemens Ladisch.
Copyright (C) 1999, 2006 Ralf Baechle (ralf@linux-mips)
Copyrighted (C) 1994 Normunds Saumanis (normunds@rx.tech.swh.lv)
Copyrighted (C) 1994, 1995, 1996 Normunds Saumanis (normunds@fi.ibm.com)
Copyright (C) 2016 Chen-Yu Tsai <wens@csie.org>
Copyright 2015 www.starterkit.ru <info@starterkit.ru>
Copyright(c) 2011-12 liran <jli11@intersil.com> [Intersil|Techwell China]
Copyright (C) 2006 8D Technologies inc.
Copyright 1999 D. Jeff Dionne <jeff@rt-control.com>
Copyright (c) 2015 Linaro, Ltd. All rights reserved.
Copyright (C) 2004 Compulab Ltd.
Copyright 2008 GE Intelligent Platforms Embedded Systems, Inc.
Copyright(c) 2013 OpenVPN Technologies, Inc. All rights reserved.
Copyright (C) 2002 Lionel Bouton <Lionel.Bouton@inet6.fr>, Maintainer
Copyright (C) 2003 Vojtech Pavlik <vojtech@suse.cz>
"Copyright (C) 2007-2009 Bartłomiej Zolnierkiewicz "

Copyright (C) 2007-2009 Matthias Schwarzott <zzam@gentoo.de>
Copyright(c) 2015 Intel Deutschland GmbH All rights reserved.
Copyright 2017-2018 NXP Author: Dong Aisheng <aisheng.dong@nxp.com>
Copyright (c) 2003 Texas Instruments
Copyright (c) 2002 Thomas Gleixner <tgxl@linutronix.de>
Copyright (C) 1995, 1996 Russell King.
Copyright (C) 1996 Gertjan van Wingerde Minix V2 fs support.
Copyright (C) 1999, 2000 Niibe Yutaka & Kaz Kojima
Copyright (C) 2014 Ma Haijun <mahaijuns@gmail.com>
Copyright (C) 2009 Oxford Semiconductor Ltd
Copyright 2016-2017 Socionext Inc. Author: Kunihiko Hayashi <hayashi.kunihiko@socionext.com>
Copyright (c) 2010 by Hertton Ronaldo Krzesinski <herton@mandriva.com.br>
Copyright (C) 2006 Simon Schulz (ark3116_driver <at> auctionant.de)
Copyright (C) 2000-2002 Greg Ungerer <gerg@snapgear.com>
Copyright (c) 2002-2005 Anton Altaparmakov
Copyright (C) 2018 exceet electronics GmbH
Copyright (C) 2018 Kontron Electronics GmbH
Copyright © 1998 - 2003 Frodo Looijaard <frodol@dds.nl>, Philip Edelbrock <phil@netroedge.com>, and Mark Studebaker <midsxyz123@yahoo.com>
Copyright (C) 2006 Manuel Francisco Naranjo (naranjo.manuel@gmail.com)
Copyright (C) 2011 Texas Instruments Author: Mayuresh Janorkar <mayur@ti.com>
Copyright (C) 2010 Canonical Ltd. Author: Bryan Wu <bryan.wu@canonical.com>
Copyright (c) 1996 Brian Buhrow <buhrow@lothlorien.nfbcal.org>
Copyright (c) 1997 Nicolas Pitre <nico@cam.org>
Copyright (c) 2003 David Borowski <david575@golden.net>
Copyright © 2008 - 2003 Sander Huijsen <Shuijsen@optelecom-nkf.com> Troy Kisky <troy.kisky@boundarydevices.com> Dirk Behme <Dirk.Behme@gmail.com>
Copyright 2006 Endrelia Technologies Inc. Based on corgi.c by:
Copyright [copy] 2009 Texas Instruments, Inc.
Copyright © 2003 Atheros Communications, Inc., All Rights Reserved.
Copyright 2007-8 Advanced Micro Devices, Inc.
Copyright (c) 2013 Lubomir Rintel
Copyright (C) 2004 Keiichiro Tokunaga (tokunaga.keiich@jp.fujitsu.com)
Copyright (C) 2004 Motoyuki Ito (motoyuki@soft.fujitsu.com)
Copyright (C) 2004 FUJITSU LIMITED
Copyright (C) 2004, 2013 Intel Corp. Author: Rafael J. Wysocki <rafael.j.wysocki@intel.com>
Copyright (C) 2008-2009 MontaVista Software, Inc. <source@mvista.com>
Copyright 2016 Intel Corporation All Rights Reserved.
Copyright (c) 2009 - 2012 Intel Corporation."
Copyright(c) 2001-2002 Petr Vandrovec <vandrove@vc.cvut.cz>
Copyright MODULE_DESCRIPTION("Matrox G450/G550 PLL driver
Copyright (c) 2006-2007 Greg Kroah-Hartman <greg@kroah.com>
Copyright (c) 2006-2007 Novell Inc.
"Copyright (C) 2006 Intel Co 2006-08-12 - IA64 Native Utrace implementation support added by Anil S Keshavamurthy <anil.s.keshavamurthy@intel.com> "
Copyright (C) 2007-2009 Texas Instruments
Copyright (C) 2004 Steven Toth <stoth@linuxtv.org>
Copyright 2008 ARM Limited
Copyright 2008 Cavium Networks Scott Shu
Copyright (C) 2000-2001 Gillem <htoa@gmx.net>
Copyright (C) 2002 Andreas Oberritter <obi@software.de>
Copyright (C) 1999 Nathan Laredo <laredo@gnu.org>
Copyright (C) 2003 Kevin Thayer <nufan_wfk@yahoo.com>
Copyright (C) 2004 Eric Varsanyi
Copyright (C) 2004, 2005 Hans Verkuil <hverkuil@xs4all.nl>
Copyright (C) 2008 Thiemo Seufer
Copyright (C) 2012 MIPS Technologies, Inc.

LICENCE TERMS (cont.)

Copyright (C) 2007 - 2008 Paul Mundt
Copyright (c) 2015 K. Merker <merker@debian.org>
Copyright 2005-2007 Rodolfo Giometti " giometti@linux.it>\n", PPS_VERSION)
"Copyright (C) 2003 Michiel Rook <michiel@grendelproject.nl>"
"Copyright (C) 2005 Grant Coady <gcoady.lk@gmail.com> with valuable guidance from Jean Delvare "
Copyright (C) 2007 Jeff Dike (jdike@{addtoit,linux.intel}.com)
Copyright (c) 2010 Red Hat, Inc.
Copyright (c) 2010 - 2011 Ping Cheng, Wacom. <pingc@wacom.com>
Copyright 1999 Precision Insight, Inc., Cedar Park, Texas.
Copyright (c) 2009-2010, Code Aurora Forum.
Copyright (C) 2018 Kent Gustavsson <kent@minoris.se>
Copyright (C) 2003 Timesys Corporation.
Copyright (C) 2004-2006 MontaVista Software, Inc.
Copyright(C) 2005 Frank Rowand (frowand@mvista.com) PPC32 support restored by Vitaly Wool <vwool@ru.mvista.com> and Sergei Shtylyov <sshtylyov@ru.mvista.com>
Copyright (C) 2007-2008 Wind River Systems, Inc.
Copyright (C) 2011 Atmel
Copyright (C) 2002 David McCullough
Copyright (c) 2009 Zhang Le <r0bertz@gentoo.org>
Copyright (C) 2018, Red Hat, Inc. (code style cleanup and fuzzing driver)
Copyright (C) 2006 IBM Corporation
Copyright (C) 2011 - 2014 Cisco Systems Inc
Copyright (C) 1997-1998 Richard Gooch
Copyright (C) 2004 Boris Hu
Copyright (C) 2010 - 2012 LAPIS SEMICONDUCTOR CO., LTD.
Copyright 2006, 2007 Sony Corporation.
Copyright 2019 ARM Limited
Copyright (c) 2006-2012 Jiri Kosina
Copyright (c) 2016 Vadim Pasternak <vadimp@mellanox.com>
copyright(c) container_of(c, struct mlxcpld_led_priv, cdev)
Copyright(c) container_of(c, struct mlxcpld_led_priv, cdev)
Copyright (c) 2006 Simtec Electronics
Copyright (C) 2008 Devin Heitmueller <dheitmueller@iinuxtv.org>
Copyright (C) 2013 Linaro. Viresh Kumar <viresh.kumar@linaro.org>
Copyright (c) 2002 Vladimir Dergachev
Copyright (c) 2007, MontaVista Software, Inc. <source@mvista.com>
Copyright (C) 2002-2005 Sam Ravnborg <sam@ravnborg.org>
Copyright (C) 2005-2014 Dell Inc.
Copyright (c) Mike Travis
Copyright (C) 2011-2012 Texas Instruments, Inc. Paul Walmsley
Copyright (C) 2008 Lyrtech <www.lyrtech.com>
Copyright © 2015 Intel Corporation.
Copyright AudioScience, Inc., 2003
Copyright (C) 2016 Song Liu <songliubraving@fb.com>
Copyright (C) ST Microelectronics SA 2011
Copyright (C) 2004, 2006, 2007 Maciej W. Rozycki
Copyright(C) 1999 David Airlie, airlie@linux.ie
Copyright (c) 2011 Mark Einon <mark.einon@gmail.com>
Copyright 2008 Thomas Bogendoerfer <tsbogend@alpha.franken.de> Mxier part taken from mace_audio.c:
Copyright 2007 Thorben Jändling <tj.trevelyan@gmail.com>
Copyright (C) 2006-2007 MontaVista Software, Inc. <source@mvista.com>
Copyright (C) 2007 - 2010 ID7 Ltd.
Copyright (C) 2010-2011 Nicholas A. Bellinger <nab@kernel.org>
Copyright (c) 2018, Craig Tatlor.
Copyright (c) 2007 Anton Vorontsov <avorontsov@ru.mvista.com>
Copyright (C) 1996-1999 Jakub Jelinek (jj@ultra.linux.cz)
Copyright (C) 1997 Michal Rehacek (Michal.Rehacek@st.mff.cuni.cz)

Copyright(c) 2006 xiong huang <xiong.huang@atheros.com>
Copyright(c) 2007 Chris Snook <csnook@redhat.com>
Copyright (c) 1998-2007 InnoSys Incorporated. All Rights Reserved
Copyright (C) 2006 Pavel Pisa, PiKRON <ppisa@pikron.com>
Copyright (c) 2012 Red Hat, Inc. All Rights Reserved.
Copyright (c) 2016, Dell Inc
Copyright (C) 2005 Martin Langer <martin-langer@gmx.de>
Copyright (C) 2005 Stefano Brivio <st3@riseup.net>
Copyright (C) 2006 Broadcom Corporation.
Copyright (C) 2001-2004 Peter Osterlund <petero2@telia.com>
Copyright 2016 Linaro Ltd.
Copyright (C) 2004, LynuxWorks, Inc., Igor Manyilov, Bill Huey Released under the General Public License (GPL).
Copyright (C) 2004 Intel Corporation <jketreno@linux.intel.com>
Copyright (C) 2006-2009 Hewlett-Packard Development Company, L.P. Alex Chiang <achiang@hp.com>
Copyright (C) 1999 AbsoluteValue Systems, Inc. All Rights Reserved.
Copyright (C) 2009-2011 Gabor Juhos <juhosg@openwrt.org>
Copyright (C) 1996 Thomas K. Dyas (tdyas@eden.rutgers.edu)
Copyright (c) 2008, Tungsten Graphics, Inc. Cedar Park, TX., USA. All Rights Reserved.
Copyright 1995-1999 by Werner Almesberger, EPFL LRC/ICA */
Copyright 1999 Paul Mackerras */ And help from Jens Axboe */
Copyright (C) 2015-2016 Anton Ivanov (aivanov@brocade.com)
Copyright (C) 2000 Jeff Dike (jdike@karaya.com)
Copyright 2000, 2001 MontaVista Softare Inc.
Copyright (C) 2000, 2001 Paolo Alberelli
Copyright (C) 2002 Stuart Menefy (stuart.menefy@st.com)
Copyright (c) 2008-2006 Frank Mori Hess <fmhess@users.sourceforge.net>
Copyright (C) 1996 Adrian Rodriguez (adrian@franklins-tower.rutgers.edu) Laboratory for Computer Science
Research Computing Facility Rutgers, The State University of New Jersey
Copyright (C) 2019 Methode Electronics
Copyright (C) 2019 Telus
Copyright (C) 2014 Bruno Prémont <bonbons@linux-vserver.org>
Copyright (C) 2006 Jamie Lenehan
Copyright (C) 2008 Angelo Castello
Copyright (C) 1999 Tetsuya Okada & Niibe Yutaka
Copyright 2007 OpenVZ SWsoft Inc Author: Pavel Emelianov <xemul@openvz.org>
Copyright 2015 - Karsten Merker <merker@debian.org>
Copyright (C) 2002 Maxim Krasnyansky <maxk@qualcomm.com>
Copyright (C) 2017 Red Hat
Copyright (C) 1999,2000 Walt Drummond <drummond@valinux.com>
Copyright (C) 2000, 2002-2003 Hewlett-Packard Co. David Mosberger-Tang <davidm@hpl.hp.com>
Copyright (C) 2000 Intel Corp.
Copyright (C) 2001 Paul Diefenbaugh <paul.s.diefenbaugh@intel.com>
Copyright (C) 2001 Jenna Hall <jenna.s.hall@intel.com>
Copyright (C) 2001 Takayoshi Kochi <t-kochi@bq.jp.nec.com>
Copyright (C) 2002 Erich Focht <efocht@ess.nec.de>
Copyright (C) 2004 Ashok Raj <ashok.raj@intel.com>
Copyright (c) 2017-2019 Socionext Inc. Reworked by Masahiro Yamada <yamada.masahiro@socionext.com>
Copyright (C) Balbir Singh, IBM Corp. 2006
Copyright (c) Jay Lan, SGI. 2006
Copyright 2009 - 2013 Integrated Device Technology, Inc. Alex Bounine <alexandre.bounine@idt.com>
Copyright 1994,1995 by Donald Becker.
Copyright (c) 2016 by Mauro Carvalho Chehab <mchehab@s-opensource.com>.
Copyright © 2001-2007 Red Hat, Inc. Created by David Woodhouse <dwmw2@infradead.org>
Copyright (C) 1999 Convergence Integrated Media GmbH <ralph@convergence.de>
Copyright IBM Corp. 2018
Copyright (C) 1999, 2000 by Silicon Graphics
Copyright (C) 2004 Greg Kroah-Hartman <greg@kroah.com>

LICENCE TERMS (cont.)

copyright 1994-2001 by Donald Becker. Modified to hep support PNIC_II by Kevin B. Hendricks
Copyright (C) 2003-2005 David Hollis <dhollis@davehollis.com>
Copyright (C) 2015 Martin Schiller <mschiller@tdt.de>
Copyright (C) 2009 Tejun Heo <tj@kernel.org>
Copyright (C) 2017 Facebook Inc.
Copyright (C) 2017 Dennis Zhou <dennisszhou@gmail.com>
Copyright (C) 2006 TOPTICA Photonics AG., Dragos Carp
Copyright (c)2006 - 2007 Myricom, Inc. for some LRO specific code
Copyright (c) 2009 - 2018 Intel Corporation."
Copyright © 2009-2010 Daniel Dickinson <openwrt@cshore.neomailbox.net>
Copyright © 2011-2013 Jonas Gorski <jonas.gorski@gmail.com>
Copyright 2013 Qtechnology A/S
Copyright (C) 2012 Amit Daniel <amit.kachhap@linaro.org>
Copyright (C) 2009 Martin Fuzzey Originally written by Jay Monkman <jtm@lopingdog.com>
Copyright 2000-2003 MontaVista Software Inc.
Copyright 1995-97 Simon G. Vogl 1998-99 Hans Berglund
Copyright 2014 Jon Smirl <jonsmirl@gmail.com>
Copyright 2015 Maxime Ripard <maxime.ripard@free-electrons.com>
Copyright 2015 Adam Sampson <ats@offog.org>
Copyright 2016 Chen-Yu Tsai <wens@csie.org>
Copyright (C) 1993, 1994, 1995 Remy Card (card@masi.ibp.fr) Laboratoire MASI - Institut Blaise Pascal Universite Pierre et Marie Curie (Paris VI)
Copyright (c) u-boot contributors
Copyright (c) 2012 Pavel Machek <pavel@denx.de>
Copyright (C) 2016 Broadcom
Copyright (c) Broadcom Corp, 2012
Copyright (C) 2014 Linaro Limited
Copyright (C) 2011 Samsung Electronics Co., Ltd.
Copyright (C) 2006 Linxb (xubin.lin@worldplus.com.cn)
Copyright (C) 2006 S1 Corp.
Copyright(C) 1996,1998 Jakub Jelinek (jj@sunsite.mff.cuni.cz)
Copyright (c) 2018 Jim Wilson (jimw@sifive.com)
Copyright (C) 2002 Broadcom, Inc.
Copyright © 2009 Paul Mackerras, IBM Corp. <paulus@au1.ibm.com>
Copyright(C) ordering is still observed by the pmu driver.
Copyright (c) 1994-2000 Justin T. Gibbs.
Copyright (c) 1997-1999 Doug Ledford
Copyright (C) 1998-2001 David Mosberger-Tang <davidm@hpl.hp.com>
Copyright (C) 2006 Jon Mason <jdmason@kudzu.us>
Copyright (C) 1999 Goutham Rao <goutham.rao@intel.com>
Copyright (c) 2008 Silicon Graphics Inc. All Rights Reserved.
Copyright (C) 2011 Bart Van Assche. All Rights Reserved.
Copyright (C) 2013 Du, Changbin <changbin.du@gmail.com>
Copyright (C) 2005-2006 Timesys Corp., Thomas Gleixner <tglx@timesys.com>
Copyright (C) 2005 Kihon Technologies Inc., Steven Rostedt
Copyright (C) 2006 Esben Nielsen
Copyright (C) 2009 Gateworks Corporation Authors: Chris Lang, Imre Kaloz
Copyright(C) 2005 Michel Xhaard mxhaard@magic.fr
Copyright (c) 2007, XenSource Inc.
Copyright (c) 2010, Citrix
Copyright (C) 2012-2013 Canonical Ltd
Copyright (C) 2012 Texas Instruments
Copyright (C) 2009 Alessandro Rubini <rubini@unipv.it> Rewritten based on work by Prafulla WADASKAR <prafulla.wadaskar@st.com>
Copyright (C) 2011-2013 Linus Walleij <linus.walleij@linaro.org>
Copyright 2012 Javier Martin, Vista Silicon <javier.martin@vista-silicon.com>
Copyright (C) 2008 Martin Michlmayr <tbm@cyrius.com>

Copyright (c) 2006, 2007 IBM Corp. Josh Boyer <jwboyer@linux.vnet.ibm.com>
Copyright (C) 1995 Miguel de Icaza (miguel@nuclecu.unam.mx)
Copyright (C) 2010 "Wu Zhangjin" <wuzhanjing@gmail.com>
Copyright (C) 1998 Kenneth Albanowski <kjahds@kjahds.com>,
Copyright 2011 Wolfson Microelectronics plc Author: Mark Brown <broonie@opensource.wolfsonmicro.com>
Copyright (C) 2002 Intel Corp.
Copyright (C) 2002 Jenna Hall <jenna.s.hall@intel.com>
Copyright (C) 2005 Keith Owens <kaos@sgi.com>
Copyright (C) 2004, David Woodhouse, Roman Kagan
Copyright (c) Kyle McMartin <kyle@debian.org>
Copyright 2003-2005 Jeff Garzik
Copyright (C) 1998-1999 Andrzej Krzysztofowicz, Author and Maintainer
Copyright (C) 2003 Red Hat Inc
Copyright (c) 2006 Sphere Systems Ltd
Copyright (c) 2006 Option Wireless n/v All rights Reserved.
Copyright (C) 2006 Aurelien Jacobs <aurel@gnucage.org >
Copyright (C) 1999-2005 Igor Pavlov
Copyright (C) 2000, 2001, 2002 Jeff Dike (jdike@karaya.com)
Copyright (C) 2001 Ridgerun, Inc (glonnon@ridgerun.com)
Copyright(c) 2000 Crutcher Dunnavant <crutcher+kernel@datastacks.com> overhauled to use key registration based upon discussions in irc://irc.openprojects.net/#kernelnewbies
Copyright (c) 2010 Dmitry Torokhov Input handler conversion
Copyright (c) 2008 Wei Ni <wni@nvidia.com>
Copyright (c) 2013 Anssi Hannula <anssi.hannula@iki.fi>
Copyright (C) 2011 Patrice Chotard
Copyright (C) 2000 Philipp Rumpf (prumpf@tux.org)
Copyright (C) 2004-2011 Red Hat, Inc. All rights reserved.
Copyright (c) 2005-2007 Matthieu Castet <castet.matthieu@free.fr>
Copyright (c) 2005-2007 Stanislaw Gruszka <stf_xl@wp.pl>
COPYRIGHT(c) phm_cap_enabled(hwmg->platform_descriptor.platformCaps, (c))
Copyright (C) 2006 Andrey Volkov, Varma Electronics
Copyright 2004-2006 Pavel Pisa - DCE FELK CVUT cz
Copyright 2005 Stanislav Marek email: pisa@cmp.felk.cvut.cz
Copyright (C) 2012 Fenghua Yu <fenghua.yu@intel.com> H Peter Anvin" <hpa@zytor.com>
Copyright(c) Copyright 2009 Hewlett-Packard Development Company, L.P.
Copyright (c) 1999 Grant Erickson <grant@lcse.umn.edu>
Copyright (C) 1999-2001, 2003 Hewlett-Packard Co David Mosberger <davidm@hpl.hp.com> Stephane Eranian <eranian@hpl.hp.com>
Copyright (c) 2002 STMicroelectronics Ltd Modified from memcpy.S and micro-optimised for SH4 Stuart Menefy (stuart.menefy@st.com)
Copyright (c) 2009 Sascha Hauer, Pengutronix
Copyright (c) 2010-2017 Pengutronix, Marc Kleine-Budde <kernel@pengutronix.de>
Copyright (c) 2014 David Jander, Protonic Holland
Copyright 2015, 2018 NXP
Copyright (C) 2001 Grant Grundler
Copyright (C) 2000, 2003 Maciej W. Rozycki
Copyright (C) 2010 Marek Vasut <marek.vasut@gmail.com>
Copyright (C) Manivannan Sadhasivam <manivannan.sadhasivam@linaro.org>
Copyright (C) 2004 - 2007 Paul Mundt
Copyright (C) Jan Henrik Weinstock <jan.weinstock@rwth-aachen.de> et al.
Copyright 2017 Google, Inc.
Copyright(c) 2003 - 2012 Intel Corporation. All rights reserved. All rights reserved.
Copyright 2008 by Martin Bachem (info@bachem-it.com)
Copyright (C) 1999 by Harald Koerfgen
Copyright (C) 2003 Vadim Catana, skystar@moldova.cc
Copyright (C) 2017 Imagination Technologies, Ltd. Author: Aleksandar Markovic <aleksandar.markovic@imgtec.com>

LICENCE TERMS (cont.)

Copyright (C) 2006 Silicon Graphics, Inc., Christoph Lameter <christoph@lameter.com>
Copyright (C) 2008-2014 Christoph Lameter
Copyright (c) 2005, Rusty Russell, IBM Corporation
Copyright (C) 2010-2012, NVIDIA CORPORATION. All rights reserved.
Copyright 2010 Texas Instruments Inc. Author: Graeme Gregory <gg@slimlogic.co.uk> Author: Jorge Eduardo Candelaria <jedu@slimlogic.co.uk>
Copyright (C) 2003-2004 MontaVista Software, Inc.
Copyright (C) 2006 OMICRON electronics GmbH
Copyright (C) 2007-2009 PetaLogix
Copyright (c) 2003 Hewlett-Packard Co Bjorn Helgaas <bjorn.helgaas@hp.com>
Copyright (C) 2001-2006 Storlink, Corp.
Copyright (C) 2008-2009 Paulius Zaleckas <paulius.zaleckas@gmail.com>
Copyright (c) 2003 Dimitromanolakis Apostolos <apostol@cs.utoronto.ca>
Copyright (c) 2004 Kouichi ONO <co2b@ceres.dti.ne.jp>
Copyright (C) 2008. Sebastian Siewior, Linutronix
Copyright (C) Andreas Gruenbacher, 2001
Copyright (C) Linus Torvalds, 1991, 1992
Copyright (C) 2015, 2016 Linaro Ltd.
Copyright (c) 2007 Jonathan Cameron <jic23@kernel.org>
Copyright (c) 2011 Analog Devices Inc.
Copyright (C) 2001 Fred Lewis <frederick.v.lewis@intel.com>
Copyright (C) 1998, 1999, 2001, 2003 Hewlett-Packard Co David Mosberger-Tang <davidm@hpl.hp.com>
Copyright (C) 1999 Srinivasa Prasad Thirumalachar <sprasad@sprasad.engr.sgi.com>
Copyright 2002, 2003 (C) Paul Mundt
Copyright (C) 2011 Guenter Roeck.
Copyright (C) 2011 - 2013 Xilinx Inc.
Copyright (C) 1994 by Florian La Roche Do not copy data too often around in the kernel. In nfs_file_read the return value of kmalloc wasn't checked. Put in a better version of read look-ahead buffering. Original idea and implementation by Wai S Kok elokokws@ee.nus.sg.
Copyright (C) 2004 Texas Instruments, Inc.
Copyright (C) 2008 Secret Lab Technologies Ltd.
Copyright 2018 SUSE Linux GmbH
Copyright 2018 Nick Piggin, Michael Ellerman, IBM Corp.
Copyright (C) 1995 Eric Schenk, Bruno Haible
Copyright(c) 1999 Manfred Spraul <manfred@colorfullife.com> Enforced range limit on SEM_UNDO
Copyright(c) 2001 Red Hat Inc Lockless wakeup
Copyright(c) 2003 Manfred Spraul <manfred@colorfullife.com>
Copyright(c) 2016 Davidlohr Bueso <dave@stgolabs.net> Further wakeup optimizations, documentation
Copyright(c) 2010 Manfred Spraul <manfred@colorfullife.com>
Copyright (c) Freescale Semiconductor
Copyright (c) 2017 Siemens AG
Copyright (c) 2015 Guenter Roeck
Copyright (C) Paul Mackerras 1997.
Copyright (C) 2014-2017 Mentor Graphics Inc.
Copyright (C) 2004 Anil S Keshavamurthy <anil.s.keshavamurthy@intel.com>
Copyright (c) 2004-2008, 2010-2014, Wind River Systems All rights reserved.
Copyright (C) 2001, 2002 Ralf Baechle (ralf@gnu.org)
Copyright 2010 Orex Computed Radiography
Copyright (C) 2001 Anton Blanchard <anton@au.ibm.com>, IBM
Copyright (C) 2007 Yoshihiro Shimoda
Copyright (C) 2016 Maxime Ripard Maxime Ripard <maxime.ripard@free-electrons.com>
Copyright (C) 2005 Nokia Corporation
Copyright (C) 2004 - 2007 Texas Instruments.
Copyright (C) 2007 Novell Inc.
Copyright (C) 2005 Andriy Skulysh Split from drivers/input/keyboard/hp600_keyb.c
Copyright (C) 2000 Yaegashi Takeshi (hp6xx kbd scan routine and translation table)
Copyright (C) 2000 Niibe Yutaka (HP620 Keyb translation table)

Copyright (C) 2014-2015 Renesas Solutions Corp.
Copyright (C) 2014-2015 Cogent Embedded, Inc.
Copyright (c) 2009-2010, Code Aurora Forum.
Copyright 2016 Intel Corp.
Copyright (C) 2002-04 Intel Corporation
Copyright (C) 2003-06 Adaptec Inc. * achim_leubner@adaptec.com> *
"Copyright 2009 Johannes Berg <johannes@sipsolutions.net> "
Copyright (C) 2008-2009 Tejun Heo <tj@kernel.org>
Copyright (C) 2000, 2001 Paolo Alberelli
Copyright (c) 2009 Intel Corporation. All rights reserved.
Copyright (C) 2009-2015 Lei Chuanhua <chuanhua.lei@lantiq.com>
Copyright (C) 2010 Matt Fleming
Copyright (c) 2005, 2010-2014, Wind River Systems All rights reserved.
Copyright (C) 2000 RidgeRun, Inc. Author: Greg Lonnon <glonnon@ridgerun.com>
Copyright (c) 2005, 2006 Stefano Brivio <stefano.brivio@polimi.it>
Copyright (C) 2007-2009 Texas Instruments, Inc.
Copyright (C) 1998 Anton Blanchard (anton@progsoc.uts.edu.au)
Copyright (c) 2008 Intel Corporation Author: Matthew Wilcox <willy@linux.intel.com>
Copyright (C) 2018-2019, Bootlin
Copyright (C) 2017, Free Electrons
Copyright (C) 2005-2007 Red Hat, Inc. All rights reserved.
Copyright (C) 2004 David Chaw <david_chaw@adaptec.com>
Copyright (c) 2013 by Tobias Hoffmann
Copyright (C) 2009 Steffen Klassert <steffen.klassert@secunet.com>
Copyright (C) 2019 Jacek Anaszewski <jacek.anaszewski@gmail.com>
Copyright (c) 2010 by Jarod Wilson <jarod@redhat.com>
Copyright (c) 2015, RapidIO Trade Association
Copyright (C) 2004-2006 International Business Machines Corp. Author(s): Michael A. Halcrow <mahalcro@us.ibm.com> Michael C. Thompson <mcthomps@us.ibm.com>
Copyright 2013 Intel Corporation
Copyright (C) 2007 MontaVista Software Inc.
Copyright (C) 2008 Zhang Rui <rui.zhang@intel.com>
Copyright (c) 2012 Heiko Stuebner <heiko@sntech.de>
Copyright (c) 2004 Li Shaohua <shaohua.li@intel.com>
Copyright (C) 2002, 2003 Christoph Hellwig
Copyright 2002 GALILEO TECHNOLOGY, LTD.
Copyright (C) 2014 Linaro Ltd Author: Ulf Hansson <ulf.hansson@linaro.org>
Copyright (C) 2001 Matthew Wilcox (willy at parisc-linux.org)
Copyright (C) 2002 Richard Hirst (rhirst with parisc-linux.org)
copyright(C) Copyright 2000 Oliver Neukum <Oliver.Neukum@lrz.uni-muenchen.de>
Copyright (C) 2005, Thibaut Varene <varenet@parisc-linux.org> Based on the OSS AD1889 driver by Randolph Chung <tausq@debian.org>
Copyright(c) 2016-2017 Intel Deutschland GmbH
Copyright (c) 2005, 2006 Maciej W. Rozycki
Copyright (C) 2003-2004 Aleksij Rempel <bug-track@fisher-privat.net> Jean Delvare <jdelvare@suse.de>
Copyright 2011-2013 Freescale Semiconductor, Inc.
Copyright 2018-2020 NXP
Copyright (c) 2001 William L. Pitts All rights reserved.
Copyright 1995-1998 by Leonard N. Zubkoff " <lnz@dandelion.com>"
Copyright (C) 2004 Tom Long Nguyen <tom.l.nguyen@intel.com>
Copyright 2014 Linaro Limited
Copyright (C) 2010 Tobias Klauser <tklauser@distanz.ch>
Copyright (c) 2017, EPAM Systems
Copyright 2008 Stefan Roeser <sr@denx.de>, DENX Software Engineering
Copyright 2009 Harris Corporation, Steven A. Falco <sfalco@harris.com>
Copyright (C) 2010 Intel Corporation <tony.luck@intel.com>
Copyright (C) 2013 SuSE Labs Borislav Petkov <bp@suse.de> - runtime services VA mapping

LICENCE TERMS (cont.)

Copyright (C) 2013 Richard Weinberger <richard@nod.at>
Copyright (C) 2014 Google Inc., Author: Daniel Walter <dwalter@google.com>
Copyright (c) 1999
Copyright (c) 2000
Copyright (c) 2009
Copyright (C) 2015-2017 Roger Shimizu <rogershimizu@gmail.com>
Copyright (C) Tomi Manninen OH2BNS (oh2bns@sral.fi)
Copyright (C) Frederic Rible F1OAT (frible@teaser.fr)
Copyright (C) 2001 Takashi Oe
Copyright (C) Christoph Hellwig 2007
Copyright (C) 2001 - 2008 Paul Mundt
Copyright (C) 2000 - 2001 YAEGASHI Takeshi
Copyright (C) 2001 M. R. Brown
Copyright (C) 2010 Google, Inc.
Copyright (C) 2010 NVIDIA Corporation
Copyright (C) 2009-2011 ST-Ericsson AB
Copyright (c) 2004 Pavel Machek <pavel@ucw.cz>
Copyright (c) 2009 Rafael J. Wysocki, Novell Inc.
Copyright (C) 2012 Bojan Smojver <bojan@rursive.com>
"Copyright (C) 2000 Andre Hedrick <andre@suse.com> "
Copyright (C) 1999 - 2001 Greg Kroah-Hartman (greg@kroah.com) Bill Ryder (bryder@sgi.com)
Copyright (C) 2002 Kuba Ober (kuba@mareimbrium.org)
Copyright (C) 2005 Nokia Corporation OMAP2 support by Juha Yrjola API improvements and OMAP2 clock framework support by Timo Teras
Copyright (C) 2018-19 Sang Engineering, Wolfram Sang
Copyright (C) 2003 Carlos O'Donell <carlos at parisc-linux.org>
Copyright (c) 2018 Guillaume Douézan-Grard
Copyright (C) 2000 ARM Limited, Deep Blue Solutions Ltd. hacked for non-paged-MM by Hyok S. Choi, 2004.
Copyright 2017 IBM Corporation
Copyright (c) 2005 Rick Koch <n1gp@hotmail.com>
Copyright (c) 1999-2000 Takashi iwai <tiwai@suse.de>
Copyright (c) 2012 Samsung Electronics Co., Ltd. http://www.samsung.com
Copyright (C) 2011-2012 Jean-Christophe PLAGNIOL-VILLARD <plagnioj@jcrosoft.com>
Copyright (C) 2002 Red Hat, Inc. All rights reserved.
Copyright (C) 2006 David Brownell
Copyright (C) 2009 Matthias Fuchs (rx8025 support)
Copyright (C) 2012 Bertrand Achard (nvram access fixes)
Copyright (C) 2009 - 2010 Ivo van Doorn <lvdoorn@gmail.com>
Copyright (C) 2008 Jim Paris <jim@jtan.com>
Copyright (C) 2009 Jean-Francois Moine http://moinejf.free.fr
Copyright (C) 1999 AbsoluteValue Systems, Inc. All Rights Reserved. This file originally written by:
Copyright (C) 2001 Jean Tourrilhes <jt AT hp.hp.com> And is now maintained by:
Copyright(C) Copyright David Gibson, IBM Corp. 2002-2003.
Copyright (C) 2015 Nobuo Iwata
Copyright 2015-2017 Pengutronix, Lucas Stach <kernel@pengutronix.de>
Copyright (C) 1998 Trent Piepho <xzyzy@u.washington.edu>
Copyright (C) 1998 Ben Pfaff <blp@gnu.org>
Copyright (C) 1999 Christoph Bartelmus <lirc@bartelmus.de>
Copyright (C) 2007 Andrei Tanas <andrei@tanac.ca> (suspend/resume support)
Copyright (C) 2016 Sean Young <sean@mess.org> (port to rc-core)
Copyright (C) 2001 Altera Corporation hacked for non-paged-MM by Hyok S. Choi, 2003.
Copyright (c) 2013-2015 Samsung Electronics Co., Ltd. http://www.samsung.com
Copyright (c) 2007 Arnaldo Carvalho de Melo <acme@redhat.com>
Copyright 2009, 2010, Christian Lamparter <chunkeey@googlemail.com>
Copyright (C) 2017 Andes Technology Corporation
copyright(c) Copyright 2007 Vlad Drukker <vlad@storewiz.com> added support for W83627THF.
copyright(c) Copyright 2003,2007 Pádraig Brady <P@draigBrady.com>

Copyright (c) 2012 Jeff Layton <jlayton@redhat.com> All rights reserved.
copyright notice, this list of conditions and the following disclaimer in the documentation and/or other materials provided with the distribution. 3. Neither the name of the University nor the names of its contributors may be used to endorse or promote products derived fro
Copyright (c) 2004 Simtec Electronics Ben Dooks <ben@simtec.co.uk>
Copyright 2014 Hans de Goede <hdegoede@redhat.com>
Copyright (C) 2008-2009 Angelo Arrifano <miknix@gmail.com>
Copyright (C) 1996,1997 Jakub Jelinek (jj@sunsite.mff.cuni.cz)
Copyright (C) 2008 Ira W. Snyder <iws@ovro.caltech.edu>
Copyright 2006-2009 Solarflare Communications Inc.
Copyright 1997 Linus Torvalds
Copyright (C) 2009 Palm All Rights Reserved
Copyright (c) 2015 Lukasz Majewski <l.majewski@samsung.com> Anand Moon <linux.amoon@gmail.com>
Copyright 2004-2016 Freescale Semiconductor, Inc. All Rights Reserved.
copyright information. 08-25-16 02.00.14 Added new values for the Flags field of Toolbox Clean Tool Request Message. 07-22-18 02.00.15 Added defines for new TOOLBOX_PCIE_LANE_MARGINING tool. Added option for DeviceInfo field in ISTWI tool. 1
Copyright (C) 2003 BULL SA.
Copyright (C) 2004-2006 Silicon Graphics, Inc.
Copyright (C) 2007 Daniel Gimpelevich <daniel@gimpelevich.san-francisco.ca.us>
Copyright (C) 2007-2012 Florian Fainelli <f.fainelli@gmail.com>
Copyright (C) 2010 Bernhard Loos <bernhardloos@googlemail.com>
Copyright (C) 2007 Lemote, Inc. & Institute of Computing Technology Author: Fuxin Zhang, zhangfx@lemote.com
Copyright (C) 2013-2017 Andes Technology Corporation
Copyright (C) 2001 Jeff Garzik (jgarzik@pobox.com)
Copyright (C) 2007-2016 Broadcom Corporation.
Copyright (C) 2018 Broadcom. All Rights Reserved. The term "Broadcom" refers to Broadcom Inc. and/or its subsidiaries.
Copyright (C) 2011 The Chromium OS Authors.
Copyright (C) 2006 Texas Instruments, Inc.
Copyright (C) 2003 MontaVista Software, Inc. Author: George G. Davis <gdavis@mvista.com> or <source@mvista.com>
Copyright (C) 2006 by Russ Cox <rsc@swtch.com>
Copyright (c) 2005-2008 Stefano Brivio <stefano.brivio@polimi.it>
Copyright (C) 1997, 1998, 1999 Jakub Jelinek (jj@ultra.linux.cz)
Copyright (C) 2017 Johan Hovold <johan@kernel.org>
Copyright 2018 Angelo Dureghello <angelo@sysam.it>
Copyright (c) 2007-2008 Bartlomiej Zolnierkiewicz
Copyright (C) 2004 Keith M Wesolowski (wesolows@foobazco.org)
Copyright (c) 2018 Kontron Electronics GmbH
Copyright (C) 2013 GSI Helmholtz Centre for Heavy Ion Research GmbH
Copyright (C) 2001, 2003 Rusty Russell
Copyright (C) 1999, 2000, 2001 by Ralf Baechle
Copyright (C) 1999, 2000 by Silicon Graphics, Inc.
Copyright (C) 2003,2004 Neil Whelchel (koyama@firstlight.net)
Copyright (C) 2002, 2008 by Andreas Mohr <hw7oshyv3001@sneakemail.com>
Copyright (c) 2010, NVIDIA Corporation
Copyright (C) 2006 Kyle McMartin <kyle at parisc-linux.org>
Copyright (C) 2012 Paul Mundt
Copyright (c) 2007 Barry Carter <Barry.Carter@robotfuzz.com>
Copyright (C) 2006 Til Harbaum (Till@Harbaum.org)
Copyright (C) 2014-2015 Pali Rohár <pali.rohar@gmail.com>
Copyright 2005-2009 Freescale Semiconductor, Inc. All Rights Reserved.
Copyright (C) 2006, OmniVision
Copyright (c) 2006 Edgar Hucek <gimli@dark-green.com>
Copyright 2017~2018 NXP Dong Aisheng <aisheng.dong@nxp.com>
Copyright (C) 2013, 2018 Wolfram Sang <wsa@the-dreams.de>

LICENCE TERMS (cont.)

Copyright (C) 2011 Kees Cook <keescook@chromium.org>
Copyright (c) 2012-2017 Qualcomm Atheros, Inc.
Copyright (c) 2006-2012 Wilocity
Copyright (c) 2004 Herbert Xu <herbert@gondor.apana.org.au>
Copyright (C) 2010 WindRiver Systems, Inc. authors: Andreas Kies <andreas.kies@windriver.com> Vlad Lungu <vlad.lungu@windriver.com>
Copyright (C) 2010. Ilya Yanok, Emcraft Systems, yanok@emcraft.com
Copyright 2005 Alejandro Vidal Mata & Javier Vidal Mata. and on the fsaa1655g driver, which is:
Copyright 2006 Martin Večeřa.
Copyright (C) 2010-2011 Julius Baxter <julius.baxter@orsoc.se>
Copyright (c) 2011 Pierre Tardy <tardyp@gmail.com> Inspired from pci fixup code:
Copyright (c) 1999 Martin Mares <mj@ucw.cz>
Copyright (C) 2008 David S. Miller <davem@davemloft.net>
Copyright (C) 1991, 1992, 1995 Linus Torvalds
, Copyright 2005-2009 Simtec Electronics"
Copyright (C) 2004 - 2006 Paul Mundt
Copyright (C) 2003-2004, Paul Clements, SteelEye Technology, Inc.: added disk storage for bitmap changes to allow various bitmap chunk sizes
Copyright (C) 1999, 2000 Greg Kroah-Hartman (greg@kroah.com)
Copyright (c) 2009 Tomas Hanak
Copyright (c) 2012 Nikolai Kondrashov
Copyright (C) 2001 Kanoj Sarcar
Copyright (C) 1996 Eddie C. Dost (ecd@brainaid.de)
Copyright (C) 1996,98,99 Jakub Jelinek (jj@sunsite.mff.cuni.cz)
Copyright (C) 2004 ICT CAS Author: Li xiaoyu, lixy@ict.ac.cn
Copyright (C) 2007 Lemote, Inc. Author: Fuxin Zhang, zhangfx@lemote.com
Copyright (c) 2012 David Airlie <airlied@linux.ie>
Copyright (c) 2013 David Herrmann <dh.herrmann@gmail.com>
Copyright (C) 2000-2001,2005-2007 Toshiba Corporation
Copyright (C) 2014-2015 Renesas Electronics Corporation
Copyright (C) 2007 - 2011 Motorola, Inc.
Copyright (C) 2014 Intel Corporation Author: Ramakrishna Pallala <ramakrishna.pallala@intel.com>
Copyright (C) 1993, 1994 Alain Knaff
Copyright (C) 1998 Alan Cox
Copyright (C) 2015 Andrew Lutomirski <luto@kernel.org>
Copyright (c) 2005 Richard Purdie
Copyright (C) 2003-2005,2008 David Brownell
copyright(c) Copyright 2001 Rodolfo Giometti <giometti@ascensit.com>
copyright(c) Copyright 2002 Rob Radez <rob@osinvestor.com>
copyright(c) Copyright 1996-1997 Alan Cox <alan@lxorguk.ukuu.org.uk>, All Rights Reserved.
copyright(c) Copyright 1995 Alan Cox <alan@lxorguk.ukuu.org.uk>*
Copyright (C) 2015 Ondrej Zary
Copyright (C) 1997 Carnegie Mellon University
Copyright (C) 2011 Thomas Chou
Copyright (C) 2011 Walter Goossens
copyright (c) 2001,2002 Sun Microsystems (thockin@sun.com)
copyright 2001,2002 Manfred Spraul (manfred@colorfullife.com)
copyright 2004 Harald Welte <laforge@gnumonks.org>
Copyright (c) 2007 Steven Toth <stoth@linuxtv.org>
Copyright (c) 2009 Devin Heitmueller <dheitmueller@kernellabs.com>
Copyright (c) 2009 Davide Ferri <d.ferri@zero11.it>
Copyright (c) 2010 Istvan Varga <istvan_v@mailbox.hu>
Copyright(C) 1999 Ulf Carlsson (ulfc@thepuffingruop.com)
Copyright (C) 2007-2010, 2011-2012 Synopsys, Inc. (www.synopsys.com)
Copyright (c) 2016 Andrew Lunn <andrew@lunn.ch>
Copyright (C) 2000 Manfred Spraul further cleanups power management. support for big endian descriptors
Copyright (C) 2001 Manfred Spraul ethtool support (jgarzik) Replace some MII-related magic numbers with constants (jgarzik)
Copyright (C) 2017 Stafford Horne <shorne@gmail.com>
Copyright (C) 2013 ARM Ltd.
Copyright (C) 2003 Wolfson Microelectronics PLC
Copyright(c) 2003 Benjamin Herrenschmidt <benh@kernel.crashing.org> Armin Kuster <akuster@mvista.com> Johnnie Peters <jpeters@mvista.com>
Copyright (C) 2008, 2011 Nokia Corporation Kalle Jokiniemi Paul Walmsley
Copyright (C) 2010 Takashi Yoshii
Copyright (c) 2003 ARM Limited, All Rights Reserved
Copyright (c) 2013 Daniel Mack <zonque@gmail.com>
Copyright (C) 2016 Petr Kulhavy, Barix AG <petr@barix.com>
Copyright (C) 2018 Jerome Brunet, Baylibre SAS <jbrunet@baylibre.com>
Copyright (C) 2002 Patrick Mansfield
Copyright (C) 2015 Andrey Smetanin <asmetanin@virtuozzo.com>
Copyright (C) 2017 Takashi Iwai <tiwai@suse.de>
Copyright (C) 2006 Lineo Solutions, Inc.
Copyright (C) 2010 Intel Corporation, Lin Ming <ming.m.lin@intel.com>
Copyright (C) 2009 Nokia Corporation and/or its subsidiary(-ies).
Copyright (C) 2008 David Brownell
Copyright (C) 1999 - 2002 Greg Kroah-Hartman (greg@kroah.com)
Copyright (C) 2000 Peter Berger (pberger@brimson.com)
Copyright (C) 2000 Al Borchers (alborchers@steinerpoint.com)
Copyright (C) 2011-2013 Gabor Juhos <juhosg@openwrt.org>
Copyright (C) 2014-2015 Felix Fietkau <nbd@nbd.name>
Copyright (C) 2007-2008 Marvell Ltd.
Copyright (C) 1999 Ralf Baechle
Copyright (C) 1994, 1995, 1996 by Andreas Busse
Copyright (c) 1998-2000 Harald Koerfgen
Copyright (C) 1998-2001 Gerard Roudier <groudier@free.fr>
Copyright (C) 1997 Richard Waltham <dormouse@farsrobt.demon.co.uk>
Copyright (C) 2000 MIPS Technologies, Inc. All rights reserved.
Copyright 2010, Christian Lamparter <chunkeey@googlemail.com>
"Copyright (C) 2013 Texas Instruments Inc. Contact: Eduardo Valentin <eduardo.valentin@ti.com>"
"Copyright (C) 2012 Samsung Electronics Co., Ltd(http://www.samsung.com)"
Copyright (C) 2002, 2003 Maciej W. Rozycki
Copyright (C) 2010 Paolo Valente <paolo.valente@unimore.it> Arianna Avanzini <avanzini@google.com>
Copyright (C) 2017 Paolo Valente <paolo.valente@linaro.org>
copyright IBM Corp. 2007
Copyright (c) 1999 Brian Gerst
Copyright (C) 2015 Clemens Gruber <clemens.gruber@pqgruber.com>
Copyright (c) 2010 Jarod Wilson <jarod@wilsonet.com>
copyright(C) 2001-2003 Greg Kroah-Hartman (greg@kroah.com)
Copyright(C) 2005, Thomas Gleixner <tglx@linutronix.de>
Copyright(C) 2006, Hans J. Koch <hjk@hansjoch.de>
Copyright(C) 2006, Greg Kroah-Hartman <greg@kroah.com>
Copyright (c) 2010, 2012, 2018 The Linux Foundation. All rights reserved.
Copyright (C) 2006 Intel Corp, Zou Nan hai <nanhai.zou@intel.com>
Copyright (c) 2019-2020 Oracle Author: Matthew Wilcox <willy@infradead.org>
Copyright (C) ST-Ericsson SA 2010 Author: Stewart Mathers <stewart.mathers@stericsson.com>
Copyright © 2014 Intel Corporation Daniel Vetter <daniel.vetter@ffwll.ch>
Copyright (C) Terry Dawson VK2KTJ (terry@animats.net)
Copyright (c) 2004 TDF
Copyright (c) 2003 Greg Kroah-Hartman (greg@kroah.com)
Copyright (c) 2008 Henrik Rydberg (rydberg@euromail.se)
Copyright (c) Copyright 2014 Cisco Systems, Inc.
Copyright (C) 2003 Greg Kroah-Hartman <greg@kroah.com>
Copyright (C) 2003 IBM Corp.

LICENCE TERMS (cont.)

Copyright (C) 2008 Andres Salomon <dilinger@debian.org>
Copyright (c) 2006-2012 Jiri Kosina
Copyright (c) 2012 Henrik Rydberg
Copyright (c) 2008 Codehermit
Copyright (c) 2010 by Samsung Electronics Author: Michal Nazarewicz <mina86@mina86.com>
Copyright (C) 2016 Kees Cook
Copyright 2003 PathScale, Inc.
Copyright (C) 2018 Linus Wallej <linus.wallej@linaro.org>
Copyright 1999-2000 D. Jeff Dionne, <jeff@rt-control.com>
Copyright (C) 2010 Matthias Fuchs <matthias.fuchs@esd.eu>, esd gmbh
Copyright (c) by David Shust, dshust@shuststring.com.
copyright,no preemphasis,PCM coder,original,48000Hz */ snd_ac97_write_cache(ac97, AC97_CSR_SPDIF, 0x0a20)
copyright,no preemphasis,PCM coder,original,48000Hz */ snd_ac97_write_cache(ac97, AC97_CXR_AUDIO_MISC, snd_ac97_read(ac97, AC97_CXR_AUDIO_MISC) & ~(AC97_CXR_SPDIFEN|AC97_CXR_COPYRGT|AC97_CXR_SPDIF_MASK))
copyright,no preemphasis,PCM coder,original */ snd_ac97_write_cache(ac97, AC97_YMF7X3_DIT_CTRL, 0xa201)
Copyright (C) 2006-2008 Jarkko Lavinen
Copyright (C) 2006-2008 Adrian Hunter
Copyright 2000 (c) Linuxcare Canada, Alex deVries
Copyright 2000-2003 (c) Helge Deller
Copyright 2001 (c) Matthieu Delahaye
Copyright 2001 (c) Jean-Christophe Vaugeois
Copyright 2003 (c) Laurent Canet
Copyright 2004 (c) Stuart Brady
Copyright Altera Corporation (C) 2014-2016. All rights reserved.
Copyright 2011-2012 Calxeda, Inc.
Copyright (C) 2000 Pavel Machek <pavel@ucw.cz>
Copyright (C) 2002,2003 Andi Kleen <ak@suse.de>
Copyright 2007 David Gibson, IBM Corporation. Based on cuboot-83xx.c, which is:
Copyright (C) 2004 John Steele Scott <toojays@toojays.net>
Copyright (C) 2002 Simon Evans <spse@secret.org.uk>
Copyright (C) 2009 Jean-Francois Moine (<http://moinejf.free.fr>)
Copyright (c) 1999 Colin Van Dyke
Copyright (C) 2003 Paul Andreassen <paul@andreassen.com.au>
Copyright (C) 2014 Renesas Electronics Corporation
Copyright (C) 2014-2017 Glider bvba
Copyright (C) 2014-2017 Netronome Systems\n", nfp_driver_name)
Copyright 2012 Kim Phillips, Freescale Semiconductor.
Copyright (C) 2012 Scott Lin <scott.lin@tw.synaptics.com>
Copyright (C) 2005-6 Patrick Boettcher <pb@linuxtv.de>
Copyright (C) 2007 Eric Biederman <ebiederm@xmission.com>
Copyright (C) 2012-2014 Canonical Ltd Authors: Rob Clark <robdclark@gmail.com> Maarten Lankhorst <maarten.lankhorst@canonical.com>
Copyright (C) 1995, 1996 Paul M. Antoine
Copyright (C) 1998 Ulf Carlsson
Copyright (C) 1999 Silicon Graphics, Inc. Kevin D. Kissell, kevink@mips.com and Carsten Langgaard, carsten@mips.com
Copyright (C) 2002, 2003, 2004, 2005, 2007 Maciej W. Rozycki
Copyright (C) 2000, 2001, 2012 MIPS Technologies, Inc. All rights reserved.
Copyright (c) 2019 Greg Kroah-Hartman <gregkh@linuxfoundation.org>
Copyright (c) 2019 Google Inc.
Copyright 2002 TimeSys Corp. Added ethtool/mii-tool support,
Copyright 2004 Matt Porter <mporter@kernel.crashing.org> Update: 2004 Bjoern Riemer, riemer@fokus.fraunhofer.de or riemer@riemer-nt.de: fixed the link beat detection with ioctls (SIOCGMIIPHY)
Copyright 2006 Herbert Valerio Riedel <hvr@gnu.org> converted to use linux-2.6.x's PHY framework
Copyright (c) 2010, Microsoft Corporation.
Copyright (c) 2011, Novell Inc.

Copyright (c) 2012-2013 Xilinx
Copyright (C) 2008 Antonio Ospite <ospite@studenti.unina.it>
Copyright (C) 2008 Jim Paris <jim@jtan.com>
Copyright (C) 2013 Marvell
Copyright (C) 1994 - 2000, 06 Ralf Baechle
Copyright (C) 2004, 2005 MIPS Technologies, Inc. All rights reserved. Author: Maciej W. Rozycki <macro@mips.com>
Copyright (C) 1999, 2006 by Ralf Baechle
Copyright (C) 2017 NXP
Copyright 2006-2007 Freescale Semiconductor, Inc. All Rights Reserved.
Copyright 2009 Ilya Yanok, Emcraft Systems Ltd, yanok@emcraft.com
Copyright (C) 2011 Wistron Co.Ltd Joseph Lai <joseph_lai@wistron.com> and trimmed down by Alan Cox <alan@linux.intel.com> in turn based on bma023.c. Device behaviour based on a misc driver posted by Nathan Royer in 2011.
Copyright (C) 2003 Marcel Holtmann <marcel@holtmann.org>
Copyright (C) 2000-2002 Paul Bristow <paul@paulbristow.net>
Copyright (C) 2005 Bartlomiej Zolnierkiewicz
Copyright (C) 1995, 1999 Silicon Graphics
Copyright (C) 2009 IBM Corporation
Copyright (C) 2009 Frederic Weisbecker <fweisbec@gmail.com>
Copyright (C) 1996,97,98 Ralph Metzler (rjkm@metzlerbros.de) Marcus Metzler (mocm@metzlerbros.de)
Copyright(c) 1999,2000 Gerd Knorr <kraxel@goldbach.in-berlin.de>
Copyright (C) 2010 Red Hat, Inc. All Rights Reserved.
Copyright 1997,1998 Jakub Jelinek (jj@sunsite.mff.cuni.cz)
Copyright (C) 2020 Intel Corporation
Copyright (C) 2020 Intel Corporation All rights reserved.
Copyright (C) 2013 Oliver Smith <oliver@8.c.9.b.0.7.4.0.1.0.0.2.ip6.arpa>
Copyright (C) 2011 Renesas Solutions Corp.
Copyright (C) 2008 Peter Griffin <pgriffin@mpc-data.co.uk>
Copyright (C) 2008 Nokia Corporation Author: David Brownell Modified: Klaus Schwarzkopf <schwarzkopf@sensortherm.de>
Copyright (C) 1998,1999 Philip Blundell
Copyright (C) 2000 Linus Torvalds and Transmeta Corp.
Copyright (C) 2009 Samsung Electronics Author: Michal Nazarewicz <mina86@mina86.com> All rights reserved.
Copyright (C) 2003-2004 Luis R. Rodriguez <mcgrof@ruslug.rutgers.edu>
Copyright (C) 2007-2008 Steven Rostedt <srostedt@redhat.com>
Copyright (C) 2008 Ingo Molnar <mingo@redhat.com>
Copyright: (C) 2010-2012 Gilles Muller, INRIA/LiP6. URL: <http://coccinelle.lip6.fr/> Comments: requires at least Coccinelle 0.2.4, lex or parse error otherwise
Copyright (C) 2014 Seth Jennings <sjenning@redhat.com>
Copyright 2013 Codethink Ltd.
Copyright 2010-2015 Renesas Electronics Corporation
Copyright IBM Corp. 2019
Copyright (C) 2010 - 2012 Paul Mundt
Copyright (C) 2012 - 2013 Samsung Electronics Co., Ltd. Author: Sylwester Nawrocki <s.nawrocki@samsung.com>
Copyright (c) 2009 Secret Lab Technologies Ltd.
Copyright (C) 2007 Marcel Holtmann <marcel@holtmann.org>
Copyright (C) 2011 Gabor Juhos <juhosg@openwrt.org>
Copyright (C) 2009 Bartlomiej Zolnierkiewicz
Copyright (C) 1994, Karl Keyte: Added support for disk statistics
Copyright(C) 2000 Andrea Arcangeli <andrea@suse.de> SuSE Queue request tables / lock, selectable elevator, Jens Axboe <axboe@suse.de> kernel-doc documentation started by NeilBrown <neilb@cse.unsw.edu.au> July2000 bio rewrite, highmem i/o, etc, Jens Axboe <axboe@suse.de> - may 2001
Copyright (c) 2005-2007, Wind River Systems All rights reserved.
Copyright (C) 1997,1999,2000 Jakub Jelinek (jakub@redhat.com)
Copyright 1999 Ben Pfaff and Petr Vandrovec Based on VGA info at <http://www.goodnet.com/~tinara/FreeVGA/home.htm>

LICENCE TERMS (cont.)

Copyright(c) 1998 Gerd Knorr
Copyright (C) 2016-2017 Christoph Hellwig.
Copyright (C) 2010 Fitipower Integrated Technology Inc
Copyright (C) 1999, 2000 Ingo Molnar
Copyright (C) 2002, 2003 H. Peter Anvin
Copyright (C) 2009 Renesas Solutions, Inc. All rights reserved.
Copyright (C) 2018-2020 Intel Corporation
Copyright (C) 2016 Pengutronix, Philipp Zabel <p.zabel@pengutronix.de>
Copyright (C) 2016 Zodiac Inflight Innovations
Copyright (C) 2012 Texas Instruments Author: Rob Clark <robdclark@gmail.com>
Copyright (C) 1999 VMware, Inc.
Copyright (C) Steven Whitehouse , Louis D. Langholtz <ldl@aros.net>
Copyright (C) 2016 Imagination Technologies
Copyright (c) 2010 Baruch Siach <baruch@tkos.co.il> Orex Computed Radiography
Copyright (C) 1994, 95, 96, 2003 by Wind River Systems Written by Fredrik Markstrom
Copyright (c) 2016-2018 Vadim Pasternak <vadimp@mellanox.com>
Copyright (C) 2009 Lemote, Inc. Author: Zhangjin Wu, wuzhangjin@gmail.com
Copyright (c) by Takashi Iwai <tiwai@suse.de> Jaroslav Kysela <perex@suse.cz>
Copyright (C) 2006 Nicolas Boichat <nicolas @boichat.ch>
Copyright (C) 2006 Felipe Alfaro Solana <felipe_alfaro @linuxmail.org>
Copyright (C) 2007 Julien BLACHE <jb@jblache.org>
Copyright (C) 2006 NTT (Nippon Telegraph and Telephone Corporation)
Copyright (C) Tom Long Nguyen (tom.l.nguyen@intel.com)
Copyright (C) 2016 Christoph Hellwig.
Copyright (C) 2004 PathScale, Inc
Copyright (c) 2001 Daniel Engstrom <5116@telia.com>
Copyright (c) 2015, 2019, The Linux Foundation. All rights reserved.
Copyright (c) 2016 John Crispin <john@phrozen.org>
Copyright (c) 2012 Pablo Neira Ayuso <pablo@netfilter.org>
Copyright (c) 2012 Intel Corporation
Copyright IBM Corp. 2000
Copyright (c) 2019 Linaro Ltd.
Copyright 2007 David Gibson <dwg@au1.ibm.com>, IBM Corporation.
Copyright © 2011 David Klekamp IBM Corporation
Copyright (c) 2011 Jiri Kosina
Copyright © 2016 Hauke Mehrtens <hauke@hauke-m.de>
Copyright (c) 2009 Intel Corporation
Copyright (C) 2011 Tejun Heo <tj@kernel.org>
Copyright (C) 2010 Benjamin Herrenschmidt <benh@kernel.crashing.org>
Copyright: [copy] 2005-2006: Ingo Molnar
Copyright (c) 1997 Dan Malek (dmalek@jlc.net)
Copyright (C) 2009 Intel Corporation. All rights reserved.
Copyright (C) 2002-2006 Novell, Inc. Jan Beulich <jbeulich@novell.com>
Copyright (C) 2000, 2001, 2002, 2003, 2005 Maciej W. Rozycki
Copyright (c) 2010 - 2011 Michal Simek <monstr@monstr.eu>
Copyright (c) 2010 - 2011 PetaLogix
Copyright (c) 2019 SED Systems, a division of Calian Ltd.
Copyright (C) Nokia Corporation
Copyright 2008-2010 Freescale Semiconductor, Inc.
Copyright (C) 2008-2009 Gabor Juhos <juhosg@openwrt.org>
Copyright (c) 2002 Mark D. Stuebaker <mdsxyz123@yahoo.com> Aaron M. Marsh <amarsh@sdf.lonestar.org>
Copyright (c) Roman Volkov <v1ron@mail.ru>
Copyright(C) 2004 Dan Brown <dan_brown@ieee.org>
Copyright(C) 2004 Kalev Lember <kalev@smartlink.ee>
Copyright (C) 2000 Netgem S.A. converted to the generic Reed-Solomon library by Thomas Gleixner <tglx@linutronix.de>
Copyright (C) 2004-2008 Red Hat, Inc. All rights reserved.

Copyright(c) if there is a "noexp" flagged request anywhere in the queue
Copyright (C) 2013 Regents of the University of California
Copyright (C) 1994 Florian La Roche
Copyright (C) 2001 Compaq Computer Corporation
Copyright (C) 2004, 2005 Oracle.
Copyright (c) 2016 BayLibre, SAS. Author : Neil Armstrong <narmstrong@baylibre.com>
Copyright (C) 2004 Albert Herranz LANDISK/sh4 supported by kogiidena
Copyright (C) 2008,2009 Albert Herranz
Copyright (C) 2017-2018 Jonathan Neuschäfer
Copyright (C) 1991-2002 SciTech Software, Inc. All rights reserved.
Copyright 1998 by Egbert Eich <Egbert.Eich@Physik.TU-Darmstadt.DE>
Copyright (c) 2010 Signal 11 Software
Copyright (C) 2004 Texas Instruments.
Copyright (C) 2005 David Brownell (ported to 2.6 SPI interface)
Copyright (C) 2006 Nokia
Copyright 2006, Michael Buesch
Copyright by Intel Corp., 2002 Louis Zhuang (louis.zhuang@intel.com)
Copyright (C) 2008-2009 Paulius Zaleckas <paulius.zaleckas@teltonika.lt>
Copyright (C) 2007 by Thomas Bogendoerfer
Copyright (C) 2019 Linus Walleij
Copyright (C) 2010 Joonas Lahtinen <joonas.lahtinen@gmail.com>
Copyright (C) 2015 Hauke Mehrtens <hauke@hauke-m.de>
Copyright (C) 2018 MIPS Tech, LLC
Copyright 2006 David Woodhouse <dwmw2@infradead.org>
Copyright 2002 Tungsten Graphics, Inc.
Copyright 2005 Thomas Hellstrom. All Rights Reserved.
Copyright (C) 2008 Google Inc
Copyright (C) 2009 Bob Copeland (me@bobcopeland.com)
Copyright (C) 2002 Red Hat, Inc.
Copyright (C) 2017 Pengutronix, Philipp Zabel <kernel@pengutronix.de>
Copyright (C) 2016 Semihalf Author: Tomasz Nowicki <tn@semihalf.com>
Copyright (C) 2009 Ilya Yanok, Emcraft Systems Ltd, <yanok@emcraft.com>
Copyright (c) 2005-2009 Michael Buesch <m@buesch.ch>
Copyright (c) 2010-2011 Rafał Mitecki <zajec5@gmail.com>
Copyright (c) 2009 Albert Herranz <albert_herranz@yahoo.es>
Copyright (C) 2005 Jesper Juhl <jj@chaosbits.net>
Copyright (C) 2009-2010 Sven Anders <anders@anduras.de>, ANDURAS AG. Watchdog driver part Based partially on fschmd driver,
Copyright 2007-2008 by Hans de Goede)
Copyright (c) 2014, Intel Corporation. Author: David Cohen <david.a.cohen@linux.intel.com>
Copyright 2006-2007 Jiri Benc <jbenc@suse.cz>
Copyright 2007-2008, Intel Corporation
Copyright 2015, Freescale Semiconductor, Inc.
Copyright (C) 2006 MontaVista Software, Inc.
Copyright (C) Zhang Yanmin (yanmin.zhang@intel.com)
Copyright (C) Shaohua Li (shaohua.li@intel.com)
Copyright (c) 2005, Bull S.A. Written by Pierre Peiffer <pierre.peiffer@bull.net>
Copyright (C) 2008 Rod Whitby <rod@whitby.id.au>
Copyright (C) 2008 Red Hat, Inc. All rights reserved. maintained by open-iscsi@googlegroups.com
Copyright (C) Ashok Raj<ashok.raj@intel.com>, Intel Corporation 2004
Copyright (c) 2006, 2007 Maciej W. Rozycki
Copyright (C) 2008 Yoshinori Sato
Copyright 2007-2008 rPath, Inc. - All Rights Reserved
Copyright (C) 2016 Laurent Pinchart
Copyright (c) 2010 Johnathon Harris <jmharris@gmail.com>
Copyright (c) 2011 Jiri Kosina
Copyright (c) 2016 Brendan McGrath <redmcg@redmandi.dyndns.org>

LICENCE TERMS (cont.)

Copyright (c) 2016 Victor Vlasenko <victor.vlasenko@sysgears.com>
Copyright (c) 2016 Frederik Wenigwieser <frederik.wenigwieser@gmail.com>
Copyright (c) 1998, 1999 Kyösti Mälkki <kmalkki@cc.hut.fi>
Copyright (C) 2003 SUGIOKA Toshinobu
Copyright (C) 2003-2009 Yoichi Yuasa <yuasa@linux-mips.org>
Copyright 2002 MontaVista Software Inc.
copyright(c) Copyright 2001 Grant Grundler (c) Copyright 2001 Hewlett-Packard Company
Copyright(c) Copyright 2001 Grant Grundler (c) Copyright 2001 Hewlett-Packard Company
Copyright (c) 2001-2002 PPC64 team, IBM Corp 64-bit and Power4 support
Copyright (c) 2005 Benjamin Herrenschmidt, IBM Corp behn@kernel.crashing.org Merge ppc32 and ppc64 implementations
Copyright (c) 2007 Manuel Lauss <mano@roarinelk.homelinux.net>
Copyright (C) 1997 Theodore Ts'o
Copyright (C) 2006 Arnd Bergmann <arnd@arndb.de>, IBM Corp.
Copyright (C) 2002, 2004 Maciej W. Rozycki
Copyright (c) 2000 - 2019 Intel Corporation"
Copyright (C) 2011 Colin Leitner <colin.leitner@googlemail.com>
Copyright (C) 2011 Cavium Networks, Inc. Author: Deng-Cheng Zhu
Copyright (C) 2010 - 2016 Cavium, Inc.
Copyright (C) 2018 Google LLC
Copyright (C) 2003, 2004 Richard Curnow
Copyright(c) 2018 Intel Corporation."
Copyright (C) 2000 - 2007 Jeff Dike (jdike@addtoit.linux.intel}.com)
Copyright (C) 2000 Linus Torvalds. 2000 Transmeta Corp.
Copyright (C) 2006 Atmark Techno, Inc. Yasushi SHOJI <yashi@atmark-techno.com> Tetsuya OHKAWA <tetsuya@atmark-techno.com>
Copyright 2016,2019 NXP
Copyright (c) 2006, 2007 IBM Corp. Josh Boyer <jwboyer@linux.vnet.ibm.com>
Copyright (C) 2012 - 2013 Pali Rohár <pali.rohar@gmail.com>
Copyright 2008 Wolfson Microelectronics PLC. Author: Mark Brown <broonie@opensource.wolfsonmicro.com>
Copyright 2013 Qtechnology/AS
Copyright (C) 2008 <srinivasa.deevi at conexant dot com>
Copyright (C) 2005 Ludovico Cavedon <cavedon@sss.it> Markus Rechberger <mrechberger@gmail.com> Mauro Carvalho Chehab <mchehab@kernel.org> Sascha Sommer <saschasommer@freenet.de>
Copyright (C) 2004, 2005 Chris Pascoe
Copyright (C) 2003, 2004 Gerd Knorr
Copyright (C) 2003 Pavel Machek
copyright 2016 linaro ltd.
Copyright (C) 2017 SiFive, Inc.
Copyright 2002 Tungsten Graphics, Inc., Cedar Park, Texas. All rights reserved.
Copyright 2004-2008 Simtec Electronics"
Copyright (C) 2004-2007 International Business Machines Corp. Author(s): Michael A. Halcrow <mahalcro@us.ibm.com> Michael C. Thompson <mcthompson@us.ibm.com>
Copyright 2006, 2007 Sony Corporation All rights reserved.
Copyright (c) 2004-2006, 2010-2013, Wind River Systems All rights reserved.
Copyright (C) 2004 Hyok S. Choi (MPU support)
Copyright (c) 2009-2010 Stephane Chatty
Copyright (c) 2010 Broadcom Corporation
Copyright (C) 2016 Alex Hung <alex.hung@canonical.com>
"Copyright: (C) 2003 Monta Vista Software, Inc. "
Copyright (C) 2004-2007 James Smart, Emulex Corporation Rewrite for host, target, device, and remote port attributes, statistics, and service functions... Add vports, etc
Copyright 2016-2017 Intel Deutschland GmbH
Copyright (C) 2008 Renesas Solutions Corp.
Copyright (C) 2008 Atom Create Engineering Co., Ltd.
Copyright (C) 2013 Canonical Ltd. Choice of algorithm:
Copyright (C) 2018 WMWare Inc.

Copyright (C) 2001 PPC 64 Team, IBM Corp
Copyright (C) 2005-2008 Auvitek International, Ltd.
Copyright (C) 2012 Michael Krufky <mkrufky@linuxtv.org>
Copyright (c) 2013-2016 Broadcom Author: Zi Shen Lim <zlim@broadcom.com>
Copyright (c) 2007-2008 Pavel Roskin <proski@gnu.org>
Copyright (c) 2009 Intel Corp. Author: Huang Ying <ying.huang@intel.com>
Copyright (C) 1995, 1996 Gero Kuhlmann and me.
Copyright 2004 Paul Mackerras <paulus@samba.org>
Copyright (C) 2004 - 2009 Red Hat, Inc. All rights reserved.
Copyright (C) 2010 LAPIS SEMICONDUCTOR CO., LTD.
Copyright (C) 1994 David Carter [carter@compsci.bristol.ac.uk]
Copyright (C) 1993 Bjoern Brauel Roman Hodek
Copyright (C) 2004 Alex Song
Copyright (C) 1996-2000 Russell King - Converted to ARM.
Copyright (C) 1999 Ralf Baechle (ralf@gnu.org)
Copyright (C) 2009 Lemote Inc. Author: Wu Zhangjin <wuzhangjin@gmail.com>
Copyright (C) 2001 Vic Phillips <vic@microtronix.com>
Copyright 2006-11 Jonathan Corbet <corbet@lwn.net>
Copyright 2018 Lubomir Rintel <lkundrak@v3.sk>
Copyright (C) 2009 Hans Verkuil <hverkuil@xs4all.nl>
Copyright (C) 2012-2014 Philipp Zabel, Pengutronix
Copyright (c) 2008-2009 Eurotech S.p.A. <info@eurotech.it> Michael Lawnick <michael.lawnick.ext@nsn.com>
Copyright 2007 Wolfson Microelectronics PLC. Author: Graeme Gregory graeme.gregory@wolfsonmicro.com or linux@wolfsonmicro.com
Copyright 2009 Wolfson Microelectronics
Copyright (c) 2010, ST-Ericsson Author: Ajitpal Singh <ajitpal.singh@lockless.no>
Copyright (C) 2014 Intel Corp.
Copyright (C) 1998 Gleb Raiko & Vladimir Roganov
Copyright (C) 2009 Theodore Kilgore <kilgota@auburn.edu>
Copyright (C) 2009 Hans de Goede <hdegoede@redhat.com> and Thomas Kaiser <thomas@kaiser-linux.li>
Copyright (C) 2009 Theodore Kilgore <kilgota@auburn.edu>
Copyright (C) 2011 Xilinx
Copyright (C) 2012 National Instruments Corp.
Copyright (C) 2013 Xilinx
Copyright (C) 2015-2016 NextThing Co
Copyright 2005-2015 Solarflare Communications Inc.
Copyright (C) 2017 Alan Stern <stern@rowland.harvard.edu>
Copyright (C) 2016 CNEX Labs Initial release: Matias Bjorling <matias@cnexlabs.com> Write buffering: Javier Gonzalez <javier@cnexlabs.com>
Copyright (C) 1997 Geert Uytterhoeven Based on linux/driver/video/pm2fb.c.
Copyright (C) 1998-1999 Ilario Nardinocchi (nardinoc@CS.UniBO.IT)
Copyright (C) 2005-2006 MontaVista Software, Inc. <source@mvista.com>
Copyright (C) 2007 Novell
Copyright (C) 2007 Intel
Copyright 2009 Red Hat, Inc. and/or its affiliates.
Copyright (c) 2004, Intel Corporation.
Copyright (c) 2000 Xavier Debacker <debackex@esiee.fr>
Copyright 2008 (c) Kristoffer Ericson <kristoffer.ericson@gmail.com>
Copyright (C) 2004 - 2010 Paul Mundt
Copyright (c) 2011 ST Microelectronics (Alessandro Rubini)
Copyright (C) 2005 Dirk Behme ad7877.c
Copyright (C) 2006-2008 Analog Devices Inc.
Copyright (c) 1997 C. Scott Ananian <cananian@alumni.priceton.edu>
Copyright (c) 1998-2000 Bruce Kalk <kall@compass.com> code for the special synaptics commands (from the tpcconfig-source)
Copyright (C) 2007 Google, Inc.
Copyright (C) 1995 Jay Estabrook

LICENCE TERMS (cont.)

Copyright (C) 2004 Andrew de Quincey (tuning thread cleanup)
Copyright (c) 2008 Sascha Hauer <s.hauer@pengutronix.de>, Pengutronix
Copyright (c) MontaVista Software, Inc. 2008.
Copyright (c) 2006 Tower Technologies Based on ep93xx driver, bits from alim7101_wdt.c
Copyright (c) 2012 H Hartley Sweeten <hsweeten@visionengravers.com> Convert to a platform device and use the watchdog framework API
Copyright 2004 Embedded Edge, LLC
Copyright 2002, 2003 Motorola Inc.
Copyright 2004-2005 MontaVista Software, Inc.
Copyright (C) 2009 - 2012 Paul Mundt
Copyright (C) 1999 Niibe Yutaka & Takeshi Yaegashi
Copyright (C) 2001 David J. Mckay (david.mckay@st.com)
Copyright (C) 2005, 2006 Paul Mundt
Copyright (C) 2008 Cavium Networks <support@caviumnetworks.com>
Copyright (C) 2013-2019 by the following authors: Rob Clark <robdclark@gmail.com> (robclark) Ilia Mirkin <imirkin@alum.mit.edu> (imirkin)
Copyright (C) 2018 Andes Technology Corporation
Copyright (c) 2008 Marvell International Ltd. Converted to SPI device based LCD/Backlight device driver by Eric Miao <eric.miao@marvell.com>
Copyright (C) 2007-2011 Marek Vasut <marek.vasut@gmail.com>
Copyright (C) 2004 Stefan Holst (mail@s-holst.de) Uni-Stuttgart
Copyright 2014, Rafal Milecki <zajec5@gmail.com>
Copyright (C) 2013 Pengutronix
Copyright (C) 2009 - 2010 NXP Semiconductors
Copyright (C) 2006 - 2007 Akio Idehara
Copyright (C) 2000 Frank Mori Hess <fmhess@users.sourceforge.net>
Copyright (C) 2001 David A. Schleaf <ds@schleaf.org>
Copyright (C) 2000, 2008 David S. Miller (davem@davemloft.net)
Copyright: |copy| 2018 NXP
Copyright (C) 2006 Michael Krufky (mkrufky@linuxtv.org)
Copyright (C) 2006, 2007 Chris Pascoe (c.pascoe@itee.uq.edu.au)
Copyright (C) 2011, 2017 Maciej S. Szmigiero (mail@maciej.szmigiero.name)
Copyright (C) 2004-2008 International Business Machines Corp. Author(s): Michael A. Halcrow <mahalcro@us.ibm.com> Trevor S. Highland <trevor.highland@gmail.com> Tyler Hicks <tyhicks@ou.edu>
Copyright (C) 2009 Intel Corporation Author: Arjan van de Ven <arjan@linux.intel.com>
Copyright (c) 2005-2006, 2010-2011, Wind River Systems All rights reserved.
Copyright (c) 2001-2003 International Business Machines, Corp.
Copyright 2018 Sebastian Reichel
Copyright 2018 Pavel Machek <pavel@ucw.cz> TI LMU LED common framework, based on previous work from Milo Kim <milo.kim@ti.com>
Copyright (C) 2005 Patrick Boettcher <pb@linuxtv.org>
Copyright (C) 2013 David Herrmann <dh.herrmann@gmail.com>
Copyright (C) 1997,1998,1999 Jakub Jelinek (jj@ultra.linux.cz)
Copyright (C) 1999 Pavel Semerad (semerad@ss1000.ms.mff.cuni.cz)
Copyright (c) 2006-2008 Jiri Kosina
Copyright (C) 2010, 2011 Anssi Hannula <anssi.hannula@iki.fi>
Copyright (C) 2010 Rabin Vincent <rabin@rab.in>
Copyright © 2011-2014 Intel Corporation
Copyright(c) Copyright 2001-2003, 2005 Hewlett-Packard Development Company, L.P. David Mosberger-Tang <davidm@hpl.hp.com> Bjorn Helgaas <bjorn.helgaas@hp.com>
Copyright (C) 2000 Philipp Rumpf
Copyright (C) 2000 David Howells
Copyright (c) 2011, 2012 Synaptics Incorporated
Copyright (C) 2006,2008 David Brownell
Copyright (C) 2015 Stephen Chandler Paul <thatslyude@gmail.com>
Copyright (C) 2011 Google, Inc. All rights reserved.
Copyright (C) 2003-2005 Benjamin Herrenschmidt.

Copyright (c) 2015, SUSE Linux GmbH
Copyright (c) 2016, Damien Le Moal
Copyright (c) 2016, Western Digital
Copyright (C) 2002 Paul Mackerras, IBM Corp.
Copyright (c) 2004, 2005 James Bottomley <James.Bottomley@SteelEye.com>
Copyright 2007 Maarten Maathuis
Copyright 2008 PIKA Technologies Sean MacLennan <smaclennan@pikatech.com>
Copyright (C) Hitachi, Ltd., 2011
Copyright (C) 2011-2013 Freescale Semiconductor, Inc. All Rights Reserved.
Copyright (c) 2017, I2SE GmbH
Copyright (C) 2013 John Crispin <blogic@openwrt.org>
Copyright (c) 2005 Ian McDonald <iam4@cs.waikato.ac.nz>
Copyright 2017, 2019 NXP
Copyright (C) 2001 - 2005 Tensilica Inc.
Copyright (c) 2012 Bosch Sensortec GmbH
Copyright (c) 2012 Unixphere AB
Copyright (c) 2014 Intel Corporation
Copyright (c) 2016 Linus Walleij <linus.walleij@linaro.org>
Copyright 1993 assigned to the United States Government as represented by the Director, National Security Agency.
Copyright (C) 2016 Linaro Ltd <ard.biesheuvel@linaro.org>
Copyright (C) 1999, 2000 Philipp Rumpf <prumpf@tux.org>
Copyright (c) 1999 Cisco, Inc.
Copyright (C) 2001 - 2009 Paul Mundt
Copyright (c) 2007 STMicroelectronics (R&D) Ltd.
Copyright (C) David Gibson, Linuxcare Australia Portions based on Spectrum24tDnld.c from original spectrum24 driver:
Copyright (C) Symbol Technologies.
Copyright (c) 2004 Hewlett-Packard Company.
Copyright (c) 2005 SDG Systems, LLC
Copyright (c) 2006 Anton Vorontsov <cbou@mail.ru>
Copyright (c) 2004-2008, 2010-2013, Wind River Systems All rights reserved.
Copyright (C) 2016 Western Digital
Copyright (c) 2019 Pragnesh Patel <Pragnesh_Patel@mentor.com>
Copyright (c) 2004 by Castet Matthieu <castet.matthieu@free.fr>
Copyright (C) 2006 Torsten Ertbjerg Rasmussen <tr@newtec.dk> nvram size determined from resource this ds1742 driver now supports ds1743.
Copyright(c) 2001 Daniel Phillips
Copyright (c) 2018 David Ahern <dsa@cumulusnetworks.com>
Copyright (c) 2019 Mellanox Technologies. All rights reserved.
Copyright (c) 2018, Google Inc.
Copyright (C) 2010, 2011 Roland Stigge <stigge@antcom.de>
Copyright (c) 2014 Jamie Lentin <jm@lentin.co.uk>
Copyright (c) 2012 Peter De Wachter <pdewacht@gmail.com>
Copyright (c) 2018 Peter Ganzhorn <peter.ganzhorn@gmail.com>
Copyright(c) hid_map_usage_clear(hi, usage, bit, max, EV_KEY, (c))
Copyright (C) 2001 Cypress Semiconductor Inc.
Copyright (c) 2008, Christian Lamparter <chunkeey@web.de>
Copyright 2004-2006 Jean-Baptiste Note <jean-baptiste.note@m4x.org>, et al.
Copyright (c) 2016 BayLibre, Inc. Michael Turquette <mturquette@baylibre.com>
Copyright 2005 (c) MontaVista Software, Inc.
Copyright (C) 2009 Matthieu CASTET <castet.matthieu@free.fr>
Copyright (C) 2012-2013 Hauke Mehrkens <hauke@hauke-m.de>
Copyright NXP 2017.
Copyright (C) 2000 Matthew Wilcox <matthew@wil.cx>
Copyright (C) 2000 David Huggins-Daines <dhd@debian.org>
Copyright (C) 2008-2016 Helge Deller <deller@gmx.de>
Copyright 2017-2019 NXP Dong Aisheng <aisheng.dong@nxp.com>

LICENCE TERMS (cont.)

Copyright (c) 2003 Spirent Communications and Claus Gindhart <claus.gindhart@kontron.com>
Copyright (c) 2012 Red Hat, Inc
Copyright (C) 2003 Adrian Sun (asun@darksunrising.com)
Copyright(c) David Miller davem@redhat.com) as its basis.
Copyright (c) 2016, Microsoft Corporation.
Copyright(c) 2013, Google Inc.
Copyright 2008 Luotao Fu, kernel@pengutronix.de
Copyright (C) 2006-2008 Felix Fietkau <nbd@openwrt.org>
Copyright (C) 2010 Alan Stern <stern@rowland.harvard.edu>
Copyright 2016 by Emese Revfy <re.emese@gmail.com> Licensed under the GPL v2
Copyright (C) 2009 IBM Corporation
Copyright (c) 2005 Stefano Brivio <st3@riseup.net>
Copyright (C) 2004 Jochen Friedrich <jochen@scram.de>
Copyright (C) 2008 Jim Law - Iris LP All rights reserved.
COPYRIGHT_YEARS "2001-2013" define ESAS2R_DEFAULT_SGL_PAGE_SIZE 384 define ESAS2R_DEFAULT_CMD_PER_LUN 64 define ESAS2R_DEFAULT_NUM_SG_LISTS 1024 define DEFINED_NUM_TO_STR(num) NUM_TO_STR(num) define NUM_TO_STR(num) #num
Copyright (C) 2004 - 2006 Red Hat, Inc. All rights reserved.
Copyright (c) 2005, 2006 Maciej W. Rozycki
Copyright 2019 Linaro, Ltd., Rob Herring <robh@kernel.org> */
Copyright 2012 Linaro Ltd.
Copyright (c) 2008-2009 Secret Lab Technologies Ltd.
Copyright (C) 1993, 1994, 1995, 1999 Eric Youngdale
copyright (C) 1991, 1992 Linus Torvalds. It was extensively rewritten by Theodore Ts'o, 8/16/92 -- 9/14/92, and then fixed as suggested by Michael K. Johnson 12/12/92. Converted to pci probing and cleaned up by Jiri Slaby.
Copyright** [copy] 1999-2018: Bill Dirks, Michael H. Schimek, Hans Verkuil, Martin Rubli, Andy Walls, Muralidharan Karicheri, Mauro Carvalho Chehab, Pawel Osciak, Sakari Ailus & Antti Palosaari, Tomasz Figa
Copyright (c) 2010-2013, NVIDIA Corporation.
Copyright (C) 2007, Red Hat, Inc.
Copyright (C) 2005 Thibaut VARENE <varenet@parisc-linux.org>
Copyright (C) 2006 Texas Instruments.
Copyright (c) 2003 Digigram SA <alsa@digigram.com> Distributable under GPL.
Copyright (c) 2009 Devin Heitmueller <dheitmueller@kernellabs.com>
Copyright 2015-2017 Socionext Inc.
Copyright (C) 2010 Samo Pogacnik
Copyright (C) 2008 TurboSight.com, Bob Liu <bob@turbosight.com>
Copyright (C) 2008 Igor M. Liplianin <liplianin@me.by> Removed stb6000 specific tuner code and revised some procedures. 2010-09-01 Josef Pavlik <josef@pavlik.it> Fixed diseqc_msg, diseqc_burst and set_tone problems
Copyright (c) 2014 ATRON electronic GmbH Author: Jan Safrata <jan.nikitenko@gmail.com>
Copyright (C) 2000 Andrew Tridgell <tridge@samba.org>
Copyright (c) 2004 David Shaohua Li <shaohua.li@intel.com>
Copyright (c) 2000-2003 Patrick Mochel
Copyright 2007-2008 Pierre Ossman
Copyright (c) 2014 The Linux Foundation. All rights reserved.
Copyright (C) 1999-2003 Hewlett-Packard Co. David Mosberger-Tang <davidm@hpl.hp.com> Stephane Eranian <eranian@hpl.hp.com>
Copyright(c) Copyright 2006 Hewlett-Packard Development Company, L.P. Bjorn Helgaas <bjorn.helgaas@hp.com>
Copyright (c) 2001 Ralf Baechle
Copyright (c) 2002 Thiemo Seufer
Copyright (C) 2001-2002, SnapGear Inc. (www.snapgear.com)
Copyright (C) 2008 Hewlett-Packard Development Company, L.P. Bjorn Helgaas <bjorn.helgaas@hp.com>
Copyright 2008 David S. Miller (davem@davemloft.net)
Copyright (C) 1999, 2000, 2001 by Michael Engel <engel@unix-ag.org>, Karsten Merker <merker@debian.org> and Harald Koerfgen <hkoerfg@web.de>, which itself is derived from HP300 Topcat framebuffer support (derived from macfb of all things) Phil Blundell <philb@gnu.org> 1998"
Copyright (c) 2016 Maciej W. Rozycki
Copyright (C) 2017 XiaojingZhu <zhuxiaoj@ict.ac.cn>

Copyright (c) 2001, 2003, 2005, 2006 Maciej W. Rozycki
Copyright (C) 1998 Alan Cox <alan@lxorguk.ukuu.org.uk>
Copyright (C) 2007 Finn Thain
Copyright (c) 2017 Yotam Gigi <yotamg@mellanox.com>
Copyright (C) 2003-2004 David Brownell
Copyright (c) 2004, 2010 Freescale Semiconductor, Inc
Copyright (C) 2007 MontaVista Software, Inc Author: Alexandre Rusev <source@mvista.com>
Copyright 2002-2004 MontaVista Software, Inc. PowerPC 44x support, Matt Porter <mporter@kernel.crashing.org>
Copyright 2004 Freescale Semiconductor, Inc PowerPC e500 modifications, Kumar Gala <galak@kernel.crashing.org>
Copyright (c) 2001,2003 Greg Kroah-Hartman (greg@kroah.com)
Copyright (c) 2001 IBM Corp.
Copyright (C) 1999 ARM Limited
Copyright (C) 2000-2001 Deep Blue Solutions Ltd
Copyright (c) 2013 Cisco Systems. All rights reserved.
Copyright (C) 1999 - 2012 Greg Kroah-Hartman (greg@kroah.com)
Copyright (C) 2000 Al Borchers (borchers@steinerpoint.com)
Copyright (C) 2009 Texas Instruments.
Copyright(c) 1999 - 2015 Intel Corporation
Copyright (C) 2012-2013 Tieto Poland
Copyright (C) 2016 HALE electronic
Copyright (C) 2005-2006, Thomas Gleixner
Copyright (C) 1996 Cort Dougan <cort@cs.nmt.edu>
Copyright 2015 Simon Arlott
Copyright (C) 2009 Albert Herranz
Copyright (C) 2000 - 2007 Jeff Dike (jdike@{addtoit,linux.intel}.com) Derived (i.e. mostly copied) from arch/i386/kernel/irq.c:
Copyright (C) 2018 Nicolas Saenz Julienne <nsaenzjulienne@suse.de>
Copyright 2009 GE Intelligent Platforms Embedded Systems, Inc.
Copyright (C) 2016-2017 Milan Broz
Copyright (C) 2016-2017 Mikulas Patocka
Copyright (C) 2004-2007 Red Hat, Inc. All rights reserved.
Copyright (C) 2009 Wind River Systems, Inc. Updated for supporting PPC405EX on Kilauea. Tiejun Chen <tiejun.chen@windriver.com>
Copyright (C) 2010 Nokia Corporation Author: Imre Deak <imre.deak@nokia.com>
Copyright (c) 2003 Benjamin Herrenschmidt <benh@kernel.crashing.org>
Copyright (C) 19yy <name of author>
Copyright (C) 19xx name of author Gnomovision comes with ABSOLUTELY NO WARRANTY
Copyright(C) 1999 Rt-Control, Inc\n
Copyright (C) 2014 Ulrich Weigand, IBM Corporation.
Copyright 2019 NXP Author: German Rivera <German.Rivera@freescale.com>
Copyright (C) 2000-2001, Lineo Inc. (www.lineo.com)
Copyright (c) 2002 Pete Zaitcev (zaitcev@yahoo.com)
Copyright (C) 2006,2007 Pete Zaitcev (zaitcev@redhat.com)
Copyright (C) 2013 Qiang Yu <yuq825@gmail.com>
Copyright (C) 2013 Henrik Nordstrom <Henrik.Nordstrom>
Copyright (C) 2013 Dmitriy B. <rzk333@gmail.com>
Copyright (C) 2013 Sergey Lapin <slapin@ossfans.org>
Copyright 1999 SuSE GmbH changed by Philipp Rumpf
Copyright 2004 Randolph Chung (tausq@debian.org)
Copyright 2006-2007 Helge Deller (deller@gmx.de)
Copyright (c) 2015 Intel Deutschland GmbH
Copyright 2009-2011 Freescale Semiconductor Inc.
Copyright (C) 2012, Insignal Co., Ltd, Homin Lee <suapapa@insignal.co.kr>
Copyright (C) 2011, Samsung Electronics Co., Ltd.
Copyright (C) 2006-2010 PEAK System-Technik GmbH
Copyright (C) 1998, 1999 David Mosberger-Tang <davidm@hpl.hp.com>

LICENCE TERMS (cont.)

Copyright (C) 2016 Imagination Technologies Ltd.
Copyright (c) 2017 Diego Elio Pettenò <flameeyes@flameeyes.eu>
Copyright (c) 2017 Alex Manoussakis <amanou@gnu.org>
Copyright (c) 2017 Tomasz Kramkowski <tk@the-tk.com>
Copyright (c) 2017-2018, Linaro Ltd.
Copyright (C) 2015 Industrial Research Institute for Automation and Measurements PIAP Written by Krzysztof Halasa
Copyright 2019 Linaro Ltd.
Copyright (c) 2001 Benjamin Herrenschmidt <benh@kernel.crashing.org>
Copyright (c) 2000 Philip Edelbrock <phil@stimpynet.roedger.com>
Copyright 2009 Openmoko, Inc Balaji Rao <balajirao@openmoko.org>
Copyright** [copy] 2002-2003 : Convergence GmbH
Copyright** [copy] 2009-2017 : Mauro Carvalho Chehab
Copyright (C) 2000-2002 J.I. Lee <jung-ik.lee@intel.com>
Copyright (C) 1999-2000, 2002-2003 Hewlett-Packard Co. David Mosberger-Tang <davidm@hpl.hp.com>
Copyright (C) 1999,2000 Walt Drummond <drummond@valinux.com>
Copyright (C) 2012 Lantiq GmbH
Copyright (C) 2008, Florian Fainelli <florian@openwrt.org>
Copyright(c) Copyright 1996 Alan Cox <alan@lxorguk.ukuu.org.uk>, All Rights Reserved.
Copyright (C) Sylver Bruneau <sylver.bruneau@googlemail.com>
Copyright (C) 2000 AG Electronics Note: the data sheets don't seem to be available from Asiliant.
Copyright (C) 1998 Paul Mackerras which was derived from the Powermac "chips" driver:
Copyright 2011-2014 Freescale Semiconductor, Inc.
Copyright (C) 2018 Vadim Pasternak <vadimp@mellanox.com>
Copyright (c) 2018 Christoph Hellwig.
Copyright (c) 2019 Vitaly Chikunov <vt@altlinux.org>
Copyright (C) 2011-2013 Synopsys, Inc. (www.synopsys.com)
Copyright (c) 2012 Alexander Potashev, Emcraft Systems, aspotashev@emcraft.com Anton Protopopov, Emcraft Systems, antonp@emcraft.com
Copyright (c) 2012 Bjørn Mork <bjorn@mork.no>
Copyright (C) ST-Ericsson 2010-2012
Copyright (C) 2004-2008 Yoichi Yuasa <yuasa@linux-mips.org>
Copyright (C) 2016, ZTE Corp.
Copyright (C) 2002-2005 Dave Jones.
Copyright(c) 2017 Intel Corporation. All rights reserved.
Copyright (C) 2010 NVIDIA Corporation
Copyright (C) 2008-2009 Laurent Pinchart <laurent.pinchart@ideasonboard.com>
Copyright (c) 2003 Ron Lee (ron@debian.org) cPad driver for kernel 2.4
Copyright (c) 2004 Jan Steinhoff (cpad@jan-steyhoff.de)
Copyright (c) 2004 Ron Lee (ron@debian.org) rewritten for kernel 2.6
Copyright (C) 2017 Christoph Hellwig.
Copyright (C) 2017 Amllogic, Inc. All rights reserved
Copyright (C) 2009 Martin Michlmayr <tbm@cyrius.com>
Copyright (C) 2008 Byron Bradley <byron.bbradley@gmail.com>
Copyright (C) 1999, 2001, 2003 David Mosberger-Tang <davidm@hpl.hp.com>
Copyright 2006 Andi Kleen, SUSE Labs. 32 Bit compat layer by Stefani Seibold <stefani@seibold.net> sponsored by Rohde & Schwarz GmbH & Co. KG Munich/Germany
Copyright 2014 Rafał Miłecki
Copyright (C) 2006-2007 Michael Wu <flamingice@sourmilk.net>
Copyright (C) 2002 Christoph Hellwig
Copyright (C) 2005-2007 David Brownell
Copyright (C) 2018 ARM Limited
Copyright (C) 1997, 1999 Jakub Jelinek (jj@ultra.linux.cz)
Copyright(c) 2008 - 2010 Realsil Semiconductor Corporation" define DRV_AUTHOR "<wlanfae@realtek.com>"
define DRV_VERSION "0014.0401.2010"
Copyright 2017-2018,2020 NXP Dong Aisheng <aisheng.dong@nxp.com>
Copyright (C) 2002 Russell King
Copyright (c) 2003-2004 Embedded Edge, LLC.

Copyright (C) 2002 Embedix, Inc
Copyright 2002 Hewlett-Packard Company
Copyright (C) 2004-2005 Pierre Ossman, All Rights Reserved.
Copyright (C) 2003 Russell King, All Rights Reserved.
Copyright (c) 2010-2011 Andres Salomon <dilinger@queued.net>
Copyright (C) 2007 Kyle McMartin
Copyright (C) 2000 Philipp Rumpf
Copyright (C) 1998, 1999 Phil Blundell
Copyright (C) 2011, Linaro Limited
Copyright (C) 2006 Unai Uribarri
Copyright (C) 2008 linwizard.sourceforge.net
Copyright (C) 2003 Red Hat
Copyright (C) 2007-2011 Texas Instruments, Inc. OMAP3/4 support by Rajendra Nayak, Santosh Shilimkar
Copyright (c) 2005-2007, 2010-2011, Wind River Systems All rights reserved.
Copyright (C) 1998-2002 Andre Hedrick <andre@linux-ide.org>, Integrator
Copyright (C) 2007-2011 Bartłomiej Zolnierkiewicz
Copyright (C) 2006 - 2008 Paul Mundt
Copyright (C) 2006 Benjamin Herrenschmidt, IBM Corp.
Copyright (C) Kuninori Morimoto <morimoto.kuninori@renesas.com>
Copyright (C) 1995,2002 Pete A. Zaitcev <zaitcev@yahoo.com>
Copyright (C) 1996 Dave Redman (djr@tadpole.co.uk)
Copyright 2008-2011 Red Hat, Inc.
Copyright (C) 2007-2009 Hans de Goede <hdegoede@redhat.com> *
Copyright (C) 2010 Giel van Schijndel <me@mortis.eu> *
Copyright (C) 2017 Cadence Design Systems Inc.
Copyright (c) 2002-2005, K A Fraser
Copyright (C) 2012 Samsung Electronics Jonghwa Lee <jonghwa3.lee@samsung.com>
Copyright (C) 1995-1997 Simon G. Vogl, 1998-2000 Hans Berglund
Copyright 2005 MontaVista Software
Copyright (C) 2017-2018 Pengutronix, Lucas Stach <kernel@pengutronix.de>
Copyright (c) 2011 John Sung <penmount.touch@gmail.com>
Copyright (c) 2004 Vojtech Pavlik
Copyright (c) 2011 Yu Ke <ke.yu@intel.com>
Copyright 2015 Regents of the University of California
Copyright 2017 SiFive
Copyright 2004 Andrew Chew
Copyright (C) 2011 Sam Ravnborg <sam@ravnborg.org>
Copyright (c) 2007-2010 The Khronos Group Inc.
Copyright (c) 2010, Code Aurora Forum. All rights reserved.
Copyright (C) 2014 Linaro Ltd. Author: Rob Herring <robh@kernel.org>
Copyright (C) 1999-2001 Cisco, Motorola
Copyright (C) 2006 by Thiemo Seufer
Copyright (C) 2012 MIPS Technologies, Inc. All rights reserved.
Copyright (c) 2009 Jonathan Cameron
Copyright (c) 2007 Wouter Horre
Copyright (C) 2004-2006 Richard Purdie
Copyright (c) 2005 Ian Molton
Copyright (c) 2006 Alberto Mardegan
Copyright 2006, 2007, Felix Fietkau <nbd@openwrt.org>
Copyright 2007, Aurelien Jarno <aurelien@aurel32.net>
Copyright (c) 2005 Ian McDonald <ian.mcdonald@jandi.co.nz>
Copyright (c) 2005 Vojtech Pavlik <vojtech@suse.cz>
Copyright (c) 2009 Sebastian Kapfer <sebastian_kapfer@gmx.net>
Copyright (C) 2007 Hidetoshi Seto <seto.hidetoshi@jp.fujitsu.com>
Copyright (C) 2006 Sam Ravnborg <sam@ravnborg.org>
Copyright (C) 2014 Google LLC. Tomasz Figa <tfiga@chromium.org>
Copyright (C) 2015 Rockchip Electronics Co., Ltd. Alpha Lin <alpha.lin@rock-chips.com>

LICENCE TERMS (cont.)

Copyright (C) 1995,1999 Pete Zaitcev (zaitcev@yahoo.com)
Copyright (C) 2007-2008 Peter Stokes <linux@dadeos.co.uk>
Copyright (C) 2018-2019 Renesas Electronics Corporation
Copyright (C) 2007 Texas Instruments, Inc. Rajendra Nayak <rnayak@ti.com>
Copyright 1998 Free Software Foundation, Inc.
Copyright © 2015 Broadcom Corporation
Copyright 2000-2010 Broadcom Corporation
Copyright (c) 2005-2007, 2012-2013, Wind River Systems All rights reserved.
Copyright 2007-2008 Jaime Velasco Juan <jsagarribay@gmail.com>
Copyright 2006-2007 Jonathan Corbet
Copyright (c) 2005 Arnaldo Carvalho de Melo <acme@ghostprotocols.net>
Copyright (c) 2005 Ian McDonald <ian.mcdonald@jandi.co.nz>
Copyright (C) 2004-2005 Richard Purdie
Copyright (c) 2005 Ian Molton <spyro@f2s.com>
Copyright (C) 2011 Pyramid Technical Consultants, Inc.
Copyright 1998 Emagic Soft- und Hardware GmbH
Copyright 2002 Martijn Sipkema
Copyright (C) 2008, 2009 Intel Corporation Author: Andi Kleen
Copyright (C) 2016 Regents of the University of California
Copyright (c) 1998 Bas Vermeulen <bvermeul@blackstar.xs4all.nl>
Copyright (c) 2004 Christoph Hellwig <hch@lst.de>
Copyright (c) 2007 Red Hat
Copyright (C) 2004 Olof Johansson <olof@lixom.net>, IBM Corporation
Copyright (C) 2006 Olof Johansson <olof@lixom.net>
Copyright (C) 2015 Richard Pospesil
Copyright (C) 2015 Tai Chi Minh Ralph Eastwood
Copyright (C) 2015 Martin Wimpess
Copyright (C) 2015 Jay Kuri
Copyright (c) 2013, Alexander Graf <agraf@suse.de>
Copyright (C) 2008 Shane McDonald
Copyright (C) 2011 Gabor Juhos <juhosg@openwrt.org>
Copyright (C) 2004-2011 Comtrol, Inc.
"Copyright (c) 2003-2004 Joern Engel <joern@wh.fh-wedel.de> "
Copyright (c) 2005 Joern Engel <joern@wh.fh-wedel.de>
Copyright (c) 2001 Arndt Schoenewald
Copyright (C) 2017 BayLibre, SAS Author: Neil Armstrong <narmstrong@baylibre.com>
Copyright (c) 2007 Intel Corporation. All rights reserved.
Copyright (c) 2008 Red Hat, Inc. All rights reserved.
Copyright (c) 2008 Mike Christie
Copyright (c) 2009 Rising Tide, Inc.
Copyright (c) 2009 Linux-iSCSI.org
Copyright (c) 2009 Nicholas A. Bellinger <nab@linux-iscsi.org>
"Copyright 2016 Intel Deutschland GmbH"
"Copyright (C) 2006-2007, 2009 MontaVista Software, Inc."
Copyright 2015 Marcus Cooper <codekipper@gmail.com>
Copyright (C) 2000 Vinh Truong (vinh.truong@eng.sun.com)
Copyright (C) 1999-2000 Maxim Krasnyansky <max_mk@yahoo.com>
Copyright (c) 1999-2000 Maksim Yevmenkin <m_evmenkin@yahoo.com>
Copyright (C) 1995, 96, 97, 98, 99, 2000, 01, 02, 03 by Ralf Baechle
Copyright (c) 2009 Greg Kroah-Hartman <gregkh@suse.de>
Copyright (c) 2009 Novell Inc.
Copyright 1994-2000 retained by the original author, Donald Becker. The timer-based reset code was supplied in 1995 by Bill Carlson, www@super.org.
Copyright (C) 2012-2015 Intel Corporation. All rights reserved.
Copyright (c) 2008 Takashi Iwai <tiwai@suse.de>
Copyright 2017-2018,2020 NXP
Copyright (c) 2001 La Monte H.P. Yarroll
Copyright (c) 2002-2003 Intel Corp.
Copyright (C) 1998 Dan Jacobowitz
Copyright (C) 1996 Paul Mackerras and Mark Abene
Copyright (c) 2004, 2005 Zultys Technologies. Eugene Surovegin <eugene.surovegin@zultys.com> or <ebs@ebshome.net>
Copyright (c) 2014-2017 Pengutronix, Marc Kleine-Budde <kernel@pengutronix.de>
Copyright (C) 2002 David S. Miller (davem@redhat.com) Fixed by Pekka Pietikainen (pp@ee.oulu.fi)
Copyright (C) Luke Kenneth Casson Leighton 1996-2000 Modified by Jeremy Allison 1995.
Copyright (C) Andrew Bartlett <abartlet@samba.org> 2002-2003 Modified by Steve French (sfrench@us.ibm.com) 2002-2003
Copyright 2000,2001 Philipp Rumpf <prumpf@mandrakesoft.com>
Copyright (c) 2000 Matt Sottek <msottek@quiknet.com>
Copyright (c) 2007, 2011 Jean Delvare <jdelvare@suse.de>
Copyright (C) 2010 Google, Inc. Rewritten by David Rientjes
Copyright (C) 2018 Jonathan McDowell <noodles@earth.li>
Copyright (C) BitBox Ltd 2010
Copyright (C) 2011 Jean-Christophe PLAGNIOL-VILLARD <plagnioj@jcssoft.com>
Copyright** |copy| 2009-2016 : Mauro Carvalho Chehab
Copyright (C) 1997, 1998 Ralf Baechle (ralf@gnu.org)
Copyright (C) 1999 Andrew R. Baker (andrewb@uab.edu) Indigo2 changes Interrupt handling fixes
Copyright (C) 2001, 2003 Ladislav Michl (ladis@linux-mips.org)
Copyright(C) 2007,2009 Bartlomiej Zolnierkiewicz
"Copyright (C) 2003 Vojtech Pavlik <vojtech@suse.cz> SiS Taiwan : for direct support and hardware. Daniela Engert : for initial ATA100 advices and numerous others. John Fremlin, Manfred Spraul, Dave Morgan, Peter Kjellerstedt : for checking code correctness, providing patches. Or "
Copyright (c) 2017-2018 Ronald Tschalär
Copyright (C) 2001 Rusty Russell, 2002, 2010 Rusty Russell IBM.
Copyright (C) 1994 Martin Schaller Roman Hodek
"Copyright (C) 2000,2001 Andi Kleen, SuSE Labs "
Copyright (C) 2001 Ken Hill (khill@microtronix.com) Vic Phillips (vic@microtronix.com)
Copyright (C) 1994 David S. Miller
Copyright (C) 2011 Paul Mundt
Copyright (C) 2002 ARM Ltd, All Rights Reserved
Copyright 2016 Naveen N. Rao <naveen.n.rao@linux.vnet.ibm.com> IBM Corporation
Copyright (C) 2004 - 2005 Alex Aizman maintained by open-iscsi@googlegroups.com
copyright information. 03-16-15 02.00.10 Updated for MPI v2.6. Added MPI2_SATA_PT_REQ_PT_FLAGS_FPDMA.
Copyright (C) 2011-2013 Jonas Gorski <jogo@openwrt.org>
Copyright 2008,2010 Anton Vorontsov <cbouatmailru@gmail.com>
Copyright (C) 2002 Mark D. Studebaker <mdsxyz123@yahoo.com>
Copyright (C) Red Hat, Inc., 2013-2015
Copyright (C) Asias He <asias@redhat.com>, 2013
Copyright (C) Stefan Hajnoczi <stefanha@redhat.com>, 2015
Copyright (C) 2010 Nicholas A. Bellinger <nab@kernel.org>
Copyright (C) 2009-2010 Jozsef Kadlec (kadlec@netfilter.org)
Copyright (C) 2016 Hans de Goede <hdegoede@redhat.com>
Copyright (c) 2003-2004 Silicon Graphics Inc. All Rights Reserved.
Copyright © 2000 Netgem S.A.
Copyright(C) Copyright 2007 TOSHIBA CORPORATION
Copyright 2002 Jamey Hicks <jamey.hicks@hp.com>
Copyright 2004-2005 Phil Blundell <pb@handhelds.org>
Copyright 2007-2008 Anton Vorontsov <cbouatmailru@gmail.com>
Copyright (C) 2017-2018 SUSE, Frederic Weisbecker
Copyright 2012 Pavel Machek <pavel@denx.de>
Copyright (C) 2002 ARM Ltd.
Copyright (C) 2012 Altera Corporation
Copyright (C) 2015 By Tech Design S.L. All Rights Reserved.
Copyright (C) 2012-2013 Freescale Semiconductor, Inc. All Rights Reserved.

LICENCE TERMS (cont.)

Copyright (C) 1999 Hewlett-Packard (Frank Rowand)
Copyright (C) 2000 Hewlett-Packard (John Marvin)
Copyright (C) 2008 Intel Corporation <linux-wimax@intel.com> Inaky Perez-Gonzalez <inaky.perez-gonzalez@intel.com>
Copyright 2005 (c) MontaVista Software, Inc. Author: Deepak Saxena <dsaxena@plexity.net>
Copyright 2004 (c) MontaVista Software, Inc.
Copyright(c) 1995-2001 Russell King
Copyright(c) 2004 MontaVista Software, Inc. Adapted from gdb/sim/arm/thumbemu.c -- Thumb instruction emulation.
Copyright (C) 1996, Cygnus Software Technologies Ltd.
Copyright(c) 1998 San Mehat (CCC) -July 1998 proc/sys/debug/alignment, modified and integrated into Linux 2.1 by Russell King
Copyright (C) 1995-2000 Ralf Baechle
Copyright (C) 2011 John Crispin <john@phrozen.org>
Copyright 2019,2020 NXP
Copyright 2001 by Micro Solutions, Inc., DeKalb IL.\n",pi->device)
Copyright 2001 by Micro Solutions, Inc., DeKalb IL. USA\n
Copyright (c) 2012 Linux Foundation
Copyright (c) 2012 Greg Kroah-Hartman <gregkh@linuxfoundation.org>
Copyright (C) 2002 - 2011 Paul Mundt
Copyright(C) 2005 Dirk Opfer
Copyright(C) 2007,2008 Dmitry Baryshkov
Copyright 2007 Freescale Semiconductor, Inc. Author: Scott Wood <scottwood@freescale.com>
Copyright (c) 2005 SDG Systems, LLC
Copyright 2019 Finn Thain
Copyright (C) 2010 Andy Walls <awalls@md.metrocast.net>
Copyright (C) 2011 Steven Toth <stoth@kernellabs.com>
Copyright (C) 2011 Maciej S. Szmigiero <mail@maciej.szmigiero.name>
Copyright (c) 1998-2000 Vojtech Pavlik
Copyright (C) 2018 Andes Technology Corporation <zong@andestech.com>
Copyright (C) 2012, Samsung Electronics Co., Ltd.
Copyright (C) 2012 Paul Mundt
Copyright (C) 1994 X Consortium
Copyright (C) 1996-2015 Free Software Foundation, Inc. This is free software
Copyright (C) 1999-2018 Free Software Foundation, Inc. Written by Tom Tromeey <tromeey@cygnus.com>.
Copyright 1992-2019 Free Software Foundation, Inc.
Copyright (C) 1999-2018 Free Software Foundation, Inc.
Copyright (C) 2004-2005, 2007, 2009, 2011-2015 Free Software Foundation, Inc. Written by Scott James Remnant, 2004.
Copyright (C) 2004, 2011-2015 Free Software Foundation, Inc. Written by Scott James Remnant, 2004
Copyright (C) 1996-2001, 2003-2015 Free Software Foundation, Inc. Written by Gordon Matzigkeit, 1996
Copyright (C) 2004-2005, 2007-2008, 2011-2015 Free Software Foundation, Inc. Written by Gary V. Vaughan, 2004
Copyright (C) 2004-2005, 2007-2009, 2011-2015 Free Software Foundation, Inc. Written by Gary V. Vaughan, 2004
Copyright (C) 1996-2018 Free Software Foundation, Inc. Originally written by Fran.cois Pinard <pinard@iro.umontreal.ca>, 1996.
Copyright (C) 2000-2018 Free Software Foundation, Inc.
Copyright (C) 1989, 1991 Free Software Foundation, Inc., 51 Franklin Street, Fifth Floor, Boston, MA 02110-1301 USA Everyone is permitted to copy and distribute verbatim copies of this license document, but changing it is not allowed.
Copyright (c) 2006, 2008 Junio C Hamano
Copyright (C) 1991, 1999 Free Software Foundation, Inc. 51 Franklin St, Fifth Floor, Boston, MA 02110-1301 USA Everyone is permitted to copy and distribute verbatim copies of this license document, but changing it is not allowed.
Copyright (C) 2011-2013 ProFUSION embedded systems
Copyright (C) 2011-2013 ProFUSION embedded systems
Copyright (C) 2014 Intel Corporation. All rights reserved.
Copyright 2010 Lennart Poettering
Copyright (C) 2012 W. Trevor King <wking@tremily.us>
Copyright (C) 2012 Red Hat, Inc. W. Trevor King <wking@tremily.us>

Copyright (C) 2013 Michal Marek, SUSE
Copyright (C) 2003 James Henstridge 2004-2007 Damon Chaplin 2007-2017 Stefan Sauer
Copyright (C) 1994-2018 Free Software Foundation, Inc.
Copyright (C) 2015 Intel Corporation. All rights reserved.
Copyright (C) 2004-2012 Kay Sievers <kay@vrfy.org>
Copyright (C) 2012-2013 ProFUSION embedded systems
Copyright (C) 1996-2018 Free Software Foundation, Inc.
Copyright (C) 2015 Intel Corporation. All rights reserved.
Copyright (C) 1992-1996, 1998-2012 Free Software Foundation, Inc.
Copyright (C) 2016 Intel Corporation. All rights reserved.
Copyright (C) 2012-2013 ProFUSION embedded systems
Copyright (C) 2011 Free Software Foundation, Inc. This config.lt script is free software; the Free Software Foundation gives unlimited permission to copy, distribute and modify it."
Copyright (C) 1994-2018 Free Software Foundation, Inc.
Copyright © 2007-2010 Josh Triplett <josh@joshtriplett.org> dnl Copying and distribution of this file, with or without modification,
Copyright (C) 2003 James Henstridge 2007-2017 Stefan Sauer
Copyright (c) 2006-2008 Diego Pettenò <flameeyes@gmail.com>
Copyright (c) 2015 Lucas De Marchi <lucas.de.marchi@gmail.com>
Copyright 2010 Ran Benita
Copyright (C) 2004-2015 Free Software Foundation, Inc. This is free software
Copyright (C) 2010-2015 Free Software Foundation, Inc. This is free software
Copyright 1992-2019 Free Software Foundation, Inc.
Copyright (C) 2014 Free Software Foundation, Inc. This is free software
Copyright (C) 2011 Free Software Foundation, Inc. This config.lt script is free software
Copyright (C) 2013 Intel Corporation. All rights reserved.
Copyright (C) 2003 James Henstridge 2004-2007 Damon Chaplin 2007-2017 Stefan Sauer
Copyright (C) 2011-2013 ProFUSION embedded systems
Copyright (C) 2011-2013 ProFUSION embedded systems
Copyright (C) 2013 Tom Gundersen <teg@jklm.no>
Copyright (C) 2008 Alan Jenkins <alan-jenkins@tuffmail.co.uk>.
Copyright (C) 2008 Alan Jenkins <alan-jenkins@tuffmail.co.uk>.
Copyright (C) 2002-2018 Free Software Foundation, Inc.
Copyright (C) 2001-2018 Free Software Foundation, Inc.
Copyright (C) 1997-2018 Free Software Foundation, Inc.
Copyright (C) 1999-2018 Free Software Foundation, Inc.
Copyright (C) 1996-2018 Free Software Foundation, Inc.
Copyright (C) 2003-2018 Free Software Foundation, Inc.
Copyright (C) 2009-2018 Free Software Foundation, Inc.
Copyright (C) 2006-2018 Free Software Foundation, Inc.
Copyright (C) 2004-2018 Free Software Foundation, Inc.
Copyright © 2004 Scott James Remnant <scott@netsplit.com>.
Copyright © 2012-2015 Dan Nicholson <dbn.lists@gmail.com> dnl dnl This program is free software
Copyright (c) 2006-2008 Diego Pettenò <flameeyes@gmail.com>
Copyright (c) 2006-2008 xine project
Copyright (c) 2012 Lucas De Marchi <lucas.de.marchi@gmail.com> dnl dnl This program is free software
Copyright (c) 2015 Lucas De Marchi <lucas.de.marchi@gmail.com>
Copyright (C) 2003 James Henstridge 2007-2017 Stefan Sauer
Copyright (C) 1996-2001, 2003-2015 Free Software Foundation, Inc. Written by Gordon Matzigkeit, 1996
Copyright (C) 2014 Free Software Foundation, Inc. This is free software
Copyright (C) 2011 Free Software Foundation, Inc. This config.lt script is free software
Copyright (C) 2004-2005, 2007-2009, 2011-2015 Free Software Foundation, Inc. Written by Gary V. Vaughan, 2004
Copyright (C) 2004-2005, 2007-2008, 2011-2015 Free Software Foundation, Inc. Written by Gary V. Vaughan, 2004
Copyright (C) 2004, 2011-2015 Free Software Foundation, Inc. Written by Scott James Remnant, 2004
Copyright (C) 2004-2005, 2007, 2009, 2011-2015 Free Software Foundation, Inc. Written by Scott James Remnant, 2004.
Copyright (C) 2002-2018 Free Software Foundation, Inc.

LICENCE TERMS (cont.)

Copyright (C) 2001-2018 Free Software Foundation, Inc.
Copyright (C) 1997-2018 Free Software Foundation, Inc.
Copyright (C) 1999-2018 Free Software Foundation, Inc.
Copyright (C) 1996-2018 Free Software Foundation, Inc.
Copyright (C) 2003-2018 Free Software Foundation, Inc.
Copyright (C) 2009-2018 Free Software Foundation, Inc.
Copyright (C) 2006-2018 Free Software Foundation, Inc.
Copyright (C) 2004-2018 Free Software Foundation, Inc.
Copyright © 2004 Scott James Remnant <scott@netsplit.com>.
Copyright © 2012-2015 Dan Nicholson <dbn.lists@gmail.com>
Copyright (c) 2006-2008 Diego Pettenò <flameeyes@gmail.com>
Copyright (c) 2006-2008 xine project
Copyright (c) 2012 Lucas De Marchi <lucas.de.marchi@gmail.com>
Copyright (c) 2015 Lucas De Marchi <lucas.de.marchi@gmail.com>
Copyright (C) 2003 James Henstridge 2007-2017 Stefan Sauer
Copyright (C) 1996-2001, 2003-2015 Free Software Foundation, Inc. Written by Gordon Matzigkeit, 1996
Copyright (C) 2004-2005, 2007-2009, 2011-2015 Free Software Foundation, Inc. Written by Gary V. Vaughan, 2004
Copyright (C) 2004-2005, 2007-2008, 2011-2015 Free Software Foundation, Inc. Written by Gary V. Vaughan, 2004
Copyright (C) 2004, 2011-2015 Free Software Foundation, Inc. Written by Scott James Remnant, 2004
Copyright (C) 2004-2005, 2007, 2009, 2011-2015 Free Software Foundation, Inc. Written by Scott James Remnant, 2004.
Copyright (C) 2012 Free Software Foundation, Inc. This configure script is free software
Copyright (C) 2012 Free Software Foundation, Inc. This config.status script is free software
Copyright (C) 2012 Lucas De Marchi <lucas.de.marchi@gmail.com>
Copyright (C) 2013-2014 Intel Corporation. All rights reserved.
Copyright (C) 2014 Intel Corporation. All rights reserved.
Copyright (C) 2012-2013 Lucas De Marchi <lucas.de.marchi@gmail.com>
Copyright (C) 2012 Pedro Pedruzzi
Copyright 2002, Rusty Russell, IBM Corporation. Maintained by Jon Masters and others. para> refsect1<
Copyright 2002, Rusty Russell,
Copyright (C) 1996-2015 Free Software Foundation, Inc. This is free software; see the source for copying conditions. There is NO warranty; not even for MERCHANTABILITY or FITNESS FOR A PARTICULAR PURPOSE.;Copyright (C) 2004-2015 Free Software Foundation, Inc. This is free software; see the source for copying conditions. There is NO warranty; not even for MERCHANTABILITY or FITNESS FOR A PARTICULAR PURPOSE.;Copyright (C) 2010-2015 Free Software Foundation, Inc. This is free software; see the source for copying conditions. There is NO warranty; not even for MERCHANTABILITY or FITNESS FOR A PARTICULAR PURPOSE.;(c) all begin with the string "--It-" application programs are unlikely to have options that match this pattern).
Copyright 1992-2019 Free Software Foundation, Inc.
Copyright (C) 2004-2005, 2007, 2009, 2011-2015 Free Software Foundation, Inc. Written by Scott James Remnant, 2004.
Copyright (C) 2004, 2011-2015 Free Software Foundation, Inc. Written by Scott James Remnant, 2004
Copyright (C) 1996-2001, 2003-2015 Free Software Foundation, Inc. Written by Gordon Matzigkeit, 1996
Copyright (C) 2004-2005, 2007-2008, 2011-2015 Free Software Foundation, Inc. Written by Gary V. Vaughan, 2004
Copyright (C) 2004-2005, 2007-2009, 2011-2015 Free Software Foundation, Inc. Written by Gary V. Vaughan, 2004
Copyright (C) 2000, 2002 Andreas Gruenbacher <agruen@suse.de>
Copyright (c) 2000-2001 Silicon Graphics, Inc. All Rights Reserved.
Copyright (C) 1999, 2000 Andreas Gruenbacher, <a.gruenbacher@bestbits.at>
Copyright (C) 1999-2002 Andreas Gruenbacher, <a.gruenbacher@bestbits.at>
Copyright (C) 2011 Andreas Gruenbacher, <a.gruenbacher@bestbits.at>
Copyright (C) 2014 Free Software Foundation, Inc. This is free software
Copyright (C) 2019 Free Software Foundation, Inc. This is free software
Copyright (C) 2002 Andreas Gruenbacher <agruen@suse.de>, SuSE Linux AG.
Copyright (c) 2000-2003 Silicon Graphics, Inc. All Rights Reserved.
Copyright (C) 2000 Andreas Gruenbacher, <a.gruenbacher@bestbits.at>
Copyright (C) 2001, 2002, 2003 Silicon Graphics, Inc. All rights reserved.
Copyright (c) 2000, 2002 Silicon Graphics, Inc. All Rights Reserved.
Copyright (C) 2003 Andreas Gruenbacher <a.gruenbacher@bestbits.at>
Copyright (C) 2001-2002 Silicon Graphics, Inc. All Rights Reserved.
Copyright (C) 2007 Andreas Gruenbacher <a.gruenbacher@computer.org>
Copyright (C) 2009 Andreas Gruenbacher <agruen@suse.de>
Copyright (C) 1999, 2000, 2001 Andreas Gruenbacher, <a.gruenbacher@bestbits.at>
Copyright (c) 2000-2006 Silicon Graphics, Inc. All Rights Reserved.
Copyright (C) 1996-2018 Free Software Foundation, Inc.
Copyright (C) 2012 Free Software Foundation, Inc. This config.status script is free software
Copyright (C) 2000, 2011 Andreas Gruenbacher, <a.gruenbacher@bestbits.at>
Copyright (C) 1992-1996, 1998-2012 Free Software Foundation, Inc.
Copyright (C) 2003 Andreas Gruenbacher <agruen@suse.de>
Copyright (c) 2007, 2008 Andreas Gruenbacher. All rights reserved.
Copyright (c) 2001-2002 Silicon Graphics, Inc. All Rights Reserved.
Copyright (c) 2000, 2002 Silicon Graphics, Inc. All Rights Reserved.
Copyright (c) 1999 by Andreas Gruenbacher a.gruenbacher@computer.org>
Copyright (C) 2009 by Andreas Gruenbacher a.gruenbacher@computer.org>
Copyright (C) 2011 Free Software Foundation, Inc.
Copyright (c) 2000-2002 Silicon Graphics, Inc. All Rights Reserved.
Copyright (c) 2000-2003 Silicon Graphics, Inc. All Rights Reserved.
Copyright (c) 2002-2003 Silicon Graphics, Inc. All Rights Reserved.
Copyright (C) 2003, 2004, 2006, 2007 Silicon Graphics, Inc.
Copyright (c) 2003-2006 Silicon Graphics, Inc. All Rights Reserved.
Copyright (c) 2002-2006 Silicon Graphics, Inc. All Rights Reserved.
Copyright (C) 2001-2005 Free Software Foundation, Inc.
Copyright (C) 2003, 2005, 2006, 2007 Silicon Graphics, Inc.
Copyright (C) 2003 Silicon Graphics, Inc.
Copyright (C) 2003, 2004, 2005, 2006, 2007 Silicon Graphics, Inc.
Copyright (C) 2003, 2008 Silicon Graphics, Inc.
Copyright (C) 2006 Free Software Foundation, Inc. Daniel Nylander <po@danielnylander.se>, 2006.
Copyright (C) 2000, 2002, 2003 Andreas Gruenbacher <agruen@suse.de>
Copyright (C) 2004 Free Software Foundation, Inc. Jakub Bogusz <qboosh@pld-linux.org>, 2004.
Copyright (C) 2007 Free Software Foundation, Inc. Antonio Trueba <atrueba@users.sourceforge.net>, 2007.
Copyright (C) 2000 Free Software Foundation, Inc. Andreas Gruenbacher <a.gruenbacher@computer.org>, 2000.
Copyright (C) 2005 Free Software Foundation, Inc. Sylvain Archenault <sylvain.archenault@laposte.net>, 2005.
Copyright (C) 1989, 1991 Free Software Foundation, Inc.
Copyright (C) 1991, 1999 Free Software Foundation, Inc.
(C) Andreas Gruenbacher, 1999
Copyright (C) 1999, 2000 Andreas Gruenbacher <a.gruenbacher@bestbits.at>
(C) 2002 Andreas Gruenbacher, <a.gruenbacher@bestbits.at>
(C) 2000 Andreas Gruenbacher, <a.gruenbacher@bestbits.at>
Copyright (C) 2001, 2002, 2004 Silicon Graphics, Inc. All rights reserved.
Copyright (c) 2002 Silicon Graphics, Inc. All Rights Reserved.
Copyright (C) 2002 Andreas Gruenbacher, <agruen@suse.de>
(C) 1999, 2000 Andreas Gruenbacher, <a.gruenbacher@computer.org>
(C) 1999 Andreas Gruenbacher, <a.gruenbacher@computer.org>
Copyright (c) 1999, 2001-2003 Silicon Graphics, Inc. All Rights Reserved.
Copyright 1992-2019 Free Software Foundation, Inc.
Copyright (C) 2014 Free Software Foundation, Inc. This is free software
Copyright (C) 2011 Free Software Foundation, Inc. This config.lt script is free software
Copyright (C) 1996-2015 Free Software Foundation, Inc.
Copyright (C) 2004-2015 Free Software Foundation, Inc. This is free software
Copyright (C) 2010-2015 Free Software Foundation, Inc. This is free software
Copyright (C) 2019 Free Software Foundation, Inc.
Copyright (C) 2001 Andreas Gruenbacher.
Copyright (C) 2001-2002 Silicon Graphics, Inc. All Rights Reserved.
Copyright (C) 2009 Andreas Gruenbacher <agruen@suse.de>
Copyright (C) 1996-2001, 2003-2015 Free Software Foundation, Inc. Written by Gordon Matzigkeit, 1996
Copyright (C) 2004-2005, 2007-2009, 2011-2015 Free Software Foundation, Inc. Written by Gary V. Vaughan, 2004

LICENCE TERMS (cont.)

Copyright (C) 2004-2005, 2007-2008, 2011-2015 Free Software Foundation, Inc. Written by Gary V. Vaughan, 2004
Copyright (C) 2004, 2011-2015 Free Software Foundation, Inc. Written by Scott James Remnant, 2004
Copyright (C) 2004-2005, 2007, 2009, 2011-2015 Free Software Foundation, Inc. Written by Scott James Remnant, 2004.
Copyright (C) 2003 Silicon Graphics, Inc.
Copyright (C) 2001-2005 Free Software Foundation, Inc.
Copyright (C) 2003, 2004, 2006, 2007 Silicon Graphics, Inc.
Copyright (C) 2003, 2005, 2006, 2007 Silicon Graphics, Inc.
Copyright (C) 2003, 2004, 2005, 2006, 2007 Silicon Graphics, Inc.
Copyright (C) 2003, 2008 Silicon Graphics, Inc.
Copyright (C) 2012 Free Software Foundation, Inc.
Copyright (C) 1996-2015 Free Software Foundation, Inc. This is free software; see the source for copying conditions. There is NO warranty; not even for MERCHANTABILITY or FITNESS FOR A PARTICULAR PURPOSE.;Copyright (C) 2004-2015 Free Software Foundation, Inc. This is free software; see the source for copying conditions. There is NO warranty; not even for MERCHANTABILITY or FITNESS FOR A PARTICULAR PURPOSE.;Copyright (C) 2010-2015 Free Software Foundation, Inc. This is free software; see the source for copying conditions. There is NO warranty; not even for MERCHANTABILITY or FITNESS FOR A PARTICULAR PURPOSE.:(c) all begin with the string "--It-" application programs are unlikely to have options that match this pattern).
Copyright 1992-2019 Free Software Foundation, Inc.
Copyright (C) 2004-2005, 2007, 2009, 2011-2015 Free Software Foundation, Inc. Written by Scott James Remnant, 2004.
Copyright (C) 2004, 2011-2015 Free Software Foundation, Inc. Written by Scott James Remnant, 2004
Copyright (C) 1996-2001, 2003-2015 Free Software Foundation, Inc. Written by Gordon Matzigeit, 1996
Copyright (C) 2004-2005, 2007-2008, 2011-2015 Free Software Foundation, Inc. Written by Gary V. Vaughan, 2004
Copyright (C) 2004-2005, 2007-2009, 2011-2015 Free Software Foundation, Inc. Written by Gary V. Vaughan, 2004
Copyright (c) 2000, 2002 Silicon Graphics, Inc. All Rights Reserved.
Copyright (C) 2003 Andreas Gruenbacher <a.gruenbacher@bestbits.at>
Copyright (C) 2001-2002 Silicon Graphics, Inc. All Rights Reserved.
Copyright (C) 2007 Andreas Gruenbacher <a.gruenbacher@computer.org>
Copyright (C) 2009 Andreas Gruenbacher <agruen@suse.de>
Copyright (c) 2002-2003 Silicon Graphics, Inc. All Rights Reserved.
Copyright (C) 2001-2005 Free Software Foundation, Inc.
Copyright (C) 2003 Silicon Graphics, Inc.
Copyright (c) 1999, 2001-2003 Silicon Graphics, Inc. All Rights Reserved.
Copyright (c) 2000-2001 Silicon Graphics, Inc. All Rights Reserved.
Copyright (C) 2001-2002 Andreas Gruenbacher <a.gruenbacher@bestbits.at>
Copyright (C) 2014 Free Software Foundation, Inc. This is free software
Copyright (C) 2019 Free Software Foundation, Inc. This is free software
Copyright (c) 2001-2002 Silicon Graphics, Inc. All Rights Reserved.
Copyright (c) 2000-2002 Silicon Graphics, Inc. All Rights Reserved.
Copyright (c) 2000-2002,2004 Silicon Graphics, Inc. All Rights Reserved.
Copyright (c) 2000-2003 Silicon Graphics, Inc. All Rights Reserved.
Copyright (C) 2001, 2002, 2003 Silicon Graphics, Inc. All rights reserved.
Copyright (c) 2000-2006 Silicon Graphics, Inc. All Rights Reserved.
Copyright (C) 1996-2018 Free Software Foundation, Inc.
Copyright (C) 2012 Free Software Foundation, Inc. This config.status script is free software
Copyright (C) 2000, 2002, 2007 Andreas Gruenbacher <agruen@suse.de>
Copyright (C) 1992-1996, 1998-2012 Free Software Foundation, Inc.
Copyright (C) 2003, 2006 Andreas Gruenbacher <agruen@suse.de>
Copyright (C) 2003 Andreas Gruenbacher <agruen@suse.de>, SuSE Linux AG.
Copyright (c) 2002-2006 Silicon Graphics, Inc. All Rights Reserved.
Copyright (C) 2001, 2002, 2006 Silicon Graphics, Inc. All rights reserved.
Copyright (c) 2001-2002,2004 Silicon Graphics, Inc. All Rights Reserved.
Copyright (C) 2002 Andreas Gruenbacher <agruen@suse.de>, SuSE Linux AG.
Copyright (c) 2001-2002 Silicon Graphics, Inc. All Rights Reserved.
Copyright (C) 2006 Andreas Gruenbacher <agruen@suse.de>, SuSE Linux AG.
Copyright (c) 2001-2003,2005 Silicon Graphics, Inc. All Rights Reserved.

Copyright (C) 2006 Free Software Foundation, Inc.
Copyright (c) 2007, 2008 Andreas Gruenbacher. All rights reserved.
Copyright (C) 2011 Free Software Foundation, Inc.
Copyright (C) 2004 Free Software Foundation, Inc.
Copyright (C) 2008 Petr Pisar <petr.pisar@atlas.cz>
Copyright (C) 2007 Free Software Foundation
Copyright (C) 2000 Free Software Foundation, Inc.
Copyright (C) 2005 Guilhelm Panaget <guilhelm.panaget@free.fr>
Copyright (C) 2004 Luk Claes <luk.claes@ugent.be>
Copyright (C) 1989, 1991 Free Software Foundation, Inc
Copyright (c) 2003-2006 Silicon Graphics, Inc. All Rights Reserved.
Copyright (C) 2003, 2004, 2006, 2007 Silicon Graphics, Inc.
Copyright (C) 2003, 2004, 2005, 2006, 2007 Silicon Graphics, Inc.
Copyright (C) 1991, 1999 Free Software Foundation, Inc.
Copyright (C) 2001, 2002, 2003, 2006 Silicon Graphics, Inc. All rights reserved.
Copyright (C) 2001, 2002, 2003, 2006, 2008 Silicon Graphics, Inc. All rights reserved.
Copyright (C) 2002, 2004 Silicon Graphics, Inc. All rights reserved.
Copyright (C) 2001, 2002, 2006, 2007 Silicon Graphics, Inc. All rights reserved.
Copyright (C) 2002, 2004, 2007 Silicon Graphics, Inc. All rights reserved.
Copyright (c) 2002 Silicon Graphics, Inc. All Rights Reserved.
Copyright 1992-2019 Free Software Foundation, Inc.
Copyright (C) 2014 Free Software Foundation, Inc. This is free software
Copyright (C) 2011 Free Software Foundation, Inc. This config.lt script is free software
Copyright (C) 2009 Andreas Gruenbacher <agruen@suse.de>
Copyright (C) 2001-2002 Silicon Graphics, Inc. All Rights Reserved.
Copyright (C) 1996-2015 Free Software Foundation, Inc. This is free software
Copyright (C) 2004-2015 Free Software Foundation, Inc. This is free software
Copyright (C) 2010-2015 Free Software Foundation, Inc. This is free software
Copyright (C) 2019 Free Software Foundation, Inc. This is free software
Copyright (C) 2009 Andreas Gruenbacher <agruen@suse.de>
Copyright (C) 2009 Andreas Gruenbacher <agruen@suse.de>
Copyright (C) 2001-2002 Silicon Graphics, Inc. All Rights Reserved.
Copyright (C) 2001 Andreas Gruenbacher.
Copyright (C) 1996-2001, 2003-2015 Free Software Foundation, Inc. Written by Gordon Matzigeit, 1996
Copyright (C) 2004-2005, 2007-2009, 2011-2015 Free Software Foundation, Inc. Written by Gary V. Vaughan, 2004
Copyright (C) 2004-2005, 2007-2008, 2011-2015 Free Software Foundation, Inc. Written by Gary V. Vaughan, 2004
Copyright (C) 2004, 2011-2015 Free Software Foundation, Inc. Written by Scott James Remnant, 2004
Copyright (C) 2004-2005, 2007, 2009, 2011-2015 Free Software Foundation, Inc. Written by Scott James Remnant, 2004.
Copyright (C) 2003 Silicon Graphics, Inc.
Copyright (C) 2001-2005 Free Software Foundation, Inc. dnl This file is free software
Copyright (C) 2003, 2004, 2006, 2007 Silicon Graphics, Inc.
Copyright (C) 2003, 2004, 2005, 2006, 2007 Silicon Graphics, Inc.
Copyright (C) 2001, 2002, 2004, 2007 Silicon Graphics, Inc. All rights reserved.
Copyright (C) 2012 Free Software Foundation, Inc. This configure script is free software
Copyright (C) 2012 Free Software Foundation, Inc. This config.status script is free software
Copyright (C) 2003, 2006 Silicon Graphics, Inc.
Copyright (C) 2006 Daniel Nylander <po@danielnylander.se>
Copyright (C) 2004, 2005 Jakub Bogusz <qboosh@pld-linux.org>
Copyright (C) 2007 Antonio Trueba <atrueba@users.sourceforge.net>
Copyright (C) 2002, 2003 Andreas Gruenbacher <a.gruenbacher@computer.org>
Copyright (C) 2007 Free Software Foundation
Copyright(C) Andreas Gruenbacher, February 2001
Copyright(C) Silicon Graphics Inc, September 2001
Copyright(C) Silicon Graphics Inc, September 2001
Copyright (C) 2000, 2002, 2007 Andreas Gruenbacher <agruen@suse.de>
Copyright (C) 2002, 2004 Andreas Gruenbacher <agruen@suse.de>

LICENCE TERMS (cont.)

Copyright (C) 2002, 2004, 2007 Andreas Gruenbacher <agruen@suse.de>
Copyright (C) 1994 X Consortium
Copyright (C) 1996-2015 Free Software Foundation, Inc. This is free software
Copyright (C) 1999-2018 Free Software Foundation, Inc. Written by Tom Tromey <tromey@cygnus.com>.
Copyright 1992-2019 Free Software Foundation, Inc.
Copyright (C) 1999-2018 Free Software Foundation, Inc.
Copyright (C) 1996-2018 Free Software Foundation, Inc. Originally written by Fran.cois Pinard <pinard@iro.umontreal.ca>, 1996.
Copyright (C) 1996-2019 Julian Seward <jseward@acm.org>
Copyright (C) 1994-2018 Free Software Foundation, Inc.
Copyright 1996-2011 Glyph & Cog,
copyright (C) 1996-2019 Julian R Seward. All rights reserved.
Copyright (C) 1996-2018 Free Software Foundation, Inc.
copyright">Copyright © 1996-2019 Julian Seward
Copyright (C) 1992-1996, 1998-2012 Free Software Foundation, Inc.
Copyright (C) 1996-2019 Julian Seward <jseward@acm.org>
Copyright © 1996-2019 Julian Seward
Copyright (C) 2011 Free Software Foundation, Inc.
Copyright (C) 2004-2015 Free Software Foundation, Inc. This is free software
Copyright (C) 2010-2015 Free Software Foundation, Inc. This is free software
Copyright 1992-2019 Free Software Foundation, Inc.
Copyright (c) 1997, 2009 American Mathematical Society
Copyright (c) 1997, 2009 American Mathematical Society
Copyright (C) 2002-2018 Free Software Foundation, Inc.
Copyright (C) 2001-2018 Free Software Foundation, Inc.
Copyright (C) 1997-2018 Free Software Foundation, Inc.
Copyright (C) 1999-2018 Free Software Foundation, Inc.
Copyright (C) 1996-2018 Free Software Foundation, Inc.
Copyright (C) 2003-2018 Free Software Foundation, Inc.
Copyright (C) 2009-2018 Free Software Foundation, Inc.
Copyright (C) 2006-2018 Free Software Foundation, Inc.
Copyright (C) 2004-2018 Free Software Foundation, Inc.
Copyright (C) 1996-2001, 2003-2015 Free Software Foundation, Inc. Written by Gordon Matzigkeit, 1996
Copyright (C) 2014 Free Software Foundation, Inc. This is free software
Copyright (C) 2011 Free Software Foundation, Inc. This config.It script is free software
Copyright (C) 2004-2005, 2007-2009, 2011-2015 Free Software Foundation, Inc. Written by Gary V. Vaughan, 2004
Copyright (C) 2004-2005, 2007-2008, 2011-2015 Free Software Foundation, Inc. Written by Gary V. Vaughan, 2004
Copyright (C) 2004, 2011-2015 Free Software Foundation, Inc. Written by Scott James Remnant, 2004
Copyright (C) 2004-2005, 2007, 2009, 2011-2015 Free Software Foundation, Inc. Written by Scott James Remnant, 2004.
copyright © 1996-2019 Julian Seward. All rights reserved.
Copyright (C) 2012 Free Software Foundation, Inc. This configure script is free software
Copyright (C) 2012 Free Software Foundation, Inc. This config.status script is free software
Copyright (C) 1996-2019 by Julian Seward.
copyright © 1996-2019 Julian Seward. All rights reserved.
Copyright (c) 2008-11,16 Andrew G. Morgan <morgan@kernel.org>
Copyright (c) 1997-8,2007 Andrew G. Morgan <morgan@kernel.org>
Copyright (c) 1998 Finn Arne Gangstad <finnag@guardian.no>
Copyright (c) 1997-8 Andrew G. Morgan <morgan@kernel.org>
Copyright (c) 1998 Andrew G. Morgan <morgan@kernel.org>
Copyright (c) 1997,2007 Andrew G. Morgan <morgan@kernel.org>
Copyright (c) 1999,2007 Andrew G. Morgan <morgan@kernel.org>
Copyright (c) 1997,2007-8 Andrew G. Morgan <morgan@kernel.org>
Copyright (c) 1997-8,2007 Andrew G. Morgan <morgan@kernel.org>
Copyright (c) 1997-8,2008 Andrew G. Morgan <morgan@kernel.org>
Copyright (c) 1997,2008 Andrew G. Morgan <morgan@kernel.org>
Copyright (c) 1997-8,2007-8 Andrew G Morgan <morgan@kernel.org>
Copyright (c) 1997-8 Andrew G Morgan <morgan@kernel.org>
Copyright (c) 1997,2007,2016 Andrew G Morgan <morgan@kernel.org>
Copyright (c) 1997-8,2007,2011 Andrew G Morgan <morgan@kernel.org>
Copyright (C) 1997 Aleph One
"Copyright (C) 2010 Serge Hallyn <serue@us.ibm.com>"
Copyright (c) 1997-8 Andrew G. Morgan <morgan@kernel.org>
Copyright (c) 1997-8 Andrew G. Morgan <morgan@kernel.org>
Copyright (c) 1997-8,2007 Andrew G. Morgan <morgan@kernel.org>
Copyright (c) 1997 Andrew Main <zefram@dcs.warwick.ac.uk>
Copyright (C) 1989, 1991 Free Software Foundation, Inc.
Copyright (C) 1989, 1991 Free Software Foundation, Inc.
Copyright (C) 1997-8,2008 Andrew G. Morgan <morgan@kernel.org>
Copyright (C) 1994 X Consortium
Copyright (C) 1996-2015 Free Software Foundation, Inc. This is free software
Copyright (C) 1999-2018 Free Software Foundation, Inc. Written by Tom Tromey <tromey@cygnus.com>.
Copyright 1992-2019 Free Software Foundation, Inc.
Copyright (C) 1999-2018 Free Software Foundation, Inc.
Copyright (C) 2004-2005, 2007, 2009, 2011-2015 Free Software Foundation, Inc. Written by Scott James Remnant, 2004.
Copyright (C) 2004, 2011-2015 Free Software Foundation, Inc. Written by Scott James Remnant, 2004
Copyright (C) 1996-2001, 2003-2015 Free Software Foundation, Inc. Written by Gordon Matzigkeit, 1996
Copyright (C) 2004-2005, 2007-2008, 2011-2015 Free Software Foundation, Inc. Written by Gary V. Vaughan, 2004
Copyright (C) 2004-2005, 2007-2009, 2011-2015 Free Software Foundation, Inc. Written by Gary V. Vaughan, 2004
Copyright (C) 1996-2018 Free Software Foundation, Inc. Originally written by Fran.cois Pinard <pinard@iro.umontreal.ca>, 1996.
Copyright (C) 2011-2018 Free Software Foundation, Inc.
Copyright (C) 1998 - 2019, Daniel Stenberg, <daniel@haxx.se>, et al.
Copyright (C) 1998 - 2018, Daniel Stenberg, <daniel@haxx.se>, et al.
Copyright (c) 1998, 1999 Kungliga Tekniska Högskolan. This notice is included here to comply with the distribution terms.
Copyright (C) 1998 - 2017, Daniel Stenberg, <daniel@haxx.se>, et al.
Copyright (c) 1996 - 2019, Daniel Stenberg, <daniel@haxx.se>, and many contributors, see the THANKS file.
Copyright (C) 1994-2018 Free Software Foundation, Inc.
Copyright (C) 1998 - 2016, Daniel Stenberg, <daniel@haxx.se>, et al.
Copyright (C) 1996-2018 Free Software Foundation, Inc.
Copyright (C) 2015 - 2016, Daniel Stenberg, <daniel@haxx.se>, et al.
Copyright (C) 1992-1996, 1998-2012 Free Software Foundation, Inc.
Copyright (C) 1998 - 2017, Daniel Stenberg, <daniel@haxx.se>
Copyright (C) 1998 - 2012, Daniel Stenberg, <daniel@haxx.se>
Copyright (C) 2011 Free Software Foundation, Inc.
Copyright (C) 2010-2015, Daniel Stenberg, <daniel@haxx.se>
Copyright (C) 2012 - 2019, Steve Holme, <steve_holme@hotmail.com>.
Copyright (C) 2012 - 2018, Steve Holme, <steve_holme@hotmail.com>.
Copyright (C) 2014 - 2017, Steve Holme, <steve_holme@hotmail.com>.
Copyright (C) 1998 - 2014, Daniel Stenberg, <daniel@haxx.se>
Copyright (C) 2006-2015 wolfSSL Inc.
Copyright (C) 2010, Mandy Wu, <mandy.wu@intel.com>
Copyright (c) 1983 Regents of the University of California. All rights reserved.
Copyright (C) 2017, Daniel Stenberg, <daniel@haxx.se>, et al.
Copyright (C) 2016, Daniel Stenberg, <daniel@haxx.se>, et al.
Copyright (C) 1998 - 2011, Daniel Stenberg, <daniel@haxx.se>, et al.
Copyright (C) 2014 - 2016, Steve Holme, <steve_holme@hotmail.com>.
Copyright (C) 1998 - 2009, Daniel Stenberg, <daniel@haxx.se>, et al.
Copyright (c) 2013 Daniel Stenberg <daniel@haxx.se>
Copyright (c) 2011 Daniel Stenberg <daniel@haxx.se>
Copyright (c) 2008 Kaveh Ghazi <ghazi@caip.rutgers.edu>

LICENCE TERMS (cont.)

Copyright (c) 2013 - 2018 Daniel Stenberg <daniel@haxx.se>
Copyright (C) 2010 - 2019, Daniel Stenberg, <daniel@haxx.se>
Copyright (C) 1998 - 2010, Daniel Stenberg, <daniel@haxx.se>
Copyright (C) 2003 - 2008, Gisle Vanem <gvanem@yahoo.no>.
Copyright (C) 2011 - 2018, Daniel Stenberg, <daniel@haxx.se>
Copyright (C) 2010 - 2018, Daniel Stenberg, <daniel@haxx.se>
Copyright (C) 1998 - 2015, Daniel Stenberg, <daniel@haxx.se>
Copyright (C) 2016 - 2019, Steve Holme, <steve_holme@hotmail.com>.
Copyright (C) 1998 - 2013, Daniel Stenberg, <daniel@haxx.se>
Copyright (C) 2018 - 2019, Daniel Stenberg, <daniel@haxx.se>
Copyright (C) 1998 - 2007, Daniel Stenberg, <daniel@haxx.se>
Copyright (C) 1998 - 2018, Daniel Stenberg, <daniel@haxx.se>
Copyright (C) 1998 - 2018, Florin Petriuc, <petriuc.florin@gmail.com>
Copyright (C) 2005 - 2009, Gisle Vanem <gvanem@yahoo.no>.
Copyright (C) 1996-2001 Internet Software Consortium.
Copyright (c) 1995, 1996, 1997, 1998, 1999 Kungliga Tekniska Högskolan Royal Institute of Technology, Stockholm, Sweden).
Copyright (C) 2014, Bill Nagel <wnagel@tycoint.com>, Exacq Technologies
Copyright (c) 1998, 1999, 2017 Kungliga Tekniska Högskolan Royal Institute of Technology, Stockholm, Sweden).
Copyright (C) 1997 - 2019, Daniel Stenberg, <daniel@haxx.se>, et al.
Copyright (C) 2015 - 2019, Daniel Stenberg, <daniel@haxx.se>, et al.
Copyright (C) 2017 - 2019 Red Hat, Inc.
Copyright (C) 2009 - 2017, Daniel Stenberg, <daniel@haxx.se>, et al.
Copyright (C) 1999 - 2017, Daniel Stenberg, <daniel@haxx.se>, et al.
Copyright (C) 2010, Howard Chu, <hyc@highlandsun.com>
Copyright (C) 2019, Daniel Stenberg, <daniel@haxx.se>, et al.
Copyright (C) 2012 - 2019, Daniel Stenberg, <daniel@haxx.se>, et al.
Copyright (C) 1998 - 2010, Florin Petriuc, <petriuc.florin@gmail.com>
Copyright (C) 2014 - 2019, Steve Holme, <steve_holme@hotmail.com>.
Copyright (C) 2014 - 2016, Steve Holme, <steve_holme@hotmail.com>.
Copyright (C) 2011 - 2019, Daniel Stenberg, <daniel@haxx.se>, et al.
Copyright (C) 2004 - 2019, Daniel Stenberg, <daniel@haxx.se>, et al.
Copyright (C) 2010, Howard Chu, <hyc@openldap.org>
Copyright (c) 1996 by Internet Software Consortium.
Copyright (C) 2012 - 2016, Linus Nielsen Feltzing, <linus@haxx.se>
Copyright (C) 2012 - 2016, Daniel Stenberg, <daniel@haxx.se>, et al.
Copyright (C) 2015, Steve Holme, <steve_holme@hotmail.com>.
Copyright (C) 2009 - 2015, Daniel Stenberg, <daniel@haxx.se>, et al.
Copyright (C) 2009, Markus Moeller, <markus_moeller@compuserve.com>
Copyright (C) 2013-2015, Daniel Stenberg, <daniel@haxx.se>, et al.
Copyright (C) 2017 - 2018, Yiming Jing, <jingyiming@baidu.com>
Copyright (C) 2017-2018, Yiming Jing, <jingyiming@baidu.com>
Copyright (C) 2012 - 2014, Nick Zitzmann, <nickzman@gmail.com>.
Copyright (C) 2012 - 2016, Marc Hoersken, <info@marc-hoersken.de>
Copyright (C) 2012, Marc Hoersken, <info@marc-hoersken.de>, et al.
Copyright (C) 2013-2017, Daniel Stenberg, <daniel@haxx.se>, et al.
Copyright (C) 2012 - 2017, Nick Zitzmann, <nickzman@gmail.com>.
Copyright (C) 2010 - 2011, Hoi-Ho Chan, <hoiho.chan@gmail.com>
Copyright (C) 2011 - 2018, Daniel Stenberg, <daniel@haxx.se>, et al.
Copyright (C) 2009 - 2014, Daniel Stenberg, <daniel@haxx.se>, et al.
Copyright (C) 2004 - 2015, Guenter Knauf
Copyright (C) 1998 - 2014, 2017, Daniel Stenberg, <daniel@haxx.se>, et al.
Copyright (C) 1998 - 2015, 2017, Daniel Stenberg, <daniel@haxx.se>, et al.
Copyright (C) 2018, Daniel Stenberg, <daniel@haxx.se>, et al.
Copyright (C) 1998 - 2016, 2018, Daniel Stenberg, <daniel@haxx.se>, et al.
Copyright (C) 1998 - 2015, 2018, Daniel Stenberg, <daniel@haxx.se>, et al.
Copyright (C) 2011, Daniel Stenberg, <daniel@haxx.se>, et al.

Copyright (C) 2015, Daniel Stenberg, <daniel@haxx.se>, et al.
Copyright (C) 2006, David Shaw <dshaw@jabberwocky.com>
Copyright (C) 2008 - 2016, Daniel Stenberg, <daniel@haxx.se>, et al.
Copyright (c) 2011, Jim Hollinger All rights reserved.
Copyright (c) 2003 The OpenEvidence Project. All rights reserved.
Copyright (C) 2012 - 2018, Daniel Stenberg, <daniel@haxx.se>, et al.
Copyright (C) 2013 - 2017, Daniel Stenberg, <daniel@haxx.se>, et al.
Copyright (c) 2000 David Odin (aka DindinX) for MandrakeSoft
Copyright (c) 2003, 2017 Simtec Electronics
Copyright (C) 2018 Jeroen Ooms <jeroenooms@gmail.com> License: MIT
Copyright (C) 2001 - 2018, Daniel Stenberg, <daniel@haxx.se>, et al.
Copyright (C) 2012 - 2017, Daniel Stenberg, <daniel@haxx.se>, et al.
Copyright (C) 2013 - 2019, Daniel Stenberg, <daniel@haxx.se>, et al.
Copyright (c) 2003-2016 CORE Security Technologies
Copyright (c) 2003-2016 CORE Security Technologies
Copyright (c) 2003-2016 CORE Security Technologies
Copyright (C) 2010-2019, Daniel Stenberg, <daniel@haxx.se>, et al.
Copyright (C) 2016, Evgeny Grin (Karlon2k), <k2k@narod.ru>.
Copyright (C) 2010-2012, Daniel Stenberg, <daniel@haxx.se>, et al.
Copyright (C) 2016, 2017, Daniel Stenberg, <daniel@haxx.se>, et al.
Copyright (C) 2010-2018, Daniel Stenberg, <daniel@haxx.se>, et al.
Copyright (C) 1998 - 2011, 2018, Daniel Stenberg, <daniel@haxx.se>, et al.
Copyright (C) 2017-2019, Daniel Stenberg, <daniel@haxx.se>, et al.
Copyright (C) 1998 - 2013, 2017, Daniel Stenberg, <daniel@haxx.se>, et al.
Copyright (C) 2013 - 2018, Linus Nielsen Feltzing <linus@haxx.se>
Copyright (C) 1998 - 2011, 2017, Daniel Stenberg, <daniel@haxx.se>, et al.
Copyright (C) 1998 - 2016, Vijay Panghal, <vpanghal@magnatics.com>, et al.
Copyright (C) 1994-2018 Free Software Foundation, Inc.
Copyright 2013, John Malmberg
Copyright 2012, John Malmberg
Copyright 2009, John Malmberg
Copyright 2014, John Malmberg
Copyright 2011, John Malmberg
Copyright (C) 2013 - 2019, Linus Nielsen Feltzing, <linus@haxx.se>
Copyright (C) 1998 - 2012, 2017, Daniel Stenberg, <daniel@haxx.se>, et al.
Copyright (C) 2017 - 2019, Daniel Stenberg, <daniel@haxx.se>, et al.
Copyright (C) 2003 - 2007, Gisle Vanem <gvanem@yahoo.no>.
Copyright (C) 2005 - 2008, Gisle Vanem <gvanem@yahoo.no>.
Copyright (C) 2013, Linus Nielsen Feltzing <linus@haxx.se>
Copyright (C) 2014, Steve Holme, <steve_holme@hotmail.com>.
Copyright (C) 1999 - 2018, Daniel Stenberg, <daniel@haxx.se>, et al.
Copyright (C) 1998 - 2014, 2019, Daniel Stenberg, <daniel@haxx.se>, et al.
Copyright (C) 2004 - 2014, Guenter Knauf
Copyright (C) 1999 - 2019, Daniel Stenberg, <daniel@haxx.se>, et al.
Copyright (C) 2011 - 2019, Daniel Stenberg, <daniel@haxx.se>
Copyright (C) 2004-2015 Free Software Foundation, Inc. This is free software
Copyright (C) 2010-2015 Free Software Foundation, Inc. This is free software
Copyright 1992-2019 Free Software Foundation, Inc.
Copyright (C) 2014 Free Software Foundation, Inc. This is free software
Copyright (C) 2011 Free Software Foundation, Inc. This config.lt script is free software
Copyright (C) 1998 - 2019, Daniel Stenberg, <daniel@haxx.se>, et al.
Copyright (C) 1998 - 2019, Daniel Stenberg, <daniel@haxx.se>, et al.
Copyright (C) 2002-2018 Free Software Foundation, Inc.
Copyright (C) 2001-2018 Free Software Foundation, Inc.
Copyright (C) 1997-2018 Free Software Foundation, Inc.
Copyright (C) 1999-2018 Free Software Foundation, Inc.

LICENCE TERMS (cont.)

Copyright (C) 1996-2018 Free Software Foundation, Inc.
Copyright (C) 2003-2018 Free Software Foundation, Inc.
Copyright (C) 2009-2018 Free Software Foundation, Inc.
Copyright (C) 2006-2018 Free Software Foundation, Inc.
Copyright (C) 2004-2018 Free Software Foundation, Inc.
Copyright (c) 2008 Kaveh Ghazi <ghazi@caip.rutgers.edu>
Copyright (c) 2017 Reini Urban <rurban@cpan.org>
Copyright (C) 1998 - 2018, Daniel Stenberg, <daniel@haxx.se>, et al.
Copyright (C) 1998 - 2011, Daniel Stenberg, <daniel@haxx.se>, et al.
Copyright (C) 1998 - 2009, Daniel Stenberg, <daniel@haxx.se>, et al.
Copyright (C) 1996-2001, 2003-2015 Free Software Foundation, Inc. Written by Gordon Matzigkeit, 1996
Copyright (C) 2014 Free Software Foundation, Inc. This is free software
Copyright (C) 2011 Free Software Foundation, Inc. This config.lt script is free software
Copyright (C) 2004-2005, 2007-2009, 2011-2015 Free Software Foundation, Inc. Written by Gary V. Vaughan, 2004
Copyright (C) 2004-2005, 2007-2008, 2011-2015 Free Software Foundation, Inc. Written by Gary V. Vaughan, 2004
Copyright (C) 2004, 2011-2015 Free Software Foundation, Inc. Written by Scott James Remnant, 2004
Copyright (C) 2004-2005, 2007, 2009, 2011-2015 Free Software Foundation, Inc. Written by Scott James Remnant, 2004.
Copyright (c) 2013 Daniel Stenberg <daniel@haxx.se>
Copyright (c) 2011 Daniel Stenberg <daniel@haxx.se>
Copyright (c) 2013 - 2018 Daniel Stenberg <daniel@haxx.se>
Copyright (c) 2013 Daniel Stenberg <daniel@haxx.se>
Copyright (C) 2002-2018 Free Software Foundation, Inc.
Copyright (C) 2001-2018 Free Software Foundation, Inc.
Copyright (C) 1997-2018 Free Software Foundation, Inc.
Copyright (C) 1999-2018 Free Software Foundation, Inc.
Copyright (C) 1996-2018 Free Software Foundation, Inc.
Copyright (C) 2003-2018 Free Software Foundation, Inc.
Copyright (C) 2009-2018 Free Software Foundation, Inc.
Copyright (C) 2006-2018 Free Software Foundation, Inc.
Copyright (C) 2004-2018 Free Software Foundation, Inc.
Copyright (c) 2008 Kaveh Ghazi <ghazi@caip.rutgers.edu>
Copyright (c) 2017 Reini Urban <rurban@cpan.org>
Copyright (C) 1998 - 2018, Daniel Stenberg, <daniel@haxx.se>, et al.
Copyright (C) 1998 - 2011, Daniel Stenberg, <daniel@haxx.se>, et al.
Copyright (C) 1998 - 2009, Daniel Stenberg, <daniel@haxx.se>, et al.
Copyright (C) 1996-2001, 2003-2015 Free Software Foundation, Inc. Written by Gordon Matzigkeit, 1996
Copyright (C) 2004-2005, 2007-2009, 2011-2015 Free Software Foundation, Inc. Written by Gary V. Vaughan, 2004
Copyright (C) 2004-2005, 2007-2008, 2011-2015 Free Software Foundation, Inc. Written by Gary V. Vaughan, 2004
Copyright (C) 2004, 2011-2015 Free Software Foundation, Inc. Written by Scott James Remnant, 2004
Copyright (C) 2004-2005, 2007, 2009, 2011-2015 Free Software Foundation, Inc. Written by Scott James Remnant, 2004.
Copyright (c) 2013 Daniel Stenberg <daniel@haxx.se>
Copyright (c) 2011 Daniel Stenberg <daniel@haxx.se>
Copyright (c) 2013 - 2018 Daniel Stenberg <daniel@haxx.se>
Copyright (c) 2013 Daniel Stenberg <daniel@haxx.se>
Copyright (c) 1998 - 2019 Daniel Stenberg, <daniel@haxx.se>
Copyright (C) 2012 Free Software Foundation, Inc.
Copyright (C) 2015, Jay Satiro, <raysatiro@yahoo.com>.
Copyright (C) 2015, Jay Satiro, <raysatiro@yahoo.com>.
Copyright (C) 2011 - 2018, Daniel Stenberg, <daniel@haxx.se>, et al.
Copyright (C) 2011 - 2018, Daniel Stenberg, <daniel@haxx.se>, et al.
Copyright (C) 2003 - 2017, Daniel Stenberg, <daniel@haxx.se>, et al.
Copyright (C) 2003 - 2017, Daniel Stenberg, <daniel@haxx.se>, et al.
Copyright (C) 2005 - 2017, Daniel Stenberg, <daniel@haxx.se>, et al.
Copyright (C) 2005 - 2017, Daniel Stenberg, <daniel@haxx.se>, et al.
Copyright (c) 2004 - 2017 Daniel Stenberg All rights reserved.

Copyright (c) 2004 - 2017 Daniel Stenberg All rights reserved.
Copyright (C) 2018, Daniel Stenberg, <daniel@haxx.se>, et al.
Copyright (C) 2018, Daniel Stenberg, <daniel@haxx.se>, et al.
Copyright (C) 2001 - 2019, Daniel Stenberg, <daniel@haxx.se>, et al.
Copyright (C) 2001 - 2019, Daniel Stenberg, <daniel@haxx.se>, et al.
Copyright (C) 2012 - 2014, Linus Nielsen Feltzing, <linus@haxx.se>
Copyright (C) 2012 - 2014, Linus Nielsen Feltzing, <linus@haxx.se>
Copyright (c) 2001 Alexander Peslyak and it is hereby released to the general public under the following terms:
Copyright (c) 2001 Alexander Peslyak and it is hereby released to the general public under the following terms:
Copyright (C) 2010, Howard Chu, <hyc@highlandsun.com>
Copyright (C) 2010, Howard Chu, <hyc@highlandsun.com>
Copyright (C) 2015, Daniel Stenberg, <daniel@haxx.se>, et al.
Copyright (C) 2015, Daniel Stenberg, <daniel@haxx.se>, et al.
Copyright (C) 2015 - 2019, Daniel Stenberg, <daniel@haxx.se>, et al.
Copyright (C) 2015 - 2019, Daniel Stenberg, <daniel@haxx.se>, et al.
Copyright (C) 2011 - 2019, Daniel Stenberg, <daniel@haxx.se>, et al.
Copyright (C) 2011 - 2019, Daniel Stenberg, <daniel@haxx.se>, et al.
Copyright (C) 2012 - 2019, Daniel Stenberg, <daniel@haxx.se>, et al.
Copyright (C) 2012 - 2019, Daniel Stenberg, <daniel@haxx.se>, et al.
Copyright (C) 2016-2019, Daniel Stenberg, <daniel@haxx.se>, et al.
Copyright (C) 2016-2019, Daniel Stenberg, <daniel@haxx.se>, et al.
Copyright (c) 2001-2004 Damien Miller <djm@openbsd.org>
Copyright (c) 2001-2004 Damien Miller <djm@openbsd.org>
Copyright (C) 2012 - 2018, Daniel Stenberg, <daniel@haxx.se>, et al.
Copyright (C) 2012 - 2018, Daniel Stenberg, <daniel@haxx.se>, et al.
Copyright (C) 2010, Hoi-Ho Chan, <hoiho.chan@gmail.com>
Copyright (C) 2010, Hoi-Ho Chan, <hoiho.chan@gmail.com>
Copyright (C) 1998 - 2017, Daniel Stenberg, <daniel@haxx.se>, et al.
Copyright (C) 1998 - 2017, Daniel Stenberg, <daniel@haxx.se>, et al.
Copyright (C) 2010 - 2011, Hoi-Ho Chan, <hoiho.chan@gmail.com>
Copyright (C) 2010 - 2011, Hoi-Ho Chan, <hoiho.chan@gmail.com>
Copyright (C) 1998 - 2017, Daniel Stenberg, <daniel@haxx.se>, et al.
Copyright (C) 1998 - 2017, Daniel Stenberg, <daniel@haxx.se>, et al.
Copyright (C) 2012, Mark Salisbury, <mark.salisbury@hp.com>
Copyright (C) 2012, Mark Salisbury, <mark.salisbury@hp.com>
Copyright (C) 2010, 2011, Hoi-Ho Chan, <hoiho.chan@gmail.com>
Copyright (C) 2010, 2011, Hoi-Ho Chan, <hoiho.chan@gmail.com>
Copyright (C) 1998 - 2012, Daniel Stenberg, <daniel@haxx.se>, et al.
Copyright (C) 1998 - 2012, Daniel Stenberg, <daniel@haxx.se>, et al.
Copyright (C) 2009, 2011, Markus Moeller, <markus_moeller@compuserve.com>
Copyright (C) 2009, 2011, Markus Moeller, <markus_moeller@compuserve.com>
Copyright (C) 2001 - 2018, Daniel Stenberg, <daniel@haxx.se>, et al.
Copyright (C) 2001 - 2018, Daniel Stenberg, <daniel@haxx.se>, et al.
Copyright (C) 1998 - \$year, Daniel Stenberg, <daniel@haxx.se>, et al.
Copyright (C) 1998 - \$year, Daniel Stenberg, <daniel@haxx.se>, et al.
copyright[(Copyright (c) 1998 - 2019 Daniel Stenberg, <daniel@haxx.se>
copyright[(Copyright (c) 1998 - 2019 Daniel Stenberg, <daniel@haxx.se>
Copyright (C) 1998 - 2016, Daniel Stenberg, <daniel@haxx.se>, et al.
Copyright (C) 1998 - 2016, Daniel Stenberg, <daniel@haxx.se>, et al.
Copyright (C) 2001 Michael Teo <michaelteo@bigfoot.com>
Copyright (C) 2001 Michael Teo <michaelteo@bigfoot.com>
Copyright 2002-2016 Core Security Technologies
Copyright (C) 1998 - 2013, Daniel Stenberg, <daniel@haxx.se>, et al.
Copyright (C) 1998 - 2013, Daniel Stenberg, <daniel@haxx.se>, et al.
copyright */ define LIBCURL_COPYRIGHT "1996 - 2019 Daniel Stenberg, <daniel@haxx.se>."
Copyright (C) 2017, Daniel Stenberg, <daniel@haxx.se>, et al.
Copyright (C) 2017, Daniel Stenberg, <daniel@haxx.se>, et al.

LICENCE TERMS (cont.)

Copyright (C) 2014, Vijay Panghal, <vpanghal@magnatics.com>, et al.
Copyright (C) 2014, Vijay Panghal, <vpanghal@magnatics.com>, et al.
Copyright (C) 2003 - 2015, Daniel Stenberg, <daniel@haxx.se>, et al.
Copyright (C) 2003 - 2015, Daniel Stenberg, <daniel@haxx.se>, et al.
Copyright (C) 2005 - 2015, Daniel Stenberg, <daniel@haxx.se>, et al.
Copyright (C) 2005 - 2015, Daniel Stenberg, <daniel@haxx.se>, et al.
Copyright (C) 1994 X Consortium
Copyright (C) 1996-2015 Free Software Foundation, Inc. This is free software
Copyright (C) 1999-2018 Free Software Foundation, Inc. Written by Tom Tromey <tromey@cygnus.com>.
Copyright 1992-2019 Free Software Foundation, Inc.
Copyright (C) 1999-2018 Free Software Foundation, Inc.
Copyright (C) 2004-2005, 2007, 2009, 2011-2015 Free Software Foundation, Inc. Written by Scott James Remnant, 2004.
Copyright (C) 2004, 2011-2015 Free Software Foundation, Inc. Written by Scott James Remnant, 2004
Copyright (C) 1996-2001, 2003-2015 Free Software Foundation, Inc. Written by Gordon Matzigkeit, 1996
Copyright (C) 2004-2005, 2007-2008, 2011-2015 Free Software Foundation, Inc. Written by Gary V. Vaughan, 2004
Copyright (C) 2004-2005, 2007-2009, 2011-2015 Free Software Foundation, Inc. Written by Gary V. Vaughan, 2004
Copyright (c) 2006-2007 Diego Pettenò <flameeyes@gmail.com>
Copyright (C) 1996-2018 Free Software Foundation, Inc. Originally written by Fran.cois Pinard <pinard@iro.umontreal.ca>, 1996.
Copyright (C) 1991, 1999 Free Software Foundation, Inc.
Copyright 2003-2008 Lennart Poettering
Copyright 2003-2009 Lennart Poettering <mzqnrzba (at) 0pointer (dot) de>
Copyright (C) 1994-2018 Free Software Foundation, Inc.
Copyright 2003-2009 Lennart Poettering <@PACKAGE_BUGREPORT@></i></p>
<i>Copyright (C) 1996-2018 Free Software Foundation, Inc.
<i>Copyright (C) 1992-1996, 1998-2012 Free Software Foundation, Inc.
<i>Copyright (C) 2008 Free Software Foundation, Inc.
<i>Copyright (C) 2011 Free Software Foundation, Inc.
<i>Copyright 2003-2009 Lennart Poettering <
<i>Copyright (C) 2004-2015 Free Software Foundation, Inc. This is free software
<i>Copyright (C) 2010-2015 Free Software Foundation, Inc. This is free software
<i>Copyright 1992-2019 Free Software Foundation, Inc.
<i>Copyright (C) 2014 Free Software Foundation, Inc. This is free software
<i>Copyright (C) 2011 Free Software Foundation, Inc. This config.lt script is free software
<i>Copyright (c) 2006-2007 xine project dnl dnl This program is free software
<i>Copyright 2003-2008 Lennart Poettering
<i>Copyright (C) 2002-2018 Free Software Foundation, Inc.
<i>Copyright (C) 2001-2018 Free Software Foundation, Inc.
<i>Copyright (C) 1997-2018 Free Software Foundation, Inc.
<i>Copyright (C) 1999-2018 Free Software Foundation, Inc.
<i>Copyright (C) 1996-2018 Free Software Foundation, Inc.
<i>Copyright (C) 2003-2018 Free Software Foundation, Inc.
<i>Copyright (C) 2009-2018 Free Software Foundation, Inc.
<i>Copyright (C) 2006-2018 Free Software Foundation, Inc.
<i>Copyright (C) 2004-2018 Free Software Foundation, Inc.
<i>Copyright (c) 2006-2007 Diego Pettenò <flameeyes@gmail.com>
<i>Copyright (C) 1996-2001, 2003-2015 Free Software Foundation, Inc. Written by Gordon Matzigkeit, 1996
<i>Copyright (C) 2004-2005, 2007-2009, 2011-2015 Free Software Foundation, Inc. Written by Gary V. Vaughan, 2004
<i>Copyright (C) 2004-2005, 2007-2008, 2011-2015 Free Software Foundation, Inc. Written by Gary V. Vaughan, 2004
<i>Copyright (C) 2004, 2011-2015 Free Software Foundation, Inc. Written by Scott James Remnant, 2004
<i>Copyright (C) 2004-2005, 2007, 2009, 2011-2015 Free Software Foundation, Inc. Written by Scott James Remnant, 2004.
<i>Copyright (C) 2012 Free Software Foundation, Inc. This configure script is free software
<i>Copyright (C) 2012 Free Software Foundation, Inc. This config.status script is free software
<i>Copyright (C) 1996, 1997, 1998, 1999, 2000, 2001, 2003, 2004, 2005, 2006, 2007, 2008 Free Software Foundation, Inc. Written by Gordon Matzigkeit, 1996

Copyright (C) 1994 X Consortium
Copyright (C) 1996-2015 Free Software Foundation, Inc. This is free software
Copyright (C) 1999-2018 Free Software Foundation, Inc. Written by Tom Tromey <tromey@cygnus.com>.
Copyright 1992-2019 Free Software Foundation, Inc.
Copyright (C) 1999-2018 Free Software Foundation, Inc.
Copyright (C) 2004-2005, 2007, 2009, 2011-2015 Free Software Foundation, Inc. Written by Scott James Remnant, 2004.
Copyright (C) 2004, 2011-2015 Free Software Foundation, Inc. Written by Scott James Remnant, 2004
Copyright (C) 1996-2001, 2003-2015 Free Software Foundation, Inc. Written by Gordon Matzigkeit, 1996
Copyright (C) 2004-2005, 2007-2008, 2011-2015 Free Software Foundation, Inc. Written by Gary V. Vaughan, 2004
Copyright (C) 2004-2005, 2007-2009, 2011-2015 Free Software Foundation, Inc. Written by Gary V. Vaughan, 2004
Copyright (C) 1996-2018 Free Software Foundation, Inc. Originally written by Fran.cois Pinard <pinard@iro.umontreal.ca>, 1996.
Copyright (c) 2014 Mike Frysinger <vapier@gentoo.org>
Copyright 1985, 1986, 1988, 1990, 1991, 1992, 1993, 1994, 1995, 1996, 1997, 1998, 1999, 2000, 2001, 2002, 2003, 2004, 2005, 2006, 2007, 2008, 2009, 2010, 2011, 2012, 2013, 2014, 2015, 2016, 2017, 2018 Free Software Foundation, Inc.
Copyright (C) 1995-2018 Free Software Foundation, Inc. written by Ulrich Drepper <drepper@gnu.ai.mit.edu>, June 1995
Copyright (C) 2009 the Initial Developer. All Rights Reserved.
Copyright (C) 1996-2018 Free Software Foundation, Inc.
Copyright (C) 1992-1996, 1998-2012 Free Software Foundation, Inc.
Copyright (C) 2011 Free Software Foundation, Inc.
Copyright (C) 2003, 2006, 2009, 2010, 2014 Free Software Foundation, Inc.
Copyright (C) 1994-2018 Free Software Foundation, Inc.
Copyright (C) 2005 Free Software Foundation, Inc.
Copyright (c) 2008 Guido U. Draheim <guidod@gmx.de>
Copyright (c) 2009 Guido U. Draheim <guidod@gmx.de>
Copyright (c) 2008 Steven G. Johnson <stevengj@alum.mit.edu>
Copyright (c) 1996, 1998, 2005 Red Hat, Inc.
Copyright (c) 1996-2014 Anthony Green, Red Hat, Inc and others. See source files for details.
Copyright (C) 2008, 2010, 2011 Red Hat, Inc.
Copyright @copyright{} 2008, 2010, 2011 Red Hat, Inc.
Copyright (c) 2011, 2014 Anthony Green
Copyright (c) 2014 Red Hat, Inc.
Copyright (C) 2011, 2012, 2013 Anthony Green
Copyright (c) 2004 Simon Posnjak
Copyright (c) 1998 Cygnus Solutions
Copyright (c) 2012 Anthony Green
Copyright (c) 2009, 2010, 2011, 2012 ARM Ltd.
Copyright (c) 1998, 2001, 2007, 2008, 2011, 2014 Red Hat
Copyright (c) 2011 Anthony Green
Copyright (c) 1996, 1998, 2005, 2007, 2009, 2010 Red Hat, Inc.
Copyright (c) 1998, 2008, 2011 Red Hat, Inc.
Copyright (c) 2011 Timothy Wall
Copyright (c) 1998, 2007, 2008, 2012 Red Hat, Inc.
Copyright (c) 1998, 2008 Red Hat, Inc.
Copyright (c) 2000 Hewlett Packard Company
Copyright (c) 2011 Tilera Corp.
Copyright (c) 2012 Tilera Corp.
Copyright (c) 2012 Tilera Corp. Target configuration macros for TILE.
Copyright (c) 2013 Tensilica, Inc.
Copyright (c) 2013 Tensilica, Inc. Target configuration macros for XTENSA.
Copyright (c) 2013 Miodrag Vallat. <miod@openbsd.org>
Copyright (c) 2012, 2013 Anthony Green
Copyright (C) 2012, 2013, 2018 Anthony Green
Copyright (c) 2012, 2013 Anthony Green Target configuration macros for Moxie

LICENCE TERMS (cont.)

Copyright (c) 1999, 2007, 2008 Red Hat, Inc.
Copyright (c) 2002, 2003, 2004, 2006, 2008 Kaz Kojima
Copyright (c) 2002-2008, 2012 Kaz Kojima
Copyright (c) 1996, 1998 Red Hat, Inc.
Copyright (c) 2012, 2013 Xilinx, Inc
Copyright (c) 2013 Mentor Graphics.
Copyright (c) 2007, 2009, 2010 Red Hat, Inc.
Copyright (c) 2000, 2003, 2004, 2008 Red Hat, Inc.
Copyright (c) 2011, 2013 Anthony Green
Copyright (c) 2013 The Written Word, Inc.
Copyright (c) 2012 Alexandre K. I. de Mendonca <alexandre.keunecke@gmail.com>, Paulo Pizarro <paulo.pizarro@gmail.com>
Copyright (c) 2012 Alexandre K. I. de Mendonca <alexandre.keunecke@gmail.com>
Copyright (C) 2004, 2005, 2007 Free Software Foundation, Inc.
Copyright (C) 2004, 2007 Free Software Foundation, Inc.
Copyright (c) 2004 Renesas Technology
Copyright (c) 2004 Renesas Technology
Copyright (C) 2003, 2005, 2008, 2009, 2010, 2011, 2014 Free Software Foundation, Inc.
Copyright (c) 2004 Anthony Green
Copyright (C) 2003-2004, 2006, 2009-2017 Free Software Foundation, Inc.
Copyright (C) 2004 Anthony Green
Copyright 1993 Bill Triggs <Bill.Triggs@inrialpes.fr>
Copyright (C) 2003, 2006, 2009, 2010, 2014, 2018 Free Software Foundation, Inc.
Copyright (c) 2013 Imagination Technologies Ltd.
Copyright (c) 2013 Imagination Technologies
Copyright (c) 2013 Imagination Technologies Ltd. Target configuration macros for Meta
(c) 2003-2004 Randolph Chung <tausq@debian.org>;(c) 2008 Red Hat, Inc.
Copyright (c) 2006 Free Software Foundation, Inc.;(c) 2008 Red Hat, Inc. based on src/pa/linux.S
(c) 2011 Anthony Green
Copyright (c) 2003, 2004, 2006, 2008 Kaz Kojima
Copyright (c) 2003, 2004, 2006, 2007, 2012 Kaz Kojima
Copyright (c) 2014 Sebastian Macke <sebastian@macke.de>
Copyright (c) 1999, 2008 Red Hat, Inc.
Copyright (c) 2013 Synopsys, Inc. (www.synopsys.com)
Copyright (c) 2013 Synopsys, Inc. (www.synopsys.com)
Copyright (c) 1998 Geoffrey Keating
Copyright (c) 2002, 2003, 2009 Free Software Foundation, Inc. based on darwin_closure.S
Copyright (c) 2003 Jakub Jelinek <jakub@redhat.com>
Copyright (C) 2013 IBM
Copyright (C) 1998 Geoffrey Keating
Copyright (c) 1998 Geoffrey Keating
Copyright (c) 2000 John Hornkvist
Copyright (c) 2002, 2003, 2004, 2010, Free Software Foundation, Inc. based on ppc_closure.S
Copyright (c) 2002, 2009 Free Software Foundation, Inc. based on darwin.S by John Hornkvist
Copyright (c) 2011, 2012 Anthony Green
Copyright (c) 2000 Software AG
Copyright (c) 2000, 2007 Software AG
Copyright (c) 2018 Anthony Green
Copyright (c) 2017 Anthony Green
Copyright (c) 2012, 2014, 2018 Anthony Green
Copyright (c) 2015 Michael Knyszek <mknyszek@berkeley.edu> 2015 Andrew Waterman <waterman@cs.berkeley.edu> 2018 Stef O'Rear <sorear2@gmail.com>
Copyright (c) 2015 Michael Knyszek <mknyszek@berkeley.edu> 2015 Andrew Waterman <waterman@cs.berkeley.edu> 2018 Stef O'Rear <sorear2@gmail.com> Based on MIPS N32/64 port
Copyright (c) 1996 Red Hat, Inc.
Copyright (c) 2012 Alan Hourihane
Copyright (c) 2009 Bradley Smith <brad@brad-smith.co.uk>

Copyright (C) 2004-2015 Free Software Foundation, Inc. This is free software
Copyright (C) 2010-2015 Free Software Foundation, Inc. This is free software
Copyright 1992-2019 Free Software Foundation, Inc.
Copyright (C) 2014 Free Software Foundation, Inc. This is free software
Copyright (C) 2011 Free Software Foundation, Inc. This config.lt script is free software
Copyright (C) 2002-2018 Free Software Foundation, Inc.
Copyright (C) 2001-2018 Free Software Foundation, Inc.
Copyright (C) 1997-2018 Free Software Foundation, Inc.
Copyright (C) 1999-2018 Free Software Foundation, Inc.
Copyright (C) 1996-2018 Free Software Foundation, Inc.
Copyright (C) 2003-2018 Free Software Foundation, Inc.
Copyright (C) 2009-2018 Free Software Foundation, Inc.
Copyright (C) 2006-2018 Free Software Foundation, Inc.
Copyright (C) 2004-2018 Free Software Foundation, Inc.
Copyright (C) 1999-2008, 2011-2015 Free Software Foundation, Inc. Written by Thomas Tanner, 1999
Copyright (c) 2008 Guido U. Draheim <guidod@gmx.de>
Copyright (c) 2011 Maarten Bosmans <mkbosmans@gmail.com>
Copyright (c) 2008 Steven G. Johnson <stevenj@alum.mit.edu>
Copyright (c) 2008 Matteo Frigo
Copyright (c) 2010 Rhys Ulerich <rhys.ulerich@gmail.com>
Copyright (c) 2009 Guido U. Draheim <guidod@gmx.de>
Copyright (c) 2009 Alan Jenkins <alan-jenkins@tuffmail.co.uk>
Copyright (c) 2014 Tsukasa Oi
Copyright (c) 2017 Alexey Kopytov
Copyright (c) 2015 Michael Petch <mpetch@capp-sysware.com>
Copyright (c) 2014 Mike Frysinger <vapier@gentoo.org>
Copyright (C) 1996-2001, 2003-2015 Free Software Foundation, Inc. Written by Gordon Matzigkeit, 1996
Copyright (C) 2014 Free Software Foundation, Inc. This is free software
Copyright (C) 2011 Free Software Foundation, Inc. This config.lt script is free software
Copyright (C) 2004-2005, 2007-2009, 2011-2015 Free Software Foundation, Inc. Written by Gary V. Vaughan, 2004
Copyright (C) 2004-2005, 2007-2008, 2011-2015 Free Software Foundation, Inc. Written by Gary V. Vaughan, 2004
Copyright (C) 2004, 2011-2015 Free Software Foundation, Inc. Written by Scott James Remnant, 2004
Copyright (C) 2004-2005, 2007, 2009, 2011-2015 Free Software Foundation, Inc. Written by Scott James Remnant, 2004.
Copyright (C) 2002-2018 Free Software Foundation, Inc.
Copyright (C) 2001-2018 Free Software Foundation, Inc.
Copyright (C) 1997-2018 Free Software Foundation, Inc.
Copyright (C) 1999-2018 Free Software Foundation, Inc.
Copyright (C) 1996-2018 Free Software Foundation, Inc.
Copyright (C) 2003-2018 Free Software Foundation, Inc.
Copyright (C) 2009-2018 Free Software Foundation, Inc.
Copyright (C) 2006-2018 Free Software Foundation, Inc.
Copyright (C) 2004-2018 Free Software Foundation, Inc.
Copyright (C) 1999-2008, 2011-2015 Free Software Foundation, Inc. Written by Thomas Tanner, 1999
Copyright (c) 2008 Guido U. Draheim <guidod@gmx.de>
Copyright (c) 2011 Maarten Bosmans <mkbosmans@gmail.com>
Copyright (c) 2008 Steven G. Johnson <stevenj@alum.mit.edu>
Copyright (c) 2008 Matteo Frigo
Copyright (c) 2010 Rhys Ulerich <rhys.ulerich@gmail.com>
Copyright (c) 2009 Guido U. Draheim <guidod@gmx.de>
Copyright (c) 2009 Alan Jenkins <alan-jenkins@tuffmail.co.uk>
Copyright (c) 2014 Tsukasa Oi
Copyright (c) 2017 Alexey Kopytov
Copyright (c) 2015 Michael Petch <mpetch@capp-sysware.com>
Copyright (c) 2014 Mike Frysinger <vapier@gentoo.org>
Copyright (C) 1996-2001, 2003-2015 Free Software Foundation, Inc. Written by Gordon Matzigkeit, 1996
Copyright (C) 2004-2005, 2007-2009, 2011-2015 Free Software Foundation, Inc. Written by Gary V. Vaughan, 2004

LICENCE TERMS (cont.)

Copyright (C) 2004-2005, 2007-2008, 2011-2015 Free Software Foundation, Inc. Written by Gary V. Vaughan, 2004
Copyright (C) 2004, 2011-2015 Free Software Foundation, Inc. Written by Scott James Remnant, 2004
Copyright (C) 2004-2005, 2007, 2009, 2011-2015 Free Software Foundation, Inc. Written by Scott James Remnant, 2004.
Copyright (C) 2012 Free Software Foundation, Inc. This configure script is free software
Copyright (C) 2012 Free Software Foundation, Inc. This config.status script is free software
copyright© Vadla Ravnås <oleavr@gmail.com> Date: Wed Mar 15 01:43:11 2017 +0100
copyright© Vadla Ravnås <oleavr@gmail.com> Date: Wed Mar 15 01:23:40 2017 +0100
copyright© Vadla Ravnås <oleavr@gmail.com> Date: Wed Aug 10 22:48:09 2016 +0200
copyright© Vadla Ravnås <oleavr@gmail.com> Date: Wed Aug 10 15:22:19 2016 +0200
copyright© Vadla Ravnås <oleavr@gmail.com> Date: Wed Aug 10 15:21:42 2016 +0200
copyright© Vadla Ravnås <oleavr@gmail.com> Date: Wed Aug 10 15:59:56 2016 +0200
copyright© Vadla Ravnås <ole.andre.ravnas@tillitech.com> Date: Fri Jul 25 21:40:50 2014 +0200
copyright© Vadla Ravnås <ole.andre.ravnas@tillitech.com> Date: Sat Jul 26 00:11:06 2014 +0200
copyright© Vadla Ravnås <ole.andre.ravnas@tillitech.com> Date: Sat Apr 12 01:04:04 2014 +0200
copyright© Vadla Ravnås <ole.andre.ravnas@tillitech.com> Date: Sun Apr 6 20:54:13 2014 +0200
copyright© Vadla Ravnås <ole.andre.ravnas@tillitech.com> Date: Sun Apr 6 20:53:02 2014 +0200
Copyright (C) 2008, 2010, 2011 Red Hat, Inc.
Copyright (c) 1996-2003, 2007, 2008 Red Hat, Inc.
Copyright (c) 1996-2003, 2007, 2008 Red Hat, Inc.
Copyright (C) 2007 Free Software Foundation, Inc
Copyright (c) 1996 Red Hat, Inc.
Copyright (c) 2005 Axis Communications AB
Copyright (c) 2004 Simon Posnjak
Copyright (c) 2005 Axis Communications AB
Copyright (C) 2007 Free Software Foundation, Inc.
Copyright (c) 1996-2003 Red Hat, Inc. Target configuration macros for CRIS.
Copyright (c) 1996-2003 Red Hat, Inc. Target configuration macros for CRIS.
Copyright (c) 1998, 2001, 2007, 2008 Red Hat, Inc.
Copyright (c) 1998, 2001, 2007, 2008 Red Hat, Inc.
Copyright (c) 1996-2003 Red Hat, Inc. Target configuration macros for Alpha.
Copyright (c) 1996-2003 Red Hat, Inc. Target configuration macros for Alpha.
Copyright (c) 2008 David Daney
Copyright (c) 1996, 2007, 2008, 2011 Red Hat, Inc.
Copyright (c) 2008 David Daney
Copyright (c) 1996, 2007, 2008, 2011 Red Hat, Inc.
Copyright (c) 1996-2003 Red Hat, Inc. Target configuration macros for MIPS.
Copyright (c) 1996-2003 Red Hat, Inc. Target configuration macros for MIPS.
Copyright (c) 2011 Plausible Labs Cooperative, Inc.
Copyright (c) 2011 Plausible Labs Cooperative, Inc.
Copyright (c) 2011 Anthony Green
Copyright (c) 2011 Free Software Foundation
Copyright (c) 1998, 2008, 2011 Red Hat, Inc.
Copyright (c) 2011 Anthony Green
Copyright (c) 2011 Free Software Foundation
Copyright (c) 1998, 2008, 2011 Red Hat, Inc.
Copyright (c) 2010 CodeSourcery
Copyright (c) 1996-2003 Red Hat, Inc.
Copyright (c) 2010 CodeSourcery
Copyright (c) 1996-2003 Red Hat, Inc.
Copyright (c) 2000 Hewlett Packard Company
Copyright (c) 2000 Hewlett Packard Company
Copyright (c) 1996-2003 Red Hat, Inc. Target configuration macros for IA-64.
Copyright (c) 1996-2003 Red Hat, Inc. Target configuration macros for IA-64.
Copyright (c) 2008 Red Hat, Inc.
Copyright (c) 2008 Red Hat, Inc.
Copyright (c) 1996-2003 Red Hat, Inc. Target configuration macros for SuperH.

Copyright (c) 1996-2003 Red Hat, Inc. Target configuration macros for SuperH.
Copyright (C) 2007, 2009, 2010 Free Software Foundation, Inc
Copyright (C) 2007, 2009, 2010 Free Software Foundation, Inc
Copyright (c) 1996, 2003-2004, 2007-2008 Red Hat, Inc.
Copyright (c) 1996, 2003-2004, 2007-2008 Red Hat, Inc.
Copyright (c) 1996, 1997, 2003, 2004, 2008 Red Hat, Inc.
Copyright (c) 1996, 1997, 2003, 2004, 2008 Red Hat, Inc.
Copyright (c) 1996-2003 Red Hat, Inc. Target configuration macros for SPARC.
Copyright (c) 1996-2003 Red Hat, Inc. Target configuration macros for SPARC.
Copyright (c) 2008 Red Hat, Inc.
Copyright (c) 2004 Renesas Technology. Target configuration macros for M32R.
Copyright (C) 2007 Free Software Foundation, Inc.
Copyright (C) 2008 Red Hat, Inc.
Copyright (C) 2007 Free Software Foundation, Inc.
Copyright (C) 2008 Red Hat, Inc.
Copyright (c) 1996-2004 Red Hat, Inc. Target configuration macros for FR-V
Copyright (c) 1996-2004 Red Hat, Inc. Target configuration macros for FR-V
Copyright 1995-2017 Bruno Haible <bruno@clisp.org>
COPYRIGHT(c) 2008 Red Hat, Inc.
COPYRIGHT(c) 2006 Free Software Foundation, Inc.
COPYRIGHT(c) 2003-2004 Randolph Chung <tausq@debian.org>
Copyright (c) 1996-2003 Red Hat, Inc. Target configuration macros for hppa.
Copyright (c) 1996-2003 Red Hat, Inc. Target configuration macros for hppa.
Copyright (c) 2008 Anthony Green
Copyright (c) 2008 Anthony Green
Copyright (c) 1996-2003 Red Hat, Inc. Target configuration macros for SuperH - SHmedia.
Copyright (c) 1996-2003 Red Hat, Inc. Target configuration macros for SuperH - SHmedia.
Copyright (c) 2013 Synopsys, Inc. (www.synopsys.com) Target configuration macros for ARC.
Copyright (C) 2007 Free Software Foundation, Inc
Copyright (C) 2011 Anthony Green
Copyright (C) 2011 Kyle Moffett
Copyright (C) 2008 Red Hat, Inc
Copyright (C) 2007, 2008 Free Software Foundation, Inc
Copyright (c) 1998 Geoffrey Keating
Copyright (C) 2001 John Hornkvist
Copyright (C) 2002, 2006, 2007, 2009, 2010 Free Software Foundation, Inc.
Copyright (c) 2004, 2010 Free Software Foundation, Inc.
Copyright (C) 2007, 2008, 2010 Free Software Foundation, Inc
Copyright (C) 2007, 2008, 2010 Free Software Foundation, Inc
Copyright (c) 1996, 1998, 2007 Red Hat, Inc.
Copyright (c) 1996, 1998, 2007 Red Hat, Inc.
Copyright (c) 2008 Red Hat, Inc
Copyright (c) 1996-2003 Red Hat, Inc. Target configuration macros for S390.
Copyright (c) 1996-2003 Red Hat, Inc. Target configuration macros for S390.
Copyright (c) 2014 Red Hat, Inc.
Copyright (c) 2014 Red Hat, Inc.
Copyright (c) 2013 The Written Word, Inc.
Copyright (c) 1996,1998,2001-2003,2005,2008,2010 Red Hat, Inc.
Copyright (c) 2013 The Written Word, Inc.
Copyright (c) 1996,1998,2001-2003,2005,2008,2010 Red Hat, Inc.
Copyright (c) 2008, 2010 Red Hat, Inc.
Copyright (c) 2002, 2007 Bo Thorsen <bo@suse.de>
Copyright (c) 2008, 2010 Red Hat, Inc.
Copyright (c) 2002, 2007 Bo Thorsen <bo@suse.de>
Copyright (c) 1996, 1998, 1999, 2001, 2007, 2008 Red Hat, Inc.
Copyright (c) 2002 Ranjit Mathew
Copyright (c) 2002 Bo Thorsen

LICENCE TERMS (cont.)

Copyright (c) 2002 Roger Sayle
Copyright (C) 2008, 2010 Free Software Foundation, Inc.
Copyright (c) 1996, 1998, 1999, 2001, 2007, 2008 Red Hat, Inc.
Copyright (c) 2002 Ranjit Mathew
Copyright (c) 2002 Bo Thorsen
Copyright (c) 2002 Roger Sayle
Copyright (C) 2008, 2010 Free Software Foundation, Inc.
Copyright (c) 1996-2003, 2010 Red Hat, Inc.
Copyright (C) 2008 Free Software Foundation, Inc.
Copyright (c) 1996-2003, 2010 Red Hat, Inc.
Copyright (C) 2008 Free Software Foundation, Inc.
Copyright (c) 2008 Red Hat, Inc.
Copyright (c) 2002 Bo Thorsen <bo@suse.de>
Copyright (c) 2008 Red Hat, Inc.
Copyright (c) 2002 Bo Thorsen <bo@suse.de>
Copyright (c) 1998, 2012 Andreas Schwab
Copyright (c) 2012, 2016 Thorsten Glaser
Copyright (c) 1998, 2012 Andreas Schwab
Copyright (c) 2012, 2016 Thorsten Glaser
Copyright (c) 1996-2003 Red Hat, Inc. Target configuration macros for Motorola 68K.
Copyright (c) 1996-2003 Red Hat, Inc. Target configuration macros for Motorola 68K.
Copyright (c) 2009 Bradley Smith <brad@brad-smith.co.uk>
Copyright (c) 2009 Bradley Smith <brad@brad-smith.co.uk>
Copyright (c) 2009 Bradley Smith <brad@brad-smith.co.uk> Target configuration macros for AVR32.
Copyright (c) 2009 Bradley Smith <brad@brad-smith.co.uk> Target configuration macros for AVR32.
Copyright (C) 2017 Free Software Foundation, Inc. This is free software; see the source for copying conditions. There is NO warranty; not even for MERCHANTABILITY or FITNESS FOR A PARTICULAR PURPOSE.
Copyright (C) 1990-2019 Free Software Foundation, Inc.
Copyright (C) 2012 Free Software Foundation, Inc. This config.status script is free software; the Free Software Foundation gives unlimited permission to copy, distribute and modify it."
Copyright (C) 1999-2019 Free Software Foundation, Inc.
Copyright (C) 2002, 2007, 2009 Free Software Foundation, Inc.
copyright (c) 1998, 1999, 2000, 2002, 2009 The Free Software Foundation, Inc.
Copyright (C) 2017 Free Software Foundation, Inc. This is free software
Copyright (C) 2004-2019 Free Software Foundation, Inc.
Copyright (C) 1994-2017 Free Software Foundation, Inc.
Copyright (C) 2012 Free Software Foundation, Inc. This config.status script is free software
Copyright (C) 1996, 1997, 1998, 1999, 2000, 2001, 2003, 2004, 2005, 2006, 2007, 2008, 2009 Free Software Foundation, Inc. Written by Gordon Matzigkeit, 1996
Copyright (C) 2019 Free Software Foundation, Inc.
Copyright (C) 1994-2017 Free Software Foundation, Inc.
Copyright (C) 2012-2019 Free Software Foundation, Inc. Written by Ian Lance Taylor, Google.
Copyright (C) 1990, 1991, 1992, 1993, 1994, 1995, 1996, 1997, 1998, 1999, 2000, 2001, 2002, 2003, 2004, 2005, 2006, 2007, 2008, 2009, 2010, 2011 Free Software Foundation
Copyright (C) 2019 Free Software Foundation, Inc.
Copyright (C) 2005-2019 Free Software Foundation, Inc.
Copyright (C) 1997-2019 Free Software Foundation, Inc.
Copyright (C) 2003-2019 Free Software Foundation, Inc. Contributed by Paul Brook
Copyright (C) 2004-2019 Free Software Foundation, Inc.
Copyright (C) 2011-2019 Free Software Foundation, Inc.
Copyright %s 2019 Free Software Foundation, Inc.
Copyright (C) 1987-2019 Free Software Foundation, Inc.
Copyright (C) 2004-2019 Free Software Foundation, Inc.
Copyright (C) 2000-2019 Free Software Foundation, Inc.
Copyright (C) 2011-2019 Free Software Foundation, Inc. Contributed by Andi Kleen.
Copyright (C) 1992-2019 Free Software Foundation, Inc.
Copyright (C) 2001-2019 Free Software Foundation, Inc. Contributed by Axis Communications. Written by Hans-

Peter Nilsson.
Copyright (C) 2009-2019 Free Software Foundation, Inc. Contributed by ARM Ltd.
Copyright (C) 2011-2019 Free Software Foundation, Inc. Contributed by ARM Ltd.
Copyright (C) 1996-2019 Free Software Foundation, Inc. Contributed by Richard Henderson.
Copyright (C) 1998-2019 Free Software Foundation, Inc.
Copyright (C) 2003-2019 Free Software Foundation, Inc.
Copyright (C) 2001-2019 Free Software Foundation, Inc. Contributed by Alexandre Oliva <aoliva@redhat.com>
Copyright (C) 2001-2019 Free Software Foundation, Inc.
Copyright (C) 1994-2019 Free Software Foundation, Inc. Contributed by Eric Youngdale. Modified for stabs-in-ELF by H.J. Lu.
Copyright (C) 2001-2019 Free Software Foundation, Inc. Contributed by Jan Hubicka <jh@suse.cz>, based on linux.h.
Copyright (C) 2002-2019 Free Software Foundation, Inc.
Copyright (C) 1995-2019 Free Software Foundation, Inc. Contributed by Eric Youngdale. Modified for stabs-in-ELF by H.J. Lu (hjl@lucon.org).
Copyright (C) 2011-2019 Free Software Foundation, Inc. Contributed by Walter Lee (walt@tilera.com)
Copyright (C) 1999-2019 Free Software Foundation, Inc. Contributed by Kazumoto Kojima <kkojima@rr.iij4u.or.jp>
Copyright (C) 2009-2019 Free Software Foundation, Inc.
Copyright (C) 2015-2019 Free Software Foundation, Inc. Contributed by Yoshinori Sato <yosato@users.sourceforge.jp>
Copyright (C) 2012-2019 Free Software Foundation, Inc. Contributed by Andes Technology Corporation.
Copyright (C) 2012-2019 Free Software Foundation, Inc. Contributed by Mentor Graphics, Inc.
Copyright (C) 1996-2019 Free Software Foundation, Inc. Contributed by Eddie C. Dost (ecd@skynet.be)
Copyright (C) 1996-2019 Free Software Foundation, Inc. Contributed by David S. Miller (davem@caip.rutgers.edu)
Copyright (C) 2007-2019 Free Software Foundation, Inc.
Copyright (C) 1999-2019 Free Software Foundation, Inc. Contributed by Red Hat Inc.
Copyright (C) 2018-2019 Free Software Foundation, Inc. Contributed by Stafford Horne.
Copyright (C) 2017-2019 Free Software Foundation, Inc.
Copyright (C) 1999-2019 Free Software Foundation, Inc. Contributed by Hartmut Penner (hpenner@de.ibm.com) and Ulrich Weigand (uweigand@de.ibm.com).
Copyright (C) 1996-2019 Free Software Foundation, Inc. Contributed by Michael Meissner (meissner@cygnus.com).
Copyright (C) 1995-2019 Free Software Foundation, Inc.
Copyright (C) 2007-2019 Free Software Foundation, Inc. This file is part of GCC.
Copyright (C) 2013-2019 Free Software Foundation, Inc. Contributed by ARM Ltd.
Copyright (C) 2008-2019 Free Software Foundation, Inc.
Copyright (C) 1989-2019 Free Software Foundation, Inc.
Copyright (C) 2006-2019 Free Software Foundation, Inc. Contributed by CodeSourcery.
Copyright (C) 2016-2019 Free Software Foundation, Inc. Contributed by ARM Ltd.
Copyright (C) 2015-2019 Free Software Foundation, Inc. Contributed by ARM Ltd.
Copyright (C) 2013-2019 Free Software Foundation, Inc.
Copyright (C) 1994-2018 Free Software Foundation, Inc.
Copyright (C) 1992-2019 Free Software Foundation, Inc. Contributed by Ron Guilmette (rfg@monkeys.com)
Copyright (C) 1995-1998, 2000-2003 Free Software Foundation, Inc.
Copyright 2002, 2007, 2009 Free Software Foundation, Inc
Copyright (C) 2017 Free Software Foundation, Inc. This is free software
Copyright (C) 1996, 1997, 1998, 1999, 2000, 2001, 2003, 2004, 2005, 2006, 2007, 2008, 2009 Free Software Foundation, Inc. Written by Gordon Matzigkeit, 1996
Copyright (C) 1996, 1997, 1998, 1999, 2000, 2001, 2003, 2004, 2005, 2006, 2007, 2008, 2009 Free Software Foundation, Inc. This is free software
Copyright (C) 2012-2019 Free Software Foundation, Inc.
Copyright (C) 2012-2019 Free Software Foundation, Inc.
Copyright (C) 2002-2019 Free Software Foundation, Inc.
Copyright (C) 1991-2019 Free Software Foundation, Inc.
Copyright (C) 1994 X Consortium
Copyright (C) 1996-2015 Free Software Foundation, Inc. This is free software
Copyright (C) 1999-2018 Free Software Foundation, Inc. Written by Tom Tromey <tromey@cygnus.com>.
Copyright 1992-2019 Free Software Foundation, Inc.

LICENCE TERMS (cont.)

Copyright (C) 1999-2018 Free Software Foundation, Inc.
Copyright (C) 2004-2005, 2007, 2009, 2011-2015 Free Software Foundation, Inc. Written by Scott James Remnant, 2004.
Copyright (C) 2004, 2011-2015 Free Software Foundation, Inc. Written by Scott James Remnant, 2004
Copyright (C) 1996-2001, 2003-2015 Free Software Foundation, Inc. Written by Gordon Matzigkeit, 1996
Copyright (C) 2004-2005, 2007-2008, 2011-2015 Free Software Foundation, Inc. Written by Gary V. Vaughan, 2004
Copyright (C) 2004-2005, 2007-2009, 2011-2015 Free Software Foundation, Inc. Written by Gary V. Vaughan, 2004
Copyright (C) 1996-2018 Free Software Foundation, Inc. Originally written by Fran.cois Pinard <pinard@iro.umontreal.ca>, 1996.
Copyright (C) 1989, 1991 Free Software Foundation, Inc.
Copyright (C) 1994-1996, 1999-2002, 2004-2016 Free Software Foundation, Inc.
Copyright 1985, 1986, 1988, 1990, 1991, 1992, 1993, 1994, 1995, 1996, 1997, 1998, 1999, 2000, 2001, 2002, 2003, 2004, 2005, 2006, 2007, 2008, 2009, 2010, 2011, 2012, 2013, 2014, 2015, 2016, 2017, 2018 Free Software Foundation, Inc.
Copyright (C) 1995-2018 Free Software Foundation, Inc. written by Ulrich Drepper <drepper@gnu.ai.mit.edu>, June 1995
Copyright @copyright{} 1989, 1991 Free Software Foundation, Inc.
Copyright (C) 2005, 2013, 2015, 2016, 2017 g10 Code GmbH
Copyright @copyright{} 1991, 1999 Free Software Foundation, Inc.
Copyright (C) 2011 Free Software Foundation, Inc.
Copyright (C) 1992, 1994, 1998, 2001, 2002 Free Software Foundation, Inc.
Copyright (C) 1989,1991-2018 Free Software Foundation, Inc.
Copyright (C) 1998, 1999, 2000, 2001, 2002, dnl 2003 Free Software Foundation, Inc.
Copyright (C) 2003, 2014 g10 Code GmbH
Copyright (C) 2013 g10 Code GmbH
Copyright (c) 2012, Intel Corporation
Copyright (C) 1992, 1994, 1998, 2001, 2002, 2006 Free Software Foundation, Inc.
Copyright 1998, 1999, 2000, 2001, 2002, 2003, 2004, 2006, 2007, 2008, 2009, 2011 Free Software Foundation, Inc.
Copyright (C) 1992, 1994, 1995, 1998, 2001, 2002, 2006 Free Software Foundation, Inc.
Copyright (C) 2016 Jussi Kivilinna <jussi.kivilinna@iki.fi>
Copyright (C) 2006,2007 NTT (Nippon Telegraph and Telephone Corporation).
Copyright (C) 2012 Simon Josefsson, Niels Möller
Copyright (C) 2014 Jussi Kivilinna <jussi.kivilinna@iki.fi>
Copyright (C) 1992, 1993, 1994, 1998, 2001, 2002 Free Software Foundation, Inc.
Copyright (C) 2013 Jussi Kivilinna <jussi.kivilinna@iki.fi>
Copyright (C) 1992, 1994, 1995, 1998, 2001, 2002 Free Software Foundation, Inc.
Copyright (C) 2013-2015 Jussi Kivilinna <jussi.kivilinna@iki.fi>
Copyright (C) 1992, 1993, 1994, 1995, 1998, 2001, 2002 Free Software Foundation, Inc.
Copyright (C) 2007, 2008, 2010, 2011 Free Software Foundation, Inc.
Copyright (C) 1993, 1994, 1996, 1998, 2001, 2002 Free Software Foundation, Inc.
Copyright (C) 1994, 1996, 1998, 2001, 2002, 2003 Free Software Foundation, Inc.
Copyright (C) 2015 g10 Code GmbH
Copyright (C) 2007 Free Software Foundation, Inc.
Copyright (C) 1998, 2001, 2002, 2003 Free Software Foundation, Inc.
Copyright 1997, 1998, 1999, 2001 Werner Koch (dd9jn)
Copyright (C) 1994, 1996, 1998, 1999, 2000, 2001, 2002 Free Software Foundation, Inc.
Copyright (C) 1994-2018 Free Software Foundation, Inc.
Copyright (C) 1994, 1996, 1997, 1998, 2001, 2002 Free Software Foundation, Inc.
Copyright (C) 2005 Free Software Foundation, Inc.
Copyright (C) 2003, 2008, 2009 Free Software Foundation, Inc.
Copyright (C) 1992, 1994, 1996, 1998, 2002 Free Software Foundation, Inc. Contributed by Peter L. Montgomery.
Copyright (C) 1994, 1996, 1998, 2001, 2002 Free Software Foundation, Inc.
Copyright (C) 2009, 2011 Free Software Foundation, Inc.
Copyright (C) 2012 Free Software Foundation, Inc.
Copyright (C) 2015 Jussi Kivilinna <jussi.kivilinna@iki.fi>
Copyright (C) 1994, 1996, 1997, 1998, 2000, 2002 Free Software Foundation, Inc.
Copyright (C) 2013 Jussi Kivilinna <jussi.kivilinna@iki.fi>

Copyright (C) 1998, 1999, 2000, 2001, 2002 Free Software Foundation, Inc.
Copyright (C) 1998, 1999, 2001, 2002, 2005 Free Software Foundation, Inc.
Copyright (C) 1992, 1994, 1995, 1998, 2000 2001, 2002 Free Software Foundation, Inc.
Copyright (C) 1995, 1998, 2000 2001, 2002 Free Software Foundation, Inc.
Copyright (C) 1995, 1998, 1999, 2000, 2001, 2002 Free Software Foundation, Inc.
Copyright (C) 1998, 1999, 2000, 2001, 2002, 2003 2005, 2007, 2008, 2009, 2011 Free Software Foundation, Inc.
Copyright (C) 1995, 1998, 2000, 2001, 2002 Free Software Foundation, Inc.
Copyright (C) 2017 Jussi Kivilinna <jussi.kivilinna@iki.fi>
Copyright (C) 2011 Free Software Foundation, Inc.
Copyright (C) 1998, 2000, 2001, 2002, 2003, 2007 Free Software Foundation, Inc.
Copyright (C) 1994, 1996, 1998, 2000, 2001, 2002 Free Software Foundation, Inc.
Copyright (C) 1998, 1999, 2000, 2001, 2002, 2003, 2009 Free Software Foundation, Inc.
Copyright (C) 1994, 1996, 1998, 2000, 2002 2003 Free Software Foundation, Inc. 2013 g10 Code GmbH
Copyright (C) 2000, 2001, 2002, 2003 Free Software Foundation, Inc.
Copyright (C) 1991, 1992, 1993, 1994, 1996, 1998, 2000, 2001, 2002, 2003, 2004, 2011 Free Software Foundation, Inc.
Copyright (C) 1998, 2001, 2002, 2003, 2010 Free Software Foundation, Inc.
Copyright (C) 1994, 1996, 1998, 1999, 2001, 2002 Free Software Foundation, Inc.
Copyright (C) 1998, 2001, 2002, 2003, 2008 Free Software Foundation, Inc.
Copyright (C) 1992, 1994, 1999, 2002 Free Software Foundation, Inc.
Copyright (C) 1992, 1994, 1996, 1999, 2002 Free Software Foundation, Inc.
Copyright (C) 2003, 2006, 2008, 2009 Free Software Foundation, Inc.
Copyright (C) 1992, 1994, 1995, 1996, 1999, 2002 Free Software Foundation, Inc.
Copyright (C) 2015, 2016 g10 Code GmbH
Copyright (C) 2006 Free Software Foundation, Inc.
Copyright (C) 1995, 1996, 1998, 2001, 2002 Free Software Foundation, Inc.
Copyright (C) 2000, 2001, 2002, 2003, 2007, 2008 Free Software Foundation, Inc.
Copyright (C) 1998, 1999 Free Software Foundation, Inc.
Copyright (C) 1998, 2002, 2003 Free Software Foundation, Inc. Written by Matthew Skala <mscala@ansuz.sooke.bc.ca>
Copyright (C) 1992, 1994, 1996, 1998, 2001, 2002 Free Software Foundation, Inc.
Copyright (C) 1992, 1994,1996, 1998, 2001, 2002 Free Software Foundation, Inc.
Copyright (C) 2013 Dmitry Eremin-Solenikov
Copyright (C) 2008 Free Software Foundation, Inc.
Copyright (C) 1996, 1998, 2001, 2002 Free Software Foundation, Inc.
Copyright (C) 2013-2014 Jussi Kivilinna <jussi.kivilinna@iki.fi>
Copyright (C) 2013-2014 Jussi Kivilinna <jussi.kivilinna@iki.fi>
Copyright (C) 2002-2003, 2006 Free Software Foundation, Inc.
Copyright (C) 1998, 2000, 2001, 2002, 2003 2004, 2008 Free Software Foundation, Inc.
Copyright (C) 2005, 2006 Free Software Foundation, Inc.
Copyright (C) 2003, 2004, 2005 Free Software Foundation, Inc.
Copyright (C) 1994-2018 Free Software Foundation, Inc.
Copyright (C) 1995,1996,1998,1999,2001,2002, 2003 Free Software Foundation, Inc.
Copyright (C) 1995-2006 Free Software Foundation, Inc.
Copyright (C) 2000, 2001, 2002, 2003, 2007, 2008, 2011, 2012 Free Software Foundation, Inc.
Copyright (C) 1998, 1999, 2002, 2003, 2006, 2008 Free Software Foundation, Inc.
Copyright (C) 1998, 1999, 2000, 2001, 2002, 2003, 2004, 2006, 2007, 2008, 2009, 2011 Free Software Foundation, Inc.
Copyright (C) 1999, 2002 Free Software Foundation, Inc.
Copyright (C) 2001, 2002, 2003, 2005 Free Software Foundation, Inc.
Copyright (C) 2013 Dmitry Eremin-Solenikov
Copyright (C) 2015 Jussi Kivilinna <jussi.kivilinna@iki.fi>
Copyright (C) 2002, 2003 Free Software Foundation, Inc.
Copyright (C) 2014-2017 Jussi Kivilinna <jussi.kivilinna@iki.fi>
Copyright (C) 1998, 2000, 2001, 2002, 2003, 2006, 2008 Free Software Foundation, Inc.
Copyright (C) 1998, 2011 Free Software Foundation, Inc.
Copyright (C) 2013 g10 code GmbH

LICENCE TERMS (cont.)

Copyright (C) 2002, 2003, 2004, 2011, 2014 g10 Code GmbH
Copyright (C) 1998, 1999, 2000, 2002, 2003, 2005, 2007, 2008, 2011 Free Software Foundation, Inc.
Copyright (C) 2000, 2002, 2003, 2004, 2006, 2007, 2008, 2009, 2011, 2012 Free Software Foundation, Inc.
Copyright (C) 2012-2017 Jussi Kivilinna <jussi.kivilinna@iki.fi>
Copyright (C) 2002 Free Software Foundation, Inc.
Copyright (C) 2012 Simon Josefsson
Copyright (C) 1998, 2000, 2001, 2002, 2003, 2008 Free Software Foundation, Inc.
Copyright @copyright{} 2000, 2002, 2003, 2004, 2006, 2007, 2008, 2009, 2011, 2012 Free Software Foundation, Inc.
Copyright 2011 Free Software Foundation, Inc.
Copyright (C) 2017 Jussi Kivilinna <jussi.kivilinna@iki.fi>
Copyright 2001, 2002, 2003, 2008 Free Software Foundation, Inc.
Copyright (C) 2013-2017 Jussi Kivilinna <jussi.kivilinna@iki.fi>
Copyright (C) 2000, 2002 Free Software Foundation, Inc.
Copyright (C) 2001, 2002, 2003, 2005, 2008, 2009 Free Software Foundation, Inc.
Copyright (C) 2013, 2014 g10 Code GmbH
Copyright (C) 2003 Nikos Mavroyanopoulos
Copyright (C) 2002, 2004, 2005, 2006, 2008 Free Software Foundation, Inc.
Copyright 2008 Free Software Foundation, Inc.
Copyright (C) 1998, 1999, 2000, 2001, 2002, 2003 2005, 2007, 2008, 2009, 2011 Free Software Foundation, Inc.
Copyright (C) 2007 Free Software Foundation, Inc.
Copyright (C) 1998, 1999, 2001, 2002, 2003, 2008 Free Software Foundation, Inc.
Copyright 2017 Jussi Kivilinna <jussi.kivilinna@iki.fi>
Copyright (C) 2003 Free Software Foundation, Inc.
Copyright (C) 2016 g10 Code GmbH
Copyright (C) 2008 Free Software Foundation, Inc.
Copyright (C) 1997, 1998, 1999 by Werner Koch (dd9jn)
Copyright (C) 2004, 2005, 2008 Free Software Foundation, Inc.
Copyright (C) 2014 g10 Code GmbH
Copyright (C) 1992, 1999, 2000, 2002 Free Software Foundation, Inc.
Copyright (c) atsec information security corporation
Copyright (C) 1996-2018 Free Software Foundation, Inc.
Copyright (C) 1992-1996, 1998-2012 Free Software Foundation, Inc.
Copyright (C) 2010 Free Software Foundation, Inc.
Copyright (C) 2009 Free Software Foundation, Inc.
Copyright (C) 2010 Free Software Foundation, Inc.
Copyright (C) 2003, 2005, 2012 Free Software Foundation, Inc.
Copyright 1998,1999,2000,2001,2002 Free Software Foundation, Inc.
Copyright 1996-2013 Free Software Foundation, Inc. Taken from GNU libtool, 2001 Originally by Gordon Matzigkeit <gord@gnu.ai.mit.edu>, 1996
Copyright (C) 2011 Free Software Foundation, Inc. This config.lt script is free software; the Free Software Foundation gives unlimited permission to copy, distribute and modify it."
Copyright (C) 2001, 2002, 2003, 2006 Free Software Foundation, Inc.
Copyright (C) 2001, 2002, 2003, 2005 Free Software Foundation, Inc.
Copyright (C) 2002, 2003, 2004, 2005, 2006 Free Software Foundation Author: Simon Josefsson
Copyright (C) 1995, 1998, 2001, 2002 Free Software Foundation, Inc.
Copyright (C) 1991, 1999 Free Software Foundation, Inc.
Copyright (C) 1994, 1995, 1998, 2001, 2002 Free Software Foundation, Inc.
Copyright 2014 Stephan Mueller <smueller@chronox.de>
Copyright (C) 1994, 1995, 1998, 1999, 2000, 2001, 2002 Free Software Foundation, Inc.
Copyright (C) 1998, 2002 Free Software Foundation, Inc.
Copyright 2008, 2009 Free Software Foundation, Inc.
Copyright (C) 1998, 1999, 2001, 2002, 2003 Free Software Foundation, Inc.
Copyright (C) 1998, 2000, 2001, 2002, 2003, 2004, 2005, 2006, 2007, 2008, 2010, 2012 Free Software Foundation, Inc.
Copyright (C) 2003, 2006, 2008, 2012 Free Software Foundation, Inc.
Copyright Peter Gutmann, Paul Kendall, and Chris Wedgwood 1996-1999.
Copyright (C) 1998, 2001, 2002, 2003, 2007, 2009 Free Software Foundation, Inc.

Copyright Stephan Mueller <smueller@chronox.de>, 2014
Copyright (C) 1994, 1996, 1998, 2000, 2002, 2003 Free Software Foundation, Inc.
Copyright 2001 Free Software Foundation, Inc.
Copyright 2001, 2002 Free Software Foundation, Inc.
Copyright (C) 2017 g10 Code GmbH
Copyright Stephan Mueller <smueller@chronox.de>, 2014 - 2017
Copyright 2001, 2002, 2003, 2005 Free Software Foundation, Inc.
Copyright (C) 1998, 2002, 2006 Free Software Foundation, Inc.
Copyright (C) 1999, 2000, 2002, 2003 Free Software Foundation, Inc.
Copyright Stephan Mueller <smueller@chronox.de>, 2013
Copyright 2001, 2002, 2004, 2005 Free Software Foundation, Inc.
Copyright (C) 1999, 2000, 2002, 2003, 2007, 2010 Free Software Foundation, Inc.
Copyright 1998,1999,2000,2001,2002,2003 Free Software Foundation, Inc.
Copyright (C) 1998, 1999, 2001, 2002, 2006 Free Software Foundation, Inc.
Copyright (C) 2005, 2006 g10 Code GmbH
Copyright (C) 1997, 1998, 1999, 2004, 2006, 2013 Werner Koch
Copyright (C) 1999, 2002, 2003, 2004, 2011 Free Software Foundation, Inc.
Copyright (C) 1998, 1999, 2001, 2002, 2003, 2007 Free Software Foundation, Inc.
Copyright (C) 2003, 2006, 2008 Free Software Foundation, Inc.
Copyright (C) 1998, 1999, 2000, 2001, 2002, 2003, 2004, 2005, 2006, 2007 Free Software Foundation, Inc.
Copyright (C) 2002, 2004, 2008, 2011 Free Software Foundation, Inc.
Copyright (C) 1993, 1994, 1998, 2001, 2002, 2004 Free Software Foundation, Inc.
Copyright (C) 1998, 2000, 2002, 2005, 2008 Free Software Foundation, Inc.
Copyright (C) 2006 Free Software Foundation, Inc.
Copyright (C) 1994, 1996, 1998, 2001, 2002, 2003, 2005 Free Software Foundation, Inc.;(c) _gcry_mpi_barrett_free ((c))
Copyright (C) 1998, 1999, 2000, 2001, 2002, 2003 2004, 2005, 2006, 2008, 2011, 2012 Free Software Foundation, Inc.
Copyright (C) 2008, 2011 Free Software Foundation, Inc.
Copyright (C) 2007, 2011 Free Software Foundation, Inc.
Copyright (C) 1998, 1999, 2000, 2001, 2002, 2003 2008 Free Software Foundation, Inc.
Copyright (C) 1992, 1994, 1998, 2001, 2002 Fee Software Foundation, Inc.
Copyright (C) 1998, 1999, 2000, 2001, 2002, 2003, 2007 Free Software Foundation, Inc.
Copyright (C) 1992, 1994, 1998 2001, 2002 Free Software Foundation, Inc.
Copyright (C) 1999, 2000, 2001, 2002, 2003, 2004, 2006, 2007, 2008, 2011 Free Software Foundation, Inc.
Copyright (C) 1993, 1994, 1998, 2001, 2002 Free Software Foundation, Inc.
Copyright (C) 1994, 1998, 1999, 2000, 2001, 2003 Free Software Foundation, Inc.
Copyright (C) 1992, 1997, 1998 Free Software Foundation, Inc. This file is part of the GNU C Library.
Copyright (C) 1995, 1998, 2002 Free Software Foundation, Inc.
Copyright (C) 2007, 2010 Free Software Foundation, Inc.
Copyright (C) 1992, 1994, 1995, 1998, 2002 Free Software Foundation, Inc.
Copyright (C) 1998, 2000, 2002, 2003 Free Software Foundation, Inc.
Copyright (C) 1992, 1993, 1994, 1995, 1998, 2002 Free Software Foundation, Inc.
Copyright (C) 1998-2017 Free Software Foundation, Inc.
Copyright (C) 2012 g10 Code GmbH
Copyright (C) 2000, 2002, 2005 Free Software Foundation, Inc.
Copyright (C) 2007, 2008, 2011 Free Software Foundation, Inc.
Copyright (C) 1992, 1994, 1995, 1996, 1998, 2001, 2002 Free Software Foundation, Inc.
Copyright (C) 2007, 2011, 2012 Free Software Foundation, Inc.
Copyright (C) 2003, 2007 Free Software Foundation, Inc.
Copyright (C) 1998, 1999, 2000, 2001, 2002, 2003, 2005 2007, 2011 Free Software Foundation, Inc.
Copyright (C) 1999, 2001, 2002, 2003, 2007, 2008 Free Software Foundation, Inc.
Copyright (C) 1998, 2002, 2003, 2009 Free Software Foundation, Inc.
Copyright 2001, 2002, 2003, 2004, 2007, 2008, 2009, 2011 Free Software Foundation, Inc.
Copyright (C) 2004-2015 Free Software Foundation, Inc. This is free software
Copyright (C) 2010-2015 Free Software Foundation, Inc. This is free software
Copyright 1992-2019 Free Software Foundation, Inc.

LICENCE TERMS (cont.)

Copyright (C) 2014 Free Software Foundation, Inc. This is free software
Copyright (C) 2011 Free Software Foundation, Inc. This config.lt script is free software
Copyright (C) 2006, 2008, 2011 Free Software Foundation, Inc.
Copyright (C) 2005, 2017 g10 Code GmbH
Copyright (C) 2012-2018 g10 Code GmbH
Copyright (C) 2013-2018 Jussi Kivilinna
Copyright (C) 2013 g10 Code GmbH dnl dnl This file is part of Libgrypt. dnl dnl Libgrypt is free software
Copyright Stephan Mueller <smueller@chronox.de>, 2013
Copyright (C) 1994 X Consortium
Copyright Stephan Mueller <smueller@chronox.de>, 2013
Copyright (C) 1994 X Consortium
Copyright (C) 2013 g10 Code GmbH
Copyright (C) 1998, 2001, 2002, 2003, 2008 Free Software Foundation, Inc.
Copyright (C) 2013 Dmitry Eremin-Solenikov
Copyright 2013 g10 Code GmbH
Copyright (C) 1992, 1999, 2000, 2002 Free Software Foundation, Inc.
Copyright (C) 2012 g10 Code GmbH
Copyright 1998, 1999, 2000, 2001, 2002, 2003, 2004, 2005, 2006 2007, 2008, 2009, 2010, 2011 Free Software Foundation, Inc.
Copyright 2012, Samuel Neves <sneves@dei.uc.pt>
copyright© <funman@videolan.org>
Copyright (C) 2011 Free Software Foundation, Inc.
Copyright© <funman@videolan.org>
Copyright (C) 2011 Free Software Foundation, Inc.
Copyright (C) 2013, 2014 g10 Code GmbH
Copyright (C) 2012-2017 g10 Code GmbH
Copyright 1998, 1999, 2000, 2001, 2002, 2003, 2009, 2011 Free Software Foundation, Inc.
Copyright (C) 2013, 2018 Jussi Kivilinna <jussi.kivilinna@iki.fi>
Copyright (C) 2013 g10 Code GmbH.
Copyright (C) 1998, 1999, 2000, 2001, 2002, 2003, 2009 Free Software Foundation, Inc.
Copyright (C) 1989,1991-2018 Free Software Foundation, Inc.
Copyright (C) 1996 L. Peter Deutsch
Copyright (C) 1997 Werner Koch
Copyright (C) 1998 The Internet Society
Copyright (C) 1996-1999 Peter Gutmann, Paul Kendall, and Chris Wedgwood
Copyright (C) 1996-2006 Peter Gutmann, Matt Thomlinson and Blake Coverett
Copyright (C) 2003 Nikos Mavroyanopoulos
Copyright (C) 2006-2007 NTT (Nippon Telegraph and Telephone Corporation)
Copyright (C) 2012-2018 g10 Code GmbH
Copyright (C) 2012 Simon Josefsson, Niels Möller
Copyright (c) 2012 Intel Corporation
Copyright (C) 2013 Christian Grothoff
Copyright (C) 2013-2017 Jussi Kivilinna
Copyright (C) 2013-2014 Dmitry Eremin-Solenikov
Copyright (C) 2014 Stephan Mueller
Copyright (C) 2017 Bundesamt für Sicherheit in der Informationstechnik
Copyright Peter Gutmann, Paul Kendall, and Chris Wedgwood 1996-1999.
Copyright 2012 Simon Josefsson and Niels Möller.
Copyright (C) 1989,1991-2018 Free Software Foundation, Inc.
Copyright (C) 1996 L. Peter Deutsch
Copyright (C) 1997 Werner Koch
Copyright (C) 1998 The Internet Society
Copyright (C) 1996-1999 Peter Gutmann, Paul Kendall, and Chris Wedgwood
Copyright (C) 1996-2006 Peter Gutmann, Matt Thomlinson and Blake Coverett
Copyright (C) 2003 Nikos Mavroyanopoulos
Copyright (C) 2006-2007 NTT (Nippon Telegraph and Telephone Corporation)
Copyright (C) 2012 Simon Josefsson, Niels Möller

Copyright (c) 2012 Intel Corporation
Copyright (C) 2013 Christian Grothoff
Copyright (C) 2013-2017 Jussi Kivilinna
Copyright (C) 2013-2014 Dmitry Eremin-Solenikov
Copyright (C) 2014 Stephan Mueller
Copyright (C) 2017 Bundesamt für Sicherheit in der Informationstechnik
Copyright Peter Gutmann, Paul Kendall, and Chris Wedgwood 1996-1999.
Copyright 2012 Simon Josefsson and Niels Möller.
Copyright (C) 2012, 2013, 2016, 2017 g10 Code GmbH
Copyright 1999, 2000, 2002, 2003, 2008 Free Software Foundation, Inc.
Copyright (C) 2013 g10 Code GmbH
Copyright (C) 2012 Simon Josefsson
Copyright (C) 2012, 2013, 2016, 2017 g10 Code GmbH
Copyright (C) 2000, 2002, 2003, 2004, 2006, 2007, 2008, 2009, 2011, 2012 Free Software Foundation, Inc.
Copyright (C) 1991, 1999 Free Software Foundation, Inc
Copyright (C) 1989, 1991 Free Software Foundation, Inc.
Copyright (C) 2012, 2013, 2016, 2017 g10 Code GmbH
Copyright (C) 2000, 2002, 2003, 2004, 2006, 2007, 2008, 2009, 2011, 2012 Free Software Foundation, Inc.
Copyright (C) 1991, 1999 Free Software Foundation, Inc. 59 Temple Place - Suite 330, Boston, MA 02111-1307, USA
Copyright (C) 1989, 1991 Free Software Foundation, Inc.
Copyright (C) 2012, 2013, 2016, 2017 g10 Code GmbH
Copyright (C) 2000, 2002, 2003, 2004, 2006, 2007, 2008, 2009, 2011, 2012 Free Software Foundation, Inc.
Copyright (C) 1991, 1999 Free Software Foundation, Inc. 59 Temple Place - Suite 330, Boston, MA 02111-1307, USA
Copyright (C) 1989, 1991 Free Software Foundation, Inc. 59 Temple Place - Suite 330, Boston, MA 02111-1307, USA
Copyright (C) 2013, 2015 g10 Code GmbH
Copyright (C) 2002 Free Software Foundation, Inc.
Copyright @copyright{} 2012, 2013, 2016, 2017 g10 Code GmbH
Copyright (C) 2004 Free Software Foundation, Inc.
Copyright (C) 2000, 2001, 2002, 2003, 2008 Free Software Foundation, Inc.
Copyright (C) 2001, 2002, 2003, 2005 Free Software Foundation, Inc.
Copyright (C) 2002, 2003, 2004, 2011, 2014, 2018 g10 Code GmbH
Copyright (C) 2002-2018 Free Software Foundation, Inc.
Copyright (C) 2001-2018 Free Software Foundation, Inc.
Copyright (C) 1997-2018 Free Software Foundation, Inc.
Copyright (C) 1999-2018 Free Software Foundation, Inc.
Copyright (C) 1996-2018 Free Software Foundation, Inc.
Copyright (C) 2003-2018 Free Software Foundation, Inc.
Copyright (C) 2009-2018 Free Software Foundation, Inc.
Copyright (C) 2006-2018 Free Software Foundation, Inc.
Copyright (C) 2004-2018 Free Software Foundation, Inc.
Copyright © 2004 Scott James Remnant <scott@netsplit.com>.
Copyright © 2012-2015 Dan Nicholson <dbn.lists@gmail.com> dnl dnl This program is free software
Copyright (C) 1996-2001, 2003-2015 Free Software Foundation, Inc. Written by Gordon Matzigkeit, 1996
Copyright (C) 2004-2005, 2007-2009, 2011-2015 Free Software Foundation, Inc. Written by Gary V. Vaughan, 2004
Copyright (C) 2004-2005, 2007-2008, 2011-2015 Free Software Foundation, Inc. Written by Gary V. Vaughan, 2004
Copyright (C) 2004, 2011-2015 Free Software Foundation, Inc. Written by Scott James Remnant, 2004
Copyright (C) 2004-2005, 2007, 2009, 2011-2015 Free Software Foundation, Inc. Written by Scott James Remnant, 2004.
Copyright (C) 1995-2006 Free Software Foundation, Inc. dnl dnl This library is free software
Copyright (C) 2002-2003, 2006 Free Software Foundation, Inc. dnl This file is free software
Copyright (C) 2005, 2006 Free Software Foundation, Inc. dnl This file is free software
Copyright (C) 2012 Free Software Foundation, Inc. This configure script is free software
Copyright (C) 2012 Free Software Foundation, Inc. This config.status script is free software
Copyright (C) 2000-2018 Free Software Foundation, Inc.\n"

LICENCE TERMS (cont.)

Copyright (C) 2012-2018 g10 Code GmbH
Copyright (C) 2013-2018 Jussi Kiviniina
Copyright (C) 2010 Free Software Foundation, Inc.
Copyright (C) 2014 g10 Code GmbH
Copyright (C) 2012 Dmitry Kasatkin
copyright Peter Gutmann (and various others) 1996, 1997, 1998, 1999, all rights reserved.
Copyright (C) 2008 Free Software Foundation, Inc.
Copyright (C) 2013 Stephan Mueller <smueller@chronox.de>
Copyright (C) 2013 Stephan Mueller <smueller@chronox.de>
Copyright Peter Gutmann, Matt Thomlinson and Blake Coverett 1996-2006
Copyright Peter Gutmann, Matt Thomlinson and Blake Coverett 1996-2006
copyright Peter Gutmann (and various others) 1996, 1997, 1998, 1999, all rights reserved.
Copyright", "Copyright © 2018 Free Software Foundation, Inc.\0" VALUE "LegalTrademarks", "\0" VALUE
"OriginalFilename", "libgcrypt.dll\0" VALUE "PrivateBuild", "\0" VALUE "ProductName", "libgcrypt\0" VALUE
"ProductVersion", "@VERSION@\0"
Copyright (C) 1997, 2013 Werner Koch
Copyright (C) 1998,1999,2000,2001,2002,2003 2004,2005,2008,2009,2011 Free Software Foundation, Inc.
Copyright (C) 2008 Free Software Foundation, Inc.
Copyright (C) 2006 Free Software Foundation, Inc.
Copyright (C) 2013, 2014, 2017 g10 Code GmbH
Copyright (C) 2013, 2016 g10 Code GmbH
Copyright (C) 1998, 1999, 2000, 2001, 2002, 2003, 2004, 2005, 2006, 2007 Free Software Foundation, Inc.
Copyright (C) 1993, 1994, 1995, 1997 Free Software Foundation, Inc. This file is part of the GNU C Library.
Copyright (C) 2010 Free Software Foundation, Inc.
Copyright (C) 1997 Free Software Foundation, Inc. This file is part of the GNU C Library.
Copyright (C) 1996, 1997 Free Software Foundation, Inc. This file is part of the GNU C Library.
Copyright (C) 1995, 1997 Free Software Foundation, Inc. This file is part of the GNU C Library.
Copyright (C) 2012 Jussi Kiviniina
Copyright (C) 1994 X Consortium
Copyright (C) 1996-2015 Free Software Foundation, Inc. This is free software
Copyright (C) 1999-2018 Free Software Foundation, Inc. Written by Tom Tromey <tromey@cygnus.com>.
Copyright 1992-2019 Free Software Foundation, Inc.
Copyright (C) 1999-2018 Free Software Foundation, Inc.
Copyright (C) 2004-2005, 2007, 2009, 2011-2015 Free Software Foundation, Inc. Written by Scott James Remnant,
2004.
Copyright (C) 2004, 2011-2015 Free Software Foundation, Inc. Written by Scott James Remnant, 2004
Copyright (C) 1996-2001, 2003-2015 Free Software Foundation, Inc. Written by Gordon Matzigkeit, 1996
Copyright (C) 2004-2005, 2007-2008, 2011-2015 Free Software Foundation, Inc. Written by Gary V. Vaughan, 2004
Copyright (C) 2004-2005, 2007-2009, 2011-2015 Free Software Foundation, Inc. Written by Gary V. Vaughan, 2004
Copyright (C) 1996-2018 Free Software Foundation, Inc. Originally written by Fran.cois Pinard <pinard@iro.
umontreal.ca>, 1996.
Copyright (C) 1989, 1991 Free Software Foundation, Inc.
Copyright (C) 1995-1997, 2000-2007, 2009-2010 by Ulrich Drepper <drepper@gnu.ai.mit.edu>
Copyright 1996-2016 Free Software Foundation, Inc. Taken from GNU libtool, 2001 Originally by Gordon Matzigkeit
<gord@gnu.ai.mit.edu>, 1996
Copyright (C) 1991, 1999 Free Software Foundation, Inc.
Copyright (C) 1994-1996, 1999-2002, 2004-2016 Free Software Foundation, Inc.
Copyright (C) 2000-2002, 2004 Free Software Foundation, Inc.
Copyright (C) 2000-2002 Free Software Foundation, Inc.
Copyright 1996-2014 Free Software Foundation, Inc. Taken from GNU libtool, 2001 Originally by Gordon Matzigkeit
<gord@gnu.ai.mit.edu>, 1996
Copyright 1985, 1986, 1988, 1990, 1991, 1992, 1993, 1994, 1995, 1996, 1997, 1998, 1999, 2000, 2001, 2002, 2003,
2004, 2005, 2006, 2007, 2008, 2009, 2010, 2011, 2012, 2013, 2014, 2015, 2016, 2017, 2018 Free Software
Foundation, Inc.
Copyright (C) 1995-2018 Free Software Foundation, Inc. written by Ulrich Drepper <drepper@gnu.ai.mit.edu>, June
1995
Copyright @copyright{} 1989, 1991 Free Software Foundation, Inc.

Copyright (C) 2014 g10 Code GmbH
Copyright (C) 2003, 2014, 2017, 2018 g10 Code GmbH
Copyright (C) 2014 g10 Code GmbH
Copyright (C) 2005, 2013, 2015, 2016, 2017 g10 Code GmbH
Copyright (C) 2003, 2006, 2007, 2013 g10 Code GmbH
Copyright (C) 1994-2018 Free Software Foundation, Inc.
Copyright (C) 2003-2004, 2010, 2013-2016 g10 Code GmbH
Copyright @copyright{} 1991, 1999 Free Software Foundation, Inc.
Copyright @copyright{} 2014 g10 Code GmbH
Copyright (C) 1996-2018 Free Software Foundation, Inc.
Copyright (C) 2015 g10 Code GmbH
Copyright (C) 2013 g10 Code GmbH
Copyright (C) 2003 g10 Code GmbH
Copyright (C) 1992-1996, 1998-2012 Free Software Foundation, Inc.
Copyright (C) 2018 g10 Code GmbH
Copyright (C) 2011 Free Software Foundation, Inc.
Copyright (C) 2013 g10 Code GmbH
Copyright (C) 2013, 2015 g10 Code GmbH
Copyright (C) 2017, 2018 g10 Code GmbH
Copyright (C) 2006 g10 Code GmbH
Copyright (C) 2005 g10 Code GmbH
Copyright (C) 2003, 2006 g10 Code GmbH
Copyright 2006 g10 Code GmbH
Copyright (C) 2002, 2003, 2004, 2011, 2014, 2018 g10 Code GmbH
Copyright (C) 2004, 2005, 2006 g10 Code GmbH
Copyright (C) 2007, 2010, 2012 g10 Code GmbH
Copyright (C) 2004, 2005, 2006, 2007, 2009, 2010, 2011, 2014, 2015, 2016, 2017 g10 Code GmbH
Copyright (C) 2010 g10 Code GmbH
Copyright (C) 2000 Werner Koch (dd9jn)
Copyright (C) 2003, 2004 g10 Code GmbH
Copyright (C) 1998-2001, 2003-2006, 2009-2010, 2017 Free Software Foundation, Inc.
Copyright (C) 2010 g10 Code GmbH
Copyright (C) 2004 Simon Josefsson
Copyright (C) 2003, 2004, 2014 g10 Code GmbH
Copyright (C) 2007 g10 Code GmbH
Copyright (C) 2004, 2005 g10 Code GmbH
Copyright (C) 1997-2001, 2006-2008, 2013-2017 Werner Koch
Copyright (C) 2005-2014 Free Software Foundation, Inc.
Copyright (C) 1995, 1996, 1997, 1999, 2005, 2007, 2008, 2010 Free Software Foundation, Inc.
Copyright (C) 2003 Free Software Foundation, Inc.
Copyright (C) 2002-2003 Free Software Foundation, Inc.
Copyright (C) 1997-2004 Free Software Foundation, Inc.
Copyright (C) 2003, 2004, 2008 g10 Code GmbH
Copyright (C) 1997-2002, 2006 Free Software Foundation, Inc.
Copyright (C) 2001-2002 Free Software Foundation, Inc.
Copyright (C) 2002, 2003, 2004, 2011, 2014, 2017, 2018 g10 Code GmbH
Copyright (C) 2005 Free Software Foundation, Inc.
Copyright (C) 2003-2004 Free Software Foundation, Inc.
Copyright (C) 2002 Free Software Foundation, Inc.
Copyright (C) 2004, 2016 g10 Code GmbH
Copyright (C) 1994-2018 Free Software Foundation, Inc.
Copyright (C) 2002-2003, 2006 Free Software Foundation, Inc.
Copyright (C) 2005-2009 Free Software Foundation, Inc.
Copyright (C) 1997-2002 Free Software Foundation, Inc.
Copyright (c) 2010 Reuben Thomas <rrt@sc3d.org>
Copyright (C) 2004, 2005 Free Software Foundation, Inc.
Copyright (C) 1995-2002 Free Software Foundation, Inc.

LICENCE TERMS (cont.)

Copyright (C) 2007, 2008, 2009, 2010, 2012, 2014 g10 Code GmbH
Copyright (C) 1999-2004 Free Software Foundation, Inc.
Copyright (C) 2001, 2003, 2004, 2008, 2010, 2011 Free Software Foundation, Inc.
Copyright (C) 2010 Free Software Foundation, Inc.
Copyright (C) 2016, 2017 g10 Code GmbH
Copyright (C) 2003, 2005-2006 Free Software Foundation, Inc.
Copyright (C) 2002-2005 Free Software Foundation, Inc.
Copyright (C) 1995-2002, 2004-2005 Free Software Foundation, Inc.
Copyright (C) 2017 g10 Code GmbH
Copyright (C) 2017 g10 Code GmbH
Copyright (C) 2001-2019 g10 Code GmbH
Copyright (C) 2005, 2010 g10 Code GmbH
Copyright (C) 1995-1998, 2000-2002 Free Software Foundation, Inc.
Copyright (C) 2003, 2004, 2006, 2010, 2013-2017 g10 Code GmbH
Copyright 2008 g10 Code GmbH
Copyright (C) 2004 g10 Code GmbH
Copyright 2004, 2005 g10 Code GmbH
Copyright (C) 2002, 2005, 2010, 2012, 2017 g10 Code GmbH
Copyright (C) 2014, 2017 g10 Code GmbH
Copyright (C) 2008, 2011 Free Software Foundation, Inc.
Copyright (C) 2004, 2007-2009, 2010 Free Software Foundation, Inc.
Copyright (C) 2001, 2002, 2012, 2013, 2014 g10 Code GmbH
Copyright (C) 2005 Free Software Foundation, Inc. Laurentiu Buzdugan <lbusz@rolix.org>, 2005.
Copyright (C) 2016 g10 Code GmbH
Copyright (C) 2013 Free Software Foundation, Inc. This file is distributed under the same license as the libpgp-error package. Felipe Castro <fefcas@gmail.com>, 2013.
Copyright (C) 2009 Free Software Foundation, Inc. This file is distributed under the same license as the libpgp-error package. Aron Xu <happyaron.xu@gmail.com>, 2009.
Copyright (C) 2014 g10 Code GmbH
Copyright (C) 1999, 2002, 2003 Free Software Foundation, Inc.
Copyright 2003, 2010 g10 Code GmbH
Copyright 2003, 2004, 2005, 2010 g10 Code GmbH
Copyright (C) 2006, 2007, 2009 Free Software Foundation, Inc. This file is distributed under the same license as the libpgp-error package. Daniel Nylander <po@danielnylander.se>, 2006, 2007, 2009.
Copyright (C) 2014 g10 Code GmbH and nedenstående oversættere. This file is distributed under the same license as the libpgp-error package. Joe Hansen <joedalton2@yahoo.dk>, 2012, 2014.
Copyright (C) 2012 Free Software Foundation, Inc.
Copyright (C) 2018 Free Software Foundation, Inc. This file is distributed under the same license as the original package. Ineiev <ineiev@gnu.org>, 2014, 2015, 2018
Copyright (C) 2009, 2014 Free Software Foundation, Inc. This file is distributed under the same license as the libpgp-error package. Francesco Groccia <francesco.groccia@poste.it>, 2009. Milo Casagrande <milo@milo.name>, 2014.
Copyright © 2009 Free Software Foundation, Inc. This file is distributed under the same license as the libpgp-error package. Clytie Siddall <clytie@riverland.net.au>, 2006-2009.
Copyright (C) 2014 Jedi Lin This file is distributed under the same license as the libpgp-error package. Jedi Lin <Jedi@Jedi.org>, 2014
Copyright (C) 2004, 2005, 2006 Free Software Foundation, Inc. This file is distributed under the same license as the libpgp-error package. Jakub Bogusz <qboosh@pld-linux.org>, 2004-2018.
Copyright (C) 2009 Free Software Foundation, Inc. This file is distributed under the same license as the libpgp-error package. Petr Písar <petr.pisar@atlas.cz>, 2009, 2012, 2014.
Copyright (C) 2018 g10 Code GmbH This file is distributed under the same license as the libpgp-error package. emma peel <emma.peel@riseup.net>, 2018
Copyright (C) 2003 g10 Code GmbH This file is distributed under the terms of the GNU LGPL v2.1 or later. Werner Koch <wk@gnupg.org>, 2003.
Copyright (C) 2014 Free Software Foundation, Inc. This file is distributed under the same license as the libpgp-error package. Мирослав Николић <miroslavnikolic@rocketmail.com>, 2014. msgid "" msgstr "" Project-Id-Version: libpgp-error-1.7

Copyright (C) 2015 Free Software Foundation, Inc. This file is distributed under the same license as the libpgp-error package.
Copyright (C) 2010, 2012, 2014, 2015, 2016 Free Software Foundation, Inc. This file is distributed under the same license as the libpgp-error package. Yasuaki Taniguchi <yasuakit@gmail.com>, 2010. Takeshi Hamasaki <hmatrjp@users.sourceforge.jp>, 2012. NIIBE Yutaka <gniibe@fsij.org>, 2014, 20
Copyright (C) 2005, 2011, 2012, 2014 Free Software Foundation, Inc. This file is distributed under the same license as the libpgp-error package.
Copyright 2003 g10 Code GmbH
Copyright (C) 2008 Free Software Foundation, Inc.
Copyright (C) 2004-2015 Free Software Foundation, Inc. This is free software
Copyright (C) 2010-2015 Free Software Foundation, Inc. This is free software
Copyright 1992-2019 Free Software Foundation, Inc.
Copyright (C) 2014 Free Software Foundation, Inc. This is free software
Copyright (C) 2011 Free Software Foundation, Inc. This config.lt script is free software
Copyright (C) 2014 g10 Code GmbH
Copyright (C) 1991, 1999 Free Software Foundation, Inc. 59 Temple Place - Suite 330, Boston, MA 02111-1307, USA
Copyright (C) 1989, 1991 Free Software Foundation, Inc. 59 Temple Place - Suite 330, Boston, MA 02111-1307, USA
copyright the software, and (2) offer you this license which gives you legal permission to copy, distribute and/or modify the software.
Copyright (C) 2014 g10 Code GmbH
Copyright (C) 1991, 1999 Free Software Foundation, Inc. 59 Temple Place - Suite 330, Boston, MA 02111-1307, USA
Copyright (C) 1989, 1991 Free Software Foundation, Inc. 59 Temple Place - Suite 330, Boston, MA 02111-1307, USA
Copyright (C) 2014 g10 Code GmbH
Copyright (C) 1991, 1999 Free Software Foundation, Inc. 59 Temple Place - Suite 330, Boston, MA 02111-1307, USA
Copyright (C) 1989, 1991 Free Software Foundation, Inc. 59 Temple Place - Suite 330, Boston, MA 02111-1307, USA
Copyright (C) 2006, 2008, 2011 Free Software Foundation, Inc.
Copyright (C) 2005, 2017 g10 Code GmbH
Copyright 2003, 2004, 2005, 2006, 2007, 2010, 2011 g10 Code GmbH
Copyright 2003, 2004, 2005, 2006, 2007, 2010, 2011 g10 Code GmbH
Copyright (C) 2014 g10 Code GmbH
Copyright (C) 2002-2018 Free Software Foundation, Inc.
Copyright (C) 2001-2018 Free Software Foundation, Inc.
Copyright (C) 1997-2018 Free Software Foundation, Inc.
Copyright (C) 1999-2018 Free Software Foundation, Inc.
Copyright (C) 1996-2018 Free Software Foundation, Inc.
Copyright (C) 2003-2018 Free Software Foundation, Inc.
Copyright (C) 2009-2018 Free Software Foundation, Inc.
Copyright (C) 2006-2018 Free Software Foundation, Inc.
Copyright (C) 2004-2018 Free Software Foundation, Inc.
Copyright (C) 1995-2014, 2016 Free Software Foundation, Inc.
Copyright (C) 2000-2002, 2007-2014, 2016 Free Software Foundation, Inc.
Copyright (C) 2004-2014, 2016 Free Software Foundation, Inc.
Copyright (C) 1996-2003, 2009-2016 Free Software Foundation, Inc.
Copyright (C) 2001-2016 Free Software Foundation, Inc.
Copyright (C) 2001-2005, 2008-2016 Free Software Foundation, Inc.
Copyright (C) 1999-2007, 2009-2016 Free Software Foundation, Inc.
Copyright (C) 1995-2003, 2005-2006, 2008-2014, 2016 Free Software Foundation, Inc.
Copyright (C) 1996-2003, 2005, 2008-2016 Free Software Foundation, Inc.
Copyright (C) 2004 Simon Josefsson
Copyright (c) 2010 Reuben Thomas <rrt@sc3d.org>
Copyright (c) 1999 Richard Henderson <rth@redhat.com>

LICENCE TERMS (cont.)

Copyright (C) 2007 g10 Code GmbH dnl This file is free software
Copyright (C) 2017 g10 Code GmbH dnl This file is free software
Copyright (C) 1996-2001, 2003-2015 Free Software Foundation, Inc. Written by Gordon Matzigkeit, 1996
Copyright (C) 2014 Free Software Foundation, Inc. This is free software
Copyright (C) 2011 Free Software Foundation, Inc. This config.lt script is free software
Copyright (C) 2005-2014 Free Software Foundation, Inc. dnl This file is free software
Copyright (C) 2004-2005, 2007-2009, 2011-2015 Free Software Foundation, Inc. Written by Gary V. Vaughan, 2004
Copyright (C) 2004-2005, 2007-2008, 2011-2015 Free Software Foundation, Inc. Written by Gary V. Vaughan, 2004
Copyright (C) 2004, 2011-2015 Free Software Foundation, Inc. Written by Scott James Remnant, 2004
Copyright (C) 2004-2005, 2007, 2009, 2011-2015 Free Software Foundation, Inc. Written by Scott James Remnant, 2004.
Copyright (C) 2004, 2005 Free Software Foundation, Inc. dnl dnl This file is free software, distributed under the terms of the GNU dnl General Public License. As a special exception to the GNU General dnl Public License, this file may be distributed as part of a program dnl that contains a configur
Copyright (C) 2002-2018 Free Software Foundation, Inc.
Copyright (C) 2001-2018 Free Software Foundation, Inc.
Copyright (C) 1997-2018 Free Software Foundation, Inc.
Copyright (C) 1999-2018 Free Software Foundation, Inc.
Copyright (C) 1996-2018 Free Software Foundation, Inc.
Copyright (C) 2003-2018 Free Software Foundation, Inc.
Copyright (C) 2009-2018 Free Software Foundation, Inc.
Copyright (C) 2006-2018 Free Software Foundation, Inc.
Copyright (C) 2004-2018 Free Software Foundation, Inc.
Copyright (C) 1995-2014, 2016 Free Software Foundation, Inc. dnl This file is free software
Copyright (C) 2000-2002, 2007-2014, 2016 Free Software Foundation, Inc. dnl This file is free software
Copyright (C) 2004-2014, 2016 Free Software Foundation, Inc. dnl This file is free software
Copyright (C) 1996-2003, 2009-2016 Free Software Foundation, Inc. dnl This file is free software
Copyright (C) 2001-2016 Free Software Foundation, Inc. dnl This file is free software
Copyright (C) 2001-2005, 2008-2016 Free Software Foundation, Inc. dnl This file is free software
Copyright (C) 1999-2007, 2009-2016 Free Software Foundation, Inc. dnl This file is free software
Copyright (C) 1995-2003, 2005-2006, 2008-2014, 2016 Free Software dnl Foundation, Inc. dnl This file is free software
Copyright (C) 1996-2003, 2005, 2008-2016 Free Software Foundation, Inc. dnl This file is free software
Copyright (C) 2004 Simon Josefsson
Copyright (c) 2010 Reuben Thomas <rrt@sc3d.org>
Copyright (c) 1999 Richard Henderson <rth@redhat.com>
Copyright (C) 2007 g10 Code GmbH dnl dnl This file is free software
Copyright (C) 2017 g10 Code GmbH dnl dnl This file is free software
Copyright (C) 1996-2001, 2003-2015 Free Software Foundation, Inc. Written by Gordon Matzigkeit, 1996
Copyright (C) 2005-2014 Free Software Foundation, Inc. dnl This file is free software
Copyright (C) 2004-2005, 2007-2009, 2011-2015 Free Software Foundation, Inc. Written by Gary V. Vaughan, 2004
Copyright (C) 2004-2005, 2007-2008, 2011-2015 Free Software Foundation, Inc. Written by Gary V. Vaughan, 2004
Copyright (C) 2004, 2011-2015 Free Software Foundation, Inc. Written by Scott James Remnant, 2004
Copyright (C) 2004-2005, 2007, 2009, 2011-2015 Free Software Foundation, Inc. Written by Scott James Remnant, 2004.
Copyright (C) 2004, 2005 Free Software Foundation, Inc. dnl dnl This file is free software, distributed under the terms of the GNU dnl General Public License. As a special exception to the GNU General dnl Public License, this file may be distributed as part of a program dnl that contains a configur
Copyright (C) 2012 Free Software Foundation, Inc. This configure script is free software
Copyright (C) 2012 Free Software Foundation, Inc. This config.status script is free software
Copyright (C) 2012 Free Software Foundation, Inc. This configure script is free software
Copyright (C) 2012 Free Software Foundation, Inc.
Copyright (C) 2003 g10 Code GmbH
Copyright", "Copyright © 2019 g10 Code GmbH
Copyright (C) 2006 g10 Code GmbH"
Copyright (C) 2003, 2006 g10 Code GmbH
Copyright (C) 2010 g10 Code GmbH"

Copyright (C) 2001, 2002, 2003, 2004, 2007, 2010, 2016 g10 Code GmbH
Copyright (C) 1998-1999, 2001-2006, 2008-2017 Werner Koch
Copyright (C) 2003, 2006, 2007, 2013 g10 Code GmbH
Copyright (C) 1998-2001, 2006-2008, 2012 Free Software Foundation, Inc.
Copyright (C) 2015-2018 g10 Code GmbH
Copyright (C) 1998-2001, 2006-2008, 2012 Free Software Foundation, Inc.
Copyright (C) 2015-2018 g10 Code GmbH
Copyright (C) 1995-1999, 2000-2003 Free Software Foundation, Inc.
Copyright (C) 2019 g10 Code GmbH"
Copyright (C) 2001, 2003, 2004, 2008, 2010, 2011, 2018 g10 Code GmbH
Copyright (C) 2003, 2004, 2014 g10 Code GmbH
copyright@ <funman@videolan.org>
Copyright (C) 2011 Free Software Foundation, Inc.
Copyright@ <funman@videolan.org>
Copyright (C) 2011 Free Software Foundation, Inc.
Copyright 2010 Free Software Foundation, Inc.
Copyright (C) 2004 g10 Code GmbH
Copyright (C) 2008, 2011, 2016 g10 Code GmbH
Copyright (C) 2004, 2006-2012, 2014-2017 g10 Code GmbH
Copyright 2001-2019 g10 Code GmbH"
copyright. COPYRIGHT HOLDER = g10 Code GmbH
Copyright (C) 2001-2019 g10 Code GmbH
Copyright (C) 1995-2017 Free Software Foundation, Inc.
Copyright (C) 1998-2006, 2008-2017 Werner Koch
Copyright (C) 2014 Jedi Lin
Copyright 2003-2007, 2013-2017 g10 Code GmbH
Copyright (C) 1994 X Consortium
Copyright (C) 1996-2015 Free Software Foundation, Inc. This is free software
Copyright (C) 1999-2018 Free Software Foundation, Inc. Written by Tom Tromey <tromey@cygnus.com>.
Copyright 1992-2019 Free Software Foundation, Inc.
Copyright (C) 1999-2018 Free Software Foundation, Inc.
Copyright (C) 2004-2005, 2007, 2009, 2011-2015 Free Software Foundation, Inc. Written by Scott James Remnant, 2004.
Copyright (C) 2004, 2011-2015 Free Software Foundation, Inc. Written by Scott James Remnant, 2004
Copyright (C) 1996-2001, 2003-2015 Free Software Foundation, Inc. Written by Gordon Matzigkeit, 1996
Copyright (C) 2004-2005, 2007-2008, 2011-2015 Free Software Foundation, Inc. Written by Gary V. Vaughan, 2004
Copyright (C) 2004-2005, 2007-2009, 2011-2015 Free Software Foundation, Inc. Written by Gary V. Vaughan, 2004
Copyright (C) 1996-2018 Free Software Foundation, Inc. Originally written by Fran,cois Pinard <pinard@iro.umontreal.ca>, 1996.
Copyright (C) 2011-2018 Free Software Foundation, Inc.
Copyright (C) 1995-1997, 2000-2007, 2009-2010 by Ulrich Drepper <drepper@gnu.ai.mit.edu>
Copyright 1996-2016 Free Software Foundation, Inc. Taken from GNU libtool, 2001 Originally by Gordon Matzigkeit <gord@gnu.ai.mit.edu>, 1996
Copyright (C) 1989, 1991 Free Software Foundation, Inc.,
Copyright (C) 1994-1996, 1999-2002, 2004-2016 Free Software Foundation, Inc.
Copyright (C) 2010-2018 Free Software Foundation, Inc. Written by Peter Rosin <peda@lysator.liu.se>.
Copyright (C) 2003 James Henstridge 2007-2017 Stefan Sauer
Copyright 1985, 1986, 1988, 1990, 1991, 1992, 1993, 1994, 1995, 1996, 1997, 1998, 1999, 2000, 2001, 2002, 2003, 2004, 2005, 2006, 2007, 2008, 2009, 2010, 2011, 2012, 2013, 2014, 2015, 2016, 2017, 2018 Free Software Foundation, Inc.
Copyright (C) 1995-2018 Free Software Foundation, Inc. written by Ulrich Drepper <drepper@gnu.ai.mit.edu>, June 1995
Copyright (C) 2003 James Henstridge 2004-2007 Damon Chaplin 2007-2017 Stefan Sauer
Copyright (C) 2009 Free Software Foundation, Inc.
Copyright (C) 2004-2014 Free Software Foundation, Inc. dnl This file is free software; the Free Software Foundation dnl gives unlimited permission to copy and/or distribute it, dnl with or without modifications, as long as this notice is preserved. dnl dnl This file can can be used in projects which

LICENCE TERMS (cont.)

Copyright (C) 2011-2016 Simon Josefsson See the end for copying conditions.
Copyright (C) 2011-2017 Simon Josefsson See the end for copying conditions.
Copyright (C) 2011-2017 Simon Josefsson
Copyright(c) 2017 Tim Ruehsen
Copyright (C) 2001, 2003, 2006-2019 Free Software Foundation, Inc.
Copyright (C) 1996-2018 Free Software Foundation, Inc.
Copyright (C) 2001-2019 Free Software Foundation, Inc.
Copyright (C) 2011-2019 Simon Josefsson, Tim Ruehsen
Copyright (C) 1994-2018 Free Software Foundation, Inc.
Copyright (C) 1992-1996, 1998-2012 Free Software Foundation, Inc.
Copyright (C) 2008-2019 Free Software Foundation, Inc.
Copyright (C) 2011-2017 Simon Josefsson
Copyright (C) 1989-2019 Free Software Foundation, Inc.
Copyright (C) 2003-2019 Free Software Foundation, Inc.
Copyright (C) 1989-2019 Free Software Foundation, Inc.
Copyright (C) 2011-2019 Free Software Foundation, Inc.
Copyright (C) 2010-2019 Free Software Foundation, Inc.
Copyright (C) 2005-2007, 2009-2019 Free Software Foundation, Inc.
Copyright (C) 1997-2019 Free Software Foundation, Inc. This file is part of the GNU C Library. Contributed by Jean-François Bignolles <bignolle@ecoledoc.ibp.fr>, 1997.
Copyright (C) 1995, 2001-2004, 2006-2019 Free Software Foundation, Inc.
Copyright (C) 2002-2019 Free Software Foundation, Inc.
Copyright (C) 1987-2019 Free Software Foundation, Inc.
Copyright (C) 2000-2001, 2004-2006, 2009-2019 Free Software Foundation, Inc.
Copyright 2016-2019 Free Software Foundation, Inc.
Copyright (C) 2005-2006, 2009-2019 Free Software Foundation, Inc.
Copyright (C) 2001-2019 Free Software Foundation, Inc.
Copyright (C) 1995-1996, 2001-2019 Free Software Foundation, Inc.
Copyright (C) 1990, 1998-2001, 2003-2006, 2009-2019 Free Software Foundation, Inc.
Copyright (C) 2001-2003, 2006-2019 Free Software Foundation, Inc. Written by Bruno Haible <haible@clisp.cons.org>, 2001.
Copyright (C) 1998, 2001, 2003-2006, 2009-2019 Free Software Foundation, Inc.
Copyright (C) 1990, 1998, 2000-2001, 2003-2006, 2009-2019 Free Software Foundation, Inc.
Copyright (C) 2016-2019 Free Software Foundation, Inc.
Copyright (C) 2007-2019 Free Software Foundation, Inc.
Copyright (C) 2004, 2007-2019 Free Software Foundation, Inc.
Copyright (C) 1995-1998, 2000-2002, 2004-2006, 2009-2019 Free Software Foundation, Inc.
Copyright (C) 1994, 1996-1998, 2001, 2003, 2005-2019 Free Software Foundation, Inc.
Copyright (C) 1997-1998, 2006-2007, 2009-2019 Free Software Foundation, Inc.
Copyright (C) 2001-2002, 2004-2019 Free Software Foundation, Inc. Written by Paul Eggert, Bruno Haible, Sam Steingold, Peter Burwood. This file is part of gnuilib.
Copyright (C) 1990, 2001, 2003-2006, 2009-2019 Free Software Foundation, Inc.
Copyright (C) 2001-2004, 2006, 2009-2019 Free Software Foundation, Inc. Written by Bruno Haible <bruno@clisp.org>, 2001.
Copyright (C) 2009-2019 Free Software Foundation, Inc.
Copyright (C) 2003, 2007-2019 Free Software Foundation, Inc.
Copyright (C) 1990-1998, 2000-2007, 2009-2019 Free Software Foundation, Inc. This file is part of the GNU C Library.
Copyright (C) 1999, 2003, 2005, 2009-2019 Free Software Foundation, Inc.
Copyright (C) 2001-2003, 2005-2019 Free Software Foundation, Inc. Written by Bruno Haible <bruno@clisp.org>, 2001.
Copyright (C) 1995-1997, 2003, 2006, 2008-2019 Free Software Foundation, Inc. This file is part of the GNU C Library.
Copyright (C) 1999-2019 Free Software Foundation, Inc.
Copyright (C) 2003, 2006-2007, 2009-2019 Free Software Foundation, Inc. Written by Bruno Haible <bruno@clisp.org>, 2003, 2018.
Copyright (C) 1999-2002, 2006-2007, 2009-2019 Free Software Foundation, Inc. Written by Bruno Haible <bruno@

clisp.org>, 2001.
Copyright (C) 2002, 2006-2007, 2009-2019 Free Software Foundation, Inc. Written by Bruno Haible <bruno@clisp.org>, 2002.
Copyright (C) 2001-2002, 2006-2007, 2009-2019 Free Software Foundation, Inc. Written by Bruno Haible <bruno@clisp.org>, 2001.
Copyright (C) 2002, 2005-2006, 2009-2019 Free Software Foundation, Inc. Written by Bruno Haible <bruno@clisp.org>, 2002.
Copyright (C) 1999, 2002, 2006, 2009-2019 Free Software Foundation, Inc. Written by Bruno Haible <bruno@clisp.org>, 2002.
Copyright (C) 2002, 2006, 2009-2019 Free Software Foundation, Inc. Written by Bruno Haible <bruno@clisp.org>, 2002.
Copyright (C) 1999-2000, 2002, 2006-2007, 2009-2019 Free Software Foundation, Inc. Written by Bruno Haible <bruno@clisp.org>, 2002.
Copyright (C) 1999, 2002, 2006-2007, 2009-2019 Free Software Foundation, Inc. Written by Bruno Haible <bruno@clisp.org>, 2002.
Copyright (C) 1998-1999, 2005-2006, 2009-2019 Free Software Foundation, Inc.
Copyright (C) 1990-2000, 2003-2004, 2006-2019 Free Software Foundation, Inc.
Copyright (C) 2007 Free Software Foundation, Inc.
Copyright (C) 2002-2019 Free Software Foundation, Inc.
Copyright (C) 2001-2002, 2005-2019 Free Software Foundation, Inc.
Copyright (C) 2000-2003, 2009-2019 Free Software Foundation, Inc. This file is part of the GNU CHARSET Library.
Copyright (C) 2007, 2009 Free Software Foundation, Inc.
Copyright (C) 2007, 2009-2019 Free Software Foundation, Inc.
Copyright (C) 2002, 2005-2006, 2009-2019 Free Software Foundation, Inc.
Copyright (C) 2000-2006, 2008-2019 Free Software Foundation, Inc.
Copyright (C) 2002, 2005, 2007-2019 Free Software Foundation, Inc. Written by Bruno Haible.
Copyright (C) 2011-2019 Free Software Foundation, Inc. Written by Bruno Haible <bruno@clisp.org>, 2011.
Copyright (C) 2000-2002, 2005-2007, 2009-2019 Free Software Foundation, Inc. Written by Bruno Haible <bruno@clisp.org>, 2000-2002.
Copyright (C) 2007, 2009-2019 Free Software Foundation, Inc. Written by Bruno Haible <bruno@clisp.org>, 2007.
Copyright (C) 2002, 2006, 2011-2019 Free Software Foundation, Inc. Written by Bruno Haible <bruno@clisp.org>, 2002.
Copyright (C) 2003-2007, 2009-2019 Free Software Foundation, Inc. Written by Bruno Haible <bruno@clisp.org>, 2003.
Copyright (C) 2002, 2005, 2007, 2009-2019 Free Software Foundation, Inc.
Copyright (C) 2002, 2005-2019 Free Software Foundation, Inc.
Copyright (C) 1995, 1999, 2001-2004, 2006-2019 Free Software Foundation, Inc.
Copyright (C) 2009-2019 Free Software Foundation, Inc. Written by Bruno Haible <bruno@clisp.org>, 2009.
Copyright (C) 2002, 2006, 2009, 2011-2019 Free Software Foundation, Inc. Written by Bruno Haible <bruno@clisp.org>, 2009.
Copyright (C) 2001-2003, 2009-2019 Free Software Foundation, Inc. Written by Bruno Haible <bruno@clisp.org>, 2009.
Copyright (C) 2001-2002, 2007, 2009-2019 Free Software Foundation, Inc.
Copyright (C) 1995-1996, 2001, 2003, 2005, 2009-2019 Free Software Foundation, Inc.
Copyright (C) 1999-2001, 2007, 2009-2019 Free Software Foundation, Inc.
Copyright (C) 2002-2004, 2006-2007, 2009-2019 Free Software Foundation, Inc.
Copyright (C) 2003-2004, 2006-2007, 2009-2019 Free Software Foundation, Inc.
Copyright (C) 2010-2019 Free Software Foundation, Inc.
Copyright (C) 2009-2019 Free Software Foundation, Inc.
Copyright (C) 2007-2019 Free Software Foundation, Inc.
Copyright (C) 2003, 2009-2019 Free Software Foundation, Inc.
Copyright (C) 2002, 2004, 2006, 2009-2019 Free Software Foundation, Inc.
Copyright (C) 2001-2007, 2009-2019 Free Software Foundation, Inc. Written by Bruno Haible and Simon Josefsson.
Copyright (C) 2002, 2005, 2007, 2009-2019 Free Software Foundation, Inc. Written by Bruno Haible.
Copyright (C) 2001-2007, 2009-2019 Free Software Foundation, Inc. Written by Bruno Haible.
Copyright (C) 2002, 2006-2007, 2009-2019 Free Software Foundation, Inc.
Copyright (C) 2001-2019 Free Software Foundation, Inc. Written by Bruno Haible and Simon Josefsson.

LICENCE TERMS (cont.)

Copyright (C) 2000-2003, 2006, 2008-2019 Free Software Foundation, Inc.
Copyright (C) 2001-2002, 2009-2019 Free Software Foundation, Inc. Written by Bruno Haible <bruno@clisp.org>, 2009.
Copyright (C) 2004-2019 Free Software Foundation, Inc.
Copyright 2003-2019 Free Software Foundation, Inc.
Copyright 1996-2019 Free Software Foundation, Inc. Taken from GNU libtool, 2001 Originally by Gordon Matzke <gord@gnu.ai.mit.edu>, 1996
Copyright (C) 2006-2019 Free Software Foundation, Inc.
Copyright (C) 1996-1998, 2001-2004, 2009-2019 Free Software Foundation, Inc.
Copyright (C) 2006, 2008-2019 Free Software Foundation, Inc.
Copyright (C) 2008-2019 Free Software Foundation, Inc.
Copyright (c) 2012, 2016 Philip Withnall
Copyright (C) 2002-2003, 2005-2006, 2008-2018 Free Software Foundation, dnl Inc.
Copyright (C) 2006-2019 Free Software Foundation, Inc.
Copyright (C) 2002-2006, 2009-2019 Free Software Foundation, Inc.
Copyright (C) 2003, 2007, 2009-2019 Free Software Foundation, Inc.
Copyright (C) 2003, 2007-2019 Free Software Foundation, Inc.
Copyright (C) 2002-2003, 2008-2019 Free Software Foundation, Inc.
Copyright (C) 2007-2019 Free Software Foundation, Inc.
Copyright (C) 2006, 2009-2019 Free Software Foundation, Inc.
Copyright (C) 2016-2019 Free Software Foundation, Inc.
Copyright (C) 2009-2019 Free Software Foundation, Inc.
Copyright (C) 2002, 2005-2019 Free Software Foundation, Inc.
Copyright 2016-2019 Free Software Foundation, Inc.
Copyright (C) 2005, 2008, 2010-2019 Free Software Foundation, Inc.
Copyright (C) 2001-2003, 2006, 2010-2019 Free Software Foundation, Inc.
Copyright (C) 2012-2019 Free Software Foundation, Inc.
Copyright (C) 2003, 2006-2019 Free Software Foundation, Inc.
Copyright (C) 2005-2019 Free Software Foundation, Inc.
Copyright (C) 2002, 2007-2019 Free Software Foundation, Inc.
Copyright (c) 2008 Paolo Bonzini <bonzini@gnu.org>
Copyright (C) 2004, 2006, 2008-2019 Free Software Foundation, Inc.
Copyright (C) 2002-2006, 2008-2019 Free Software Foundation, Inc.
Copyright (C) 2001-2019 Free Software Foundation, Inc.
Copyright (C) 2007, 2009-2019 Free Software Foundation, Inc.
Copyright (C) 1999-2007, 2009-2019 Free Software Foundation, Inc.
Copyright (C) 2005, 2009-2019 Free Software Foundation, Inc.
Copyright (C) 2011-2019 Free Software Foundation, Inc.
Copyright (C) 2000-2002, 2006, 2008-2014 Free Software Foundation, Inc.
Copyright (C) 2005-2007, 2009-2019 Free Software Foundation, Inc.
Copyright 2012-2019 Free Software Foundation, Inc.
Copyright (C) 1998-2003, 2005-2007, 2009-2019 Free Software Foundation, dnl Inc.
Copyright (C) 2016-2017 Tim Rühse
Copyright (c) 1991-2013 Unicode, Inc.
Copyright (C) 2016-2017 Tim Rühse
Copyright (c) 1991-2013 Unicode, Inc. For terms of use, see http://www.unicode.org/terms_of_use.
Copyright (C) 2011-2016 Simon Josefsson
Copyright (C) 2016 Tim Rühse
Copyright (C) 2007 Free Software Foundation, Inc. <<http://fsf.org/>>
Copyright (C) 2003 Free Software Foundation, Inc.
Copyright (C) 2012 Free Software Foundation, Inc.
Copyright (C) 2008 Free Software Foundation, Inc. Meng Jie <zuxyhere@eastday.com>, 2005. Ji ZhengYu <zhenyuyj@gmail.com>, 2011, 2012
Copyright © 2016, 2018, 2019 Free Software Foundation, Inc. Josef Andersson <josef.andersson@fripost.org>, 2016. Sebastian Rasmussen <sebras@gmail.com>, 2018, 2019.
Copyright (C) 2019 Free Software Foundation, Inc. Joe Hansen <joedalton2@yahoo.dk>, 2015, 2017, 2019.
Copyright (C) 2011 Free Software Foundation, Inc.

Copyright (C) 2019 Free Software Foundation, Inc.
Copyright (C) 2004, 2007, 2008 Free Software Foundation, Inc. Marco Colombo <m.colombo@ed.ac.uk>, 2004, 2007, 2008, 2011.
Copyright © 2014 Free Software Foundation, Inc. Clytie Siddall <clytie@riverland.net.au>, 2005-2008. Trần Ngọc Quân <vnwildman@gmail.com>, 2012-2014.
Copyright (C) 2008 Free Software Foundation, Inc. Andhika Padmawan <andhika.padmawan@gmail.com>, 2008-2012.
Copyright (C) 2004, 2007, 2008, 2011, 2017, 2019 Free Software Foundation, Inc. Jakub Bogusz <qboosh@pld-linux.org>, 2004-2019.
Copyright © 2008, 2009, 2011 Free Software Foundation, Inc.
Copyright (C) 2007 Free Software Foundation, Inc. Petr Písař <petr.pisar@atlas.cz>, 2007, 2008, 2011, 2017, 2019.
Copyright (C) 20118 Free Software Foundation, Inc. Francisco Javier Serrador <fserrador@gmail.com>, 2018
Copyright (C) 2004 Free Software Foundation, Inc. Roland Illig <roland.illig@gmx.de>, 2004, 2009, 2011. Mario Blättermann <mario.blaettermann@gmail.com>, 2019.
Copyright (C) 2018 Free Software Foundation, Inc. Fabio Tomat <f.t.public@gmail.com>, 2018.
Copyright (C) 2012 Free Software Foundation, Inc. Aleksandar Jelenak <jelenak@verizon.net>, 2004, 2005.
Copyright (C) 2014 Free Software Foundation, Inc.
Copyright (C) 2006 Free Software Foundation, Inc. GOTO Masanori <gotom@debian.or.jp>, 2006.
Copyright © 1996 Free Software Foundation, Inc. Marc Veillet <scouigne@gmail.com>, 2008.
Copyright (C) YEAR Free Software Foundation, Inc.
Copyright (C) 2019 Free Software Foundation, Inc.
Copyright c 2011-2017 Simon Josefsson
Copyright @copyright{} 2011-2017 Simon Josefsson end copying
Copyright © 2011-2017 Simon Josefsson
Copyright (C) 2011-2017 Simon Josefsson
Copyright (C) 2002-2017 Simon Josefsson
Copyright (c) 2002-2017 Simon Josefsson
Copyright (C) 2002-2017 Simon Josefsson
Copyright (C) 2017 Tim Rühse;(C) Chinese (traditional)
Copyright (C) 2019 Red Hat, Inc.
Copyright (c) 1991-2013 Unicode, Inc.
Copyright (C) 1994-2018 Free Software Foundation, Inc.
Copyright(c) 2019 Tim Rühse
Copyright (C) 2004-2015 Free Software Foundation, Inc.
Copyright (C) 2010-2015 Free Software Foundation, Inc.
Copyright 1992-2019 Free Software Foundation, Inc.
Copyright (C) 2014 Free Software Foundation, Inc.
Copyright (C) 2011 Free Software Foundation, Inc.
Copyright (C) 2002-2018 Free Software Foundation, Inc.
Copyright (C) 2011-2018 Free Software Foundation, Inc.
Copyright (C) 2001-2018 Free Software Foundation, Inc.
Copyright (C) 1997-2018 Free Software Foundation, Inc.
Copyright (C) 1999-2018 Free Software Foundation, Inc.
Copyright (C) 1996-2018 Free Software Foundation, Inc.
Copyright (C) 2003-2018 Free Software Foundation, Inc.
Copyright (C) 2009-2018 Free Software Foundation, Inc.
Copyright (C) 2006-2018 Free Software Foundation, Inc.
Copyright (C) 2004-2018 Free Software Foundation, Inc.
Copyright (C) 1995-2014, 2016 Free Software Foundation, Inc.
Copyright (C) 2000-2002, 2007-2014, 2016 Free Software Foundation, Inc.
Copyright (C) 1996-2003, 2009-2016 Free Software Foundation, Inc.
Copyright (C) 2001-2016 Free Software Foundation, Inc.
Copyright (C) 2001-2005, 2008-2016 Free Software Foundation, Inc.
Copyright (C) 1995-2003, 2005-2006, 2008-2014, 2016 Free Software dnl Foundation, Inc.
Copyright © 2004 Scott James Remnant <scott@netsplit.com>.
Copyright © 2012-2015 Dan Nicholson <dbn.lists@gmail.com>
Copyright (C) 1996-2003, 2005, 2008-2016 Free Software Foundation, Inc.

LICENCE TERMS (cont.)

Copyright (C) 2001-2003, 2006, 2010-2019 Free Software Foundation, Inc. dnl This file is free software
Copyright (C) 2001-2019 Free Software Foundation, Inc. dnl This file is free software
Copyright (C) 2003, 2007, 2009-2019 Free Software Foundation, Inc.
Copyright (C) 2002, 2007-2019 Free Software Foundation, Inc.
Copyright (C) 2007-2019 Free Software Foundation, Inc.
Copyright (C) 2002, 2005-2019 Free Software Foundation, Inc.
Copyright (C) 2005-2019 Free Software Foundation, Inc.
Copyright (C) 2005, 2008, 2010-2019 Free Software Foundation, Inc.
Copyright (C) 2010-2019 Free Software Foundation, Inc.
Copyright (C) 2002-2003, 2008-2019 Free Software Foundation, Inc.
Copyright 2011-%s %d Simon Josefsson, Tim Ruehsen."
Copyright 2011-%s %d Simon Josefsson, Tim Ruehsen."
Copyright (C) 2011-2017 Simon Josefsson
Copyright (C) 2012 Free Software Foundation, Inc.
Copyright (C) 2012 Free Software Foundation, Inc.
Copyright (C) 2018-2019 Tim Ruehsen See the end for copying conditions.
Copyright (C) 2002-2019 Free Software Foundation, Inc.
Copyright @copyright{} 1990-2005, 2007-2009 Free Software Foundation, Inc.
Copyright (C) 1990-2005, 2007-2009 Free Software Foundation, Inc.
copyright 90,2005,2007-2009 Free Software Foundation, Inc.
Copyright (C) 2009-2019 Free Software Foundation, Inc.
Copyright @copyright{} 1990-2005, 2007-2009 Free Software Foundation, Inc.
Copyright (C) 1990-2005, 2007-2009 Free Software Foundation, Inc.
COPYRIGHT 90,2005,2007-2009 Free Software Foundation, Inc.
Copyright (C) 2009-2019 Free Software Foundation, Inc.
Copyright @copyright{} 1990-2005, 2007-2009 Free Software Foundation, Inc.
Copyright (C) 1990-2005, 2007-2009 Free Software Foundation, Inc.
Copyright 90,2005,2007-2009 Free Software Foundation, Inc.
Copyright 2019 Free Software Foundation, Inc. T
Copyright © 1991-2016 Unicode, Inc. All rights reserved.
Copyright © 1991-2016 Unicode, Inc. All rights reserved.
Copyright © 1991-2016 Unicode, Inc. All rights reserved.
Copyright © 1991-2016 Unicode, Inc. All rights reserved.
Copyright (C) 2011-2016 Simon Josefsson"
Copyright (C) 2011-2016 Simon Josefsson"
Copyright © 2007 Simon Josefsson This file is distributed under the same license as the libidn package. Jorma
Karvonen <karvjorm@users.sf.net>, 2008. Jorma Karvonen <karvonen.jorma@gmail.com>, 2009-2011.
Copyright (C) 2019 Simon Josefsson. Rafael Fontenelle <rafaelff@gnome.org>, 2014, 2017, 2019.
Copyright (C) 2003 James Henstridge 2004-2007 Damon Chaplin 2007-2017 Stefan Sauer
Copyright (C) 2011-2017 Simon Josefsson
Copyright (C) 2002-2017 Simon Josefsson
Copyright © 2011-2017 Simon Josefsson
Copyright 2011-2017 Simon Josefsson
Copyright (c) 2001, 2002 Nikos Mavrogiannopoulos added -tex
Copyright (c) 1998 Michael Zucchi
Copyright (c) 2013 Adam Sampson made highlighting not depend on hash order, for Perl 5.18
Copyright (c) 2001, 2002 Nikos Mavrogiannopoulos added -tex
Copyright (c) 1998 Michael Zucchi
Copyright (c) 2013 Adam Sampson made highlighting not depend on hash order, for Perl 5.18
Copyright (c) 2001, 2002 Nikos Mavrogiannopoulos added -tex
Copyright (c) 1998 Michael Zucchi
Copyright (c) 2013 Adam Sampson made highlighting not depend on hash order, for Perl 5.18
Copyright (C) 1989, 1991 Free Software Foundation, Inc. 51 Franklin St, Fifth Floor, Boston, MA 02110-1301 USA
Everyone is permitted to copy and distribute verbatim copies of this license document, but changing it is not
allowed.;copyright the software, and 2) offer you this license which gives you legal permission to copy, distribute and/
or modify the software.;copyright law: that is to say, a work containing the Program or a portion of it, either verbatim
or with modifications and/or translated into another language. (Hereinafter, translation is included without limitation in

the term "modification".) Each licensee is addressed as "you".;copyrighted interfaces, the;copyrighted by the Free
Software Foundation, write to the Free Software Foundation; we sometimes make exceptions for this. Our decision
will be guided by the two goals of preserving the free status of all derivatives of our free software and of promoting
the sharing and reuse of software generally.;copyright" line and a pointer to where the full notice is found.;Copyright
(C) <year> <name of author>;Copyright (C) year name of author Gnomovision comes with ABSOLUTELY NO
WARRANTY; for details type `show w'. This is free software, and you are welcome to redistribute it under certain
conditions; type `show c' for details.;copyright disclaimer" for the program, if necessary. Here is a sample; alter the
names.;copyright interest in the program Gnomovision' (which makes passes at compilers) written by James Hacker.
Copyright (c) 2006, 2008 Junio C Hamano
copyright notice, this list of conditions and the following disclaimer.
Copyright (C) 2017 - 2018, Stephan Mueller <smueller@chronox.de>
Copyright Stephan Mueller <smueller@chronox.de>, 2014
Copyright Stephan Mueller <smueller@chronox.de>, 2014 - 2018
Copyright (c) 2013 by Stephan Mueller (smueller@chronox.de)
Copyright Stephan Mueller <smueller@chronox.de>, 2013
Copyright (C) 2009 The Android Open Source Project
Copyright (C) 1994 X Consortium
Copyright (C) 1996-2015 Free Software Foundation, Inc.
Copyright (C) 1999-2018 Free Software Foundation, Inc. Written by Tom Tromey <tromey@cygnus.com>.

Copyright 1992-2019 Free Software Foundation, Inc.
Copyright (C) 1999-2018 Free Software Foundation, Inc.
Copyright (C) 2004-2005, 2007, 2009, 2011-2015 Free Software Foundation, Inc. Written by Scott James Remnant,
2004.
Copyright (C) 2004, 2011-2015 Free Software Foundation, Inc. Written by Scott James Remnant, 2004
Copyright (C) 1996-2001, 2003-2015 Free Software Foundation, Inc. Written by Gordon Matzigkeit, 1996
Copyright (C) 2004-2005, 2007-2008, 2011-2015 Free Software Foundation, Inc. Written by Gary V. Vaughan, 2004
Copyright (C) 2004-2005, 2007-2009, 2011-2015 Free Software Foundation, Inc. Written by Gary V. Vaughan, 2004
Copyright (C) 1996-2018 Free Software Foundation, Inc. Originally written by Fran,cois Pinard <pinard@iro.
umontreal.ca>, 1996.
Copyright (C) 1995-1997, 2000-2007, 2009-2010 by Ulrich Drepper <drepper@gnu.ai.mit.edu>
Copyright 1996-2016 Free Software Foundation, Inc. Taken from GNU libtool, 2001 Originally by Gordon Matzigkeit
<gord@gnu.ai.mit.edu>, 1996
Copyright (C) 1989, 1991 Free Software Foundation, Inc.
Copyright (C) 2007 Free Software Foundation, Inc.
Copyright (C) 2005, 2008, 2010-2014 Free Software Foundation, Inc.
Copyright (C) 1991, 1999 Free Software Foundation, Inc.
Copyright (C) 1994-2018 Free Software Foundation, Inc.
Copyright (C) 1996-2018 Free Software Foundation, Inc.
Copyright (C) 2006 Timo Lindfors
Copyright (C) 1992-1996, 1998-2012 Free Software Foundation, Inc.
Copyright (C) 2001, 2002, 2007 Free Software Foundation
Copyright (C) 1998, 2002, 2006, 2007 Free Software Foundation
Copyright (C) 1998, 2001, 2002, 2006, 2007 Free Software Foundation
Copyright (C) 1998, 2002, 2006, 2007 Free Software Foundation
Copyright 1996-2014 Free Software Foundation, Inc.2001 Originally by Gordon Matzigkeit <gord@gnu.ai.mit.edu>,
1996
Copyright (C) 1994, 1995, 1996, 1999, 2000, 2001, 2002, 2004, 2005, 2006, 2007, 2008, 2009, 2010 Free Software
Foundation, Inc.
Copyright (C) 2007-2008 Free Software Foundation, Inc.
Copyright (c) 2008 Steven G. Johnson <stevenj@alum.mit.edu>
Copyright (C) 2004-2014 Free Software Foundation, Inc.
Copyright (C) 2002-2006, 2008 Free Software Foundation, Inc.
Copyright (c) 2014 Google Inc.
Copyright (C) 1989-1994,1996-1999,2001,2003,2004,2005,2006,2007 Free Software Foundation, Inc.
Copyright (C) 2004-2007 Free Software Foundation, Inc.
Copyright (C) 1987,88,89,90,91,92,93,94,96,97,98,2004,2006 Free Software Foundation, Inc.

LICENCE TERMS (cont.)

Copyright (C) 1987,88,89,90,91,92,93,94,95,96,98,99,2000,2001,2002,2003,2004,2006 Free Software Foundation, Inc.
Copyright (C) 1989-1994,1996-1999,2001,2003,2004 Free Software Foundation, Inc.
© Vadla Ravnås for the patch and testing.
Copyright (C) 1997-2007 by Dimitri van Heesch
Copyright (C) 2004-2015 Free Software Foundation, Inc.
Copyright (C) 2010-2015 Free Software Foundation, Inc.
Copyright 1992-2019 Free Software Foundation, Inc.
Copyright (C) 2014 Free Software Foundation, Inc.
Copyright (C) 2011 Free Software Foundation, Inc.
Copyright (C) 2002-2018 Free Software Foundation, Inc.
Copyright (C) 2001-2018 Free Software Foundation, Inc.
Copyright (C) 1997-2018 Free Software Foundation, Inc.
Copyright (C) 1999-2018 Free Software Foundation, Inc.
Copyright (C) 1996-2018 Free Software Foundation, Inc.
Copyright (C) 2003-2018 Free Software Foundation, Inc.
Copyright (C) 2009-2018 Free Software Foundation, Inc.
Copyright (C) 2006-2018 Free Software Foundation, Inc.
Copyright (C) 2004-2018 Free Software Foundation, Inc.
Copyright (C) 1995-2014, 2016 Free Software Foundation, Inc.
Copyright (C) 2000-2002, 2007-2014, 2016 Free Software Foundation, Inc.
Copyright (C) 1996-2003, 2009-2016 Free Software Foundation, Inc.
Copyright (C) 2001-2016 Free Software Foundation, Inc.
Copyright (C) 2001-2005, 2008-2016 Free Software Foundation, Inc.
Copyright (C) 1995-2003, 2005-2006, 2008-2014, 2016 Free Software dnl Foundation, Inc.
Copyright (C) 1996-2003, 2005, 2008-2016 Free Software Foundation, Inc.
Copyright (c) 2014 Google Inc.
Copyright (c) 2015 Lasse Collin <lasse.collin@tukaani.org>
Copyright (c) 2008 Steven G. Johnson <stevenj@alum.mit.edu>
Copyright (c) 2011 Daniel Richard G. <skunk@iSKUNK.ORG>
Copyright (C) 2002-2006, 2008 Free Software Foundation, Inc.
Copyright (C) 2004-2014 Free Software Foundation, Inc.
Copyright (C) 1996-2001, 2003-2015 Free Software Foundation, Inc. Written by Gordon Matzigkeit, 1996
Copyright (C) 2014 Free Software Foundation, Inc.
Copyright (C) 2011 Free Software Foundation, Inc.
Copyright (C) 2004-2005, 2007-2009, 2011-2015 Free Software Foundation, Inc. Written by Gary V. Vaughan, 2004
Copyright (C) 2004-2005, 2007-2008, 2011-2015 Free Software Foundation, Inc. Written by Gary V. Vaughan, 2004
Copyright (C) 2004, 2011-2015 Free Software Foundation, Inc. Written by Scott James Remnant, 2004
Copyright (C) 2004-2005, 2007, 2009, 2011-2015 Free Software Foundation, Inc. Written by Scott James Remnant, 2004.
Copyright (C) 2007-2008 Free Software Foundation, Inc.
Copyright (C) 2005, 2008, 2010-2014 Free Software Foundation, Inc.
Copyright (C) 2002-2018 Free Software Foundation, Inc.
Copyright (C) 2001-2018 Free Software Foundation, Inc.
Copyright (C) 1997-2018 Free Software Foundation, Inc.
Copyright (C) 1999-2018 Free Software Foundation, Inc.
Copyright (C) 1996-2018 Free Software Foundation, Inc.
Copyright (C) 2003-2018 Free Software Foundation, Inc.
Copyright (C) 2009-2018 Free Software Foundation, Inc.
Copyright (C) 2006-2018 Free Software Foundation, Inc.
Copyright (C) 2004-2018 Free Software Foundation, Inc.
Copyright (C) 1995-2014, 2016 Free Software Foundation, Inc.
Copyright (C) 2000-2002, 2007-2014, 2016 Free Software Foundation, Inc.
Copyright (C) 1996-2003, 2009-2016 Free Software Foundation, Inc.
Copyright (C) 2001-2016 Free Software Foundation, Inc.
Copyright (C) 2001-2005, 2008-2016 Free Software Foundation, Inc.
Copyright (C) 1995-2003, 2005-2006, 2008-2014, 2016 Free Software dnl Foundation, Inc.

Copyright (C) 1996-2003, 2005, 2008-2016 Free Software Foundation, Inc.
Copyright (c) 2014 Google Inc.
Copyright (c) 2015 Lasse Collin <lasse.collin@tukaani.org>
Copyright (c) 2008 Steven G. Johnson <stevenj@alum.mit.edu>
Copyright (c) 2011 Daniel Richard G. <skunk@iSKUNK.ORG>
Copyright (C) 2004-2014 Free Software Foundation, Inc.
Copyright (C) 1996-2001, 2003-2015 Free Software Foundation, Inc. Written by Gordon Matzigkeit, 1996
Copyright (C) 2004-2005, 2007-2009, 2011-2015 Free Software Foundation, Inc. Written by Gary V. Vaughan, 2004
Copyright (C) 2004-2005, 2007-2008, 2011-2015 Free Software Foundation, Inc. Written by Gary V. Vaughan, 2004
Copyright (C) 2004, 2011-2015 Free Software Foundation, Inc. Written by Scott James Remnant, 2004
Copyright (C) 2004-2005, 2007, 2009, 2011-2015 Free Software Foundation, Inc. Written by Scott James Remnant, 2004.
Copyright (C) 2007-2008 Free Software Foundation, Inc.
Copyright (C) 2005, 2008, 2010-2014 Free Software Foundation, Inc.
Copyright (C) 2005 Philipp Benner.
Copyright (C) Michael D. Brennan
Copyright (C) 1998, 1999, 2001 Henry Spencer.
Copyright (C) 2005 Philipp Benner.
Copyright (C) Michael D. Brennan
Copyright (C) 1998, 1999, 2001 Henry Spencer.
Copyright (C) 2012 Free Software Foundation, Inc.
Copyright (C) 2012 Free Software Foundation, Inc.
Copyright (C) 1992, 1993 Jean-loup Gailly
Copyright (C) 1993 Jean-loup Gailly
copyright© Vadla Ravnås.
Copyright (C) 1994 X Consortium
Copyright (C) 1996-2015 Free Software Foundation, Inc.
Copyright (C) 1999-2018 Free Software Foundation, Inc. Written by Tom Tromey <tromey@cygnus.com>.
Copyright 1992-2019 Free Software Foundation, Inc.
Copyright (C) 1999-2018 Free Software Foundation, Inc.
Copyright (C) 2004-2005, 2007, 2009, 2011-2015 Free Software Foundation, Inc. Written by Scott James Remnant, 2004.
Copyright (C) 2004, 2011-2015 Free Software Foundation, Inc. Written by Scott James Remnant, 2004
Copyright (C) 1996-2001, 2003-2015 Free Software Foundation, Inc. Written by Gordon Matzigkeit, 1996
Copyright (C) 2004-2005, 2007-2008, 2011-2015 Free Software Foundation, Inc. Written by Gary V. Vaughan, 2004
Copyright (C) 2004-2005, 2007-2009, 2011-2015 Free Software Foundation, Inc. Written by Gary V. Vaughan, 2004
Copyright (C) 1996-2018 Free Software Foundation, Inc. Originally written by Fran.cois Pinard <pinard@iro.umontreal.ca>, 1996.
Copyright (C) 1991, 1999 Free Software Foundation, Inc.
Copyright (C) 1994-2018 Free Software Foundation, Inc.
Copyright (C) 1996-2018 Free Software Foundation, Inc.
Copyright (C) 1992-1996, 1998-2012 Free Software Foundation, Inc.
(C) 2008-2012 by Pablo Neira Ayuso <pablo@netfilter.org>
Copyright (C) 2011 Free Software Foundation, Inc.
(C) 2008-2010 by Pablo Neira Ayuso <pablo@netfilter.org>
Copyright (C) 2004-2015 Free Software Foundation, Inc. This is free software
Copyright (C) 2010-2015 Free Software Foundation, Inc. This is free software
Copyright 1992-2019 Free Software Foundation, Inc.
Copyright (C) 2014 Free Software Foundation, Inc.
Copyright (C) 2011 Free Software Foundation, Inc.
Copyright (C) 2002-2018 Free Software Foundation, Inc.
Copyright (C) 2001-2018 Free Software Foundation, Inc.
Copyright (C) 1997-2018 Free Software Foundation, Inc.
Copyright (C) 1999-2018 Free Software Foundation, Inc.
Copyright (C) 1996-2018 Free Software Foundation, Inc.
Copyright (C) 2003-2018 Free Software Foundation, Inc.
Copyright (C) 2009-2018 Free Software Foundation, Inc.

LICENCE TERMS (cont.)

Copyright (C) 2006-2018 Free Software Foundation, Inc.
Copyright (C) 2004-2018 Free Software Foundation, Inc.
Copyright (C) 1996-2001, 2003-2015 Free Software Foundation, Inc. Written by Gordon Matzigkeit, 1996
Copyright (C) 2004-2005, 2007-2009, 2011-2015 Free Software Foundation, Inc. Written by Gary V. Vaughan, 2004
Copyright (C) 2004-2005, 2007-2008, 2011-2015 Free Software Foundation, Inc. Written by Gary V. Vaughan, 2004
Copyright (C) 2004, 2011-2015 Free Software Foundation, Inc. Written by Scott James Remnant, 2004
Copyright (C) 2004-2005, 2007, 2009, 2011-2015 Free Software Foundation, Inc. Written by Scott James Remnant, 2004.
Copyright (C) 2012 Free Software Foundation, Inc.
Copyright (C) 1994 X Consortium
Copyright (C) 1996-2015 Free Software Foundation, Inc.
Copyright (C) 1999-2018 Free Software Foundation, Inc. Written by Tom Tromey <tromey@cygnus.com>.
Copyright 1992-2019 Free Software Foundation, Inc.
Copyright (C) 1999-2018 Free Software Foundation, Inc.
Copyright (C) 2004-2005, 2007, 2009, 2011-2015 Free Software Foundation, Inc. Written by Scott James Remnant, 2004.
Copyright (C) 2004, 2011-2015 Free Software Foundation, Inc. Written by Scott James Remnant, 2004
Copyright (C) 1996-2001, 2003-2015 Free Software Foundation, Inc. Written by Gordon Matzigkeit, 1996
Copyright (C) 2004-2005, 2007-2008, 2011-2015 Free Software Foundation, Inc. Written by Gary V. Vaughan, 2004
Copyright (C) 2004-2005, 2007-2009, 2011-2015 Free Software Foundation, Inc. Written by Gary V. Vaughan, 2004
Copyright (C) 1996-2018 Free Software Foundation, Inc. Originally written by Fran.cois Pinard <pinard@iro.umontreal.ca>, 1996.
Copyright (C) 2011-2018 Free Software Foundation, Inc.
Copyright (c) 2006, 2008 Junio C Hamano
Copyright (C) 2010-2018 Free Software Foundation, Inc. Written by Peter Rosin <peda@lysator.liu.se>.
(C) 2013 by Ana Rey Botello <anarey@gmail.com>
Copyright (C) 1989, 1991 Free Software Foundation, Inc.
(C) 2016 by Pablo Neira Ayuso <pablo@netfilter.org>
Copyright (C) 1996-2018 Free Software Foundation, Inc.
Copyright (C) 1992-1996, 1998-2012 Free Software Foundation, Inc.
Copyright (C) 2011 Free Software Foundation, Inc.
(C) 2013 by Eric Leblond <eric@regit.org>
Copyright (C) 1994-2018 Free Software Foundation, Inc.
(C) 2016 by Laura Garcia <nevola@gmail.com>
(C) 2012 by Pablo Neira Ayuso <pablo@netfilter.org>
(C) 2019 by Stéphane Veyret <sveyret@gmail.com>
(C) 2013 by Pablo Neira Ayuso <pablo@netfilter.org>
(C) 2012-2014 by Pablo Neira Ayuso <pablo@netfilter.org>
(C) 2012-2016 by Pablo Neira Ayuso <pablo@netfilter.org>;(C) 2016 by Carlos Falgueras García <carlosfg@riseup.net>
(C) 2012-2013 by Pablo Neira Ayuso <pablo@netfilter.org>;(C) 2013 by Arturo Borrero Gonzalez <arturo@debian.org>;(C) 2013 by Alvaro Neira Ayuso <alvaroneay@gmail.com>
(C) 2015 Pablo Neira Ayuso <pablo@netfilter.org>
(C) 2012-2016 by Pablo Neira Ayuso <pablo@netfilter.org>
(C) 2012-2013 by Pablo Neira Ayuso <pablo@netfilter.org>
Copyright (c) 2013 Arturo Borrero Gonzalez <arturo@debian.org>
(C) 2018 by Pablo Neira Ayuso <pablo@netfilter.org>
(C) 2016 Red Hat GmbH Author: Florian Westphal <fw@strlen.de>
Copyright (c) 2018 Máté Eckl <ecklm94@gmail.com>
(C) 2014 by Arturo Borrero Gonzalez <arturo@debian.org>
Copyright (c) 2016 Anders K. Pedersen <akp@cohaesio.com>
Copyright (c) 2014, 2015 Patrick McHardy <kaber@trash.net>
(C) 2012-2014 Pablo Neira Ayuso <pablo@netfilter.org>;(C) 2012 Intel Corporation
(C) 2012-2013 by Pablo Neira Ayuso <pablo@netfilter.org>;(C) 2013 by Arturo Borrero Gonzalez <arturo@debian.org>
Copyright (c) 2013-2015 Pablo Neira Ayuso <pablo@netfilter.org>
(C) 2018 by Harsha Sharma <harshasharmaitr@gmail.com>

Copyright (c) 2017 Pablo M. Bermudo Garay <pablombg@gmail.com>
(C) 2017 Red Hat GmbH Author: Florian Westphal <fw@strlen.de>
(C) 2015 Red Hat GmbH Author: Florian Westphal <fw@strlen.de>
Copyright (C) 2004-2015 Free Software Foundation, Inc.
Copyright (C) 2010-2015 Free Software Foundation, Inc.
Copyright 1992-2019 Free Software Foundation, Inc.
Copyright (C) 2014 Free Software Foundation, Inc.
Copyright (C) 2011 Free Software Foundation, Inc. This config.lt script is free software
Copyright (C) 2002-2018 Free Software Foundation, Inc.
Copyright (C) 2011-2018 Free Software Foundation, Inc.
Copyright (C) 2001-2018 Free Software Foundation, Inc.
Copyright (C) 1997-2018 Free Software Foundation, Inc.
Copyright (C) 1999-2018 Free Software Foundation, Inc.
Copyright (C) 1996-2018 Free Software Foundation, Inc.
Copyright (C) 2003-2018 Free Software Foundation, Inc.
Copyright (C) 2009-2018 Free Software Foundation, Inc.
Copyright (C) 2006-2018 Free Software Foundation, Inc.
Copyright (C) 2004-2018 Free Software Foundation, Inc.
Copyright © 2004 Scott James Remnant <scott@netsplit.com>.
Copyright © 2012-2015 Dan Nicholson <dbn.lists@gmail.com>
Copyright (C) 1996-2001, 2003-2015 Free Software Foundation, Inc. Written by Gordon Matzigkeit, 1996
Copyright (C) 2004-2005, 2007-2009, 2011-2015 Free Software Foundation, Inc. Written by Gary V. Vaughan, 2004
Copyright (C) 2004-2005, 2007-2008, 2011-2015 Free Software Foundation, Inc. Written by Gary V. Vaughan, 2004
Copyright (C) 2004, 2011-2015 Free Software Foundation, Inc. Written by Scott James Remnant, 2004
Copyright (C) 2004-2005, 2007, 2009, 2011-2015 Free Software Foundation, Inc. Written by Scott James Remnant, 2004.
Copyright (C) 2012 Free Software Foundation, Inc. This configure script is free software
Copyright (C) 2012 Free Software Foundation, Inc. This config.status script is free software
Copyright (c) 2013 Pablo Neira Ayuso <pablo@netfilter.org>
Copyright (C) 1994 X Consortium
Copyright (C) 1996-2015 Free Software Foundation, Inc.
Copyright (C) 1999-2018 Free Software Foundation, Inc. Written by Tom Tromey <tromey@cygnus.com>.
Copyright 1992-2019 Free Software Foundation, Inc.
Copyright (C) 1999-2018 Free Software Foundation, Inc.
Copyright (C) 2004-2005, 2007, 2009, 2011-2015 Free Software Foundation, Inc. Written by Scott James Remnant, 2004.
Copyright (C) 2004, 2011-2015 Free Software Foundation, Inc. Written by Scott James Remnant, 2004
Copyright (C) 1996-2001, 2003-2015 Free Software Foundation, Inc. Written by Gordon Matzigkeit, 1996
Copyright (C) 2004-2005, 2007-2008, 2011-2015 Free Software Foundation, Inc. Written by Gary V. Vaughan, 2004
Copyright (C) 2004-2005, 2007-2009, 2011-2015 Free Software Foundation, Inc. Written by Gary V. Vaughan, 2004
Copyright (C) 1996-2018 Free Software Foundation, Inc. Originally written by Fran.cois Pinard <pinard@iro.umontreal.ca>, 1996.
Copyright (C) 2011-2018 Free Software Foundation, Inc.
Copyright (C) 2010-2018 Free Software Foundation, Inc. Written by Peter Rosin <peda@lysator.liu.se>.
Copyright (C) 1991, 1999 Free Software Foundation, Inc.
Copyright (c) 2003-2006 Thomas Graf <tgraf@suug.ch>
Copyright (c) 2003-2008 Thomas Graf <tgraf@suug.ch>
Copyright (C) 1996-2018 Free Software Foundation, Inc.
Copyright (c) 2011 Thomas Graf <tgraf@suug.ch>
Copyright (c) 2016 Sushma Sitarum <sushma.sitarum@intel.com>
Copyright (c) 2015 Cong Wang <xiyou.wangcong@gmail.com>
Copyright (c) 2013 Cong Wang <xiyou.wangcong@gmail.com>
Copyright (c) 2018 Volodymyr Bendiuga <volodymyr.bendiuga@gmail.com>
Copyright (c) 2017 David Ahern <dsa@cumulusnetworks.com>
Copyright (c) 2010 Thomas Graf <tgraf@suug.ch>
Copyright (c) 2003-2011 Thomas Graf <tgraf@suug.ch>
Copyright (c) 2013 Thomas Graf <tgraf@suug.ch>

LICENCE TERMS (cont.)

Copyright (c) 2003-2010 Thomas Graf <tgraf@suug.ch>
copyright ©2011, Thomas Graf
Copyright (c) 2019 Eyal Birger <eyal.birger@gmail.com>
Copyright (c) 2016 Sabrina Dubroca <sd@queasysnail.net>
Copyright (C) 1992-1996, 1998-2012 Free Software Foundation, Inc.
Copyright (c) 2014 Susant Sahani <susant@redhat.com>
Copyright (C) 2011 Free Software Foundation, Inc.
Copyright (c) 2012 Benedikt Spranger <b.spranger@linutronix.de>
Copyright (c) 2015 Beniamino Galvani <bgalvani@redhat.com>
Copyright (c) 2013 Michael Braun <michael-dev@fami-braun.de>
Copyright (c) 2011-2013 Thomas Graf <tgraf@suug.ch>
Copyright (c) 2015 Cumulus Networks. All rights reserved.
Copyright (c) 2016 Jonas Johansson <jonasj76@gmail.com>
Copyright (C) 1994-2018 Free Software Foundation, Inc.
Copyright (c) 2014 Dan Williams <dcbw@redhat.com>
Copyright (c) 2003-2012 Thomas Graf <tgraf@suug.ch>
Copyright (c) 2013 Yasunobu Chiba <yasu@dsl.gr.jp>
Copyright (c) 2016 Intel Corp. All rights reserved.
Copyright (c) 2015 Cong Wang <cwang@twopopensource.com>
Copyright (c) 2003-2013 Thomas Graf <tgraf@suug.ch>
Copyright (c) 2003-2011 Thomas Graf <tgraf@suug.ch>
Copyright (c) 2008-2013 Thomas Graf <tgraf@suug.ch>
Copyright (c) 2014 Cong Wang <xiyu.wangcong@gmail.com>
Copyright (c) 2018 Volodymyr Bendiuga <volodymyr.bendiuga@westermo.se>
Copyright (c) 2012 Shriram Rajagopalan <rshriram@cs.ubc.ca>
Copyright (c) 2018 Wang Jian <jjianjian.wang1@gmail.com>
Copyright (c) 2010-2013 Thomas Graf <tgraf@suug.ch>
Copyright (c) 2003-2006 Thomas Graf <tgraf@suug.ch>
Copyright (c) 2008-2010 Thomas Graf <tgraf@suug.ch>
Copyright (c) 2009-2010 Thomas Graf <tgraf@suug.ch>
Copyright (c) 2017 Volodymyr Bendiuga <volodymyr.bendiuga@gmail.com>
Copyright (c) 2008-2011 Thomas Graf <tgraf@suug.ch>
Copyright (c) 2003-2012 Thomas Graf <tgraf@suug.ch>
Copyright (c) 2008 Thomas Graf <tgraf@suug.ch>
Copyright (c) 2012 Cumulus Networks, Inc
Copyright (c) 2013 Sassano Systems LLC <joe@sassanosystems.com>
Copyright (C) 2012 Texas Instruments Incorporated - <http://www.ti.com/>
Copyright (c) 2003-2013 Thomas Graf <tgraf@suug.ch>
Copyright (c) 2003-2008 Thomas Graf <tgraf@suug.ch>
Copyright (c) 2007, 2008 Patrick McHardy <kaber@trash.net>
Copyright (c) 2008 Patrick McHardy <kaber@trash.net>
Copyright (c) 2009-2013 Thomas Graf <tgraf@suug.ch>
Copyright (c) 2008-2009 Thomas Graf <tgraf@suug.ch>
Copyright (c) 2012 Rich Fought <Rich.Fought@watchguard.com>
Copyright (c) 2010-2011 Thomas Graf <tgraf@suug.ch>
Copyright (c) 2003-2009 Thomas Graf <tgraf@suug.ch>
Copyright (c) 2015 Sabrina Dubroca <sd@queasysnail.net>
(c) UCB 1982-1988 Ross Biro Fred N. van Kempen, <waltje@uWalt.NL.Mugnet.ORG>
Copyright (c) 2008, Intel Corporation.
Copyright (c) 2014 Jiri Pirko <jiri@resnulli.us>
Copyright (c) 2009 Wolfgang Grandegger <wg@grandegger.com>
Copyright (c) 2014 Thomas Graf <tgraf@suug.ch>
Copyright (c) 2007, 2008 Patrick McHardy <kaber@trash.net>
Copyright (c) 2003-2009 Thomas Graf <tgraf@suug.ch>
Copyright (c) 2011 Adrian Ban <adrian.ban@mantech.ro>
Copyright (c) 2008-2009 Thomas Graf <tgraf@suug.ch>
Copyright (c) 2018 Avast software

Copyright (C) 2004-2015 Free Software Foundation, Inc.
Copyright (C) 2010-2015 Free Software Foundation, Inc.
Copyright 1992-2019 Free Software Foundation, Inc.
Copyright (C) 2014 Free Software Foundation, Inc.
Copyright (C) 2011 Free Software Foundation, Inc.
Copyright (C) 2002-2018 Free Software Foundation, Inc.
Copyright (C) 2011-2018 Free Software Foundation, Inc.
Copyright (C) 2001-2018 Free Software Foundation, Inc.
Copyright (C) 1997-2018 Free Software Foundation, Inc.
Copyright (C) 1999-2018 Free Software Foundation, Inc.
Copyright (C) 1996-2018 Free Software Foundation, Inc.
Copyright (C) 2003-2018 Free Software Foundation, Inc.
Copyright (C) 2009-2018 Free Software Foundation, Inc.
Copyright (C) 2006-2018 Free Software Foundation, Inc.
Copyright (C) 2004-2018 Free Software Foundation, Inc.
Copyright © 2004 Scott James Remnant <scott@netsplit.com>.
Copyright © 2012-2015 Dan Nicholson <dbn.lists@gmail.com>
Copyright (C) 1996-2001, 2003-2015 Free Software Foundation, Inc. Written by Gordon Matzigkeit, 1996
Copyright (C) 2004-2005, 2007-2009, 2011-2015 Free Software Foundation, Inc. Written by Gary V. Vaughan, 2004
Copyright (C) 2004-2005, 2007-2008, 2011-2015 Free Software Foundation, Inc. Written by Gary V. Vaughan, 2004
Copyright (C) 2004, 2011-2015 Free Software Foundation, Inc. Written by Scott James Remnant, 2004
Copyright (C) 2004-2005, 2007, 2009, 2011-2015 Free Software Foundation, Inc. Written by Scott James Remnant, 2004.
Copyright (C) 2012 Free Software Foundation, Inc.
Copyright (C) 2012 Free Software Foundation, Inc.
Copyright (c) 2015 David Ahern <dsa@cumulusnetworks.com>
Copyright (c) 2016 Jef Oliver <jef.oliver@intel.com>
Copyright (c) 2005 Petr Gotthard <petr.gotthard@siemens.com>
Copyright (c) 2005 Siemens AG Oesterreich
Copyright (c) 2006 Petr Gotthard <petr.gotthard@siemens.com>
Copyright (c) 2006 Siemens AG Oesterreich
Copyright (c) 2003-2006 Baruch Even <baruch@ev-en.org>, Mediatrix Telecom, inc. <ericb@mediatrix.com>
Copyright (c) 2005-2006 Petr Gotthard <petr.gotthard@siemens.com>
Copyright (c) 2005-2006 Siemens AG Oesterreich
Copyright (c) 2007 Philip Craig <philipc@snapgear.com>
Copyright (c) 2007 Secure Computing Corporation
Copyright (c) 2007 Secure Computing Corporation
Copyright (c) 2012 Rich Fought <rich.fought@watchguard.com>
Copyright (c) 2008 Patrick McHardy <kaber@trash.net>
Copyright (c) 2008-2009 Thomas Graf <tgraf@suug.ch>
Copyright (c= 2008 Patrick McHardy <kaber@trash.net>
Copyright (c) 2010 Karl Hiramoto <karl@hiramoto.org>
Copyright (c) 2013 Sassano Systems LLC <joe@sassanosystems.com>
Copyright (c= 2008 Patrick McHardy <kaber@trash.net>
Copyright (C) 2003-2010 Thomas Graf <tgraf@redhat.com>
Copyright (C) 1994 X Consortium
Copyright (C) 1996-2015 Free Software Foundation, Inc.
Copyright (C) 1999-2018 Free Software Foundation, Inc. Written by Tom Tromey <tromey@cygnus.com>.
Copyright 1992-2019 Free Software Foundation, Inc.
Copyright (C) 1999-2018 Free Software Foundation, Inc.
Copyright (C) 1996-2018 Free Software Foundation, Inc. Originally written by Fran,cois Pinard <pinard@iro.umontreal.ca>, 1996.
Copyright (C) 1991, 1999 Free Software Foundation, Inc.
Copyright 2004-2007 Lennart Poettering
Copyright (C) 1994-2018 Free Software Foundation, Inc.
Copyright (C) 1996-2018 Free Software Foundation, Inc.
Copyright (C) 1992-1996, 1998-2012 Free Software Foundation, Inc.

LICENCE TERMS (cont.)

Copyright (C) 2011 Free Software Foundation, Inc.
Copyright 2004-2007 Lennart Poettering
Copyright (C) 2004-2015 Free Software Foundation, Inc.
Copyright (C) 2010-2015 Free Software Foundation, Inc.
Copyright 1992-2019 Free Software Foundation, Inc.
Copyright (C) 2002-2018 Free Software Foundation, Inc.
Copyright (C) 2001-2018 Free Software Foundation, Inc.
Copyright (C) 1997-2018 Free Software Foundation, Inc.
Copyright (C) 1999-2018 Free Software Foundation, Inc.
Copyright (C) 1996-2018 Free Software Foundation, Inc.
Copyright (C) 2003-2018 Free Software Foundation, Inc.
Copyright (C) 2009-2018 Free Software Foundation, Inc.
Copyright (C) 2006-2018 Free Software Foundation, Inc.
Copyright (C) 2004-2018 Free Software Foundation, Inc.
Copyright (C) 1996-2001, 2003-2015 Free Software Foundation, Inc. Written by Gordon Matzigkeit, 1996
Copyright (C) 2014 Free Software Foundation, Inc.
Copyright (C) 2011 Free Software Foundation, Inc.
Copyright (C) 2004-2005, 2007-2009, 2011-2015 Free Software Foundation, Inc. Written by Gary V. Vaughan, 2004
Copyright (C) 2004-2005, 2007-2008, 2011-2015 Free Software Foundation, Inc. Written by Gary V. Vaughan, 2004
Copyright (C) 2004, 2011-2015 Free Software Foundation, Inc. Written by Scott James Remnant, 2004
Copyright (C) 2004-2005, 2007, 2009, 2011-2015 Free Software Foundation, Inc. Written by Scott James Remnant, 2004.
Copyright (C) 2012 Free Software Foundation, Inc.
Copyright (C) 1994 X Consortium
Copyright (C) 1996-2015 Free Software Foundation, Inc.
Copyright (C) 1999-2018 Free Software Foundation, Inc. Written by Tom Tromey <tromey@cygnus.com>.
Copyright 1992-2019 Free Software Foundation, Inc.
Copyright (C) 1999-2018 Free Software Foundation, Inc.
Copyright (C) 2004-2005, 2007, 2009, 2011-2015 Free Software Foundation, Inc. Written by Scott James Remnant, 2004.
Copyright (C) 2004, 2011-2015 Free Software Foundation, Inc. Written by Scott James Remnant, 2004
Copyright (C) 1996-2001, 2003-2015 Free Software Foundation, Inc. Written by Gordon Matzigkeit, 1996
Copyright (C) 2004-2005, 2007-2008, 2011-2015 Free Software Foundation, Inc. Written by Gary V. Vaughan, 2004
Copyright (C) 2004-2005, 2007-2009, 2011-2015 Free Software Foundation, Inc. Written by Gary V. Vaughan, 2004
Copyright (C) 1996-2018 Free Software Foundation, Inc. Originally written by Fran,cois Pinard <pinard@iro.umontreal.ca>, 1996.
Copyright (C) 2011-2018 Free Software Foundation, Inc.
Copyright (C) 1995-1997, 2000-2007, 2009-2010 by Ulrich Drepper <drepper@gnu.ai.mit.edu>
Copyright 1996-2016 Free Software Foundation, Inc. Taken from GNU libtool, 2001 Originally by Gordon Matzigkeit <gord@gnu.ai.mit.edu>, 1996
Copyright (C) 1994-1996, 1999-2002, 2004-2016 Free Software Foundation, Inc.
Copyright (C) 1996-2018 Free Software Foundation, Inc.
Copyright 1996-2013 Free Software Foundation, Inc. Taken from GNU libtool, 2001 Originally by Gordon Matzigkeit <gord@gnu.ai.mit.edu>, 1996
Copyright (c) 2005, 2006, 2009 Thorsten Kukuk <kukuk@suse.de>
Copyright (C) 1994-2018 Free Software Foundation, Inc.
Copyright 1999 by Theodore Ts'o.
Copyright (c) 2009 Thorsten Kukuk <kukuk@thkukuk.de>
(C) Copyright IBM Corporation 2005;(C) Copyright Red Hat 2006 All Rights Reserved.
Copyright (C) 1992-1996, 1998-2012 Free Software Foundation, Inc.
(C) Copyright IBM Corporation 2005;(C) Copyright Red Hat, Inc. 2006, 2008 All Rights Reserved.
Copyright (c) Andrew G. Morgan <morgan@ftp.kernel.org>
Copyright (c) 2005 Thorsten Kukuk <kukuk@suse.de>
Copyright (c) 1999 Andrew G. Morgan <morgan@linux.kernel.org>
Copyright 2005 Red Hat Inc., Durham, North Carolina. All Rights Reserved.
Copyright (c) 2006, 2009 Thorsten Kukuk <kukuk@thkukuk.de>
Copyright (c) 1999 Andrew G. Morgan <morgan@ftp.kernel.org>

Copyright 2001-2003 Red Hat, Inc.
Copyright (c) 2005, 2006, 2008, 2009 Thorsten Kukuk <kukuk@suse.de>
Copyright (C) 2004-2013 Free Software Foundation, Inc.
Copyright (c) 2005, 2006, 2007, 2009 Thorsten Kukuk <kukuk@thkukuk.de>
Copyright 1989 - 1994, Julianne Frances Haugh All rights reserved.
Copyright (C) 1984, 1989-1990, 2000-2012 Free Software Foundation, Inc.
(c) yyunput
Copyright (c) 2006, 2009 David Howells <dhowells@redhat.com>
Copyright (c) Andrew G. Morgan 1997 <morgan@parc.power.net>
Copyright (C) 1984, 1989-1990, 2000-2012 Free Software Foundation, Inc.
Copyright (C) 2006 Red Hat, Inc. All Rights Reserved. Written by David Howells (dhowells@redhat.com)
Copyright (C) 1994-2018 Free Software Foundation, Inc.
Copyright (c) 2006 Thorsten Kukuk <kukuk@thkukuk.de>
Copyright (c) 2006 Thorsten Kukuk <kukuk@suse.de>
Copyright (c) 2005, 2006, 2008 Thorsten Kukuk <kukuk@thkukuk.de>
Copyright (c) 2005, 2006, 2009, 2011 Thorsten Kukuk <kukuk@suse.de>
Copyright (C) YEAR Linux-PAM Project
Copyright (c) 2006, 2009 Thorsten Kukuk <kukuk@suse.de>
Copyright (c) 2006, 2008 Thorsten Kukuk <kukuk@thkukuk.de>
Copyright (C) YEAR Linux-PAM Project
Copyright (c) 2005, 2006, 2009 Thorsten Kukuk <kukuk@thkukuk.de>
Copyright (c) 2005, 2006 Thorsten Kukuk <kukuk@suse.de>
Copyright (c) 2005, 2006, 2007 Thorsten Kukuk <kukuk@thkukuk.de>
Copyright (c) 2007, 2008, 2009 Red Hat, Inc. Originally written by Tomas Mraz <tmraz@redhat.com> Contributions by Dan Walsh <dwalsh@redhat.com>
Copyright (c) Cristian Gafton <gafton@redhat.com>, 1999 All rights reserved
Copyright (c) 2005, 2009 Thorsten Kukuk <kukuk@suse.de>
Copyright (c) 2006 Thorsten Kukuk <kukuk@thkukuk.de>
Copyright 2003,2004 Red Hat, Inc.
Copyright (c) 2005, 2009 Thorsten Kukuk <kukuk@suse.de>
Copyright (c) 2003 Red Hat, Inc. Written by Nalin Dahyabhai <nalin@redhat.com>
Copyright (c) 2002 Red Hat, Inc. Written by Nalin Dahyabhai <nalin@redhat.com>
Copyright © 2007, 2008 Red Hat, Inc. All rights reserved. Red Hat author: Miloslav Trmac <mitr@redhat.com>
Copyright (c) 2005, 2006, 2009, 2010 Thorsten Kukuk <kukuk@suse.de>
Copyright (c) 2008, 2009 Thorsten Kukuk <kukuk@suse.de>
Copyright (c) 2008, 2012 Thorsten Kukuk Author: Thorsten Kukuk <kukuk@thkukuk.de>
Copyright (c) 2008 Thorsten Kukuk <kukuk@suse.de>
Copyright 1999 by Ben Collins <bcollins@debian.org>
Copyright 2001, 2004 Red Hat, Inc.
Copyright (c) 2005, 2006, 2007, 2009 Thorsten Kukuk <kukuk@thkukuk.de>
Copyright 2006, Red Hat, Inc.
Copyright 2006, Red Hat, Inc. All rights reserved.
Copyright (c) 2005, 2006 Thorsten Kukuk <kukuk@suse.de>
Copyright Alexander O. Yuriev, 1996. All rights reserved. NIS+ support by Thorsten Kukuk <kukuk@weber.uni-paderborn.de>
Copyright 1994, 1995, 1996 Olaf Kirch, <okir@lst.de>
Copyright Elliot Lee, 1996. All rights reserved.
Copyright Alexander O. Yuriev, 1996. All rights reserved.
Copyright (C) 1996.
Copyright (c) 2005, 2006, 2007, 2010, 2013 Thorsten Kukuk <kukuk@thkukuk.de>
Copyright (c) 2005, 2006, 2009 Thorsten Kukuk <kukuk@suse.de>
Copyright (c) Red Hat, Inc. 2009 Originally written by Jason Gunthorpe <jgg@debian.org> Feb 1999 Structure taken from pam_lastlogin by Andrew Morgan morgan@parc.power.net> 1996
Copyright (c) Red Hat, Inc., 2009 Originally written by Jason Gunthorpe <jgg@debian.org> Feb 1999 Structure taken from pam_lastlogin by Andrew Morgan morgan@parc.power.net> 1996
Copyright 2003, 2004 Red Hat, Inc.
Copyright (c) 2003-2008 Red Hat, Inc. Written by Dan Walsh <dwalsh@redhat.com> Additional improvements by

LICENCE TERMS (cont.)

Tomas Mraz <tmraz@redhat.com>
Copyright (c) 2005, 2006, 2007 Thorsten Kukuk <kukuk@thkukuk.de>
Copyright (c) 2003 Red Hat, Inc. Written by Dan Walsh <dwalsh@redhat.com>
(C) 2005-2006 Red Hat, Inc.
Copyright (c) 2001 Andrew Morgan <morgan@kernel.org>
Copyright (c) Andrew G. Morgan <morgan@kernel.org> 2000-2003 All rights reserved.
Copyright (c) 1998, 2005 Andrew G. Morgan <morgan@kernel.org>
Copyright (c) Andrew G. Morgan <morgan@kernel.org> 1996-9 All rights reserved.
Copyright (c) 2006, 2007 Thorsten Kukuk <kukuk@thkukuk.de>
(C) Sebastien Tricaud 2005 <toady@gscore.org>
Copyright Theodore Ts'o, 1996. All rights reserved.
Copyright (c) 2001-2002 Andrew Morgan <morgan@kernel.org>
Copyright (C) 2005, 2006, 2008, 2009 Thorsten Kukuk.
Copyright (c) Andrew G. Morgan <morgan@parc.power.net> 1996,1997 All rights reserved.
Copyright (C) 1996-2018 Free Software Foundation, Inc.
Copyright (c) 2005, 2006, 2010 Thorsten Kukuk <kukuk@suse.de>
Copyright (C) Nalin Dahyabhai <nalin@redhat.com> 2003
Copyright (C) Thorsten Kukuk <kukuk@suse.de> 2009
Copyright (C) 2004-2015 Free Software Foundation, Inc.
Copyright (C) 2010-2015 Free Software Foundation, Inc.
Copyright(c) all begin with the string "--lt-" application programs are unlikely to have options that match this pattern).
Copyright 1992-2019 Free Software Foundation, Inc.
Copyright (C) 2014 Free Software Foundation, Inc.
Copyright (C) 2011 Free Software Foundation, Inc.
Copyright (c) 2006 Thorsten Kukuk <kukuk@suse.de>
Copyright (c) 2005, 2006, 2009 Thorsten Kukuk <kukuk@suse.de>
Copyright (c) 2006 Red Hat, Inc.
Copyright (c) 2009 Thorsten Kukuk <kukuk@thkukuk.de>
Copyright (C) 2012 Free Software Foundation, Inc.
Copyright (C) 2012 Free Software Foundation, Inc.
Copyright (C) 2014 Free Software Foundation, Inc.
Copyright (C) 2012 Free Software Foundation, Inc.
Copyright (c) 2005 Thorsten Kukuk <kukuk@suse.de>
Copyright (c) 2006, 2009 Thorsten Kukuk <kukuk@thkukuk.de>
Copyright (C) 2011 Free Software Foundation, Inc.
Copyright (c) 2005, 2006, 2008, 2009 Thorsten Kukuk <kukuk@suse.de>
Copyright (c) 2005, 2006, 2007 Thorsten Kukuk <kukuk@thkukuk.de>
Copyright (c) 2005, 2006, 2007, 2009 Thorsten Kukuk <kukuk@thkukuk.de>
Copyright (c) Andrew G. Morgan 1997 <morgan@parc.power.net>
Copyright (c) Andrew G. Morgan 1997-8 <morgan@linux.kernel.org>
Copyright (c) 2006, 2009 David Howells <dhowells@redhat.com>
Copyright (c) Jan R korajski 1999.
Copyright (c) Andrew G. Morgan 1996-8.
Copyright (c) Alex O. Yuriev, 1996.
Copyright (c) Cristian Gafton 1996.
Copyright (c) Red Hat, Inc. 2007.
Copyright (c) Andrew G. Morgan 1996-8.
Copyright (c) Alex O. Yuriev, 1996.
Copyright (c) Cristian Gafton 1996.
Copyright (c) Red Hat, Inc. 2007.
Copyright (c) Cristian Gafton <gafton@redhat.com>, 1996, 1997 All rights reserved
Copyright (c) Cristian Gafton <gafton@redhat.com>, 1996, 1997 All rights reserved
Copyright (c) Cristian Gafton <gafton@redhat.com>, 1996. All rights reserved
Copyright (c) Philip W. Dalrymple III <pwd@mdtsoft.com> 1997. All rights reserved
Copyright (c) Cristian Gafton <gafton@redhat.com>, 1996. All rights reserved
Copyright (c) Philip W. Dalrymple III <pwd@mdtsoft.com> 1997. All rights reserved
Copyright (c) 2006, 2009 Thorsten Kukuk <kukuk@suse.de>

Copyright (c) 2005, 2006, 2009 Thorsten Kukuk <kukuk@thkukuk.de>
Copyright (c) 2008, 2009 Red Hat, Inc.
Copyright (c) Cristian Gafton <gafton@redhat.com>, 1999 All rights reserved
Copyright (c) Cristian Gafton <gafton@redhat.com>, 1999 All rights reserved
Copyright (c) Cristian Gafton, 1996-1997, <gafton@redhat.com> All rights reserved.
Copyright (c) Cristian Gafton, 1996-1997, <gafton@redhat.com> All rights reserved.
Copyright (c) 2005, 2009 Thorsten Kukuk <kukuk@suse.de>
Copyright (c) 2005 Darren Tucker <dtucker at zip com au>.
Copyright (c) 2005 Darren Tucker <dtucker at zip com au>.
Copyright (c) 2005, 2006, 2008 Thorsten Kukuk <kukuk@thkukuk.de>
Copyright (c) 2005, 2008 Red Hat, Inc.
Copyright (c) 2005, 2009 Thorsten Kukuk <kukuk@suse.de>
Copyright (c) 2005, 2006, 2009, 2010 Thorsten Kukuk <kukuk@suse.de>
Copyright (c) 2008, 2009 Thorsten Kukuk <kukuk@suse.de>
Copyright (c) 2008 Red Hat, Inc.
Copyright 1989 - 1993, Julianne Frances Haugh All rights reserved.
Copyright 1989 - 1993, Julianne Frances Haugh All rights reserved.
Copyright (c) 2005, 2006, 2007, 2009 Thorsten Kukuk <kukuk@thkukuk.de>
Copyright Jan R korajski, 1999. All rights reserved.
Copyright Jan R korajski, 1999. All rights reserved.
Copyright (c) 2005, 2006, 2009, 2011 Thorsten Kukuk <kukuk@suse.de>
Copyright (c) 2006 Thorsten Kukuk <kukuk@thkukuk.de>
Copyright (c) Andrew G. Morgan, 1996. All rights reserved
Copyright (c) Red Hat, Inc., 2007, 2008. All rights reserved
Copyright (c) Andrew G. Morgan, 1996. All rights reserved
Copyright (c) Red Hat, Inc., 2007, 2008. All rights reserved
Copyright (c) 2006 Thorsten Kukuk <
Copyright (c) 1996-2002 Andrew G. Morgan <
Copyright (c) 2006 Thorsten Kukuk <
Copyright (c) 1996-2002 Andrew G. Morgan <
Copyright (c) Red Hat, Inc., 2007,2008. All rights reserved
Copyright (c) Red Hat, Inc., 2007,2008. All rights reserved
Copyright (c) 2005, 2006 Thorsten Kukuk <kukuk@suse.de>
Copyright (c) Red Hat, Inc. 1996, 2007, 2008.
Copyright (c) Red Hat, Inc. 1996, 2007, 2008.
Copyright (c) Jan R korajski, 1999.
Copyright (c) Red Hat, Inc., 2007, 2008.
Copyright (c) Jan R korajski, 1999.
Copyright (c) Red Hat, Inc., 2007, 2008.
Copyright 1995 by Wietse Venema. All rights reserved.
Copyright (c) 2005, 2006, 2009 Thorsten Kukuk <kukuk@suse.de>
Copyright (c) 2005, 2006, 2007 Thorsten Kukuk <kukuk@thkukuk.de>
Copyright (C) 1998,2001 Andrew G. Morgan <morgan@kernel.org>
Copyright (C) 1998,2001 Andrew G. Morgan <morgan@kernel.org>
Copyright (C) 1995 by Red Hat Software, Marc Ewing
Copyright (c) 1996-8,2001 by Andrew G. Morgan <morgan@kernel.org>
Copyright (C) 1995 by Red Hat Software, Marc Ewing
Copyright (c) 1996-8,2001 by Andrew G. Morgan <morgan@kernel.org>
Copyright Theodore Ts'o, 1996. All rights reserved.
Copyright Theodore Ts'o, 1996. All rights reserved.
Copyright (C) Theodore Ts'o, 1996.
Copyright (C) Andrew Morgan, 1996-8. All rights reserved.
Copyright (C) Theodore Ts'o, 1996.
Copyright (C) Andrew Morgan, 1996-8. All rights reserved.
Copyright (c) Andrew G. Morgan <morgan@linux.kernel.org>, 1996-8
Copyright (c) Andrew G. Morgan <morgan@linux.kernel.org>, 1996-8
Copyright (C) 2002-2018 Free Software Foundation, Inc.

LICENCE TERMS (cont.)

Copyright (C) 2001-2018 Free Software Foundation, Inc.
Copyright (C) 1997-2018 Free Software Foundation, Inc.
Copyright (C) 1999-2018 Free Software Foundation, Inc.
Copyright (C) 1996-2018 Free Software Foundation, Inc.
Copyright (C) 2003-2018 Free Software Foundation, Inc.
Copyright (C) 1998-2018 Free Software Foundation, Inc.
Copyright (C) 2009-2018 Free Software Foundation, Inc.
Copyright (C) 2006-2018 Free Software Foundation, Inc.
Copyright (C) 2004-2018 Free Software Foundation, Inc.
Copyright (C) 1995-2014, 2016 Free Software Foundation, Inc.
Copyright (C) 2000-2002, 2007-2014, 2016 Free Software Foundation, Inc.
Copyright (C) 1996-2003, 2009-2016 Free Software Foundation, Inc.
Copyright (C) 2001-2016 Free Software Foundation, Inc.
Copyright (C) 2001-2005, 2008-2016 Free Software Foundation, Inc.
Copyright (C) 1995-2003, 2005-2006, 2008-2014, 2016 Free Software dnl Foundation, Inc.
Copyright © 2004 Scott James Remnant <scott@netsplit.com>.
Copyright © 2012-2015 Dan Nicholson <dbn.lists@gmail.com>
Copyright (C) 1996-2003, 2005, 2008-2016 Free Software Foundation, Inc.
Copyright (C) 2004-2013 Free Software Foundation, Inc.
Copyright (C) 1996-2001, 2003-2015 Free Software Foundation, Inc. Written by Gordon Matzigkeit, 1996
Copyright (C) 2004-2005, 2007-2009, 2011-2015 Free Software Foundation, Inc. Written by Gary V. Vaughan, 2004
Copyright (C) 2004-2005, 2007-2008, 2011-2015 Free Software Foundation, Inc. Written by Gary V. Vaughan, 2004
Copyright (C) 2004, 2011-2015 Free Software Foundation, Inc. Written by Scott James Remnant, 2004
Copyright (C) 2004-2005, 2007, 2009, 2011-2015 Free Software Foundation, Inc. Written by Scott James Remnant, 2004.
Copyright (C) 2002-2018 Free Software Foundation, Inc.
Copyright (C) 2001-2018 Free Software Foundation, Inc.
Copyright (C) 1997-2018 Free Software Foundation, Inc.
Copyright (C) 1999-2018 Free Software Foundation, Inc.
Copyright (C) 1996-2018 Free Software Foundation, Inc.
Copyright (C) 2003-2018 Free Software Foundation, Inc.
Copyright (C) 1998-2018 Free Software Foundation, Inc.
Copyright (C) 2009-2018 Free Software Foundation, Inc.
Copyright (C) 2006-2018 Free Software Foundation, Inc.
Copyright (C) 2004-2018 Free Software Foundation, Inc.
Copyright (C) 1995-2014, 2016 Free Software Foundation, Inc.
Copyright (C) 2000-2002, 2007-2014, 2016 Free Software Foundation, Inc.
Copyright (C) 1996-2003, 2009-2016 Free Software Foundation, Inc.
Copyright (C) 2001-2016 Free Software Foundation, Inc.
Copyright (C) 2001-2005, 2008-2016 Free Software Foundation, Inc.
Copyright (C) 1995-2003, 2005-2006, 2008-2014, 2016 Free Software dnl Foundation, Inc.
Copyright © 2004 Scott James Remnant <scott@netsplit.com>.
Copyright © 2012-2015 Dan Nicholson <dbn.lists@gmail.com>
Copyright (C) 1996-2003, 2005, 2008-2016 Free Software Foundation, Inc.
Copyright (C) 2004-2013 Free Software Foundation, Inc.
Copyright (C) 1996-2001, 2003-2015 Free Software Foundation, Inc. Written by Gordon Matzigkeit, 1996
Copyright (C) 2004-2005, 2007-2009, 2011-2015 Free Software Foundation, Inc. Written by Gary V. Vaughan, 2004
Copyright (C) 2004-2005, 2007-2008, 2011-2015 Free Software Foundation, Inc. Written by Gary V. Vaughan, 2004
Copyright (C) 2004, 2011-2015 Free Software Foundation, Inc. Written by Scott James Remnant, 2004
Copyright (C) 2004-2005, 2007, 2009, 2011-2015 Free Software Foundation, Inc. Written by Scott James Remnant, 2004.
Copyright (c) 2006, 2007 Thorsten Kukuk <kukuk@thkukuk.de>
Copyright (c) 2005, 2006, 2010 Thorsten Kukuk <kukuk@suse.de>
Copyright 1992-2019 Free Software Foundation, Inc.; Copyright 1992-2019 Free Software Foundation, Inc.
Copyright (c) 1994, 1996, 1997 The Regents of the University of California. All rights reserved.
Copyright (c) 2002 - 2003 NetGroup, Politecnico di Torino (Italy) All rights reserved.
Copyright (c) 1993, 1994, 1995, 1996 The Regents of the University of California. All rights reserved.

Copyright (c) 1994, 1995, 1996 The Regents of the University of California. All rights reserved.
Copyright (c) 1993, 1994, 1995, 1996, 1998 The Regents of the University of California. All rights reserved.
Copyright (c) 1993, 1994, 1995, 1996, 1997 The Regents of the University of California. All rights reserved.
Copyright (c) 1987, 1993, 1994 The Regents of the University of California. All rights reserved.
Copyright 1991 by the Massachusetts Institute of Technology
Copyright TCPdump Group
Copyright (c) 2002 - 2005 NetGroup, Politecnico di Torino (Italy)
Copyright (c) 2002-2005 NetGroup, Politecnico di Torino (Italy)
Copyright (c) 1993, 1994, 1995, 1996, 1997 The Regents of the University of California. All rights reserved.
Copyright (c) 2006 Paolo Abeni (Italy) All rights reserved.
Copyright (c) 2007 Fulko Hew, SITA INC Canada, Inc <fulko.hew@sita.aero>
Copyright (c) 1988, 1989, 1990, 1991, 1992, 1993, 1994, 1995, 1996 The Regents of the University of California. All rights reserved.
Copyright (c) 1990, 1991, 1992, 1993, 1994, 1995, 1996 The Regents of the University of California. All rights reserved.
Copyright (c) 1988, 1989, 1990, 1991, 1992, 1993, 1994, 1995, 1996, 1997 The Regents of the University of California. All rights reserved.
"Copyright (c) 1994, 1995, 1996, 1997 dnl The Regents of the University of California. All rights reserved."
Copyright 1989 by Carnegie Mellon.
Copyright (C) 2016 Julian Andres Klode <jak@debian.org>.
Copyright (c) 1996 Juniper Networks, Inc. All rights reserved.
Copyright (C) 2017 Ali Abdulkadir <autostart.ini@gmail.com>.
Copyright (c) 1990, 1993, 1994, 1995, 1996 The Regents of the University of California. All rights reserved.
Copyright (c) 1993, 1994, 1995, 1996, 1997, 1998 The Regents of the University of California. All rights reserved.
Copyright (c) 1998, 2015 Todd C. Miller <Todd.Miller@courtesan.com>
Copyright (c) 1995-1999 Kungliga Tekniska Högskolan Royal Institute of Technology, Stockholm, Sweden). All rights reserved.
"Copyright (c) 1995, 1996, 1997, 1998 dnl The Regents of the University of California. All rights reserved."
Copyright (c) 1998 Softweyr LLC. All rights reserved.
Copyright (c) 1992, 1993, 1994, 1995, 1996 The Regents of the University of California. All rights reserved.
Copyright (c) 1994, 1995, 1996, 1997, 1998 The Regents of the University of California. All rights reserved.
Copyright (c) 1987, 1988, 1989, 1990, 1991, 1992, 1994, 1995, 1996, 1997 The Regents of the University of California. All rights reserved. All rights reserved.
Copyright (c) 1990, 1991, 1992, 1993, 1994, 1995, 1996, 1997, 1998 The Regents of the University of California. All rights reserved.
Copyright (c) 2000 Torsten Landschoff <torsten@debian.org> Sebastian Kraemer <kraemer@cs.uni-potsdam.de>
Copyright (c) 1993, 1994, 1996 The Regents of the University of California. All rights reserved.
Copyright (C) 1992-1996, 1998-2012 Free Software Foundation, Inc.
Copyright (c) 1997 Yen Yen Lim and North Dakota State University All rights reserved.
Copyright (c) 2014 Michal Labeledzki for Tieto Corporation All rights reserved.
Copyright (c) 2011 Jakub Zawadzki All rights reserved.
Copyright (c) 1990, 1991, 1992, 1994, 1995, 1996 The Regents of the University of California. All rights reserved.
Copyright (c) 2013, Michal Sekletar All rights reserved.
Copyright (c) 1982, 1986, 1993 The Regents of the University of California. All rights reserved.
Copyright (c) 2013, Petar Alilovic, Faculty of Electrical Engineering and Computing, University of Zagreb All rights reserved
Copyright (c) 1990, 1991, 1992, 1993, 1994, 1995, 1996, 1997 The Regents of the University of California. All rights reserved.
Copyright (c) 1994, 1996 The Regents of the University of California. All rights reserved.
Copyright (c) 1994, 1996 The Regents of the University of California. All rights reserved.
Copyright (c) 1988, 1989, 1990, 1991, 1993, 1994, 1995, 1996 The Regents of the University of California. All rights reserved.
Copyright (c) 1990, 1991, 1992, 1993, 1994, 1995, 1996 The Regents of the University of California. All rights reserved.
Copyright (c) 2008 CACE Technologies, Davis (California) All rights reserved.
Copyright (C) 2014 Luigi Rizzo. All rights reserved.
Copyright (c) 2017 Pure Storage, Inc. All rights reserved.

LICENCE TERMS (cont.)

Copyright (c) 1994, 1995, 1996 The Regents of the University of California. All rights reserved.
Copyright (c) 1999 - 2005 NetGroup, Politecnico di Torino (Italy)
Copyright (c) 2001 Atsushi Onoe
Copyright (c) 2012 Jakub Zawadzki All rights reserved.
Copyright (c) 1988, 1989, 1990, 1991, 1992, 1993, 1994, 1995, 1996, 1997, 2000 The Regents of the University of California. All rights reserved.
Copyright (c) 1993, 1994, 1997 The Regents of the University of California. All rights reserved.
Copyright The TCPdump Group
Copyright (c) 1989, 1990, 1993, 1994, 1995, 1996 The Regents of the University of California. All rights reserved.
Copyright (c) 2005 - 2008 CACE Technologies, Davis (California) All rights reserved.
Copyright (c) 2005 - 2008 CACE Technologies, Davis (California) All rights reserved.
Copyright (c) 2005 - 2008 CACE Technologies, Davis (California) All rights reserved.
Copyright (c) 2005-2009 CACE Technologies
Copyright (c) 2018- The TCPdump Group All rights reserved.
Copyright (c) 2005-2009 CACE Technologies
Copyright (c) 2018- The TCPdump Group All rights reserved.
Copyright (c) 2005-2009 CACE Technologies
Copyright (c) 2018- The TCPdump Group All rights reserved.
Copyright (c) 1988, 1993 The Regents of the University of California. All rights reserved.
Copyright (c) 1988, 1993 The Regents of the University of California. All rights reserved.
"Copyright (c) 2007, 2008 Johannes Berg"
Copyright (c) 2007 Andy Lutomirski
Copyright (c) 2007 Mike Kershaw
Copyright (c) 2008 Gábor Stefanik
"Copyright (c) 2007, 2008 Johannes Berg"
Copyright (c) 2007 Andy Lutomirski
Copyright (c) 2007 Mike Kershaw
Copyright (c) 2008 Gábor Stefanik
Copyright (C) 2012 Free Software Foundation, Inc. This configure script is free software
Copyright (C) 2012 Free Software Foundation, Inc. This config.status script is free software
Copyright (c) 2005 - 2009 CACE Technologies, Inc. Davis (California) All rights reserved.
Copyright (c) 2005 - 2009 CACE Technologies, Inc. Davis (California) All rights reserved.
Copyright (c) 2005 - 2009 CACE Technologies, Inc. Davis (California) All rights reserved.
Copyright (c) 2002 - 2003 NetGroup, Politecnico di Torino (Italy) All rights reserved.
Copyright (c) 2002 - 2003 NetGroup, Politecnico di Torino (Italy) All rights reserved.
Copyright (c) 2002 - 2003 NetGroup, Politecnico di Torino (Italy) All rights reserved.
Copyright (c) 1997 Yen Yen Lim and North Dakota State University All rights reserved.
Copyright (c) 1997 Yen Yen Lim and North Dakota State University All rights reserved.
Copyright (c) 2005 - 2010 CACE Technologies, Davis (California) All rights reserved.
Copyright (c) 2005 - 2010 CACE Technologies, Davis (California) All rights reserved.
Copyright (c) 2005 - 2010 CACE Technologies, Davis (California) All rights reserved.
Copyright (c) 2002-2005 Sam Leffler, Errno Consulting All rights reserved.
Copyright (c) 2002-2005 Sam Leffler, Errno Consulting All rights reserved.
Copyright (c) 1988, 1989, 1990, 1991, 1992, 1993, 1994, 1995, 1996, 1997, 2000\n The Regents of the University of California. All rights reserved.
Copyright (c) 1988, 1989, 1990, 1991, 1992, 1993, 1994, 1995, 1996, 1997, 2000\n The Regents of the University of California. All rights reserved.
Copyright (C) 1994 X Consortium
Copyright (C) 1996-2015 Free Software Foundation, Inc.
Copyright (C) 1999-2018 Free Software Foundation, Inc. Written by Tom Tromey <tromey@cygnus.com>.
Copyright 1992-2019 Free Software Foundation, Inc.
Copyright (C) 1999-2018 Free Software Foundation, Inc.
Copyright (C) 2004-2005, 2007, 2009, 2011-2015 Free Software Foundation, Inc. Written by Scott James Remnant, 2004.
Copyright (C) 2004, 2011-2015 Free Software Foundation, Inc. Written by Scott James Remnant, 2004
Copyright (C) 1996-2001, 2003-2015 Free Software Foundation, Inc. Written by Gordon Matzigkeit, 1996
Copyright (C) 2004-2005, 2007-2008, 2011-2015 Free Software Foundation, Inc. Written by Gary V. Vaughan, 2004

Copyright (C) 2004-2005, 2007-2009, 2011-2015 Free Software Foundation, Inc. Written by Gary V. Vaughan, 2004
Copyright (C) 1996-2018 Free Software Foundation, Inc. Originally written by Fran,cois Pinard <pinard@iro.umontreal.ca>, 1996.
Copyright (C) 2011-2018 Free Software Foundation, Inc.
Copyright (C) 1994-1996, 1999-2002, 2004-2016 Free Software Foundation, Inc.
Copyright (C) 2010-2018 Free Software Foundation, Inc. Written by Peter Rosin <peda@lysator.liu.se>.
Copyright (c) 1997-2017 University of Cambridge
Copyright (c) 1997-2012 University of Cambridge
Copyright 2013-2015 Tiler Corporation(jiawang@tilera.com). All rights reserved.
(C) Auxiliary files:
Copyright (C) 2005, 2008, 2010-2011 Free Software Foundation, Inc.
Copyright (c) 2008 Steven G. Johnson <stevenj@alum.mit.edu>
Copyright (c) 1997-2018 University of Cambridge
Copyright (c) 1997-2014 University of Cambridge
Copyright (c) 2005, Google Inc. All rights reserved.
Copyright (c) 2010, Google Inc. All rights reserved.
Copyright (c) 1997-2013 University of Cambridge
Copyright (C) 1996-2018 Free Software Foundation, Inc.
Copyright (c) 2005 - 2010, Google Inc. All rights reserved.
Copyright (c) 1997-2020 University of Cambridge
Copyright (c) 1997-2016 University of Cambridge
Copyright (C) 1992-1996, 1998-2012 Free Software Foundation, Inc.
Copyright (c) 1997-2019 University of Cambridge All rights reserved
(c) 2001 Peter S. Voronov aka Chem O'Dun <petervrn@yahoo.com>
Copyright (c) 1997-2014 University of Cambridge.
Copyright (c) 1997-2013 University of Cambridge.
Copyright 2003 and onwards Google Inc. Author: Sanjay Ghemawat
Copyright (c) 1997-2012 University of Cambridge.
Copyright (c) 1997-2015 University of Cambridge.
Copyright (c) 1997-2016 University of Cambridge.
Copyright (c) 1997-2017 University of Cambridge.
Copyright (c) 1997-2015 University of Cambridge.
Copyright (c) 2007 Google Inc.
Copyright © 1997-2013 University of Cambridge.
Copyright © 1997-2012 University of Cambridge.
Copyright (C) 2011 Free Software Foundation, Inc.
Copyright © 1997-2014 University of Cambridge.
Copyright © 1997-2016 University of Cambridge.
Copyright © 1997-2015 University of Cambridge.
Copyright (C) 1994-2018 Free Software Foundation, Inc.
Copyright © 1997-2017 University of Cambridge.
Copyright © 2007 Google Inc.
Copyright (c) 1997-2014 University of Cambridge.
Copyright (c) 1997-2017 University of Cambridge.
Copyright (C) 2004-2015 Free Software Foundation, Inc.
Copyright (C) 2010-2015 Free Software Foundation, Inc.
Copyright 1992-2019 Free Software Foundation, Inc.
Copyright (C) 2014 Free Software Foundation, Inc.
Copyright (C) 2011 Free Software Foundation, Inc.
Copyright (c) 2011 Daniel Richard G. <skunk@iSKUNK.ORG>
Copyright (c) 2011 Daniel Richard G. <skunk@iSKUNK.ORG>
Copyright (c) 2010-2012
Copyright (c) 2010-2012
Copyright (C) 2002-2018 Free Software Foundation, Inc.
Copyright (C) 2011-2018 Free Software Foundation, Inc.
Copyright (C) 2001-2018 Free Software Foundation, Inc.
Copyright (C) 1997-2018 Free Software Foundation, Inc.

LICENCE TERMS (cont.)

Copyright (C) 1999-2018 Free Software Foundation, Inc.
Copyright (C) 1996-2018 Free Software Foundation, Inc.
Copyright (C) 2003-2018 Free Software Foundation, Inc.
Copyright (C) 2009-2018 Free Software Foundation, Inc.
Copyright (C) 2006-2018 Free Software Foundation, Inc.
Copyright (C) 2004-2018 Free Software Foundation, Inc.
Copyright (c) 2008 Steven G. Johnson <stevenj@alum.mit.edu>
Copyright (C) 1996-2001, 2003-2015 Free Software Foundation, Inc. Written by Gordon Matzigkeit, 1996
Copyright (C) 2014 Free Software Foundation, Inc.
Copyright (C) 2011 Free Software Foundation, Inc.
Copyright (C) 2004-2005, 2007-2009, 2011-2015 Free Software Foundation, Inc. Written by Gary V. Vaughan, 2004
Copyright (C) 2004-2005, 2007-2008, 2011-2015 Free Software Foundation, Inc. Written by Gary V. Vaughan, 2004
Copyright (C) 2004, 2011-2015 Free Software Foundation, Inc. Written by Scott James Remnant, 2004
Copyright (C) 2004-2005, 2007, 2009, 2011-2015 Free Software Foundation, Inc. Written by Scott James Remnant, 2004.
Copyright (C) 2005, 2008, 2010-2011 Free Software Foundation, Inc.
Copyright (C) 2002-2018 Free Software Foundation, Inc.
Copyright (C) 2011-2018 Free Software Foundation, Inc.
Copyright (C) 2001-2018 Free Software Foundation, Inc.
Copyright (C) 1997-2018 Free Software Foundation, Inc.
Copyright (C) 1999-2018 Free Software Foundation, Inc.
Copyright (C) 1996-2018 Free Software Foundation, Inc.
Copyright (C) 2003-2018 Free Software Foundation, Inc.
Copyright (C) 2009-2018 Free Software Foundation, Inc.
Copyright (C) 2006-2018 Free Software Foundation, Inc.
Copyright (C) 2004-2018 Free Software Foundation, Inc.
Copyright (c) 2008 Steven G. Johnson <stevenj@alum.mit.edu>
Copyright (C) 1996-2001, 2003-2015 Free Software Foundation, Inc. Written by Gordon Matzigkeit, 1996
Copyright (C) 2004-2005, 2007-2009, 2011-2015 Free Software Foundation, Inc. Written by Gary V. Vaughan, 2004
Copyright (C) 2004-2005, 2007-2008, 2011-2015 Free Software Foundation, Inc. Written by Gary V. Vaughan, 2004
Copyright (C) 2004, 2011-2015 Free Software Foundation, Inc. Written by Scott James Remnant, 2004
Copyright (C) 2004-2005, 2007, 2009, 2011-2015 Free Software Foundation, Inc. Written by Scott James Remnant, 2004.
Copyright (C) 2005, 2008, 2010-2011 Free Software Foundation, Inc.
copyright(c) is TRUE. Otherwise it has an undefined behaviour.
copyright(c) is TRUE. Otherwise it has an undefined behaviour.
Copyright (C) 2012 Free Software Foundation, Inc.
Copyright (C) 2012 Free Software Foundation, Inc.
Copyright(c) 2010-2019 Zoltan Herczeg All rights reserved.
Copyright(c) 2009-2019 Zoltan Herczeg All rights reserved.
Copyright (c) 2007-2012 Google Inc All rights reserved
Copyright(c) 2001 Alexander Tokarev <dwalin@dwalin.ru>
Copyright (c) 2001, Alexander Tokarev All rights reserved.
Copyright (c) 1997-2004 University of Cambridge
Copyright (c) 2010-2013
Copyright (c) 2010-2013
Copyright (c) 1997-2013 University of Cambridge.
Copyright (c) 1997-2012 University of Cambridge.
Copyright (c) 1997-2015 University of Cambridge.
Copyright (c) 1997-2016 University of Cambridge.
Copyright (c) 1997-2014 University of Cambridge.
Copyright (c) 1997-2017 University of Cambridge.
Copyright (c) 2007 Google Inc.
Copyright (c) 1997-2012 University of Cambridge.
Copyright (c) 1997-2019 University of Cambridge All rights reserved.
Copyright(c) 2010-2019 Zoltan Herczeg All rights reserved.
Copyright(c) 2009-2019 Zoltan Herczeg All rights reserved.

Copyright (c) 2007-2012, Google Inc. All rights reserved.
Copyright (c) 1997-2019 University of Cambridge All rights reserved.
Copyright (c) 2007-2012, Google Inc. All rights reserved.
Copyright 1997-2013 University of Cambridge.
Copyright (c) 1997-2013 University of Cambridge.
Copyright (c) 1997-2020 University of Cambridge
Copyright (C) 1994 X Consortium
Copyright (C) 1996-2015 Free Software Foundation, Inc.
Copyright (C) 1999-2018 Free Software Foundation, Inc. Written by Tom Tromey <tromey@cygnus.com>.
Copyright 1992-2019 Free Software Foundation, Inc.
Copyright (C) 1999-2018 Free Software Foundation, Inc.
Copyright (C) 1996-2018 Free Software Foundation, Inc. Originally written by Fran,cois Pinard <pinard@iro.umontreal.ca>, 1996.
Copyright (C) 1996-2018 Free Software Foundation, Inc.
Copyright (C) 1994-2018 Free Software Foundation, Inc.
Copyright (c) 2001-2003 David Gravereaux.
Copyright (c) 1995-1996 Sun Microsystems, Inc.
Copyright (c) 2002 by David Gravereaux.
Copyright (c) 1999 Scriptics Corporation.
Copyright (c) 1999-2000 Ajuba Solutions.
Copyright (C) 1994-1996, 1999-2002, 2004-2011 Free Software Foundation, Inc.
Copyright (C) 1992-1996, 1998-2012 Free Software Foundation, Inc.
Copyright (C) 2011 Free Software Foundation, Inc.
Copyright (C) 2004-2015 Free Software Foundation, Inc.
Copyright (C) 2010-2015 Free Software Foundation, Inc.
Copyright 1992-2019 Free Software Foundation, Inc.
Copyright (C) 2002-2018 Free Software Foundation, Inc.
Copyright (C) 2001-2018 Free Software Foundation, Inc.
Copyright (C) 1997-2018 Free Software Foundation, Inc.
Copyright (C) 1999-2018 Free Software Foundation, Inc.
Copyright (C) 1996-2018 Free Software Foundation, Inc.
Copyright (C) 2003-2018 Free Software Foundation, Inc.
Copyright (C) 2009-2018 Free Software Foundation, Inc.
Copyright (C) 2006-2018 Free Software Foundation, Inc.
Copyright (C) 2004-2018 Free Software Foundation, Inc.
Copyright (C) 1996-2001, 2003-2015 Free Software Foundation, Inc. Written by Gordon Matzigkeit, 1996
Copyright (C) 2014 Free Software Foundation, Inc.
Copyright (C) 2011 Free Software Foundation, Inc.
Copyright (C) 2004-2005, 2007-2009, 2011-2015 Free Software Foundation, Inc. Written by Gary V. Vaughan, 2004
Copyright (C) 2004-2005, 2007-2008, 2011-2015 Free Software Foundation, Inc. Written by Gary V. Vaughan, 2004
Copyright (C) 2004, 2011-2015 Free Software Foundation, Inc. Written by Scott James Remnant, 2004
Copyright (C) 2004-2005, 2007, 2009, 2011-2015 Free Software Foundation, Inc. Written by Scott James Remnant, 2004.
Copyright (c) 2003-2008 Patrick Thoyts
Copyright (c) 1998-2000 Ajuba Solutions.
Copyright (c) 2001 ActiveState Corporation.
Copyright (c) 2001-2002 David Gravereaux.
Copyright (c) 2003 Pat Thoyts
Copyright (c) 2006 by Pat Thoyts
Copyright (c) 2002-2005 ActiveState Corporation.
Copyright (C) 2012 Free Software Foundation, Inc.
copyright (c) 1998, 1999, 2000, 2002, 2009 The Free Software Foundation, Inc.
Copyright (C) 2019 Free Software Foundation, Inc.

Copyright (C) 2012-2019 Free Software Foundation, Inc. Written by Ian Lance Taylor, Google
Copyright (C) 1997-2019 Free Software Foundation, Inc.
Copyright (C) 2003-2019 Free Software Foundation, Inc. Contributed by Paul Brook

LICENCE TERMS (cont.)

(c) yyunput(c, (ytext_ptr));Copyright (C) 2002-2019 Free Software Foundation, Inc.
Copyright (C) 2004-2019 Free Software Foundation, Inc.
Copyright (C) 2011-2019 Free Software Foundation, Inc.
Copyright %s 2019 Free Software Foundation, Inc.
Copyright %s 2019 Free Software Foundation, Inc.
Copyright (C) 2004-2019 Free Software Foundation, Inc.
Copyright (C) 2000-2019 Free Software Foundation, Inc.
Copyright (C) 2011-2019 Free Software Foundation, Inc. Contributed by Andi Kleen.
Copyright (C) 1992-2019 Free Software Foundation, Inc.
Copyright (C) 2001-2019 Free Software Foundation, Inc. Contributed by Axis Communications. Written by Hans-Peter Nilsson.
Copyright (C) 2009-2019 Free Software Foundation, Inc. Contributed by ARM Ltd.
Copyright (C) 2011-2019 Free Software Foundation, Inc. Contributed by ARM Ltd.
Copyright (C) 1996-2019 Free Software Foundation, Inc. Contributed by Richard Henderson.
Copyright (C) 1998-2019 Free Software Foundation, Inc.
Copyright (C) 2003-2019 Free Software Foundation, Inc.
Copyright (C) 2001-2019 Free Software Foundation, Inc. Contributed by Alexandre Oliva <aoliva@redhat.com>
Copyright (C) 2001-2019 Free Software Foundation, Inc.
Copyright (C) 1994-2019 Free Software Foundation, Inc. Contributed by Eric Youngdale. Modified for stabs-in-ELF by H.J. Lu.
Copyright (C) 2001-2019 Free Software Foundation, Inc. Contributed by Jan Hubicka <jh@suse.cz>, based on linux.h.
Copyright (C) 2002-2019 Free Software Foundation, Inc.
Copyright (C) 1995-2019 Free Software Foundation, Inc. Contributed by Eric Youngdale. Modified for stabs-in-ELF by H.J. Lu (hjl@lucon.org).
Copyright (C) 2011-2019 Free Software Foundation, Inc. Contributed by Walter Lee (walt@tilera.com)
Copyright (C) 1999-2019 Free Software Foundation, Inc. Contributed by Kazumoto Kojima <kkojima@rr.iij4u.or.jp>
Copyright (C) 2009-2019 Free Software Foundation, Inc.
Copyright (C) 2015-2019 Free Software Foundation, Inc. Contributed by Yoshinori Sato <ysato@users.sourceforge.jp>
Copyright (C) 2012-2019 Free Software Foundation, Inc. Contributed by Andes Technology Corporation.
Copyright (C) 2012-2019 Free Software Foundation, Inc. Contributed by Mentor Graphics, Inc.
Copyright (C) 1996-2019 Free Software Foundation, Inc. Contributed by Eddie C. Dost (ecd@skynet.be)
Copyright (C) 1996-2019 Free Software Foundation, Inc. Contributed by David S. Miller (davem@caip.rutgers.edu)
Copyright (C) 2007-2019 Free Software Foundation, Inc.
Copyright (C) 1999-2019 Free Software Foundation, Inc. Contributed by Red Hat Inc.
Copyright (C) 2018-2019 Free Software Foundation, Inc. Contributed by Stafford Horne.
Copyright (C) 2017-2019 Free Software Foundation, Inc.
Copyright (C) 1999-2019 Free Software Foundation, Inc. Contributed by Hartmut Penner (hpenner@de.ibm.com) and Ulrich Weigand (uweigand@de.ibm.com).
Copyright (C) 1996-2019 Free Software Foundation, Inc. Contributed by Michael Meissner (meissner@cygnus.com).
Copyright (C) 1995-2019 Free Software Foundation, Inc.
Copyright (C) 2013-2019 Free Software Foundation, Inc. Contributed by ARM Ltd.
Copyright (C) 2008-2019 Free Software Foundation, Inc.
Copyright (C) 1989-2019 Free Software Foundation, Inc.
Copyright (C) 2006-2019 Free Software Foundation, Inc. Contributed by CodeSourcery.
Copyright (C) 2016-2019 Free Software Foundation, Inc. Contributed by ARM Ltd.
Copyright (C) 2015-2019 Free Software Foundation, Inc. Contributed by ARM Ltd.
Copyright (C) 2013-2019 Free Software Foundation, Inc.
Copyright (C) 1994-2018 Free Software Foundation, Inc.
Copyright (C) 1987-2019 Free Software Foundation, Inc.
Copyright (C) 1992-2019 Free Software Foundation, Inc. Contributed by Ron Guilmette (rfg@monkeys.com)
Copyright (C) 2017 Free Software Foundation, Inc.
Copyright (C) 1990-2019 Free Software Foundation, Inc.
Copyright (C) 2012 Free Software Foundation, Inc.
Copyright (C) 1999-2019 Free Software Foundation, Inc.
Copyright (C) 1998, 1999, 2000, 2001, 2003, 2004, 2009, 2010, 2012 Free Software Foundation, Inc.

Copyright (C) 2002, 2007, 2009 Free Software Foundation, Inc.
Copyright (C) 1994-2017 Free Software Foundation, Inc.
Copyright (C) 2012 Free Software Foundation, Inc. Copyright (C) 1996, 1997, 1998, 1999, 2000, 2001, 2003, 2004, 2005, 2006, 2007, 2008, 2009 Free Software Foundation, Inc. Written by Gordon Matzigkeit, 1996
Copyright (C) 1996, 1997, 1998, 1999, 2000, 2001, 2003, 2004, 2005, 2006, 2007, 2008, 2009 Free Software Foundation, Inc. Written by Gordon Matzigkeit, 1996; Copyright (C) 1996, 1997, 1998, 1999, 2000, 2001, 2003, 2004, 2005, 2006, 2007, 2008, 2009 Free Software Foundation, Inc.
Copyright (C) 1994-2017 Free Software Foundation, Inc.; Copyright (C) 2012-2019 Free Software Foundation, Inc.; copyright notice, this list of conditions and the following disclaimer.; copyright notice, this list of conditions and the following disclaimer in the documentation and/or other materials provided with the distribution.
Copyright (C) 1990, 1991, 1992, 1993, 1994, 1995, 1996, 1997, 1998, 1999, 2000, 2001, 2002, 2003, 2004, 2005, 2006, 2007, 2008, 2009, 2010, 2011 Free Software Foundation
Copyright (C) 2003-2019 Free Software Foundation, Inc. Written by Ian Lance Taylor <ian@wasabisystems.com>.
Copyright (C) 2001-2019 Free Software Foundation, Inc.; Copyright (c) 1994 Hewlett-Packard Company; Copyright (c) 1996, 1997 Silicon Graphics Computer Systems, Inc.
Copyright (C) 2010-2019 Free Software Foundation, Inc.
Copyright (C) 2009-2019 Free Software Foundation, Inc.; © Brönnimann, Guillaume Melquiond, Sylvain Pion.
Copyright (C) 2015-2019 Free Software Foundation, Inc.
Copyright (C) 2006-2019 Free Software Foundation, Inc.
Copyright (C) 2001-2019 Free Software Foundation, Inc.; Copyright (c) 1994 Hewlett-Packard Company; Copyright (c) 1996-1998 Silicon Graphics Computer Systems, Inc.
Copyright (C) 2016-2019 Free Software Foundation, Inc.
Copyright (C) 2001-2019 Free Software Foundation, Inc.; Copyright (c) 1994 Hewlett-Packard Company; Copyright (c) 1997 Silicon Graphics Computer Systems, Inc.
Copyright (C) 2001-2019 Free Software Foundation, Inc.; Copyright (c) 1996, 1997 Silicon Graphics Computer Systems, Inc.; Copyright (c) 1994 Hewlett-Packard Company
Copyright (C) 2014-2019 Free Software Foundation, Inc.
Copyright (C) 2007-2019 Free Software Foundation, Inc.; Copyright (c) 2001, 2002, 2003 Peter Dimov and Multi Media Ltd.; Copyright (C) 1998, 1999 Greg Colvin and Beman Dawes.; Copyright (C) 2001, 2002, 2003 Peter Dimov; Copyright (C) 2001, 2002, 2003 Peter Dimov; Copyright (C) 2002 Peter Dimov
Copyright (C) 2001-2019 Free Software Foundation, Inc.; Copyright (c) 1994 Hewlett-Packard Company; Copyright (c) 1996 Silicon Graphics Computer Systems, Inc.
Copyright (C) 2001-2019 Free Software Foundation, Inc.
Copyright (C) 2001-2019 Free Software Foundation, Inc.; Copyright (c) 1994 Hewlett-Packard Company; Copyright (c) 1996, 1997 Silicon Graphics
Copyright (C) 2001-2019 Free Software Foundation, Inc.; Copyright (c) 1994 Hewlett-Packard Company; Copyright (c) 1996-1999 Silicon Graphics Computer Systems, Inc.
Copyright (C) 2001-2019 Free Software Foundation, Inc.; Copyright (c) 1996-1997 Silicon Graphics Computer Systems, Inc.
Copyright (C) 2004-2019 Free Software Foundation, Inc.; (C) Copyright Jeremy Siek 2000. Permission to copy, use, modify, sell and distribute this software is granted provided this
Copyright (C) 2009-2019 Free Software Foundation, Inc.
Copyright (C) 1997-2019 Free Software Foundation, Inc.; (c) outputs the contents of the buffer plus the character c.
27.5.2.4.5 Consume some sequence of the characters in the pending sequence. virtual int_type overflow(int_type __c = _Traits::eof());
Copyright (C) 2001-2019 Free Software Foundation, Inc.; Copyright (c) 1998 Silicon Graphics Computer Systems, Inc.
Copyright (C) 2001-2019 Free Software Foundation, Inc.; Copyright (c) 1996 Silicon Graphics Computer Systems, Inc.; Copyright (c) 1994 Hewlett-Packard Company
Copyright (C) 2001-2019 Free Software Foundation, Inc.; Copyright (c) 1996-1998 Silicon Graphics Computer Systems, Inc.; Copyright (c) 1994 Hewlett-Packard Company
Copyright (C) 2012-2019 Free Software Foundation, Inc.
Copyright (C) 2005-2019 Free Software Foundation, Inc.
Copyright (C) 2007-2019 Free Software Foundation, Inc.
Copyright (C) 1995-1998, 2000-2003 Free Software Foundation, Inc.
Copyright (C) 2018-2019 Free Software Foundation, Inc.
Copyright (C) 2006-2019 Free Software Foundation, Inc.; Copyright (C) 1996-2003 Gerard Jungman

LICENCE TERMS (cont.)

Copyright (C) 2001-2019 Free Software Foundation, Inc.; Copyright (c) 1997 Silicon Graphics Computer Systems, Inc.
Copyright (C) 2001-2019 Free Software Foundation, Inc.; Copyright (c) 1997-1999 Silicon Graphics Computer Systems, Inc.
Copyright (C) 2005-2019 Free Software Foundation, Inc.; Copyright (C) 2004 Ami Tavory and Vladimir Dreizin, IBM-HRL.
Copyright (C) 2002-2019 Free Software Foundation, Inc.; Copyright (c) 1994 Hewlett-Packard Company; Copyright (c) 1996 Silicon Graphics Computer Systems, Inc.
Copyright (C) 2005-2019 Free Software Foundation, Inc.; Copyright (C) 2004 Ami Tavory and Vladimir Dreizin, IBM-HRL. Copyright (c) 1996, 1997 Silicon Graphics Computer Systems, Inc.; Copyright (c) 1994 Hewlett-Packard Company
Copyright (C) 2011-2019 Free Software Foundation, Inc.; Copyright (C) 2011-2019 Free Software Foundation, Inc.; Copyright (C) 2000, 2001, 2002, 2007, 2008 Free Software Foundation, Inc.
Copyright (C) 2005-2019 Free Software Foundation, Inc. Contributed by Jakub Jelinek <jakub@redhat.com>.
Copyright (C) 1994-2017 Free Software Foundation, Inc.; Copyright (C) 2014-2018 Free Software Foundation, Inc.
Copyright (C) 2006-2019 Free Software Foundation, Inc.; Copyright (C) 2006-2019 Free Software Foundation, Inc.; Copyright (C) 2007 Free Software Foundation, Inc.
Copyright (C) 2005-2019 Free Software Foundation, Inc. Contributed by Richard Henderson <rth@redhat.com>.
Copyright (C) 1994 X Consortium
Copyright (C) 1996-2015 Free Software Foundation, Inc. This is free software
Copyright (C) 1999-2018 Free Software Foundation, Inc. Written by Tom Tromey <tromey@cygnus.com>.
Copyright 1992-2019 Free Software Foundation, Inc.
Copyright (C) 1999-2018 Free Software Foundation, Inc.
Copyright (C) 1996-2018 Free Software Foundation, Inc. Originally written by Fran,cois Pinard <pinard@iro.umontreal.ca>, 1996.
Copyright (C) 1994-1996, 1999-2002, 2004-2016 Free Software Foundation, Inc.
Copyright (C) 1992-1996, 1998-2012 Free Software Foundation, Inc.
Copyright (C) 1996-2018 Free Software Foundation, Inc.
Copyright (C) 1994-2018 Free Software Foundation, Inc.
Copyright (C) 1995-2003 Free Software Foundation, Inc.
Copyright (C) IBM Corp. 2004-2005
Copyright (C) IBM Corp. 2003-2005
Copyright (C) 2003 Eric J Bohm
Copyright (C) IBM Corp. 2003
Copyright (C) 1989, 1991 Free Software Foundation, Inc.
Copyright (C) 1991, 1999 Free Software Foundation, Inc.
Copyright (c) 1997--2002 Martin Mares <mj@ucw.cz>
Copyright (C) 2011 Free Software Foundation, Inc.
Copyright (C) 2004-2015 Free Software Foundation, Inc. This is free software
Copyright (C) 2010-2015 Free Software Foundation, Inc. This is free software
Copyright 1992-2019 Free Software Foundation, Inc.
Copyright (C) 2012 Free Software Foundation, Inc. This configure script is free software
Copyright (C) 2012 Free Software Foundation, Inc. This config.status script is free software
Copyright (C) 2014 Free Software Foundation, Inc. This is free software
Copyright (C) 2002-2018 Free Software Foundation, Inc.
Copyright (C) 2001-2018 Free Software Foundation, Inc.
Copyright (C) 1997-2018 Free Software Foundation, Inc.
Copyright (C) 1999-2018 Free Software Foundation, Inc.
Copyright (C) 1996-2018 Free Software Foundation, Inc.
Copyright (C) 2003-2018 Free Software Foundation, Inc.
Copyright (C) 2009-2018 Free Software Foundation, Inc.
Copyright (C) 2006-2018 Free Software Foundation, Inc.
Copyright (C) 2004-2018 Free Software Foundation, Inc.
Copyright (C) 1996-2001, 2003-2015 Free Software Foundation, Inc. Written by Gordon Matzigkeit, 1996
Copyright (C) 2011 Free Software Foundation, Inc. This config.lt script is free software
Copyright (C) 2004-2005, 2007-2009, 2011-2015 Free Software Foundation, Inc. Written by Gary V. Vaughan, 2004
Copyright (C) 2004-2005, 2007-2008, 2011-2015 Free Software Foundation, Inc. Written by Gary V. Vaughan, 2004

Copyright (C) 2004, 2011-2015 Free Software Foundation, Inc. Written by Scott James Remnant, 2004
Copyright (C) 2004-2005, 2007, 2009, 2011-2015 Free Software Foundation, Inc. Written by Scott James Remnant, 2004.
Copyright (C) 1994 X Consortium
Copyright (C) 1996-2015 Free Software Foundation, Inc.
Copyright (C) 1999-2018 Free Software Foundation, Inc. Written by Tom Tromey <tromey@cygnus.com>.
Copyright 1992-2019 Free Software Foundation, Inc.
Copyright (C) 1999-2018 Free Software Foundation, Inc.
Copyright (C) 2004-2005, 2007, 2009, 2011-2015 Free Software Foundation, Inc. Written by Scott James Remnant, 2004.
Copyright (C) 2004, 2011-2015 Free Software Foundation, Inc. Written by Scott James Remnant, 2004
Copyright (C) 1996-2001, 2003-2015 Free Software Foundation, Inc. Written by Gordon Matzigkeit, 1996
Copyright (C) 2004-2005, 2007-2008, 2011-2015 Free Software Foundation, Inc. Written by Gary V. Vaughan, 2004
Copyright (C) 2004-2005, 2007-2009, 2011-2015 Free Software Foundation, Inc. Written by Gary V. Vaughan, 2004
Copyright (C) 1996-2018 Free Software Foundation, Inc. Originally written by Fran,cois Pinard <pinard@iro.umontreal.ca>, 1996.
Copyright (C) 1994-1996, 1999-2002, 2004-2016 Free Software Foundation, Inc.
Copyright (C) 1996-2018 Free Software Foundation, Inc.
Copyright (c) 2008 Isilon Inc http://www.isilon.com/
Copyright (c) Copyright (c) Bull S.A. 2005 All Rights Reserved.
Copyright 1989 AT&T
Copyright (C) 1992-1996, 1998-2012 Free Software Foundation, Inc.
Copyright (C) 2011 Free Software Foundation, Inc.
Copyright (C) 1994-2018 Free Software Foundation, Inc.
Copyright (c) 2009, Sun Microsystems, Inc. All rights reserved.
Copyright (c) 1992 Sun Microsystems Inc. All rights reserved.
Copyright (c) 2010, Oracle America, Inc. All rights reserved.
Copyright (c) 2000 The Regents of the University of Michigan. All rights reserved.
Copyright (c) 2009, Sun Microsystems, Inc. All rights reserved.
Copyright (C) 2014 Red Hat, Steve Dickson <steved@redhat.com>
Copyright (c) 2013, Oracle America, Inc. All rights reserved.
Copyright (c) 1988 by Sun Microsystems, Inc.
Copyright (c) 1986 - 1991, 1994, 1996, 1997 by Sun Microsystems, Inc. All rights reserved.
(C) 1986 SMI
Copyright (c) 2001 Dima Dorfman. All rights reserved.
Copyright (c) 1996 Bill Paul <wpaul@ctr.columbia.edu>. All rights reserved.
Copyright (c) 2015, Axentia Technologies AB. All rights reserved.
Copyright (c) 2015, Oracle America, Inc. All rights reserved.
Copyright (c) 1997,98 The NetBSD Foundation, Inc. All rights reserved.
Copyright (c) 2001 Daniel Eischen <deischen@FreeBSD.org>. All rights reserved.
Copyright 2003 Niels Provos <provos@citi.umich.edu> All rights reserved.
Copyright 1989 AT&T Dd May 7, 1993
Copyright 1989 AT&T Dd April 22, 2000
Copyright (C) 1992 Eric Young
Copyright (c) 2018, Oracle America, Inc. All rights reserved.
Copyright 1989 AT&T Dd December 10, 1991
Copyright (c) 2010, Oracle America, Inc.
Copyright (C) 2004-2015 Free Software Foundation, Inc.
Copyright (C) 2010-2015 Free Software Foundation, Inc.
Copyright 1992-2019 Free Software Foundation, Inc.
Copyright (C) 2014 Free Software Foundation, Inc.
Copyright (C) 2011 Free Software Foundation, Inc.
Copyright (C) 2002-2018 Free Software Foundation, Inc.
Copyright (C) 2001-2018 Free Software Foundation, Inc.
Copyright (C) 1997-2018 Free Software Foundation, Inc.
Copyright (C) 1999-2018 Free Software Foundation, Inc.
Copyright (C) 1996-2018 Free Software Foundation, Inc.

LICENCE TERMS (cont.)

Copyright (C) 2003-2018 Free Software Foundation, Inc.
Copyright (C) 2009-2018 Free Software Foundation, Inc.
Copyright (C) 2006-2018 Free Software Foundation, Inc.
Copyright (C) 2004-2018 Free Software Foundation, Inc.
Copyright (C) 1996-2001, 2003-2015 Free Software Foundation, Inc. Written by Gordon Matzigkeit, 1996
Copyright (C) 2004-2005, 2007-2009, 2011-2015 Free Software Foundation, Inc. Written by Gary V. Vaughan, 2004
Copyright (C) 2004-2005, 2007-2008, 2011-2015 Free Software Foundation, Inc. Written by Gary V. Vaughan, 2004
Copyright (C) 2004, 2011-2015 Free Software Foundation, Inc. Written by Scott James Remnant, 2004
Copyright (C) 2004-2005, 2007, 2009, 2011-2015 Free Software Foundation, Inc. Written by Scott James Remnant, 2004.
Copyright (c) 1988 Sun Microsystems, Inc. - All Rights Reserved.
Copyright (c) 1988 Sun Microsystem's, Inc. - All Right's Reserved.
Copyright (C) 2012 Free Software Foundation, Inc.
Copyright (C) 2012 Free Software Foundation, Inc.
Copyright (c) 1988 Sun Microsystems, Inc. - All Rights Reserved.
Copyright (c) 1988 Sun Microsystems, Inc. - All Rights Reserved.
Copyright (c) 1985 by Sun Microsystems, Inc.
Copyright (C) 1984, Sun Microsystems, Inc.
Copyright (c) 2000 Dug Song <dugsong@UMICH.EDU>. All rights reserved, all wrongs reversed.
Copyright (c) 2000 Dug Song <dugsong@UMICH.EDU>. All rights reserved, all wrongs reversed.
Copyright (c) 1988 by Sun Microsystems, Inc.
Copyright (c) 1986 by Sun Microsystems, Inc.
Copyright (c) 1986-1991 by Sun Microsystems Inc.
Copyright (c) 2009, Sun Microsystems, Inc. All rights reserved.
Copyright (c) 1984 - 1991 by Sun Microsystems, Inc.
Copyright (C) 1986-1993 by Sun Microsystems, Inc.
Copyright (c) 1986 - 1991 by Sun Microsystems, Inc.
Copyright (C) 1986, Sun Microsystems, Inc.
Copyright (c) 1990, 1991 Sun Microsystems, Inc.
Copyright (C) 1986, Sun Microsystems, Inc.
Copyright (c) 2009, Sun Microsystems, Inc. All rights reserved.
Copyright (c) 1989 by Sun Microsystems, Inc.
Copyright (c) 1984 by Sun Microsystems, Inc.
Copyright (C) 1990, 1991 Sun Microsystems, Inc.
Copyright (C) 1987, Sun Microsystems, Inc.
Copyright 1991 Sun Microsystems, Inc.
Copyright (c) 1986-1991 by Sun Microsystems Inc.
Copyright (C) 1984, 1988, Sun Microsystems, Inc.
Copyright (c) 1987 by Sun Microsystems, Inc.
Copyright(C) 1996, Jason Downs. All rights reserved.
Copyright (C) 1988, Sun Microsystems, Inc.
Copyright 1990 Sun Microsystems, Inc.
Copyright (C) 1994 X Consortium
Copyright (C) 1996-2015 Free Software Foundation, Inc. This is free software

Copyright 1992-2019 Free Software Foundation, Inc.
Copyright (C) 1999-2018 Free Software Foundation, Inc.
Copyright (C) 2004-2005, 2007, 2009, 2011-2015 Free Software Foundation, Inc. Written by Scott James Remnant, 2004.
Copyright (C) 2004, 2011-2015 Free Software Foundation, Inc. Written by Scott James Remnant, 2004
Copyright (C) 1996-2001, 2003-2015 Free Software Foundation, Inc. Written by Gordon Matzigkeit, 1996
Copyright (C) 2004-2005, 2007-2008, 2011-2015 Free Software Foundation, Inc. Written by Gary V. Vaughan, 2004
Copyright (C) 2004-2005, 2007-2009, 2011-2015 Free Software Foundation, Inc. Written by Gary V. Vaughan, 2004
Copyright (C) 1996-2018 Free Software Foundation, Inc. Originally written by Fran.cois Pinard <pinard@iro.umontreal.ca>, 1996.
Copyright (C) 2011-2018 Free Software Foundation, Inc.
Copyright (C) 2007 Free Software Foundation, Inc.

Copyright @copyright{} 2000, 2001, 2002, 2007, 2008 Free Software Foundation, Inc.
Copyright 1996-2018 Free Software Foundation, Inc.
Copyright (C) 1994-1996, 1999-2002, 2004-2016 Free Software Foundation, Inc.
Copyright (C) 2004-2014, 2016 Free Software Foundation, Inc.
Copyright 1985, 1986, 1988, 1990, 1991, 1992, 1993, 1994, 1995, 1996, 1997, 1998, 1999, 2000, 2001, 2002, 2003, 2004, 2005, 2006, 2007, 2008, 2009, 2010, 2011, 2012, 2013, 2014, 2015, 2016, 2017, 2018 Free Software Foundation, Inc.
Copyright (C) 1995-2018 Free Software Foundation, Inc. written by Ulrich Drepper <drepper@gnu.ai.mit.edu>, June 1995
Copyright (C) 2009 Free Software Foundation, Inc.
Copyright (C) 2002, 2006-2007, 2009-2018 Free Software Foundation, Inc.
Copyright (C) 2003, 2005-2018 Free Software Foundation, Inc.
Copyright (C) 2001-2002, 2006-2018 Free Software Foundation, Inc.
Copyright (C) 2007-2018 Free Software Foundation, Inc.
Copyright (C) 2006-2018 Free Software Foundation, Inc.
Copyright (C) 2002, 2006-2018 Free Software Foundation, Inc.
Copyright (C) 2002-2004, 2006-2007, 2009-2018 Free Software Foundation, dnl Inc.
Copyright (C) 2010-2018 Free Software Foundation, Inc.
Copyright (C) 2000-2002, 2007-2014, 2016-2018 Free Software Foundation, dnl Inc.
Copyright (C) 1996-1998, 2001-2004, 2009-2018 Free Software Foundation, Inc.
Copyright (C) 2003-2004, 2006-2007, 2009-2018 Free Software Foundation, dnl Inc.
Copyright (C) 2005, 2007, 2009-2018 Free Software Foundation, Inc.
Copyright (C) 2007, 2009-2018 Free Software Foundation, Inc.
Copyright (C) 2002-2018 Free Software Foundation, Inc.
Copyright (C) 2009-2018 Free Software Foundation, Inc.
Copyright (C) 2009-2018 Free Software Foundation, Inc.
Copyright (C) 2008-2018 Free Software Foundation, Inc.
Copyright (C) 2006, 2008-2018 Free Software Foundation, Inc.
Copyright (C) 2007-2018 Free Software Foundation, Inc.
Copyright (C) 2005-2018 Free Software Foundation, Inc.
Copyright (C) 1995-2018 Free Software Foundation, Inc.
Copyright (C) 2009-2018 Free Software Foundation, Inc. Written by Bruno Haible <bruno@clisp.org>, 2009.
Copyright (C) 2002-2018 Free Software Foundation, Inc.
Copyright (C) 2002-2006, 2009-2018 Free Software Foundation, Inc.
Copyright (C) 2001-2005, 2008-2018 Free Software Foundation, Inc.
Copyright (C) 2011-2018 Free Software Foundation, Inc.
Copyright (C) 2003, 2005-2007, 2009-2018 Free Software Foundation, Inc.
Copyright (C) 2002, 2006, 2009-2018 Free Software Foundation, Inc. Written by Bruno Haible <bruno@clisp.org>, 2009.
Copyright (C) 2002-2004, 2006-2018 Free Software Foundation, Inc.
Copyright (C) 2007-2008, 2010-2018 Free Software Foundation, Inc.
Copyright (C) 2003, 2007-2018 Free Software Foundation, Inc.
Copyright (C) 2008-2018 Free Software Foundation, Inc.
Copyright (C) 2002-2003, 2008-2018 Free Software Foundation, Inc.
Copyright 2016-2018 Free Software Foundation, Inc.
Copyright (C) 1997-2004, 2006, 2008-2018 Free Software Foundation, Inc.
Copyright (C) 2002, 2006-2007, 2009-2018 Free Software Foundation, Inc. Written by Bruno Haible <bruno@clisp.org>, 2009.
Copyright (C) 2008, 2010-2018 Free Software Foundation, Inc.
Copyright (C) 1997-2002, 2006, 2008-2018 Free Software Foundation, Inc.
Copyright (C) 2006, 2009-2018 Free Software Foundation, Inc.
Copyright (C) 2016-2018 Free Software Foundation, Inc.
Copyright (C) 2000-2001, 2003-2007, 2009-2018 Free Software Foundation, Inc.
Copyright (C) 2017-2018 Free Software Foundation, Inc.
Copyright (C) 2001-2003, 2006, 2010-2018 Free Software Foundation, Inc.
Copyright (C) 2000-2002, 2004, 2008, 2010-2018 Free Software Foundation, dnl Inc.
Copyright (C) 2012-2018 Free Software Foundation, Inc.

LICENCE TERMS (cont.)

Copyright (C) 2003-2004, 2008-2018 Free Software Foundation, Inc.
Copyright (C) 2003, 2006-2018 Free Software Foundation, Inc.
Copyright (C) 2002, 2007-2018 Free Software Foundation, Inc.
Copyright (C) 2002-2004, 2009-2018 Free Software Foundation, Inc.
Copyright (C) 1996-2003, 2009-2018 Free Software Foundation, Inc.
Copyright (C) 2005, 2008-2018 Free Software Foundation, Inc.
Copyright (C) 2004, 2006, 2008-2018 Free Software Foundation, Inc.
Copyright (C) 2000-2002, 2008-2018 Free Software Foundation, Inc.
Copyright (C) 2001-2018 Free Software Foundation, Inc.
Copyright (C) 1997-2004, 2006-2007, 2009-2018 Free Software Foundation, dnl Inc.
Copyright (C) 1999-2007, 2009-2018 Free Software Foundation, Inc.
Copyright (C) 2005-2007, 2009-2018 Free Software Foundation, Inc.
Copyright (C) 2005, 2009-2018 Free Software Foundation, Inc.
Copyright (C) 2006, 2009-2018 Free Software Foundation, Inc.
Copyright (C) 2003, 2009-2018 Free Software Foundation, Inc.
Copyright (C) 2000-2002, 2006, 2008-2014, 2016 Free Software Foundation, dnl Inc.
Copyright (C) 2001-2004, 2006-2018 Free Software Foundation, Inc.
Copyright 2011-2018 Free Software Foundation, Inc.
Copyright (C) 2001-2002, 2004-2005, 2008-2018 Free Software Foundation, dnl Inc.
Copyright (C) 2002, 2004, 2006, 2009-2018 Free Software Foundation, Inc.
Copyright (C) 2007, 2009-2018 Free Software Foundation, Inc.
Copyright 2012-2018 Free Software Foundation, Inc.
Copyright (C) 2001-2003, 2005-2018 Free Software Foundation, Inc. Written by Bruno Haible <bruno@clisp.org>, 2001.
Copyright (C) 2010-2018 Free Software Foundation, Inc.
Copyright (C) 2003, 2005-2006, 2008-2018 Free Software Foundation, Inc.
Copyright (C) 1999-2002, 2005-2018 Free Software Foundation, Inc. Written by Bruno Haible <bruno@clisp.org>, 2008.
Copyright 2016-2018 Free Software Foundation, Inc.
Copyright (C) 2010-2018 Free Software Foundation, Inc. Written by Ben Pfaff <blp@cs.stanford.edu>, 2010.
Copyright (C) 2001-2003, 2006-2018 Free Software Foundation, Inc. Written by Ben Pfaff <blp@cs.stanford.edu>, 2010, based on code written by Bruno Haible <bruno@clisp.org>, 2009.
Copyright (C) 1995-2002, 2004-2005, 2008-2014, 2016 Free Software dnl Foundation, Inc.
Copyright (C) 2002, 2004-2005, 2007, 2009-2018 Free Software Foundation, dnl Inc.
Copyright (C) 2003-2018 Free Software Foundation, Inc.
Copyright (C) 2009, 2016, 2018 Free Software Foundation, Inc.
Copyright (C) 1996-2018 Free Software Foundation, Inc.
Copyright (C) 2006-2007, 2010-2018 Free Software Foundation, Inc.
Copyright (C) 2006-2011 Free Software Foundation, Inc.
Copyright (C) 2001-2002, 2004-2010 Free Software Foundation, Inc.
Copyright (C) 1994-2018 Free Software Foundation, Inc.
Copyright (C) 2001-2018 Free Software Foundation, Inc.
Copyright (C) 2000-2003, 2006, 2008-2018 Free Software Foundation, Inc.
Copyright (C) 2008-2018 Free Software Foundation, Inc. This file is part of the GNU C Library. Written by Eric Blake <ebb9@byu.net>, 2008.:(c) A macro that canonicalizes an element right after it has been fetched from one of the two strings. The argument is an 'unsigned char'; the result must be an 'unsigned char' as well.:(c) c endif ifndef CMP_FUNC define CMP_FUNC memcmp endif
Copyright (C) 1992-1996, 1998-2012 Free Software Foundation, Inc.
Copyright (C) 2006, 2008 Free Software Foundation, Inc.
Copyright (C) 2001-2002, 2009-2018 Free Software Foundation, Inc. Written by Bruno Haible <bruno@clisp.org>, 2009.
Copyright (C) 2001-2002, 2006, 2009-2018 Free Software Foundation, Inc. Written by Bruno Haible <bruno@clisp.org>, 2002.
Copyright (C) 1999-2005 Patrice Dumas <dumas@centre-cired.fr>, Derek Price <derek@ximbiot.com>, Adrian Aichner <adrian@xemacros.org>, others.
Copyright (C) 2001-2002, 2006-2007, 2009-2018 Free Software Foundation, Inc. Written by Bruno Haible <bruno@clisp.org>, 2002.

Copyright (C) 2009 Free Software Foundation, Inc.
Copyright (C) 2006, 2009 Free Software Foundation, Inc. Written by Bruno Haible <bruno@clisp.org>, 2006.
Copyright (C) 2006, 2011-2012 Free Software Foundation, Inc. Written by Bruno Haible <bruno@clisp.org>, 2006.
Copyright (C) 2001-2002, 2005-2007, 2009-2018 Free Software Foundation, Inc. Written by Bruno Haible <bruno@clisp.org>, 2002.
Copyright (C) 2001-2002, 2006-2018 Free Software Foundation, Inc. Written by Bruno Haible <bruno@clisp.org>, 2002.
Copyright (C) 2007-2018 Free Software Foundation, Inc. Written by Bruno Haible <bruno@clisp.org>, 2007.
Copyright (C) 2009-2010 Free Software Foundation, Inc. dnl dnl This program is free software: you can redistribute it and/or modify dnl it under the terms of the GNU General Public License as published by dnl the Free Software Foundation; either version 3 of the License, or dnl (at your option) any
Copyright @copyright{} 2007 Free Software Foundation, Inc. @url{http://fsf.org/}
Copyright © 2007 Free Software Foundation, Inc. <http://fsf.org/>
Copyright (C) 2009, 2011, 2017 Free Software Foundation, Inc.
Copyright (C) 1992-2009 Free Software Foundation, Inc. dnl This file is free software, distributed under the terms of the GNU dnl General Public License. As a special exception to the GNU General dnl Public License, this file may be distributed as part of a program dnl that contains a configuration
Copyright (C) 2006, 2009 Free Software Foundation, Inc. dnl This file is free software; the Free Software Foundation dnl gives unlimited permission to copy and/or distribute it, dnl with or without modifications, as long as this notice is preserved.
Copyright (C) 2005-2006, 2011, 2015-2016 Free Software Foundation, Inc. dnl This file is free software; the Free Software Foundation dnl gives unlimited permission to copy and/or distribute it, dnl with or without modifications, as long as this notice is preserved.
Copyright (C) 1991, 1993, 1996-1997, 1999-2000, 2003-2004, 2006, 2008-2018 Free Software Foundation, Inc.
Copyright (C) 2001, 2005-2007, 2009-2018 Free Software Foundation, Inc.:(c) tests whether the single-byte character c is in the ISO C "basic character set". This is a convenience function, and is in this file only to share code between mbiter_multi.h and mbfile_multi.h. */ if ('' == 32) && ('!' == 33) && ('"' == 34) && ('#' == 35) \ 37) && ('&
Copyright (C) 2000, 2009-2018 Free Software Foundation, Inc.
Copyright (C) 2003-2006, 2008-2018 Free Software Foundation, Inc. Written by Bruno Haible <bruno@clisp.org>, 2003.:(C) tests whether C is a directory separator character. IS_PATH_WITH_DIR(P) tests whether P contains a directory specification.
Copyright (C) 2001-2018 Free Software Foundation, Inc.
Copyright (C) 1999, 2002-2018 Free Software Foundation, Inc.
Copyright (C) 2003, 2006-2007, 2009-2018 Free Software Foundation, Inc. Written by Bruno Haible <bruno@clisp.org>, 2003, 2018.
Copyright (C) 2002, 2005-2018 Free Software Foundation, Inc.
Copyright (C) 1999-2002, 2006-2007, 2009-2018 Free Software Foundation, Inc. Written by Bruno Haible <bruno@clisp.org>, 2001.
Copyright (C) 2002, 2006-2007, 2009-2018 Free Software Foundation, Inc. Written by Bruno Haible <bruno@clisp.org>, 2002.
Copyright (C) 2001-2002, 2006-2007, 2009-2018 Free Software Foundation, Inc. Written by Bruno Haible <bruno@clisp.org>, 2001.
Copyright (C) 1999, 2002, 2006, 2009-2018 Free Software Foundation, Inc. Written by Bruno Haible <bruno@clisp.org>, 2002.
Copyright (C) 2002, 2005-2006, 2009-2018 Free Software Foundation, Inc. Written by Bruno Haible <bruno@clisp.org>, 2002.
Copyright (C) 1999, 2002, 2006-2007, 2009-2018 Free Software Foundation, Inc. Written by Bruno Haible <bruno@clisp.org>, 2002.
Copyright (C) 1997-2000, 2002-2004, 2006, 2009-2018 Free Software Foundation, Inc.
Copyright (C) 2011-2018 Free Software Foundation, Inc. Written by Bruno Haible <bruno@clisp.org>, 2011.
Copyright 2011-2018 Free Software Foundation, Inc.
Copyright (C) 1992, 1995-2002, 2005-2018 Free Software Foundation, Inc. This file is part of the GNU C Library.
Copyright (C) 2002, 2006, 2009-2018 Free Software Foundation, Inc. Written by Bruno Haible <bruno@clisp.org>, 2002.
Copyright (C) 1999-2000, 2002, 2006-2007, 2009-2018 Free Software Foundation, Inc. Written by Bruno Haible <bruno@clisp.org>, 2002.
Copyright (C) 1992, 1995-2003, 2005-2018 Free Software Foundation, Inc. This file is part of the GNU C Library.

LICENCE TERMS (cont.)

Copyright (C) 2006-2007, 2009-2018 Free Software Foundation, Inc.
Copyright (C) 1999, 2002, 2006, 2009-2018 Free Software Foundation, Inc. Written by Bruno Haible <bruno@clisp.org>, 2002.;(c) c include "str-kmp.h"
Copyright (C) 2004, 2007-2018 Free Software Foundation, Inc.
Copyright (C) 1999, 2002, 2006, 2010-2018 Free Software Foundation, Inc. Written by Bruno Haible <bruno@clisp.org>, 2002, 2005.
Copyright (C) 2015-2018 Free Software Foundation, Inc.
Copyright (C) 1999, 2002, 2006, 2010-2018 Free Software Foundation, Inc. Written by Bruno Haible <bruno@clisp.org>, 2002.
Copyright (C) 2007, 2009-2018 Free Software Foundation, Inc. Written by Bruno Haible <bruno@clisp.org>, 2007.
Copyright (C) 1999, 2002, 2006, 2010-2018 Free Software Foundation, Inc. Written by Bruno Haible <bruno@clisp.org>, 2002.;(c) c include "str-kmp.h"
Copyright (C) 1998-1999, 2005-2006, 2009-2018 Free Software Foundation, Inc.
Copyright (C) 1991-1994, 1996-1998, 2000, 2004, 2007-2018 Free Software Foundation, Inc. This file is part of the GNU C Library.
Copyright (C) 2002-2003, 2007-2018 Free Software Foundation, Inc.
Copyright (C) 1999, 2002, 2006-2007, 2009-2018 Free Software Foundation, Inc.
Copyright (C) 1999-2000, 2002, 2006-2007, 2009-2018 Free Software Foundation, Inc.
Copyright (C) 1999, 2002, 2005-2007, 2009-2018 Free Software Foundation, Inc.
Copyright (C) 2005, 2007, 2009-2018 Free Software Foundation, Inc.
Copyright 2009-2018 Free Software Foundation, Inc.
Copyright (C) 1999, 2002, 2006-2018 Free Software Foundation, Inc.
Copyright (C) 1999, 2002, 2005, 2007, 2009-2018 Free Software Foundation, Inc.
Copyright (C) 2004, 2006-2018 Free Software Foundation, Inc.
Copyright (C) 2012-2018 Free Software Foundation, Inc.
Copyright (C) 1990-2000, 2003-2004, 2006-2018 Free Software Foundation, Inc.
Copyright (C) 2006-2018 Free Software Foundation, Inc.
Copyright (C) 2000-2001, 2004-2006, 2009-2018 Free Software Foundation, Inc.
Copyright (C) 2009-2018 Free Software Foundation, Inc. Written by Eric Blake <ebb9@byu.net>, 2009.
Copyright (C) 2008, 2010-2018 Free Software Foundation, Inc. Written by Bruno Haible <bruno@clisp.org>, 2008.
Copyright (C) 2001-2018 Free Software Foundation, Inc.
Copyright (C) 2018 Free Software Foundation, Inc.
Copyright (C) 1990-2000, 2002-2006, 2008-2018 Free Software Foundation, Inc.
Copyright (C) 2004, 2007-2018 Free Software Foundation, Inc. Written by Bruno Haible and Eric Blake
Copyright (C) 2000-2003, 2005, 2007, 2009-2018 Free Software Foundation, Inc.
Copyright (C) 2005-2006, 2009-2018 Free Software Foundation, Inc. Written by Simon Josefsson.
Copyright (C) 2002, 2009-2018 Free Software Foundation, Inc.
Copyright (C) 2005-2018 Free Software Foundation, Inc. Written by Bruno Haible <bruno@clisp.org>, 2005.;(c) A macro that canonicalizes an element right after it has been fetched from needle or haystack. The argument is of type UNIT; the result must be of type UNIT as well. */
Copyright (C) 2002, 2005, 2007, 2009-2018 Free Software Foundation, Inc.
Copyright (C) 1995, 2001-2004, 2006-2018 Free Software Foundation, Inc.
Copyright (C) 2009-2011 Free Software Foundation, Inc.
Copyright (C) 2005-2018 Free Software Foundation, Inc.
Copyright (C) 1999, 2003-2004, 2009-2018 Free Software Foundation, Inc.
Copyright (C) 2001-2002, 2005-2018 Free Software Foundation, Inc.
Copyright (C) 2000-2003, 2009-2018 Free Software Foundation, Inc. This file is part of the GNU CHARSET Library.
Copyright (C) 2005-2006, 2009-2018 Free Software Foundation, Inc.
Copyright (C) 1990, 1998-2001, 2003-2006, 2009-2018 Free Software Foundation, Inc.
Copyright (C) 2009-2018 Free Software Foundation, Inc.
Copyright (C) 2002, 2005-2006, 2009-2018 Free Software Foundation, Inc.
Copyright (C) 2000-2002, 2005-2007, 2009-2018 Free Software Foundation, Inc.
Copyright (C) 2000-2006, 2008-2018 Free Software Foundation, Inc.
Copyright (C) 1995-1996, 2001-2018 Free Software Foundation, Inc.
Copyright (C) 2001, 2006, 2009-2018 Free Software Foundation, Inc.
Copyright (C) 2000-2002, 2005, 2007, 2009-2018 Free Software Foundation, Inc.
Copyright (C) 2007-2009 Free Software Foundation, Inc.

Copyright (C) 2007 Free Software Foundation, Inc.
Copyright (C) 2007 Free Software Foundation, Inc.
Copyright (C) 2007 Free Software Foundation, Inc.
Copyright (C) 2001-2002, 2005, 2007, 2009-2018 Free Software Foundation, Inc.
Copyright (C) 2007 Free Software Foundation, Inc.
Copyright (C) 2002, 2005-2007, 2009-2018 Free Software Foundation, Inc.
Copyright (C) 2011 Free Software Foundation, Inc.
Copyright (C) 2007-2009, 2011 Free Software Foundation, Inc.
Copyright (C) 2007-2008, 2010-2018 Free Software Foundation, Inc.
Copyright (C) 2002, 2005, 2007-2018 Free Software Foundation, Inc. Written by Bruno Haible.
Copyright (C) 2007 Free Software Foundation, Inc.
Copyright (C) 2007 Free Software Foundation, Inc.
Copyright (C) 1999-2000, 2002-2003, 2006-2018 Free Software Foundation, Inc.
Copyright (C) 2007 Free Software Foundation, Inc.
Copyright (C) 2006, 2009 Free Software Foundation, Inc.
Copyright (C) 2011 Free Software Foundation, Inc. Written by Bruno Haible <bruno@clisp.org>, 2011.
Copyright (C) 2007 Free Software Foundation, Inc.
Copyright (C) 2009-2010 Free Software Foundation, Inc. Written by Bruno Haible <bruno@clisp.org>, 2009.
Copyright (C) 2007 Free Software Foundation, Inc.
Copyright (C) 2001-2003, 2006-2018 Free Software Foundation, Inc. Written by Bruno Haible <bruno@clisp.org>, 2001.
Copyright (C) 2007 Free Software Foundation, Inc.
Copyright (C) 2007 Free Software Foundation, Inc.
Copyright (C) 2007 Free Software Foundation, Inc.
Copyright (C) 2007 Free Software Foundation, Inc.
Copyright (C) 2000-2002, 2004, 2008 Free Software Foundation, Inc.
Copyright (C) 2007 Free Software Foundation, Inc.
Copyright (C) 2007-2011 Free Software Foundation, Inc.
Copyright (C) 2007 Free Software Foundation, Inc.
Copyright (C) 2007 Free Software Foundation, Inc.
Copyright (C) 2007 Free Software Foundation, Inc.
Copyright (C) 2007 Free Software Foundation, Inc.
Copyright (C) 1997-1999, 2002-2004, 2006-2007, 2009-2018 Free Software Foundation, Inc.
Copyright (C) 2007 Free Software Foundation, Inc.
Copyright (C) 2002, 2006-2007, 2009-2018 Free Software Foundation, Inc. Written by Bruno Haible <bruno@clisp.org>, 2011.
Copyright (C) 2007 Free Software Foundation, Inc.
Copyright (C) 2007 Free Software Foundation, Inc.
Copyright (C) 2002, 2006-2007, 2011-2018 Free Software Foundation, Inc. Written by Bruno Haible <bruno@clisp.org>, 2002.
Copyright (C) 2007 Free Software Foundation, Inc.
Copyright (C) 2007 Free Software Foundation, Inc.
Copyright (C) 2007 Free Software Foundation, Inc.
Copyright (C) 2002, 2006-2007, 2011-2018 Free Software Foundation, Inc. Written by Bruno Haible <bruno@clisp.org>, 2011.
Copyright (C) 2007 Free Software Foundation, Inc.;(c) uc_is_property_lowercase (c) include "test-predicate-part2.h"
Copyright (C) 2007 Free Software Foundation, Inc.;(c) uc_is_general_category (c, UC_CATEGORY_Lm) include "test-predicate-part2.h"
Copyright (C) 2007 Free Software Foundation, Inc.;(c) uc_is_property_changes_when_casefolded (c) include "test-predicate-part2.h"
Copyright (C) 2007 Free Software Foundation, Inc.;(c) uc_is_property_math (c) include "test-predicate-part2.h"
Copyright (C) 2007 Free Software Foundation, Inc.;(c) uc_is_general_category (c, UC_CATEGORY_ZI) include "test-predicate-part2.h"
Copyright (C) 2007 Free Software Foundation, Inc.;(c) uc_is_property_id_continue (c) include "test-predicate-part2.h"
Copyright (C) 2007 Free Software Foundation, Inc.;(c) uc_is_property_format_control (c) include "test-predicate-part2.h"

LICENCE TERMS (cont.)

Copyright (C) 2007 Free Software Foundation, Inc.:(c) uc_is_general_category (c, UC_CATEGORY_N) include "test-predicate-part2.h"

Copyright (C) 2007 Free Software Foundation, Inc.:(c) uc_is_property_left_of_pair (c) include "test-predicate-part2.h"

Copyright (C) 2002, 2006, 2011-2018 Free Software Foundation, Inc. Written by Bruno Haible <bruno@clisp.org>, 2002.

Copyright (C) 2007 Free Software Foundation, Inc.:(c) uc_is_property_zero_width (c) include "test-predicate-part2.h"

Copyright (C) 2007 Free Software Foundation, Inc.:(c) uc_is_general_category (c, UC_CATEGORY_S) include "test-predicate-part2.h"

Copyright (C) 2007 Free Software Foundation, Inc.:(c) uc_is_general_category (c, UC_CATEGORY_Pf) include "test-predicate-part2.h"

Copyright (C) 2007 Free Software Foundation, Inc.:(c) uc_is_cntrl (c) include "test-predicate-part2.h"

Copyright (C) 2007 Free Software Foundation, Inc.:(c) uc_is_general_category (c, UC_CATEGORY_Sc) include "test-predicate-part2.h"

Copyright (C) 2007 Free Software Foundation, Inc.:(c) uc_is_lower (c) include "test-predicate-part2.h"

Copyright (C) 2007 Free Software Foundation, Inc.:(c) uc_is_property_bidi_whitespace (c) include "test-predicate-part2.h"

Copyright (C) 2007 Free Software Foundation, Inc.:(c) uc_is_upper (c) include "test-predicate-part2.h"

Copyright (C) 2007 Free Software Foundation, Inc.:(c) uc_is_property_titlecase (c) include "test-predicate-part2.h"

Copyright (C) 2007 Free Software Foundation, Inc.:(c) uc_is_general_category (c, UC_CATEGORY_M) include "test-predicate-part2.h"

Copyright (C) 2007 Free Software Foundation, Inc.:(c) uc_is_general_category (c, UC_CATEGORY_Pc) include "test-predicate-part2.h"

Copyright (C) 2007 Free Software Foundation, Inc.:(c) uc_is_property_bidi_embedding_or_override (c) include "test-predicate-part2.h"

Copyright (C) 2007 Free Software Foundation, Inc.:(c) uc_is_general_category (c, UC_CATEGORY_Cc) include "test-predicate-part2.h"

Copyright (C) 2007 Free Software Foundation, Inc.:(c) uc_is_property_deprecated (c) include "test-predicate-part2.h"

Copyright (C) 2007 Free Software Foundation, Inc.:(c) uc_is_property_other_grapheme_extend (c) include "test-predicate-part2.h"

Copyright (C) 2007 Free Software Foundation, Inc.:(c) uc_is_print (c) include "test-predicate-part2.h"

Copyright (C) 2007 Free Software Foundation, Inc.:(c) uc_is_general_category (c, UC_CATEGORY_Z) include "test-predicate-part2.h"

Copyright (C) 2007 Free Software Foundation, Inc.

Copyright (C) 2007 Free Software Foundation, Inc.:(c) uc_is_property_white_space (c) include "test-predicate-part2.h"

Copyright (C) 2007 Free Software Foundation, Inc.:(c) uc_is_property_changes_when_titlecased (c) include "test-predicate-part2.h"

Copyright (C) 2007 Free Software Foundation, Inc.:(c) uc_is_property_other_alphabetic (c) include "test-predicate-part2.h"

Copyright (C) 2007 Free Software Foundation, Inc.:(c) uc_is_property_bidi_segment_separator (c) include "test-predicate-part2.h"

Copyright (C) 2007 Free Software Foundation, Inc.:(c) uc_is_property_diacritic (c) include "test-predicate-part2.h"

Copyright (C) 2007 Free Software Foundation, Inc.:(c) uc_is_property_other_default_ignorable_code_point (c) include "test-predicate-part2.h"

Copyright (C) 2007 Free Software Foundation, Inc.:(c) uc_is_property_ideographic (c) include "test-predicate-part2.h"

Copyright (C) 2007 Free Software Foundation, Inc.:(c) uc_is_property_pattern_syntax (c) include "test-predicate-part2.h"

Copyright (C) 2007 Free Software Foundation, Inc.:(c) uc_is_general_category (c, UC_CATEGORY_Nd) include "test-predicate-part2.h"

Copyright (C) 2007 Free Software Foundation, Inc.:(c) uc_is_blank (c) include "test-predicate-part2.h"

Copyright (C) 2007 Free Software Foundation, Inc.:(c) uc_is_graph (c) include "test-predicate-part2.h"

Copyright (C) 2007 Free Software Foundation, Inc.:(c) uc_is_property_not_a_character (c) include "test-predicate-part2.h"

Copyright (C) 2007 Free Software Foundation, Inc.:(c) uc_is_property_soft_dotted (c) include "test-predicate-part2.h"

Copyright (C) 2007 Free Software Foundation, Inc.:(c) uc_is_general_category (c, UC_CATEGORY_Nl) include "test-predicate-part2.h"

Copyright (C) 2007 Free Software Foundation, Inc.:(c) uc_is_property_bidi_other_neutral (c) include "test-predicate-

part2.h"

Copyright (C) 2007 Free Software Foundation, Inc.:(c) uc_is_general_category (c, UC_CATEGORY_Me) include "test-predicate-part2.h"

Copyright (C) 2007 Free Software Foundation, Inc.:(c) uc_is_general_category (c, UC_CATEGORY_Zs) include "test-predicate-part2.h"

Copyright (C) 2007 Free Software Foundation, Inc.:(c) uc_is_property_join_control (c) include "test-predicate-part2.h"

Copyright (C) 2007 Free Software Foundation, Inc.:(c) uc_is_property_changes_when_lowercased (c) include "test-predicate-part2.h"

Copyright (C) 2007 Free Software Foundation, Inc.:(c) uc_is_property_combining (c) include "test-predicate-part2.h"

Copyright (C) 2007 Free Software Foundation, Inc.:(c) uc_is_property_space (c) include "test-predicate-part2.h"

Copyright (C) 2007 Free Software Foundation, Inc.:(c) uc_is_general_category (c, UC_CATEGORY_Pi) include "test-predicate-part2.h"

Copyright (C) 2007 Free Software Foundation, Inc.:(c) uc_is_general_category (c, UC_CATEGORY_Pe) include "test-predicate-part2.h"

Copyright (C) 2007 Free Software Foundation, Inc.:(c) uc_is_property_alphabetic (c) include "test-predicate-part2.h"

Copyright (C) 2007 Free Software Foundation, Inc.:(c) uc_is_property_other_math (c) include "test-predicate-part2.h"

Copyright (C) 2007 Free Software Foundation, Inc.:(c) uc_is_property_ids_binary_operator (c) include "test-predicate-part2.h"

Copyright (C) 2007 Free Software Foundation, Inc.:(c) uc_is_property_unassigned_code_value (c) include "test-predicate-part2.h"

Copyright (C) 2007 Free Software Foundation, Inc.:(c) uc_is_property_grapheme_base (c) include "test-predicate-part2.h"

Copyright (C) 2007 Free Software Foundation, Inc.:(c) uc_is_property_dash (c) include "test-predicate-part2.h"

Copyright (C) 2007 Free Software Foundation, Inc.:(c) uc_is_property_bidi_european_digit (c) include "test-predicate-part2.h"

Copyright (C) 2007 Free Software Foundation, Inc.:(c) uc_is_property_bidi_boundary_neutral (c) include "test-predicate-part2.h"

Copyright (C) 2007 Free Software Foundation, Inc.:(c) uc_is_property_changes_when_uppercased (c) include "test-predicate-part2.h"

Copyright (C) 2007 Free Software Foundation, Inc.:(c) uc_is_property_ids_trinary_operator (c) include "test-predicate-part2.h"

Copyright (C) 2007 Free Software Foundation, Inc.:(c) uc_is_property_other_id_continue (c) include "test-predicate-part2.h"

Copyright (C) 2007 Free Software Foundation, Inc.:(c) uc_is_general_category (c, UC_CATEGORY_Cn) include "test-predicate-part2.h"

Copyright (C) 2007 Free Software Foundation, Inc.:(c) uc_is_property_decimal_digit (c) include "test-predicate-part2.h"

Copyright (C) 2007 Free Software Foundation, Inc.:(c) uc_is_property_sentence_terminal (c) include "test-predicate-part2.h"

Copyright (C) 2007 Free Software Foundation, Inc.:(c) uc_is_property_grapheme_link (c) include "test-predicate-part2.h"

Copyright (C) 2007 Free Software Foundation, Inc.:(c) uc_is_property_default_ignorable_code_point (c) include "test-predicate-part2.h"

Copyright (C) 2000-2002, 2005-2007, 2009-2018 Free Software Foundation, Inc. Written by Bruno Haible <bruno@clisp.org>, 2000-2002.

Copyright (C) 2007 Free Software Foundation, Inc.:(c) uc_is_property_line_separator (c) include "test-predicate-part2.h"

Copyright (C) 2007 Free Software Foundation, Inc.:(c) uc_is_property_xid_continue (c) include "test-predicate-part2.h"

Copyright (C) 2007 Free Software Foundation, Inc.:(c) uc_is_property_other_uppercase (c) include "test-predicate-part2.h"

Copyright (C) 2007 Free Software Foundation, Inc.:(c) uc_is_punct (c) include "test-predicate-part2.h"

Copyright (C) 2007 Free Software Foundation, Inc.:(c) uc_is_property_extender (c) include "test-predicate-part2.h"

Copyright (C) 2007 Free Software Foundation, Inc.:(c) uc_is_property_numeric (c) include "test-predicate-part2.h"

Copyright (C) 2007 Free Software Foundation, Inc.:(c) uc_is_general_category (c, UC_CATEGORY_Lc) include "test-predicate-part2.h"

Copyright (C) 2007 Free Software Foundation, Inc.:(c) uc_is_general_category (c, UC_CATEGORY_Ll) include

LICENCE TERMS (cont.)

"test-predicate-part2.h"
Copyright (C) 2007 Free Software Foundation, Inc.:(c) uc_is_general_category (c, UC_CATEGORY_No) include "test-predicate-part2.h"
Copyright (C) 2007, 2011-2018 Free Software Foundation, Inc. Written by Bruno Haible <bruno@clisp.org>, 2007.
Copyright (C) 2007 Free Software Foundation, Inc.:(c) uc_is_property_other_id_start (c) include "test-predicate-part2.h"
Copyright (C) 2007 Free Software Foundation, Inc.:(c) uc_is_property_ignorable_control (c) include "test-predicate-part2.h"
Copyright (C) 2007 Free Software Foundation, Inc.:(c) uc_is_property_bidi_pdf (c) include "test-predicate-part2.h"
Copyright (C) 2007 Free Software Foundation, Inc.:(c) uc_is_general_category (c, UC_CATEGORY_P) include "test-predicate-part2.h"
Copyright (C) 2007 Free Software Foundation, Inc.:(c) uc_is_property_bidi_arabic_right_to_left (c) include "test-predicate-part2.h"
Copyright (C) 2007 Free Software Foundation, Inc.:(c) uc_is_property_currency_symbol (c) include "test-predicate-part2.h"
Copyright (C) 2007 Free Software Foundation, Inc.:(c) uc_is_property_hyphen (c) include "test-predicate-part2.h"
Copyright (C) 2002, 2006, 2011-2018 Free Software Foundation, Inc. Written by Bruno Haible <bruno@clisp.org>, 2011.
Copyright (C) 2007 Free Software Foundation, Inc.:(c) uc_is_property_non_break (c) include "test-predicate-part2.h"
Copyright (C) 2007 Free Software Foundation, Inc.:(c) uc_is_general_category (c, UC_CATEGORY_So) include "test-predicate-part2.h"
Copyright (C) 2007 Free Software Foundation, Inc.:(c) uc_is_general_category (c, UC_CATEGORY_Lo) include "test-predicate-part2.h"
Copyright (C) 2007 Free Software Foundation, Inc.:(c) uc_is_general_category (c, UC_CATEGORY_Ps) include "test-predicate-part2.h"
Copyright (C) 2007 Free Software Foundation, Inc.:(c) uc_is_property_uppercase (c) include "test-predicate-part2.h"
Copyright (C) 2007 Free Software Foundation, Inc.:(c) uc_is_c_whitespace (c) include "test-predicate-part2.h"
Copyright (C) 2007 Free Software Foundation, Inc.:(c) uc_is_property_bidi_non_spacing_mark (c) include "test-predicate-part2.h"
Copyright (C) 2007 Free Software Foundation, Inc.:(c) uc_is_xdigit (c) include "test-predicate-part2.h"
Copyright (C) 2007 Free Software Foundation, Inc.:(c) uc_is_property_pattern_white_space (c) include "test-predicate-part2.h"
Copyright (C) 2007 Free Software Foundation, Inc.:(c) uc_is_property_quotation_mark (c) include "test-predicate-part2.h"
Copyright (C) 2007 Free Software Foundation, Inc.:(c) uc_is_general_category (c, UC_CATEGORY_Mn) include "test-predicate-part2.h"
Copyright (C) 2007 Free Software Foundation, Inc.:(c) uc_is_general_category (c, UC_CATEGORY_Pd) include "test-predicate-part2.h"
Copyright (C) 2007 Free Software Foundation, Inc.:(c) uc_is_property_radical (c) include "test-predicate-part2.h"
Copyright (C) 2007 Free Software Foundation, Inc.:(c) uc_is_property_unified_ideograph (c) include "test-predicate-part2.h"
Copyright (C) 2002-2003, 2005-2007, 2009-2018 Free Software Foundation, Inc.
Copyright (C) 2002, 2005-2007, 2009-2018 Free Software Foundation, Inc. Written by Bruno Haible <bruno@clisp.org>, 2002.
Copyright (C) 1998, 2001, 2003-2006, 2009-2018 Free Software Foundation, Inc.
Copyright (C) 2005, 2008-2018 Free Software Foundation, Inc.
Copyright (C) 2008-2018 Free Software Foundation, Inc. Written by Bruno Haible <bruno@clisp.org>, 2008.
Copyright (C) 1990, 1998, 2000-2001, 2003-2006, 2009-2018 Free Software Foundation, Inc.
Copyright (C) 1994-2018 Free Software Foundation, Inc.
© 2016 Unicode®, Inc. Unicode and the Unicode Logo are registered trademarks of Unicode, Inc. in the U.S. and other countries. For terms of use, see http://www.unicode.org/terms_of_use.html
Copyright (C) 2003-2007, 2009-2018 Free Software Foundation, Inc. Written by Bruno Haible <bruno@clisp.org>, 2003.
Copyright (C) 1999, 2002-2003, 2005, 2007, 2010-2018 Free Software Foundation, Inc.
Copyright (C) 2001-2003, 2006-2018 Free Software Foundation, Inc. Written by Bruno Haible <haible@clisp.cons.org>, 2001.
Copyright (C) 2000-2004, 2006-2018 Free Software Foundation, Inc.

Copyright (C) 2001-2003, 2005-2018 Free Software Foundation, Inc. Written by Bruno Haible <bruno@clisp.org>, 2009.
Copyright (C) 1995, 1999, 2001-2004, 2006-2018 Free Software Foundation, Inc.
Copyright (C) 2005, 2007-2018 Free Software Foundation, Inc.
Copyright (C) 2002-2007, 2009-2018 Free Software Foundation, Inc.
Copyright (C) 2016-2018 Free Software Foundation, Inc.
Copyright (C) 2002-2003, 2005-2006, 2009-2018 Free Software Foundation, Inc.
Copyright (C) 1995-1998, 2000-2002, 2004-2006, 2009-2018 Free Software Foundation, Inc.
Copyright (C) 2009, 2011-2018 Free Software Foundation, Inc.
Copyright (C) 2002, 2006, 2009, 2011-2018 Free Software Foundation, Inc. Written by Bruno Haible <bruno@clisp.org>, 2009.
Copyright (C) 2001-2003, 2009-2018 Free Software Foundation, Inc. Written by Bruno Haible <bruno@clisp.org>, 2009.
Copyright (C) 2011-2018 Free Software Foundation, Inc. This file is part of the GNUlib Library.
Copyright (C) 2001-2002, 2007, 2009-2018 Free Software Foundation, Inc.
Copyright (C) 1995-1996, 2001, 2003, 2005, 2009-2018 Free Software Foundation, Inc.
Copyright (C) 1999-2001, 2007, 2009-2018 Free Software Foundation, Inc.
Copyright (C) 1999, 2002-2003, 2005-2007, 2009-2018 Free Software Foundation, Inc.
Copyright (C) 2009-2018 Free Software Foundation, Inc. This file is part of the GNUlib Library.
Copyright (C) 2001-2007, 2009-2018 Free Software Foundation, Inc. Written by Bruno Haible and Simon Josefsson.
Copyright (C) 2017-2018 Free Software Foundation, Inc.
Copyright (C) 2003, 2005, 2008-2018 Free Software Foundation, Inc. Written by Bruno Haible <bruno@clisp.org>, 2003.
Copyright (C) 1990, 2001, 2003-2006, 2009-2018 Free Software Foundation, Inc.
Copyright (C) 1999, 2002-2003, 2006-2007, 2011-2018 Free Software Foundation, Inc.
Copyright (C) 2001-2003, 2006-2017 Free Software Foundation, Inc. Written by Bruno Haible <haible@clisp.cons.org>, 2001.
Copyright (C) 1997-1998, 2006-2007, 2009-2018 Free Software Foundation, Inc.
Copyright (C) 2009 Free Software Foundation, Inc. Written by Bruno Haible <bruno@clisp.org>, 2009.
Copyright (C) 2002, 2005, 2007, 2009-2018 Free Software Foundation, Inc. Written by Bruno Haible.
Copyright (C) 2001-2002, 2004-2018 Free Software Foundation, Inc. Written by Paul Eggert, Bruno Haible, Sam Steingold, Peter Burwood. This file is part of gnuilib.
Copyright (C) 1995, 1998, 2001, 2003, 2005, 2009-2018 Free Software Foundation, Inc.
Copyright (C) 2001, 2005, 2007, 2009-2018 Free Software Foundation, Inc.
Copyright (C) 2001-2003, 2006-2018 Free Software Foundation, Inc. Written by Bruno Haible <bruno@clisp.org>, 2009.
Copyright (C) 2000-2002, 2004, 2007-2009 Free Software Foundation, Inc.
Copyright (C) 2006-2018 Free Software Foundation, Inc. Written by Paul Eggert, Bruno Haible, Derek Price. This file is part of gnuilib.
Copyright (C) 2003, 2008-2018 Free Software Foundation, Inc.
Copyright (C) 2001-2007, 2009-2018 Free Software Foundation, Inc. Written by Bruno Haible.
Copyright (C) 2009 Free Software Foundation, Inc.:(c) uc_toupper (c) include "test-mapping-part2.h"
Copyright (C) 2009 Free Software Foundation, Inc.:(c) uc_tolower (c) include "test-mapping-part2.h"
Copyright (C) 2007 Free Software Foundation, Inc.:(c) uc_is_case_ignorable (c) include "test-predicate-part2.h"
Copyright (C) 2007 Free Software Foundation, Inc.:(c) uc_is_cased (c) include "test-predicate-part2.h"
Copyright (C) 2009 Free Software Foundation, Inc.:(c) uc_totitle (c) include "test-mapping-part2.h"
Copyright (C) 1990-1998, 2000-2007, 2009-2018 Free Software Foundation, Inc. This file is part of the GNU C Library.
Copyright (C) 2008-2018 Free Software Foundation, Inc. Written by Eric Blake and Bruno Haible
Copyright (C) 1995-1997, 2003, 2006, 2008-2018 Free Software Foundation, Inc. This file is part of the GNU C Library.
Copyright (C) 1991, 1994, 1997-1998, 2000, 2003-2018 Free Software Foundation, Inc.
Copyright (C) 2010 Free Software Foundation, Inc.
Copyright (C) 2005, 2009-2018 Free Software Foundation, Inc.
Copyright (C) 2006-2018 Free Software Foundation, Inc. Written by Bruno Haible <bruno@clisp.org>, 2006.
Copyright (C) 2004-2015 Free Software Foundation, Inc. This is free software
Copyright (C) 2010-2015 Free Software Foundation, Inc. This is free software

LICENCE TERMS (cont.)

Copyright(c) all begin with the string "--It-" application programs are unlikely to have options that match this pattern).
Copyright 1992-2019 Free Software Foundation, Inc.
Copyright (C) 2014 Free Software Foundation, Inc. This is free software
Copyright (C) 2011 Free Software Foundation, Inc. This config.It script is free software
copyright on the software, and (2) offer you this License giving you legal permission to copy, distribute and/or modify it.
copyright treaty adopted on 20 December 1996, or similar laws prohibiting or restricting circumvention of such measures.
copyright keep intact all notices stating that this License and any non-permissive terms added in accord with section 7 apply to the code
copyright holder fails to notify you of the violation by some reasonable means prior to 60 days after the cessation.
Copyright (C) <year> <name of author>
Copyright (C) <year> <name of author> This program comes with ABSOLUTELY NO WARRANTY
copyright on the software, and (2) offer you this License giving you legal permission to copy, distribute and/or modify it.
copyright treaty adopted on 20 December 1996, or similar laws prohibiting or restricting circumvention of such measures.
COPYRIGHT keep intact all notices stating that this License and any non-permissive terms added in accord with section 7 apply to the code
copyright holder fails to notify you of the violation by some reasonable means prior to 60 days after the cessation.
Copyright (C) <year> <name of author>
Copyright (C) <year> <name of author> This program comes with ABSOLUTELY NO WARRANTY
copyright on the software, and (2) offer you this License giving you legal permission to copy, distribute and/or modify it.
copyright treaty adopted on 20 December 1996, or similar laws prohibiting or restricting circumvention of such measures.
Copyright keep intact all notices stating that this License and any non-permissive terms added in accord with section 7 apply to the code
copyright holder fails to notify you of the violation by some reasonable means prior to 60 days after the cessation.
Copyright (C) <year> <name of author>
Copyright (C) @var{year} @var{your name}. Permission is granted to copy, distribute and/or modify this document under the terms of the GNU Free Documentation License, Version 1.3 or any later version published by the Free Software Foundation
Copyright (C) @var{year} @var{your name}. Permission is granted to copy, distribute and/or modify this document under the terms of the GNU Free Documentation License, Version 1.3 or any later version published by the Free Software Foundation
copyright{}}% DeclareUnicodeCharacter{00AA}{\ordf}% DeclareUnicodeCharacter{00AB}{\guillemetleft{}}%
DeclareUnicodeCharacter{00AC}{\ensurermath\lnot}% DeclareUnicodeCharacter{00AD}{\l-}%
DeclareUnicodeCharacter{00AE}{\registeredsymbol{}}% DeclareUnicodeCharacter{00AF}{\l={}}%
Copyright (C) 2002-2018 Free Software Foundation, Inc.
Copyright (C) 2001-2018 Free Software Foundation, Inc.
Copyright (C) 1997-2018 Free Software Foundation, Inc.
Copyright (C) 1999-2018 Free Software Foundation, Inc.
Copyright (C) 1996-2018 Free Software Foundation, Inc.
Copyright (C) 2003-2018 Free Software Foundation, Inc.
Copyright (C) 2009-2018 Free Software Foundation, Inc.
Copyright (C) 2006-2018 Free Software Foundation, Inc.
Copyright (C) 2004-2018 Free Software Foundation, Inc.
Copyright (C) 1995-2014, 2016 Free Software Foundation, Inc. dnl This file is free software
copyright-holder= --msgid-bugs-address= /dev/null >&]AS_MESSAGE_LOG_FD[2>&1 &&
copyright-holder= --msgid-bugs-address= /dev/null 2>&1 >/dev/null | grep usage >/dev/null
copyright then exit 1
copyright else exit 0
Copyright (C) 2006, 2009 Free Software Foundation, Inc. dnl This file is free software
Copyright (C) 1992-2009 Free Software Foundation, Inc. dnl This file is free software, distributed under the terms of the GNU dnl General Public License. As a special exception to the GNU General dnl Public License, this file may be

distributed as part of a program dnl that contains a configuration
Copyright (C) 1996-2001, 2003-2015 Free Software Foundation, Inc. Written by Gordon Matzigeit, 1996
Copyright (C) 2014 Free Software Foundation, Inc. This is free software
Copyright (C) 2011 Free Software Foundation, Inc. This config.It script is free software
Copyright (C) 2004-2005, 2007-2009, 2011-2015 Free Software Foundation, Inc. Written by Gary V. Vaughan, 2004
Copyright (C) 2004-2005, 2007-2008, 2011-2015 Free Software Foundation, Inc. Written by Gary V. Vaughan, 2004
Copyright (C) 2004, 2011-2015 Free Software Foundation, Inc. Written by Scott James Remnant, 2004
Copyright (C) 2004-2005, 2007, 2009, 2011-2015 Free Software Foundation, Inc. Written by Scott James Remnant, 2004.
Copyright (C) 2005-2006, 2011, 2015-2016 Free Software Foundation, Inc. dnl This file is free software
Copyright (C) 2009-2018 Free Software Foundation, Inc. dnl This file is free software
Copyright (C) 2006-2018 Free Software Foundation, Inc. dnl This file is free software
Copyright (C) 2002-2004, 2006-2007, 2009-2018 Free Software Foundation, dnl Inc. dnl This file is free software
Copyright (C) 2010-2018 Free Software Foundation, Inc. dnl This file is free software
Copyright (C) 2008-2018 Free Software Foundation, Inc. dnl This file is free software
Copyright 2016-2018 Free Software Foundation, Inc. dnl This file is free software
Copyright (C) 2000-2002, 2006, 2008-2014, 2016 Free Software Foundation, dnl Inc. dnl This file is free software
Copyright (C) 2002-2006, 2009-2018 Free Software Foundation, Inc. dnl This file is free software
Copyright (C) 2006, 2008-2018 Free Software Foundation, Inc. dnl This file is free software
Copyright (C) 2003, 2009-2018 Free Software Foundation, Inc. dnl This file is free software
Copyright (C) 2001-2004, 2006-2018 Free Software Foundation, Inc. dnl This file is free software
Copyright (C) 2004, 2006, 2008-2018 Free Software Foundation, Inc. dnl This file is free software
Copyright (C) 1996-1998, 2001-2004, 2009-2018 Free Software Foundation, Inc.
Copyright (C) 2007-2008, 2010-2018 Free Software Foundation, Inc. dnl This file is free software
Copyright (C) 2007-2018 Free Software Foundation, Inc. dnl This file is free software
Copyright (C) 2003, 2006-2018 Free Software Foundation, Inc. This file is free software
Copyright 2012-2018 Free Software Foundation, Inc. dnl This file is free software
Copyright (C) 2006, 2009-2018 Free Software Foundation, Inc. dnl This file is free software
Copyright (C) 2011-2018 Free Software Foundation, Inc. dnl This file is free software
Copyright (C) 2006, 2009-2018 Free Software Foundation, Inc. This file is free software
Copyright (C) 2007, 2009-2018 Free Software Foundation, Inc. dnl This file is free software
Copyright (C) 2012-2018 Free Software Foundation, Inc. dnl This file is free software
Copyright (C) 2002, 2004-2005, 2007, 2009-2018 Free Software Foundation, dnl Inc. dnl This file is free software
Copyright (C) 2016-2018 Free Software Foundation, Inc. This file is free software
Copyright (C) 2000-2002, 2004, 2008, 2010-2018 Free Software Foundation, dnl Inc. dnl This file is free software
Copyright (C) 2002-2018 Free Software Foundation, Inc. dnl This file is free software
Copyright (C) 2000-2002, 2007-2014, 2016-2018 Free Software Foundation, dnl Inc. dnl This file is free software
Copyright (C) 2004-2014, 2016 Free Software Foundation, Inc. dnl This file is free software
Copyright (C) 1997-2004, 2006-2007, 2009-2018 Free Software Foundation, dnl Inc. dnl This file is free software
Copyright (C) 1997-2002, 2006, 2008-2018 Free Software Foundation, Inc. dnl This file is free software
Copyright (C) 1997-2004, 2006, 2008-2018 Free Software Foundation, Inc. dnl This file is free software
Copyright (C) 1995-2002, 2004-2005, 2008-2014, 2016 Free Software dnl Foundation, Inc. dnl This file is free software
Copyright (C) 1996-2003, 2009-2018 Free Software Foundation, Inc. dnl This file is free software
Copyright (C) 2001-2018 Free Software Foundation, Inc. dnl This file is free software
Copyright (C) 2001-2005, 2008-2018 Free Software Foundation, Inc. dnl This file is free software
Copyright (C) 2002, 2004, 2006, 2009-2018 Free Software Foundation, Inc. dnl This file is free software
Copyright (C) 2003, 2005-2018 Free Software Foundation, Inc. dnl This file is free software
Copyright (C) 2005-2018 Free Software Foundation, Inc. dnl This file is free software
Copyright (C) 1999-2007, 2009-2018 Free Software Foundation, Inc. dnl This file is free software
Copyright (C) 2003-2004, 2006-2007, 2009-2018 Free Software Foundation, dnl Inc. dnl This file is free software
Copyright (C) 2005-2007, 2009-2018 Free Software Foundation, Inc. dnl This file is free software
Copyright (C) 2005, 2008-2018 Free Software Foundation, Inc. dnl This file is free software
Copyright (C) 2001-2002, 2004-2005, 2008-2018 Free Software Foundation, dnl Inc. dnl This file is free software
Copyright (C) 2008, 2010-2018 Free Software Foundation, Inc. dnl This file is free software
Copyright (C) 2000-2002, 2008-2018 Free Software Foundation, Inc. dnl This file is free software
Copyright (C) 2002-2004, 2009-2018 Free Software Foundation, Inc. dnl This file is free software

LICENCE TERMS (cont.)

Copyright (C) 2005, 2009-2018 Free Software Foundation, Inc. dnl This file is free software
Copyright (C) 2005, 2007, 2009-2018 Free Software Foundation, Inc. dnl This file is free software
Copyright (C) 2003, 2007-2018 Free Software Foundation, Inc. dnl This file is free software
Copyright (C) 2017-2018 Free Software Foundation, Inc. dnl This file is free software
Copyright (C) 2003, 2005-2007, 2009-2018 Free Software Foundation, Inc. dnl This file is free software
Copyright (C) 2001-2002, 2006-2018 Free Software Foundation, Inc. dnl This file is free software
Copyright (C) 2003, 2005-2006, 2008-2018 Free Software Foundation, Inc. dnl This file is free software
Copyright (C) 2001-2003, 2006, 2010-2018 Free Software Foundation, Inc. dnl This file is free software
Copyright 2011-2018 Free Software Foundation, Inc. dnl This file is free software
Copyright (C) 2002, 2007-2018 Free Software Foundation, Inc. dnl This file is free software
Copyright (C) 2007-2018 Free Software Foundation, Inc. This file is free software
Copyright (C) 2000-2001, 2003-2007, 2009-2018 Free Software Foundation, Inc.
Copyright (C) 2002-2004, 2006-2018 Free Software Foundation, Inc. dnl This file is free software
Copyright (C) 2002-2003, 2008-2018 Free Software Foundation, Inc. dnl This file is free software
Copyright (C) 2003-2004, 2008-2018 Free Software Foundation, Inc. dnl This file is free software
Copyright (C) 2002-2018 Free Software Foundation, Inc.
Copyright (C) 2001-2018 Free Software Foundation, Inc.
Copyright (C) 1997-2018 Free Software Foundation, Inc.
Copyright (C) 1999-2018 Free Software Foundation, Inc.
Copyright (C) 1996-2018 Free Software Foundation, Inc.
Copyright (C) 2003-2018 Free Software Foundation, Inc.
Copyright (C) 2009-2018 Free Software Foundation, Inc.
Copyright (C) 2006-2018 Free Software Foundation, Inc.
Copyright (C) 2004-2018 Free Software Foundation, Inc.
Copyright (C) 1995-2014, 2016 Free Software Foundation, Inc.
Copyright (C) 2006, 2009 Free Software Foundation, Inc.
Copyright (C) 1992-2009 Free Software Foundation, Inc.
Copyright (C) 1996-2001, 2003-2015 Free Software Foundation, Inc. Written by Gordon Matzigkeit, 1996
Copyright (C) 2004-2005, 2007-2009, 2011-2015 Free Software Foundation, Inc. Written by Gary V. Vaughan, 2004
Copyright (C) 2004-2005, 2007-2008, 2011-2015 Free Software Foundation, Inc. Written by Gary V. Vaughan, 2004
Copyright (C) 2004, 2011-2015 Free Software Foundation, Inc. Written by Scott James Remnant, 2004
Copyright (C) 2004-2005, 2007, 2009, 2011-2015 Free Software Foundation, Inc. Written by Scott James Remnant, 2004.
Copyright (C) 2005-2006, 2011, 2015-2016 Free Software Foundation, Inc. dnl This file is free software
Copyright (C) 2009-2018 Free Software Foundation, Inc. dnl This file is free software
Copyright (C) 2006-2018 Free Software Foundation, Inc. dnl This file is free software
Copyright (C) 2002-2004, 2006-2007, 2009-2018 Free Software Foundation, Inc. dnl This file is free software
Copyright (C) 2010-2018 Free Software Foundation, Inc. dnl This file is free software
Copyright (C) 2008-2018 Free Software Foundation, Inc. dnl This file is free software
Copyright 2016-2018 Free Software Foundation, Inc. dnl This file is free software
Copyright (C) 2000-2002, 2006, 2008-2014, 2016 Free Software Foundation, Inc.
Copyright (C) 2002-2006, 2009-2018 Free Software Foundation, Inc. dnl This file is free software
Copyright (C) 2006, 2008-2018 Free Software Foundation, Inc. dnl This file is free software
Copyright (C) 2003, 2009-2018 Free Software Foundation, Inc. dnl This file is free software
Copyright (C) 2001-2004, 2006-2018 Free Software Foundation, Inc. dnl This file is free software
Copyright (C) 2004, 2006, 2008-2018 Free Software Foundation, Inc. dnl This file is free software
Copyright (C) 1996-1998, 2001-2004, 2009-2018 Free Software Foundation, Inc.
Copyright (C) 2007-2008, 2010-2018 Free Software Foundation, Inc. dnl This file is free software
Copyright (C) 2007-2018 Free Software Foundation, Inc. dnl This file is free software
Copyright (C) 2003, 2006-2018 Free Software Foundation, Inc. This file is free software
Copyright 2012-2018 Free Software Foundation, Inc. dnl This file is free software
Copyright (C) 2006, 2009-2018 Free Software Foundation, Inc. dnl This file is free software
Copyright (C) 2011-2018 Free Software Foundation, Inc. dnl This file is free software
Copyright (C) 2006, 2009-2018 Free Software Foundation, Inc. This file is free software
Copyright (C) 2007, 2009-2018 Free Software Foundation, Inc. dnl This file is free software
Copyright (C) 2012-2018 Free Software Foundation, Inc. dnl This file is free software
Copyright (C) 2002, 2004-2005, 2007, 2009-2018 Free Software Foundation, Inc. dnl This file is free software

Copyright (C) 2016-2018 Free Software Foundation, Inc. This file is free software
Copyright (C) 2000-2002, 2004, 2008, 2010-2018 Free Software Foundation, Inc. dnl This file is free software
Copyright (C) 2002-2018 Free Software Foundation, Inc. dnl This file is free software
Copyright (C) 2000-2002, 2007-2014, 2016-2018 Free Software Foundation, Inc. dnl This file is free software
Copyright (C) 2004-2014, 2016 Free Software Foundation, Inc. dnl This file is free software
Copyright (C) 1997-2004, 2006-2007, 2009-2018 Free Software Foundation, Inc. dnl This file is free software
Copyright (C) 1997-2002, 2006, 2008-2018 Free Software Foundation, Inc. dnl This file is free software
Copyright (C) 1997-2004, 2006, 2008-2018 Free Software Foundation, Inc. dnl This file is free software
Copyright (C) 1995-2002, 2004-2005, 2008-2014, 2016 Free Software Foundation, Inc. dnl This file is free software
Copyright (C) 1996-2003, 2009-2018 Free Software Foundation, Inc. dnl This file is free software
Copyright (C) 2001-2018 Free Software Foundation, Inc. dnl This file is free software
Copyright (C) 2001-2005, 2008-2018 Free Software Foundation, Inc. dnl This file is free software
Copyright (C) 2002, 2004, 2006, 2009-2018 Free Software Foundation, Inc. dnl This file is free software
Copyright (C) 2003, 2005-2018 Free Software Foundation, Inc. dnl This file is free software
Copyright (C) 2005-2018 Free Software Foundation, Inc. dnl This file is free software
Copyright (C) 1999-2007, 2009-2018 Free Software Foundation, Inc. dnl This file is free software
Copyright (C) 2003-2004, 2006-2007, 2009-2018 Free Software Foundation, Inc. dnl This file is free software
Copyright (C) 2005-2007, 2009-2018 Free Software Foundation, Inc. dnl This file is free software
Copyright (C) 2005, 2008-2018 Free Software Foundation, Inc. dnl This file is free software
Copyright (C) 2001-2002, 2004-2005, 2008-2018 Free Software Foundation, Inc. dnl This file is free software
Copyright (C) 2008, 2010-2018 Free Software Foundation, Inc. dnl This file is free software
Copyright (C) 2000-2002, 2008-2018 Free Software Foundation, Inc. dnl This file is free software
Copyright (C) 2002-2004, 2009-2018 Free Software Foundation, Inc. dnl This file is free software
Copyright (C) 2005, 2009-2018 Free Software Foundation, Inc. dnl This file is free software
Copyright (C) 2005, 2007, 2009-2018 Free Software Foundation, Inc. dnl This file is free software
Copyright (C) 2003, 2007-2018 Free Software Foundation, Inc. dnl This file is free software
Copyright (C) 2017-2018 Free Software Foundation, Inc. dnl This file is free software
Copyright (C) 2003, 2005-2007, 2009-2018 Free Software Foundation, Inc. dnl This file is free software
Copyright (C) 2001-2002, 2006-2018 Free Software Foundation, Inc. dnl This file is free software
Copyright (C) 2003, 2005-2006, 2008-2018 Free Software Foundation, Inc. dnl This file is free software
Copyright (C) 2001-2003, 2006, 2010-2018 Free Software Foundation, Inc. dnl This file is free software
Copyright 2011-2018 Free Software Foundation, Inc. dnl This file is free software
Copyright (C) 2002, 2007-2018 Free Software Foundation, Inc. dnl This file is free software
Copyright (C) 2007-2018 Free Software Foundation, Inc. This file is free software
Copyright (C) 2000-2001, 2003-2007, 2009-2018 Free Software Foundation, Inc.
Copyright (C) 2002-2004, 2006-2018 Free Software Foundation, Inc. dnl This file is free software
Copyright (C) 2002-2003, 2008-2018 Free Software Foundation, Inc. dnl This file is free software
Copyright (C) 2003-2004, 2008-2018 Free Software Foundation, Inc. dnl This file is free software
Copyright (C) 2012 Free Software Foundation, Inc. This configure script is free software
Copyright (C) 2012 Free Software Foundation, Inc. This config.status script is free software
Copyright (C) 1999-2005 Patrice Dumas <dumas@centre-cired.fr>, Derek Price <derek@ximbiot.com>, Adrian Aichner <adrian@xemacs.org>, others.
Copyright (C) 2009 Free Software Foundation, Inc.
copyright year. lib/libunistring.rc: Add year 2011.
Copyright © 2007 Free Software Foundation, Inc. <<http://fsf.org/>>
Copyright © 2000, 2001, 2002, 2007, 2008 Free Software Foundation, Inc. <http://fsf.org/>>
Copyright © 2007 Free Software Foundation, Inc. <<http://fsf.org/>>
Copyright © 2000, 2001, 2002, 2007, 2008 Free Software Foundation, Inc. <http://fsf.org/>>
Copyright © 2007 Free Software Foundation, Inc. <<http://fsf.org/>>
Copyright © 2000, 2001, 2002, 2007, 2008 Free Software Foundation, Inc. <http://fsf.org/>>
Copyright (C) YEAR YOUR NAME. Permission is granted to copy, distribute and/or modify this document under the terms of the GNU Free Documentation License, Version 1.3 or any later version published by the Free Software Foundation
copyright 2007 Free Software Foundation, Inc.
copyright 2000, 2001, 2002, 2007, 2008 Free Software Foundation, Inc.
COPYRIGHT 2007 Free Software Foundation, Inc.

LICENCE TERMS (cont.)

Copyright 2007 Free Software Foundation, Inc.
Copyright 2000, 2001, 2002, 2007, 2008 Free Software Foundation, Inc.
Copyright (C) 2001-2018 Free Software Foundation, Inc.
Copyright (C) 2002-2018 Free Software Foundation, Inc.
Copyright (C) 1994 X Consortium
Copyright (C) 1996-2015 Free Software Foundation, Inc. This is free software
Copyright (C) 1999-2018 Free Software Foundation, Inc. Written by Tom Tromeey <tromeey@cygnus.com>.
Copyright 1992-2019 Free Software Foundation, Inc.
Copyright (C) 1999-2018 Free Software Foundation, Inc.
Copyright (C) 2004-2005, 2007, 2009, 2011-2015 Free Software Foundation, Inc. Written by Scott James Remnant, 2004.
Copyright (C) 2004, 2011-2015 Free Software Foundation, Inc. Written by Scott James Remnant, 2004
Copyright (C) 1996-2001, 2003-2015 Free Software Foundation, Inc. Written by Gordon Matzigkeit, 1996
Copyright (C) 2004-2005, 2007-2008, 2011-2015 Free Software Foundation, Inc. Written by Gary V. Vaughan, 2004
Copyright (C) 2004-2005, 2007-2009, 2011-2015 Free Software Foundation, Inc. Written by Gary V. Vaughan, 2004
Copyright (C) 1996-2018 Free Software Foundation, Inc. Originally written by Fran,cois Pinard <pinard@iro.umontreal.ca>, 1996.
Copyright (C) 1994-1996, 1999-2002, 2004-2016 Free Software Foundation, Inc.
Copyright (C) 1996-2018 Free Software Foundation, Inc.
Copyright (C) 1991, 1999 Free Software Foundation, Inc.
Copyright (C) 1992-1996, 1998-2012 Free Software Foundation, Inc.
Copyright (C) 1994-2018 Free Software Foundation, Inc.
Copyright © 2012-2013 RealVNC Ltd. <toby.gray@realvnc.com>
Copyright (C) 2012 Harald Welte <laforge@gnumonks.org>
Copyright © 2012-2013 RealVNC Ltd.
Copyright (c) 2013 Nathan Hjelm <hjelmn@mac.ccom>
Copyright © 2007 Daniel Drake <dsd@gentoo.org>
Copyright (C) 1987,88,89,90,91,92,93,94,96,97,98 Free Software Foundation, Inc. This file is part of the GNU C Library.
Copyright (C) 1987,88,89,90,91,92,93,94,95,96,98,99,2000,2001 Free Software Foundation, Inc. This file is part of the GNU C Library.
Copyright (C) 1989-1994, 1996-1999, 2001 Free Software Foundation, Inc. This file is part of the GNU C Library.
Copyright © 2001 Stephen Williams (steve@icarus.com)
Copyright © 2009-2012 Pete Batard <pete@akeo.ie> Contributions to Mass Storage by Alan Stern.
Copyright © 2012-2013 Nathan Hjelm <hjelmn@mac.com>
Copyright © 2007 Daniel Drake <dsd@gentoo.org>
Copyright © 2001 Johannes Erdfelt <johannes@erdfelt.com>
Copyright © 2012 Toby Gray <toby.gray@realvnc.com>
Copyright © 2012 Pete Batard <pete@akeo.ie> For more information, please visit: <http://libusb.info>
Copyright © 2012-2013 RealVNC Ltd.
Copyright © 2011-2013 RealVNC Ltd. Portions taken from Windows backend, which is
Copyright © 2011 Martin Pieuchot <mpi@openbsd.org>
Copyright © 2014 Red Hat, Inc.
Copyright © 2014 Akshay Jaggi <akshay1994.leo@gmail.com>
Copyright © 2007-2009 Daniel Drake <dsd@gentoo.org>
Copyright © 2010 Michael Plante <michael.plante@gmail.com>
Copyright (C) 2007-2009 Daniel Drake <dsd@gentoo.org>
Copyright (c) 2016, Oracle and/or its affiliates.
Copyright © 2012 RealVNC Ltd.
Copyright 2006-2008, Haiku Inc. All rights reserved. Distributed under the terms of the MIT License.
Copyright © 2008-2017 Nathan Hjelm <hjelmn@users.sourceforge.net>
Copyright © 2009-2012 Pete Batard <pete@akeo.ie>
Copyright (C) 2011 Free Software Foundation, Inc.
Copyright © 2013 RealVNC Ltd.
Copyright © 2011-2013 Martin Pieuchot <mpi@openbsd.org>
Copyright © 2009-2012 Pete Batard <pete@akeo.ie>
Copyright 2007-2008, Haiku Inc. All rights reserved.

Copyright © 2010 Peter Stuge <peter@stuge.se>
Copyright © 2011 Vitali Lovich <vlovich@aliph.com>
Copyright © 2011-2013 RealVNC Ltd.
Copyright © 2008-2015 Nathan Hjelm <hjelmn@users.sourceforge.net>
Copyright © 2017 Chris Dickens <christopher.a.dickens@gmail.com>
Copyright © 2007-2008 Daniel Drake <dsd@gentoo.org>
Copyright © 2013 Hans de Goede <hdegoede@redhat.com>
Copyright © 2012-2013 Nathan Hjelm <hjelmn@mac.com>
Copyright © 2012-2013 Nathan Hjelm <hjelmn@cs.unm.edu>
Copyright (C) 2004-2015 Free Software Foundation, Inc. This is free software
Copyright (C) 2010-2015 Free Software Foundation, Inc. This is free software
Copyright 1992-2019 Free Software Foundation, Inc.
Copyright (C) 2014 Free Software Foundation, Inc. This is free software
Copyright (C) 2011 Free Software Foundation, Inc. This config.It script is free software
Copyright (C) 2002-2018 Free Software Foundation, Inc.
Copyright (C) 2001-2018 Free Software Foundation, Inc.
Copyright (C) 1997-2018 Free Software Foundation, Inc.
Copyright (C) 1999-2018 Free Software Foundation, Inc.
Copyright (C) 1996-2018 Free Software Foundation, Inc.
Copyright (C) 2003-2018 Free Software Foundation, Inc.
Copyright (C) 2009-2018 Free Software Foundation, Inc.
Copyright (C) 2006-2018 Free Software Foundation, Inc.
Copyright (C) 2004-2018 Free Software Foundation, Inc.
Copyright (C) 1996-2001, 2003-2015 Free Software Foundation, Inc. Written by Gordon Matzigkeit, 1996
Copyright (C) 2004-2005, 2007-2009, 2011-2015 Free Software Foundation, Inc. Written by Gary V. Vaughan, 2004
Copyright (C) 2004-2005, 2007-2008, 2011-2015 Free Software Foundation, Inc. Written by Gary V. Vaughan, 2004
Copyright (C) 2004, 2011-2015 Free Software Foundation, Inc. Written by Scott James Remnant, 2004
Copyright (C) 2004-2005, 2007, 2009, 2011-2015 Free Software Foundation, Inc. Written by Scott James Remnant, 2004.
Copyright (C) 2012 Free Software Foundation, Inc. This configure script is free software
Copyright (C) 2012 Free Software Foundation, Inc. This config.status script is free software
Copyright © 2002 David Brownell (dbrownell@users.sourceforge.net)
Copyright © 2013 Federico Manzan (f.manzan@gmail.com)
Copyright © 2001-2002 David Brownell (dbrownell@users.sourceforge.net)
Copyright © 2008 Roger Williams (rawqux@users.sourceforge.net)
Copyright © 2012 Pete Batard (pete@akeo.ie)
Copyright © 2001-2002 David Brownell (dbrownell@users.sourceforge.net)
Copyright © 2008 Roger Williams (rawqux@users.sourceforge.net)
Copyright © 2012 Pete Batard (pete@akeo.ie)
Copyright © 2013 Federico Manzan (f.manzan@gmail.com)
Copyright © 2013 Federico Manzan (f.manzan@gmail.com)
Copyright © 2016 Nathan Hjelm <hjelmn@mac.com>
Copyright © 2007-2009 Daniel Drake <dsd@gentoo.org>
Copyright © 2010-2012 Peter Stuge <peter@stuge.se>
Copyright © 2008-2016 Nathan Hjelm <hjelmn@users.sourceforge.net>
Copyright © 2009-2013 Pete Batard <pete@akeo.ie>
Copyright © 2009-2013 Ludovic Rousseau <ludovic.rousseau@gmail.com>
Copyright © 2010-2012 Michael Plante <michael.plante@gmail.com>
Copyright © 2011-2013 Hans de Goede <hdegoede@redhat.com>
Copyright © 2012-2013 Martin Pieuchot <mpi@openbsd.org>
Copyright © 2012-2013 Toby Gray <toby.gray@realvnc.com>
Copyright © 2013-2018 Chris Dickens <christopher.a.dickens@gmail.com>
Copyright © 2009-2010 Pete Batard <pete@akeo.ie>
Copyright © 2016-2018 Chris Dickens <christopher.a.dickens@gmail.com>
Copyright © 2009-2010 Pete Batard <pbatard@gmail.com>
Copyright © 2001 Johannes Erdfelt <johannes@erdfelt.com>
Copyright © 2013 Nathan Hjelm <hjelmn@mac.com>

LICENCE TERMS (cont.)

Copyright © 2012-2013 Hans de Goede <hdegoede@redhat.com>
Copyright (c) 2001 Johannes Erdfelt <johannes@erdfelt.com>
Copyright (c) 2013 Nathan Hjelm <hjelm@mac.com>
Copyright (c) 2016 Chris Dickens <christopher.a.dickens@gmail.com>
Copyright © 2009-2012 Pete Batard <pete@akeo.ie>
Copyright (c) 2012-2013 Nathan Hjelm <hjelm@mac.com>
Copyright © 2016-2018 Chris Dickens <christopher.a.dickens@gmail.com>
Copyright © 2011 Peter Stuge <peter@stuge.se>
Copyright © 2001 Johannes Erdfelt <johannes@erdfelt.com>
Copyright © 2012-2013 Peter Stuge <peter@stuge.se>
Copyright © 2007-2008 Daniel Drake <dsd@gentoo.org>
Copyright © 2012 Pete Batard <pete@akeo.ie>
Copyright © 2012 Nathan Hjelm <hjelm@cs.unm.edu>
Copyright (C) 1994 X Consortium
Copyright (C) 1996-2015 Free Software Foundation, Inc. This is free software
Copyright (C) 1999-2018 Free Software Foundation, Inc. Written by Tom Tromey <tromey@cygnus.com>.
Copyright 1992-2019 Free Software Foundation, Inc.
Copyright (C) 1999-2018 Free Software Foundation, Inc.
Copyright (C) 2004-2005, 2007, 2009, 2011-2015 Free Software Foundation, Inc. Written by Scott James Remnant, 2004.
Copyright (C) 2004, 2011-2015 Free Software Foundation, Inc. Written by Scott James Remnant, 2004
Copyright (C) 1996-2001, 2003-2015 Free Software Foundation, Inc. Written by Gordon Matzigkeit, 1996
Copyright (C) 2004-2005, 2007-2008, 2011-2015 Free Software Foundation, Inc. Written by Gary V. Vaughan, 2004
Copyright (C) 2004-2005, 2007-2009, 2011-2015 Free Software Foundation, Inc. Written by Gary V. Vaughan, 2004
Copyright (C) 1996-2018 Free Software Foundation, Inc. Originally written by Fran.cois Pinard <pinard@iro.umontreal.ca>, 1996.
Copyright (C) 2011-2018 Free Software Foundation, Inc.
Copyright (c) 2006, 2008 Junio C Hamano
Copyright (C) 1994-1996, 1999-2002, 2004-2016 Free Software Foundation, Inc.
Copyright (c) 2011 Maarten Bosmans <mbosmans@gmail.com>
Copyright (c) 2014 Mike Frysinger <vapier@gentoo.org>
Copyright (c) 2008 Guido U. Draheim <guidod@gmx.de>
Copyright (C) 1991, 1999 Free Software Foundation, Inc.
Copyright 2007-2017 Thorsten Kukuk and Zack Weinberg
Copyright 2005-2016 Colin Percival All rights reserved.
Copyright 2005-2016 Colin Percival
Copyright (c) 2002, 2007 SuSE Linux AG, Germany
Copyright (C) 2018 vt@altlinux.org
Copyright (C) 1991-2017 Free Software Foundation, Inc.
Copyright (C) 1996-2018 Free Software Foundation, Inc.
Copyright (c) 1994 David Burren All rights reserved.
Copyright (C) 1992-1996, 1998-2012 Free Software Foundation, Inc.
Copyright 2013-2018 Alexander Peslyak All rights reserved.
Copyright (C) 2018 Björn Esser <besser82@fedoraproject.org>
Copyright (C) 2019 Björn Esser <besser82@fedoraproject.org>
Copyright 2009 Colin Percival
Copyright (C) 2018-2019 Björn Esser <besser82@fedoraproject.org>
Copyright (c) 2013, Alexey Degtyarev <alexey@renatasystems.org>. All rights reserved.
Copyright (C) 2007-2017 Thorsten Kukuk
Copyright 2007-2014 Colin Percival All rights reserved.
Copyright (C) 2012-2018 Free Software Foundation, Inc. This file is part of the GNU C Library.
Copyright (c) 2004, Juniper Networks, Inc. All rights reserved.
Copyright (c) 1998-1999 Whistle Communications, Inc.
Copyright (c) 2017, Björn Esser <besser82@fedoraproject.org> All rights reserved.
Copyright (C) 2013 Alexander Peslyak
Copyright (c) 2018 Zack Weinberg. All rights reserved.
Copyright 2005 Colin Percival All rights reserved.

Copyright 2018 Zack Weinberg
Copyright (C) 1996-2017 Free Software Foundation, Inc.
Copyright (C) 2011 Free Software Foundation, Inc.
Copyright 2005 Colin Percival
Copyright (C) 2018 vt@altlinux.org
Copyright (C) 1994-2018 Free Software Foundation, Inc.
Copyright (C) 2007-2017 Thorsten Kukuk
Copyright © 2004 Scott James Remnant <scott@netsplit.com>.
Copyright 2017 Zack Weinberg <zackw at panix.com>.
Copyright (c) 2009 Francesco Salvestrini <salvestrini@users.sourceforge.net>
Copyright (c) 2008 Steven G. Johnson <stevenj@alum.mit.edu>
Copyright (c) 2008 Andrew Collier
Copyright (c) 2014 Kevin Cernekee <cernekee@gmail.com>
Copyright (c) 2008 Tim Toolan <toolan@ele.uri.edu>
Copyright (c) 2014, 2015, 2016 Philip Withnall <philip.withnall@collabora.co.uk>
Copyright (C) 2004-2015 Free Software Foundation, Inc. This is free software
Copyright (C) 2010-2015 Free Software Foundation, Inc. This is free software
Copyright 1992-2019 Free Software Foundation, Inc.
Copyright (C) 2014 Free Software Foundation, Inc. This is free software
Copyright (C) 2011 Free Software Foundation, Inc. This config.lt script is free software
Copyright 2018-2019 Björn Esser
Copyright 2016-2018 Alexander Peslyak All rights reserved.
Copyright (C) 2018 Björn Esser <besser82@fedoraproject.org>
Copyright (C) 2002-2018 Free Software Foundation, Inc.
Copyright (C) 2001-2018 Free Software Foundation, Inc.
Copyright (C) 1997-2018 Free Software Foundation, Inc.
Copyright (C) 1999-2018 Free Software Foundation, Inc.
Copyright (C) 2012-2018 Free Software Foundation, Inc.
Copyright (C) 2003-2018 Free Software Foundation, Inc.
Copyright (C) 2009-2018 Free Software Foundation, Inc.
Copyright (C) 2006-2018 Free Software Foundation, Inc.
Copyright (C) 2004-2018 Free Software Foundation, Inc.
Copyright © 2012-2015 Dan Nicholson <dbn.lists@gmail.com>
copyright either version 2 of the License, or dnl (at your option)
Copyright (c) 2011 Daniel Richard G. <skunk@iSKUNK.ORG>
Copyright (C) 2004-2005, 2007-2009, 2011-2015 Free Software Foundation, Inc. Written by Gary V. Vaughan, 2004
Copyright (C) 2004-2005, 2007-2008, 2011-2015 Free Software Foundation, Inc. Written by Gary V. Vaughan, 2004
Copyright (C) 2004, 2011-2015 Free Software Foundation, Inc. Written by Scott James Remnant, 2004
Copyright (C) 2004-2005, 2007, 2009, 2011-2015 Free Software Foundation, Inc. Written by Scott James Remnant, 2004.
Copyright © 2012-2015 Dan Nicholson <dbn.lists@gmail.com>
copyright 1992-2017 Free Software Foundation. dnl dnl This program is free software
Copyright © 2012-2015 Dan Nicholson <dbn.lists@gmail.com> dnl dnl This program is free software
Copyright (C) 2012 Free Software Foundation, Inc. This configure script is free software
Copyright (C) 2012 Free Software Foundation, Inc. This config.status script is free software
Copyright (c) 2017 Zack Weinberg and it is hereby released to the general public under the following terms:
Copyright 2012-2018 Alexander Peslyak All rights reserved.
Copyright (c) 2001 Alexander Peslyak and it is hereby released to the general public under the following terms:
Copyright (c) 1998-1999 Archie Cobbs <archie@freebsd.org>
Copyright (c) 2003 Michael Bretterkieber
Copyright (c) 2017-2019 Björn Esser <besser82@fedoraproject.org>
Copyright (c) 2017-2019 Zack Weinberg <zackw at panix.com> All rights reserved.
Copyright 2013-2018 Alexander Peslyak All rights reserved.
Copyright (c) 1998-2014 Solar Designer and it is hereby released to the general public under the following terms:
Copyright (c) 2015 Allan Jude <allanjude@FreeBSD.org> All rights reserved.
Copyright (C) 2019 Björn Esser
Copyright © 2012-2015 Dan Nicholson <dbn.lists@gmail.com>

LICENCE TERMS (cont.)

Copyright 2002, 2003, 2004 SuSE Linux AG, Germany
Copyright 2005, 2008, 2009 2011 SUSE LINUX Products GmbH, Germany
Copyright 2015 Björn Esser
Copyright 2000-2011 Solar Designer, 2017 Zack Weinberg, and it is hereby released to the general public under the following terms:
Copyright 2000-2011 Solar Designer, 2017, 2018 Zack Weinberg, and it is hereby released to the general public under the following terms:
Copyright (C) 1994 X Consortium
Copyright (C) 1996-2015 Free Software Foundation, Inc. This is free software
Copyright (C) 1999-2018 Free Software Foundation, Inc. Written by Tom Tromej <tromej@cygnus.com>.
Copyright 1992-2019 Free Software Foundation, Inc.
Copyright (C) 1999-2018 Free Software Foundation, Inc.
Copyright (C) 2004-2005, 2007, 2009, 2011-2015 Free Software Foundation, Inc. Written by Scott James Remnant, 2004.
Copyright (C) 2004, 2011-2015 Free Software Foundation, Inc. Written by Scott James Remnant, 2004
Copyright (C) 1996-2001, 2003-2015 Free Software Foundation, Inc. Written by Gordon Matzigkeit, 1996
Copyright (C) 2004-2005, 2007-2008, 2011-2015 Free Software Foundation, Inc. Written by Gary V. Vaughan, 2004
Copyright (C) 2004-2005, 2007-2009, 2011-2015 Free Software Foundation, Inc. Written by Gary V. Vaughan, 2004
Copyright (C) 1996-2018 Free Software Foundation, Inc. Originally written by Fran.cois Pinard <pinard@iro.umontreal.ca>, 1996.
Copyright (C) 1994-1996, 1999-2002, 2004-2016 Free Software Foundation, Inc.
Copyright (C) 1998 Bjorn Reese and Daniel Stenberg.
Copyright (C) 2001 Bjorn Reese <breeser@users.sourceforge.net>
Copyright (C) 1994-2018 Free Software Foundation, Inc.
Copyright (C) 2000,2012 Bjorn Reese and Daniel Veillard.
Copyright (C) 2001 Bjorn Reese and Daniel Stenberg.
Copyright (C) 1996-2018 Free Software Foundation, Inc.
Copyright 1998 by Sun Microsystems, Inc. All Rights Reserved.
Copyright 1997 Fuji Xerox Information Systems Co.,Ltd. *
copyright 1998 by Sun Microsystems, Inc. All Rights Reserved.
Copyright University of Edinburgh, HCRC February 2008.
Copyright Richard Tobin, HCRC July 2003.
Copyright Richard Tobin, HCRC June 2006.
Copyright Richard Tobin, HCRC February 2003.
(C) 1999, 2000 WAP Forum Ltd. All rights reserved
(C) 1999, 2000 WAP Forum Ltd. All rights reserved
Copyright (C) 1998 James Clark. All rights reserved.
Copyright 1998-1999 by Sun Microsystems, Inc. All Rights Reserved.
Copyright (c) 2000. All Rights Reserved. International Press Telecommunications Council <http://www.iptc.org>
(C) Copyright IBM Corp. 2000 All rights reserved.
(C) Copyright IBM Corp. 2003 All rights reserved.
copyright Netscape Communications, 1999
(C) 1999, 2000 WAP Forum Ltd. All rights reserved
Copyright (c) 2010-2017 Christopher Swenson.
Copyright (C) 2000 Bjorn Reese and Daniel Stenberg.
© 2000 GameSquad.net All Rights Reserved.
Copyright (C) 1992-1996, 1998-2012 Free Software Foundation, Inc.
Copyright 2000 Example.com. All rights reserved. T
Copyright 2000 Example.com. All rights reserved.
(C) International Organization for Standardization 1986
Copyright (c) 1998-1999 W3C (MIT, INRIA, Keio), All Rights Reserved.
Copyright (c) IPTC, 2000 All rights reserved NewsML is a trademark of IPTC
© Copyright Microsoft Corporation, 1999
© 2000 GameSquad.net All Rights Reserved.
Copyright (C) 2011 Free Software Foundation, Inc.
Copyright (C) 1994-2018 Free Software Foundation, Inc.
Copyright © 2002, 2003 John Fleck Revision 1 Revision 2 Revision 3 Revision 4 Revision 5 Revision 6 Revision 7

Revision 8 Revision 9 Revision 7
Copyright (C) 2003-2012 Daniel Veillard.
Copyright (C) 2000 Gary Pennington and Daniel Veillard.
Copyright (C) 2004-2015 Free Software Foundation, Inc. This is free software
Copyright (C) 2010-2015 Free Software Foundation, Inc. This is free software
Copyright 1992-2019 Free Software Foundation, Inc.
Copyright (C) 2014 Free Software Foundation, Inc. This is free software
Copyright (C) 2011 Free Software Foundation, Inc. This config.lt script is free software
Copyright (C) 1998-2012 Daniel Veillard. All Rights Reserved.
Copyright (C) 2002-2018 Free Software Foundation, Inc.
Copyright (C) 2001-2018 Free Software Foundation, Inc.
Copyright (C) 1997-2018 Free Software Foundation, Inc.
Copyright (C) 1999-2018 Free Software Foundation, Inc.
Copyright (C) 2003-2018 Free Software Foundation, Inc.
Copyright (C) 2009-2018 Free Software Foundation, Inc.
Copyright (C) 2006-2018 Free Software Foundation, Inc.
Copyright (C) 2004-2018 Free Software Foundation, Inc.
Copyright © 2004 Scott James Remnant <scott@netsplit.com>.
Copyright © 2012-2015 Dan Nicholson <dbn.lists@gmail.com> dnl dnl This program is free software
Copyright (C) 2004-2005, 2007-2009, 2011-2015 Free Software Foundation, Inc. Written by Gary V. Vaughan, 2004
Copyright (C) 2004-2005, 2007-2008, 2011-2015 Free Software Foundation, Inc. Written by Gary V. Vaughan, 2004
Copyright (C) 2004, 2011-2015 Free Software Foundation, Inc. Written by Scott James Remnant, 2004
copyright 1999 by OASIS.
copyright 1999 by OASIS.
copyright 2001 by OASIS.
Copyright (c) 2012 Vojtech Fried.
Copyright (c) 2012 Google Inc. All Rights Reserved.
Copyright (C) 2012 Free Software Foundation, Inc. This configure script is free software
Copyright (C) 2012 Free Software Foundation, Inc. This config.status script is free software
Copyright (C) 1989, 1991 Free Software Foundation, Inc.
Copyright (c) 2006, 2008 Junio C Hamano
Copyright (c) 2008-2009 Atheros Communications Inc.
Copyright 2008, Johannes Berg <johannes@sipsolutions.net>
copyright (c) 2011, ENE TECHNOLOGY INC.
Copyright(c) 2008 - 2011 Intel Corporation. All rights reserved.
Copyright (C) 2019 Advanced Micro Devices, Inc. All rights reserved.
Copyright (C) 2015-2019 Advanced Micro Devices, Inc., All rights reserved.
Copyright (c) 2012, Cresta Technology Corporation <info@crestatech.com>
Copyright (c) 2008-2010, Atheros Communications, Inc. All rights reserved.
Copyright (c) 2001 3Com Corporation
Copyright (c) 1999-2001, Intel Corporation
(C) Copyright 2000 Brian Warner <warner@lothar.com>
Copyright (c) 2014 Intel Corporation. All rights reserved.
Copyright (c) 2014-15 Intel Corporation. All rights reserved.
Copyright (C) 1995, 1996, 1997, 1998, 1999, 2000 QLogic, Inc. All rights reserved.
Copyright (c) 2010, Abilis Systems Sarl
Copyright (c) 2009, DiBcom
Copyright 2017, NXP All rights reserved.
Copyright (c) 2014, Renesas Electronics Corporation All rights reserved.
Copyright (c) 2017, NETRONOME Systems, Inc. All rights reserved.
Copyright (c) 2015, Intel Corporation. All rights reserved.
Copyright (c) 2018, Cadence Design Systems, Inc. All rights reserved.
Copyright (c) 2013 Qualcomm Atheros, Inc.
Copyright (c) 2015 Texas Instruments Incorporated
Copyright (2006) Ikanos Communications, Inc.
Copyright (C) 2015 Atmel Corporation. All rights reserved.
COPYRIGHT © 1994 - 1995 by AT&T. All Rights Reserved

LICENCE TERMS (cont.)

Copyright (c) 2018 NXP. All rights reserved.
Copyright (c) 2014, Intel Corporation. All rights reserved.
Copyright (c) 1996-2011 Express Logic Inc.
Copyright (c) 1996-2011 Express Logic Inc.
Copyright (c) 1996-2011 Express Logic
Copyright (c) 2003-2004, Cavium. All rights reserved.
COPYRIGHT 2001 QLOGIC CORPORATION ISP2300 Firmware Version 03.03.28
Copyright (C) 2010-2018 Advanced Micro Devices, Inc., All rights reserved.
Copyright (c) ST Microelectronics
Copyright © 2003-2013 QLogic Corporation QLogic Linux Intelligent Ethernet (3000 and 3100 Series) Adapter Firmware
Copyright © 2014, Intel Corporation. All rights reserved.
Copyright (C) 2001 Convergence integrated media GmbH Written by Ralph Metzler rjkm@convergence.de>
COPYRIGHT 2001 QLOGIC CORPORATION ISP2200 Firmware Version 02.02.08
Copyright (c) 2006-2015, Intel Corporation. All rights reserved.
Copyright (c) 2007, Atheros Communications, Inc. All right reserved.
(C) Copyright 2018 Linaro Ltd
(C) Copyright 2018 Raspberry Pi (Trading) Ltd.
(C) Copyright 2018 Raspberry Pi (Trading) Ltd.
Copyright © 2015, Cavium, Inc. All rights reserved.
Copyright (C) 1995-1999 Madge Networks Ltd.
Copyright (c) 2000 —2013 Texas Instruments Incorporated
Copyright (c) 2006, One Laptop per Child and Marvell Corporation. All rights reserved.
Copyright (C) 2009-2017 Advanced Micro Devices, Inc. All rights reserved.
Copyright (c) 2015-2017, Qualcomm Atheros, Inc. All rights reserved.
Copyright (c) 2017, Intel Corporation. All rights reserved.
Copyright (c) 2009, Xceive Corporation <info@xceive.com>
Copyright (c) 2007, Ralink Technology Corporation All rights reserved.
Copyright 1999 Kawasaki LSI.
Copyright (c) 2016 Texas Instruments Incorporated
Copyright (c) 2015, Qualcomm Atheros, Inc. All rights reserved.
(c) Madge Networks Ltd 1995. All rights reserved.
Copyright (c) 2006-2010, Myricom Inc. All rights reserved.
Copyright Ben Hutchings 2011.
Copyright (C) 2018 Microchip Technology Incorporated and its subsidiaries. All rights reserved.
Copyright (c) 2016, Fuzhou Rockchip Electronics Co.Ltd All rights reserved.
Copyright (C) 2007 Free Software Foundation, Inc.
Copyright 1998 Inside Out Networks PassFAIL
COPYRIGHT 2017 QLOGIC CORPORATION ISP25xx Firmware Version 8.07.00
Copyright (c) 2008, Intel Corporation.
COPYRIGHT 2017 QLOGIC CORPORATION ISP24xx Firmware Version 8.07.00
Copyright (c) 2005-2014 Siano Mobile Silicon Ltd. All rights reserved.
Copyright (c) 2013, Ralink, A MediaTek Company All rights reserved.
(c) adapters
Copyright © 2019. Marvell International Ltd. All rights reserved.
Copyright (c) 2012, Creative Technology Ltd All rights reserved.
Copyright (c) 2014, ITE Tech. Inc.
Copyright 1998-2010 VIA Technologies, Inc. All Rights Reserved.
Copyright (c) 2010, Realtek Semiconductor Corporation All rights reserved.
Copyright 2009-2011 Christian Lamparter <chunkeey@googlemail.com>
Copyright 2010-2011 Christian Lamparter <chunkeey@googlemail.com>
Copyright (c) 2003-2006 Thomas Graf <tgraf@suug.ch>
Copyright 2011, Christian Lamparter <chunkeey@googlemail.com>
Copyright 2009 Kitware, Inc.
Copyright 2006-2009 Kitware, Inc.
Copyright 2007-2009 Kitware, Inc.
Copyright (c) 2009 Andreas Schneider <mail@cynapses.org>

Copyright (C) 2002 Roman Zippel <zippel@linux-m68k.org>
Copyright (C) 2002-2005 Roman Zippel <zippel@linux-m68k.org>
Copyright (c) 2000-2005 ZyDAS Technology Corporation
Copyright (C) 1999 Niibe Yutaka
Copyright (C) 1994, 1995, 1997, 1998, 1999, 2000, 2001, 2002, 2003, 2004, 2005, 2006 Free Software Foundation, Inc.
"Copyright 2011 Christian Lamparter <chunkeey@googlemail.com>"
Copyright (C) 2004,2008 Kustaa Nyholm
Copyright (C) 2006 Free Software Foundation, Inc.
Copyright (c) 2001-2002, SSH Communications Security Corp and Jouni Malinen jkmaline@cc.hut.fi>
Copyright (c) 2007-2013, ST Microelectronics NV. All rights reserved.
Copyright (c) 2011 Chelsio Communications All rights reserved.
COPYRIGHT 2001 QLOGIC CORPORATION ISP2100 Firmware Version 01.19
Copyright (c) 1996-2010 Express Logic Inc.
(c) Bernd Porr GNU public license no warranty
(c) Bernd Porr, BerndPorr@f2s.com GPL, GNU public license
Copyright (C) 2004,2009 Bernd Porr, Bernd.Porr@f2s.com
Copyright (C) 2004,2009 Bernd Porr, Bernd.Porr@f2s.com
Copyright (C) 2010,2015 Bernd Porr, mail@berndporr.me.uk
Copyright (c) 2003-2017 QLogic Corporation QLogic Linux Fibre Channel Adapter Firmware
Copyright 2009-2011 Christian Lamparter <chunkeey@googlemail.com>
Copyright (c) 2007-2008 Atheros Communications, Inc.
Copyright(c) 2008 - 2011 Intel Corporation. All rights reserved. All rights reserved.
Copyright 2005-2007 Rodolfo Giometti <giometti@linux.it>
Copyright (c) 2013-2017 Qualcomm Technologies, Inc. All rights reserved.
Copyright (c) 1998-2011 The OpenSSL Project. All rights reserved.
Copyright (C) 1995-1998 Eric Young (eay@cryptsoft.com) All rights reserved.
Copyright (C) 1995-2005 Jean-loup Gailly
Copyright (C) 1995-2009 Mark Adler
Copyright (C) 1995-2003, 2010 Mark Adler
Copyright (C) 1995-2005 Jean-loup Gailly and Mark Adler
Copyright (c) 2004-2006 Qualphone, Inc. All rights reserved.
Copyright 2000 Aaron D. Gifford. All rights reserved.
copyright (C) 1986 Gary S. Brown.
copyright - THIS IS 100% IN THE PUBLIC DOMAIN
Copyright (c) 2003-2005, Jouni Malinen <jkmaline@cc.hut.fi>
Copyright 1998, 2000 Aaron D. Gifford. All rights reserved.
Copyright (c) 2000-2001, Aaron D. Gifford All rights reserved.
Copyright (c) 1998 Todd C. Miller <Todd.Miller@courtesan.com> All rights reserved.
Copyright (c) 1998 Todd C. Miller <Todd.Miller@courtesan.com>
COPYRIGHT (C) 1986 Gary S. Brown.
COPYRIGHT - THIS IS 100% IN THE PUBLIC DOMAIN
copyright (C) 1986 Gary S. Brown.
Copyright (c) 1994-2009 Red Hat, Inc. All rights reserved.
Copyright (c) 1981-2000 The Regents of the University of California. All rights reserved.
Copyright (c) 1991 by AT&T.
Copyright (C) 1998-2001 by Lucent Technologies All Rights Reserved
Copyright 1989, 1990 Advanced Micro Devices, Inc.
Copyright (C) 1993 by Sun Microsystems, Inc. All rights reserved.
copyright(c) Copyright 1986 HEWLETT-PACKARD COMPANY
Copyright (C) 2001 Hans-Peter Nilsson
Copyright (C) 1999, 2000, 2001, 2002 Stephane Carrez (stcarrez@nerim.fr)
Copyright (c) 2001 Christopher G. Demetriou All rights reserved.
Copyright 2002 SuperH, Inc. All rights reserved
Copyright (c) 1999 Kungliga Tekniska Högskolan Royal Institute of Technology, (Stockholm, Sweden). All rights reserved.
Copyright (c) 2000, 2001 Alexey Zelkin <phantom@FreeBSD.org> All rights reserved.

LICENCE TERMS (cont.)

Copyright (C) 1997 by Andrey A. Chernov, Moscow, Russia. All rights reserved.
Copyright (c) 1997-2002 FreeBSD Project. All rights reserved.
Copyright (c) 1984,2000 S.L. Moshier
Copyright (c)1999 Citrus Project, All rights reserved.
Copyright (C) 1991 DJ Delorie All rights reserved.
Copyright (C) 1990-1999, 2000, 2001 Free Software Foundation, Inc. Contributed by Mark Kettenis <kettenis@phys.uva.nl>, 1997.
Copyright (C) 1996 Xavier Leroy (Xavier.Leroy@inria.fr)
Copyright (c) 1993 Intel Corporation
Copyright 1992, 1993, 1994 Henry Spencer. All rights reserved.
Copyright (c) 2001 Mike Barcroft <mike@FreeBSD.org> All rights reserved.
Copyright (c) 1999, 2000 Konstantin Chuguev. All rights reserved.
Copyright (c) 2003, Artem B. Bituyckiy, SoftMine Corporation. Rights transferred to Franklin Electronic Publishers.
copyright(C) Copyright 2001,2006, International Business Machines Corporation, Sony Computer Entertainment, Incorporated, Toshiba Corporation,
Copyright (c) 1995 Alex Tatmanjants <alex@elvisti.kiev.ua> at Electronni Visti IA, Kiev, Ukraine. All rights reserved.
Copyright (c) 1998, M. Warner Losh <imp@freebsd.org> All rights reserved.
Copyright (C) 1996 by Andrey A. Chernov, Moscow, Russia. All rights reserved.
Copyright (c) 2001 Daniel Eischen <deischen@FreeBSD.org>. All rights reserved.
Copyright (c) 2009 ARM Ltd All rights reserved.
Copyright (c) 2004, 2009 Xilinx, Inc. All rights reserved.
Copyright (c) 1996-2010,2014 Texas Instruments Incorporated <http://www.ti.com/>
Copyright (c) 2004 National Semiconductor Corporation
Copyright (c) 2011, Adapteva, Inc. All rights reserved.
Copyright (c) 2003 Altera Corporation All rights reserved.
Copyright (c) 2008 Ed Schouten <ed@FreeBSD.org> All rights reserved.
COPYRIGHT(c) Copyright 1986 HEWLETT-PACKARD COMPANY
COPYRIGHT(C) Copyright 2001,2006, International Business Machines Corporation, Sony Computer Entertainment, Incorporated, Toshiba Corporation,
Copyright(c) Copyright 1986 HEWLETT-PACKARD COMPANY
Copyright(C) Copyright 2001,2006, International Business Machines Corporation, Sony Computer Entertainment, Incorporated, Toshiba Corporation,
Copyright (c) 2013 QUALCOMM ATHEROS Incorporated. All rights reserved.
Copyright (c) 2005-2012 Atheros Communications Inc.
Copyright (c) 2002-2005 Sam Leffler, Errno Consulting
Copyright (c) 2002-2005 Atheros Communications, Inc.
Copyright (c) 2008-2010, Atheros Communications Inc.
Copyright (C) 1998, 1999, 2000, 2001, 2002 Red Hat, Inc.
Copyright (C) 2002 Gary Thomas
Copyright (c) 2013 Tensilica Inc.
COPYRIGHT © 1996 - 2000 by Lucent Technologies. All Rights Reserved
COPYRIGHT © 2001 - 2004 by Agere Systems Inc. All Rights Reserved All rights reserved.
Copyright (c) 2006 David Gibson, IBM Corporation All rights reserved.
Copyright (c) 2006,2008-2011 Joseph Koshy All rights reserved.
Copyright (C) 2006 Matthieu CASTET <castet.matthieu@free.fr>
Copyright (c) 1997-1999 Yamaha Corporation. All Rights Reserved.
Copyright (C) 1999-2001 Keyspan, A division of InnoSys Incorporated ("Keyspan")
Copyright (c) 1999-2002 Emagic as an unpublished work.
Copyright (C) 2004 Texas Instruments
Copyright (C) 2005 Multi-Tech Systems, Inc.
Copyright (C) 2000-2002 ConnectTech Inc
Copyright (C) 2001 STMicroelectronics, Inc. Contact: steve.miller@st.com Description
Copyright (C) 1999 BayCom GmbH
Copyright (C) 1998 Inside Out Networks, All rights reserved.
Copyright (C) 2001 Inside Out Networks, All rights reserved.
Copyright (c) 1994 Creative Technology Ltd. Microcode files for SB16 Advanced Signal Processor
Copyright (C) 1999-2009 Alacritch, Inc.

Copyright (c) 2007-2009 NetLogic Microsystems, Inc.
Copyright (C) 2000-2013 Broadcom Corporation.
Copyright (C) 2007 Tehuti Networks Ltd.
Copyright 1999-2004 3Com Corporation. All Rights Reserved.
copyright(C) F6FBB 1998
Copyright (C) 1998, 1999, 2000 David A. Hinds
Copyright (c) 2007-2011 Broadcom Corporation
Copyright (c) 2007-2011 Broadcom Corporation.
Copyright (c) 2004 - 2010 Broadcom Corporation.
Copyright (c) 1998-2002 by Paul Davis <pbd@op.net>
Copyright 1999 Matrox Graphics Inc. All Rights Reserved.
Copyright 2000 Advanced Micro Devices, Inc.
Copyright 2007-2009 Advanced Micro Devices, Inc. All Rights Reserved.
Copyright (c) 2007, 2008 QLogic Corporation. All rights reserved.
Copyright (c) 2015-2018 QLogic Corporation.
Copyright (c) 2010 Exar Corporation.
Copyright © 2010 STMicroelectronics
Copyright © 2011-2013, Realtek Semiconductor Corporation
Copyright (C) 2013 Comtrol Corporation
Copyright (c) 2011-2013 Sagrad, Inc.
Copyright (c) 2013-2014 Brocade Communications Systems, Inc.
Copyright (c) 2014-2015 QLogic Corporation.
Copyright (C) 2019 Redpine Signals Inc.
Copyright (c) 2017-2019 Mellanox Technologies, Ltd. All rights reserved.
Copyright (C) 2001 STMicroelectronics, Inc. Contact: steve.miller@st.com
COPYRIGHT(C) F6FBB 1998
Copyright (C) 1999-2001 Keyspan,
Copyright (c) 1999-2002 Emagic as an unpublished work.
Copyright (C) 2001 STMicroelectronics, Inc. Contact: steve.miller@st.com
Copyright(C) F6FBB 1998
Copyright (c) 2016 Qualcomm Atheros, Inc. All rights reserved.
Copyright (c) 1991, 1993 The Regents of the University of California. All rights reserved.
Copyright (c)2014 Qualcomm Atheros, Inc. All Rights Reserved.
Copyright (c) 1990, 1993 The Regents of the University of California. All rights reserved.
Copyright (c) 2011 The FreeBSD Foundation All rights reserved.
Copyright (c) 1998 The NetBSD Foundation, Inc. All rights reserved.
Copyright (c) 2002-2005, Jouni Malinen <jkmaline@cc.hut.fi>
Copyright (c) 1998-2008 Tensilica Inc.
Copyright (c) 2012 Qualcomm Atheros, Inc. All Rights Reserved.
Copyright (c) 2002-2004 Sam Leffler, Errno Consulting All rights reserved.
Copyright (c) 1988, 1993 The Regents of the University of California. All rights reserved.
Copyright (c) 2003-2006 Marcus Geelard
Copyright (c) 2011 Qualcomm Atheros, Inc. All Rights Reserved.
Copyright (c) 2006-2007 Atheros Communications Inc.
Copyright (c) 1990 The Regents of the University of California. All rights reserved.
Copyright (c) 2012 Qualcomm Atheros, Inc. All Rights Reserved.
Copyright (c) 1999-2006 by Tensilica Inc.
Copyright (c) 2014 Qualcomm Atheros, Inc. All rights reserved.
Copyright (c) 2014 Qualcomm Atheros, Inc. All Rights Reserved.
Copyright (c) 2011 Qualcomm Atheros, Inc. All Rights Reserved.
Copyright (c) 2004-2005, Jouni Malinen <jkmaline@cc.hut.fi>
Copyright (c) 2003-2006, Jouni Malinen <j@w1.fi>
Copyright (c) 2006-2007, Jouni Malinen <j@w1.fi>
Copyright (c) 2003-2007, Jouni Malinen <j@w1.fi>
Copyright (c) 2002-2013, Jouni Malinen <j@w1.fi>
Copyright (c) 2003-2008, Jouni Malinen <j@w1.fi>
Copyright (c) 2010-2011, embWiSe Technologies

LICENCE TERMS (cont.)

Copyright (c) 2013 Atheros Communications Inc.
Copyright (c) 2012, Atheros Communications Inc.
Copyright (c) 2011 by QUALCOMM Technologies, Incorporated. All Rights Reserved.
Copyright (c) 2006-2007 Atheros Communications Inc.
Copyright (c) 2011 Qualcomm Atheros, Inc. All Rights Reserved. .
Copyright (c) 2014 Qualcomm Atheros, Inc. All Rights Reserved. .
Copyright (c) 2006-2007 Atheros Communications Inc.
Copyright (c) 2014 Qualcomm Atheros, Inc. All Rights Reserved.
Copyright (c) 2011 Qualcomm Atheros, Inc. All Rights Reserved.
Copyright (c) 2017 Qualcomm Technologies, Inc. All rights reserved.
Copyright (c) 2006-2007 Atheros Communications Inc.
Copyright (c)2014 Qualcomm Atheros, Inc. All Rights Reserved.
Copyright (c) 2015 Qualcomm Atheros, Inc. All rights reserved.
Copyright (c) 2003-2005, Jouni Malinen <jkmaline@cc.hut.fi>
Copyright (c) 2017 Qualcomm Atheros, Inc. All rights reserved.
Copyright (c) 2014 Qualcomm Atheros, Inc. All rights reserved.
Copyright (c) 1998 Todd C. Miller <Todd.Miller@courtesan.com>
Copyright (c) 2018, Cavium, Inc. All rights reserved.
Copyright (C) 1989, 1991 Free Software Foundation, Inc.
Copyright 2006 Tristan Carel
Copyright 2006-2008 Andreas Schneider <mail@cynapses.org>
Copyright 2007 Wengo
Copyright 2007 Mike Jackson
Copyright 2008 Andreas Pakulat <apaku@gmx.de>
Copyright 2008-2009 Philip Lowman <philip@yhbt.com>
Copyright (C) 2002-2005 Sam Ravnborg <sam@ravnborg.org>
Copyright (c) 2007-2009 Atheros Communications, Inc.
Copyright (c) 2009-2011 Christian Lamparter <chunkeey@googlemail.com>
"Copyright 2009 Johannes Berg <johannes@sipsolutions.net>"
"Copyright 2009-2011 Christian Lamparter <chunkeey@googlemail.com>"
Copyright (c) 2002-2003, Jouni Malinen <jkmaline@cc.hut.fi>
Copyright (c) 2005, Devicescape Software, Inc.
Copyright (c) 2006, Michael Wu <flamingice@sourmilk.net>
Copyright 2009 Jerome Glisse
Copyright 2009 Red Hat Inc.
Copyright (c) 1998-2002 The OpenSSL Project. All rights reserved.
Copyright (c) 2003 Stichting NLnet Labs
Copyright (c) 2001, 2002, 2003 Steven Knight
Copyright (c) 2006, 2008 Junio C Hamano
Copyright (C) 2005 Olivier Gay <olivier.gay@a3.epfl.ch> All rights reserved.
Copyright (c) 2016 SanDisk Corp.
Copyright (C) 2005, 2007 Olivier Gay <olivier.gay@a3.epfl.ch> All rights reserved.
Copyright (C) ST-Ericsson SA 2010-2011 Author: Sebastian Rasmussen <sebastian.rasmussen@stericsson.com>
Copyright 1992-2019 Free Software Foundation, Inc.
Copyright (c) 2006, 2008 Junio C Hamano
Copyright (c) 1998-2015,2018 Free Software Foundation, Inc.
Copyright (c) 1998-2018,2019 Free Software Foundation, Inc.
Copyright (c) 1998-2017,2018 Free Software Foundation, Inc.
Copyright (C) 1994 X Consortium
Copyright (c) 2008 Free Software Foundation, Inc.
Copyright (c) 2004-2011,2012 Free Software Foundation, Inc.
Copyright (c) 1998-2017,2019 Free Software Foundation, Inc.
Copyright (c) 2011-2017,2019 Free Software Foundation, Inc.
Copyright (c) 2002-2017,2018 Free Software Foundation, Inc.
Copyright (c) 2008-2018,2019 Free Software Foundation, Inc. *
Copyright (c) 1998,2000 Free Software Foundation, Inc.
Copyright (c) 1998-2015,2016 Free Software Foundation, Inc. *

Copyright (c) 2007-2014,2015 Free Software Foundation, Inc. *
Copyright (c) 2015-2017,2018 Free Software Foundation, Inc.
Copyright (c) 1998-2003,2006 Free Software Foundation, Inc.
Copyright (c) 1999-2010,2018 Free Software Foundation, Inc. *
Copyright (c) 1998,2006 Free Software Foundation, Inc. *
Copyright (c) 2006-2017,2018 Free Software Foundation, Inc.
Copyright (c) 2009-2015,2018 Free Software Foundation, Inc.
Copyright (c) 1998-2005,2007 Free Software Foundation, Inc.
Copyright (c) 2002 Free Software Foundation, Inc.
Copyright (c) 1998-2017,2019 Free Software Foundation, Inc.
Copyright (c) 2000-2016,2017 Free Software Foundation, Inc. *
Copyright (c) 1999-2016,2018 Free Software Foundation, Inc. *
Copyright (c) 1998-2012,2018 Free Software Foundation, Inc.
Copyright (c) 1998-2018,2019 Free Software Foundation, Inc.
Copyright (c) 1998-2018,2019 Free Software Foundation, Inc.
Copyright (c) 1998-2000,2006 Free Software Foundation, Inc.
Copyright (c) 1998-2015,2018 Free Software Foundation, Inc. *
Copyright (c) 2010 Free Software Foundation, Inc. *
Copyright (c) 1998-2016,2018 Free Software Foundation, Inc. *
Copyright (c) 1998-1999,2006 Free Software Foundation, Inc.
Copyright (c) 2005-2016,2017 Free Software Foundation, Inc. *
Copyright (c) 1998,2003 Free Software Foundation, Inc.
Copyright (c) 2010-2017,2018 Free Software Foundation, Inc.
Copyright (c) 2010-2016,2018 Free Software Foundation, Inc.
Copyright 1992, 1993, 1994, 1995, 1996, 1998, 1999, 2000, 2001 Free Software Foundation, Inc.
Copyright (c) 2010-2017,2019 Free Software Foundation, Inc.
Copyright (c) 2000 Free Software Foundation, Inc.
Copyright (c) 1998-2010,2018 Free Software Foundation, Inc. *
Copyright (c) 2000-2011,2014 Free Software Foundation, Inc.
Copyright (c) 1998,2006 Free Software Foundation, Inc.
Copyright (c) 2008-2015,2017 Free Software Foundation, Inc. *
Copyright (c) 2002-2011,2012 Free Software Foundation, Inc. *
Copyright (c) 1998-2008,2011 Free Software Foundation, Inc.
Copyright (c) 1998-2009,2011 Free Software Foundation, Inc.
Copyright (c) 2002-2012,2017 Free Software Foundation, Inc. *
Copyright (c) 1998-2011,2014 Free Software Foundation, Inc.
Copyright (c) 2010-2018,2019 Free Software Foundation, Inc. *
Copyright (c) 1998-2006,2009 Free Software Foundation, Inc.
Copyright (c) 1998-2003,2009 Free Software Foundation, Inc.
Copyright (c) 2000,2006 Free Software Foundation, Inc.
Copyright (c) 2010-2014,2016 Free Software Foundation, Inc. *
Copyright (c) 1998-2018,2019 Free Software Foundation, Inc. *
Copyright (c) 1998-2006,2011 Free Software Foundation, Inc.
Copyright (c) 1998-2006,2008 Free Software Foundation, Inc.
Copyright (c) 2000-2011,2018 Free Software Foundation, Inc.
Copyright (c) 1998-2017,2019 Free Software Foundation, Inc. *
Copyright (c) 2000,2003 Free Software Foundation, Inc.
Copyright (c) 1998-2004,2009 Free Software Foundation, Inc.
Copyright (c) 2000-2008,2009 Free Software Foundation, Inc.
Copyright (c) 1998-2003,2009 Free Software Foundation, Inc.
Copyright (c) 1998-2014,2018 Free Software Foundation, Inc.
Copyright (c) 1998-2004,2009 Free Software Foundation, Inc.
Copyright (c) 2000-2006,2009 Free Software Foundation, Inc.
Copyright (c) 1998-2015,2018 Free Software Foundation, Inc.
Copyright (c) 2000-2008,2014 Free Software Foundation, Inc.
Copyright (c) 1998-2011,2014 Free Software Foundation, Inc.
Copyright (c) 2000-2007,2008 Free Software Foundation, Inc.

LICENCE TERMS (cont.)

Copyright (c) 2005-2012,2017 Free Software Foundation, Inc. *
Copyright (c) 1998-2000,2012 Free Software Foundation, Inc. *
Copyright (c) 2007-2011,2019 Free Software Foundation, Inc.
Copyright (c) 1998-2010,2019 Free Software Foundation, Inc.
Copyright (c) 1998-2005,2010 Free Software Foundation, Inc. *
Copyright (c) 2000-2012,2017 Free Software Foundation, Inc. *
Copyright (c) 2007-2009,2019 Free Software Foundation, Inc.
Copyright (c) 2006-2017,2019 Free Software Foundation, Inc. *
Copyright (c) 1999-2018,2019 Free Software Foundation, Inc. *
Copyright (c) 1998-2009,2013 Free Software Foundation, Inc. *
Copyright (c) 1998-2011,2015 Free Software Foundation, Inc. *
Copyright (c) 2013-2014,2016 Free Software Foundation, Inc. *
Copyright (c) 2006-2013,2019 Free Software Foundation, Inc. *
Copyright (c) 2001-2018,2019 Free Software Foundation, Inc. *
Copyright (c) 2012-2017,2019 Free Software Foundation, Inc. *
Copyright (c) 2002-2011,2016 Free Software Foundation, Inc. *
Copyright (c) 2004-2016,2019 Free Software Foundation, Inc. *
Copyright (c) 2004,2009 Free Software Foundation, Inc. *
Copyright (c) 2003-2008,2018 Free Software Foundation, Inc. *
Copyright (c) 2002-2010,2016 Free Software Foundation, Inc. *
Copyright (c) 2007,2017 Free Software Foundation, Inc. *
Copyright (c) 2002-2016,2018 Free Software Foundation, Inc. *
Copyright (c) 2012-2013,2018 Free Software Foundation, Inc. *
Copyright (c) 2002-2009,2016 Free Software Foundation, Inc. *
Copyright (c) 2002-2009,2011 Free Software Foundation, Inc. *
Copyright (c) 2002-2011,2018 Free Software Foundation, Inc. *
Copyright (c) 2002-2007,2009 Free Software Foundation, Inc. *
Copyright (c) 2002-2017,2019 Free Software Foundation, Inc. *
Copyright (c) 2001-2011,2012 Free Software Foundation, Inc. *
Copyright (c) 2003-2011,2016 Free Software Foundation, Inc. *
Copyright (c) 2002-2010,2014 Free Software Foundation, Inc. *
Copyright (c) 2008-2017,2019 Free Software Foundation, Inc. *
Copyright (c) 2013-2016,2017 Free Software Foundation, Inc. *
Copyright (c) 2009-2018,2019 Free Software Foundation, Inc. *
Copyright (c) 1998-2008,2010 Free Software Foundation, Inc. *
Copyright (c) 1989 BULL SA
Copyright 1992, 1993, 1994, 1995, 1996, 1998, 1999, 2000, 2001 Free Software Foundation, Inc.
Copyright: 2010-2018,2019 by Thomas E. Dickey
Copyright: 1994 X Consortium Licence
Copyright: 2010-2018,2019 by Thomas E. Dickey
Copyright: 1994 X Consortium Licence
Copyright: 2003-2018,2019 by Thomas E. Dickey
Copyright: 2003-2018,2019 by Thomas E. Dickey
Copyright (C) 2012 Free Software Foundation, Inc.
Copyright: 1996-2018,2019 by Thomas E. Dickey
Copyright: 2001 by Pradeep Padala
Copyright: 1994 X Consortium
Copyright: 1980,1991,1992,1993 The Regents of the University of California.
Copyright: 1996-2018,2019 by Thomas E. Dickey
Copyright: 2001 by Pradeep Padala
Copyright: 1994 X Consortium
Copyright: 1980,1991,1992,1993 The Regents of the University of California.
Copyright (c) 1980, 1991, 1993 The Regents of the University of California. All rights reserved.
Copyright (c) 1980, 1991, 1993 The Regents of the University of California. All rights reserved.
Copyright (c) 1992, 1993 The Regents of the University of California. All rights reserved.
Copyright (c) 1980, 1993 The Regents of the University of California. All rights reserved.
Copyright (c) 1992, 1993 The Regents of the University of California. All rights reserved.

Copyright (c) 1980, 1993 The Regents of the University of California. All rights reserved.
COPYRIGHT 2001 by Pradeep Padala.
Copyright 2001 by Pradeep Padala.
Copyright (c) 1998-2018,2019 Free Software Foundation, Inc. *
Copyright (c) 1998-2018,2019 Free Software Foundation, Inc. *
copyright began in 1996.
Copyright (C) 1994 X Consortium
Copyright (C) 1996-2015 Free Software Foundation, Inc. This is free software
Copyright (C) 1999-2018 Free Software Foundation, Inc. Written by Tom Tromey <tromey@cygnus.com>.
Copyright 1992-2019 Free Software Foundation, Inc.
Copyright (C) 1999-2018 Free Software Foundation, Inc.
Copyright (C) 2004-2005, 2007, 2009, 2011-2015 Free Software Foundation, Inc. Written by Scott James Remnant, 2004.
Copyright (C) 2004, 2011-2015 Free Software Foundation, Inc. Written by Scott James Remnant, 2004
Copyright (C) 1996-2001, 2003-2015 Free Software Foundation, Inc. Written by Gordon Matzigkeit, 1996
Copyright (C) 2004-2005, 2007-2008, 2011-2015 Free Software Foundation, Inc. Written by Gary V. Vaughan, 2004
Copyright (C) 2004-2005, 2007-2009, 2011-2015 Free Software Foundation, Inc. Written by Gary V. Vaughan, 2004
Copyright (C) 1996-2018 Free Software Foundation, Inc. Originally written by Fran,cois Pinard <pinard@iro.umontreal.ca>, 1996.
Copyright (C) 2011-2018 Free Software Foundation, Inc.
Copyright (C) 1989, 1991 Free Software Foundation, Inc.
Copyright (C) 1994, 1995, 1996, 1999, 2000, 2001, 2002, 2004, 2005 Free Software Foundation, Inc.
Copyright (C) 2004-2011 Marcel Holtmann <marcel@holtmann.org>
Copyright (C) 1996-2018 Free Software Foundation, Inc.
Copyright (C) 2012 Intel Corporation. All rights reserved.
Copyright (C) 2011 Intel Corporation. All rights reserved.
Copyright (C) 2014 Marvell International Ltd.
Copyright (C) 2013 Intel Corporation. All rights reserved.
Copyright (C) 2013 Mobic Limited. All rights reserved.
Copyright (C) 2015 Marvell International Ltd.
Copyright (C) 2013 Intel Corporation
Copyright (C) 2011-2013 Intel Corporation
Copyright (C) 2011 Instituto Nokia de Tecnologia
Copyright (C) 1992-1996, 1998-2012 Free Software Foundation, Inc.
Copyright (C) 2011-2016 Intel Corporation. All rights reserved.
Copyright (C) 2011 Free Software Foundation, Inc.
Copyright (C) 1994-2018 Free Software Foundation, Inc.
"Copyright 2007, 2008 Johannes Berg <johannes@sipsolutions.net>"
Copyright (C) 2004-2015 Free Software Foundation, Inc. This is free software
Copyright (C) 2010-2015 Free Software Foundation, Inc. This is free software
Copyright 1992-2019 Free Software Foundation, Inc.
Copyright (C) 2014 Free Software Foundation, Inc. This is free software
Copyright (C) 2011 Free Software Foundation, Inc. This config.lt script is free software
Copyright (C) 2002-2018 Free Software Foundation, Inc.
Copyright (C) 2001-2018 Free Software Foundation, Inc.
Copyright (C) 1997-2018 Free Software Foundation, Inc.
Copyright (C) 1999-2018 Free Software Foundation, Inc.
Copyright (C) 2003-2018 Free Software Foundation, Inc.
Copyright (C) 2009-2018 Free Software Foundation, Inc.
Copyright (C) 2006-2018 Free Software Foundation, Inc.
Copyright (C) 2004-2018 Free Software Foundation, Inc.
Copyright © 2004 Scott James Remnant <scott@netsplit.com>.
Copyright © 2012-2015 Dan Nicholson <dbn.lists@gmail.com>
Copyright (C) 2004-2005, 2007-2009, 2011-2015 Free Software Foundation, Inc. Written by Gary V. Vaughan, 2004
Copyright (C) 2004-2005, 2007-2008, 2011-2015 Free Software Foundation, Inc. Written by Gary V. Vaughan, 2004
Copyright (C) 2004, 2011-2015 Free Software Foundation, Inc. Written by Scott James Remnant, 2004
Copyright (C) 2013 Animal Creek Technologies, Inc. All rights reserved.

LICENCE TERMS (cont.)

Copyright (C) 2000-2001 Qualcomm Incorporated
Copyright (C) 2002-2003 Maxim Krasnyansky <maxk@qualcomm.com>
Copyright (C) 2002-2010 Marcel Holtmann <marcel@holtmann.org>
Copyright (C) 2004-2010 Marcel Holtmann <marcel@holtmann.org>
Copyright (C) 2012 Free Software Foundation, Inc. This configure script is free software
Copyright (C) 2012 Free Software Foundation, Inc. This config.status script is free software
Copyright (C) 2011 Instituto Nokia de Tecnologia
Copyright (c) 1993 Fred Baumgarten
Copyright 1993 MicroWalt Corporation
Copyright 1996 Bernd Eckenfels, Germany
Copyright 1999 Bernd Eckenfels, Germany base on Code from Jonathan Naylor <jsn@Cs.Nott.AC.UK>
Copyright 1998 by Andi Kleen. Subject to the GPL.
Copyright 1993,1994 MicroWalt Corporation
Copyright 1998 Andi Kleen
Copyright 1999 Bernd Eckenfels, Germany
Copyright (C) 2000 David A. Hinds
Copyright 1997,1999,2000 Andi Kleen.
Copyright 1988-1993 MicroWalt Corporation
Copyright 1993 MicroWalt Corporation Tom Duffy <tduffy@sun.com>
Copyright (c) 1994 John Paul Morrison (VE7JPM).
Copyright (C) 2000 David A. Hinds -- dhinds@pcmcia.sourceforge.org
Copyright 1998 Andi Kleen
Copyright (C) 2000 David A. Hinds -- dhinds@pcmcia.sourceforge.org
Copyright 1997,1999,2000 Andi Kleen.
Copyright (C) 1999 Free Software Foundation, Inc. Jiř Pavlovskı̇ <pavlovsk@ffcuni.cz>, 1999.
Copyright (C) 1999 Ralf Bł̃hle <ralf@gnu.org> Language-Team: " MIME-Version
Copyright (C) 1999 Ralf Bł̃hle <ralf@gnu.org>
Copyright (C) 1999 J.M.Vansteene <vanstee@worldnet.fr>
Copyright (C) 1999 J.M.Vansteene <vanstee@worldnet.fr>
Copyright (C) 1999 Free Software Foundation, Inc. Meelis Roos <Meelis.Roos@mail.ee>, 1999.
Copyright (C) 2000 Free Software Foundation, Inc. Arnaldo Carvalho de Melo <acme@conectiva.com.br>, 2000.
Copyright: GPL Group: Networking/Admin Source:
Copyright 1995-1996 Bernd Eckenfels, Germany 1998 Arnaldo Carvalho de Melo, Brazil
Copyright (C) 1989, 1991 Free Software Foundation, Inc.
Copyright 1993 MicroWalt Corporation
Copyright 1993 MicroWalt Corporation
Copyright 1993 MicroWalt Corporation
Copyright 1997,1999,2000 Andi Kleen.
Copyright 1995-1996 Bernd Eckenfels, Germany
Copyright 2001 Daniel Stodden
copyright 1997-2000 by Donald Becker becker@scyld.com>
Copyright (C) 1998, 1999 Free Software Foundation, Inc. <ralf@gnu.org>
Copyright (C) 1998, 1999 Free Software Foundation, Inc.
Copyright: © 1988-1994 MicroWalt Corporation
Copyright: © 1995-1996 Bernd Eckenfels
Copyright: © 1997-2000 Andi Kleen
Copyright: © 1997-2000 Donald Becker License
Copyright: © 2008-2009 Luk Claes, Martín Ferrari
Copyright: © 2000-2007 Bernd Eckenfels
Copyright: © 2000 Anthony Towns License:
Copyright: © 1997-2000 Donald Becker License: GPL-2+
Copyright: © 2000 Anthony Towns License
Copyright 1998 by Andi Kleen.
Copyright 1998 Andi Kleen
Copyright (C) 1999 Ralf Bł̃hle <ralf@gnu.org> msgid
Copyright 1988-1993 MicroWalt Corporation
Copyright 1993-1994 Swansea University Computer Society

copyright: Rearranged the summary in the copyright file and listed;copyright: Bumped the version of net-tools.
Ooops.;copyright instead.
Copyright 1994-2010 Peter Tobias, Anthony Towns and Marco d'Itri
Copyright (C) 1994 X Consortium
Copyright (C) 1999-2018 Free Software Foundation, Inc. Written by Tom Tromey <tromey@cygnus.com>.
Copyright 1992-2019 Free Software Foundation, Inc.
Copyright (C) 1999-2018 Free Software Foundation, Inc.
Copyright (C) 1996-2018 Free Software Foundation, Inc. Originally written by Fran,cois Pinard <pinard@iro.umontreal.ca>, 1996.
Copyright (C) 1995-1997, 2000-2007, 2009-2010 by Ulrich Drepper <drepper@gnu.ai.mit.edu>
Copyright 1996-2016 Free Software Foundation, Inc. Taken from GNU libtool, 2001 Originally by Gordon Matzigkeit <gord@gnu.ai.mit.edu>, 1996
Copyright (C) 1989, 1991 Free Software Foundation, Inc.
Copyright 1985, 1986, 1988, 1990, 1991, 1992, 1993, 1994, 1995, 1996, 1997, 1998, 1999, 2000, 2001, 2002, 2003, 2004, 2005, 2006, 2007, 2008, 2009, 2010, 2011, 2012, 2013, 2014, 2015, 2016, 2017, 2018 Free Software Foundation, Inc.
Copyright (C) 1995-2018 Free Software Foundation, Inc. written by Ulrich Drepper <drepper@gnu.ai.mit.edu>, June 1995
Copyright (C) 1987,88,89,90,91,92,93,94,96,97,98 Free Software Foundation, Inc.
Copyright (C) 2002 Giovanni Giacobbi
Copyright (C) 2002 - 2004 Giovanni Giacobbi
Copyright (C) 2002-2003 Lubomir Sedlacik This file is distributed under the same license as the GNU netcat package. Lubomir Sedlacik <salo@Xtrmnr.org>, 2003.
Copyright (C) 1994, 1995, 1996, 1999, 2000, 2001, 2002 Free Software Foundation, Inc.
Copyright (C) 2002-2003 Giovanni Giacobbi This file is distributed under the same license as the GNU netcat package. Giovanni Giacobbi <giovanni@giacobbi.net>, 2003.
Copyright (C) 1995, 1996, 1997, 1998, 1999, 2001, 2002 Free Software Foundation, Inc.
Copyright (C) 2002 - 2003 Giovanni Giacobbi
Copyright (C) 1996-2018 Free Software Foundation, Inc.
Copyright (C) YEAR Free Software Foundation, Inc.
Copyright (C) 1992-1996, 1998-2012 Free Software Foundation, Inc.
Copyright (C) 2002 - 2003 Giovanni Giacobbi
Copyright (C) 1994-2018 Free Software Foundation, Inc.
Copyright (C) 1997-2002 Free Software Foundation, Inc.
Copyright (C) 2000-2002 Free Software Foundation, Inc.
Copyright (C) 2002 Free Software Foundation, Inc.
Copyright (C) 2002 - 2004 Giovanni Giacobbi
Copyright (C) 1999, 2000, 2001 Free Software Foundation, Inc.
Copyright (C) 1995-2002 Free Software Foundation, Inc.
Copyright (C) 1999-2002 Free Software Foundation, Inc.
Copyright (C) 1987,88,89,90,91,92,93,94,95,96,98,99,2000,2001 Free Software Foundation, Inc. This file is part of the GNU C Library.
Copyright (C) 1989-1994, 1996-1999, 2001 Free Software Foundation, Inc. This file is part of the GNU C Library.
Copyright 1992-2019 Free Software Foundation, Inc.
Copyright (C) 2002 - 2003 Giovanni Giacobbi
Copyright (C) 2002 - 2003 Giovanni Giacobbi
Copyright (C) 2002 - 2003 Giovanni Giacobbi
Copyright (C) 2002-2018 Free Software Foundation, Inc.
Copyright (C) 2001-2018 Free Software Foundation, Inc.
Copyright (C) 1997-2018 Free Software Foundation, Inc.
Copyright (C) 1999-2018 Free Software Foundation, Inc.
Copyright (C) 1996-2018 Free Software Foundation, Inc.
Copyright (C) 2003-2018 Free Software Foundation, Inc.
Copyright (C) 2009-2018 Free Software Foundation, Inc.
Copyright (C) 2006-2018 Free Software Foundation, Inc.
Copyright (C) 2004-2018 Free Software Foundation, Inc.
Copyright 2012-2016 Free Software Foundation, Inc.

LICENCE TERMS (cont.)

Copyright (C) 2006, 2009-2016 Free Software Foundation, Inc.
Copyright (C) 1995-2014, 2016 Free Software Foundation, Inc.
Copyright (C) 2000-2002, 2004, 2008, 2010-2016 Free Software Foundation, dnl Inc.
Copyright (C) 2000-2002, 2007-2014, 2016 Free Software Foundation, Inc.
Copyright (C) 2004-2014, 2016 Free Software Foundation, Inc.
Copyright (C) 2002-2005, 2008-2016 Free Software Foundation, Inc.
Copyright (C) 1997-2004, 2006, 2008-2016 Free Software Foundation, Inc.
Copyright (C) 1995-2002, 2004-2005, 2008-2014, 2016 Free Software
Copyright (C) 1996-2003, 2009-2016 Free Software Foundation, Inc.
Copyright (C) 2001-2016 Free Software Foundation, Inc.
Copyright (C) 2001-2005, 2008-2016 Free Software Foundation, Inc.
Copyright (C) 2005-2016 Free Software Foundation, Inc.
Copyright (C) 1999-2007, 2009-2016 Free Software Foundation, Inc.
Copyright (C) 1995-2003, 2005-2006, 2008-2014, 2016 Free Software dnl Foundation, Inc.
Copyright (C) 2003, 2007, 2009-2016 Free Software Foundation, Inc.
Copyright (C) 1996-2003, 2005, 2008-2016 Free Software Foundation, Inc.
Copyright (C) 2003, 2005-2006, 2008-2016 Free Software Foundation, Inc.
Copyright (C) 1997-2004, 2007-2016 Free Software Foundation, Inc.
Copyright (C) 2005, 2008, 2010-2016 Free Software Foundation, Inc.
Copyright (C) 2002-2003, 2008-2016 Free Software Foundation, Inc.
Copyright (C) 2003, 2007-2016 Free Software Foundation, Inc.
Copyright (C) 2003-2004, 2008-2016 Free Software Foundation, Inc.
Copyright (C) 2000-2002 Free Software Foundation, Inc.
Copyright (C) 2002 Free Software Foundation, Inc.
Copyright (C) 1997-2002 Free Software Foundation, Inc.
Copyright (C) 2002-2018 Free Software Foundation, Inc.
Copyright (C) 2001-2018 Free Software Foundation, Inc.
Copyright (C) 1997-2018 Free Software Foundation, Inc.
Copyright (C) 1999-2018 Free Software Foundation, Inc.
Copyright (C) 1996-2018 Free Software Foundation, Inc.
Copyright (C) 2003-2018 Free Software Foundation, Inc.
Copyright (C) 2009-2018 Free Software Foundation, Inc.
Copyright (C) 2006-2018 Free Software Foundation, Inc.
Copyright (C) 2004-2018 Free Software Foundation, Inc.
Copyright 2012-2016 Free Software Foundation, Inc.
Copyright (C) 2006, 2009-2016 Free Software Foundation, Inc.
Copyright (C) 1995-2014, 2016 Free Software Foundation, Inc.
Copyright (C) 2000-2002, 2004, 2008, 2010-2016 Free Software Foundation, dnl Inc.
Copyright (C) 2000-2002, 2007-2014, 2016 Free Software Foundation, Inc.
Copyright (C) 2004-2014, 2016 Free Software Foundation, Inc.
Copyright (C) 2002-2005, 2008-2016 Free Software Foundation, Inc.
Copyright (C) 1997-2004, 2006, 2008-2016 Free Software Foundation, Inc.
Copyright (C) 1995-2002, 2004-2005, 2008-2014, 2016 Free Software dnl Foundation, Inc.
Copyright (C) 1996-2003, 2009-2016 Free Software Foundation, Inc.
Copyright (C) 2001-2016 Free Software Foundation, Inc.
Copyright (C) 2001-2005, 2008-2016 Free Software Foundation, Inc.
Copyright (C) 2005-2016 Free Software Foundation, Inc.
Copyright (C) 1999-2007, 2009-2016 Free Software Foundation, Inc.
Copyright (C) 1995-2003, 2005-2006, 2008-2014, 2016 Free Software dnl Foundation, Inc.
Copyright (C) 2003, 2007, 2009-2016 Free Software Foundation, Inc.
Copyright (C) 1996-2003, 2005, 2008-2016 Free Software Foundation, Inc.
Copyright (C) 2003, 2005-2006, 2008-2016 Free Software Foundation, Inc.
Copyright (C) 1997-2004, 2007-2016 Free Software Foundation, Inc.
Copyright (C) 2005, 2008, 2010-2016 Free Software Foundation, Inc.
Copyright (C) 2002-2003, 2008-2016 Free Software Foundation, Inc.
Copyright (C) 2003, 2007-2016 Free Software Foundation, Inc.
Copyright (C) 2003-2004, 2008-2016 Free Software Foundation, Inc.

Copyright (C) 2000-2002 Free Software Foundation, Inc.
Copyright (C) 2002 Free Software Foundation, Inc.
Copyright (C) 1997-2002 Free Software Foundation, Inc.
Copyright (C) 2012 Free Software Foundation, Inc. This configure script is free software
Copyright (C) 2012 Free Software Foundation, Inc. This config.status script is free software
Copyright (C) 2012 Free Software Foundation, Inc. This configure script is free software
Copyright (C) 2012 Free Software Foundation, Inc. This config.status script is free software
Copyright @copyright{} 1996, 1997, 1998, 2000, 2001 Free Software Foundation, Inc.
Copyright @copyright{} 1996, 1997, 1998, 2000, 2001 Free Software Foundation, Inc.
Copyright @copyright{} 2002 - 2004 Giovanni Giacobbi
Copyright @copyright{} 1996, 1997, 1998, 2000, 2001 Free Software Foundation, Inc.
Copyright @copyright{} 1996, 1997, 1998, 2000, 2001 Free Software Foundation, Inc.
Copyright (C) The Internet Society (1998). All Rights Reserved.
Copyright (C) The Internet Society (1998). All Rights Reserved.
Copyright (C) 1996, 1997, 1998, 2000, 2001 Free Software Foundation, Inc.
Copyright (c) 2002 - 2004 Giovanni Giacobbi
Copyright 1992-2019 Free Software Foundation, Inc.; Copyright 1992-2019 Free Software Foundation, Inc.
Copyright (C) 1989, 1991 Free Software Foundation, Inc., 51 Franklin Street, Fifth Floor, Boston, MA 02110-1301
USA Everyone is permitted to copy and distribute verbatim copies of this license document, but changing it is not allowed.
Copyright (C) 2007 Free Software Foundation, Inc. <<http://fsf.org/>> Everyone is permitted to copy and distribute verbatim copies of this license document, but changing it is not allowed.
Copyright (C) 2007 Free Software Foundation, Inc. <<http://fsf.org/>> Everyone is permitted to copy and distribute verbatim copies of this license document, but changing it is not allowed.
Copyright 2011-2015 Free Software Foundation, Inc.
Copyright (C) 2013 Niels Möller
Copyright (C) 2013, 2014 Niels Möller
Copyright (C) 2013 Niels Möller
Copyright (C) 2012 Niels Möller
Copyright (C) 2001 Niels Möller
Copyright (C) 2017 Daiki Ueno
Copyright (C) 2006, 2007 NTT Nippon Telegraph and Telephone Corporation).
Copyright (C) 2001, 2013 Niels Möller
Copyright (C) 2012 Simon Josefsson
Copyright (C) 2001, 2002 Niels Möller
Copyright (C) 2015 Amos Jeffries, Niels Möller
Copyright (C) 2015 Red Hat, Inc.
Copyright (C) 1992 Dana L. How
Copyright (C) 2000, 2001, 2002 Rafael R. Sevilla, Niels Möller
Copyright (C) 2001, 2003, 2006, 2010 Niels Möller
Copyright (C) 2001, 2003, 2012 Niels Möller
Copyright (C) 1994 X Consortium
Copyright (C) 2013 Nikos Mavrogiannopoulos
Copyright (C) 2013, Niels Möller
Copyright (C) 2015, 2017 Dmitry Eremin-Solenikov
Copyright (C) 2014 Niels Möller
Copyright (C) 2002 Niels Möller
Copyright (C) 2005 Niels Möller
Copyright (C) 2001, 2004 Peter Gutmann, Andrew Kuchling, Niels Möller
Copyright (C) 2010, 2014 Niels Möller
Copyright (C) 2011 Niels Möller
Copyright (C) 2011 Niels Möller
Copyright (C) 2018 Red Hat, Inc.
Copyright (C) 2012 Simon Josefsson, Niels Möller
Copyright (C) 2010 Niels Möller
Copyright (C) 2014 Niels Möller
Copyright (C) 2001, 2003 Niels Möller

Copyright (C) 2013, 2015 Niels Möller
Copyright (C) 2011, 2014 Niels Möller
Copyright (C) 2003 Niels Möller
Copyright (C) 2018 Niels Möller
Copyright (C) 2006, 2012 Jeronimo Pellegrini, Niels Möller
Copyright (C) 2015 Niels Möller
Copyright (C) 2002, 2017 Niels Möller
Copyright (C) 2001, 2010, 2014 Niels Möller
Copyright (C) 2002, 2007 Niels Möller
Copyright (C) 2002, 2012 Niels Möller
Copyright (C) 2002, 2010 Niels Möller
Copyright (C) 2013 Joachim Strömbergson
Copyright (C) 2001, 2010 Niels Möller
Copyright (C) 2012 Simon Josefsson
Copyright (C) 1998, 2001, 2002, 2003 Free Software Foundation, Inc.
Copyright (C) 2002, 2003, 2008 Niels Möller
Copyright (C) 2001, 2012 Niels Möller
Copyright (C) 2005, 2009 Niels Möller, Magnus Holmgren
Copyright (C) 2002, 2003 Niels Möller
Copyright (C) 2002, 2003, 2008, 2011 Niels Möller
Copyright (C) 2002, 2003, 2009 Niels Möller
Copyright (C) 2011, 2013 Niels Möller
Copyright (C) 2011 Daniel Kahn Gillmor
Copyright (C) 2002, 2003, 2011 Niels Möller
Copyright (C) 2002, 2013 Niels Möller
Copyright (C) 1998, 2001, 2002, 2003 Free Software Foundation, Inc.
Copyright (C) 2012 Nikos Mavrogiannopoulos, Niels Möller
Copyright (C) 2001, 2012 Niels Möller
Copyright (C) 2001, 2003, 2015 Niels Möller
Copyright (C) 2001, 2003, 2006 Niels Möller
Copyright: 2012-2013 Andrew M. (floodyberry)
Copyright (C) 2014, 2015 Niels Möller
Copyright (C) 2003 Niels Möller, Andreas Sigfridsson
Copyright (C) 2002, 2014 Niels Möller
Copyright (C) 1994, 1995, 1996, 1999, 2000, 2001, 2002, 2004, 2005, 2006 Free Software Foundation, Inc.
Copyright (C) 2001, 2011, 2012 Niels Möller
Copyright (C) 2010, 2013 Niels Möller
Copyright (C) 2004, 2008, 2013 Niels Möller
Copyright (C) 2010, 2013, 2014 Niels Möller
Copyright (C) 2012, 2014 Niels Möller
Copyright: 2009-2012 Aleksey Kravchenko <rhash.admin@gmail.com>
Copyright (C) 2012 Nikos Mavrogiannopoulos
Copyright (C) 2002, 2013, 2014 Niels Möller
Copyright (C) 2001, 2002, 2005, Rafael R. Sevilla, Niels Möller
Copyright (C) 2005 Niels Möller
Copyright (C) 2001, 2015 Niels Möller
Copyright (C) 2015, 2018 Niels Möller
Copyright (C) 2004, 2009 Niels Möller
Copyright (C) 2005, 2013 Niels Möller
Copyright (C) 2004, Niels Möller
Copyright (C) 2005, Niels Möller
Copyright (C) 2010, Niels Möller
Copyright (C) 2014 Exegin Technologies Limited
Copyright (C) 2010, 2014, Niels Möller
Copyright (C) 2016 Niels Möller
Copyright (C) Stefan Metzmacher 2012
Copyright 2002, 2013 Niels Möller

Copyright (C) 2001, 2014 Niels Möller
Copyright (C) 2001, 2011 Niels Möller
Copyright (C) 2001, 2010 Niels Möller
Copyright (C) 2011 Andres Mejia
Copyright (C) 2003, 2010 Niels Möller
Copyright (C) 2004 Simon Josefsson
Copyright (C) 2017 Red Hat, Inc.
Copyright (C) 1989-2014 Free Software Foundation, Inc. This file is part of the GNU C Library.
Copyright (C) 2002, 2005, 2013 Niels Möller
Copyright (C) 1987-2014 Free Software Foundation, Inc. This file is part of the GNU C Library.
Copyright (C) 2002, 2005 Niels Möller
Copyright (C) 2005-2018 Niels Möller
Copyright (C) 2011, 2014 Niels Möller
Copyright (C) 2008-2014 Free Software Foundation, Inc. dnl This file is free software; the Free Software Foundation dnl gives unlimited permission to copy and/or distribute it, dnl with or without modifications, as long as this notice is preserved.
Copyright (C) 1992 Dana L. How
Copyright (C) 2001, 2012 Niels Möller, Nikos Mavrogiannopoulos
Copyright (C) 2013 Nikos Mavrogiannopoulos
Copyright (C) 2011 Katholieke Universiteit Leuven
Copyright 1985, 1986, 1988, 1990, 1991, 1992, 1993, 1994, 1995, 1996, 1997, 1998, 1999, 2000, 2001, 2002, 2003, 2004, 2005, 2006, 2007, 2008, 2009 Free Software Foundation, Inc.
Copyright (C) 1992-1996, 1998-2012 Free Software Foundation, Inc.
Copyright (C) 2002, 2003, 2010 Niels Möller
Copyright (C) 2001, 2014 Niels Möller
Copyright (C) 2002, 2009, 2014 Niels Möller, Magnus Holmgren
Copyright (C) 1999 Ruud de Rooij <ruud@debian.org>
Copyright (C) 2018 Niels Möller
Copyright (C) 2005, 2014 Niels Möller
Copyright (C) 2002 Dan Egnor, Niels Möller
Copyright (C) 2001, 2012 Niels Möller, Nikos Mavrogiannopoulos
Copyright 1991-1997, 1999-2017 Free Software Foundation, Inc.
Copyright (C) 2000, 2001, 2002, 2004, 2005, 2011, 2012 Niels Möller
Copyright (C) 2013 Joachim Strömbergson
Copyright (C) 2003 Niels Möller, Marcus Comstedt
Copyright (C) 2001, 2005 Niels Möller
Copyright (C) 2002 Niels Möller, Dan Egnor
Copyright (C) 2001, 2004 Niels Möller
Copyright (C) 2001, 2008, 2013 Niels Möller
Copyright (C) 2016 Niels Möller.
Copyright (C) 2012 Nikos Mavrogiannopoulos, Niels Möller
Copyright (C) 2013 Red Hat
Copyright (C) 2010, 2013 Niels Möller
Copyright (C) 2012-2014 Niels Möller
Copyright (C) 2015 Niels Möller
Copyright (C) 2013 Niels Möller
Copyright (C) 2001 Niels Möller
Copyright (C) 2018 Red Hat, Inc.
Copyright (C) 2010, 2011 Simon Josefsson
Copyright (C) 2003, 2004, 2005 Free Software Foundation, Inc.
Copyright (C) 2013 Joachim Strömbergson
Copyright (C) 2012 Simon Josefsson
Copyright (C) 2017 Red Hat, Inc.
Copyright (C) 1998, 2001 FSF, Ray Dassen, Niels Möller
Copyright (C) 2010 Simon Josefsson
Copyright (C) 1998, 2001, 2002, 2003 Free Software Foundation, Inc.
Copyright (C) 2012 Simon Josefsson, Niels Möller

LICENCE TERMS (cont.)

Copyright (C) 2014 Joachim Strömbergson
Copyright (C) 2010 Niels Möller
Copyright (C) 2011 Niels Möller
Copyright (C) 2014 Niels Möller
Copyright (C) 2001, 2011 Niels Möller
Copyright: 2009-2012 Aleksey Kravchenko <rhash.admin@gmail.com>
Copyright: 2013 Nikos Mavrogiannopoulos
Copyright: 2013 Niels Möller
Copyright (C) 2012 Simon Josefsson
Copyright (C) 2008, 2013 Niels Möller
Copyright (C) 2012 Nikos Mavrogiannopoulos
Copyright (C) 2018 Red Hat Inc.
Copyright (C) 2014 Owen Kirby
Copyright (C) Jeremy Allison 2012
Copyright (C) Michael Adam 2012
Copyright (C) 2017, Red Hat Inc.
Copyright (C) 2003 Nikos Mavroyanopoulos
Copyright (C) 2004 Free Software Foundation, Inc.
Copyright (C) 2004, 2014 Niels Möller
Copyright (C) 1992 Dana L. How
Copyright (C) 1992 Dana L. How
Copyright (C) 2003, 2004, 2005 Free Software Foundation, Inc.
Copyright (C) 1998 Ross Anderson, Eli Biham, Lars Knudsen.
Copyright (C) 2001 Niels Möller
Copyright (C) 1992 Dana L. How
Copyright (C) 2001 Niels Möller
Copyright (C) 2013, 2014 Niels Möller
Copyright (C) 2011, 2013, 2018 Niels Möller
Copyright (C) 2011, 2014 Niels Möller
Copyright (C) 2012 Free Software Foundation, Inc. This configure script is free software
Copyright (C) 2012 Free Software Foundation, Inc. This config.status script is free software
Copyright (C) 1999 Ruud de Rooij <ruud@debian.org>
Copyright (C) 1999 J.H.M. Dassen (Ray) <jdassen@wi.LeidenUniv.nl>
Copyright (C) 2012, 2014 Niels Möller
Copyright (C) 2004 Niels Möller
Copyright (C) 2018 Red Hat, Inc
Copyright (C) 2002, 2004, 2014 Niels Möller
Copyright (C) 1994 X Consortium
Copyright (C) 1996-2015 Free Software Foundation, Inc. This is free software
Copyright (C) 1999-2018 Free Software Foundation, Inc. Written by Tom Tromey <tromey@cygnus.com>.
Copyright 1992-2019 Free Software Foundation, Inc.
Copyright (C) 1999-2018 Free Software Foundation, Inc.
Copyright (C) 2004-2005, 2007, 2009, 2011-2015 Free Software Foundation, Inc. Written by Scott James Remnant, 2004.
Copyright (C) 2004, 2011-2015 Free Software Foundation, Inc. Written by Scott James Remnant, 2004
Copyright (C) 1996-2001, 2003-2015 Free Software Foundation, Inc. Written by Gordon Matzigkeit, 1996
Copyright (C) 2004-2005, 2007-2008, 2011-2015 Free Software Foundation, Inc. Written by Gary V. Vaughan, 2004
Copyright (C) 2004-2005, 2007-2009, 2011-2015 Free Software Foundation, Inc. Written by Gary V. Vaughan, 2004
Copyright (C) 1996-2018 Free Software Foundation, Inc. Originally written by Fran.cois Pinard <pinard@iro.umontreal.ca>, 1996.
Copyright (C) 2010-2018 Free Software Foundation, Inc. Written by Peter Rosin <peda@lysator.liu.se>.
Copyright (C) 1996-2018 Free Software Foundation, Inc.
Copyright 1991-1997, 1999-2016 Free Software Foundation, Inc.
Copyright (C) 1989, 1991 Free Software Foundation, Inc.
Copyright (C) 1994-2014 Free Software Foundation, Inc.
Copyright (C) 1994-2018 Free Software Foundation, Inc.
(C) Copyright 2000-2003 by Michal Zalewski <lcamtuf@coredump.cx>;(C) Copyright 2003 by Mike Frantzen <frantzen@w4g.org>
Copyright (c) 2017 Eric Leblond <eric@regit.org>
Copyright 2011-2015, 2017 Free Software Foundation, Inc.
(C) 1999 Andrea Arcangeli <andrea@suse.de>
(C) Steve Whitehouse 1999 derived from the ipv4 netfilter header file which is
Copyright (C) 1999 Paul 'Rusty' Russell & Michael J. Neuling
Copyright(C) 2018 Phil Sutter <phil@nwl.cc>
Copyright (C) 1996-2018 Free Software Foundation, Inc.
Copyright (c) 2008 Patrick McHardy <kaber@trash.net>
Copyright (C) 1992-1996, 1998-2012 Free Software Foundation, Inc.
Copyright (c) 2015 Pablo Neira Ayuso <pablo@netfilter.org>
Copyright (C) 2011 Free Software Foundation, Inc.
Copyright (c) 2008 Patrick McHardy <kaber@trash.net>
Copyright (c) 2007-2012 Patrick McHardy <kaber@trash.net>
Copyright (c) 2007-2008 Patrick McHardy <kaber@trash.net>
Copyright (c) 2016 Pablo Neira Ayuso <pablo@netfilter.org>
Copyright (C) 1984, 1989-1990, 2000-2015, 2018-2019 Free Software Foundation, Inc.
Copyright (c) 2008-2012 Patrick McHardy <kaber@trash.net>
Copyright (c) 2019 Pablo Neira Ayuso <pablo@netfilter.org>
Copyright (c) Red Hat GmbH. Author: Florian Westphal <fw@strln.de>
(C) 2014 by Ana Rey Botello <anarey@gmail.com>;(C) 2012 by Pablo Neira Ayuso <pablo@netfilter.org>
Copyright (c) 2016 Anders K. Pedersen <akp@cohaesio.com>
Copyright (c) 2017 Phil Sutter <phil@nwl.cc>
Copyright (c) 2017 Elise Lennion <elise.lennion@gmail.com>
Copyright (c) 2013-2015 Pablo Neira Ayuso <pablo@netfilter.org>
(C) 1999 Andrea Arcangeli <andrea@suse.de>;(C) 2002 David Woodhouse <dwmw2@infradead.org>
Copyright (c) 2013-2017 Pablo Neira Ayuso <pablo@netfilter.org>
Copyright (c) 2014 Patrick McHardy <kaber@trash.net>
Copyright (c) 2008-2012 Patrick McHardy <kaber@trash.net>
Copyright (c) 2005 Evgeniy Polyakov <johnpol@2ka.mxt.ru>
Copyright (c) 2018 Máté Eckl <ecklm94@gmail.com>
Copyright (c) 2015 Arturo Borrero Gonzalez <arturo@netfilter.org>
Copyright (C) 2004-2015 Free Software Foundation, Inc. This is free software
Copyright (C) 2010-2015 Free Software Foundation, Inc. This is free software
Copyright 1992-2019 Free Software Foundation, Inc.
Copyright (C) 2014 Free Software Foundation, Inc. This is free software
Copyright (C) 2011 Free Software Foundation, Inc. This config.lt script is free software
Copyright (C) 2002-2018 Free Software Foundation, Inc.
Copyright (C) 2011-2018 Free Software Foundation, Inc.
Copyright (C) 2001-2018 Free Software Foundation, Inc.
Copyright (C) 1997-2018 Free Software Foundation, Inc.
Copyright (C) 1999-2018 Free Software Foundation, Inc.
Copyright (C) 2003-2018 Free Software Foundation, Inc.
Copyright (C) 1998-2018 Free Software Foundation, Inc.
Copyright (C) 2009-2018 Free Software Foundation, Inc.
Copyright (C) 2006-2018 Free Software Foundation, Inc.
Copyright (C) 2004-2018 Free Software Foundation, Inc.
Copyright © 2004 Scott James Remnant <scott@netsplit.com>.
Copyright © 2012-2015 Dan Nicholson <dnl.lists@gmail.com> dnl dnl This program is free software
Copyright (C) 2004-2005, 2007-2009, 2011-2015 Free Software Foundation, Inc. Written by Gary V. Vaughan, 2004
Copyright (C) 2004-2005, 2007-2008, 2011-2015 Free Software Foundation, Inc. Written by Gary V. Vaughan, 2004
Copyright (C) 2004, 2011-2015 Free Software Foundation, Inc. Written by Scott James Remnant, 2004
Copyright (C) 2012 Free Software Foundation, Inc. This configure script is free software
Copyright (C) 2012 Free Software Foundation, Inc. This config.status script is free software
Copyright (c) 2013 Pablo Neira Ayuso <pablo@netfilter.org>
Copyright © 2008-2014 Patrick McHardy <kaber@trash.net> Copyright © 2013-2018 Pablo Neira Ayuso <pablo@netfilter.org> +

LICENCE TERMS (cont.)

Copyright (c) 2015 Arturo Borrero Gonzalez <arturo@debian.org>
Copyright (C) Maxim Dounin; Copyright (C) Nginx, Inc.
Copyright (C) Igor Sysoev
(c) Andrei Nigmatulin, 2005
Copyright (C) Roman Arutyunyan
Copyright (C) 2002-2019 Igor Sysoev
Copyright (C) 2010 Sergey A. Osokin
Copyright (C) Nginx, Inc.
Copyright (C) Unbit S.a.s. 2009-2010
Copyright (C) Nginx, Inc.
Copyright (C) Ruslan Ermilov
Copyright (C) Maxim Dounin
Copyright (C) Austin Appleby
Copyright (C) Nginx, Inc.
Copyright (C) Maxim Dounin
Copyright (C) 2011-2019 Nginx, Inc. All rights reserved.
Copyright (C) 2011-2019 Nginx, Inc. All rights reserved.
Copyright (C) Nginx, Inc. All rights reserved.
Copyright (C) Nginx, Inc. All rights reserved.
Copyright (C) Nginx, Inc.
Copyright (C) Manlio Perillo (manlio.perillo@gmail.com)
Copyright (C) 2008 Manlio Perillo (manlio.perillo@gmail.com)
Copyright (C) Igor Sysoev
Copyright (C) Valentin V. Bartenev
Copyright (C) Valentin V. Bartenev
Copyright (C) 2015 Vlad Krasnov
Copyright (C) Ruslan Ermilov
Copyright (C) 1994 X Consortium
Copyright (C) 1996-2015 Free Software Foundation, Inc. This is free software
Copyright (C) 1999-2018 Free Software Foundation, Inc. Written by Tom Tromey <tromey@cygnus.com>.
Copyright 1992-2019 Free Software Foundation, Inc.
Copyright (C) 1999-2018 Free Software Foundation, Inc.
Copyright (C) 2004-2005, 2007, 2009, 2011-2015 Free Software Foundation, Inc. Written by Scott James Remnant, 2004.
Copyright (C) 2004, 2011-2015 Free Software Foundation, Inc. Written by Scott James Remnant, 2004
Copyright (C) 1996-2001, 2003-2015 Free Software Foundation, Inc. Written by Gordon Matzigkeit, 1996
Copyright (C) 2004-2005, 2007-2008, 2011-2015 Free Software Foundation, Inc. Written by Gary V. Vaughan, 2004
Copyright (C) 2004-2005, 2007-2009, 2011-2015 Free Software Foundation, Inc. Written by Gary V. Vaughan, 2004
Copyright (C) 1996-2018 Free Software Foundation, Inc. Originally written by Fran,cois Pinard <pinard@iro.umontreal.ca>, 1996.
Copyright (C) 2011-2018 Free Software Foundation, Inc.
Copyright (C) 2010-2018 Free Software Foundation, Inc. Written by Peter Rosin <peda@lysator.liu.se>.
Copyright (C) 1996-2018 Free Software Foundation, Inc.
Copyright (C) 1992-2015 by Bruce Korb.
Copyright (C) 1992-2015 by Bruce Korb - all rights reserved Everyone is permitted to copy and distribute verbatim copies of this license document, but changing it is not allowed.
Copyright (C) 1992-2015 by Bruce Korb - all rights reserved Redistribution and use in source and binary forms, with or without modification, are permitted provided that the following conditions are met:
Copyright (C) 2004, 2005, 2007 Internet Systems Consortium, Inc. ("ISC")
Copyright (C) 2004-2007 Internet Systems Consortium, Inc. ("ISC")
(c) Copyright Tai Jin, 1988. All Rights Reserved. */ Hewlett-Packard Laboratories. */
Copyright (C) 1994-2018 Free Software Foundation, Inc.
Copyright (C) 2004-2007, 2011, 2012 Internet Systems Consortium, Inc. ("ISC")
Copyright (C) 2004-2007, 2009 Internet Systems Consortium, Inc. ("ISC")
Copyright (C) 2004-2007, 2010-2012 Internet Systems Consortium, Inc. ("ISC")
Copyright (C) 2009, 2012 Internet Systems Consortium, Inc. ("ISC")
Copyright (C) 2004-2009, 2011, 2012 Internet Systems Consortium, Inc. ("ISC")

Copyright (C) 2008 Internet Systems Consortium, Inc. ("ISC")
Copyright (C) 2009-2012 Internet Systems Consortium, Inc. ("ISC")
Copyright (C) 2011, 2012 Internet Systems Consortium, Inc. ("ISC")
Copyright (C) 2006-2008 Internet Systems Consortium, Inc. ("ISC")
Copyright (C) 2004-2007, 2009, 2011, 2012 Internet Systems Consortium, Inc. ("ISC")
Copyright (C) 2005-2007, 2009 Internet Systems Consortium, Inc. ("ISC")
Copyright (C) 2004-2009 Internet Systems Consortium, Inc. ("ISC")
Copyright (C) 2004-2009, 2012 Internet Systems Consortium, Inc. ("ISC")
Copyright (C) 2004-2008 Internet Systems Consortium, Inc. ("ISC")
Copyright (C) 2008, 2009 Internet Systems Consortium, Inc. ("ISC")
Copyright (C) 2004-2007, 2009, 2010 Internet Systems Consortium, Inc. ("ISC")
Copyright 2001, 2015, Harlan Stenn. Used by NTP with permission.
Copyright (C) 2004, 2006, 2007, 2011, 2012 Internet Systems Consortium, Inc. ("ISC")
Copyright 2015 Harlan Stenn. Used by NTP with permission.
Copyright (C) 2006, 2007 Internet Systems Consortium, Inc. ("ISC")
Copyright (C) 1996-2018 Free Software Foundation, Inc.
Copyright 2007-2012 Niels Provos and Nick Mathewson
Copyright (C) 2004-2010 Internet Systems Consortium, Inc. ("ISC")
Copyright (c) 2000-2007 Niels Provos <provos@citi.umich.edu>
Copyright (c) 2007-2012 Niels Provos and Nick Mathewson
Copyright (C) 2005-2007, 2009 Internet Systems Consortium, Inc. ("ISC")
Copyright (c) 2002-2007 Niels Provos <provos@citi.umich.edu>
Copyright (C) 2004-2012 Internet Systems Consortium, Inc. ("ISC")
Copyright (C) 2009 Internet Systems Consortium, Inc. ("ISC")
Copyright 2000-2007 Niels Provos <provos@citi.umich.edu>
Copyright (c) 2009-2012 Niels Provos, Nick Mathewson
Copyright 2001-2007 Niels Provos <provos@citi.umich.edu>
Copyright 2000-2007 Niels Provos
Copyright (C) 2007, 2008 Internet Systems Consortium, Inc. ("ISC")
Copyright 2006-2007 Niels Provos
Copyright (C) 1999-2001 Internet Software Consortium.
Copyright (C) 2004-2008, 2010 Internet Systems Consortium, Inc. ("ISC")
Copyright (c) 2009-2012 Niels Provos and Nick Mathewson
Copyright (C) 2004, 2005, 2007, 2008 Internet Systems Consortium, Inc. ("ISC")
Copyright (C) 1992-1996, 1998-2012 Free Software Foundation, Inc.
Copyright (C) 2004-2007, 2009-2012 Internet Systems Consortium, Inc. ("ISC")
Copyright (c) 2008-2012 Niels Provos and Nick Mathewson
Copyright (c) 1991, 1993 The Regents of the University of California. All rights reserved.
Copyright (c) 2012 Ross Lagerwall <rosslagerwall@gmail.com>
Copyright (c) 2010-2012 Niels Provos and Nick Mathewson
Copyright (c) 2003-2007 Niels Provos <provos@citi.umich.edu>
Copyright 2003-2007 Niels Provos <provos@citi.umich.edu>
Copyright 2009-2012 Nick Mathewson
Copyright (c) 2012 Niels Provos and Nick Mathewson
Copyright (C) 2004, 2005, 2007, 2009 Internet Systems Consortium, Inc. ("ISC")
Copyright (C) 2004, 2007 Internet Systems Consortium, Inc. ("ISC")
Copyright (C) 2004, 2006, 2007 Internet Systems Consortium, Inc. ("ISC")
Copyright 2008-2012 Niels Provos and Nick Mathewson
copyright year. bk-7 trigger updates
Copyright 2009-2012 Niels Provos and Nick Mathewson
Copyright (C) 2015, 2017 Network Time Foundation Author: Harlan Stenn
Copyright (C) 2014 Timothe Litt litt at acm dot org
Copyright (c) 2013 Niels Provos and Nick Mathewson
Copyright (C) 1994-2018 Free Software Foundation, Inc.
Copyright (c) 2009-2012 Nick Mathewson and Niels Provos
Copyright 2000-2009 Niels Provos <provos@citi.umich.edu>
Copyright (c) 2016 Network Time Foundation

LICENCE TERMS (cont.)

Copyright 2002 Christopher Clark */
Copyright (c) 2003-2009 Niels Provos <provos@citi.umich.edu>
Copyright (c) 1997 by Ulrich Windl Modified 970318: Harlan Stenn: rewritten... usage: ntpver hostname
Copyright 2002 Niels Provos <provos@citi.umich.edu> All rights reserved.
Copyright (c) 2005-2007 Niels Provos <provos@citi.umich.edu>
Copyright (C) 2011 Free Software Foundation, Inc.
Copyright (C) 1999,2000 Hans Lambers and Origin B.V.
Copyright (c) 1992 Rainer Pruy Friedrich-Alexander Universitaet Erlangen-Nuernberg
Copyright (c) 1992-1998 Rainer Pruy, Friedrich-Alexander Universitaet Erlangen-Nuernberg
Copyright (c) 1992 Frank Kardel, Rainer Pruy Friedrich-Alexander Universitaet Erlangen-Nuernberg
Copyright 2003-2009 Niels Provos <provos@citi.umich.edu>
Copyright (c) 1997, 1999 by Ulrich Windl <Ulrich.Windl@rz.uni-regensburg.de>
Copyright (c) 2010 Chris Davis, Niels Provos, and Nick Mathewson
Copyright (c) 2007 Steven G. Johnson <stevenj@alum.mit.edu>
Copyright (c) 2008-2012 Niels Provos, Nick Mathewson
Copyright (c) 2006-2007 Niels Provos <provos@citi.umich.edu>
Copyright (c) 1998 Todd C. Miller <Todd.Miller@courtesan.com> All rights reserved.
Copyright (c) 2007-2012 Niels Provos, Nick Mathewson
(C) Copyright 2008 Spectracom Corporation
Copyright (c) 2005-2012 Niels Provos and Nick Mathewson
Copyright (c) 1997, 1998, 2003 The Regents of the University of California. All rights reserved.
Copyright (C) 1984, 1989-1990, 2000-2015 Free Software Foundation, Inc.
Copyright (c) 2006
Copyright (c) 1992 The Regents of the University of California. All rights reserved.
Copyright (c) 1995-2015 by Frank Kardel <kardel <AT> ntp.org>
Copyright (c) 2006 Some code shamelessly based on the original NTP discrete event simulator)
Copyright (c) 2015 Network Time Foundation
Copyright (c) 2014 Network Time Foundation
Copyright (c) 2008 Holger Weiss <holger@jhweiss.de>.
Copyright (C) 1992-2013 by Bruce Korb - all rights reserved
Copyright 2008, Red Hat, Inc.
Copyright (C) 1992-2013 Bruce Korb - all rights reserved
Copyright (C) 1992-2013 Bruce Korb - all rights reserved
Copyright (C) 1992-2015 by Bruce Korb - all rights reserved
Copyright (C) 2001-2015, Takao Abe. All rights reserved. */
Copyright 2002, 2009, 2010 Harlan Stenn. Used by NTP with permission. Author: Harlan Stenn <harlan+cvo@pfcs.com>
Copyright (C) 1992, 1996 by Rainer Pruy Friedrich-Alexander Universitaet Erlangen-Nuernberg, Germany
Copyright (c) 2010 James Grenning and Contributed to Unity Project
Copyright (c) 2007-14 Mike Karlesky, Mark VanderVoord, Greg Williams Released under MIT License. Please refer to license.txt for details]
Copyright (c) 1997, 1998, 1999, 2000 Trimble Navigation Ltd. All rights reserved.
Copyright (c) 2002 RIPE NCC
Copyright (c) 2007 Mike Karlesky, Mark VanderVoord, Greg Williams Released under MIT License. Please refer to license.txt for details]
Copyright (c) 2015 Alexander Mueller / XelaRellum@web.de Released under MIT License. Please refer to license.txt for details] Based on the ruby script by Mike Karlesky, Mark VanderVoord, Greg Williams
Copyright (C) 2011-2015 Bruce Korb, all rights reserved. This is free software. It is licensed for use, modification and redistribution under the terms of the Modified (3 clause) Berkeley Software Distribution License <http://www.xfree86.org/3.3.6/COPYRIGHT2.html>>
Copyright (C) 2001-2005, 2009-2015 Free Software Foundation, Inc.
Copyright (C) 1992-2015 by Bruce Korb
Copyright (C) 1992-2015 by Bruce Korb - all rights reserved
Copyright (C) 2008-2015 Free Software Foundation, Inc. Written by Bruce Korb <bkorb@gnu.org>, 2008.
Copyright 2012-2015 Free Software Foundation, Inc.
Copyright 2012-2015 Free Software Foundation, Inc.
Copyright (C) 1995-1998, 2000-2002, 2004-2006, 2009-2015 Free Software Foundation, Inc.

Copyright Apple Computer, Inc., 2005
Copyright (c) 1998 Hewlett-Packard Company
"Copyright Apple Computer 1987 Version 1.17 of rc.sh on 91/11/08 15:56:21 (ATT 1.12)"
Copyright (c) 1998-2005 by Frank Kardel <kardel <AT> ntp.org>
Copyright (c) 1995-2005 by Frank Kardel <kardel <AT> ntp.org>
Copyright (C) 1999, 2000 by Philippe De Muyter <phdm@macqel.be>
Copyright (c) 1995-2009 by Frank Kardel <kardel <AT> ntp.org>
Copyright (c) 1997-2005 by Frank Kardel <kardel <AT> ntp.org>
Copyright (c) 2009,2012 - Schweizer Engineering Laboratories, Inc. <opensource@selinc.com>
Copyright (c) 1995 Vixie Enterprises
Copyright (c) David L. Mills 1993, 1994 *
Copyright (c) 1992 Microsoft Corporation
Copyright (C) 2001 Internet Software Consortium.
Copyright (C) 2004 Internet Systems Consortium, Inc. ("ISC")
(c) Copyright Tai Jin, 1988. All Rights Reserved. */ Hewlett-Packard Laboratories. */
Copyright (C) 1999, 2000 by Bernd Altmeier altmeier@ATLSOFT.de
Copyright (c) David L. Mills 1999-2000 *
Copyright (c) David L. Mills 1999-2009 *
Copyright (c) by Meinberg Funkhuren (www.meinberg.de)
Copyright 2012-2014 Free Software Foundation, Inc.
Copyright (C) 2005 by Frank Kardel
Copyright (c) 1982, 1986 Regents of the University of California. All rights reserved. The Berkeley software License Agreement specifies the terms and conditions for redistribution.
(c) 1999, 2000 Bernd Altmeier <altmeier@ATLSOFT.de>
Copyright (C) 1995, 1996, 1997, and 1998 WIDE Project. All rights reserved.
Copyright (c) 2010 Serge A. Zaitsev
Copyright (c) 2010 IETF Trust and the persons identified as authors of the code. All rights reserved.
Copyright (c) 1983 Regents of the University of California. All rights reserved.
Copyright (c) 1987, 1989 Regents of the University of California. All rights reserved.
Copyright (c) 1998 Todd C. Miller <Todd.Miller@courtesan.com>
Copyright (c) 1983, 1993 The Regents of the University of California. All rights reserved.
Copyright (c) 1988 Regents of the University of California. All rights reserved.
Copyright (c) 1995 Patrick Powell.
Copyright (c) 2014 by Network Time Foundation.
Copyright (c) 2008 Otto Moerbeek <otto@drijf.net>
Copyright (C) 2005, 2007 Internet Systems Consortium, Inc. ("ISC")
Copyright (C) 2005, 2007, 2009 Internet Systems Consortium, Inc. ("ISC")
Copyright (C) 2004, 2005, 2007, 2009, 2011, 2012 Internet Systems Consortium, Inc. ("ISC")
Copyright (C) 2006, 2007, 2009 Internet Systems Consortium, Inc. ("ISC")
Copyright (C) 2007-2009, 2011, 2012 Internet Systems Consortium, Inc. ("ISC")
Copyright (C) 2004, 2005, 2007, 2011, 2012 Internet Systems Consortium, Inc. ("ISC")
Copyright (C) 2005-2007, 2009, 2011, 2012 Internet Systems Consortium, Inc. ("ISC")
Copyright (C) 2005, 2007, 2008 Internet Systems Consortium, Inc. ("ISC")
Copyright (C) 2004, 2005, 2007, 2008, 2011, 2012 Internet Systems Consortium, Inc. ("ISC")
Copyright (C) 2004, 2005, 2007-2009, 2011, 2012 Internet Systems Consortium, Inc. ("ISC")
Copyright (C) 2005, 2007 Internet Systems Consortium, Inc. ("ISC")
Copyright (C) 2004, 2005, 2007, 2008, 2012 Internet Systems Consortium, Inc. ("ISC")
Copyright (C) 2006, 2008, 2009 Internet Systems Consortium, Inc. ("ISC")
Copyright (C) 2004, 2007-2009 Internet Systems Consortium, Inc. ("ISC")
Copyright (C) 2004, 2006, 2007, 2009 Internet Systems Consortium, Inc. ("ISC")
Copyright (C) 2004, 2007, 2009 Internet Systems Consortium, Inc. ("ISC")
Copyright (C) 2004, 2007, 2008 Internet Systems Consortium, Inc. ("ISC")
Copyright (C) 2004, 2006-2009 Internet Systems Consortium, Inc. ("ISC")
Copyright (C) 2004, 2007-2009, 2011, 2012 Internet Systems Consortium, Inc. ("ISC")
Copyright (C) 2004, 2007, 2009, 2011, 2012 Internet Systems Consortium, Inc. ("ISC")
Copyright (C) 2004, 2005, 2007-2009 Internet Systems Consortium, Inc. ("ISC")
Copyright (C) 2004, 2005, 2007, 2010-2012 Internet Systems Consortium, Inc. ("ISC")

LICENCE TERMS (cont.)

Copyright (C) 2004-2010, 2012 Internet Systems Consortium, Inc. ("ISC")
Copyright (C) 2009, 2010 Internet Systems Consortium, Inc. ("ISC")
Copyright (C) 2005, 2007, 2009, 2011, 2012 Internet Systems Consortium, Inc. ("ISC")
Copyright (C) 2004-2008, 2011, 2012 Internet Systems Consortium, Inc. ("ISC")
Copyright (C) 2004, 2007, 2011, 2012 Internet Systems Consortium, Inc. ("ISC")
Copyright (C) 2004, 2007 Internet Systems Consortium, Inc. ("ISC")
Copyright (C) 2006-2008, 2010-2012 Internet Systems Consortium, Inc. ("ISC")
Copyright (C) 2009, 2011, 2012 Internet Systems Consortium, Inc. ("ISC")
Copyright (C) 2005-2007, 2009, 2011, 2012 Internet Systems Consortium, Inc. ("ISC")
Copyright (C) 2004-2015 Free Software Foundation, Inc. This is free software
Copyright (C) 2010-2015 Free Software Foundation, Inc. This is free software
Copyright 1992-2019 Free Software Foundation, Inc.
Copyright (C) 2014 Free Software Foundation, Inc. This is free software
Copyright (C) 2011 Free Software Foundation, Inc. This config.lt script is free software
Copyright (C) 1999-2002 Internet Software Consortium.
Copyright (C) 1999-2001 Internet Software Consortium.
Copyright (C) 2000, 2001 Internet Software Consortium.
Copyright (C) 1998-2001 Internet Software Consortium.
Copyright (C) 2001, 2002 Internet Software Consortium.
Copyright (C) 1998-2002 Internet Software Consortium.
Copyright (C) 1999-2001, 2003 Internet Software Consortium.
Copyright (C) 2003 Internet Software Consortium.
Copyright (C) 1996-2001 Internet Software Consortium.
Copyright 2000 Aaron D. Gifford. All rights reserved.
Copyright 2000 Aaron D. Gifford. All rights reserved.
Copyright (C) 2001 Internet Software Consortium.
Copyright (C) 1998-2001, 2003 Internet Software Consortium.
Copyright (C) 2001, 2003 Internet Software Consortium.
Copyright (C) 1997-2001 Internet Software Consortium.
Copyright (C) 2000, 2001 Internet Software Consortium.
Copyright (C) 2000, 2001 Internet Software Consortium.
Copyright (C) 1992-2017 The University of Delaware and Network Time Foundation, all rights reserved.
Copyright (C) 2000, 2001, 2003 Internet Software Consortium.
Copyright (C) 1997-2002 Internet Software Consortium.
Copyright (C) 1999-2003 Internet Software Consortium.
Copyright (C) 2002-2018 Free Software Foundation, Inc.
Copyright (C) 2011-2018 Free Software Foundation, Inc.
Copyright (C) 2001-2018 Free Software Foundation, Inc.
Copyright (C) 1997-2018 Free Software Foundation, Inc.
Copyright (C) 1999-2018 Free Software Foundation, Inc.
Copyright (C) 1996-2018 Free Software Foundation, Inc.
Copyright (C) 2003-2018 Free Software Foundation, Inc.
Copyright (C) 2009-2018 Free Software Foundation, Inc.
Copyright (C) 2006-2018 Free Software Foundation, Inc.
Copyright (C) 2004-2018 Free Software Foundation, Inc.
Copyright (C) 1996-2001, 2003-2015 Free Software Foundation, Inc. Written by Gordon Matzigkeit, 1996
Copyright (C) 1999-2007, 2009-2016 Free Software Foundation, Inc. dn1 This file is free software
Copyright (C) 2004-2005, 2007-2009, 2011-2015 Free Software Foundation, Inc. Written by Gary V. Vaughan, 2004
Copyright (C) 2004-2005, 2007-2008, 2011-2015 Free Software Foundation, Inc. Written by Gary V. Vaughan, 2004
Copyright (C) 2004, 2011-2015 Free Software Foundation, Inc. Written by Scott James Remnant, 2004
Copyright (C) 2004-2005, 2007, 2009, 2011-2015 Free Software Foundation, Inc. Written by Scott James Remnant, 2004.
Copyright 2000-2007 Niels Provos <provos@citi.umich.edu>
Copyright 2003 Michael A. Davis <mike@datanerds.net>
Copyright 2000-2007 Niels Provos <provos@citi.umich.edu>
Copyright 2003 Michael A. Davis <mike@datanerds.net>
Copyright (c) 2007-2012 Niels Provos and Nick Mathewson
Copyright (c) 2007-2012 Niels Provos and Nick Mathewson
Copyright (c) 2010 BitTorrent, Inc.
Copyright (c) 2010 BitTorrent, Inc.
Copyright (C) 1997-2001 Internet Software Consortium.
Copyright 2007-2012 Niels Provos and Nick Mathewson
Copyright 2007-2012 Niels Provos and Nick Mathewson
Copyright 2007-2012 Niels Provos and Nick Mathewson
Copyright (C) 1998-2003 Internet Software Consortium.
Copyright (c) 2007 Sun Microsystems. All rights reserved. Use is subject to license terms.
Copyright (c) 2007 Sun Microsystems. All rights reserved. Use is subject to license terms.
Copyright (C) 2000-2003 Internet Software Consortium.
Copyright (C) 2012 Free Software Foundation, Inc. This configure script is free software
Copyright (C) 2012 Free Software Foundation, Inc. This config.status script is free software
Copyright (C) 2002 Internet Software Consortium.
Copyright (c) 2007-2013 Niels Provos and Nick Mathewson
Copyright (c) 2007-2013 Niels Provos and Nick Mathewson
Copyright (C) 2001-2003 Internet Software Consortium.
Copyright (C) 2014 Timothe Litt litt at acm dot org
Copyright 2009-2012 Niels Provos and Nick Mathewson
Copyright 2009-2012 Niels Provos and Nick Mathewson
Copyright 2007-2012 Niels Provos, Nick Mathewson
Copyright 2007-2012 Niels Provos, Nick Mathewson
Copyright 2005-2012 Nick Mathewson */
Copyright 2009-2012 Niels Provos and Nick Mathewson */ See license at end. */
Copyright (c) 2002, Christopher Clark All rights reserved.
Copyright 2005-2012 Nick Mathewson */
Copyright 2009-2012 Niels Provos and Nick Mathewson */ See license at end. */
Copyright (c) 2002, Christopher Clark All rights reserved.
Copyright 2005-2012 Nick Mathewson */
Copyright 2009-2012 Niels Provos and Nick Mathewson */ See license at end. */
Copyright (c) 2002, Christopher Clark All rights reserved.
Copyright (c) 2009-2012 Niels Provos and Nick Mathewson
Copyright (c) 2009-2012 Niels Provos and Nick Mathewson
Copyright 2007-2012 Nick Mathewson and Niels Provos
Copyright 2007-2012 Nick Mathewson and Niels Provos
Copyright (c) 2002-2006 Niels Provos <provos@citi.umich.edu> All rights reserved.
Copyright (c) 2002-2006 Niels Provos <provos@citi.umich.edu> All rights reserved.
Copyright (c) 2007-2012 Niels Provos and Nick Mathewson All rights reserved.
Copyright (c) 2006 Maxim Yegorushkin <maxim.yegorushkin@gmail.com>
Copyright (c) 2006 Maxim Yegorushkin <maxim.yegorushkin@gmail.com>
Copyright (c) 1997 by Ulrich Windl <Ulrich.Windl@rz.uni-regensburg.de> Converted to a PERL 5.004 package)
Copyright 2000-2007 Niels Provos
Copyright (c) 2007-2012 Niels Provos, Nick Mathewson
Copyright (c) 2007-2012 Niels Provos, Nick Mathewson
Copyright (c) 2010-2012 Niels Provos and Nick Mathewson
Copyright (c) 1996, David Mazieres <dm@uun.org>
Copyright (c) 2008, Damien Miller <djm@openbsd.org>
Copyright 2007-2012 Niels Provos and Nick Mathewson dn1 dn1 See LICENSE for copying information. dn1 dn1
Original version Dug Song <dugsong@monkey.org>
Copyright (c) 2000 Dug Song <dugsong@monkey.org>
Copyright (c) 1993 The Regents of the University of California.
Copyright (c) 1998 Todd C. Miller <Todd.Miller@courtesan.com>
Copyright (c) 2003 Michael A. Davis <mike@datanerds.net>
Copyright (c) 2007 Sun Microsystems
Copyright (c) 2002 Christopher Clark
Copyright (c) 1996, David Mazieres <dm@uun.org>
Copyright (c) 2008, Damien Miller <djm@openbsd.org>

LICENCE TERMS (cont.)

Copyright (c) 2000 Dug Song <dugsong@monkey.org>
Copyright (c) 1993 The Regents of the University of California.
Copyright (c) 1998 Todd C. Miller <Todd.Miller@courtesan.com>
Copyright (c) 2003 Michael A. Davis <mike@datanerds.net>
Copyright (c) 2007 Sun Microsystems
Copyright (c) 2002 Christopher Clark
Copyright (c) 2008, Damien Miller <djm@openbsd.org>
Copyright (c) 2000-2007 Niels Provos <provos@citi.umich.edu> All rights reserved.
Copyright (c) 2000-2007 Niels Provos <provos@citi.umich.edu> All rights reserved.
Copyright (c) 1993 The Regents of the University of California. All rights reserved.
Copyright (c) 1993 The Regents of the University of California. All rights reserved.
Copyright (c) 1989-1994 by Frank Kardel, Friedrich-Alexander Universitaet Erlangen-Nuernberg, Germany
Copyright (c) 1989-2015, Frank Kardel")
Copyright (c) 1989-1994 by Frank Kardel, Friedrich-Alexander Universitaet Erlangen-Nuernberg, Germany
Copyright (c) 1989-2015, Frank Kardel")
Copyright 2008, Andrew Tridgell. Licenced under the same terms as NTP itself.
Copyright (c) University of Delaware 1992-2015 *
Copyright (c) Network Time Foundation 2011-2017 *
Copyright (c) University of Delaware 1992-2015 *
Copyright (c) Network Time Foundation 2011-2017 *
Copyright (C) 1992-2015 by Bruce Korb - all rights reserved
Copyright (C) 1992-2015 by Bruce Korb - all rights reserved
Copyright (C) 1999-2014 by Bruce Korb - all rights reserved
Copyright (C) 1999-2014 by Bruce Korb - all rights reserved
Copyright (C) by Bruce Korb - all rights reserved
Copyright (C) by Bruce Korb - all rights reserved This program comes with ABSOLUTELY NO WARRANTY
Copyright (C) by Bruce Korb - all rights reserved
Copyright (C) by Bruce Korb - all rights reserved This program comes with ABSOLUTELY NO WARRANTY
Copyright (C) by Bruce Korb - all rights reserved
Copyright (C) by Bruce Korb - all rights reserved This program comes with ABSOLUTELY NO WARRANTY
Copyright (C) 1999-2014 Bruce Korb, all rights reserved.
Copyright (C) 1999-2014 Bruce Korb, all rights reserved.
Copyright (C) 1999-2014 Bruce Korb, all rights reserved.
Copyright (c) 1993-2005, Frank Kardel
Copyright (c) 1993-2005, Frank Kardel
Copyright (C) 1991-2005, Frank Kardel
Copyright (C) 1991-2005, Frank Kardel
Copyright (c) 1999 by Ulrich Windl, * based on code by Reg Clemens <reg@dwf.com> * based on code by Poul-Henning Kamp <phk@FreeBSD.org> *
Copyright (c) 1997-2005 by Frank Kardel <kardel <AT> ntp.org>
Copyright (c) Meinberg Funkuhren, Bad Pyrmont, Germany
Copyright (c) 1997-2005 by Frank Kardel <kardel <AT> ntp.org>
Copyright (c) Meinberg Funkuhren, Bad Pyrmont, Germany
Copyright (c) 1982, 1986, 1990, 1993 The Regents of the University of California. All rights reserved.
Copyright (c) 1982, 1986, 1990, 1993 The Regents of the University of California. All rights reserved.
Copyright (C) 1992-2017 The University of Delaware and Network Time Foundation all rights reserved.
Copyright (C) 1992-2017 The University of Delaware and Network Time Foundation all rights reserved.
Copyright (C) 1992-2017 The University of Delaware and Network Time Foundation all rights reserved.
Copyright (C) 1992-2017 The University of Delaware and Network Time Foundation all rights reserved.
Copyright 1992 by Carnegie Mellon University
Copyright © 2003 Sun Microsystems, Inc. All rights reserved.
Copyright 1992 by Carnegie Mellon University
Copyright © 2003 Sun Microsystems, Inc. All rights reserved.
Copyright (C) 1992-2017 The University of Delaware and Network Time Foundation all rights reserved.
Copyright (C) 1992-2017 The University of Delaware and Network Time Foundation all rights reserved.
Copyright (C) 1993-2005, Frank Kardel
Copyright (C) 1993-2005 by Frank Kardel

Copyright (C) 1993-2005 by Frank Kardel
Copyright (c) 1998 Todd C. Miller <Todd.Miller@courtesan.com>
Copyright (c) 2008 Holger Weiss.
Copyright 1999 AT&T.
Copyright (c) 1998 Doug Rabson All rights reserved.
Copyright (c) 1998 Doug Rabson All rights reserved.
Copyright (C) 1999-2001 Internet Software Consortium.
Copyright (c) 1987, 1993, 1994 The Regents of the University of California. All rights reserved.
Copyright (C) 1999-2001 Internet Software Consortium.
Copyright (c) 1987, 1993, 1994 The Regents of the University of California. All rights reserved.
Copyright (C) 2000-2002 Internet Software Consortium.
Copyright (C) 2003 Internet Software Consortium.
Copyright ((c)) 2002, Rice University All rights reserved.
Copyright (C) 2003 Internet Software Consortium.
Copyright ((c)) 2002, Rice University All rights reserved.
Copyright (c) 1998 Doug Rabson.
Copyright (c) 2001 Jake Burkholder. All rights reserved.
Copyright (c) 1998 Doug Rabson.
Copyright (c) 2001 Jake Burkholder. All rights reserved.
Copyright (C) 1996-2003 Internet Software Consortium.
Copyright (C) 1997-2003 Internet Software Consortium.
Copyright (C) 2000-2002 Internet Software Consortium.
Copyright (c) 1987, 1993 The Regents of the University of California. All rights reserved.
Copyright (C) 2000-2002 Internet Software Consortium.
Copyright (c) 1987, 1993 The Regents of the University of California. All rights reserved.
Copyright (C) 1999-2003 Internet Software Consortium.
Copyright (C) 1996-2001 Internet Software Consortium.
Copyright (c) 1983, 1990, 1993 The Regents of the University of California. All rights reserved.
Copyright (c) 1993 by Digital Equipment Corporation.
Copyright (C) 1996-2001 Internet Software Consortium.
Copyright (c) 1983, 1990, 1993 The Regents of the University of California. All rights reserved.
Copyright (c) 1993 by Digital Equipment Corporation.
Copyright (c) 1990, 1993 The Regents of the University of California. All rights reserved.
Copyright (c) 1990, 1993 The Regents of the University of California. All rights reserved.
Copyright (c) 2006, 2008 Junio C Hamano
Copyright (C) 2010-2019, Marvell International Ltd.
Copyright 2014-2020 NXP
Copyright (C) 2008-2019, Marvell International Ltd.
Copyright (C) 2008-2019, Marvell International Ltd. All Rights Reserved
Copyright (C) 2009-2019, Marvell International Ltd. All Rights Reserved
Copyright (C) 2009-2019, Marvell International Ltd.
Copyright (C) 2011-2019, Marvell International Ltd. All Rights Reserved
Copyright (C) 2011-2019, Marvell International Ltd.
Copyright (C) 1989, 1991 Free Software Foundation, Inc.
Copyright (C) 2014-2019, Marvell International Ltd.
Copyright (C) 2010-2019, Marvell International Lt.
Copyright (C) 2014-2019, Marvell International Ltd. All Rights Reserved
Copyright 1992-2019 Free Software Foundation, Inc.; Copyright 1992-2019 Free Software Foundation, Inc.
Copyright (c) 2003 Markus Friedl <markus@openbsd.org>
Copyright (c) 2014 Markus Friedl. All rights reserved.
Copyright (c) 2002 Chris Adams. All rights reserved.
Copyright (c) 2012 Will Drewry <wad@dataspill.org>
Copyright (c) 1995 Tatu Ylonen <ylo@cs.hut.fi>, Espoo, Finland All rights reserved
Copyright (C) 1992-1996, 1998-2012 Free Software Foundation, Inc.
Copyright (c) 2000, 2001 Markus Friedl. All rights reserved.
Copyright (c) 2001-2003 Simon Wilkinson. All rights reserved.
Copyright (c) 2012 Markus Friedl. All rights reserved.

LICENCE TERMS (cont.)

Copyright (c) 2000 Markus Friedl. All rights reserved.
Copyright (c) 2000 Damien Miller. All rights reserved.
Copyright (c) 2016 Darren Tucker. All rights reserved.
Copyright (c) 2010 Markus Friedl. All rights reserved.
Copyright (c) 1995 Tatu Ylonen <ylo@cs.hut.fi>, Espoo, Finland All rights reserved
Copyright (c) 2000 Niels Provos. All rights reserved.
Copyright (c) 1989, 1993 The Regents of the University of California. All rights reserved.
Copyright (c) 2001 The NetBSD Foundation, Inc. All rights reserved.
Copyright (c) 2003 Markus Friedl. All rights reserved.
Copyright 2003 Damien Miller
Copyright (c) 1987 Regents of the University of California. All rights reserved.
Copyright (C) 1994 X Consortium
Copyright (c) 2005 Tim Rice. All rights reserved.
Copyright (c) 1995 Tatu Ylonen <ylo@cs.hut.fi>
Copyright (c) 1995 Tatu Ylonen <ylo@cs.hut.fi>, Espoo, Finland All rights reserved
Copyright (c) 1997, 2004 Todd C. Miller <Todd.Miller@courtesan.com>
Copyright (c) 2001 Markus Friedl. All rights reserved.
Copyright (c) 2004-2008 Damien Miller <djm@mindrot.org>
Copyright (c) 2000-2002, 2007, 2010 Todd C. Miller <Todd.Miller@courtesan.com>
Copyright (c) 2008,2014 Darren Tucker <dtucker@zip.com.au>
Copyright (c) 1995, 1996, 1998 Theo de Raadt. All rights reserved.
Copyright (c) 1996 Theo de Raadt All rights reserved.
Copyright (c) 1990, 1993 The Regents of the University of California. All rights reserved.
Copyright (c) 2002 Markus Friedl. All rights reserved.
Copyright (c) 2017 Darren Tucker (dtucker at zip com au).
Copyright (c) 2006 Chad Mynhier.
Copyright (c) 2011 Damien Miller <djm@mindrot.org>
Copyright (c) 2002 Todd C. Miller <Todd.Miller@courtesan.com>
Copyright (c) 2000,2001 Ben Lindstrom. All rights reserved.
Copyright (c) 2004, 2005, 2007 Darren Tucker (dtucker at zip com au).
Copyright (c) 1998,2000 Free Software Foundation, Inc. *
Copyright (c) 2001 Gert Doering. All rights reserved.
Copyright (c) 2013 Ted Unangst <tedu@openbsd.org>
Copyright (c) 1999-2004 Damien Miller <djm@mindrot.org>
Copyright (c) 1992 The Regents of the University of California. All rights reserved.
Copyright (c) 2000, 2001, 2011, 2013 Corinna Vinschen <vinschen@redhat.com>
Copyright (c) 2003 Ben Lindstrom. All rights reserved.
Copyright (c) 1998 Todd C. Miller <Todd.Miller@courtesan.com>
Copyright (C) 2019 Free Software Foundation, Inc.
Copyright (c) 2015 Tim Rice <tim@multitalents.net>
Copyright (c) 1996 by Internet Software Consortium.
Copyright (c) 1983, 1993 The Regents of the University of California. All rights reserved.
Copyright (c) 1995 Tatu Ylonen <ylo@cs.hut.fi>, Espoo, Finland All rights reserved Password authentication.
Copyright (c) 1999-2003 Damien Miller. All rights reserved.
Copyright (c) 2000-2001, Aaron D. Gifford All rights reserved.
Copyright (c) 2005 Darren Tucker
Copyright (c) 2004 Otto Moerbeek <otto@drijf.net>
Copyright (c) 2006 Darren Tucker
Copyright (c) 1995 Tatu Ylonen <ylo@cs.hut.fi>
Copyright (c) 2019 Darren Tucker
Copyright (c) 2016 Ingo Schwarze <schwarze@openbsd.org>
Copyright (c) 2014 Darren Tucker
Copyright (c) 2011 Damien Miller
Copyright (c) 2005 Darren Tucker
Copyright (c) 2006 Darren Tucker. All rights reserved.
Copyright (c) 2000, 2002 Todd C. Miller <Todd.Miller@courtesan.com>
Copyright (c) 2010 Todd C. Miller <Todd.Miller@courtesan.com>

Copyright (c) 1989, 1991, 1993 The Regents of the University of California. All rights reserved.
Copyright (c) 2000 Ben Lindstrom. All rights reserved.
Copyright 2001 Niels Provos <provos@citi.umich.edu> All rights reserved.
Copyright (C) 2000-2003 Damien Miller. All rights reserved.
Copyright (c) 1996-1998, 2008 Theo de Raadt
Copyright (c) 2018 Damien Miller <djm@mindrot.org>
Copyright (c) 2008 Otto Moerbeek <otto@drijf.net>
Copyright (c) 2004 Damien Miller <djm@mindrot.org>
Copyright (c) 2000, 2013 Markus Friedl. All rights reserved.
Copyright (c) 2012 Darren Tucker (dtucker at zip com au).
Copyright (c) 1995 Tatu Ylonen <ylo@cs.hut.fi> socket.
Copyright (c) 2005 Reyk Floeter <reyk@openbsd.org>
Copyright (c) 2004, 2005 Darren Tucker
Copyright (C) 1995-1998 Eric Young (eay@cryptsoft.com) All rights reserved.
Copyright 2006, 2007 g10 Code GmbH
Copyright (c) 1996 by Internet Software Consortium.
Copyright (c) 2006 Damien Miller. All rights reserved.
Copyright (c) 2006 Damien Miller <djm@openbsd.org>
Copyright (c) 2004 Darren Tucker.
Copyright (c) 2005 Darren Tucker <dtucker@zip.com.au>
Copyright (c) 2001 Damien Miller. All rights reserved.
Copyright (c) 1996, David Mazieres <dm@uun.org>
Copyright (c) 2002-2008 Damien Miller <djm@openbsd.org>
Copyright (c) 2004-2005 Todd C. Miller <Todd.Miller@courtesan.com>
Copyright (c) 2002,2004 Damien Miller <djm@mindrot.org>
Copyright (c) 2000 Andre Lucas. All rights reserved.
Copyright (c) 2010 Markus Friedl. All rights reserved.
Copyright (c) 1995 Tatu Ylonen <ylo@cs.hut.fi>
Copyright 2002 Niels Provos <provos@citi.umich.edu> All rights reserved.
Copyright 1997 Niels Provos <provos@physnet.uni-hamburg.de> All rights reserved.
Copyright 2010 Red Hat, Inc. All rights reserved. Use is subject to license terms.
Copyright (c) 2002 Networks Associates Technology, Inc. All rights reserved.
Copyright (c) 2010 Damien Miller. All rights reserved.
Copyright (c) 1997, 1998 The NetBSD Foundation, Inc. All rights reserved.
Copyright (c) Damien Miller 2013 <djm@mindrot.org>
Copyright (c) 2004 Ted Unangst and Todd Miller All rights reserved.
Copyright (c) 2001 Jakob Schlyter. All rights reserved.
Copyright (c) 2003 Constantin S. Svintsoff <kostik@iclub.nsu.ru>
Copyright (c) 2017 Markus Friedl. All rights reserved.
Copyright (c) 1983, 1990, 1993 The Regents of the University of California. All rights reserved.
Copyright (C) 2012 Free Software Foundation, Inc.
Copyright 1996, Jason Downs. All rights reserved.
Copyright (c) 1991, 1993 The Regents of the University of California. All rights reserved.
Copyright (c) 1990 Regents of the University of California. All rights reserved.
Copyright (c) 2005 The SCO Group. All rights reserved.
Copyright (c) 2007 Simon Vallet / Genoscope <svallet@genoscope.cns.fr>
Copyright (c) 1990 The Regents of the University of California. All rights reserved.
Copyright (c) 2008, 2017 Otto Moerbeek <otto@drijf.net>
Copyright (c) 2000 Denis Parker. All rights reserved.
Copyright (c) 2011 The NetBSD Foundation, Inc. All rights reserved.
Copyright (c) 2013 Damien Miller <djm@mindrot.org>
Copyright (c) 2005 Daniel Walsh <dwalsh@redhat.com>
Copyright (c) 2000 The NetBSD Foundation, Inc. All rights reserved.
Copyright (c) 2008 Markus Friedl. All rights reserved.
Copyright (c) 1995 Tatu Ylonen <ylo@cs.hut.fi>
Copyright (c) 2001, 2002, 2003 Ian F. Darwin. All rights reserved.
Copyright (c) 2014 Markus Friedl

Copyright (c) 2008, 2010, 2011, 2016 Otto Moerbeek <otto@drijf.net>
Copyright (c) 1995 Tatu Ylonen <ylo@cs.hut.fi> c
Copyright (c) 2008 Damien Miller <djm@mindrot.org>
Copyright (c) 2000-2004 Markus Friedl. All rights reserved.
Copyright (c) 1999, 2000, 2001, 2002 Markus Friedl. All rights reserved.
Copyright (c) 2012 Damien Miller <djm@mindrot.org>
Copyright (c) 2003 Nils Nordman. All rights reserved.
Copyright (c) 1995 Tatu Ylonen <ylo@cs.hut.fi>
Copyright (c) 2010 Damien Miller. All rights reserved.
Copyright 1995, 1996 by David Mazieres <dm@lcs.mit.edu>.
Copyright (c) 1995 Tatu Ylonen <ylo@cs.hut.fi>, Espoo, Finland All rights reserved
Copyright (c) 2017 Colin Watson <cjwatson@debian.org>
Copyright (c) 2017 Stefan-Lukas Gazdag.
Copyright (c) 2015 Theo de Raadt <deraadt@openbsd.org>
Copyright (c) 2015 Damien Miller <djm@mindrot.org>
Copyright (c) 2001-2007 Simon Wilkinson. All rights reserved.
Copyright (c) 1999-2004 Damien Miller
Copyright (c) 2019 Markus Friedl. All rights reserved.
Copyright (c) 2000, 2003 Markus Friedl <markus@openbsd.org>
Copyright (c) 1999-2004 Ted Krovetz
Copyright (c) 2002 Daniel Kouril. All rights reserved.
Copyright (c) 1999-2006 Ted Krovetz
Copyright 2002 Niels Provos <provos@citi.umich.edu>
Copyright (c) 2001 Eric Jackson <ericj@monkey.org>
Copyright (c) 2003 Wesley Griffin. All rights reserved.
Copyright (c) 2004 Darren Tucker. All rights reserved.
Copyright (c) 2003 Markus Friedl. All rights reserved.
Copyright 1988-2002 Sun Microsystems, Inc. All rights reserved. Use is subject to license terms.
Copyright (c) 2013 Markus Friedl <markus@openbsd.org>
Copyright (c) 1995 Tatu Ylonen <ylo@cs.hut.fi>, Espoo, Finland All rights reserved Rhosts authentication.
Copyright 1994 Phil Karn <karn@qualcomm.com>
Copyright (c) 1999-2000 Damien Miller. All rights reserved.
Copyright (c) 1995 Tatu Ylonen <ylo@cs.hut.fi>, Espoo, Finland All rights reserved Ssh client program.
Copyright (c) 1994 Tatu Ylonen <ylo@cs.hut.fi>, Espoo, Finland All rights reserved Identity and host key generation and maintenance.
Copyright (c) 1995 Tatu Ylonen <ylo@cs.hut.fi>, Espoo, Finland All rights reserved Functions for returning the canonical host name of the remote site.
Copyright (c) 1995 Tatu Ylonen <ylo@cs.hut.fi>, Espoo, Finland All rights reserved Functions for reading the configuration files.
Copyright (c) 2001-2004 Damien Miller <djm@openbsd.org>
Copyright (c) 2001 Kevin Steves. All rights reserved.
Copyright (c) 2013 Damien Miller <djm@mindrot.org>
Copyright (c) 2015 Joyent, Inc Author: Alex Wilson <alex.wilson@joyent.com>
Copyright (c) 1999, 2000, 2001 Markus Friedl. All rights reserved.
Copyright (c) 2000-2002 Damien Miller. All rights reserved.
Copyright (c) 1999-2016 Philip Hands <phil@hands.com> 2013
Copyright 2000-2014 Red Hat Inc.
Copyright (c) 1995-2000 SuSE GmbH Nuernberg, Germany.
Copyright (c) 1999-2013 hands.com Ltd. <http://hands.com/>
Copyright (c) 2011 Dag-Erling Smorgrav
Copyright (c) 2003 Peter Stuge <stuge-mdoc2man@cdy.org>
Copyright (c) 1995 Tatu Ylonen <ylo@cs.hut.fi>, Espoo, Finland All rights reserved Code for uid-swapping.
Copyright (c) 1995 Tatu Ylonen <ylo@cs.hut.fi>, Espoo, Finland All rights reserved Created: Mon Mar 20 22:09:17 1995 ylo
Copyright (c) 1995 Tatu Ylonen <ylo@cs.hut.fi>, Espoo, Finland All rights reserved The authentication agent program.
Copyright (c) 1995 Tatu Ylonen <ylo@cs.hut.fi>, Espoo, Finland All rights reserved Interface for the packet protocol

functions.
Copyright (c) 1995 Tatu Ylonen <ylo@cs.hut.fi>, Espoo, Finland All rights reserved Functions for manipulating the known hosts files.
Copyright (c) 1995 Tatu Ylonen <ylo@cs.hut.fi>, Espoo, Finland All rights reserved Adds an identity to the authentication server, or removes an identity.
Copyright (c) 1999 Theo de Raadt. All rights reserved.
Copyright (c) 2002 Nils Nordman. All rights reserved.
Copyright (c) 1995 Tatu Ylonen <ylo@cs.hut.fi>, Espoo, Finland All rights reserved Definitions for server configuration data and for the functions reading it.
Copyright (c) 2004, 2005 Darren Tucker. All rights reserved.
Copyright (c) 1999 Markus Friedl. All rights reserved.
Copyright (c) 1995 Tatu Ylonen <ylo@cs.hut.fi>, Espoo, Finland All rights reserved The main loop for the interactive session (client side).
Copyright (c) 1999,2000 Markus Friedl. All rights reserved.
Copyright (c) 1999 Aaron Campbell. All rights reserved.
Copyright (C) 2012 Free Software Foundation, Inc. This configure script is free software
Copyright (C) 2012 Free Software Foundation, Inc. This config.status script is free software
Copyright (c) 1983, 1995-1997 Eric P. Allman
Copyright (c) 1988, 1993 The Regents of the University of California. All rights reserved.
Copyright (c) 1983, 1993, 1994 The Regents of the University of California. All rights reserved.
Copyright (c) 2004,2005,2006 Darren Tucker. All rights reserved.
Copyright (c) 1999 Dug Song. All rights reserved.
Copyright (c) 2002 Tim Rice. All rights reserved.
Copyright (c) 2005 Damien Miller
Copyright (C) 1999 WIDE Project. All rights reserved.
Copyright (c) 1997, 2008-2009 Todd C. Miller
Copyright (c) 1995 Tatu Ylonen <ylo@cs.hut.fi>
Copyright (c) 2003,2004,2005,2006 Darren Tucker. All rights reserved.
Copyright (c) 2000-2005 The OpenSSL Project. All rights reserved.
Copyright (c) 2018 Theo Buehler <tb@openbsd.org>
Copyright 2006 Andreas Jellinghaus
Copyright (c) 1995 by International Business Machines, Inc.
Copyright (c) 2005 Anil Madhavapeddy. All rights reserved.
Copyright (c) 1995,1999 Theo de Raadt. All rights reserved. All rights reserved.
Copyright (c) 1997 Todd C. Miller <Todd.Miller@courtesan.com>
Copyright (c) 2008, Damien Miller <djm@openbsd.org>
Copyright (c) 2013, Markus Friedl <markus@openbsd.org>
Copyright (c) 2014 Pedro Martelletto. All rights reserved.
Copyright (c) 2003,2004 Damien Miller <djm@mindrot.org>
Copyright (c) 2003,2004 Darren Tucker <dtucker@zip.com.au>
Copyright (c) 1999-2001 Internet Software Consortium.
Copyright (c) 1993 by Digital Equipment Corporation.
Copyright 1998, Theo de Raadt. All rights reserved.
Copyright 2000, Damien Miller. All rights reserved.
Copyright (c) 2000 Michael Stone. All rights reserved.
Copyright (c) 2000, 2001, 2002 Markus Friedl. All rights reserved.
Copyright (c) 2002 Niels Provos. All rights reserved.
Copyright (c) 2001 Per Allansson. All rights reserved.
Copyright (c) 2017 Markus Friedl.
Copyright 2002 Markus Friedl <markus@openbsd.org> All rights reserved.
Copyright (c) 1999 Niklas Hallqvist. All rights reserved.
Copyright (c) 2004, 2005 Damien Miller. All rights reserved.
Copyright (c) 2003 Jakob Schlyter. All rights reserved.
Copyright (c) 2013 Aris Adamantiadis. All rights reserved.
Copyright (c) 2008 Damien Miller. All rights reserved.
Copyright 1996-1998, 2003 William Allen Simpson <wsimpson@greendragon.com>
Copyright 2000 Niels Provos <provos@citi.umich.edu> All rights reserved.

LICENCE TERMS (cont.)

Copyright 2015-2020 The OpenSSL Project Authors. All Rights Reserved.
Copyright 2005-2017 The OpenSSL Project Authors. All Rights Reserved.
Copyright 2004-2020 The OpenSSL Project Authors. All Rights Reserved.
Copyright 2000-2017 The OpenSSL Project Authors. All Rights Reserved.
Copyright 1999-2017 The OpenSSL Project Authors. All Rights Reserved.
Copyright 2008-2020 The OpenSSL Project Authors. All Rights Reserved.
Copyright 2010-2016 The OpenSSL Project Authors. All Rights Reserved.
Copyright 1998-2020 The OpenSSL Project Authors. All Rights Reserved.
Copyright 2012-2017 The OpenSSL Project Authors. All Rights Reserved.
Copyright 2008-2018 The OpenSSL Project Authors. All Rights Reserved.
Copyright 2004-2019 The OpenSSL Project Authors. All Rights Reserved.
Copyright 2000-2018 The OpenSSL Project Authors. All Rights Reserved.
Copyright 2008-2016 The OpenSSL Project Authors. All Rights Reserved.
Copyright 1995-2019 The OpenSSL Project Authors. All Rights Reserved.
Copyright 2008-2019 The OpenSSL Project Authors. All Rights Reserved.
Copyright 2007-2018 The OpenSSL Project Authors. All Rights Reserved.
Copyright 2004-2020 The OpenSSL Project Authors. All Rights Reserved.
Copyright 2004-2016 The OpenSSL Project Authors. All Rights Reserved.
Copyright 2003-2018 The OpenSSL Project Authors. All Rights Reserved.
Copyright 2003-2016 The OpenSSL Project Authors. All Rights Reserved.
Copyright 1995-2016 The OpenSSL Project Authors. All Rights Reserved.
Copyright 2018 The OpenSSL Project Authors. All Rights Reserved.
Copyright 1998-2019 The OpenSSL Project Authors. All Rights Reserved.
Copyright 2013-2019 The OpenSSL Project Authors. All Rights Reserved.
Copyright 2009-2018 The OpenSSL Project Authors. All Rights Reserved.
Copyright 2016-2017 The OpenSSL Project Authors. All Rights Reserved.
Copyright 1998-2016 The OpenSSL Project Authors. All Rights Reserved.
Copyright 2016 The OpenSSL Project Authors. All Rights Reserved.
Copyright 2016-2019 The OpenSSL Project Authors. All Rights Reserved.
Copyright 2004-2021 The OpenSSL Project Authors. All Rights Reserved.
Copyright 2004-2019 The OpenSSL Project Authors. All Rights Reserved.
Copyright 2010-2020 The OpenSSL Project Authors. All Rights Reserved.
Copyright 2010-2021 The OpenSSL Project Authors. All Rights Reserved.
Copyright 2013-2018 The OpenSSL Project Authors. All Rights Reserved.
Copyright 2001-2021 The OpenSSL Project Authors. All Rights Reserved.
Copyright 2003-2020 The OpenSSL Project Authors. All Rights Reserved.
Copyright 2017 BaishanCloud. All rights reserved.
Copyright (c) 2017, Oracle and/or its affiliates. All rights reserved.
Copyright (c) 2002, Oracle and/or its affiliates. All rights reserved
Copyright 2011 Google Inc.
Copyright 2014 Cryptography Research, Inc.
Copyright 2014-2016 Cryptography Research, Inc.
Copyright 2016 Cryptography Research, Inc.
Copyright 2015-2016 Cryptography Research, Inc.
Copyright 2015 Cryptography Research, Inc.
Copyright (c) 2014, Intel Corporation. All Rights Reserved.
Copyright (c) 2015, CloudFlare, Inc.
Copyright (c) 2002, Oracle and/or its affiliates. All rights reserved
Copyright 2005 Nokia. All rights reserved.
Copyright (C) 2006, Network Resonance, Inc. Copyright (C) 2011, RTFM, Inc.
Copyright (c) 2004, EdelKey Project. All Rights Reserved.
Copyright (c) 2013-2014 Timo Teräs <timo.teras@gmail.com>
Copyright (c) 2004, 2018, Richard Levitte <richard@levitte.org> All rights reserved.
Copyright (c) 2004 Kungliga Tekniska Högskolan Royal Institute of Technology, Stockholm, Sweden). All rights reserved.
Copyright 2004-2014, Akamai Technologies. All Rights Reserved.
Copyright (c) 2004, Richard Levitte <richard@levitte.org> All rights reserved.

Copyright (C) 2017 National Security Research Institute. All Rights Reserved.
Copyright (c) 2017 National Security Research Institute. All rights reserved. */
Copyright (c) 2018, Oracle and/or its affiliates. All rights reserved.
Copyright (c) 2006, 2008 Junio C Hamano
Copyright (c) 2017, Linaro Limited All rights reserved.
Copyright (c) 2016-2017, Linaro Limited All rights reserved.
Copyright (c) 2015-2016, Linaro Limited All rights reserved.
Copyright (c) 2014, STMicroelectronics International N.V. All rights reserved.
Copyright (C) 2005 Olivier Gay <olivier.gay@a3.epfl.ch> All rights reserved.
Copyright (C) 2005, 2007 Olivier Gay <olivier.gay@a3.epfl.ch> All rights reserved.
Copyright (c) 2016, Linaro Limited All rights reserved.
Copyright (c) 2014, Linaro Limited All rights reserved.
Copyright (c) 2014, STMicroelectronics International N.V. All rights reserved.
Copyright (c) 2015, Linaro Limited All rights reserved.
Copyright (c) 2016, Linaro Limited
Copyright (c) 2018-2020, Linaro Limited
Copyright (c) 2017-2020, Linaro Limited
Copyright (c) 2020, Linaro Limited
Copyright (c) 2017-2018, Linaro Limited
Copyright (c) 20187-2020, Linaro Limited
Copyright (c) 2017, Linaro Limited
Copyright (c) 2016, Linaro Limited All rights reserved.
Copyright (c) 2016, Linaro Limited All rights reserved.
Copyright (c) 2015, Linaro Limited All rights reserved.
Copyright (c) 2014, STMicroelectronics International N.V. All rights reserved.
Copyright (c) 2006, 2008 Junio C Hamano
Copyright (C) STMicroelectronics 2018 - All Rights Reserved Author: Philippe Peurichard <philippe.peurichard@st.com>, Pascal Paillet <p.paillet@st.com> for STMicroelectronics.
Copyright (C) 2006 David Gibson, IBM Corporation.
Copyright (C) 2012 David Gibson, IBM Corporation.
Copyright (C) 2006 David Gibson, IBM Corporation. EVEN IF ADVISED OF THE POSSIBILITY OF SUCH DAMAGE.
Copyright (C) 2006 David Gibson, IBM Corporation.
Copyright (c) 2017-2020, STMicroelectronics
Copyright (c) 2016-2020, STMicroelectronics
Copyright (c) 2016-2020, STMicroelectronics
Copyright (c) 2017, Linaro Limited
Copyright (c) 2018, STMicroelectronics
Copyright (c) 2016, Linaro Limited
Copyright (c) 2017-2018, STMicroelectronics
Copyright (c) 2016, Linaro Limited
Copyright (c) 2019, STMicroelectronics
Copyright (c) 2020, Linaro Limited
Copyright (C) 2017-2018, STMicroelectronics
Copyright (c) 2018, Linaro Limited
Copyright (c) 2020, Linaro Limited
Copyright (c) 2019-2020, STMicroelectronics
Copyright (c) 2014, STMicroelectronics International N.V.
Copyright (c) 2018-2019, STMicroelectronics
Copyright (c) 2020, ARM Limited. All rights reserved.
Copyright (c) 1019 Huawei Technologies Co., Ltd
Copyright (c) 2019, Linaro Limited
Copyright (c) 2016-2019, Linaro Limited
Copyright (C) 2018-2019, STMicroelectronics
Copyright (c) 2017, EPAM Systems All rights reserved.
Copyright (c) 2017, Linaro Limited SPDX-License-Identifier: BSD-2-Clause
Copyright (c) 2014, Linaro Limited
Copyright (C) 2018, Linaro Limited

LICENCE TERMS (cont.)

Copyright (C) 2019, Linaro Limited
Copyright (c) 2016, Xilinx Inc. All rights reserved.
Copyright (c) 2018-2019, Linaro Limited
Copyright 2019 Broadcom.
Copyright (C) 2015 Freescale Semiconductor, Inc.
Copyright (c) 2019, Broadcom
Copyright (C) 2016 Freescale Semiconductor, Inc.
Copyright (C) 2017 NXP
Copyright 2017-2018, 2020 NXP
Copyright 2017-2019 NXP
Copyright (c) 2015, Linaro Limited
Copyright 2017-2018 NXP
Copyright (C) 2017 - 2018, ARM Limited
Copyright 2017-2020 NXP
Copyright 2018-2020 NXP
Copyright 2018, 2020 NXP
Copyright (C) 2004, 2005, 2010, 2011, 2012, 2013, 2016 Mark Adler
Copyright (C) 1995-2016 Jean-loup Gailly, Mark Adler
Copyright (C) 1995-2003, 2010 Mark Adler
Copyright (C) 1995-2017 Mark Adler
Copyright (C) 1995-2011, 2016 Mark Adler
Copyright (C) 1995-2017 Mark Adler
Copyright (C) 1995-2016 Jean-loup Gailly, Mark Adler
Copyright 2019 NXP
Copyright (C) 1995-2016 Mark Adler
Copyright (C) 1995-2017 Jean-loup Gailly
Copyright (C) 1995-2005, 2010 Mark Adler
Copyright (C) 1995-2017 Jean-loup Gailly and Mark Adler
copyright 2018 NXP
Copyright 2018-2019 NXP
Copyright 2020 Pengutronix, Rouven Czerwinski <entwicklung@pengutronix.de>
Copyright (C) 2016 Free Electrons
Copyright (C) 2014 David Gibson <david@gibson.dropbear.id.au>
Copyright (c) 2014-2019, Linaro Limited
Copyright (c) 2020 Huawei Technologies Co., Ltd
Copyright (c) 2019 Huawei Technologies Co., Ltd
Copyright (c) 2015, 2020, Linaro Limited
Copyright (c) 2018, Linaro Limited
Copyright (c) 2015, Linaro Limited All rights reserved.
Copyright 2020 NXP
Copyright 2020 Foundries Ltd
copyright 2019 NXP
Copyright (c) Microsoft Corporation. All rights reserved.
Copyright 2018 NXP
Copyright (c) Microsoft Corporation. All rights reserved.
Copyright (c) 2014, STMicroelectronics International N.V.
Copyright (C) 2019 Bryan O'Donoghue
Copyright 2019 Pengutronix All rights reserved.
Copyright (C) 2017, Fuzhou Rockchip Electronics Co., Ltd.
Copyright (C) 2017, Fuzhou Rockchip Electronics Co., Ltd.
Copyright (C) 2019, Theobroma Systems Design und Consulting GmbH
Copyright (C) STMicroelectronics 2017 - All Rights Reserved Author: Ludovic Barre <ludovic.barre@st.com> for STMicroelectronics.
Copyright (C) STMicroelectronics 2019 - All Rights Reserved Author: Alexandre Torgue <alexandre.torgue@st.com> for STMicroelectronics.
Copyright (c) 2001-2007, Tom St Denis
Copyright (C) Cryptico A/S. All rights reserved.

Copyright (c) 2016, Sequitur Labs Inc. All rights reserved. All rights reserved.
Copyright (C) 2016 Freescale Semiconductor, Inc. All rights reserved.
Copyright 2017 NXP
Copyright (c) 2016-2020, Linaro Limited
Copyright (C) 2015 Freescale Semiconductor, Inc. All rights reserved.
Copyright (c) 2016, Wind River Systems. All rights reserved.
Copyright (c) 2016, Wind River System All rights reserved.
Copyright (c) 2014, STMicroelectronics International N.V. All rights reserved.
Copyright (c) 2015-2016, Linaro Limited
Copyright (c) 2015, Linaro Limited
Copyright (C) 2017 Marvell International Ltd. All rights reserved.
Copyright (c) 2016, Linaro Ltd and Contributors. All rights reserved.
Copyright (c) 2019, HiSilicon Technologies Co., Ltd.
Copyright (c) 2016-2017, Linaro Limited
Copyright (c) 2020 Carlo Caione <ccaione@baylibre.com>
Copyright (c) 2016, GlobalLogic
Copyright (c) 2016, Linaro Limited.
Copyright (c) 2019, Arm Limited
Copyright 2018 NXP
Copyright (C) 2015 Freescale Semiconductor, Inc. All rights reserved.
Copyright (C) 2017 Timesys Corporation All rights reserved.
Copyright (c) 2016-2017, Linaro Limited
Copyright (C) 2020 Pengutronix Rouven Czerwinski <entwicklung@pengutronix.de>
(c) 2020 Jorge Ramirez <jorge@foundries.io>, Foundries Ltd.
Copyright (c) 2015-2019, Arm Limited and Contributors. All rights reserved.
Copyright (c) 2017-2019, STMicroelectronics
Copyright (c) 2014-2017, Linaro Limited
Copyright (c) 2015-2020, Linaro Limited
Copyright (c) 2016, Freescale Semiconductor, Inc. All rights reserved.
Copyright 2017 NXP All rights reserved.
Copyright (c) 2016, Spreadtrum Communications Inc.
Copyright (c) 2016-2020, STMicroelectronics - All Rights Reserved
Copyright (c) 2017-2020, Linaro Limited
Copyright 2019-2020 NXP
Copyright (c) 2014-2020, Linaro Limited
Copyright (c) 2020 Linaro Limited
Copyright (c) 2015, 2020 Linaro Limited
Copyright (c) 2014-2020, Linaro Limited
Copyright (c) 2020 Linaro Limited
Copyright (c) 2015-2020, Linaro Limited
Copyright (c) 2016, 2020 Linaro Limited
Copyright (C) 2014 - 2017 Linaro Ltd. <ard.biesheuvel@linaro.org>
Copyright (C) 2017 Timesys Corporation. All rights reserved.
Copyright (c) 2013, Atmel Corporation
Copyright (c) 2015, Atmel Corporation
Copyright (c) 2013, Atmel Corporation
Copyright (c) 2016-2020, Linaro Limited
Copyright (c) 2015-2016, Linaro Limited All rights reserved.
Copyright (c) 2015-2016, Linaro Limited
Copyright (c) 2016, Spreadtrum Communications Inc. All rights reserved.
Copyright (C) 2006-2015, ARM Limited, All Rights Reserved
Copyright (C) 2006-2016, ARM Limited, All Rights Reserved
Copyright (C) 2018, Arm Limited, All Rights Reserved
Copyright (C) 2006-2017, ARM Limited, All Rights Reserved
Copyright (C) 2018, Arm Limited (or its affiliates), All Rights Reserved
Copyright 2017-2020 NXP All rights reserved.
Copyright (c) 2015-2017, ARM Limited and Contributors. All rights reserved.

LICENCE TERMS (cont.)

Copyright (c) 2018, Linaro Limited */
Copyright (c) 2018, EPAM Systems. All rights reserved. */
Copyright (c) 2015-2019, Linaro Limited
Copyright (C) 2006-2020, ARM Limited, All Rights Reserved SPDX-License-Identifier: Apache-2.0
Copyright (C) 2016-2018, ARM Limited, All Rights Reserved SPDX-License-Identifier: Apache-2.0
Copyright (C) 2006-2017, ARM Limited, All Rights Reserved SPDX-License-Identifier: Apache-2.0
Copyright (c) 2020 Foundries Ltd <jorge@foundries.io>
Copyright (C) 2006-2018, Arm Limited (or its affiliates), All Rights Reserved
Copyright (C) STMicroelectronics 2017 - All Rights Reserved Author: Torgue Alexandre <alexandre.torgue@st.com> for STMicroelectronics.
Copyright (C) 2006-2018, ARM Limited, All Rights Reserved
Copyright (C) STMicroelectronics 2018 - All Rights Reserved Author: Gabriel Fernandez <gabriel.fernandez@st.com> for STMicroelectronics.
Copyright (C) 2018-2019, ARM Limited, All Rights Reserved SPDX-License-Identifier: Apache-2.0
Copyright (C) 2006-2018, Arm Limited (or its affiliates), All Rights Reserved.
Copyright (C) 2018, Arm Limited, All Rights Reserved SPDX-License-Identifier: Apache-2.0
Copyright (C) 2006-2018, ARM Limited, All Rights Reserved SPDX-License-Identifier: Apache-2.0
Copyright (C) 2015-2018, Arm Limited (or its affiliates), All Rights Reserved
Copyright (C) 2016, ARM Limited, All Rights Reserved
Copyright (C) 2006-2015, ARM Limited, All Rights Reserved;
Copyright (C) 2020 Foundries.io Jorge Ramirez-Ortiz <jorge@foundries.io>
Copyright (c) 2016, Xilinx Inc
Copyright (c) 2015-2019, Arm Limited and Contributors. All rights reserved.
Copyright (c) 2018, Linaro Limited
Copyright (c) 2014, ARM Limited and Contributors. All rights reserved.
Copyright (c) 2016-2018, STMicroelectronics - All Rights Reserved
Copyright (C) 2006-2019, Arm Limited (or its affiliates), All Rights Reserved
Copyright (c) 2017, Timesys Corporation All rights reserved.
Copyright (C) 2006-2019, ARM Limited, All Rights Reserved
Copyright (C) 2006-2018, Arm Limited (or its affiliates), All Rights Reserved.
Copyright (C) 2018, Arm Limited (or its affiliates), All Rights Reserved SPDX-License-Identifier: Apache-2.0
Copyright (C) 2018, ARM Limited
Copyright (c) 2017-2020, Linaro Limited
Copyright (c) 2017, Linaro Limited
Copyright (c) 2015-2017, Linaro Limited
Copyright Copyright (c) 2019 Huawei Technologies Co., Ltd
Copyright (c) 2018, Linaro Limited
Copyright (c) 2020, Linaro Limited */
Copyright (c) 2018, Linaro Limited
Copyright (c) 2019, KAIST
Copyright (c) 2020, Huawei Technologies Co., Ltd
Copyright (c) 2014, Allwinner Technology Co., Ltd.
Copyright (c) 2013, ARM Ltd
Copyright (c) 2014-2016, STMicroelectronics International N.V.
Copyright (c) 2014-2016, Linaro Limited
Copyright (c) 1992, 1993 The Regents of the University of California. All rights reserved.
Copyright (c) 1994-2009 Red Hat, Inc. All rights reserved.
Copyright (c) 2015 Linaro Limited
Copyright (c) 2015, 2019, Linaro Limited
Copyright 2015 Linaro Limited
Copyright (c) 1994-2009 Red Hat, Inc. All rights reserved.
Copyright (c) 2017, Linaro Limited. All rights reserved.
Copyright 2020 Foundries Ltd <jorge@foundries.io>
Copyright (c) 2020, Linaro Limited.
Copyright (c) 1991, 1993 The Regents of the University of California. All rights reserved.
Copyright (c) 1994-2009 Red Hat, Inc.
Copyright (c) 2014, Linaro Limited All rights reserved.

Copyright (c) 2015, STMicroelectronics International N.V.
Copyright 2011, 2012, 2013, 2014, 2015 The Regents of the University of California. All rights reserved.
Copyright 2011, 2012, 2013, 2014 The Regents of the University of California. All rights reserved.
Copyright 2011, 2012, 2013, 2014 The Regents of the University of California. All rights reserved.
Copyright (c) 2017, 2019, Linaro Limited
Copyright (c) 2014, 2015 Linaro Limited
Copyright (C) 2016-2018 Texas Instruments Incorporated - http://www.ti.com/ Andrew F. Davis <afd@ti.com>
Copyright (c) 2016, GlobalLogic All rights reserved.
Copyright 2011, 2012, 2013, 2014, 2015 The Regents of the University of California. All rights reserved.
Copyright 2011, 2012, 2013, 2014 The Regents of the University of California. All Rights Reserved.
Copyright (c) 2017, Texas Instruments All rights reserved.
Copyright (c) 2015, Texas Instruments All rights reserved.
Copyright (c) 2017-2018, STMicroelectronics
Copyright (c) 2011, 2012 ARM Ltd All rights reserved.
Copyright (c) 1998 Todd C. Miller <Todd.Miller@courtesan.com> All rights reserved.
Copyright (c) 1986, 1988, 1991, 1993 The Regents of the University of California. All rights reserved.
Copyright (C) 2019 Linaro Limited
Copyright (c) 2018 EPAM Systems
Copyright (c) 2017 Arm Limited. All rights reserved.
Copyright (c) 2020 Linaro Limited */
Copyright (c) 2015 Linaro Limited
Copyright (c) 1989, 1993 The Regents of the University of California. All rights reserved.
Copyright (c) 2017 Intel Corporation
Copyright (C) 2019 Linaro Limited
Copyright (c) 2019 Linaro limited
Copyright (c) 2018, Linaro limited
Copyright (C) 2017, ARM Limited, All Rights Reserved
Copyright (c) 1996-1998 John D. Polstra. All rights reserved.
Copyright (c) 2000, 2001, 2008, 2011, David E. O'Brien
Copyright (C) 2012 The Android Open Source Project
Copyright (c) 2016, Linaro Limited All rights reserved.
Copyright (C) 2019-2020, Linaro Limited
Copyright (c) 2018-2020, Linaro Limited
Copyright (c) 2015-2019 Linaro Limited
Copyright 2015-2019 Linaro Limited
Copyright (c) 2015-2019, Linaro Limited
Copyright (c) 2016, Linaro Limited import struct import argparse
Copyright (c) 2015, 2017, 2019, Linaro Limited
Copyright (c) 2015, Linaro Limited All rights reserved.
Copyright 2012 Kim Phillips, Freescale Semiconductor.
Copyright (c) 2016, Wind River Systems. All rights reserved.
Copyright 1995-2017 Mark Adler "
Copyright (C) 2016 NextThing Co.
Copyright (C) 2018 embedded brains GmbH
Copyright (c) 2001-2007, Tom St Denis All rights reserved.
Copyright (c) 2001-2007, Tom St Denis All rights reserved.
Copyright (C) 2013 Linaro Ltd <ard.biesheuvel@linaro.org>
Copyright (c) 2014, STMicroelectronics International N.V. All rights reserved.
Copyright (c) 2016, Hisilicon Ltd and Contributors. All rights reserved.
Copyright (c) 2017, Linaro Limited All rights reserved.
Copyright (c) 2019-2020, Linaro Limited
Copyright 2018-2019 NXP.
Copyright (C) 2017, Fuzhou Rockchip Electronics Co., Ltd. All rights reserved.
Copyright (c) 2000, 2001 Ben Harris
Copyright (c) 1996 Scott K. Stevens
Copyright (c) 1991, 1990 Carnegie Mellon University All Rights Reserved.
Copyright (c) 2018-2019, Arm Limited. All rights reserved.

LICENCE TERMS (cont.)

Copyright (c) 2019, Arm Limited. All rights reserved.
Copyright (c) 2014, ARM Limited and Contributors. All rights reserved.
Copyright (C) 2014 Linaro Ltd <ard.biesheuvel@linaro.org>
Copyright (C) 2013 Linaro Ltd <ard.biesheuvel@linaro.org>
Copyright (C) 2015 Linaro Ltd <ard.biesheuvel@linaro.org>
Copyright (c) 2017, Timesys Corporation
copyright(c) You must retain, in the Source form of any Derivative Works
Copyright(c) You must retain, in the Source form of any Derivative Works
Copyright (C) 2019, Linaro Limited
Copyright (C) 2019 Huawei Technologies Co., Ltd
Copyright (c) 2018, Amit Singh Tomar <amittomer25@gmail.com> All rights reserved.
Copyright (c) 2018, Amit Singh Tomar <amittomer25@gmail.com All rights reserved.
Copyright (C) 2018, Linaro Limited All rights reserved.
Copyright (c) 2018, Linaro Limited All rights reserved.
Copyright (c) 2017, Socionext Inc.
Copyright (c) 2015 The FreeBSD Foundation All rights reserved.
Copyright (c) 2016, ARM Limited and Contributors. All rights reserved.
Copyright 2013-2014 Andrew Turner.
Copyright 2013-2014 Ian Lepore.
Copyright 2013-2014 Rui Paulo.
Copyright 2013 Eitan Adler. All rights reserved.
Copyright (c) 1990 Regents of the University of California. All rights reserved.
Copyright (C) 2008, 2010 Eric Blake Permission to use, copy, modify, and distribute this software is freely granted, provided that this notice is preserved.
Copyright (c) 2016, ARM Limited and Contributors. All rights reserved.
Copyright (c) 2013-2014, ARM Limited and Contributors. All rights reserved.
Copyright (c) 2016, Linaro Limited All rights reserved.
Copyright (c) 2008-2010 Travis Geiselbrecht
Copyright (c) 2015-2017 Linaro Limited
Copyright (c) 2016-2018, Linaro Limited
copyright(c) UNIX System Laboratories, Inc.
Copyright (c) 2015 Linaro Limited All rights reserved.
Copyright(c) UNIX System Laboratories, Inc.
Copyright (C) 2004-2007, 2011, 2012 Internet Systems Consortium, Inc. ("ISC")
Copyright (C) 1999-2001, 2003 Internet Software Consortium.
Copyright 2019 The Fuchsia Authors. All rights reserved.
Copyright 2019 The Fuchsia Authors. All rights reserved.
Copyright (c) 1998 John D. Polstra. All rights reserved.
Copyright (c) 2018, Linaro Limited.
Copyright (C) 1996-2016 Free Software Foundation, Inc. This file is part of the GNU C Library. Contributed by David Mosberger <davidm@cs.arizona.edu>.
Copyright (c) 1982, 1986, 1992, 1993 The Regents of the University of California. All rights reserved.
Copyright (c) 1983, 1992, 1993, 2011 The Regents of the University of California. All rights reserved.
Copyright (C) 1989, 1991 Free Software Foundation, Inc., 51 Franklin Street, Fifth Floor, Boston, MA 02110-1301 USA Everyone is permitted to copy and distribute verbatim copies of this license document, but changing it is not allowed.;copyright the software, and 2) offer you this license which gives you legal permission to copy, distribute and/or modify the software.;copyright law: that is to say, a work containing the Program or a portion of it, either verbatim or with modifications and/or translated into another language. (Hereinafter, translation is included without limitation in the term "modification".) Each licensee is addressed as "you".;copyrighted interfaces, the;copyrighted by the Free Software Foundation, write to the Free Software Foundation; we sometimes make exceptions for this. Our decision will be guided by the two goals of preserving the free status of all derivatives of our free software and of promoting the sharing and reuse of software generally.;copyright" line and a pointer to where the full notice is found.;Copyright (C) <year> <name of author>;Copyright (C) year name of author Gnomovision comes with ABSOLUTELY NO WARRANTY; for details type `show w'. This is free software, and you are welcome to redistribute it under certain conditions; type `show c' for details.;copyright disclaimer" for the program, if necessary. Here is a sample; alter the names.;copyright interest in the program Gnomovision' (which makes passes at compilers) written by James Hacker.
Copyright (c) 2006, 2008 Junio C Hamano

Copyright (c) 2014, STMicroelectronics International N.V. All rights reserved.
Copyright (c) 2006 The OpenSSL Project. All rights reserved.
Copyright (c) 2014, STMicroelectronics International N.V. --> All rights reserved. -->
Copyright (c) 1999-2004 The OpenSSL Project. All rights reserved.
Copyright (C) 1995-1998 Eric Young (eay@cryptsoft.com) All rights reserved.
Copyright (c) 1999 The OpenSSL Project. All rights reserved.
Copyright (c) 2016, Linaro Limited All rights reserved.
Copyright (c) 2004 The OpenSSL Project. All rights reserved.
Copyright (C) 1995-1997 Eric Young (eay@cryptsoft.com) All rights reserved.
Copyright (c) 2019, Mentor Graphics Corporation
Copyright (c) 2015, Linaro Limited All rights reserved.
Copyright (c) 2000-2005 The OpenSSL Project. All rights reserved.
Copyright 2002 Sun Microsystems, Inc. ALL RIGHTS RESERVED.
Copyright (c) 2018-2019, Linaro Limited
Copyright (c) 1998-2000 The OpenSSL Project. All rights reserved.
Copyright (c) 2018, Linaro Limited
Copyright (c) 2019, Linaro Limited
Copyright (c) 1998-2001 The OpenSSL Project. All rights reserved.
Copyright (c) 2010 The OpenSSL Project. All rights reserved.
Copyright (c) 2001 The OpenSSL Project. All rights reserved.
Copyright (c) 2020 Huawei Technologies Co., Ltd
Copyright (c) 2008 The OpenSSL Project. All rights reserved.
Copyright (c) 2000 The OpenSSL Project. All rights reserved.
Copyright (c) 2007 KISA(Korea Information Security Agency). All rights reserved.
Copyright (c) 1998-2002 The OpenSSL Project. All rights reserved.
Copyright (c) 2015-2016, Linaro Limited All rights reserved.
Copyright (c) 1999-2005 The OpenSSL Project. All rights reserved.
Copyright (c) 2020, ARM Limited. All rights reserved.
Copyright (c) 2018, Linaro Limited
Copyright (c) 2014, Linaro Limited
Copyright (c) 2014, STMicroelectronics International N.V. All rights reserved.
Copyright (c) 1998-2005 The OpenSSL Project. All rights reserved.
Copyright (c) 1998-2006 The OpenSSL Project. All rights reserved.
Copyright (c) 2008 The OpenSSL Project. All rights reserved.
Copyright (c) 2017, Linaro Limited
Copyright (c) 2014, STMicroelectronics International N.V.
Copyright (c) 2014, Linaro Limited All rights reserved.
Copyright (c) 2016, Linaro Limited
Copyright (c) 2016, Linaro Limited
Copyright (c) 2015, Linaro Limited
Copyright (c) 2014, STMicroelectronics International N.V.
Copyright (c) 2017, Linaro Limited All rights reserved.
Copyright (c) 2020, ARM Limited. All rights reserved.
Copyright (C) 2011 Google, Inc.
Copyright 2002 Sun Microsystems, Inc. ALL RIGHTS RESERVED.
Copyright (c) 1998-2007 The OpenSSL Project. All rights reserved.
Copyright 2005 Nokia. All rights reserved.
Copyright 2002 Sun Microsystems, Inc.
Copyright (c) 2000-2002 The OpenSSL Project. All rights reserved.
Copyright 2002 Sun Microsystems, Inc. ALL RIGHTS RESERVED.
Copyright (C) 2006, Network Resonance, Inc. Copyright (C) 2011, RTFM, Inc.
Copyright 2002 Sun Microsystems, Inc. ALL RIGHTS RESERVED.
Copyright (C) 2005, 2007 Olivier Gay <olivier.gay@a3.epfl.ch> All rights reserved.
Copyright (c) 2012 - 2022 Krzysztof Gabis
© 2019 Unicode®, Inc. Unicode and the Unicode Logo are registered trademarks of Unicode, Inc. in the U.S. and other countries. For terms of use, see http://www.unicode.org/terms_of_use.html
Copyright (C) 1991, 1992, 1993, 1994, 1995, 1996, 1997, 1998, 1999, 2000, 2001, 2004, 2005, 2006, by Larry Wall

LICENCE TERMS (cont.)

and others
Copyright (C) 1993, 1994, 1996, 1997, 1998, 1999, 2000, 2001, 2002, 2004, 2005, 2006, 2007, 2008 by Larry Wall and others
Copyright (C) 1991, 1992, 1993, 1999, 2001, 2002, 2003, 2004, 2005, 2007, by Larry Wall and others
Copyright (C) 1991, 1992, 1993, 1994, 1995, 1996, 1997, 1998, 1999, 2000, 2001, 2002, 2003, 2004, 2005, 2006, 2007, 2008, 2009 by Larry Wall and others
Copyright (C) 1993, 1994, 1995, 1996, 1997, 1998, 1999, 2000, 2001, 2002, 2003, 2004, 2005, 2006, 2007, 2008, 2009, 2010, 2011, 2012, 2013, 2014, 2015, 2016, 2017, 2018, 2019 by Larry Wall and others. All rights reserved.
Copyright (C) 1993, 1994, 1995, 1996, 1997, 1998, 1999, 2000, 2001, 2002, 2003, 2004, 2005, 2006, 2007, 2008, 2009 by Larry Wall and others
Copyright (C) 1997, 1998, 2000, 2001, 2005, 2006, 2007, 2011 by Larry Wall and others
Copyright (C) 2001, 2002, 2003, 2005, 2006, 2007, 2009, 2010, 2011 by Larry Wall, Nick Ing-Simmons, and others
Copyright (C) 2007, 2011 by Larry Wall and others
Copyright (C) 1991, 1992, 1993, 1996, 1997, 1998, 1999, 2000, 2001, 2002, 2003, 2005, 2006, 2007, 2008, by Larry Wall and others
Copyright (C) 1991, 1992, 1993, 1994, 1995, 1996, 1997, 1998, 1999, 2000, 2001, 2002, 2003, 2004, 2005, 2006, 2007, 2008, 2009 by Larry Wall and others
Copyright (c) 1995 Your Name. All rights reserved. This program is free software
Copyright (C) 1991, 1992, 1993, 1994, 1995, 1996, 1997, 1998, 1999, 2000, 2001, 2002, 2003, 2004, 2005, 2006, 2007, 2008 by Larry Wall and others
Copyright (C) 2000, 2001, 2002, 2003, 2004, 2005, 2006, 2007, 2008 by Larry Wall and others
copyright 2004, Published by O'Reilly Media, Inc.), Damian Conway provides a list of criteria to use when deciding if OO is the right fit for your problem:
"Copyright (C) 2000, 2001, 2002, 2005, 2006, 2007, 2009, 2010, 2011 by Larry Wall and others;(c) (__ASSERT__(FITS_IN_8_BITS(c)) \;(c) UTF8_IS_ABOVE_LATIN1(c);(c) UVCHR_IS_INVARIANT((c) | 0);(c) UVCHR_IS_INVARIANT(c);(c) __BASE_TWO_BYTE_HI(c, NATIVE_TO_UNI);(c) __BASE_TWO_BYTE_LO(c, NATIVE_TO_UNI);(c) \;(c) \"
Copyright (C) 1996, 1997, 1998, 1999, 2000, 2001, 2002, 2003, 2004, 2005, 2006, 2007, 2008 by Larry Wall and others
Copyright (c) 2000
Copyright (c) 2007 Brandon L Black
Copyright (C) 1991, 1992, 1993, 1994, 1995, 1996, 1998, 1999, 2000, 2001, 2002, 2003, 2004, 2005, 2006, 2007, 2008 by Larry Wall and others
Copyright (C) 1993, 1994, 1996, 1997, 1998, 1999, 2000, 2001, 2002, 2007, by Larry Wall and others
Copyright (C) 1994, 1995, 1996, 1997, 1998, 1999, 2000, 2001, 2002, 2003, 2004, 2005, 2006, 2007, 2008 by Larry Wall and others
Copyright (C) 1991, 1992, 1993, 1994, 1995, 1996, 1997, 1998, 1999, 2000, 2001, 2002, 2003, 2004, 2005, 2006, 2007, 2008 by Larry Wall and others;(C) is that it is now physically possible for the LHS vars to appear on the RHS too, where they are not reference counted; but in this case, the compile-time PL_generation sweep will detect such common vars.;(C) differ from (B) in that if common vars are detected, the runtime "test RC==1" optimisation can no longer be used, and a full mark and sweep is required
Copyright 1987-2019, Larry Wall
Copyright (C) 2012 by Larry Wall and others
Copyright (C) 2015 by Larry Wall and others
Copyright 1998 The Perl Journal.
Copyright (C) 1989 Free Software Foundation, Inc.
Copyright (C) 1991, 1992, 1993, 1994, 1995, 1996, 1997, 1998, 1999, 2000, 2001, 2002, 2003, 2005, 2006, 2007, by Larry Wall and others
Copyright (C) 1994, 1995, 1996, 1997, 1999, 2000, 2001, 2002, 2003, 2004, 2005, 2006, 2007, 2016 by Larry Wall and others
Copyright (C) 1994, 1995, 1996, 1997, 1999, 2000, 2001, 2002, 2005, 2006, 2007 by Larry Wall and others
Copyright (C) 2002, 2003, 2005, 2006, 2007 by Larry Wall and others
Copyright (C) 2008, 2010, 2011 by Larry Wall and others
Copyright (c) 1986 by University of Toronto. Written by Henry Spencer. Not derived from licensed software.
Copyright (C) 1991, 1992, 1993, 2000, 2004, 2011 by Larry Wall and others
Copyright (c) 2012 Craig A. Berry
Copyright (C) 1993, 1994, 1995, 1996, 1997, 1998, 1999, 2000, 2001, 2002, 2003, 2004, 2005, 2006, 2007 by

Charles Bailey and others.
Copyright (C) 1993-2015 by Charles Bailey and others.
"Copyright (C) 1999, 2000, 2001, 2002, 2003, 2004, 2005, 2006, by Larry Wall and others;(c) condition_signal(*c);(c) condition_broadcast(*c) define COND_WAIT(c, m) condition_wait(*c, *m);(c) NOOP endif;(c) NOOP endif;(c) NOOP endif;(c) NOOP endif"
Copyright (C) 1993, 1994, 1995, 1996, 1997, 1998, 1999, 2000, 2001, 2002, 2003, 2004, 2005, 2006, 2007, 2008 by Larry Wall and others
Copyright (c) 1991-2002, 2003, 2004, 2005, 2006 Larry Wall
Copyright 2010 by Makamaka Hannyaharamitu
Copyright (c) 2011-2018 Paul Marquess. All rights reserved.
Copyright (C) 2003-2018 Mark Shelor, All Rights Reserved
Copyright 2006 Yves Orton and 2007 E<AElig>var ArnfjE<ouml>rE<eth> Bjarmason.
Copyright © 2012 Tom Christiansen.
Copyright (C) 1991, 1992, 1993, 1994, 1995, 1996, 1997, 1998, 1999, 2000, 2001, 2002, 2004, 2005, 2006, 2007, 2008, 2009 by Larry Wall and others
Copyright (C) 1991, 1992, 1993, 1994, 1995, 1996, 1997, 1998, 1999, 2000, 2001, 2002, 2003, 2004, 2005, 2006, 2007, 2008 by Larry Wall and others;(C) compile time, or at least, doing most of the work. */ if (!PL_psig_name[i]) { PL_psig_name[i] = newSVpv(n, len); SvREADONLY_on(PL_psig_name[i]);
Copyright (C) 2012 by Larry Wall and others
Copyright (C) 1993, 1994, 1995, 1996, 1997, 1998, 1999, 2000, 2001 2002, 2003, 2004, 2005, 2006, 2007, 2008, 2009 by Larry Wall and others
Copyright (C) 1993, 1994, 1995, 1996, 1997, 1998, 1999, 2000, 2001, 2002, 2003, 2004, 2005, 2006, 2007 by Larry Wall and others
Copyright (C) 2010, 2011 by Larry Wall and others
Copyright (c) 1996-2006, Nick Ing-Simmons
Copyright (C) 1984, 1989-1990, 2000-2015, 2018 Free Software Foundation, Inc.
Copyright (C) 1993, 1994, 1995, 1996, 1997, 1998, 1999, 2000, 2001 2002, 2003, 2004, 2005, 2006, 2007, 2008, 2009, 2010, 2011, 2012 2013, 2014, 2015, 2016, 2017, 2018, 2019 by Larry Wall and others
(c) 1995 Microsoft Corporation. All rights reserved.
(c) 1999 Microsoft Corporation. All rights reserved.
Copyright 19.... ah hell, just take it.
(C) comments:
Copyright (C) 2013 by Larry Wall and others
Copyright Ilya Zakharevich 1996-99.
Copyright © 2001 Novell, Inc. All Rights Reserved.
(c) 1995 Microsoft Corporation. All rights reserved. Developed by hip communications inc.
Copyright (C) 1993 Eric Young
Copyright (C) 2000-01, 2002 Novell, Inc. All Rights Reserved."
Copyright (C) 1993, 1994, 1995, 1996, 1997, 1998, 1999, 2000, 2001, 2002, 2003, 2004, 2005, 2006, 2007, 2008 by Larry Wall and others
Copyright (C) 1991, 1992, 1993, 1994, 1995, 1996, 1997, 1999, 2000, 2001, 2002, 2003, 2004, 2005, 2006, 2007, 2008 by Larry Wall and others
Copyright (C) 1991, 1992, 1993, 1995, 1996, 1998, 2000, 2001, by Larry Wall and others
Copyright 1992-2019 Free Software Foundation, Inc.
Copyright (c) 2007-2008 Michael G Schwern
Copyright (C) 1997, 1998, 1999, 2000, 2001, 2002, 2003, 2004, 2005, 2006, 2007, 2008 by Larry Wall and others
Copyright (C) 1996, 1997, 1998, 1999, 2000, 2001, 2002, 2003, 2006, 2007, 2008 by Larry Wall and others
Copyright (c) 2006, 2007, 2009, 2010, 2011 Larry Wall and others
Copyright (C) 1991, 1992, 1993, 1994, 1995, 1996, 1997, 1999, 2000, 2001, 2002, 2004, 2005, 2006, 2007, 2008, 2012 by Larry Wall and others;(c) returns true if c doesn't have a bit set other than in the lower 8. It is designed to be hopefully bomb-proof, making sure that no bits of information are lost even on a 64-bit machine, but to get the compiler to optimize it out if possible.
Copyright (C) 1999, 2000, 2001, 2002, 2003, 2004, 2005, 2006, 2007, by Larry Wall and others
Copyright (C) 1995, 1996, 1997, 1998, 1999, 2000, 2001, 2002, 2003, 2004, 2005, 2006, 2007, 2008 by Larry Wall and others;(c) we're portable to non-POSIX platforms where ino_t isn't defined, so have no name for the type of st_ino; and (d) sprintf() doesn't necessarily support integers as large as st_ino.
Copyright (c) 1991-2006 Unicode, Inc.

LICENCE TERMS (cont.)

Copyright (C) 2007-2010, Marcus Holland-Moritz <mhx@cpan.org>.
Copyright (C) 1991, 1992, 1993, 1994, 1995, 1996, 1997, 1998, 1999, 2000, 2001, 2002, 2003, 2004, 2005, 2006, 2007, 2008 by Larry Wall and others
Copyright (c) 2004, 2005, 2006, 2007, 2008, 2009, 2010, 2011 by Larry Wall and others
Copyright (C) 1991, 1992, 1993, 1994, 1995, 1996, 1997, 1999, 2000, 2002, 2005, 2006, 2007, 2008 by Larry Wall and others
Copyright (C) 1989 Free Software Foundation, Inc.
Copyright (C) 1993, 1994, 1995, 1996, 1997, 1998, 1999, 2000, 2001, 2002, 2003, 2005, 2006, 2007, 2008 by Larry Wall and others
Copyright (C) 1996, 2000, 2001, 2005, by Larry Wall and others
Copyright (C) 1996, 1997, 1999, 2000, 2001, 2002, 2003, 2004, 2005, 2006, 2007, by Larry Wall and others
Copyright (C) 1994, 1995, 1996, 1997, 1998, 1999, 2000, 2001, 2002, 2003, 2004, 2005, 2006, 2007 Larry Wall and others.
Copyright (C) 2002, 2003, 2004, 2005, 2006, 2007, 2008 by Larry Wall and others
Copyright (c) 2004, 2005, 2006, 2009, 2010, 2011 Larry Wall
Copyright (C) 1991, 1992, 1993, 1995, 1996, 1997, 1998, 1999, 2000, 2001, 2002, 2005, 2006, 2007, 2008, by Larry Wall and others
Copyright (C) 1993, 1994, 1995, 1996, 1997, 1999, 2000, 2001, 2002, 2003, 2006, 2007, by Larry Wall and others
Copyright (C) 1993, 1995, 1996, 1997, 1998, 1999, 2000, 2001, 2002, 2003, 2004, 2005, 2006, 2007, 2008, 2009, by Larry Wall and others
Copyright (C) 2005, 2006, 2007, 2008, 2009, 2010, 2011, 2012 by Larry Wall and others
Copyright (C) 2002, 2003, 2005, 2006, 2007, 2008, 2009, 2010, 2011 by Larry Wall and others
Copyright (C) 1995, 1999, 2000, 2001, 2008 by Larry Wall and others
Copyright (c) 1995-2018 Paul Marquess. All rights reserved. This program is free software; you can redistribute it and/or modify it under the same terms as Perl itself.
Copyright (c) 1998-2012 Paul Marquess. All rights reserved. This program is free software; you can redistribute it and/or modify it under the same terms as Perl itself.
Copyright (c) 1995-2002 Paul Marquess. All rights reserved. This program is free software; you can redistribute it and/or modify it under the same terms as Perl itself.
Copyright (c) Nokia 2004-2005. All rights reserved. This code is licensed under the same terms as Perl itself.
Copyright (c) Nokia, 2004-2005, all rights reserved, and licensed under the same terms as Perl itself.
Copyright (c) 2004-2005 Nokia. All Rights Reserved.
Copyright (c) 2004-2005 Nokia. All rights reserved. */
Copyright (c) 2004-2005 Nokia. All rights reserved. This utility is licensed under the same terms as Perl itself.
Copyright (C) 1996-2010 Julian Seward <jseward@bzip.org>
Copyright (c) 2005-2010 Paul Marquess. All rights reserved. This program is free software; you can redistribute it and/or modify it under the same terms as Perl itself.
Copyright (c) 2004-2005 Nokia. All rights reserved. The sisify.pl utility is licensed under the same terms as Perl itself.
Copyright (c) 200-2005 Nokia. All rights reserved. */
Copyright (c) 2004-2005 Nokia. All rights reserved. */
copyright (C) 1996-2010 Julian R Seward. All rights reserved.
Copyright (c) 2005 Nokia. All rights reserved. */
Copyright (c) 2004-2005 Nokia. All rights reserved.
Copyright (C) 2003-2018 Mark Shelor, All Rights Reserved
"Copyright (C) 2003-2018 Mark Shelor, All Rights Reserved;(c) c ## U elif UINT_MAX == SHA32_MAX define SHA32 unsigned int;(c) c ## U elif ULONG_MAX == SHA32_MAX define SHA32 unsigned long;(c) c ## UL else undef SHA32_ALIGNED undef SHA_LO32 define SHA_LO32(x) ((x) & SHA32_MAX) undef SHA32_SHR define SHA32_SHR(x, n) (SHA_LO32(x) >> (n)) define SHA32 unsigned long;(c) c ## UL endif;(c) c ## UL elif defined(SHA_ULL_EXISTS) && defined(LONGLONGSIZE) && LONGLONGSIZE == 8 define SHA64 unsigned long long;(c) c ## ULL elif defined(SHA_ULL_EXISTS) undef SHA64_ALIGNED undef SHA64_SHR define SHA64_MAX 18446744073709551615ULL define SHA64_SHR(x, n) (((x) & SHA64_MAX) >> (n)) define SHA64 unsigned long long;(c) c ## ULL"
Copyright (c) 2006 Alexander Smishlajev. All rights reserved. */
Copyright (C) 2000, by Larry Wall and others
Copyright (C) 1993, 1994, 1996, 1997, 1999, 2000, 2001, 2003, 2005, 2006, 2007, 2008 by Larry Wall and others
Copyright 2013-2014, Niels Thykier E<lt>niels@thykier.netE<gt>
Copyright 2009, Paul Fenwick E<lt>pjf@perltraining.com.auE<gt>

Copyright 2013, Paul Fenwick <pjf@cpan.org>
Copyright 2008-2009, Paul Fenwick E<lt>pjf@perltraining.com.auE<gt>
Copyright 2013, Niels Thykier E<lt>niels@thykier.netE<gt>
Copyright (C)2008 Paul Fenwick
Copyright (C) 1993, 1994, 1995, 1996, 1997, 1998, 1999, 2000, 2001, 2002, 2003, 2004, 2005, 2006, 2007, 2008, 2009, 2011, 2012, 2013 by Larry Wall and others
Copyright (C) 1995-2003, 2010, 2014, 2016 Jean-loup Gailly, Mark Adler
Copyright (C) 1995-2017 Jean-loup Gailly detect_data_type() function provided freely by Cosmin Truta, 2006
Copyright (C) 1995-2017 Mark Adler
Copyright (C) 1995-2011, 2016 Mark Adler
Copyright (C) 1995-2017 Jean-loup Gailly and Mark Adler
Copyright (C) 1995-2017 Mark Adler
copyright (c) 2016 by David Golden.
Copyright (c) 1995-2013 Paul Marquess. All rights reserved. This program is free software
Copyright (C) 1995-2005, 2014, 2016 Jean-loup Gailly, Mark Adler
Copyright (C) 1995-2016 Mark Adler
Copyright 1995-2017 Jean-loup Gailly and Mark Adler
Copyright (C) 1995-2017 Jean-loup Gailly
Copyright (C) 1995-2016 Jean-loup Gailly, Mark Adler
Copyright (C) 1995-2016 Jean-loup Gailly
Copyright (C) 1995-2016 Jean-loup Gailly
Copyright (C) 1995-2003, 2010 Mark Adler
Copyright (C) 1995-2016 Jean-loup Gailly, Mark Adler
Copyright (C) 1995-2005, 2010 Mark Adler
Copyright (C) 1995-2006, 2010, 2011, 2012, 2016 Mark Adler
Copyright (C) 1995-2017 Jean-loup Gailly and Mark Adler
Copyright 1995-2017 Mark Adler
Copyright (c) 1982, 1986, 1988, 1993 The Regents of the University of California. All rights reserved.
Copyright (c) 1997-2000 Graham Barr <gbarr@pobox.com>. All rights reserved. This program is free software; you can redistribute it and/or modify it under the same terms as Perl itself.
Copyright 1996, 1997, 1998, 2000, 2001, 2002, 2005, 2006, 2008, 2009, 2010, 2011, 2012, 2013, 2014, 2015, 2016 Russ Allbery <rra@cpan.org>
Copyright 1995-2015 (c) perl5 porters.
Copyright (C) 2009-2018 H.Merijn Brand
Copyright (C) 2002,2004 Tim Jenness, Christian Soeller, Hugo van der Sanden. All Rights Reserved.
Copyright (C) 2001 Tim Jenness All Rights Reserved. This program is free software; you can redistribute it and/or modify it under the same terms as Perl itself.
Copyright (c) 1996-2000 by Bradford Appleton. All rights reserved.
Copyright (C) 1996-2000 by Bradford Appleton. All rights reserved. This file is part of "PodParser". PodParser is free software; you can redistribute it and/or modify it under the same terms as Perl itself.
copyright 1996 by Charles Bailey. Permission is granted to distribute the revised code under the same terms as Perl itself.
Copyright 1999-2000 by Russ Allbery <rra@stanford.edu>
copyright (c) 2019 by Tim Jenness and the UK Particle Physics and Astronomy Research Council.
Copyright (c) 2005 Paul Marquess. All rights reserved. This program is free software; you can redistribute it and/or modify it under the same terms as Perl itself.
Copyright (C) All Perl Hackers everywhere Ton Voon <ton.voon@opsera.com>, 2009.
Copyright 2013, 2014 The Board of Trustees of the Leland Stanford Junior University
Copyright 2015, 2016 Russ Allbery <eagle@eyrie.org>
Copyright 2012 Russ Allbery <rra@cpan.org>
Copyright 2012, 2013, 2014 Russ Allbery <rra@cpan.org>
copyright 1999 The Perl Journal. It appears courtesy of Jon Orwant and The Perl Journal. This document may be distributed under the same terms as Perl itself.
Copyright 2011 Revilo Reegiles
Copyright (c) 1999-2004 Sean M. Burke. All rights reserved.
Copyright 1997, 1998, 2000, 2001, 2002, 2005, 2006, 2009, 2010, 2012, 2014 Russ Allbery <rra@cpan.org>
Copyright (c) 1997-2007 Graham Barr <gbarr@pobox.com>. All rights reserved. This program is free software
Copyright 2012 Kurt Starsinic <kstarsinic@gmail.com>

LICENCE TERMS (cont.)

Copyright (c) 1996-2019 Gurusamy Sarathy. All rights reserved. This program is free software; you can redistribute it and/or modify it under the same terms as Perl itself.

Copyright 2007-2016 by Makamaka Hannyaharamitu

Copyright (c) 2000-2014, Damian Conway. All Rights Reserved. This module is free software. It may be used, redistributed and/or modified under the same terms as Perl itself.

Copyright (c) 1995-2011 Paul Marquess. All rights reserved.

Copyright (c) 1997-8 Graham Barr <gbarr@pobox.com>. All rights reserved. This program is free software

(C) Paul Evans, 2010-2015 -- leonerd@leonerd.org.uk

Copyright (c) 1996-8 Graham Barr <gbarr@pobox.com>. All rights reserved. This program is free software

Copyright (c) 2005-2019 Paul Marquess. All rights reserved.

Copyright (c) 1998-2000 by Bradford Appleton. All rights reserved.

Copyright (c) 1998-2004 Tom Hughes <tom@compton.nu>. All rights reserved. This program is free software

Copyright (c) 2014 Paul Evans <leonerd@leonerd.org.uk>. All rights reserved. This program is free software; you can redistribute it and/or modify it under the same terms as Perl itself.

Copyright (c) 1995-2019 Paul Marquess. All rights reserved.

Copyright (C) 2009, 2011

Copyright (c) 2001+ Sean M. Burke. All rights reserved.

Copyright 2001 by Jarkko Hietaniemi

Copyright (c) 1998-2000 Joshua Nathaniel Pritikin.

copyright (c) 2010 by David Golden, Ricardo Signes, Adam Kennedy and Contributors.

Copyright (c) 1996-2002 Douglas E. Wegscheid. All rights reserved.

copyright (c) 1997 - 2018 by Graham Barr & Dave Rolsky.

Copyright 2001, Larry Wall.

Copyright (c) 2007-2017 Max Maischein C<< corion@cpan.org >> Based on the idea of C<base.pm>, which was introduced with Perl 5.004_04.

Copyright 1998-2006 Gisle Aas.

Copyright (c) 2001-2014, Damian Conway. All Rights Reserved. This module is free software. It may be used, redistributed and/or modified under the same terms as Perl itself.

Copyright (C) 2002-2009 Richard Clamp. All Rights Reserved.

© Tomas Doran tokuhirom Christian Walde Tatsuhiko Miyagawa Peter Rabbitson Steve Hay Jerry D. Hedden Craig A. Berry Mitchell Steinbrunner Edward Zborowski Gareth Harper James Raspas 'BinGOs' Williams Josh Jore Kent Fredric

Copyright (C) 2005 Joshua Hoblitt

Copyright (c) 1996-2000 by Bradford Appleton. All rights reserved. This file is part of "PodParser". PodParser is free software; you can redistribute it and/or modify it under the same terms as Perl itself.

Copyright (C) 2013 Chris Williams. All Rights Reserved.

Copyright 1997-2004 Gisle Aas

Copyright (C) 2007-2013, Marcus Holland-Moritz <mhx@cpan.org>.

© 2019 Unicode®, Inc. For terms of use, see http://www.unicode.org/terms_of_use.html

Copyright 1998-2000 Gisle Aas.

Copyright 1999-2001, 2008, 2010, 2012, 2014-2016, 2018 Russ Allbery <rra@cpan.org>

Copyright 2001, 2009, 2018 by Russ Allbery <rra@cpan.org>

Copyright 2006, 2008-2009, 2012, 2015, 2018 by Russ Allbery <rra@cpan.org>

Copyright 2001-2002, 2004, 2006, 2009, 2012, 2014-2015, 2018 Russ Allbery <rra@cpan.org>

Copyright 2006, 2009, 2012, 2014-2016, 2018 Russ Allbery <rra@cpan.org>

Copyright 2015, 2016, 2018 Russ Allbery <rra@cpan.org>

Copyright 2013, 2014 The Board of Trustees of the Leland Stanford Junior University

Copyright 2016 Russ Allbery <eagle@eyrie.org>

Copyright 2016 Russ Allbery <eagle@eyrie.org>

Copyright 2012-2014 The Board of Trustees of the Leland Stanford Junior University

Copyright 2013-2014 The Board of Trustees of the Leland Stanford Junior University

Copyright 2018 Russ Allbery <eagle@eyrie.org>

Copyright 2014-2016 Russ Allbery <eagle@eyrie.org>

Copyright 2002, 2004, 2006-2009, 2012, 2015, 2018 Russ Allbery <rra@cpan.org>

Copyright 2002, 2004, 2006, 2009, 2012-2013, 2018 Russ Allbery <rra@cpan.org>

Copyright 2002, 2004, 2006-2009, 2012, 2014, 2018 Russ Allbery <rra@cpan.org>

"COPYRIGHT SIGN 00A9"

Copyright 2002, 2004, 2006, 2008-2009, 2012-2013, 2015, 2018 Russ Allbery <rra@cpan.org>

Copyright 2002, 2004, 2006-2010, 2012, 2014, 2018 Russ Allbery <rra@cpan.org>

Copyright 2013, 2018 Russ Allbery <rra@cpan.org>

Copyright 2002, 2004, 2006-2009, 2012, 2018 Russ Allbery <rra@cpan.org>

Copyright 2002, 2004, 2006, 2009, 2012-2014, 2018 Russ Allbery <rra@cpan.org>

Copyright 2002, 2004, 2006, 2008-2010, 2012, 2014-2015, 2018 Russ Allbery <rra@cpan.org>

Copyright 2009, 2014-2015, 2018 Russ Allbery <rra@cpan.org>

Copyright 2016 Niko Tyni <ntyni@iki.fi>

Copyright 2015-2016, 2018 Russ Allbery <rra@cpan.org>

Copyright 2002, 2004, 2006, 2008-2009, 2012-2013, 2015-2016, 2018 Russ Allbery <rra@cpan.org>

Copyright 2013, 2016, 2018 Russ Allbery <rra@cpan.org>

Copyright 2002, 2004, 2006, 2008-2009, 2012, 2015, 2018 Russ Allbery <rra@cpan.org>

Copyright 2016 Russ Allbery <rra@cpan.org>

Copyright 2015, 2018 Russ Allbery <rra@cpan.org>

Copyright 2001, 2004, 2016, 2018 Russ Allbery <rra@cpan.org>

Copyright 2001, 2004, 2016, 2018 Russ Allbery <rra@cpan.org> PP Copying and distribution of this file, with or without modification, are

Copyright 2001, 2004, 2016, 2018 Russ Allbery <rra@cpan.org>

Copyright 1999-2001, 2004, 2006, 2008, 2010, 2012-2018 Russ Allbery rra@cpan.org>

Copyright 1999-2001, 2004, 2006, 2008, 2010, 2012-2018 Russ Allbery rra@cpan.org>

Copyright 1999-2001, 2004, 2006, 2008, 2010, 2012-2018 Russ Allbery rra@cpan.org> PP This program is free software; you may redistribute it and/or modify it under the same terms as Perl itself. SH "SEE ALSO" IX Header "SEE ALSO" Pod::Text, Pod::Text::Color, Pod::Text::Overstrike, Pod::Text::Te

Copyright 1999-2001, 2004, 2006, 2008, 2010, 2012-2018 Russ Allbery rra@cpan.org> PP This program is free software; you may redistribute it and/or modify it under the same terms as Perl itself. SH "SEE ALSO" IX Header "SEE ALSO" Pod::Man, Pod::Simple, \fBmanfR\|(1), \fBnroffR\|(1), \fBperlP

Copyright (c) 1995-2018 Paul Marquess. All rights reserved. This program is free software

copyright (C) 2003 Mark Jason Dominus.

Copyright (C) 1996-2002,2005,2006 David Muir Sharnoff.

Copyright (C) 1996-2009 David Muir Sharnoff.

Copyright (c) 1997-2009 Graham Barr <gbarr@pobox.com>. All rights reserved. This program is free software

Copyright (c) 1995-2001, Raphael Manfredi

copyright (c) 2013 by Leon Timmermans.

copyright (c) 1996- by Andreas Koenig.

Copyright 2010 Gisle Aas <gisle@aas.no>.

Copyright (C) 2000-2003 Stephen McCamant. All rights reserved. This program is free software; you can redistribute and/or modify it under the same terms as Perl itself.

Copyright (c) 1998-2000, 2002, 2003, 2004, 2005, 2006 Stephen McCamant. All rights reserved. This module is free software; you can redistribute and/or modify it under the same terms as Perl itself.

Copyright (C) 2014 by Larry Wall and others

Copyright 2000 Gisle Aas.

Copyright (C) 2006-2007 by (Anno Siegel)

Copyright (C) 1993, 1994, 1995, 1996, 1997, 1998, 1999, 2000, 2001, 2002, 2003, 2004, 2005, 2006 by Larry Wall and others

Copyright (C) 1995-2006 Graham Barr. All rights reserved.

Copyright (C) 2000 Graham Barr. All rights reserved.

Copyright (C) 1995-1997 Graham Barr. All rights reserved.

Copyright (C) 1995-2004 Graham Barr. All rights reserved.

Copyright (C) 1995-1998 Graham Barr. All rights reserved.

Copyright 1999-2002, 2004, 2006, 2008-2009, 2012-2016, 2018 Russ Allbery rra@cpan.org>

Copyright 2001, 2008, 2009, 2014, 2018 Russ Allbery <rra@cpan.org>

Copyright (C) 1999-2000 by Marek Rouchal (and borrowing code from Nick Ing-Simmon's PodToHtml). All rights reserved. This file is part of "PodParser". Pod::Find is free software; you can redistribute it and/or modify it under the same terms as Perl itself.

Copyright (C) 1999-2000 by Marek Rouchal. All rights reserved. This file is part of "PodParser". PodParser is free software; you can redistribute it and/or modify it under the same terms as Perl itself.

Copyright (c) 2002 Sean M. Burke. All rights reserved.

LICENCE TERMS (cont.)

Copyright (c) 2011 Mark Allen. All rights reserved.
Copyright (c) 2002-2007 Sean M. Burke.
Copyright (c) 2017 Mark Allen.
Copyright (c) 2011 brian d foy. All rights reserved.
Copyright (c) 2002 Sean M. Burke.
Copyright 1999, 2001-2002, 2004, 2006, 2008-2009, 2014-2015, 2018 Russ Allbery rra@cpan.org>
Copyright 1999, 2001, 2004, 2006, 2008, 2009, 2018 Russ Allbery rra@cpan.org>
Copyright 2000 by Joe Smith <Joe.Smith@inwap.com>
Copyright (c) 2002-2004 Sean M. Burke.
Copyright (c) 2004 Sean M. Burke.
Copyright (c) 2003-2005 Allison Randal.
Copyright (C) 1994-2000 by Bradford Appleton. All rights reserved.
Copyright 1999-2010, 2012-2018 Russ Allbery <rra@cpan.org>
Copyright (c) 2001-2004 Sean M. Burke. All rights reserved.
Copyright 1998, 1999, 2000, 2001, 2012 M. J. Dominus.
Copyright (c) 1995 Graham Barr & Nick Ing-Simmons. All rights reserved. This program is free software
Copyright (c) 1991-2011 Unicode, Inc. All Rights reserved.
Copyright (c) 1991-1999 Unicode, Inc. All Rights reserved.
© Randy Sims Tomohiro Hosaka
Copyright (c) 1991-1999 Unicode, Inc. All Rights reserved.
Copyright (c) 1991-2011 Unicode, Inc. All Rights reserved.
copyright (c) 2010 by David Golden and Ricardo Signes.
copyright (c) 2010 by Adam Kennedy.
Copyright 1990,2015 by Johan Vromans. This program is free software; you can redistribute it and/or modify it under
the terms of the Perl Artistic License or the GNU General Public License as published by the Free Software
Foundation; either version 2 of the License, or (at your option) any later ve
Copyright (C) 2008 by Larry Wall and others
Copyright 2003 by Fergal Daly <fergal@esatclear.ie>.
copyright 2005 Fergal Daly <fergal@esatclear.ie>
Copyright (c) 1998 - 1999 Unicode, Inc. All Rights reserved.
Copyright (c) 1996 by Eryq. All rights reserved.
Copyright Mark Fowler E<lt>mark@twoshortplanks.comE<gt> 2002.
Copyright Mark Fowler E<lt>mark@twoshortplanks.comE<gt> 2002, 2004.
Copyright (c) 1996, 1997, 1998 Malcolm Beattie
Copyright (C) 2003-2018 Mark Shelor
Copyright(C) 2001-2012, SADAHIRO Tomoyuki. Japan. All rights reserved.
Copyright(C) 2001-2018, SADAHIRO Tomoyuki. Japan. All rights reserved.
Copyright(C) 2004-2018, SADAHIRO Tomoyuki. Japan. All rights reserved.
Copyright (c) 1999-2001 Unicode, Inc. All Rights reserved.
Copyright (c) 2002 Unicode, Inc. All Rights reserved.
Copyright (c) 1991-2008 Unicode, Inc. All Rights reserved.
Copyright 2017 Unicode, Inc.
Copyright (c) 1999 Unicode, Inc. All Rights reserved.
Copyright (c) 1995-98 Ilya Zakharevich. All rights reserved. This program is free software; you can redistribute it and/
or modify it under the same terms as Perl itself.
Copyright (C) 2004-2013, Marcus Holland-Moritz.
Copyright (C) 2002 Your Name <your@address.domain>
Copyright (C) 1999, 2000, 2001, 2002, 2003, 2004, 2005, 2006, 2007, 2008 by Larry Wall and others
"(c) inet_addr(c) define PerlSock_inet_ntoa(i) inet_ntoa(i) define PerlSock_listen(s, b) listen(s, b) define PerlSock_
recv(s, b, l, f) recv(s, b, l, f) define PerlSock_recvfrom(s, b, l, f, from, fromlen) \ recvfrom(s, b, l, f, from,
fromlen) define PerlSock_select(n, r, w, e, t) select(n,"
copyright (c) 2002 by Ilya Zakharevich.
Copyright (C) 1991, 1992, 1993, 1995, 1996, 1997, 1998, 1999, 2000, 2001, by Larry Wall and others
Copyright (C) 2001 Tim Jenness. All Rights Reserved
Copyright (C) 2013 by Andy Broad.
Copyright (C) 2007 by Larry Wall and others
Copyright (C) 2002-2013, and GNU GPL'd, by Nicholas Nethercote et al.
Copyright (c) 1996 Malcolm Beattie
Copyright (c) 1989, 1993 The Regents of the University of California. All rights reserved.
Copyright (C) 2005-2012 by H.Merijn Brand (m)'12 [22-09-2012]
copyright (c) 2010 by David Golden.
Copyright (c) 1991, 1992, 1993, 1994, 1995, 1996, 1997, 1998, 1999, 2000, 2001, 2002, 2003, 2004, 2005, 2006,
2007, 2008 by Larry Wall and others;(c) isBLANK_A(c)
"Copyright: 2004, Nokia License: Artistic/GPL"
copyright (c) 1992 Helios Software GmbH 3000 Hannover 1, Germany
Copyright (c) 1994, Larry Wall
Copyright (c) 1997-8 Graham Barr <gbarr@pobox.com>. All rights reserved. This program is free software; you can
redistribute it and/or modify it under the same terms as Perl itself.
Copyright (c) 1995-2000, Raphael Manfredi
Copyright (c) 1995-2000, Raphael Manfredi;(C) Copyright 1997, Universitat Dortmund, all rights reserved.
Copyright 2002, Larry Wall.
Copyright (c) 1995-2000, Raphael Manfredi
Copyright 2004, Larry Wall.
Copyright 2005, Adam Kennedy.
Copyright (c) 2002 Slaven Rezic
Copyright (c) 2001-2002, 2006 Larry Wall
Copyright (c) 2003 Constantin S. Svintsoff <kostik@iclub.nsu.ru>
Copyright (C) 2017, Pali <pali@cpan.org>
copyright (c) 2017 by Ken Williams.
copyright SIGN 00AA
Copyright 1987-2019, Larry Wall
Copyright 2013 Tom Christiansen.
Copyright (c) 2007, 2008, 2009, 2010, 2011 Larry Wall and others
Copyright (c) 2008-2009 Bjoern Hoehrmann <bjoern@hoehrmann.de>
Copyright (c) 2008-2009 Bjoern Hoehrmann <bjoern@hoehrmann.de>
Copyright (c) 2008-2009 Bjoern Hoehrmann <bjoern@hoehrmann.de>
Copyright (c) 2002,2003 Jarkko Hietaniemi RCS: RCS:
Copyright (C) 1995, 1996, 1997, 1998 Doug MacEachern and Jon Orwant. All Rights Reserved.
Copyright 1999, 2000, 2001, 2004, 2006, 2008, 2010, 2015, 2018 Russ Allbery <rra@cpan.org>
Copyright (C) 1991, 1992, 1993, 1994, 1995, 1996, 1997, 1998, 1999, 2000, 2001, 2002, 2003, 2004, 2005, 2006,
2007, 2008 by Larry Wall and others
Copyright 1996 by Charles Bailey <bailey@newman.upenn.edu> Permission is given to distribute this code as part of
the Perl standard distribution under the terms of the GNU General Public License or the Perl Artistic License. Copies
of each may be found in the Perl standard distribution
Copyright (C) 1989-1994, 2007 by * Mark Pizzolato - INFO COMM, Danville, California (510) 837-5600 *
Copyright 1996 by Charles Bailey <bailey@newman.upenn.edu>. Incorporates, with permission, some code from
EZZCOPY by Tim Adye T.J.Adye@rl.ac.uk>. Permission is given to distribute this code as part of the Perl standard
distribution under the terms of the GNU General Public License or
Copyright (c) 1993 Martin Birgmeier All rights reserved.
Copyright (c) 2007, 2008, 2009, 2010, 2011 by Larry Wall and others
Copyright 2010 Grant McLean E<lt>grantm@cpan.orgE<gt>
Copyright (c) 2011-2018 Paul Marquess. All rights reserved.
Copyright (c) 2011-2018 Paul Marquess. All rights reserved.
Copyright (C) 2003-2018 Mark Shelor <mshelor@cpan.org>.
Copyright 2015 Michael LaGrasta and Dan Kogai.
Copyright 2010, brian d foy C<<< <brian.d.foy@gmail.com> >>
Copyright (c) 2002-2007 by D.H. aka PodMaster
Copyright (c) 2001-2015, brian d foy, All Rights Reserved.
Copyright © 2012 Tom Christiansen
Copyright (C) 1998, 2002, 2003 Jon Orwant. All Rights Reserved.
Copyright 2001-2011 Jarkko Hietaniemi
Copyright (c) 2000 Mark Kvale. All rights reserved. Now maintained by Perl porters.
Copyright (c) 2006, 2007, 2008, 2009, 2010, 2011 Larry Wall and others
Copyright 1987-2019, Larry Wall

LICENCE TERMS (cont.)

Copyright (c) 1989, 1990, Diomidis Spinellis
Copyright (c) 1990, 1991, Raymond Chen, Kai Uwe Rommel
Copyright (c) 1994-2002, Andreas Kaiser, Ilya Zakharevich
Copyright (c) 2000 Mark Kvale All rights reserved.
Copyright (C) 2000-01 Novell, Inc. All Rights Reserved.
Copyright (C) 2000-01 Novell, Inc. All Rights Reserved.
Copyright (C) 2000-01 Novell, Inc. All Rights Reserved.
Copyright (C) 2000-01 Novell, Inc. All Rights Reserved.
Copyright 1992-2019 Free Software Foundation, Inc.
Copyright (c) 2004 by the Perl 5 Porters. All rights reserved.
Copyright (c) 1997-8 Graham Barr. All rights reserved. This program is free software
Copyright (C) 1990-2011 by Larry Wall and others.
Copyright (C) 1999, Graham Barr <gbarr@pobox.com>.
Copyright (C) Tom Horsley, 1997. All rights reserved.
Copyright (C) 1991, 1992, 1993, 1994, 1995, 1996, 1997, 1998, 1999, 2000, 2001, 2002, 2003, 2004, 2005, 2006, 2007, 2008 by Larry Wall and others
Copyright (c) 2004-2005, Nokia. All rights reserved. */
Copyright (c) 2004-2005 Nokia. All rights reserved.
Copyright 1987-2005 Larry Wall and others, Symbian port Copyright Nokia 2004-2005")
Copyright = 1028, EPerlAppCommandAboutCopyright = 1029, EPerlAppLast = 1099 // no comma here
Copyright 2006 by Marcus Holland-Moritz <mhx@cpan.org>.
Copyright (C) 1990-2012 by Larry Wall and others.
Copyright 1995-2017 Mark Adler "
Copyright 1995-2017 Mark Adler "
Copyright 1995-2017 Jean-loup Gailly and Mark Adler "
Copyright 1995-2017 Jean-loup Gailly and Mark Adler "
Copyright (c) 2000-2001, Damian Conway. All Rights Reserved. This module is free software. It may be used, redistributed and/or modified under the same terms as Perl itself.
Copyright (C) 1995 Jean-loup Gailly.
Copyright (C) 2003 Mark Adler, all rights reserved version 1.1, 4 Nov 2003
Copyright (C) 1995 Jean-loup Gailly.
Copyright (C) 2003 Mark Adler, all rights reserved version 1.1, 4 Nov 2003
Copyright 2019 Chad Granum E<lt>exodist@cpan.orgE<gt>.
Copyright 2012 Kurt Starsinic <kstarsinic@gmail.com>
Copyright 1996, 1997, 1998, 2000, 2001, 2002, 2005, 2006, 2008, 2009, 2010, 2011, 2012, 2013, 2014, 2015, 2016 Russ Allbery <rra@cpan.org>
Copyright 2012 Kurt Starsinic <kstarsinic@gmail.com>
Copyright (C) 2009 Andrew Main (Zefram) <zefram@fysh.org>
Copyright (c) 2001-2016 by Marek Rouchal. This file is part of "Pod-Usage". Pod-Usage is free software
Copyright (c) 1989, 1993 The Regents of the University of California. All rights reserved.
Copyright (c) 1989, 1993 The Regents of the University of California. All rights reserved.
Copyright (c) 2004-2013 by the Perl 5 Porters. All rights reserved.
Copyright (c) 2004-14 by the Perl 5 Porters. All rights reserved.
Copyright (c) 2004,2007 by the Perl 5 Porters. All rights reserved.
Copyright (c) 2004 by the Perl 5 Porters. All rights reserved.
copyright (C) Charles Bailey, Tim Bunce, David Landgren, James Keenan and Richard Elberger 1995-2018. All rights reserved.
Copyright 2013, 2014 The Board of Trustees of the Leland Stanford Junior University
Copyright 2003, 2004, 2005, 2006 by Audrey Tang E<lt>cpan@audreyt.orgE<gt>.
Copyright 2011, 2014 Russ Allbery <rra@cpan.org>
Copyright (c) 1997-2007 Graham Barr <gbarr@pobox.com>. All rights reserved. This program is free software
Copyright (c) 1999 Tuomas J. Lukka <lukka@iki.fi>. All rights reserved. This program is free software
Copyright (C) 2004, 2008 Matthijs van Duin. All rights reserved.
Copyright (C) 2014 cPanel Inc. All rights reserved. This program is free software
Copyright (c) 1997-2007 Graham Barr <gbarr@pobox.com>. All rights reserved. This program is free software
Copyright (c) 1999 Tuomas J. Lukka <lukka@iki.fi>. All rights reserved. This program is free software
Copyright (C) 2004, 2008 Matthijs van Duin. All rights reserved.

Copyright (C) 2014 cPanel Inc. All rights reserved. This program is free software
Copyright 2012, 2013, 2016 Russ Allbery <rra@cpan.org>
Copyright 2004, 2005, 2006, 2007 by Audrey Tang E<lt>cpan@audreyt.orgE<gt>.
copyright (c) 2002 - 2009 Jos Boumans E<lt>kane@cpan.orgE<gt>. All rights reserved.
Copyright (c) 2011-2014 Reini Urban. All rights reserved.
Copyright (c) 2014-2017 cPanel Inc. All rights reserved.
Copyright (c) 1995-2011 Paul Marquess. All rights reserved.
Copyright (c) 2014-2017 cPanel Inc. All rights reserved.
Copyright (c) 2001-2018, brian d foy, All Rights Reserved.
Copyright (c) 1997-8 Graham Barr <gbarr@pobox.com>. All rights reserved. This program is free software
Copyright 2001, Lincoln Stein <lstein@cshl.org>. This module is distributed under the same terms as Perl itself. Feel free to use, modify and redistribute it as long as you retain the correct attribution.
Copyright (c) 1997-8 Graham Barr <gbarr@pobox.com>. All rights reserved. This program is free software
Copyright 2001, Lincoln Stein <lstein@cshl.org>. This module is distributed under the same terms as Perl itself. Feel free to use, modify and redistribute it as long as you retain the correct attribution.
Copyright (c) 1994 Powerdog Industries. All rights reserved.
Copyright (c) 1994 Powerdog Industries. All rights reserved.
Copyright (c) 1996-8 Graham Barr <gbarr@pobox.com>. All rights reserved. This program is free software
Copyright (c) 1996-8 Graham Barr <gbarr@pobox.com>. All rights reserved. This program is free software
Copyright (c) 1997-2003 Graham Barr <gbarr@pobox.com>. All rights reserved. This program is free software
Copyright (c) 1997-2003 Graham Barr <gbarr@pobox.com>. All rights reserved. This program is free software
Copyright (c) 1998-2004 Tom Hughes E<lt>F<tom@compton.nu>E<gt>. All rights reserved. This program is free software
Copyright (c) 1998-2004 Tom Hughes E<lt>F<tom@compton.nu>E<gt>. All rights reserved. This program is free software
Copyright 2002-2014 Dan Kogai l<< <dankogai@cpan.org> >>.
Copyright 2002-2014 Dan Kogai l<< <dankogai@cpan.org> >>.
Copyright (c) 2002, 2003, 2004, 2012 Elizabeth Mattijsen. All rights reserved. This library is free software
Copyright (c) 1998+ Sean M. Burke. All rights reserved.
Copyright (c) 1998-2004 Sean M. Burke. All rights reserved.
Copyright (c) 2001-2002 Michael G. Schwern.
Copyright (c) 2002-2004 Sean M. Burke.
Copyright (c) 2000, 1996, 1991, 2012 O'Reilly Media, Inc. This document may be distributed under the same terms as Perl itself.
Copyright (c) 2000, 1996, 1991, 2012 O'Reilly Media, Inc. This document may be distributed under the same terms as Perl itself.
Copyright (c) 2000, 1996, 1991, 2012 O'Reilly Media, Inc. This document may be distributed under the same terms as Perl itself.
Copyright (c) 2002, 2003, 2004, 2005, 2006, 2007, 2008 Jarkko Hietaniemi. All rights reserved.
Copyright (C) 2011, 2012, 2013 Andrew Main (Zefram) <zefram@fysh.org>
Copyright (c) 1997-2010 Tom Christiansen, Nathan Torkington, and other authors as noted. All rights reserved.
Copyright 2006-2008 Curtis "Ovid" Poe, all rights reserved.
Copyright 2007-2011 Andy Armstrong.
copyright 2006-2008 Adam Kennedy.
Copyright 2007-2011 Andy Armstrong.
copyright 2006-2008 Adam Kennedy.
Copyright 2007-2011 Andy Armstrong.
Copyright 1995-1999, 2001-2004, 2010 Gisle Aas.
Copyright 1991 Bell Communications Research, Inc. (Bellcore)
Copyright 1995-1997,2002-2004 Gisle Aas.
Copyright 1995,1996 Neil Winton.
Copyright (c) 2001-2011 Ken Williams.
Copyright (c) 2010-2011 Matt Trout and David Golden. All rights reserved.
Copyright (c) 2001-2011 Ken Williams.
Copyright (c) 2010-2011 Matt Trout and David Golden. All rights reserved.
Copyright (c) 2011-2014 Reini Urban. All rights reserved. This program is free software
Copyright (C) 2014, 2015 Steve Hay. All rights reserved.

LICENCE TERMS (cont.)

Copyright 1995-1996 Neil Winton.
Copyright 1991-1992 RSA Data Security, Inc.
Copyright (C) 1991-2, RSA Data Security, Inc. Created 1991. All rights reserved.
Copyright 2013, 2014 The Board of Trustees of the Leland Stanford Junior University
Copyright 2013, 2014 The Board of Trustees of the Leland Stanford Junior University
Copyright 2013-2014 The Board of Trustees of the Leland Stanford Junior University
Copyright (c) 1995-2016 Paul Marquess. All rights reserved. This program is free software
Copyright 1997 - 2001 Damian Conway. All Rights Reserved.
copyright 2009 Adam Kennedy.
Copyright 1997 - 2001 Damian Conway. All Rights Reserved.
copyright 2009 Adam Kennedy.
Copyright (C) 2005 Aristotle Pagaltzis
Copyright (C) 2012-2013 Google, Inc. This module may be modified, used, copied, and redistributed at your own risk. Although allowed by the preceding license, please do not publicly redistribute modified versions of this code with the name "Text::Tabs" unless it passes the unmodified Text::Tabs test
Copyright (C) 2012-2013 Google, Inc. This module may be modified, used, copied, and redistributed at your own risk. Although allowed by the preceding license, please do not publicly redistribute modified versions of this code with the name "Text::Wrap" unless it passes the unmodified Text::Wrap test
Copyright (c) 2008 Graham Barr <gbarr@pobox.com>. All rights reserved. This program is free software
Copyright (c) 2002-2014 by the Perl 5 Porters
Copyright (c) 2015-2016 cPanel Inc
Copyright (c) 2017 Reini Urban
Copyright 2012 Steffen Mueller
Copyright 2009, 2010, 2011, 2012 Steffen Mueller
Copyright 2002-2014 by Ken Williams, David Golden and other contributors. All rights reserved.
Copyright (c) 2003-2005 Ken Williams. All rights reserved.
Copyright 2009, 2010, 2011, 2012, 2013 Steffen Mueller
Copyright (c) 2008,2009 Larry Wall and others
Copyright (c) 1997-1999 Tom Christiansen and Nathan Torkington. All rights reserved. When included as an integrated part of the Standard Distribution of Perl or of its documentation (printed or otherwise), this works is covered under Perl's Artistic License. For separate distributions of all or part
Copyright (c) 1997-1999 Tom Christiansen and Nathan Torkington. All rights reserved.
Copyright (c) 2017-2018, Reini Urban. All rights reserved.
Copyright (c) 2016, cPanel Inc. All rights reserved.
Copyright (c) 2012, Steve Peters. All rights reserved.
Copyright (c) 2002-2003, Rob Brown. All rights reserved.
Copyright (c) 2001, Colin McMillen. All rights reserved.
Copyright (C) 2013-2016 Steve Hay. All rights reserved. This module is free software
Copyright (C) 1995-2006 Graham Barr. All rights reserved.
Copyright (C) 2013-2016 Steve Hay. All rights reserved.
Copyright (C) 2013-2016 Steve Hay. All rights reserved. This module is free software
Copyright (C) 1995-2006 Graham Barr. All rights reserved.
Copyright (C) 2013-2016 Steve Hay. All rights reserved.
Copyright (C) 2013-2014, 2016 Steve Hay. All rights reserved. This module is free software
Copyright (C) 1998-2011 Graham Barr. All rights reserved.
Copyright (C) 2013-2014, 2016 Steve Hay. All rights reserved.
Copyright (C) 2013-2014, 2016 Steve Hay. All rights reserved. This module is free software
Copyright (C) 1998-2011 Graham Barr. All rights reserved.
Copyright (C) 2013-2014, 2016 Steve Hay. All rights reserved.
Copyright (C) 1995-1997 Graham Barr. All rights reserved.
Copyright (C) 1995-1997 Graham Barr. All rights reserved.
Copyright (C) 1995-2004 Graham Barr. All rights reserved.
Copyright (C) 1995-2004 Graham Barr. All rights reserved.
Copyright (C) 2013-2014 Steve Hay. All rights reserved. This module is free software
Copyright (C) 1995-1998 Graham Barr. All rights reserved.
Copyright (C) 2013-2014 Steve Hay. All rights reserved.
Copyright (C) 2013-2014 Steve Hay. All rights reserved. This module is free software

Copyright (C) 1995-1998 Graham Barr. All rights reserved.
Copyright (C) 2013-2014 Steve Hay. All rights reserved.
Copyright (C) 2014 Steve Hay. All rights reserved. This module is free software
Copyright (C) 2014 Steve Hay. All rights reserved.
Copyright (C) 2014 Steve Hay. All rights reserved. This module is free software
Copyright (C) 2014 Steve Hay. All rights reserved.
Copyright (C) 2013-2017 Steve Hay. All rights reserved. This module is free software
Copyright (C) 2013-2017 Steve Hay. All rights reserved.
Copyright (C) 2013-2017 Steve Hay. All rights reserved. This module is free software
Copyright (C) 2013-2017 Steve Hay. All rights reserved.
Copyright (C) 1997-1998 Graham Barr. All rights reserved. This document is free
Copyright (C) 1997-1998 Graham Barr. All rights reserved.
Copyright (C) 1997-1998 Graham Barr. All rights reserved.
Copyright (c) 2002,3,4 Sean M. Burke. All rights reserved.
Copyright 2001, 2004, 2008, 2014, 2018 by Russ Allbery <rra@cpan.org>
Copyright 2001, 2004, 2008, 2014, 2018 by Russ Allbery <rra@cpan.org>
Copyright (c) 2002 Sean M. Burke.
Copyright (c) 1997-2013 Tom Christiansen, Nathan Torkington, and other authors as noted. All rights reserved.
copyright (c) 2018 by Christian Hansen.
Copyright 1998, 1999, 2000, 2001, 2012 by Mark Jason Dominus
Copyright (c) 1995 Graham Barr & Nick Ing-Simmons. All rights reserved. This program is free software
Copyright (c) 1995 Graham Barr & Nick Ing-Simmons. All rights reserved. This program is free software
Copyright (C) 1994-2013 Larry Wall
Copyright (c) 2004 by the Perl 5 Porters. All rights reserved.
copyright (c) 1994 by the Regents of the University of California. All rights reserved. The license on this code is compatible with the licensing of the rest of the distribution - please see the source code in F<Cwd.xs> for the details.
Copyright (c) 2004 by the Perl 5 Porters. All rights reserved.
copyright (c) 1994 by the Regents of the University of California. All rights reserved. The license on this code is compatible with the licensing of the rest of the distribution - please see the source code in F<Cwd.xs> for the details.
copyright (c) 2010 by David Golden, Ricardo Signes, Adam Kennedy and Contributors.
Copyright 2002-2008 by chromatic E<lt>chromatic@wgz.orgE<gt> and Michael G Schwern E<lt>schwern@pobox.comE<gt>.
Copyright 2001-2008 by Michael G Schwern E<lt>schwern@pobox.comE<gt>.
Copyright 2001 by Michael G Schwern E<lt>schwern@pobox.comE<gt>.
Copyright (c) 1999,2001 by ZeeGee Software Inc. All rights reserved.
Copyright Micheal G Schwern 2001. Used and distributed with permission.
Copyright (c) 2007-2011, Andy Armstrong C<<< <andy@hexten.net> >>. All rights reserved.
Copyright 1998-2003 Gisle Aas.
Copyright 1995-1996 Neil Winton.
Copyright 1991-1992 RSA Data Security, Inc.
Copyright (C) 1991-2, RSA Data Security, Inc. Created 1991. All rights reserved.
Copyright 1998-2003 Gisle Aas.
Copyright (C) 1991-2, RSA Data Security, Inc. Created 1991. All rights reserved.
Copyright (c) 2016 Unicode, Inc.
Copyright (C) 1997, Graham Barr <gbarr@pobox.com>.
Copyright (C) 2007-2013, Marcus Holland-Moritz.
Copyright (c) 1997, Graham Barr.
Copyright (C) 1997, Graham Barr <gbarr@pobox.com>.
Copyright (C) 2007-2013, Marcus Holland-Moritz.
Copyright (c) 1997, Graham Barr.
Copyright (C) 2018, The perl5 porters
Copyright (C) 2001, Paul Marquess.
Copyright (C) 1999, Kenneth Albanowski.
Copyright (C) 2004-2013, Marcus Holland-Moritz.
Copyright (c) 2004-2013, Marcus Holland-Moritz.
Copyright (C) 2002-2009 Richard Clamp. All Rights Reserved.

LICENCE TERMS (cont.)

Copyright (c) 2002-2010 Jarkko Hietaniemi. All rights reserved.
Copyright (c) 2001-2004, Larry Wall
Copyright (c) 2016,2017 cPanel Inc
Copyright (c) 2017, Reini Urban
Copyright (c) 2017, cPanel Inc
Copyright (c) 2016, 2017 cPanel Inc
Copyright 1999-2004, Sean M. Burke <sburke@cpan.org>, all rights reserved. This program is free software
Copyright (C) 1999, Kenneth Albanowski.
Copyright (C) 1999, Kenneth Albanowski.
Copyright (c) 2004-2013, Marcus Holland-Moritz.
Copyright (c) 2004-2013, Marcus Holland-Moritz.
Copyright (c) 2006-2013, Marcus Holland-Moritz.
Copyright (c) 2006-2013, Marcus Holland-Moritz.
Copyright (c) 2017 by Ken Williams.
Copyright (C) 1989 Free Software Foundation, Inc.
Copyright (c) 2017 by Ken Williams.
Copyright (C) 1989 Free Software Foundation, Inc.
Copyright 1992-2019 Free Software Foundation, Inc.; Copyright 1992-2019 Free Software Foundation, Inc.
Copyright 2013-2013 Tilera Corporation(jiwang@tilera.com). All rights reserved.
Copyright (c) 2008 Guido U. Draheim <guidod@gmx.de>
Copyright © 2004 Scott James Remnant <scott@netsplit.com>.
Copyright (c) The PHP Group |
Copyright (c) The PHP Group |
(c) 2007,2008 Andrei Nigmatulin
(c) 2009 Jerome Loyet
(c) 2007,2008 Andrei Nigmatulin
(c) 2004-2007 Andrei Nigmatulin
(c) 2007,2008 Andrei Nigmatulin, Jerome Loyet
(c) 2011 Jerome Loyet The PHP License, version 3.01
Copyright (c) 2007-2009, Andrei Nigmatulin All rights reserved.
Copyright (c) The PHP Group
(c) Pierrick Charron <pierrick@adoy.net>
Copyright (C) 1984, 1989-1990, 2000-2013 Free Software Foundation, Inc.
Copyright 2009,2010 Ryan Dahl <ry@tinyclouds.org>
Copyright 2009,2010 Ryan Dahl <ry@tinyclouds.org>;(c) tokens[(unsigned char)c]
Copyright (c) 1996-2015, The PostgreSQL Global Development Group
Copyright (c) 1997-2008, Vincent Blavet <vincent@phpconcept.net> All rights reserved.
Copyright (c) The PHP Group
Copyright (c) 1992, 1993 The Regents of the University of California. All rights reserved.
Copyright (c) The PHP Group
Copyright (c) Zend Technologies Ltd. (<http://www.zend.com>) |
Copyright (C) 1984, 1989-1990, 2000-2013 Free Software Foundation, Inc.
Copyright (c) Zend Technologies Ltd.
Copyright (c) Zend Technologies Ltd. (<http://www.zend.com>)
Copyright (c) Zend Technologies Ltd. (<http://www.zend.com>)
Copyright (c) Zend Technologies Ltd. (<http://www.zend.com>)
Copyright (c) Zend Technologies Ltd. (<http://www.zend.com>)
Copyright (c) 1991, 2000, 2001 by Lucent Technologies.
Copyright (c) 1999-2006 Zend Technologies Ltd. All rights reserved.
Copyright (C) 1996, 1997, 1998, 1999, 2000, 2001, 2003, 2004, 2005, 2006, 2007, 2008 Free Software Foundation, Inc. Originally by Gordon Matzigkeit <gord@gnu.ai.mit.edu>, 1996
Copyright (c) 2008 Caolan McNamara <caolan@skynet.ie>
Copyright 1996, 1997, 1998, 1999, 2000, 2001, 2003, 2004, 2005, 2006, 2007, 2008 Free Software Foundation, Inc. Originally by Gordon Matzigkeit <gord@gnu.ai.mit.edu>, 1996
Copyright (c) 2013 Gabriele Svelto <gabriele.svelto@gmail.com>
Copyright (c) 1994-2008 Ralf S. Engelschall <rse@engelschall.com>
Copyright (c) 2008 Benjamin Kosnik <bkoz@redhat.com>

Copyright (C) 1992-1996, 1998-2012 Free Software Foundation, Inc.
Copyright (c) 1989, 1993 The Regents of the University of California. All rights reserved.
Copyright 1994 The Downhill Project *
Copyright (c) Christos Zoulas 2003. All Rights Reserved.
Copyright (c) Christos Zoulas 2017. All Rights Reserved.
Copyright (c) Ian F. Darwin 1986-1995. Software written by Ian F. Darwin and others
Copyright (c) 2008 Christos Zoulas All rights reserved.
Copyright (c) 2016 Christos Zoulas All rights reserved.
Copyright (c) 2018 Christos Zoulas All rights reserved.
Copyright (c) Christos Zoulas 2008. All Rights Reserved.
Copyright (c) 2008, 2016 Christos Zoulas All rights reserved.
Copyright (c) 1990, 1993 The Regents of the University of California. All rights reserved.
Copyright 1996 by the University of Washington
Copyright (c) 2006-2009 Alexander Chemeris
Copyright (c) 1989, 1993, 1994 The Regents of the University of California. All rights reserved.
Copyright (c) 2006 Alexander Chemeris
Copyright (c) 1999 - 2021 The PHP Group. All rights reserved.
Copyright (c) 1999-2011, Andi Gutmans, Sascha Schumann, Zeev Suraski
Copyright (c) 1999, 2000 Sascha Schumann. All rights reserved.
Copyright (c) 1999-2006, Andi Gutmans, Sascha Schumann, Zeev Suraski. All rights reserved.
"Copyright (c) The PHP Group mysqli_stmt_warning_count(s) mysqli_stmt_warning_count((s)) define mysqli_stmt_server_status(s) mysqli_stmt_server_status((s)) define mysqli_stmt_get_connection(s) (s)->data->conn"
Copyright (C) 1991, 1999 Free Software Foundation, Inc.
Copyright (C) 1991, 1992, 1993, 1994, 1997 Free Software Foundation, Inc.
Copyright (c) 1991-1999 Unicode, Inc. All Rights reserved.
Copyright: (c) 1994-2002, 2005 by Apple Computer, Inc., all rights reserved.
Copyright (c) 1998 - 1999 Unicode, Inc. All Rights reserved.
Copyright (c) 1991-1999 Unicode, Inc. All Rights reserved.
Copyright (c) The PHP Group
Copyright (C) 2000 by Martin Pool <mbp@humblebug.org.au>
Copyright (c) 1994 David Burren All rights reserved.
Copyright (c) The PHP Group
Copyright (c) 1998-2008, Brian Gladman, Worcester, UK. All rights reserved.
Copyright (c) 1990-2008 Info-ZIP
copyright 1997-2005 The PHP Group license <http://www.gnu.org/copyleft/lesser>.
Copyright (c) 2005-2009, Laurent Laville <pear@laurent-laville.org>
copyright 2005-2009 Klaus Guenther, Laurent Laville license
copyright 2005-2009 Laurent Laville license
copyright 2005-2009 Klaus Guenther, Laurent Laville license
copyright 2005-2009 Klaus Guenther, Laurent Laville license
copyright 2007-2009 Laurent Laville license
copyright 2003-2009 Klaus Guenther, Laurent Laville license
copyright 2007-2009 Laurent Laville license
copyright 2005-2009 Klaus Guenther, Laurent Laville license
copyright 2006-2009 Laurent Laville license
copyright 2003-2009 Klaus Guenther, Laurent Laville license
Copyright (c) 2003-2009, Klaus Guenther <klaus@capitalfocus.org> Laurent Laville <pear@laurent-laville.org>
Copyright (c) 2002-2004, Richard Heyes | All rights reserved. |
Copyright (c) 2002-2003, Richard Heyes | All rights reserved. |
Copyright (c) 2003 Sérgio Gonçalves Carvalho |
Copyright 1999 Greg Roelofs and Thomas Boutell
Copyright (c) 1997-1998 Sun Microsystems, Inc.
(c) 2000 Johan Van den Brande <johan@vandenbrande.com>
Copyright (C) Johan Van den Brande (johan@vandenbrande.com)
Copyright 1999, Philip Warner.
Copyright 2004-2016, Blizzard

LICENCE TERMS (cont.)

Copyright (c) 2003 Samsung Electronics Co., Ltd
Copyright (C) 1989 by Jef Poskanzer
Copyright 2008-2009, The PHP Group
Copyright (C) 1991-1996, Thomas G. Lane.

Copyright (c) 1998 Hewlett-Packard Company
Copyright 2000 Doug Becker, <mailto:thebeckers@home.com>
Copyright (c) 1997-2012 University of Cambridge
Copyright 2000 Example.com. All rights reserved. `<xsd:documentation> xsd:annotation>`
Copyright (c) 2016-2020 University of Cambridge
Copyright 1998-2007 The OpenLDAP Foundation. All rights reserved.
Copyright (c) 1998-2002 HappySize, Inc. All rights reserved.
Copyright (c) 1998-2002 HappySize, Inc. All rights reserved.
Copyright (c) 1998,1999,2000,2001 HappySize, Inc. All rights reserved.
Copyright (C) 1991, 1999 Free Software Foundation, Inc. 59 Temple Place, Suite 330, Boston, MA 02111-1307 USA
Everyone is permitted to copy and distribute verbatim copies of this license document, but changing it is not allowed.
Copyright Abandoned 1996 TCX DataKonsult AB & Monty Program KB & Detron HB
Copyright 1993-1995, Scott E. Lee, all rights reserved.
Copyright (c) 2015-2019 Derick Rethans
Copyright (c) 2015-2019 Derick Rethans
Copyright 2001 Epinions, Inc.
Copyright 2000 Epinions, Inc.
Copyright 2001 Dan Libby, Epinions, Inc.
Copyright 2001 Epinions, Inc.
Copyright (c) 2011 Maarten Bosmans mkbosmans@gmail.com
Copyright (c) 2011 Maarten Bosmans mkbosmans@gmail.com
copyright(c) You must retain, in the Source form of any Derivative Works
Copyright(c) You must retain, in the Source form of any Derivative Works
Copyright © 2012-2015 Dan Nicholson dbn.lists@gmail.com
Copyright either version 2 of the License, or dnl (at your option)
Copyright (c) 2002-2018, Lite Speed Technologies Inc. All rights reserved.
Copyright (c) 2002-2018, Lite Speed Technologies Inc. All rights reserved.
Copyright (c) 2002-2018, Lite Speed Technologies Inc. All rights reserved.
Copyright (c) 2002-2015, Lite Speed Technologies Inc. All rights reserved.
Copyright (c) 2002-2015, Lite Speed Technologies Inc. All rights reserved.
Copyright (c) 2002-2015, Lite Speed Technologies Inc. All rights reserved.
Copyright (c) 2007-2009, Andrei Nigmatulin PD 1 LP This source file is subject to version 3.01 of the PHP license, that is bundled with this package in the file LICENSE, and is available through the world-wide-web at the following url: PD 0
Copyright (c) Zend Technologies
Copyright (c) 1994, The Regents of the University of California
Copyright (c) 1994, The Regents of the University of California
Copyright (c) The PHP Group |
copyright 1997-2010 The Authors license
Copyright (c) 1995-1998 The Apache Group. All rights reserved.
Copyright (c) 1995-1998 The Apache Group. All rights reserved.
Copyright (c) 1998 Todd C. Miller Todd.Miller@courtesan.com> All rights reserved.
Copyright (c) 1998 Todd C. Miller Todd.Miller@courtesan.com> All rights reserved.
Copyright (c) 2002, 2006 Todd C. Miller Todd.Miller@courtesan.com
Copyright (c) 2002, 2006 Todd C. Miller Todd.Miller@courtesan.com
Copyright (c) 1990, 1993 The Regents of the University of California. All rights reserved.
Copyright (c) 1998 Softweyr LLC. All rights reserved.
Copyright (c) 1988, 1993 The Regents of the University of California. All rights reserved.
Copyright (c) 1990, 1993 The Regents of the University of California. All rights reserved.
Copyright (c) 1998 Softweyr LLC. All rights reserved.
Copyright (c) 1988, 1993 The Regents of the University of California. All rights reserved.
Copyright (c) Zend Technologies Ltd. (<http://www.zend.com>) |

Copyright (c) 2009-2012 by the contributors listed at <http://llvm.org/svn/llvm-project/libcxx/trunk/CREDITS.TXT>
Copyright (c) 2009-2012 by the contributors listed at <http://llvm.org/svn/llvm-project/libcxx/trunk/CREDITS.TXT>
Copyright (c) 2009-2012 by the contributors listed at <http://llvm.org/svn/llvm-project/libcxx/trunk/CREDITS.TXT>
Copyright (c) 2009-2012 by the contributors listed at <http://llvm.org/svn/llvm-project/libcxx/trunk/CREDITS.TXT>
Copyright (c) Zend Technologies
Copyright (c) Zend Technologies
Copyright (C) 2008 Free Software Foundation, Inc. This is free software
Copyright (c) 2008 Daniel Richard G. skunk@iskunk.org
Copyright (c) 2008 Daniel Richard G. skunk@iskunk.org
Copyright (C) 1996, 1997, 1998, 1999, 2000, 2001, 2002, 2003, 2004, 2005, 2006, 2007, 2008 Free Software Foundation, Inc.
Copyright (c) 1994-2008 Ralf S. Engelschall rse@engelschall.com
Copyright (c) 1998-2008 Ralf S. Engelschall rse@engelschall.com
Copyright (c) 1997-2008 Ralf S. Engelschall rse@engelschall.com
Copyright (c) 1996-2008 Ralf S. Engelschall rse@engelschall.com
Copyright (c) 2003-2008 Ralf S. Engelschall rse@engelschall.com
Copyright (c) 1998-2008 Ralf S. Engelschall rse@engelschall.com
Copyright (c) 2012 Zack Weinberg zackw@panix.com
Copyright (c) 2013 Roy Stogner roystgnr@ices.utexas.edu
Copyright (c) 2014, 2015 Google Inc.
Copyright (c) 2015 Paul Norman penorman@mac.com
Copyright (c) 2015 Moritz Klammler moritz@klammler.eu
Copyright (c) 2016, 2018 Krzesimir Nowak qdlacz@gmail.com
Copyright (c) 2019 Enji Cooper yaneurabeya@gmail.com
Copyright (c) 2012 Zack Weinberg zackw@panix.com
Copyright (c) 2013 Roy Stogner roystgnr@ices.utexas.edu
Copyright (c) 2014, 2015 Google Inc.
Copyright (c) 2015 Paul Norman penorman@mac.com
Copyright (c) 2015 Moritz Klammler moritz@klammler.eu
Copyright (c) 2016, 2018 Krzesimir Nowak qdlacz@gmail.com
Copyright (c) 2019 Enji Cooper yaneurabeya@gmail.com
Copyright (C) 2012 Free Software Foundation, Inc. This configure script is free software
Copyright (C) 1996, 1997, 1998, 1999, 2000, 2001, 2002, 2003, 2004, 2005, 2006, 2007, 2008 Free Software Foundation, Inc.
Copyright (C) 2012 Free Software Foundation, Inc. This config.status script is free software
copyright maintained 1995-present by Christos Zoulas and others.
copyright 2014 Nicira, Inc. and have been modified to work with PHP.
copyright(C) 1985-1995 Ian F. Darwin
copyright(C) 1994-2009 Christos Zoulas christos@zoulas.com> License: BSD This software is not subject to any export provision of the United States Department of Commerce, and may be exported to any country or planet.
Copyright (c) 2005-2010, Matthew Wilson and Synesis Software
Copyright (C) 2018 Alois Schloegl alouis.schloegl@gmail.com
Copyright (C) 2003 by Andrew Tridgell. You may do whatever you want with this file.
Copyright (C) 2001 by Martin Pool. You may do whatever you want with this file.
Copyright 1995-2018 by GARMIN Corporation
Copyright (c) 1996 Ignatios Souvatzis. All rights reserved.
Copyright (c) 1997-2019 University of Cambridge All rights reserved.
Copyright(c) 2010-2019 Zoltan Herczeg All rights reserved.
Copyright(c) 2009-2019 Zoltan Herczeg All rights reserved.
Copyright (c) 1994 David Burren All rights reserved.
Copyright (c) 1998-2011 Solar Designer and it is hereby released to the general public under the following terms:
Copyright (C) 1997 - 2002, Makoto Matsumoto and Takuji Nishimura,
Copyright (C) 2000 - 2003, Richard J. Wagner All rights reserved.
Copyright (C) 2000 by Martin Pool mhb@humblebug.org.au
Copyright (c) 1983, 1993 The Regents of the University of California. All rights reserved.
Copyright 2000 Epinions, Inc.
copyright notice, this list of conditions and the following disclaimer in the documentation and/or other materials

LICENCE TERMS (cont.)

provided with the distribution. 3. The name of the author may not be used to endorse or promote products derived from this software without specific prior written permission.

copyright 1994, 1995, 1996, 1997, 1998, 1999, 2000, 2001, 2002, 2003, 2004 by Cold Spring Harbor Laboratory. Funded under Grant P41-RR02188 by the National Institutes of Health.

copyright 1996, 1997, 1998, 1999, 2000, 2001, 2002, 2003, 2004 by Boutell.Com, Inc.

copyright 1999, 2000, 2001, 2002, 2003, 2004 Philip Warner.

copyright 1999, 2000, 2001, 2002, 2003, 2004 Greg Roelofs.

copyright 1999, 2000, 2001, 2002, 2003, 2004 John Ellson (ellson@graphviz.org).

copyright 2001, 2002, 2003, 2004 John Ellson (ellson@graphviz.org).

copyright 2000, 2001, 2002, 2003, 2004, 2005, 2006, 2007 Pierre-Alain Joye (pierre@libgd.org).

copyright (C) 1994, 1995, 1996, 1997, 1998, 1999, 2000, 2001, 2002, 2003, 2004 Thomas G. Lane. This software is based in part on the work of the Independent JPEG Group. See the file README-JPEG.TXT for more information.

copyright 1989 by Jef Poskanzer and David Rowley, with modifications for thread safety by Thomas Boutell.

copyright 1990, 1991, 1993 by David Koblas, with modifications for thread safety by Thomas Boutell.

copyright 2000, 2001, 2002, 2003, 2004 Maurice Szmurlo and Johan Van den Brande.

copyright 2004 Jaakko Hyvätti jaakko.hyvatti@iki.fi

Copyright (c) 2003-2007 Tim Kientzle All rights reserved.

Copyright (C) 1999, 2003, 2004, 2005 Dieter Baron and Thomas Klausner

Copyright 1999-2003 The OpenLDAP Foundation, Redwood City, California, USA. All Rights Reserved.

Copyright (c) 1997-2019 University of Cambridge All rights reserved.

Copyright(c) 2010-2019 Zoltan Herczeg All rights reserved.

Copyright(c) 2009-2019 Zoltan Herczeg All rights reserved.

Copyright (c) 1994 David Burren All rights reserved.

Copyright (c) 1998-2011 Solar Designer and it is hereby released to the general public under the following terms:

Copyright (C) 1997 - 2002, Makoto Matsumoto and Takuji Nishimura,

Copyright (C) 2000 - 2003, Richard J. Wagner All rights reserved.

Copyright (C) 2000 by Martin Pool <mbp@humblebug.org.au>

Copyright (c) 1983, 1993 The Regents of the University of California. All rights reserved.

Copyright 2000 Epinions, Inc.

Copyright (c) 2002, 2006 Todd C. Miller <Todd.Miller@courtesan.com>

Copyright (c) 1995-1998 The Apache Group. All rights reserved.

Copyright (c) 1998 Todd C. Miller <Todd.Miller@courtesan.com> All rights reserved.

copyright notice, this list of conditions and the following disclaimer in the documentation and/or other materials provided with the distribution. 3. The name of the author may not be used to endorse or promote products derived from this software without specific prior written permission.

copyright 1994, 1995, 1996, 1997, 1998, 1999, 2000, 2001, 2002, 2003, 2004 by Cold Spring Harbor Laboratory. Funded under Grant P41-RR02188 by the National Institutes of Health.

copyright 1996, 1997, 1998, 1999, 2000, 2001, 2002, 2003, 2004 by Boutell.Com, Inc.

copyright 1999, 2000, 2001, 2002, 2003, 2004 Philip Warner.

copyright 1999, 2000, 2001, 2002, 2003, 2004 Greg Roelofs.

copyright 1999, 2000, 2001, 2002, 2003, 2004 John Ellson (ellson@graphviz.org).

copyright 2001, 2002, 2003, 2004 John Ellson (ellson@graphviz.org).

copyright 2000, 2001, 2002, 2003, 2004, 2005, 2006, 2007 Pierre-Alain Joye (pierre@libgd.org).

copyright (C) 1994, 1995, 1996, 1997, 1998, 1999, 2000, 2001, 2002, 2003, 2004 Thomas G. Lane. This software is based in part on the work of the Independent JPEG Group. See the file README-JPEG.TXT for more information.

copyright 1989 by Jef Poskanzer and David Rowley, with modifications for thread safety by Thomas Boutell.

copyright 1990, 1991, 1993 by David Koblas, with modifications for thread safety by Thomas Boutell.

copyright 2000, 2001, 2002, 2003, 2004 Maurice Szmurlo and Johan Van den Brande.

copyright 2004 Jaakko Hyvätti jaakko.hyvatti@iki.fi)

Copyright (c) 2003-2007 Tim Kientzle All rights reserved.

Copyright (C) 1999, 2003, 2004, 2005 Dieter Baron and Thomas Klausner

Copyright 1999-2003 The OpenLDAP Foundation, Redwood City, California, USA. All Rights Reserved. Permission to copy and distribute verbatim copies of this document is granted.

Copyright (c) 1997-2019 University of Cambridge All rights reserved.

Copyright(c) 2010-2019 Zoltan Herczeg All rights reserved.

Copyright(c) 2009-2019 Zoltan Herczeg All rights reserved.

Copyright (c) 1994 David Burren All rights reserved.

Copyright (c) 1998-2011 Solar Designer and it is hereby released to the general public under the following terms:

Copyright (C) 1997 - 2002, Makoto Matsumoto and Takuji Nishimura,

Copyright (C) 2000 - 2003, Richard J. Wagner All rights reserved.

Copyright (C) 2000 by Martin Pool <mbp@humblebug.org.au>

Copyright (c) 1983, 1993 The Regents of the University of California. All rights reserved.

Copyright 2000 Epinions, Inc.

copyright 1994, 1995, 1996, 1997, 1998, 1999, 2000, 2001, 2002, 2003, 2004 by Cold Spring Harbor Laboratory. Funded under Grant P41-RR02188 by the National Institutes of Health.

copyright 1996, 1997, 1998, 1999, 2000, 2001, 2002, 2003, 2004 by Boutell.Com, Inc.

copyright 1999, 2000, 2001, 2002, 2003, 2004 Philip Warner.

copyright 1999, 2000, 2001, 2002, 2003, 2004 Greg Roelofs.

copyright 1999, 2000, 2001, 2002, 2003, 2004 John Ellson (ellson@graphviz.org).

copyright 2001, 2002, 2003, 2004 John Ellson (ellson@graphviz.org).

copyright 2000, 2001, 2002, 2003, 2004, 2005, 2006, 2007 Pierre-Alain Joye (pierre@libgd.org).

copyright (C) 1994, 1995, 1996, 1997, 1998, 1999, 2000, 2001, 2002, 2003, 2004 Thomas G. Lane. This software is based in part on the work of the Independent JPEG Group. See the file README-JPEG.TXT for more information.

copyright 1989 by Jef Poskanzer and David Rowley, with modifications for thread safety by Thomas Boutell.

copyright 1990, 1991, 1993 by David Koblas, with modifications for thread safety by Thomas Boutell.

copyright 2000, 2001, 2002, 2003, 2004 Maurice Szmurlo and Johan Van den Brande.

copyright 2004 Jaakko Hyvätti jaakko.hyvatti@iki.fi)

Copyright (c) 2003-2007 Tim Kientzle All rights reserved.

Copyright (C) 1999, 2003, 2004, 2005 Dieter Baron and Thomas Klausner

Copyright 1999-2003 The OpenLDAP Foundation, Redwood City, California, USA. All Rights Reserved.

Copyright (C) 2000 Philip A. Nelson

Copyright (C) 2000 Philip A. Nelson

Copyright (C) 1995-2005 Mark Adler

Copyright (C) 1995-2005 Jean-loup Gailly and Mark Adler

Copyright © Michael Rushton 2009-10 <http://squilloople.com/>

Copyright © Michael Rushton 2009-10 <http://squilloople.com/>

Copyright (c) 2000-2011 Solar Designer and it is hereby released to the general public under the following terms:

Copyright (c) 2015-2018, Wojciech Mula All rights reserved.

Copyright (c) 2005-2007, Nick Galbreath

Copyright (c) 2013-2017, Alfred Klomp

Copyright (c) 2015-2017, Wojciech Mula

Copyright (c) 2016-2017, Matthieu Darbois All rights reserved.

Copyright (c) 2015-2018, Wojciech Mula All rights reserved.

Copyright (c) 2005-2007, Nick Galbreath

Copyright (c) 2013-2017, Alfred Klomp

Copyright (c) 2015-2017, Wojciech Mula

Copyright (c) 2016-2017, Matthieu Darbois All rights reserved.

Copyright (c) 2015-2018, Wojciech Mula All rights reserved.

Copyright (c) 2005-2007, Nick Galbreath

Copyright (c) 2013-2017, Alfred Klomp

Copyright (c) 2015-2017, Wojciech Mula

Copyright (c) 2016-2017, Matthieu Darbois All rights reserved.

Copyright 1997 by the University of Washington

Copyright (C) 1991-2, RSA Data Security, Inc. Created 1991. All rights reserved.

copyright 2005-2009 Laurent Laville license

copyright 2005-2009 Laurent Laville license

copyright 2005-2009 Klaus Guenther, Laurent Laville license

copyright 2003-2009 Klaus Guenther, Laurent Laville license

"copyright (c) 2004 by Sérgio Carvalho package Structures_Graph"

"copyright (c) 2004 by Sérgio Carvalho see Structures_Graph_Manipulator_AcyclicTest package Structures_Graph"

Copyright (c) 2003-2009 Tim Kientzle All rights reserved.

Copyright (c) 2003-2009 Tim Kientzle All rights reserved.

Copyright (c) 2003-2009 Tim Kientzle."

copyright 1994, 1995, Quest Protein Database Center, Cold Spring Harbor Labs. */

LICENCE TERMS (cont.)

Copyright(c) M.Boerger, Edited by M.Boerger."
Copyright(c) M.Boerger"
Copyright (c) 2016-2020 University of Cambridge
Copyright (c) 2016-2020 University of Cambridge
Copyright (c) 2015-2020 University of Cambridge
Copyright (c) 2015-2020 University of Cambridge
Copyright (c) 2016-2019 University of Cambridge
Copyright (c) 2016-2019 University of Cambridge
Copyright (c) 2016-2018 University of Cambridge
Copyright (c) 2016-2018 University of Cambridge
Copyright (c) 2016 University of Cambridge
Copyright (c) 2016 University of Cambridge
Copyright (c) 2018 University of Cambridge
Copyright (c) 2018 University of Cambridge
Copyright 2001 Computing Research Labs, New Mexico State University
copyright (c) 1999,2000,2001 by the PHP3 internationalization team. All rights reserved.
Copyright (c) 1998,1999,2000,2001 HappySize, Inc. All rights reserved.
Copyright (c) 1998,1999,2000,2001 HappySize, Inc. All rights reserved.
Copyright (c) 2018 MongoDB, Inc.
copyright (c) 1998-2017 Zend Technologies Ltd.
Copyright (c) 2017-2019 MongoDB, Inc.
Copyright (C) 1994 X Consortium
Copyright (C) 1996-2015 Free Software Foundation, Inc. This is free software
Copyright (C) 1999-2018 Free Software Foundation, Inc. Written by Tom Tromey <tromey@cygnus.com>.
Copyright 1992-2019 Free Software Foundation, Inc.
Copyright (C) 1999-2018 Free Software Foundation, Inc.
Copyright (C) 2004-2005, 2007, 2009, 2011-2015 Free Software Foundation, Inc. Written by Scott James Remnant, 2004.
Copyright (C) 2004, 2011-2015 Free Software Foundation, Inc. Written by Scott James Remnant, 2004
Copyright (C) 1996-2001, 2003-2015 Free Software Foundation, Inc. Written by Gordon Matzigkeit, 1996
Copyright (C) 2004-2005, 2007-2008, 2011-2015 Free Software Foundation, Inc. Written by Gary V. Vaughan, 2004
Copyright (C) 2004-2005, 2007-2009, 2011-2015 Free Software Foundation, Inc. Written by Gary V. Vaughan, 2004
Copyright (C) 1996-2018 Free Software Foundation, Inc. Originally written by Fran,cois Pinard <pinard@iro.umontreal.ca>, 1996.
Copyright (C) 1995-1997, 2000-2007, 2009-2010 by Ulrich Drepper <drepper@gnu.ai.mit.edu>
Copyright 1996-2016 Free Software Foundation, Inc. Taken from GNU libtool, 2001 Originally by Gordon Matzigkeit <gord@gnu.ai.mit.edu>, 1996
Copyright © 2008 Free Software Foundation, Inc. This file is distributed under the same license as the popt package.
Göran Uddeborg <goeran@uddeborg.se>, 2008.
Copyright (c) 1998 Red Hat Software
Copyright (C) 2008 popt. This file is distributed under the same license as the popt package. Martin Hansen <mah@k64.dk>, 2001. Joe Hansen <joedalton2@yahoo.dk>, 2008.
Copyright (c) 1998 by Addison Wesley Longman, Inc., and included in the popt documentation with the permission of the Publisher and the appreciation of the Authors. PP Thanks to Robert Lynch for his extensive work on this man page. SH "SEE ALSO" BR getopt (3) sp IR "Linux Application Developmen
Copyright (C) 1999 Free Software Foundation, Inc.
Copyright (C) 1999 Free Software Foundation, Inc. Yuri Syrota <rasta@renome.rovno.ua>, 1999.
Copyright (C) 1996-2018 Free Software Foundation, Inc.
(C) 1998-2002 Red Hat, Inc. – Licensing details are in the COPYING file accompanying popt source distributions, available from ftp://ftp.rpm.org/pub/rpm/dist. */
Copyright © 2008 Free Software Foundation, Inc
Copyright (C) 1992-1996, 1998-2012 Free Software Foundation, Inc.
Copyright 1986, 1994 Radical Eye Software
Copyright (C) 2005 Free Software Foundation, Inc. Wei-Lun Chao <chaoweilun@pcmail.com.tw>, 2005
Copyright (C) 1999 US Interactive, Inc.
(C) 1998-2000 Red Hat, Inc.
Copyright (C) 2008 Free Software Foundation, Inc. This file is distributed under the same license as the popt

package. Milan Kerslager <kerslage@linux.cz>, 2001. Petr Pisar <petr.pisar@atlas.cz>, 2008.
Copyright (C) 2008 Free Software Foundation, Inc. Seksan Poltree <seksan.poltree@gmail.com>, 2008.
Copyright (C) 2007 Free Software Foundation, Inc. Leandro Lucarella <luca@linuxmendoza.org.ar>, 2007
(C) 1998-2002 Red Hat, Inc. -
Copyright (C) 1994-2018 Free Software Foundation, Inc.
Copyright (C) 1994, 1995, 1996, 1997, 1998, 1999, 2000, 2001, 2002, 2003, 2004, 2005, 2006, 2007, 2008, 2009
Free Software Foundation, Inc. This Makefile.in is free software; the Free Software Foundation gives unlimited permission to copy and/or distribute it, with or without modification
Copyright (C) 2008 Felipe Castro This file is put in the public domain. Felipe Castro <fefcas@gmail.com>, 2008
Copyright (C) 2007 Free Software Foundation, Inc. Gabor Kelemen <kelemeng@gnome.hu>, 2007.
Copyright (C) 2003 Free Software Foundation, Inc. Yukihiko Nakai <yinakai@redhat.com>, 2003
Copyright (C) 2005, 2007 Free Software Foundation, Inc. Wei-Lun Chao <chaoweilun@pcmail.com.tw>, 2005. LI Daobing <lidaobing@gmail.com>, 2007, 2008.
Copyright (C) 2003 Free Software Foundation, Inc.
Copyright (C) YEAR Free Software Foundation, Inc.
Copyright © 2009 Free Software Foundation, Inc. This file is put in the public domain.
Copyright (C) 2004-2015 Free Software Foundation, Inc. This is free software
Copyright (C) 2010-2015 Free Software Foundation, Inc. This is free software
Copyright 1992-2019 Free Software Foundation, Inc.
Copyright (C) 2014 Free Software Foundation, Inc. This is free software
Copyright (C) 2011 Free Software Foundation, Inc. This config.lt script is free software
Copyright (C) 2002-2018 Free Software Foundation, Inc.
Copyright (C) 2001-2018 Free Software Foundation, Inc.
Copyright (C) 1997-2018 Free Software Foundation, Inc.
Copyright (C) 1999-2018 Free Software Foundation, Inc.
Copyright (C) 1996-2018 Free Software Foundation, Inc.
Copyright (C) 2003-2018 Free Software Foundation, Inc.
Copyright (C) 2009-2018 Free Software Foundation, Inc.
Copyright (C) 2006-2018 Free Software Foundation, Inc.
Copyright (C) 2004-2018 Free Software Foundation, Inc.
Copyright (C) 1995-2014, 2016 Free Software Foundation, Inc.
Copyright (C) 2000-2002, 2007-2014, 2016 Free Software Foundation, Inc.
Copyright (C) 2004-2014, 2016 Free Software Foundation, Inc.
Copyright (C) 1996-2003, 2009-2016 Free Software Foundation, Inc.
Copyright (C) 2001-2016 Free Software Foundation, Inc. dnl This file is free software
Copyright (C) 2001-2005, 2008-2016 Free Software Foundation, Inc. dnl This file is free software
Copyright (C) 1995-2003, 2005-2006, 2008-2014, 2016 Free Software dnl Foundation, Inc.
Copyright (C) 1996-2003, 2005, 2008-2016 Free Software Foundation, Inc. dnl This file is free software
Copyright (C) 1996-2001, 2003-2015 Free Software Foundation, Inc. Written by Gordon Matzigkeit, 1996
Copyright (C) 2014 Free Software Foundation, Inc. This is free software
Copyright (C) 2011 Free Software Foundation, Inc. This config.lt script is free software
Copyright (C) 2004-2005, 2007-2009, 2011-2015 Free Software Foundation, Inc. Written by Gary V. Vaughan, 2004
Copyright (C) 2004-2005, 2007-2008, 2011-2015 Free Software Foundation, Inc. Written by Gary V. Vaughan, 2004
Copyright (C) 2004, 2011-2015 Free Software Foundation, Inc. Written by Scott James Remnant, 2004
Copyright (C) 2004-2005, 2007, 2009, 2011-2015 Free Software Foundation, Inc. Written by Scott James Remnant, 2004.
Copyright (C) 2002-2018 Free Software Foundation, Inc.
Copyright (C) 2001-2018 Free Software Foundation, Inc.
Copyright (C) 1997-2018 Free Software Foundation, Inc.
Copyright (C) 1999-2018 Free Software Foundation, Inc.
Copyright (C) 1996-2018 Free Software Foundation, Inc.
Copyright (C) 2003-2018 Free Software Foundation, Inc.
Copyright (C) 2009-2018 Free Software Foundation, Inc.
Copyright (C) 2006-2018 Free Software Foundation, Inc.
Copyright (C) 2004-2018 Free Software Foundation, Inc.
Copyright (C) 1995-2014, 2016 Free Software Foundation, Inc. dnl This file is free software
Copyright (C) 2000-2002, 2007-2014, 2016 Free Software Foundation, Inc. dnl This file is free software

LICENCE TERMS (cont.)

Copyright (C) 2004-2014, 2016 Free Software Foundation, Inc. dnl This file is free software
Copyright (C) 1996-2003, 2009-2016 Free Software Foundation, Inc. dnl This file is free software
Copyright (C) 2001-2016 Free Software Foundation, Inc. dnl This file is free software
Copyright (C) 2001-2005, 2008-2016 Free Software Foundation, Inc. dnl This file is free software
Copyright (C) 1995-2003, 2005-2006, 2008-2014, 2016 Free Software dnl Foundation, Inc. dnl This file is free software
Copyright (C) 1996-2003, 2005, 2008-2016 Free Software Foundation, Inc. dnl This file is free software
Copyright (C) 1996-2001, 2003-2015 Free Software Foundation, Inc. Written by Gordon Matzigkeit, 1996
Copyright (C) 2004-2005, 2007-2009, 2011-2015 Free Software Foundation, Inc. Written by Gary V. Vaughan, 2004
Copyright (C) 2004-2005, 2007-2008, 2011-2015 Free Software Foundation, Inc. Written by Gary V. Vaughan, 2004
Copyright (C) 2004, 2011-2015 Free Software Foundation, Inc. Written by Scott James Remnant, 2004
Copyright (C) 2004-2005, 2007, 2009, 2011-2015 Free Software Foundation, Inc. Written by Scott James Remnant, 2004.
Copyright (C) 2012 Free Software Foundation, Inc. This configure script is free software
Copyright (C) 2012 Free Software Foundation, Inc. This config.status script is free software
Copyright (C) 2012 Free Software Foundation, Inc. This configure script is free software
Copyright (C) 2012 Free Software Foundation, Inc. This config.status script is free software
Copyright (c) 1987, 1990, 1992 Adobe Systems Incorporated. All Rights Reserved. ITC Stone is a registered trademark of International Typeface Corporation.) readonly def FullName (ITC Stone Sans Bold) readonly def FamilyName (ITC Stone Sans) readonly def Weight (Bold) readonly def isFixedPitch fa
Copyright (c) 1987, 1990, 1992 Adobe Systems Incorporated. All Rights Reserved. ITC Stone is a registered trademark of International Typeface Corporation.) readonly def FullName (ITC Stone Sans) readonly def FamilyName (ITC Stone Sans) readonly def Weight (Medium) readonly def isFixedPitch false
Copyright (c) 1987 Adobe Systems Incorporated.
Copyright (c) 1987 Adobe Systems Incorporated.)readonly def
Copyright (c) 1987, 1990, 1992 Adobe Systems Incorporated. All Rights Reserved. ITC Stone is a registered trademark of International Typeface Corporation.) readonly def FullName (ITC Stone Sans Semibold Italic) readonly def FamilyName (ITC Stone Sans) readonly def Weight (Semibold) readonly def
Copyright (c) 1987, 1990, 1992 Adobe Systems Incorporated. All Rights Reserved. ITC Stone is a registered trademark of International Typeface Corporation.) readonly def FullName (ITC Stone Sans Semibold) readonly def FamilyName (ITC Stone Sans) readonly def Weight (Semibold) readonly def isFixed
Copyright (c) 1987, 1990, 1992 Adobe Systems Incorporated. All Rights Reserved.
Copyright (c) 1987 Adobe Systems Incorporated.
Copyright (c) 1987 Adobe Systems Incorporated.)readonly def
Copyright (c) 1987, 1990, 1992 Adobe Systems Incorporated. All Rights Reserved
Copyright (C) 2008 Free Software Foundation, Inc. This config.lt script is free software
Copyright (C) 2008 Free Software Foundation, Inc. This config.lt script is free software
Copyright (C) 1996, 1997, 1998, 1999, 2000, 2001, 2003, 2004, 2005, 2006, 2007, 2008 Free Software Foundation, Inc. Written by Gordon Matzigkeit, 1996
Copyright (C) 1996, 1997, 1998, 1999, 2000, 2001, 2003, 2004, 2005, 2006, 2007, 2008 Free Software Foundation, Inc. Written by Gordon Matzigkeit, 1996
Copyright 1992-2019 Free Software Foundation, Inc.; Copyright 1992-2019 Free Software Foundation, Inc.

Copyright (C) 1989-1991 Free Software Foundation Inc.
Copyright (C) 2007 Free Software Foundation, Inc.
Copyright (C) 2000-2002 Free Software Foundation, Inc.
Copyright (C) 1987-2018 Free Software Foundation, Inc.
Copyright (C) 1996-2017 Free Software Foundation, Inc.
Copyright (C) 1994-2017 Free Software Foundation, Inc.
Copyright (C) 1985, 1988, 1990-1991, 1995-2010, 2012, 2015 Free Software Foundation, Inc.
Copyright (C) 1988-2017 Free Software Foundation, Inc.
Copyright (C) 1987,1991 Free Software Foundation, Inc.
Copyright (C) 1987-2017 Free Software Foundation, Inc.
Copyright (C) 1985, 1988, 1990-1991, 1995-2010, 2012, 2015, 2017 Free Software Foundation, Inc.
Copyright (C) 1992-2009 Free Software Foundation, Inc.
Copyright (C) 1989, 1992-2009,2017 Free Software Foundation, Inc.
Copyright (C) 1991-2017 Free Software Foundation, Inc.

Copyright (C) 1985, 1988, 1990-1991, 1995-2010, 2012, 2017 Free Software Foundation, Inc.
Copyright (C) 1987-2016 Free Software Foundation, Inc.
Copyright (C) 2001-2015 Free Software Foundation, Inc.
Copyright (C) 1987,1991-2015 Free Software Foundation, Inc.
Copyright (C) 2000-2017 Free Software Foundation, Inc.
Copyright (C) 1994-2015 Free Software Foundation, Inc.
Copyright (C) 1994-2009,2017 Free Software Foundation, Inc.
Copyright (C) 1992-2015 Free Software Foundation, Inc.
Copyright (C) 1987, 1989, 1992 Free Software Foundation, Inc.
Copyright (C) 1993 Free Software Foundation, Inc.
Copyright (C) 1989-2015 Free Software Foundation, Inc.
Copyright (C) 1999-2009 Free Software Foundation, Inc.
Copyright (C) 2009 Free Software Foundation, Inc.
Copyright (C) 1987, 1989, 1992-2015, 2017 Free Software Foundation, Inc.
Copyright (C) 1987-2017 Free Software Foundation, Inc.
Copyright (C) 1987-2009 Free Software Foundation, Inc.
Copyright (C) 1989-2009 Free Software Foundation, Inc.
Copyright (C) 1999 Jeff Solomon
Copyright (C) 1989-2017 Free Software Foundation, Inc.
Copyright (C) 1987,1991,2012 Free Software Foundation, Inc.
Copyright (C) 2001-2017 Free Software Foundation, Inc.
Copyright (C) 1997-2009 Free Software Foundation, Inc.
Copyright (C) 1988,1989-2009,2017 Free Software Foundation, Inc.
Copyright (C) 1993-2009 Free Software Foundation, Inc.
Copyright (C) 1997-2009,2017 Free Software Foundation, Inc.
Copyright @copyright{} 1988-2016 Free Software Foundation, Inc.
Copyright (C) 1988-2018 Free Software Foundation, Inc. end ignore
Copyright @copyright{} 2000, 2001, 2002, 2007, 2008 Free Software Foundation, Inc.
Copyright (C) 1988-2016 Free Software Foundation, Inc.
Copyright (C) 1988-2018 Free Software Foundation, Inc.
Copyright (C) 1988-2016 Free Software Foundation, Inc.
Copyright 1985, 1986, 1988, 1990, 1991, 1992, 1993, 1994, 1995, 1996, 1997, 1998, 1999, 2000, 2001, 2002, 2003, 2004, 2005, 2006, 2007, 2008, 2009, 2010, 2011, 2012, 2013, 2014, 2015 Free Software Foundation, Inc.
Copyright (C) 1999-2015 Free Software Foundation, Inc.
Copyright (C) 1992-2017 Free Software Foundation, Inc.
Copyright (C) 1985, 1988, 1990-1991, 1995-2010, 2012 Free Software Foundation, Inc.
Copyright (C) 1989-2009 Free Software Foundation, Inc.
Copyright (C) 1995-2009 Free Software Foundation, Inc.
Copyright (C) 1991-2010,2017 Free Software Foundation, Inc.
Copyright (C) 1989-2018 Free Software Foundation, Inc.
Copyright (C) 2000-2011 Free Software Foundation, Inc.
Copyright (C) 1987-2011 Free Software Foundation, Inc.
Copyright (C) 1998,2003,2017 Free Software Foundation, Inc.
Copyright (C) 1996-2015 Free Software Foundation, Inc.
Copyright 1991 by the Massachusetts Institute of Technology
Copyright (C) 1996-2002 Free Software Foundation, Inc.
Copyright 1992, 1993, 1994, 1995, 1996, 1997, 1998, 1999, 2001, 2002, 2003, 2004, 2005, 2006, 2007, 2008, 2009, 2010, 2011, 2012, 2013, 2014 Free Software Foundation, Inc.
Copyright (C) 1996-2014 Free Software Foundation, Inc.
Copyright (C) 1999, 2000 Free Software Foundation, Inc.
Copyright 1996-2018 Free Software Foundation, Inc. Taken from GNU libtool, 2001 Originally by Gordon Matzigkeit <gord@gnu.ai.mit.edu>, 1996
Copyright (C) 1994, 1995, 1996, 1997, 1998, 1999, 2000, 2001, 2002, 2003, 2004, 2005, 2006 Free Software Foundation, Inc.
Copyright (C) 2000-2007 Hans Lub hlub@knoware.nl dnl dnl This file is part of rlwrap dnl dnl rlwrap is free software
Copyright (C) 1996-2018 Free Software Foundation, Inc.
Copyright (C) 1992-1996, 1998-2012 Free Software Foundation, Inc.

LICENCE TERMS (cont.)

(C) 2000-2007 Hans Lub
Copyright (C) Damian Ivereigh 2000
Copyright (C) 1994-2018 Free Software Foundation, Inc.
Copyright (c) 1999-2001 Geoff Wing <gcw@pobox.com> by Hans Lub <hclub@knoware.nl>
Copyright (C) Damian Ivereigh 2000
(c) 2001 by Dimitris Vyzovitis [vyzo@media.mit.edu]
Copyright (C) 2011 Free Software Foundation, Inc.
Copyright (C) 1998-2009 Free Software Foundation, Inc.
Copyright 2004 Per Bothner <per@bothner.com> Based on config.h from screen-4.0.2.
Copyright (c) 1993-2002 Juergen Weigert
Copyright (C) 1988-2016 Free Software Foundation, Inc.
Copyright (C) 2004, 1999 Per Bothner
Copyright (C) 1994,2008,2009 Free Software Foundation, Inc.
Copyright (C)©2003-2004 Harold Levy.
Copyright (C) 2000, 2001, 2002, 2007, 2008 Free Software Foundation, Inc.
Copyright (C) 1992, 1993, 1994, 1995, 1996, 1997, 1998, 1999, 2000, 2001, 2002, 2003, 2004, 2005 Free Software Foundation, Inc.
Copyright 1999, 2000 Free Software Foundation, Inc.
Copyright (C) 1996, 1997, 1999, 2000, 2002 Free Software Foundation, Inc. Originally by Fran,cois Pinard <pinard@iro.umontreal.ca>, 1996.
Copyright (C) 1988--2016 Free Software Foundation, Inc.
Copyright (C) 1996, 1997, 1998, 1999, 2000, 2001, 2002, 2003, 2004, 2005, 2006 Free Software Foundation, Inc.
This file is free software
Copyright (C) 1996-2009 Free Software Foundation, Inc.
Copyright (C) 1992, 1993, 1994, 1995, 1996, 1998, 1999, 2000, 2001, 2002, 2003, 2004, 2005, 2006 Free Software Foundation, Inc. This configure script is free software
Copyright (C) 1999-2002 Free Software Foundation, Inc.
Copyright (C) 1995-2003 Free Software Foundation, Inc.
Copyright (C) 2002 Free Software Foundation, Inc.
Copyright (C) 1997-2002 Free Software Foundation, Inc.
Copyright (C) 1997-2003 Free Software Foundation, Inc.
Copyright (C) 1995-2002 Free Software Foundation, Inc.
Copyright (C) 1996-2003 Free Software Foundation, Inc.
Copyright (C) 2001-2003 Free Software Foundation, Inc.
Copyright (C) 1999-2002 Free Software Foundation, Inc.
Copyright (c) 1999-2001 Geoff Wing <gcw@pobox.com>
Copyright (C) 2012 Free Software Foundation, Inc. This configure script is free software
Copyright (C) 2012 Free Software Foundation, Inc. This config.status script is free software
Copyright (c) 1993-2000 Juergen Weigert (jnwieger@immd4.informatik.uni-erlangen.de) Michael Schroeder (mlschroe@immd4.informatik.uni-erlangen.de)
Copyright (c) 1987 Oliver Laumann
Copyright (C) 2000, 2001, 2002, 2007, 2008 Free Software Foundation, Inc.
Copyright 2000, 2001, 2002, 2007, 2008 Free Software Foundation, Inc.
Copyright 2000, 2001, 2002, 2007, 2008 Free Software Foundation, Inc.
Copyright (C) 1989\2014 Free Software Foundation, Inc.
Copyright \co 1989\2014 Free Software Foundation, Inc.
Copyright \co 1989-2017 by the Free Software Foundation, Inc.
Copyright (C) 1989-2017 by the Free Software Foundation, Inc.
Copyright (C) 1992, 1993, 1994, 1995, 1996, 1997, 1998, 1999, 2000, 2001, 2002, 2003, 2004, 2005 Free Software Foundation, Inc.
Copyright (C) 2002, 2003, 2005, 2006 Free Software Foundation, Inc.
Copyright (C) 2001, 2003, 2005 Free Software Foundation, Inc.
Copyright (C) 1997, 2000, 2001, 2003, 2004, 2005, 2006 Free Software Foundation, Inc.
Copyright (C) 1999, 2000, 2001, 2002, 2003, 2004, 2005, 2006 Free Software Foundation, Inc.
Copyright (C) 1999, 2000, 2001, 2002, 2003, 2004, 2005 Free Software Foundation, Inc.
Copyright (C) 1996, 1997, 2000, 2001, 2003, 2005 Free Software Foundation, Inc.
Copyright (C) 1996, 1997, 1998, 1999, 2000, 2001, 2002, 2003, 2004, 2005, 2006 Free Software Foundation, Inc.

Copyright (C) 2003, 2005 Free Software Foundation, Inc.
Copyright (C) 2001, 2002, 2003, 2005 Free Software Foundation, Inc.
Copyright (C) 1997, 1999, 2000, 2001, 2003, 2004, 2005 Free Software Foundation, Inc.
Copyright (C) 2003, 2004, 2005, 2006 Free Software Foundation, Inc.
Copyright (C) 2006 Free Software Foundation, Inc.
Copyright (C) 2004, 2005 Free Software Foundation, Inc.
Copyright (c) 1999-2001 Geoff Wing <gcw@pobox.com>
Copyright (C) 2006 Free Software Foundation, Inc. This config.status script is free software
Copyright (C) 1989-2017 by the Free Software Foundation, Inc.
Copyright (C) 1989-2014 Free Software Foundation, Inc.
Copyright (C) 1994 X Consortium
Copyright (C) 1999-2018 Free Software Foundation, Inc. Written by Tom Tromey <tromey@cygnus.com>.
Copyright 1992-2019 Free Software Foundation, Inc.
Copyright (C) 1999-2018 Free Software Foundation, Inc.
Copyright (C) 1996-2018 Free Software Foundation, Inc. Originally written by Fran,cois Pinard <pinard@iro.umontreal.ca>, 1996.
Copyright (C) 2011-2018 Free Software Foundation, Inc.
Copyright (C) 1989, 1991 Free Software Foundation, Inc., 51 Franklin Street, Fifth Floor, Boston, MA 02110-1301 USA Everyone is permitted to copy and distribute verbatim copies of this license document, but changing it is not allowed.
Copyright (c) 2006, 2008 Junio C Hamano
Copyright (c) 2008 Steven G. Johnson <stevenj@alum.mit.edu>
Copyright (C) 2001 Philipp Rumpf
Copyright (c) 2011-2014, Intel Corporation Authors: Fenghua Yu <fenghua.yu@intel.com>, H. Peter Anvin <hpa@linux.intel.com> PIC code by: Francisco Blas Izquierdo Riera (klondike) <klondike@gentoo.org>
Copyright (C) 2004 Henrique M. Holschuh <hnh@debian.org>
Copyright (C) 2004 Henrique de Moraes Holschuh <hnh@debian.org>
Copyright (C) 2017 - Neil Horman <nhorman@tuxdriver.com>
Copyright (C) 1996-2018 Free Software Foundation, Inc.
Copyright (C) 2001 Philipp Rumpf
Copyright (C) 1992-1996, 1998-2012 Free Software Foundation, Inc.
Copyright 2009 Red Hat, Inc.
Copyright (c) 2017, Neil Horman
Copyright (C) 2004 Henrique de Moraes Holschuh <hnh@debian.org>
Copyright (C) 1994-2018 Free Software Foundation, Inc.
Copyright (c) 2012-2014, Intel Corporation Authors: Richard B. Hill <richard.b.hill@intel.com>, H. Peter Anvin <hpa@linux.intel.com>, John P. Mechalis <john.p.mechalis@intel.com>
Copyright (c) 2004 Henrique de Moraes Holschuh -- hnh@debian.org
Copyright 1992-2019 Free Software Foundation, Inc.
Copyright (c) 2011 Daniel Richard G. <skunk@iSKUNK.ORG>
Copyright (c) 2011 Daniel Richard G. <skunk@iSKUNK.ORG>
Copyright (c) 2004 by Henrique de Moraes Holschuh
Copyright (C) 2002-2018 Free Software Foundation, Inc.
Copyright (C) 2001-2018 Free Software Foundation, Inc.
Copyright (C) 1997-2018 Free Software Foundation, Inc.
Copyright (C) 1999-2018 Free Software Foundation, Inc.
Copyright (C) 1996-2018 Free Software Foundation, Inc.
Copyright (C) 2003-2018 Free Software Foundation, Inc.
Copyright (C) 2009-2018 Free Software Foundation, Inc.
Copyright (C) 2006-2018 Free Software Foundation, Inc.
Copyright (C) 2004-2018 Free Software Foundation, Inc.
Copyright © 2004 Scott James Remnant <scott@netsplit.com>.
Copyright © 2012-2015 Dan Nicholson <dbn.lists@gmail.com> dnl dnl This program is free software
Copyright (c) 2008 Steven G. Johnson <stevenj@alum.mit.edu>
Copyright (C) 2002-2018 Free Software Foundation, Inc.
Copyright (C) 2001-2018 Free Software Foundation, Inc.
Copyright (C) 1997-2018 Free Software Foundation, Inc.

LICENCE TERMS (cont.)

Copyright (C) 1999-2018 Free Software Foundation, Inc.
Copyright (C) 1996-2018 Free Software Foundation, Inc.
Copyright (C) 2003-2018 Free Software Foundation, Inc.
Copyright (C) 2009-2018 Free Software Foundation, Inc.
Copyright (C) 2006-2018 Free Software Foundation, Inc.
Copyright (C) 2004-2018 Free Software Foundation, Inc.
Copyright © 2004 Scott James Remnant <scott@netsplit.com>.
Copyright © 2012-2015 Dan Nicholson <dbn.lists@gmail.com> dnl dnl This program is free software
Copyright (c) 2008 Steven G. Johnson <stevnj@alum.mit.edu>
Copyright (C) 2004 Henrique de Moraes Holschuh <hmh@debian.org> dnl dnl This program is free software
Copyright (C) 2012 Free Software Foundation, Inc. This configure script is free software
Copyright (C) 2012 Free Software Foundation, Inc. This config.status script is free software
Copyright 2001-2004 Jeff Garzik
Copyright 2017 Neil Horman
Copyright (c) 2001 by Philipp Rumpfl This is free software
Copyright (C) 1994 X Consortium
Copyright (C) 1999-2018 Free Software Foundation, Inc. Written by Tom Tromej <tromej@cygnus.com>.
Copyright 1992-2019 Free Software Foundation, Inc.
Copyright (C) 1999-2018 Free Software Foundation, Inc.
Copyright (C) 1996-2018 Free Software Foundation, Inc. Originally written by Fran.cois Pinard <pinard@iro.umontreal.ca>, 1996.
Copyright (C) 2011-2018 Free Software Foundation, Inc.
Copyright (C) 1989, 1991 Free Software Foundation, Inc.,
Copyright (c) 1991, 1993 The Regents of the University of California. All rights reserved.
Copyright (C) 1996-2018 Free Software Foundation, Inc.
Copyright (C) 1992-1996, 1998-2012 Free Software Foundation, Inc.
Copyright (C) 1995-2001 Red Hat, Inc.
Copyright (C) 2007-2017 Free Software Foundation, Inc.
Copyright (C) 1994-2018 Free Software Foundation, Inc.
Copyright 1992-2019 Free Software Foundation, Inc.
Copyright (C) 2002-2018 Free Software Foundation, Inc.
Copyright (C) 2001-2018 Free Software Foundation, Inc.
Copyright (C) 1997-2018 Free Software Foundation, Inc.
Copyright (C) 1999-2018 Free Software Foundation, Inc.
Copyright (C) 2003-2018 Free Software Foundation, Inc.
Copyright (C) 2009-2018 Free Software Foundation, Inc.
Copyright (C) 2006-2018 Free Software Foundation, Inc.
Copyright (C) 2004-2018 Free Software Foundation, Inc.
Copyright (C) 2012 Free Software Foundation, Inc. This configure script is free software
Copyright (C) 2012 Free Software Foundation, Inc. This config.status script is free software
Copyright 2011 Free Software Foundation, Inc.
Copyright (C) 1994 X Consortium
Copyright (C) 1999-2018 Free Software Foundation, Inc. Written by Tom Tromej <tromej@cygnus.com>.
Copyright 1992-2019 Free Software Foundation, Inc.
Copyright (C) 1999-2018 Free Software Foundation, Inc.
Copyright (C) 1996-2018 Free Software Foundation, Inc. Originally written by Fran.cois Pinard <pinard@iro.umontreal.ca>, 1996.
Copyright (C) 1994-1996, 1999-2002, 2004-2016 Free Software Foundation, Inc.
Copyright (c) Copyright (c) Bull S.A. 2005 All Rights Reserved. Redistribution and use in source and binary forms, with or without modification, are permitted provided that the following conditions are met:
Copyright 1989 AT&T
Copyright (C) 1996-2018 Free Software Foundation, Inc.
Copyright (C) 1992-1996, 1998-2012 Free Software Foundation, Inc.
Copyright (c) 2009, Sun Microsystems, Inc. All rights reserved.
Copyright (C) 1994-2018 Free Software Foundation, Inc.
Copyright (C) 1995 Olaf Kirch <okir@monad.swb.de>
Copyright (c) 2000 The NetBSD Foundation, Inc. All rights reserved.

Copyright 1992-2019 Free Software Foundation, Inc.
Copyright (C) 2002-2018 Free Software Foundation, Inc.
Copyright (C) 2001-2018 Free Software Foundation, Inc.
Copyright (C) 1997-2018 Free Software Foundation, Inc.
Copyright (C) 1999-2018 Free Software Foundation, Inc.
Copyright (C) 1996-2018 Free Software Foundation, Inc.
Copyright (C) 2003-2018 Free Software Foundation, Inc.
Copyright (C) 2009-2018 Free Software Foundation, Inc.
Copyright (C) 2006-2018 Free Software Foundation, Inc.
Copyright (C) 2004-2018 Free Software Foundation, Inc.
Copyright © 2004 Scott James Remnant <scott@netsplit.com>.
Copyright © 2012-2015 Dan Nicholson <dbn.lists@gmail.com>
Copyright (C) 2012 Free Software Foundation, Inc.
Copyright (C) 2012 Free Software Foundation, Inc.
Copyright 1991 Sun Microsystems, Inc.
Copyright (c) 1990 by Sun Microsystems, Inc.
Copyright (c) 1986 - 1991 by Sun Microsystems, Inc.
Copyright (c) 1984 - 1991 by Sun Microsystems, Inc.
Copyright 2007 Openedhand Ltd.
Copyright (C) 1994 X Consortium
Copyright (C) 1996-2015 Free Software Foundation, Inc. This is free software
Copyright (C) 1999-2018 Free Software Foundation, Inc. Written by Tom Tromej <tromej@cygnus.com>.
Copyright 1992-2019 Free Software Foundation, Inc.
Copyright (C) 1999-2018 Free Software Foundation, Inc.
Copyright (C) 1996-2018 Free Software Foundation, Inc. Originally written by Fran.cois Pinard <pinard@iro.umontreal.ca>, 1996.
Copyright (C) 1995-1997, 2000-2007, 2009-2010 by Ulrich Drepper <drepper@gnu.ai.mit.edu>
Copyright 1996-2016 Free Software Foundation, Inc. Taken from GNU libtool, 2001 Originally by Gordon Matzigkeit <gord@gnu.ai.mit.edu>, 1996
Copyright (C) 1996-2018 Free Software Foundation, Inc.
Copyright (c) 1990 - 1994, Julianne Frances Haugh
Copyright (c) 1989 - 1994, Julianne Frances Haugh
Copyright (c) 2000 - 2005, Tomasz Kloczko
Copyright (c) 1989 - 1991, Julianne Frances Haugh
Copyright (c) 1992 - 1993, Julianne Frances Haugh
Copyright (c) 1991 - 1994, Julianne Frances Haugh
Copyright (c) 2005 , Red Hat, Inc.
Copyright (C) 1984, 1989-1990, 2000-2015 Free Software Foundation, Inc.
Copyright (c) 1989 - 1992, Julianne Frances Haugh
Copyright (C) 1994-2018 Free Software Foundation, Inc.
Copyright (c) 2008 , Nicolas François All rights reserved.
Copyright (c) 2008 - 2011, Nicolas François All rights reserved.
Copyright (c) 2007 - 2009, Nicolas François All rights reserved.
Copyright (c) 2009 - 2010, Nicolas François All rights reserved.
Copyright (c) 1996 - 1997, Marek Michał L. Iewicz
Copyright (c) 2011 , Julian Pidancet
Copyright (c) 1992 - 1994, Julianne Frances Haugh
Copyright (c) 2008 - 2009, Nicolas François All rights reserved.
Copyright (c) 1991 - 1993, Julianne Frances Haugh
Copyright (c) 1991 , Julianne Frances Haugh
Copyright 1991, Julianne Frances Haugh All rights reserved.
Copyright 1991 - 1994, Julianne Frances Haugh All rights reserved.
Copyright (c) 2013 Eric Biederman All rights reserved.
Copyright 1991 - 1993, Julianne Frances Haugh All rights reserved.
Copyright 1989 - 1990, Julianne Frances Haugh All rights reserved.
Copyright (c) 1997 - 1999, Marek Michał L. Iewicz
Copyright (c) 1993 Michael Haardt (michael@moriam.de)

LICENCE TERMS (cont.)

Copyright 1990 - 1994 Julianne Frances Haugh All rights reserved.
Copyright Red Hat, Inc., 1998, 1999, 2002.
Copyright (c) 2012 Eric Biederman
Copyright 1993 Rickard E. Faith (faith@cs.unc.edu) May be distributed under the GNU General Public License
(c) 1994 by salvatore valente <svalente@athena.mit.edu>
Copyright (c) 2017, Chris Lamb All rights reserved.
Copyright (c) 1989 - 1993, Julianne Frances Haugh
Copyright (c) 1983, 1991 The Regents of the University of California. All rights reserved.
Copyright (C) 1996-2018 Free Software Foundation, Inc.
Copyright 1993 Rickard E. Faith (faith@cs.unc.edu)
Copyright (C) 1992-1996, 1998-2012 Free Software Foundation, Inc.
Copyright (C) 2011 Free Software Foundation, Inc. This config.lt script is free software
Copyright 1992, Phillip Street and Julianne Frances Haugh All rights reserved.
Copyright (c) 1993 Michael Haardt (u31b3hs@pool.informatik.rwth-aachen.de)
Copyright 1989 \- 1994, John F. Haugh II All rights reserved.
Copyright 1991, Julianne Frances Haugh Hungarian translation by Peter Mamuzsics <zumu@mentha.hu> All rights reserved.
Copyright 1990, John F. Haugh II All rights reserved.
Copyright 1996, Rafal Maszkowski, rzm@pdi.net All rights reserved.
(C) 1999 Ragnar Hojland Espinosa <ragnar@macula.net>
Copyright 1989 \- 1994, Julianne Frances Haugh All rights reserved.
Copyright (c) 2009 , Nicolas Francois All rights reserved.
Copyright 1991 \- 1994, Julianne Frances Haugh All rights reserved.
Copyright (c) 1992 , Julianne Frances Haugh
Copyright (c) 2011 , Jonathan Nieder All rights reserved.
Copyright (c) 2011 , Peter Vrabc <pvrabc@redhat.com> All rights reserved.
Copyright (c) 2012 - Eric Biederman
Copyright (c) 1990 , Julianne Frances Haugh
Copyright (c) 1993 - 1994, Julianne Frances Haugh
Copyright (c) 1999 , Marek Michał L iewicz
Copyright (c) 1988 - 1994, Julianne Frances Haugh
Copyright (c) 2010 , Jakub Hrozek <jhrozek@redhat.com>
Copyright (c) 1989 - 1990, Julianne Frances Haugh
Copyright (c) 2005 - 2006, Tomasz Kloczko All rights reserved.
Copyright (c) 1996 , Rafal Maszkowski
Copyright (c) 1990 - 1993, Julianne Frances Haugh
Copyright (c) 2012- Eric W. Biederman
Copyright (C) 2006 THE PACKAGE'S COPYRIGHT HOLDER This file is distributed under the same license as the shadow package. Daniel Nylander <po@danielnylander.se>, 2006.
Copyright (C) 2012 Free Software Foundation, Inc. This file is distributed under the same license as the shadow package. Joe Hansen (joedalton2@yahoo.dk), 2012.
Copyright (c) 2001 Rafal Wojtczuk, Solar Designer All rights reserved.
Copyright (C) 1995-1997, 2000-2006 by Ulrich Drepper <drepper@gnu.ai.mit.edu>
Copyright (C) 2006 Free Software Foundation, Inc. Simon Brandmair <sbrandmair@gmx.net>, 2005, 2006, 2007, 2011, 2012.
Copyright 1992 - 1993, Julianne Frances Haugh All rights reserved.
Copyright 1992, Julianne Frances Haugh All rights reserved.
Copyright (c) 1996 - 2000, Marek Michał L iewicz
Copyright (c) 2001 Yuichi SATO all rights reserved. Translated Sat Dec 1 20:09:17 JST 2001 by Yuichi SATO <ysato@h4.dion.ne.jp> Modified Sun 22 Sep 2002 by NAKANO Takeo <nakano@apm.seikei.ac.jp>
Copyright (c) 2001 Maki KURODA all right reserved, Translated Tue Oct 30 11:55:56 JST 2001 by Maki KURODA <mkuroda@aisys-jp.com> Modified Sun 22 Sep 2002 by NAKANO Takeo <nakano@apm.seikei.ac.jp>
Copyright (C) YEAR THE PACKAGE'S COPYRIGHT HOLDER. Sorin Batariuc <sorin@bonbon.net>, 2004, 2005, 2006.
Copyright: Ming Hua <minghua@ubuntu.com>, 2005,2006,2007. Carlos Z.F. Liu <carloslu@users.sourceforge.net>, 2004,2006. YunQiang Su <wzssyqa@gmail.com>, 2010, 2012.
Copyright 1989 - 1992, Julianne Frances Haugh All rights reserved.

Copyright 1989 - 1993, Julianne Frances Haugh All rights reserved.
Copyright (c) 2001 Maki KURODA all right reserved, Translated Mon Nov 5 18:12:16 JST 2001 by Maki KURODA <mkuroda@aisys-jp.com> Modified Tue 18 Sep 2002 by NAKANO Takeo <nakano@apm.seikei.ac.jp>
Copyright (c) 1997 Kazuyoshi Furutaka all rights reserved. Translated Fri 14 Feb 1997 by Kazuyoshi Furutaka <furutaka@Flux.tokai.jaeri.go.jp> Modified Tue 18 Sep 2002 by NAKANO Takeo <nakano@apm.seikei.ac.jp>
Copyright 1991 - 1993, Julianne Frances Haugh and Chip Rosenthal All rights reserved.
Copyright 1989 - 1994, Julianne Frances Haugh All rights reserved.
Copyright (C) 2006, 2008, 2011 Free Software Foundation, Inc. This file is distributed under the same license as the shadow package. Daniel Nylander <po@danielnylander.se>, 2006, 2008, 2011.
Copyright 1990 - 1994 Julianne Frances Haugh All rights reserved. Modified for expiry by Ben Collins <bcollins@debian.org>, 1999
Copyright (C) 2011 Free Software Foundation, Inc. This file is distributed under the same license as the shadow package. Claus Hindsgaul <claus.hindsgaul@gmail.com>, 2004, 2005, 2006. Joe Hansen (joedalton2@yahoo.dk), 2011, 2012.
Copyright 1990, Julianne Frances Haugh All rights reserved.
Copyright 1996, Rafal Maszkowski <rzm@pdi.net> All rights reserved.
Copyright (C) 2004, 2005, 2006, 2007, 2008, 2009 Free Software Foundation, Inc.
Copyright (C) 2004 Free Software Foundation, Inc. This file is distributed under the same license as the shadow package. Giuseppe Sacco <eppesuig@debian.org>, 2004. Danilo Piazzalunga <danilopiazza@gmail.com>, 2004-2006.
Copyright © 2015 Free Software Foundation, Inc. Clytie Siddall <clytie@riverland.net.au>, 2005-2008. Trần Ngọc Quân <vnwildman@gmail.com>, 2014, 2015, 2016.
Copyright (C) YEAR THE PACKAGE'S COPYRIGHT HOLDER. Shiva Pokharel <pokharelshiva@hotmail.com>, 2006.
Copyright (C) 2004, 2005, 2006, 2008, 2009 Free Software Foundation, Inc.
Copyright (C) YEAR THE PACKAGE'S COPYRIGHT HOLDER This file is distributed under the same license as the PACKAGE package. Asho S.Y. Yeg <asho@debian.org.tw>, 2004.
Copyright (C) 1999 Free Software Foundation, Inc. Arkadiusz Miśkiewicz <misiek@misiek.eu.org>, 1999. Jakub Bogusz <qboosh@pld-linux.org>, 2003-2004. Tomasz Kloczko <kloczek@pld.org.pl>, 2004-2006
Copyright (C) 2004-2007 Free Software Foundation, Inc. Tommi Vainikainen <Tommi.Vainikainen@iki.fi>, 2004-2007.
Copyright (c) 1993 , The Regents of the University of California
Copyright (c) 2013 Eric W. Biederman All rights reserved.
Copyright (C) 2004, 2011 Free Software Foundation, Inc. This file is distributed under the same license as the shadow package.
Copyright (C) 2004, 2006 Free Software Foundation, Inc. Knut Yrvin <knuty@skolelinux.no>, 2004. Klaus Ade Johnstad <klaus.johnstad@holmlia.gs.oslo.no>, 2004. Klaus Ade Johnstad <klaus@skolelinux.no>, 2004. Håvard Korsvoll <korsvoll@skulelinux.no>, 2004. Bjørn Steensrud <bjornst@powertech>
Copyright (C) 1999, 2004, 2005 Free Software Foundation, Inc. Jacobo Tarrio <jtarrio@debian.org>, 2006
Copyright (C) 2004 THE shadow'S COPYRIGHT HOLDER This file is distributed under the same license as the shadow package. Lior Kaplan <webmaster@guides.co.il>, 2004.
Copyright (C) YEAR Free Software Foundation, Inc.
Copyright (C) 1999 Free Software Foundation, Inc. Frank Schmid <frank@cs-schmid.de>, 2002 Holger Wansing <linux@wansing-online.de>, 2006, 2008, 2009, 2011, 2012, 2014.
Copyright (C) 2009 Free Software Foundation, Inc. This file is distributed under the same license as the PACKAGE package. Baurzhan Muftakhidinov <baurthefirst@gmail.com>, 2009-2017.
Copyright (C) 2004 Free Software Foundation, Inc. Håvard Korsvoll <korsvoll@skulelinux.no>, 2004.
Copyright (C) YEAR Free Software Foundation, Inc. Yasuyuki Furukawa <furukawa@vinelinux.org>, 2000. revised by NAKANO Takeo <nakano@webmasters.gr.jp> since 2004-09-05
Copyright (C) 2004 Free Software Foundation, Inc. Elian Myftiu <elian@lycos.com>, 2004.
Copyright (C) 2004 Free Software Foundation, Inc. Bart Cornelis <cobaco@linux.be>, 2004, 2006. Frans Spiesschaert <Frans.Spiesschaert@yucum.be>, 2014, 2017.
Copyright (C) 2004 Free Software Foundation, Inc.© Luis Lopes <andrelp@debian.org>, 2004.
Copyright (C) 2005 Software in the Public Interest, Inc.
Copyright (C) 1996 Marek Michalkiewicz <marekm@i17linux.ists.pwr.wroc.pl>.
Copyright (C) 1996 Petri Mattila, Prihateam Networks petri@prihateam.fi
Copyright (c) 1996 Brian R. Gaeke All rights reserved.

LICENCE TERMS (cont.)

Copyright (C) 1989, 1991 Free Software Foundation, Inc.
Copyright (C) 1999 Sami Kerola and Janne Riihijärvi
Copyright 2000, International Business Machines, Inc. All rights reserved.
Copyright (c) 1996 - 1998, Marek Michał L. Iewicz
Copyright (c) 1997, Luca Berra
Copyright (c) 2007 - 2008, Nicolas François All rights reserved.
Copyright (c) 2010, Paweł Hajdan All rights reserved.
Copyright (c) 2013, Eric W. Biederman All rights reserved.
Copyright (c) 1993 Michael Haardt (michael@morja.de)
COPYRIGHT (版權) 版權所有 1999 Free Software Foundation, Inc.
Copyright (c) 2005 - 2008, Nicolas François All rights reserved.
Copyright (c) 1997, Marek Michał L. Iewicz
Copyright (c) 2000, International Business Machines George Kraft IV, gk4@us.ibm.com, 03/23/2000
Copyright 1991, Julianne Frances Haugh Todos os direitos reservados.
Copyright 1991 - 1993, Julianne Frances Haugh All rights reserved.
Copyright (c) 1997, Guy Maor <maor@ece.utexas.edu>
Copyright 1989 - 1990, Julianne Frances Haugh All rights reserved.
Copyright (c) 1996, Marek Michał L. Iewicz
Copyright (c) 2006, Tomasz Kłoczko
Copyright (c) 2004 The FreeBSD Project. All rights reserved.
Copyright (c) 1996, Michael Meskes
Copyright (c) 1994, Julianne Frances Haugh
Copyright 1995 by Wietse Venema. All rights reserved.
Copyright (C) 2004-2015 Free Software Foundation, Inc. This is free software
Copyright (C) 2010-2015 Free Software Foundation, Inc. This is free software
Copyright 1992-2019 Free Software Foundation, Inc.
Copyright (c) 1996 - 1997, Marek Michał L. Iewicz
Copyright (c) 2003 - 2005, Tomasz Kłoczko
Copyright (c) 2008, Nicolas François All rights reserved.
Copyright (c) 1996 - 1997, Marek Michał L. Iewicz
Copyright (c) 2003 - 2005, Tomasz Kłoczko
Copyright (c) 2008, Nicolas François All rights reserved.
Copyright (c) 1996 - 1997, Marek Michał L. Iewicz
Copyright (c) 2003 - 2005, Tomasz Kłoczko
Copyright (c) 2008, Nicolas François All rights reserved.
Copyright (c) 1996 - 1999, Marek Michał L. Iewicz
Copyright (c) 2001 - 2005, Tomasz Kłoczko
Copyright (c) 2008 - 2009, Nicolas François All rights reserved.
Copyright (c) 1996 - 1999, Marek Michał L. Iewicz
Copyright (c) 2001 - 2005, Tomasz Kłoczko
Copyright (c) 2008 - 2009, Nicolas François All rights reserved.
Copyright (c) 2007 - 2008, Nicolas François All rights reserved.
Copyright (c) 2007 - 2008, Nicolas François All rights reserved.
Copyright (c) 2007 - 2008, Nicolas François All rights reserved.
Copyright (c) 1996 - 1998, Marek Michał L. Iewicz
Copyright (c) 1996 - 1998, Marek Michał L. Iewicz
Copyright (c) 1996 - 1998, Marek Michał L. Iewicz
Copyright (c) 1996 - 2000, Marek Michał L. Iewicz
Copyright (c) 2010 - , Nicolas François All rights reserved.
Copyright (c) 1996 - 2000, Marek Michał L. Iewicz
Copyright (c) 2010 - , Nicolas François All rights reserved.
Copyright (c) 1996 - 2000, Marek Michał L. Iewicz
Copyright (c) 2010 - , Nicolas François All rights reserved.
Copyright (c) 1997 - 2000, Marek Michał L. Iewicz

Copyright (c) 2005, Tomasz Kłoczko
Copyright (c) 1997 - 2000, Marek Michał L. Iewicz
Copyright (c) 2005, Tomasz Kłoczko
Copyright (c) 1997 - 2000, Marek Michał L. Iewicz
Copyright (c) 2005, Tomasz Kłoczko
Copyright (c) 1996 - 2001, Marek Michał L. Iewicz
Copyright (c) 2003 - 2006, Tomasz Kłoczko
Copyright (c) 2007 - 2010, Nicolas François All rights reserved.
Copyright (c) 1996 - 2001, Marek Michał L. Iewicz
Copyright (c) 2003 - 2006, Tomasz Kłoczko
Copyright (c) 2007 - 2010, Nicolas François All rights reserved.
Copyright (c) 1996 - 2001, Marek Michał L. Iewicz
Copyright (c) 2003 - 2006, Tomasz Kłoczko
Copyright (c) 2007 - 2010, Nicolas François All rights reserved.
Copyright (c) 2005 - 2008, Nicolas François All rights reserved.
Copyright (c) 2005 - 2008, Nicolas François All rights reserved.
Copyright (c) 2005 - 2008, Nicolas François All rights reserved.
Copyright (c) 1997, Marek Michał L. Iewicz
Copyright (c) 1997, Marek Michał L. Iewicz
Copyright (c) 1997, Marek Michał L. Iewicz
Copyright (c) 2000 - 2006, Tomasz Kłoczko
Copyright (c) 2007 - 2009, Nicolas François All rights reserved.
Copyright (c) 2000 - 2006, Tomasz Kłoczko
Copyright (c) 2007 - 2009, Nicolas François All rights reserved.
Copyright (c) 2000 - 2006, Tomasz Kłoczko
Copyright (c) 2007 - 2009, Nicolas François All rights reserved.
Copyright (c) 2008 - 2010, Nicolas François All rights reserved.
Copyright (c) 2008 - 2010, Nicolas François All rights reserved.
Copyright (c) 2008 - 2010, Nicolas François All rights reserved.
Copyright (c) 2001 - 2006, Tomasz Kłoczko
Copyright (c) 2001 - 2006, Tomasz Kłoczko
Copyright (c) 2001 - 2006, Tomasz Kłoczko
Copyright (c) 2011, Nicolas François All rights reserved.
Copyright (c) 2011, Nicolas François All rights reserved.
Copyright (c) 2011, Nicolas François All rights reserved.
Copyright (c) 2007 - 2011, Nicolas François All rights reserved.
Copyright (c) 2007 - 2011, Nicolas François All rights reserved.
Copyright (c) 2007 - 2011, Nicolas François All rights reserved.
Copyright (c) 1991 - 1994, Chip Rosenthal
Copyright (c) 1991 - 1994, Chip Rosenthal
Copyright (c) 1991 - 1994, Chip Rosenthal
Copyright (c) 2002 - 2005, Tomasz Kłoczko
Copyright (c) 2002 - 2005, Tomasz Kłoczko
Copyright (c) 2002 - 2005, Tomasz Kłoczko
Copyright (c) 2003 - 2005, Tomasz Kłoczko All rights reserved.
Copyright (c) 2003 - 2005, Tomasz Kłoczko All rights reserved.
Copyright (c) 2003 - 2005, Tomasz Kłoczko All rights reserved.
Copyright (c) 2008 - 2011, Nicolas François
Copyright (c) 2014, Red Hat, Inc. All rights reserved.
Copyright (c) 2008 - 2011, Nicolas François
Copyright (c) 2014, Red Hat, Inc. All rights reserved.
Copyright (c) 2008 - 2011, Nicolas François
Copyright (c) 2014, Red Hat, Inc. All rights reserved.
Copyright (c) 1991, Chip Rosenthal
Copyright (c) 1991, Chip Rosenthal
Copyright (c) 1991, Chip Rosenthal
Copyright (c) Cristian Gafton, 1998, <gafton@redhat.com>

LICENCE TERMS (cont.)

Copyright (c) Cristian Gafton, 1998, <gafton@redhat.com>
Copyright (c) 1991 - 1993, Chip Rosenthal
Copyright (c) 1991 - 1993, Chip Rosenthal
Copyright (c) 1991 - 1993, Chip Rosenthal
Copyright (c) 2009 , Nicolas François All rights reserved.
Copyright (c) 2009 , Nicolas François All rights reserved.
Copyright (c) 2009 , Nicolas François All rights reserved.
Copyright (c) 2005 , Tomasz Kłoczko All rights reserved.
Copyright (c) 2005 , Tomasz Kłoczko All rights reserved.
Copyright (c) 2005 , Tomasz Kłoczko All rights reserved.
Copyright (c) 2008 - 2011, Nicolas François All rights reserved.
Copyright (c) 2008 - 2011, Nicolas François All rights reserved.
Copyright (c) 2008 - 2011, Nicolas François All rights reserved.
Copyright (c) 2003 - 2006, Tomasz Kłoczko All rights reserved.
Copyright (c) 2003 - 2006, Tomasz Kłoczko All rights reserved.
Copyright (c) 2003 - 2006, Tomasz Kłoczko All rights reserved.
Copyright (c) 2010 , Nicolas François All rights reserved.
Copyright (c) 2010 , Nicolas François All rights reserved.
Copyright (c) 2010 , Nicolas François All rights reserved.
Copyright (C) 2002-2018 Free Software Foundation, Inc.
Copyright (C) 2001-2018 Free Software Foundation, Inc.
Copyright (C) 1997-2018 Free Software Foundation, Inc.
Copyright (C) 1999-2018 Free Software Foundation, Inc.
Copyright (C) 1996-2018 Free Software Foundation, Inc.
Copyright (C) 2003-2018 Free Software Foundation, Inc.
Copyright (C) 2009-2018 Free Software Foundation, Inc.
Copyright (C) 2006-2018 Free Software Foundation, Inc.
Copyright (C) 2004-2018 Free Software Foundation, Inc.
Copyright (C) 1995-2014, 2016 Free Software Foundation, Inc. dnl This file is free software
Copyright (C) 2000-2002, 2007-2014, 2016 Free Software Foundation, Inc. dnl This file is free software
Copyright (C) 2004-2014, 2016 Free Software Foundation, Inc. dnl This file is free software
Copyright (C) 1996-2003, 2009-2016 Free Software Foundation, Inc. dnl This file is free software
Copyright (C) 2001-2016 Free Software Foundation, Inc. dnl This file is free software
Copyright (C) 2001-2005, 2008-2016 Free Software Foundation, Inc. dnl This file is free software
Copyright (C) 1996-2001, 2003-2015 Free Software Foundation, Inc. Written by Gordon Matzigeit, 1996
Copyright (C) 2014 Free Software Foundation, Inc. This is free software
Copyright (C) 2011 Free Software Foundation, Inc. This config.lt script is free software
Copyright (C) 2004-2005, 2007-2009, 2011-2015 Free Software Foundation, Inc. Written by Gary V. Vaughan, 2004
Copyright (C) 2004-2005, 2007-2008, 2011-2015 Free Software Foundation, Inc. Written by Gary V. Vaughan, 2004
Copyright (C) 2004, 2011-2015 Free Software Foundation, Inc. Written by Scott James Remnant, 2004
Copyright (C) 2004-2005, 2007, 2009, 2011-2015 Free Software Foundation, Inc. Written by Scott James Remnant, 2004.
Copyright (C) 1995-2003, 2005-2006, 2008-2014, 2016 Free Software dnl Foundation, Inc. dnl This file is free software
Copyright (C) 1996-2003, 2005, 2008-2016 Free Software Foundation, Inc. dnl This file is free software
Copyright (C) 2002-2018 Free Software Foundation, Inc.
Copyright (C) 2001-2018 Free Software Foundation, Inc.
Copyright (C) 1997-2018 Free Software Foundation, Inc.
Copyright (C) 1999-2018 Free Software Foundation, Inc.
Copyright (C) 1996-2018 Free Software Foundation, Inc.
Copyright (C) 2003-2018 Free Software Foundation, Inc.
Copyright (C) 2009-2018 Free Software Foundation, Inc.
Copyright (C) 2006-2018 Free Software Foundation, Inc.
Copyright (C) 2004-2018 Free Software Foundation, Inc.
Copyright (C) 1995-2014, 2016 Free Software Foundation, Inc. dnl This file is free software
Copyright (C) 2000-2002, 2007-2014, 2016 Free Software Foundation, Inc. dnl This file is free software
Copyright (C) 2004-2014, 2016 Free Software Foundation, Inc. dnl This file is free software

Copyright (C) 1996-2003, 2009-2016 Free Software Foundation, Inc. dnl This file is free software
Copyright (C) 2001-2016 Free Software Foundation, Inc. dnl This file is free software
Copyright (C) 2001-2005, 2008-2016 Free Software Foundation, Inc. dnl This file is free software
Copyright (C) 1996-2001, 2003-2015 Free Software Foundation, Inc. Written by Gordon Matzigeit, 1996
Copyright (C) 2014 Free Software Foundation, Inc. This is free software
Copyright (C) 2011 Free Software Foundation, Inc. This config.lt script is free software
Copyright (C) 2004-2005, 2007-2009, 2011-2015 Free Software Foundation, Inc. Written by Gary V. Vaughan, 2004
Copyright (C) 2004-2005, 2007-2008, 2011-2015 Free Software Foundation, Inc. Written by Gary V. Vaughan, 2004
Copyright (C) 2004, 2011-2015 Free Software Foundation, Inc. Written by Scott James Remnant, 2004
Copyright (C) 2004-2005, 2007, 2009, 2011-2015 Free Software Foundation, Inc. Written by Scott James Remnant, 2004.
Copyright (C) 1995-2003, 2005-2006, 2008-2014, 2016 Free Software dnl Foundation, Inc.
Copyright (C) 1996-2003, 2005, 2008-2016 Free Software Foundation, Inc.
Copyright (C) 2012 Free Software Foundation, Inc. This configure script is free software
Copyright (C) 2012 Free Software Foundation, Inc. This config.status script is free software
Copyright (C) 2012 Free Software Foundation, Inc. This configure script is free software
Copyright (C) 2012 Free Software Foundation, Inc. This config.status script is free software
Copyright (c) 2001 , Michał Moskal
Copyright (c) 2001 , Michał Moskal
Copyright (c) 2001 , Michał Moskal
Copyright (c) 2007 - 2013, Nicolas François All rights reserved.
Copyright (c) 2007 - 2013, Nicolas François All rights reserved.
Copyright (c) 2007 - 2013, Nicolas François All rights reserved.
Copyright (c) 2002 - 2006, Tomasz Kłoczko
Copyright (c) 2002 - 2006, Tomasz Kłoczko
Copyright (c) 2002 - 2006, Tomasz Kłoczko
Copyright (c) 2005 , Michał Moskal
Copyright (c) 2005 , Michał Moskal
Copyright (c) 2005 , Michał Moskal
Copyright (c) 2007 , Nicolas François All rights reserved.
Copyright (c) 2007 , Nicolas François All rights reserved.
Copyright (c) 2007 , Nicolas François All rights reserved.
Copyright (c) 2001 - 2005, Tomasz Kłoczko All rights reserved.
Copyright (c) 2001 - 2005, Tomasz Kłoczko All rights reserved.
Copyright (c) 2001 - 2005, Tomasz Kłoczko All rights reserved.
Copyright (c) 2011 , Peter Vrabec <pvrabec@redhat.com> All rights reserved.
Copyright (c) 2011 , Peter Vrabec <pvrabec@redhat.com> All rights reserved.
Copyright (c) 2011 , Peter Vrabec <pvrabec@redhat.com> All rights reserved.
Copyright (c) 1997 Kazuyoshi Furutaka all rights reserved. Translated Fri Feb 14 23:06:00 JST 1997 by Kazuyoshi Furutaka <furutaka@Flux.tokai.jaeri.go.jp> Updated & Modified Sat 21 Sep 2002 by NAKANO Takeo <nakano@apm.seikei.ac.jp>
Copyright (c) 1997 Kazuyoshi Furutaka all rights reserved. Translated Fri Feb 14 23:06:00 JST 1997 by Kazuyoshi Furutaka <furutaka@Flux.tokai.jaeri.go.jp> Updated & Modified Sat 21 Sep 2002 by NAKANO Takeo <nakano@apm.seikei.ac.jp>
Copyright (c) 1997 Kazuyoshi Furutaka all rights reserved. Translated Fri Feb 14 23:06:00 JST 1997 by Kazuyoshi Furutaka <furutaka@Flux.tokai.jaeri.go.jp> Updated & Modified Thu Oct 14 1997 by NAKANO Takeo <nakano@apm.seikei.ac.jp> Updated Fri Jan 12 2001 by Kenta
Copyright (c) 1997 Kazuyoshi Furutaka all rights reserved. Translated Fri Feb 14 23:06:00 JST 1997 by Kazuyoshi Furutaka <furutaka@Flux.tokai.jaeri.go.jp> Updated & Modified Thu Oct 14 1997 by NAKANO Takeo <nakano@apm.seikei.ac.jp> Updated Fri Jan 12 2001 by Kenta
Copyright (c) 1997 Kazuyoshi Furutaka all rights reserved. Translated Fri Feb 14 23:06:00 JST 1997 by Kazuyoshi Furutaka <furutaka@Flux.tokai.jaeri.go.jp> Updated Sun 3 Mar 2002 by NAKANO Takeo <nakano@apm.seikei.ac.jp> Modified Sun 22 Sep 2002 by NAKANO Takeo
Copyright (c) 1997 Kazuyoshi Furutaka all rights reserved. Translated Fri Feb 14 23:06:00 JST 1997 by Kazuyoshi Furutaka <furutaka@Flux.tokai.jaeri.go.jp> Updated Sun 3 Mar 2002 by NAKANO Takeo <nakano@apm.seikei.ac.jp> Modified Sun 22 Sep 2002 by NAKANO Takeo
Copyright (c) 1997 Kazuyoshi Furutaka all rights reserved. Translated Fri Feb 14 23:06:00 JST 1997 by Kazuyoshi

LICENCE TERMS (cont.)

Copyright (c) 1999 - 2000, Marek Michał L iewicz
Copyright (c) 2007 - 2013, Nicolas François All rights reserved.
Copyright (c) 2007 - 2012, Nicolas François All rights reserved.
Copyright (C) 1992-2003 Free Software Foundation, Inc.
Copyright (c) 2008 - 2012, Nicolas François All rights reserved.
Copyright (c) 2006 , Tomasz Kłoczko
Copyright (c) 2006 , Jonas Meurer
Copyright (C) 1994 X Consortium
Copyright (C) 1999-2018 Free Software Foundation, Inc. Written by Tom Tromeey <tromeey@cygnus.com>.
Copyright 1992-2019 Free Software Foundation, Inc.
Copyright (C) 1999-2018 Free Software Foundation, Inc.
Copyright (C) 1996-2018 Free Software Foundation, Inc. Originally written by Fran.cois Pinard <pinard@iro.umontreal.ca>, 1996.
Copyright (C) 1989, 1991 Free Software Foundation, Inc.,
Copyright (C) 1995, 1996, 1997 by Ulrich Drepper <drepper@gnu.ai.mit.edu>
Copyright (C) 2008 Free Software Foundation, Inc. Ihar Hrachyshka <ihar.hrachyshka@gmail.com>, 2008.
(c) 2001 Filip Van Raemdonck <mechanix@debian.org>
Copyright (C) 1996-2018 Free Software Foundation, Inc.
Copyright (C) 1992-1996, 1998-2012 Free Software Foundation, Inc.
Copyright (C) 2003 Thomas Leonard.
Copyright (C) 1994-2018 Free Software Foundation, Inc.
Copyright (C) 2008 Red Hat, Inc.
Copyright 1992-2019 Free Software Foundation, Inc.
Copyright (C) 2004-2008 Rodney Dawes <dobey.pwns@gmail.com>
Copyright (C) 2002 Thomas Leonard.
Copyright (C) 2002-2018 Free Software Foundation, Inc.
Copyright (C) 2001-2018 Free Software Foundation, Inc.
Copyright (C) 1997-2018 Free Software Foundation, Inc.
Copyright (C) 1999-2018 Free Software Foundation, Inc.
Copyright (C) 2003-2018 Free Software Foundation, Inc.
Copyright (C) 2009-2018 Free Software Foundation, Inc.
Copyright (C) 2006-2018 Free Software Foundation, Inc.
Copyright (C) 2004-2018 Free Software Foundation, Inc.
Copyright (C) 1995-2002 Free Software Foundation, Inc.
Copyright (C) 2001-2003,2004 Red Hat, Inc.
Copyright (C) 2004-2013 Free Software Foundation, Inc.
Copyright (C) 1995-2003, 2005-2006, 2008-2014, 2016 Free Software dnl Foundation, Inc.
Copyright © 2004 Scott James Remnant <scott@netsplit.com>.
Copyright © 2012-2015 Dan Nicholson <dbn.lists@gmail.com>
Copyright (C) 2012 Free Software Foundation, Inc. This configure script is free software
Copyright (C) 2012 Free Software Foundation, Inc. This config.status script is free software
Copyright (c) 2009-2018 Arm Limited.
Copyright (c) 2009-2019 ARM Limited.
Copyright (c) 2009-2019 Arm Limited.
Copyright (c) 2013-2019 ARM Limited.
Copyright (c) 2013-2020 Arm Limited.
Copyright (c) 2017-2018 Arm Limited.
Copyright (c) 2017-2019 Arm Limited.
Copyright (c) 2017-2019 IAR Systems
Copyright (c) 2018 Arm Limited.
Copyright (c) 2018 STMicroelectronics. All rights reserved.
Copyright (c) 2018-2019 Arm Limited.
Copyright (c) 2018-2021 STMicroelectronics. All rights reserved.
"Copyright (c) 2019 STMicroelectronics. All rights reserved."
Copyright (C) 2020 Amazon.com, Inc. or its affiliates.
Copyright (c) 2020 STMicroelectronics. All rights reserved.
Copyright (c) 2021 STMicroelectronics. All rights reserved.

Copyright(c) 2021 Panasonic Life Solutions Co., Ltd. Template version 1.00.00
"Portion Copyright (C) 2017 Amazon.com, Inc. or its affiliates.
Portion Copyright (C) 2019 STMicroelectronics, Inc."
Portions Copyright © 2017 STMicroelectronics International N.V.
Portions Copyright (c) 2013-2017 ARM Limited.
(c) 2021 Chart.js Contributors Released
(c) 2020 Jukka Kurkela
(c) 2021 chartjs-plugin-annotation Contributors
(c) 2016-2021 chartjs-plugin-zoom Contributor
Copyright (c) 2016 Jorik Tangelder
(c) OpenJS Foundation and other contributors | jquery.org/license
Copyright (c) 2009-2018 Arm Limited. All rights reserved.
Copyright (c) 2009-2019 ARM Limited. All rights reserved.
Copyright (C) 2017 Amazon.com, Inc. or its affiliates. All Rights Reserved.
Copyright (C) 2019 STMicroelectronics, Inc. All Rights Reserved.
Copyright (c) 2017-2018 Arm Limited. All rights reserved.
Copyright (c) 2017-2019 Arm Limited. All rights reserved.
Copyright (c) 2018 Arm Limited. All rights reserved.
(C) COPYRIGHT STMicroelectronics
Copyright (c) 2018-2019 Arm Limited. All rights reserved.
Copyright (c) 2019 STMicroelectronics. All rights reserved.(C) COPYRIGHT STMicroelectronics
Copyright (C) 2020 Amazon.com, Inc. or its affiliates. All Rights Reserved.
Copyright (c) 2021 STMicroelectronics. All rights reserved.(C) COPYRIGHT STMicroelectronics *****END OF FILE*****/
Copyright 2014 Scott Finneran <scottfinneran@yahoo.com.au>;Copyright Peter Miller <pmiller@opensource.org.au>
This program is free software
Copyright © Scott Finneran <scottfinneran@yahoo.com.au>;Copyright © 1998, 1999, 2000, 2001, 2002, 2003, 2004, 2005, 2006, 2007, 2008, 2009, 2010, 2011, 2012, 2013, 2014 Peter Miller <pmiller@opensource.org.au> Copyright © 1998, 1999, 2000, 2001, 2002, 2003, 2004, 2005, 2006, 2007, 2008, 2009, 2010, 2011, 2012, 2013, 2014 Peter Miller;Copyright © 1998, 1999, 2000, 2001, 2002, 2003, 2004, 2005, 2006, 2007, 2008, 2009, 2010, 2011, 2012, 2013, 2014 SCott Finneran The SRecord package
copyright Scott Finneran;E-Mail:;scottfinneran@yahoo.com.au, and they will be GNU GPL licensed.
Copyright © 1998, 1999, 2000, 2001, 2002, 2003, 2004, 2005, 2006, 2007, 2008, 2009, 2010, 2011, 2012, 2013, 2014 Peter Miller The src_cat program comes with ABSOLUTELY NO WARRANTY
Copyright © 1998, 1999, 2000, 2001, 2002, 2003, 2004, 2005, 2006, 2007, 2008, 2009, 2010, 2011, 2012, 2013, 2014 Peter Miller The src_cmp program comes with ABSOLUTELY NO WARRANTY
Copyright (C) 1812 Tchaikovsky.
Copyright © Scott Finneran <scottfinneran@yahoo.com.au>;Copyright © 1998, 1999, 2000, 2001, 2002, 2003, 2004, 2005, 2006, 2007, 2008, 2009, 2010, 2011, 2012, 2013, 2014 Peter Miller <pmiller@opensource.org.au>
Copyright © 2017 STMicroelectronics International N.V. All rights reserved.;Copyright (c) 2013-2017 ARM Limited. All rights reserved.
Copyright 2014 Scott Finneran <scottfinneran@yahoo.com.au>
Copyright Peter Miller <pmiller@opensource.org.au>
Copyright © Scott Finneran <scottfinneran@yahoo.com.au>
Copyright © 1998, 1999, 2000, 2001, 2002, 2003, 2004, 2005, 2006, 2007, 2008, 2009, 2010, 2011, 2012, 2013, 2014 Peter Miller <pmiller@opensource.org.au>
Copyright © 1998, 1999, 2000, 2001, 2002, 2003, 2004, 2005, 2006, 2007, 2008, 2009, 2010, 2011, 2012, 2013, 2014 Peter Miller
Copyright © 1998, 1999, 2000, 2001, 2002, 2003, 2004, 2005, 2006, 2007, 2008, 2009, 2010, 2011, 2012, 2013, 2014 SCott Finneran
copyright Scott Finneran;E-Mail:;scottfinneran@yahoo.com.au
Copyright (C) 1812 Tchaikovsky.
Copyright (C) 1989, 1991 Free Software Foundation, Inc., 51 Franklin Street, Fifth Floor, Boston, MA 02110-1301 USA
Copyright (c) 2006, 2008 Junio C Hamano
Copyright (C) 1991, 1999 Free Software Foundation, Inc.
Copyright (c) 2015 Sabrina Dubroca <sd@queasysnail.net>

LICENCE TERMS (cont.)

(c) Copyright 1995 Simon "Guru Aleph-Null" Janes NCM: Network and Communications Management, Inc.;(c)
Copyright 1999, Thomas Davis, tadavis@lbl.gov
Copyright (C) 1999-2000 Maxim Krasnyansky <max_mk@yahoo.com>
Copyright © 2014 Vinay Kulkarni <kulkarniv@vmware.com>
Copyright © 2016 BSDN GmbH. All rights reserved.
Copyright © 2013-2019 Daniele Medri
Copyright © 2017 Intel Corporation. All rights reserved.
Copyright © 2014 Intel Corporation. All rights reserved.
Copyright © 2015-2017 Jason A. Donenfeld <Jason@zx2c4.com>. All Rights Reserved.
Copyright © 2015 Boyuan Yang
Copyright © 2015 Jeff Huang
Copyright © 2015 Rafael Ferreira (translation)
Copyright © 2016 Alexander Shopov <ash@kambanaria.org>
Copyright © 2015 Werner Fink
Copyright © 2016 Gabor Kelemen;© kell bejelenteni.
Copyright © 2004 Chris Friesen <chris_friesen@sympatico.ca>
Copyright © 2003 Greg Kroah-Hartman <greg@kroah.com>
Copyright © 2013-2017 Sergey Ptashnick
Copyright © 2009-2010 David Zeuthen <zeuthen@gmail.com>
Copyright (c) 2009 Filippo Argiolas <filippo.argiolas@gmail.com>
Copyright © 2004 David Zeuthen, <david@fubar.dk>
Copyright © 2009 Canonical Ltd.
Copyright (c) 2005 SUSE Linux Products GmbH, Germany Author: Hannes Reinecke <hare@suse.de>
Copyright © 2011 ProFUSION embedded systems
Copyright © 2010 - Maxim Levitsky
Copyright © IBM Corp. 2003
Copyright (C) IBM Corp. 2003
Copyright © IBM Corp. 2003
Copyright © 2011 Karel Zak <kzak@redhat.com>
Copyright © 2003-2004 Greg Kroah-Hartman <greg@kroah.com>
Copyright © 2017 Michal Sekletar <msekleta@redhat.com>
© 2017 Canonical Ltd. Author: Dan Streetman <dan.streetman@canonical.com>
© 2015 Canonical Ltd. Author: Martin Pitt <martin.pitt@ubuntu.com>
Copyright © 2004 Leann Ogasawara <ogasawara@osdl.org>
Copyright (C) 1999 Tom Tromey
Copyright © 2016 Michael Karcher
Copyright (C) 1999, 2000 Tom Tromey
Copyright © 2013 Intel Corporation
Copyright (C) 2015-2019 Jason A. Donenfeld <Jason@zx2c4.com>. All Rights Reserved.
Copyright (C) 2007 Oracle. All rights reserved.
(c) UCB 1982-1988 Ross Biro Fred N. van Kempen, <waltje@uWalt.NL.Mugnet.ORG>
© 2010 Canonical Ltd. Author: Martin Pitt <martin.pitt@ubuntu.com>
Copyright (c) 2012 Josh Triplett <josh@joshtriplett.org>
(C) 2016 Canonical Ltd. Author: Martin Pitt <martin.pitt@ubuntu.com>
Copyright © 2013 Intel Corporation Authored by Joonas Lahtinen <joonas.lahtinen@linux.intel.com>
Copyright © 2017 Max Resch <resch.max@gmail.com>
COPYRIGHT (C) 1986 Gary S. Brown.
Copyright © 2012 Holger Hans Peter Freyther
Copyright © 2016 Djalal Harouni
Copyright © 2010 ProFUSION embedded systems
Copyright © 2013 Intel Corporation Authors: Nathaniel Chen <nathaniel.chen@intel.com>
Copyright © 2012 Roberto Sassu
Copyright © 2010 Maarten Lankhorst
Copyright © 2018 Neal Gomba
Copyright © 2014 Michael Maríneau
Copyright © 2013 Holger Hans Peter Freyther
Copyright © 2013 Jan Janssen

Copyright © 2016 Canonical Ltd.
Copyright © 2013 Simon Peeters
Copyright (C) 1995-2004 Miquel van Smoorenburg
Copyright (C) 2001 - 2003 Sistina Software (UK) Limited.
Copyright (c) 2011-2014 PLUMgrid, http://plumgrid.com
Copyright 2008 Red Hat, Inc. All rights reserved.
Copyright (C) 1998 David S. Miller (davem@redhat.com)
Copyright © 2018 Dell Inc.
Copyright © 2017 Felipe Sateler
Copyright © 2010 Ran Benita
Copyright © 2010-2017 Canonical
Copyright © 2012 B. Poettering Contact: fsprg@point-at-infinity.org
Copyright © 2008 Alan Jenkins <alan.christopher.jenkins@gmail.com>
Copyright © 2016 Zeal Jagannatha
Copyright © 2016 Michal Soltys <soltys@ziu.info>
Copyright © 2019 Oracle and/or its affiliates. */
Copyright © 2009 Alan Jenkins <alan-jenkins@tuffmail.co.uk>
Copyright © 2013 Intel Corporation. All rights reserved.
Copyright © 2014-2015 Intel Corporation. All rights reserved.
Copyright © 2015, 2016. Free Software Foundation, Inc.
Copyright © 2016 Alexander Shopov <ash@kambanaria.org> Alexander Shopov <ash@kambanaria.org>, 2016.
Copyright © 2014 Axis Communications AB. All rights reserved.
Copyright © 2016 Julian Orth
Copyright © 2016 Red Hat, Inc.
Copyright © 2014 Axis Communications AB. All rights reserved.
Copyright © 2013 Intel Corporation. All rights reserved.
Copyright © 2014 Holger Hans Peter Freyther
Copyright © 2014 Vinay Kulkarni
Copyright © 2014 Didier Roche
Copyright © 2014 Josh Triplett
Copyright © 2015 Chris Morgan
Copyright © 2014 Jason St. John
Copyright © 2010 Brandon Philips
Copyright © 2009 Scott James Remnant <scott@netsplit.com>
Copyright © 2014 Carlos Garnacho <carlosg@gnome.org>
Copyright © SUSE Linux Products GmbH, 2006
Copyright (C) 2000 Red Hat, Inc.
Copyright © 2000, 2005 Red Hat, Inc.
Copyright (C) 2007-2019 Free Software Foundation, Inc. This file is part of the GNU C Library.
Copyright © 2012 <James.Bottomley@HansenPartnership.com>
Copyright (C) 2004 - 2009 Red Hat, Inc. All rights reserved.
Copyright 2008 Ian Kent <raven@themaw.net>
Copyright 2001 Jeff Garzik <jgarzik@pobox.com>
Copyright 2001 Sun Microsystems (thockin@sun.com)
Copyright 2002 Intel (eli.kupermann@intel.com, christopher.leech@intel.com, scott.feldman@intel.com)
Copyright (C) Sun Microsystems 2008
Copyright 1992-2019 Free Software Foundation, Inc.; Copyright 1992-2019 Free Software Foundation, Inc.
Copyright 1991 by the Massachusetts Institute of Technology
Copyright (c) 1994, 1996 The Regents of the University of California. All rights reserved.
Copyright (c) 2013 The TCPDUMP project All rights reserved.
Copyright (C) 2000 Alfredo Andres Omella. All rights reserved.
Copyright (c) 1989, 1990, 1991, 1993, 1994 The Regents of the University of California. All rights reserved.
Copyright (c) 1996, 1997 The Regents of the University of California. All rights reserved.
Copyright (c) 1988, 1989, 1990, 1991, 1992, 1993, 1994, 1995, 1996, 1997 The Regents of the University of California. All rights reserved.
Copyright (c) 2014 The TCPDUMP project All rights reserved.
Copyright (c) 2001 NETLAB, Temple University

LICENCE TERMS (cont.)

Copyright (c) 1988, 1989, 1990, 1991, 1992, 1993, 1994 The Regents of the University of California. All rights reserved.

Copyright (c) 1998-2007 The TCPDUMP project

Copyright (C) 2019 Free Software Foundation, Inc.

Copyright (c) 1997 Yen Yen Lim and North Dakota State University All rights reserved.

Copyright (c) 2002 Guy Harris. All rights reserved.

Copyright (c) 1988, 1989, 1990, 1991, 1992, 1993, 1994, 1995, 1996, 1997, 2000 The Regents of the University of California. All rights reserved.

Copyright (c) 1995, 1996 The Regents of the University of California. All rights reserved.

Copyright (c) 2000 William C. Fenner. All rights reserved.

Copyright (c) 1990, 1996 John Robert LoVerso. All rights reserved.

Copyright (c) 1993, 1994 Jeffrey C. Mogul, Digital Equipment Corporation, Western Research Laboratory. All rights reserved.

Copyright (c) 2013 Romain Francoise <romain@orebokech.com>

Copyright (c) 2013, The TCPDUMP project All rights reserved.

Copyright (c) 1986-2008 by Cisco Systems, Inc.

Copyright (c) 1989, 1990, 1992, 1993 Regents of the University of California. All rights reserved.

Copyright (c) 1986-2008 by Cisco Systems, Inc.

Copyright (c) 1992, 1993, 1994, 1995, 1996, 1997 The Regents of the University of California. All rights reserved.

Copyright (c) 1986-2006 by Cisco Systems, Inc.

Copyright (c) 1989, 1993 The Regents of the University of California. All rights reserved.

Copyright (c) 1996 The Regents of the University of California. All rights reserved.

Copyright (c) 1998-2004 Hannes Gredler <hannes@gredler.at>

Copyright (c) 2007-2011 Grégoire Henry, Juliusz Chroboczek

Copyright (c) 1987 Regents of the University of California. All rights reserved.

Copyright (c) 2009 Mojatatu Networks, Inc

Copyright (c) 1994, 1995, 1996, 1997 The Regents of the University of California. All rights reserved.

Copyright (c) 1988, 1989, 1990, 1993, 1994, 1995, 1996 The Regents of the University of California. All rights reserved.

Copyright (c) 2009 Siemens AG, All rights reserved. Dmitry Eremin-Solenikov (dbaryshkov@gmail.com)

Copyright (c) 2013 The TCPDUMP project

Copyright (c) 1988, 1989, 1990, 1991, 1992, 1993, 1994, 1995, 1996 The Regents of the University of California. All rights reserved.

Copyright (c) 1992, 1993, 1994, 1995, 1996 The Regents of the University of California. All rights reserved.

Copyright (C) 2012 Free Software Foundation, Inc. This config.status script is free software

Copyright (c) 1990, 1991, 1993, 1994, 1995, 1996, 1997 The Regents of the University of California. All rights reserved.

Copyright (c) 1990, 1991, 1993, 1994, 1995, 1996, 1997 John Robert LoVerso. All rights reserved.

Copyright (c) 1982, 1986, 1993 The Regents of the University of California. All rights reserved.

Copyright (c) 1998-2007 The TCPDUMP project

Copyright (c) 2015 The TCPDUMP project All rights reserved.

Copyright (c) 1993, 1994, 1996 The Regents of the University of California. All rights reserved.

Copyright (c) 2000 The NetBSD Foundation, Inc. All rights reserved.

Copyright (C) 1992-1996, 1998-2012 Free Software Foundation, Inc.

Copyright (C) 2001 Julian Cowley All rights reserved.

Copyright: (c) 2000 United States Government as represented by the Secretary of the Navy. All rights reserved.

Copyright (c) 2013, Petar Alilovic, Faculty of Electrical Engineering and Computing, University of Zagreb All rights reserved

Copyright (c) 1988, 1989, 1990, 1991, 1992, 1993, 1994, 1995, 1996, 1997, 2000 The Regents of the University of California. All rights reserved.

Copyright (c) 2001 Nickolai Zeldovich <kolya@MIT.EDU> All rights reserved.

Copyright (c) 1988-1997 The Regents of the University of California. All rights reserved.

Copyright (c) 1989, 1990, 1991, 1993, 1994, 1995, 1996, 1997 The Regents of the University of California. All rights reserved.

Copyright (C) Andrew Tridgell 1995-1999

Copyright (C) 2002 WIDE Project. All rights reserved.

Copyright (c) 1988, 1989, 1990, 1991, 1993, 1994 The Regents of the University of California. All rights reserved.

Copyright (c) 2001 Fortress Technologies, Inc. All rights reserved. Charlie Lenahan (clenahan@fortresstech.com)

Copyright (c) 2004 by Internet Systems Consortium, Inc. ("ISC")

Copyright (c) 1998-2006 The TCPDUMP project

Copyright (c) 2003, 2004 David Young. All rights reserved.

Copyright (c) 1991, 1993, 1994, 1995, 1996, 1997 The Regents of the University of California. All rights reserved.

Copyright (c) 1993, 1994, 1995, 1996, 1997 The Regents of the University of California. All rights reserved.

Copyright (c) 2004 - Michael Richardson <mcr@xelerance.com>

(c) 1998 The NetBSD Foundation, Inc. All rights reserved.

Copyright (c) 2003 Bruce M. Simpson <bms@spc.org> All rights reserved.

Copyright (C) 2001 WIDE Project. All rights reserved.

Copyright (c) 1988, 1989, 1990, 1991, 1993, 1994, 1995, 1996 The Regents of the University of California. All rights reserved.

Copyright (c) 1991, 1992, 1993, 1994, 1995, 1996, 1997 The Regents of the University of California. All rights reserved.

Copyright (C) 1998 and 1999 WIDE Project. All rights reserved.

Copyright (c) 1990, 1991, 1992, 1993, 1994, 1995, 1996, 1997 The Regents of the University of California. All rights reserved.

Copyright (c) 1988, 1992, 1993 The Regents of the University of California. All rights reserved.

Copyright (c) 2014 VMware, Inc. All Rights Reserved.

Copyright (c) 1982, 1986, 1990, 1993 The Regents of the University of California. All rights reserved.

Copyright (c) 1990, 1992, 1993, 1994, 1995, 1996, 1997 The Regents of the University of California. All rights reserved.

Copyright (c) 1993, 1994, 1995, 1996, 1997 The Regents of the University of California. All rights reserved.

Copyright (c) 1990, 1991, 1993, 1994, 1995, 1996 The Regents of the University of California. All rights reserved.

Copyright (c) 1992, 1993, 1994, 1995, 1996 The Regents of the University of California. All rights reserved.

Copyright (c) 1997 The Regents of the University of California. All rights reserved.

Copyright (c) 2015, bugyo All rights reserved.

Copyright (c) 2012

Copyright (c) 1999 Kungliga Tekniska Högskolan Royal Institute of Technology, Stockholm, Sweden). All rights reserved.

Copyright (c) 1998 Michael Shalayeff All rights reserved.

Copyright (c) 1998-2011 The TCPDUMP project

Copyright (c) 2002 Jason L. Wright (jason@thought.net) All rights reserved.

Copyright (c) 2000 Lennert Buytenhek

Copyright (c) 2002 - 2003 NetGroup, Politecnico di Torino (Italy) All rights reserved.

Copyright (C) 1995, 1996, 1997, and 1998 WIDE Project. All rights reserved.

Copyright (c) 1988, 1989, 1990, 1991, 1993, 1994 The Regents of the University of California. All rights reserved.

Copyright (c) 1987, 1988, 1989, 1990, 1991, 1992, 1994, 1995, 1996, 1997 The Regents of the University of California. All rights reserved. All rights reserved.

Copyright (c) 2015 Ritesh Ranjan (r.ranjan789@gmail.com) All rights reserved.

Copyright (c) 1995, 1996, 1997 The Regents of the University of California. All rights reserved.

Copyright (c) 1993, 1994, 1997 The Regents of the University of California. All rights reserved.

Copyright (c) 1994, 1995, 1996 The Regents of the University of California. All rights reserved.

Copyright (c) 1983, 1989, 1993 The Regents of the University of California. All rights reserved.

Copyright (c) 1989, 1990, 1993, 1994, 1995, 1996 The Regents of the University of California. All rights reserved.

Copyright (c) 1990, 1993, 1994, 1995, 1996 The Regents of the University of California. All rights reserved.

Copyright (C) 1999 WIDE Project. All rights reserved.

Copyright (c) 2007 - Andrey "nording" Chernyak <andrew@nording.ru>

Copyright (c) 1988-2002 The Regents of the University of California. All rights reserved.

Copyright (c) 1995 The Regents of the University of California. All rights reserved.

"Copyright (c) 1995, 1996, 1997, 1998 dnl The Regents of the University of California. All rights reserved. "

Copyright (C) 1998 WIDE Project. All rights reserved.

Copyright (c) 2016 Antonin Décimo, Jean-Raphaël Gaglione

Copyright (c) 1993, 1994, 1995, 1996 The Regents of the University of California. All rights reserved.

Copyright (c) 1988, 1989, 1990, 1991, 1992, 1993, 1994, 1995, 1996, 1997 The Regents of the University of California. All rights reserved.

Copyright (c) 1990, 1991, 1993, 1994, 1995, 1996, 1997 The Regents of the University of California. All rights reserved.

LICENCE TERMS (cont.)

reserved.
Copyright (c) 1990, 1991, 1993, 1994, 1995, 1996 The Regents of the University of California. All rights reserved.
"Copyright (c) 1994, 1995, 1996, 1997 dnl The Regents of the University of California. All rights reserved."
Copyright (c) 2000 Ben Smithurst <ben@scientia.demon.co.uk> All rights reserved.
Copyright 1989 by Carnegie Mellon.
Copyright (c) 1989, 1990, 1991, 1993, 1994, 1996 The Regents of the University of California. All rights reserved.
Copyright (c) 2007 paolo.abeni@email.it All rights reserved.
Copyright (c) 2000 William C. Fenner. All rights reserved.
Copyright (c) 1997, 1998 The NetBSD Foundation, Inc. All rights reserved.
Copyright (c) 1990, 1993 The Regents of the University of California. All rights reserved.
Copyright (c) 1993, 1994, 1995, 1996, 1997, 1998 The Regents of the University of California. All rights reserved.
Copyright (c) 2002 Todd C. Miller <Todd.Miller@courtesan.com>
Copyright (c) 1998 Todd C. Miller <Todd.Miller@courtesan.com> All rights reserved.
Copyright (c) 1995-1999 Kungliga Tekniska Högskolan Royal Institute of Technology, Stockholm, Sweden). All rights reserved.
Copyright (c) 1988, 1993 The Regents of the University of California. All rights reserved.
Copyright (C) 2000, Richard Sharpe
Copyright (c) 1991, 1992, 1993, 1994, 1995, 1996 The Regents of the University of California. All rights reserved.
Copyright (c) 1988, 1989, 1990, 1991, 1992, 1993, 1994 The Regents of the University of California. All rights reserved.
Copyright (c) 2001 William C. Fenner. All rights reserved.
Copyright 2009 Bert Vermeulen <bert@biot.com>
Copyright (C) Arnaldo Carvalho de Melo 2004
Copyright (c) 1986-2005 by Cisco Systems, Inc.
Copyright (c) 1986-2005 by Cisco Systems, Inc.
Copyright (C) 1995, 1996, 1997 and 1998 WIDE Project. All rights reserved.
Copyright (c) 2001 Protocol Engineering Lab, University of Delaware
Copyright (C) 1999 Cisco And Motorola
Copyright (c) 2001 Seth Webster <swebster@sst.ll.mit.edu>
Copyright (c) 1988, 1989, 1990, 1991, 1992, 1993, 1994, 1995, 1996, 1997, 2000\n The Regents of the University of California. All rights reserved.
Copyright (c) 2011 Advanced Computing Technologies George V. Neille-Neil
copyright (c) 1999 William C. Fenner.
Copyright (c) 2001 Compaq Computer Corporation. All rights reserved.
Copyright (c) 1986-2006 by Cisco Systems, Inc.
Copyright (c) 2001 Seth Webster <swebster@sst.ll.mit.edu>
Copyright (c) 1998, Larry Lile All rights reserved.
Copyright (c) 1999.
Copyright (c) 2009 Florian Forster
Copyright (C) 2012 Free Software Foundation, Inc. This configure script is free software
Copyright (c) 1998-2012 Michael Richardson <mcr@tcpdump.org> The TCPDUMP project
Copyright (c) 1996, 1999 by Internet Software Consortium.
Copyright (C) 1984, Sun Microsystems, Inc.
Copyright (c) 1993 by Digital Equipment Corporation.
Copyright (c) 1999 WIDE Project. All rights reserved.
Copyright (c) 1999-2004 The tcpdump.org project
Copyright 1988 by Carnegie Mellon.
Copyright (C) 1995, 1996, 1997, 1998 by John Ioannidis, Angelos D. Keromytis and Niels Provos.
Copyright (c) 2001, Angelos D. Keromytis.
Copyright (c) 1994, Simon J. Gerraty.
Copyright (C) Ian McDonald 2005
Copyright (C) Yoshifumi Nishida 2005
Copyright (C) 1994 X Consortium
Copyright (C) 1999-2018 Free Software Foundation, Inc. Written by Tom Tromeey <tromeey@cygnus.com>.
Copyright 1992-2019 Free Software Foundation, Inc.
Copyright (C) 1999-2018 Free Software Foundation, Inc.
Copyright (C) 2004-2005, 2007, 2009, 2011-2015 Free Software Foundation, Inc. Written by Scott James Remnant,

2004.
Copyright (C) 2004, 2011-2015 Free Software Foundation, Inc. Written by Scott James Remnant, 2004
Copyright (C) 1996-2001, 2003-2015 Free Software Foundation, Inc. Written by Gordon Matzigeit, 1996
Copyright (C) 2004-2005, 2007-2008, 2011-2015 Free Software Foundation, Inc. Written by Gary V. Vaughan, 2004
Copyright (C) 2004-2005, 2007-2009, 2011-2015 Free Software Foundation, Inc. Written by Gary V. Vaughan, 2004
Copyright (C) 1996-2018 Free Software Foundation, Inc. Originally written by Fran,cois Pinard <pinard@iro.umontreal.ca>, 1996.
Copyright (C) 2011-2018 Free Software Foundation, Inc.
Copyright (C) 1995-1997, 2000-2007, 2009-2010 by Ulrich Drepper <drepper@gnu.ai.mit.edu>
Copyright 1996-2016 Free Software Foundation, Inc. Taken from GNU libtool, 2001 Originally by Gordon Matzigeit <gord@gnu.ai.mit.edu>, 1996
Copyright (C) 1995-2014, 2016 Free Software Foundation, Inc. dnl This file is free software
Copyright (C) 2000-2002, 2007-2014, 2016 Free Software Foundation, Inc.
Copyright (C) 2001-2005, 2008-2016 Free Software Foundation, Inc
Copyright (C) 1996-2003, 2005, 2008-2016 Free Software Foundation, Inc.
Copyright (C) 1995-2003, 2005-2006, 2008-2014, 2016 Free Software dnl Foundation, Inc.
Copyright (C) 1996-2003, 2009-2016 Free Software Foundation, Inc.
Copyright (C) 2001-2016 Free Software Foundation, Inc.
Copyright (C) 1995-2014, 2016 Free Software Foundation, Inc.
Copyright (C) 2000-2018 Free Software Foundation, Inc.
Copyright (C) 2007 Free Software Foundation, Inc.
Copyright (C) 1992-2009 Free Software Foundation, Inc.
Copyright (C) 1987-2016 Free Software Foundation, Inc.
Copyright (C) 1994-2015 Free Software Foundation, Inc.
Copyright (C) 1992-2015 Free Software Foundation, Inc.
Copyright (C) 1987, 1989, 1992 Free Software Foundation, Inc.
Copyright (C) 1989-2015 Free Software Foundation, Inc.
Copyright (C) 1993-2009 Free Software Foundation, Inc.
Copyright (C) 2000-2011 Free Software Foundation, Inc.
Copyright (C) 2004 Red Hat, Inc.
Copyright (C) 2003 CodeFactory AB
Copyright (C) 2002, 2003 CodeFactory AB
Copyright (C) 2002, 2003 Red Hat Inc.
Copyright (C) 2002 Red Hat Inc.
Copyright (C) 1994-1996, 1999-2002, 2004-2016 Free Software Foundation, Inc.
Copyright (C) 2002 Red Hat Inc.
Copyright (C) 2006 Red Hat, Inc.
Copyright © 2011 Nokia Corporation
Copyright (C) 2005 Red Hat Inc.
Copyright (C) 2002, 2003, 2005 Red Hat Inc.
Copyright (C) 2005, 2008, 2010-2014 Free Software Foundation, Inc.
Copyright (C) 2010-2018 Free Software Foundation, Inc. Written by Peter Rosin <peda@lysator.liu.se>.
Copyright (C) 2004-2014, 2016 Free Software Foundation, Inc.
Copyright © 2010, 2012, 2015 Guillem Jover <guillem@debian.org>
Copyright © 2011 Guillem Jover <guillem@debian.org>
Copyright © 2010 Guillem Jover <guillem@debian.org>
Copyright © 1994, 1995 Ian Jackson <ijackson@chiark.greenend.org.uk>
Copyright © 2008-2012 Guillem Jover <guillem@debian.org>
Copyright © 2008-2014 Guillem Jover <guillem@debian.org>
Copyright © 2004 Scott James Remnant <scott@netsplit.com>
Copyright © 2011-2014 Guillem Jover <guillem@debian.org>
Copyright © 1995 Bruce Perens
Copyright © 1995 Ian Jackson <ijackson@chiark.greenend.org.uk>
Copyright © 2012-2013 Guillem Jover <guillem@debian.org>
Copyright © 2015-2016 Guillem Jover <guillem@debian.org>
Copyright © 2008-2010 Guillem Jover <guillem@debian.org>
Copyright © 2007 Canonical, Ltd. written by Ian Jackson <ijackson@chiark.greenend.org.uk>

LICENCE TERMS (cont.)

Copyright © 2010-2012 Guillem Jover <guillem@debian.org>
Copyright © 2009, 2010 Guillem Jover <guillem@debian.org>
Copyright © 2008-2012, 2015 Guillem Jover <guillem@debian.org>
Copyright © 2009-2015 Guillem Jover <guillem@debian.org>
Copyright © 2008-2015 Guillem Jover <guillem@debian.org>
Copyright © 2009,2011-2012 Guillem Jover <guillem@debian.org>
Copyright © 2009-2010 Guillem Jover <guillem@debian.org>
Copyright © 2018 Guillem Jover <guillem@debian.org>
Copyright © 2009 Guillem Jover <guillem@debian.org>
Copyright © 1999, 2000 Wichert Akkerman <wakkerma@debian.org>
Copyright © 2001 Wichert Akkerman <wakkerma@debian.org>
Copyright © 2011 Linaro Limited
Copyright © 2013-2015 Guillem Jover <guillem@debian.org>
Copyright © 2011-2015 Guillem Jover <guillem@debian.org>
Copyright © 1994, 1995 Ian Jackson <ijackson@chiark.greenend.org.uk>
Copyright © 2009-2014 Guillem Jover <guillem@debian.org>
Copyright © 2013 Guillem Jover <guillem@debian.org>
Copyright © 2017 Guillem Jover <guillem@debian.org>
Copyright © Colin Watson <cjwatson@debian.org>
Copyright © 2009-2010 Modestas Vainius <modax@debian.org>
Copyright © 2007 Raphaël Hertzog <hertzog@debian.org>
Copyright © 2007-2010 Raphaël Hertzog <hertzog@debian.org>
Copyright © 2002 Adam Heath <doogie@debian.org>
Copyright © 2014 Guillem Jover <guillem@debian.org>
Copyright © 2006 Frank Lichtenheld <djpig@debian.org>
Copyright © 2011 Raphaël Hertzog <hertzog@debian.org>
Copyright © 2007, 2016 Raphaël Hertzog <hertzog@debian.org>
Copyright © 2014-2015 Guillem Jover <guillem@debian.org>
Copyright © 1998 Richard Braakman
Copyright © 2005, 2007 Frank Lichtenheld <frank@lichtenheld.de>
Copyright © 2009 Raphaël Hertzog <hertzog@debian.org>
Copyright © 2009 Raphaël Hertzog <hertzog@debian.org>
Copyright © 2008 Ian Jackson <ijackson@chiark.greenend.org.uk>
Copyright © 2009-2011 Raphaël Hertzog <hertzog@debian.org>
Copyright © 2008-2010 Raphaël Hertzog <hertzog@debian.org>
Copyright © 2008-2010 Raphaël Hertzog <hertzog@debian.org>
Copyright © 2000 Joey Hess <joeyh@debian.org>
Copyright © 2007 Frank Lichtenheld <djpig@debian.org>
Copyright © 2012 Guillem Jover <guillem@debian.org>
Copyright © 2016 Guillem Jover <guillem@debian.org>
Copyright © 2007-2009 Raphaël Hertzog <hertzog@debian.org>
Copyright © 2008-2009 Raphaël Hertzog <hertzog@debian.org>
Copyright © 2006-2015 Guillem Jover <guillem@debian.org>
Copyright © 2010-2011 Raphaël Hertzog <hertzog@debian.org>
Copyright © 2010 Raphaël Hertzog <hertzog@debian.org>
Copyright © 2006-2009, 2012-2015 Guillem Jover <guillem@debian.org>
Copyright © 2008-2011 Raphaël Hertzog <hertzog@debian.org>
Copyright © 2007 Colin Watson <cjwatson@debian.org>
Copyright © 2008-2012 Raphaël Hertzog <hertzog@debian.org>
Copyright © 2007,2010 Joey Hess <joeyh@debian.org>
Copyright © 2008 Raphaël Hertzog <hertzog@debian.org>
Copyright © 2008 Raphaël Hertzog <hertzog@debian.org>
Copyright © 2008-2010, 2012-2015 Guillem Jover <guillem@debian.org>
Copyright © 2008 Frank Lichtenheld <djpig@debian.org>
Copyright © 2009-2010 Raphaël Hertzog <hertzog@debian.org>
Copyright © 2008-2009 Raphaël Hertzog <hertzog@debian.org>
Copyright © 2007-2011 Raphaël Hertzog <hertzog@debian.org>

Copyright © 2007-2009 Raphaël Hertzog <hertzog@debian.org>
Copyright © 1996 Ian Jackson
Copyright © 2010 Raphaël Hertzog <hertzog@debian.org>
Copyright © 2007-2009,2012-2013 Guillem Jover <guillem@debian.org>
Copyright (c) 1997-2000 Thai Open Source Software Center Ltd
Copyright (C) 2000-2002, 2004 Free Software Foundation, Inc.
Copyright (C) 2000-2002 Free Software Foundation, Inc
Copyright (C) 1991, 1999 Free Software Foundation, Inc.
Copyright (C) 1995-1999, 2000-2001, 2003 Free Software Foundation, Inc. Written by Ulrich Drepper <drepper@gnu.org>, 1995.
Copyright (c) 2003,2004 Cluster File Systems, Inc, info@clusterfs.com Written by Alex Tomas <alex@clusterfs.com>
Copyright (C) 1995, 2000-2003 Software Foundation, Inc.
Copyright (C) 1993, 1994, 1995, 1996 Theodore Ts'o.
Copyright (C) 1995-1997, 2000-2003 Free Software Foundation, Inc.
Copyright (C) 2000-2003 Free Software Foundation, Inc. Written by Ulrich Drepper <drepper@cygnus.com>, 2000.
Copyright (C) 1995-1999, 2000-2003 Free Software Foundation, Inc.
Copyright (C) 1996-2001,2003 Free Software Foundation, Inc.
Copyright (C) 1999, 2002-2003 Free Software Foundation, Inc.
Copyright (C) 1992, 1993, 1994, 1995 Remy Card (card@masi.ibp.fr)
Copyright (C) 2001-2002 Free Software Foundation, Inc.
Copyright 1987, 1988 by MIT Student Information Processing Board
Copyright (C) 2000-2001, 2003 Free Software Foundation, Inc. Written by Ulrich Drepper <drepper@cygnus.com>, 2000.
Copyright (C) Andrew Tridgell 1999-2004
Copyright (C) 2002-2003 Free Software Foundation, Inc.
Copyright 1996-2014 Free Software Foundation, Inc. Taken from GNU libtool, 2001 Originally by Gordon Matzigkeit <gord@gnu.ai.mit.edu>, 1996
Copyright (C) 2000 Free Software Foundation, Inc.
Copyright (C) 1995-1998, 2000-2003 Free Software Foundation, Inc.
Copyright (C) 2003 Free Software Foundation, Inc. Written by Bruno Haible <bruno@clisp.org>, 2003.
Copyright (C) 1995, 1997, 2000-2003 Free Software Foundation, Inc.
Copyright (C) 1995, 1997-1998, 2000-2003 Free Software Foundation, Inc.
Copyright 1988, Student Information Processing Board of the Massachusetts Institute of Technology.
Copyright (C) 2003 Free Software Foundation, Inc.
Copyright (C) 1995, 1997, 2000-2002, 2004 Free Software Foundation, Inc.
Copyright (C) 2000-2003 Free Software Foundation, Inc.
Copyright (C) 1996-1999, 2000-2003 Free Software Foundation, Inc. This file is part of the GNU C Library.
Contributed by Ulrich Drepper <drepper@cygnus.com>, 1996.
Copyright (C) 1995-1999, 2000-2001, 2003 Free Software Foundation, Inc.
Copyright (C) 2010 Red Hat, Inc., Lukas Czermer <lczermer@redhat.com>
Copyright (C) 2000-2003 Free Software Foundation, Inc. This file is part of the GNU CHARSET Library.
(C) 2000 Andreas Gruenbacher, <a.gruenbacher@computer.org>
Copyright (C) 1995-1998, 2000-2001, 2003 Free Software Foundation, Inc. Contributed by Ulrich Drepper <drepper@gnu.ai.mit.edu>, 1995.
Copyright 1996-2003 Free Software Foundation, Inc. Taken from GNU libtool, 2001 Originally by Gordon Matzigkeit <gord@gnu.ai.mit.edu>, 1996
Copyright (C) 1996-2018 Free Software Foundation, Inc.
Copyright 1985, 1986, 1988, 1990, 1991, 1992, 1993, 1994, 1995, 1996, 1997, 1998, 1999, 2000, 2001, 2002, 2003, 2004, 2005, 2006, 2007, 2008, 2009, 2010, 2011, 2012, 2013, 2014, 2015, 2016, 2017, 2018 Free Software Foundation, Inc.
Copyright (C) 1995-2018 Free Software Foundation, Inc. written by Ulrich Drepper <drepper@gnu.ai.mit.edu>, June 1995
Copyright (c) 2010, Oracle America, Inc.
Copyright (C) 1996-2019 Julian Seward <jseward@acm.org>
Copyright (C) 2009 Andreas Gruenbacher <agruen@suse.de>
Copyright (c) 2001-2002 Silicon Graphics, Inc. All Rights Reserved.
Copyright (c) 2001-2002,2004 Silicon Graphics, Inc. All Rights Reserved.

LICENCE TERMS (cont.)

Copyright (C) 2005-2014 Free Software Foundation, Inc.
Copyright (C) 2003 Free Software Foundation, Inc.
Copyright (C) 2002-2003 Free Software Foundation, Inc.
Copyright (C) 1997-2004 Free Software Foundation, Inc.
Copyright (C) 1997-2002, 2006 Free Software Foundation, Inc.
Copyright (C) 2001-2002 Free Software Foundation, Inc.
Copyright (C) 2005 Free Software Foundation, Inc.
Copyright (C) 2003-2004 Free Software Foundation, Inc.
Copyright (C) 2002 Free Software Foundation, Inc.
Copyright (C) 2002-2003, 2006 Free Software Foundation, Inc.
Copyright (C) 1997-2002 Free Software Foundation, Inc.
Copyright (C) 1995-2002 Free Software Foundation, Inc.
Copyright (C) 1999-2004 Free Software Foundation, Inc.
Copyright (C) 2003, 2005-2006 Free Software Foundation, Inc.
Copyright (C) 2002-2005 Free Software Foundation, Inc.
Copyright (C) 1995-2002, 2004-2005 Free Software Foundation, Inc.
Copyright (c) 2012, 2014, 2018 Anthony Green
Copyright (C) 2004-2014 Free Software Foundation, Inc.
Copyright 1996-2013 Free Software Foundation, Inc. Taken from GNU libtool, 2001 Originally by Gordon Matzigkeit <gord@gnu.ai.mit.edu>, 1996
Copyright (C) 2000-2002, 2006, 2008-2014 Free Software Foundation, Inc.
Copyright (C) 2004-2013 Free Software Foundation, Inc.
Copyright (c) 2010, Oracle America, Inc. All rights reserved.
Copyright (c) 2009, Sun Microsystems, Inc. All rights reserved.
Copyright (c) 2009, Sun Microsystems, Inc. All rights reserved.
Copyright (c) 1986 - 1991, 1994, 1996, 1997 by Sun Microsystems, Inc. All rights reserved.
Copyright (c) 2015, Axentia Technologies AB. All rights reserved.
Copyright (c) 1996 Bill Paul <wpaul@ctr.columbia.edu>. All rights reserved.
Copyright (C) 2000-2002, 2006, 2008-2014, 2016 Free Software Foundation, dnl Inc.
Copyright (C) 1995-2002, 2004-2005, 2008-2014, 2016 Free Software dnl Foundation, Inc.
Copyright (C) 1997-2002 Free Software Foundation, Inc.
Copyright (C) 2000-2002 Free Software Foundation, Inc.
Copyright (C) 2002 Free Software Foundation, Inc.
Copyright (C) 1995-2002 Free Software Foundation, Inc.
Copyright (C) 1999-2002 Free Software Foundation, Inc.
(C) 1998-2000 Red Hat, Inc.
Copyright 1995-2019 The OpenSSL Project Authors. All Rights Reserved.
Copyright 1995-2020 The OpenSSL Project Authors. All Rights Reserved.
Copyright 2006-2018 The OpenSSL Project Authors. All Rights Reserved.
Copyright 2016-2018 The OpenSSL Project Authors. All Rights Reserved.
Copyright 2015-2018 The OpenSSL Project Authors. All Rights Reserved.
Copyright 1995-2018 The OpenSSL Project Authors. All Rights Reserved.
Copyright 2000-2018 The OpenSSL Project Authors. All Rights Reserved.
Copyright 2004-2018 The OpenSSL Project Authors. All Rights Reserved.
Copyright 1995-2017 The OpenSSL Project Authors. All Rights Reserved.
Copyright 2000-2016 The OpenSSL Project Authors. All Rights Reserved.
Copyright 1995-2016 The OpenSSL Project Authors. All Rights Reserved.
Copyright 2000-2019 The OpenSSL Project Authors. All Rights Reserved.
Copyright 2005-2016 The OpenSSL Project Authors. All Rights Reserved.
Copyright 2001-2018 The OpenSSL Project Authors. All Rights Reserved.
Copyright 2010-2016 The OpenSSL Project Authors. All Rights Reserved.
Copyright 1995-2019 The OpenSSL Project Authors. All Rights Reserved.
Copyright 2008-2019 The OpenSSL Project Authors. All Rights Reserved.
Copyright 2016-2019 The OpenSSL Project Authors. All Rights Reserved.
Copyright 2011-2016 The OpenSSL Project Authors. All Rights Reserved.
Copyright 2002-2016 The OpenSSL Project Authors. All Rights Reserved.
Copyright 1999-2016 The OpenSSL Project Authors. All Rights Reserved.

Copyright 1995-2019 The OpenSSL Project Authors. All Rights Reserved.
Copyright 1999-2019 The OpenSSL Project Authors. All Rights Reserved.
Copyright 2008-2016 The OpenSSL Project Authors. All Rights Reserved.
Copyright 1995-2016 The OpenSSL Project Authors. All Rights Reserved.
Copyright 2017-2018 The OpenSSL Project Authors. All Rights Reserved.
Copyright (c) 1998-2002,2003 Free Software Foundation, Inc. *
Copyright (C) 1993, 1994, 1996, 1997, 1998, 1999, 2000, 2001, 2002, 2004, 2005, 2006, 2007, 2008 by Larry Wall and others;
Copyright (C) 1991, 1992, 1993, 1999, 2001, 2002, 2003, 2004, 2005, 2007, by Larry Wall and others
Copyright (C) 1991, 1992, 1993, 1994, 1995, 1996, 1997, 1998, 1999, 2000, 2001, 2002, 2003, 2004, 2005, 2006, 2007, 2008, 2009 by Larry Wall and others
Copyright (C) 1993, 1994, 1995, 1996, 1997, 1998, 1999, 2000, 2001, 2002, 2003, 2004, 2005, 2006, 2007, 2008, 2009 by Larry Wall and others
Copyright (C) 2001, 2002, 2003, 2005, 2006, 2007, 2009, 2010, 2011 by Larry Wall, Nick Ing-Simmons, and others;
Copyright (C) 2007, 2011 by Larry Wall and others
Copyright (C) 1991, 1992, 1993, 1996, 1997, 1998, 1999, 2000, 2001, 2002, 2003, 2005, 2006, 2007, 2008, by Larry Wall and others
Copyright (C) 1991, 1992, 1993, 1994, 1995, 1996, 1997, 1998, 1999, 2000, 2001, 2002, 2003, 2004, 2005, 2006, 2007, 2008, 2009 by Larry Wall and others
copyright 2004, Published by O'Reilly Media, Inc.
Copyright (C) 2000, 2001, 2002, 2005, 2006, 2007, 2009, 2010, 2011 by Larry Wall and others
Copyright (c) 2000
Copyright (C) 1993, 1994, 1996, 1997, 1998, 1999, 2000, 2001, 2002, 2007, by Larry Wall and others
Copyright (C) 1994, 1995, 1996, 1997, 1998, 1999, 2000, 2001, 2002, 2003, 2004, 2005, 2006, 2007, 2008 by Larry Wall and others
Copyright (C) 2012 by Larry Wall and others
Copyright (C) 2015 by Larry Wall and others
Copyright 1998 The Perl Journal.
Copyright (C) 1989 Free Software Foundation, Inc.
Copyright (C) 1991, 1992, 1993, 1994, 1995, 1996, 1997, 1998, 1999, 2000, 2001, 2002, 2003, 2005, 2006, 2007, by Larry Wall and others
Copyright (C) 1994, 1995, 1996, 1997, 1999, 2000, 2001, 2002, 2005, 2006, 2007 by Larry Wall and others
Copyright (C) 1991, 1992, 1993, 1994, 1995, 1996, 1997, 1998, 1999, 2000, 2001, 2002, 2003, 2004, 2005, 2006, 2007, 2008 by Larry Wall and others
Copyright (C) 1997, 1998, 2000, 2001, 2005, 2006, 2007, 2011 by Larry Wall and others
Copyright (C) 2008, 2010, 2011 by Larry Wall and others
Copyright (c) 1995 Your Name. All rights reserved. This program is free software
Copyright (C) 1991, 1992, 1993, 2000, 2004, 2011 by Larry Wall and others
Copyright (C) 1999, 2000, 2001, 2002, 2003, 2004, 2005, 2006, by Larry Wall and others
Copyright (C) 1991, 1992, 1993, 1994, 1995, 1996, 1998, 1999, 2000, 2001, 2002, 2003, 2004, 2005, 2006, 2007, 2008 by Larry Wall and others
Copyright 2006 Yves Orton and 2007 E<AElig>var ArnfE<ouml>rE<eth> Bjarmason.
Copyright © 2012 Tom Christiansen.
Copyright (C) 2012 by Larry Wall and others
Copyright (C) 1993, 1994, 1995, 1996, 1997, 1998, 1999, 2000, 2001 2002, 2003, 2004, 2005, 2006, 2007, 2008, 2009 by Larry Wall and others
Copyright (C) 1993, 1994, 1995, 1996, 1997, 1998, 1999, 2000, 2001, 2002, 2003, 2004, 2005, 2006, 2007 by Larry Wall and others
Copyright (C) 2010, 2011 by Larry Wall and others
Copyright (C) 1984, 1989-1990, 2000-2015, 2018 Free Software Foundation, Inc.
Copyright (c) 2008
Copyright (C) 1991, 1992, 1993, 1994, 1995, 1996, 1997, 1999, 2000, 2001, 2002, 2003, 2004, 2005, 2006, 2007, 2008 by Larry Wall and others
Copyright (C) 1991, 1992, 1993, 1995, 1996, 1998, 2000, 2001, by Larry Wall and others
Copyright (C) 1997, 1998, 1999, 2000, 2001, 2002, 2003, 2004, 2005, 2006, 2007, 2008 by Larry Wall and others
Copyright (C) 1996, 1997, 1998, 1999, 2000, 2001, 2002, 2003, 2006, 2007, 2008 by Larry Wall and others
Copyright (c) 2006, 2007, 2009, 2010, 2011 Larry Wall and others

LICENCE TERMS (cont.)

Copyright (C) 1991, 1992, 1993, 1994, 1995, 1996, 1997, 1999, 2000, 2001, 2002, 2004, 2005, 2006, 2007, 2008, 2012 by Larry Wall and others
Copyright (C) 1999, 2000, 2001, 2002, 2003, 2004, 2005, 2006, 2007, by Larry Wall and others
Copyright (C) 1991, 1992, 1993, 1994, 1995, 1996, 1997, 1999, 2000, 2002, 2005, 2006, 2007, 2008 by Larry Wall and others
Copyright (C) 1996, 2000, 2001, 2005, by Larry Wall and others
Copyright (C) 1996, 1997, 1999, 2000, 2001, 2002, 2003, 2004, 2005, 2006, 2007, by Larry Wall and others
Copyright (C) 1991, 1992, 1993, 1995, 1996, 1997, 1998, 1999, 2000, 2001, 2002, 2005, 2006, 2007, 2008, by Larry Wall and others
Copyright (C) 2002, 2003, 2005, 2006, 2007 by Larry Wall and others
Copyright (C) 1993, 1994, 1995, 1996, 1997, 1999, 2000, 2001, 2002, 2003, 2006, 2007, by Larry Wall and others
Copyright (C) 1993, 1995, 1996, 1997, 1998, 1999, 2000, 2001, 2002, 2003, 2004, 2005, 2006, 2007, 2008, 2009, by Larry Wall and others
Copyright (C) 2002, 2003, 2005, 2006, 2007, 2008, 2009, 2010, 2011 by Larry Wall and others
Copyright (C) 2000, by Larry Wall and others
Copyright (C) 1993, 1994, 1996, 1997, 1999, 2000, 2001, 2003, 2005, 2006, 2007, 2008 by Larry Wall and others
Copyright 2013-2014, Niels Thykier E<lt>niels@thykier.netE<gt>
Copyright 2009, Paul Fenwick E<lt>pjf@perltraining.com.auE<gt>
Copyright 2013, Paul Fenwick <pjf@cpan.org>
Copyright 2008-2009, Paul Fenwick E<lt>pjf@perltraining.com.auE<gt>
Copyright 2013, Niels Thykier E<lt>niels@thykier.netE<gt>
Copyright (C)2008 Paul Fenwick
Copyright (C) 1993, 1994, 1995, 1996, 1997, 1998, 1999, 2000, 2001, 2002, 2003, 2004, 2005, 2006, 2007, 2008, 2009, 2011, 2012, 2013 by Larry Wall and others
copyright (c) 2016 by David Golden.
Copyright (C) 1995-2017 Jean-loup Gailly and Mark Adler
Copyright 1996, 1997, 1998, 2000, 2001, 2002, 2005, 2006, 2008, 2009, 2010, 2011, 2012, 2013, 2014, 2015, 2016 Russ Allbery <rra@cpan.org>
Copyright 1995-2015 (c) perl5 porters.
Copyright (C) 2009-2018 H.Merijn Brand
copyright 1996 by Charles Bailey.
copyright (c) 2019 by Tim Jenness and the UK Particle Physics and Astronomy Research Council.
Copyright (c) 2005 Paul Marquess. All rights reserved.
copyright 1999 The Perl Journal.
Copyright (c) 1999-2004 Sean M. Burke. All rights reserved.
Copyright (c) 1997-2007 Graham Barr <gbarr@pobox.com>. All rights reserved. This program is free software
Copyright (c) 1996-2019 Gurusamy Sarathy. All rights reserved.
Copyright 2007-2016 by Makamaka Hannyaharamitu
Copyright (c) 2000-2014, Damian Conway. All Rights Reserved.
Copyright (c) 1995-2011 Paul Marquess. All rights reserved.
Copyright (c) 1997-8 Graham Barr <gbarr@pobox.com>. All rights reserved. This program is free software
(C) Paul Evans, 2010-2015 -- leonerd@leonerd.org.uk
Copyright (c) 1996-8 Graham Barr <gbarr@pobox.com>. All rights reserved. This program is free software
Copyright (c) 2005-2019 Paul Marquess. All rights reserved.
Copyright (c) 1998-2004 Tom Hughes <tom@compton.nu>. All rights reserved. This program is free software
Copyright (c) 2014 Paul Evans <leonerd@leonerd.org.uk>. All rights reserved.
Copyright (c) 1995-2019 Paul Marquess. All rights reserved.
Copyright (c) 2001+ Sean M. Burke. All rights reserved.
Copyright 2001 by Jarkko Hietaniemi
Copyright (c) 1998-2000 Joshua Nathaniel Pritikin.
copyright (c) 2010 by David Golden, Ricardo Signes, Adam Kennedy and Contributors.
Copyright (c) 1996-2002 Douglas E. Wegscheid. All rights reserved.
copyright (c) 1997 - 2018 by Graham Barr & Dave Rolsky.
Copyright 2001, Larry Wall.
Copyright (c) 2007-2017 Max Maischein C<< <corion@cpan.org> >>
Copyright 1998-2006 Gisle Aas.
Copyright (c) 2001-2014, Damian Conway. All Rights Reserved.

Copyright (C) 2002-2009 Richard Clamp. All Rights Reserved.
Copyright (C) 2013 Chris Williams. All Rights Reserved.
Copyright (c) 1995-2018 Paul Marquess. All rights reserved. This program is free software
copyright (C) 2003 Mark Jason Dominus.
Copyright (C) 1996-2002,2005,2006 David Muir Sharnoff.
Copyright (C) 1996-2009 David Muir Sharnoff.
Copyright (c) 1997-2009 Graham Barr <gbarr@pobox.com>. All rights reserved. This program is free software
Copyright (c) 1995-2001, Raphael Manfredi
Copyright (C) 1993, 1994, 1995, 1996, 1997, 1998, 1999, 2000, 2001, 2002, 2003, 2004, 2005, 2006, 2007, 2008 by Larry Wall and others
copyright (c) 2013 by Leon Timmermans.
copyright (c) 1996- by Andreas Koenig.
Copyright 2010 Gisle Aas <gisle@aa.no>.
Copyright (C) 1994, 1995, 1996, 1997, 1999, 2000, 2001, 2002, 2003, 2004, 2005, 2006, 2007, 2016 by Larry Wall and others
Copyright (c) 2007 Brandon L Black
Copyright (C) 2000-2003 Stephen McCamant. All rights reserved.
Copyright (c) 1998-2000, 2002, 2003, 2004, 2005, 2006 Stephen McCamant. All rights reserved.
Copyright (C) 2014 by Larry Wall and others
Copyright 2000 Gisle Aas.
Copyright (C) 2006-2007 by (Anno Siegel)
Copyright (C) 1993, 1994, 1995, 1996, 1997, 1998, 1999, 2000, 2001, 2002, 2003, 2004, 2005, 2006 by Larry Wall and others
Copyright (C) 1995-2006 Graham Barr. All rights reserved.
Copyright (C) 2000 Graham Barr. All rights reserved.
Copyright (C) 1995-1997 Graham Barr. All rights reserved.
Copyright (C) 1995-2004 Graham Barr. All rights reserved.
Copyright (C) 1995-1998 Graham Barr. All rights reserved.
Copyright (C) 1996-2000 by Bradford Appleton. All rights reserved.
Copyright 1999-2002, 2004, 2006, 2008-2009, 2012-2016, 2018 Russ Allbery rra@cpan.org>
Copyright 2001, 2008, 2009, 2014, 2018 Russ Allbery <rra@cpan.org>
Copyright (C) 1999-2000 by Marek Rouchal (and borrowing code from Nick Ing-Simmon's PodToHtml). All rights reserved.
Copyright (C) 1999-2000 by Marek Rouchal. All rights reserved.
Copyright (c) 2002 Sean M. Burke. All rights reserved.
Copyright (c) 2011 Mark Allen. All rights reserved.
Copyright (c) 2002-2007 Sean M. Burke.
Copyright (c) 2017 Mark Allen.
Copyright (c) 2011 brian d foy. All rights reserved.
Copyright (c) 1996-2000 by Bradford Appleton. All rights reserved.
Copyright (c) 2002 Sean M. Burke.
Copyright 1999, 2001-2002, 2004, 2006, 2008-2009, 2014-2015, 2018 Russ Allbery rra@cpan.org>
Copyright 1999, 2001, 2004, 2006, 2008, 2009, 2018 Russ Allbery rra@cpan.org>
Copyright 2000 by Joe Smith <Joe.Smith@inwap.com>
Copyright (c) 2002-2004 Sean M. Burke.
Copyright (c) 2004 Sean M. Burke.
Copyright (c) 2003-2005 Allison Randal.
Copyright (C) 1994-2000 by Bradford Appleton. All rights reserved.
Copyright 1999-2010, 2012-2018 Russ Allbery <rra@cpan.org>
Copyright 1999-2000 by Russ Allbery <rra@stanford.edu>
Copyright (c) 2001-2004 Sean M. Burke. All rights reserved.
Copyright 1998, 1999, 2000, 2001, 2012 M. J. Dominus.
Copyright (c) 1995 Graham Barr & Nick Ing-Simmons. All rights reserved. This program is free software
© Randy Sims Tomohiro Hosaka
copyright (c) 2010 by David Golden and Ricardo Signes.
copyright (c) 2010 by Adam Kennedy.
Copyright 1990,2015 by Johan Vromans.

LICENCE TERMS (cont.)

Copyright (C) 2008 by Larry Wall and others
Copyright 2003 by Fergal Daly <fergal@esatclear.ie>.
copyright 2005 Fergal Daly <fergal@esatclear.ie>, some parts are based on other people's work.
Copyright (c) 1996 by Eryq. All rights reserved.
Copyright Mark Fowler E<lt>mark@twoshortplanks.comE<gt> 2002.
Copyright Mark Fowler E<lt>mark@twoshortplanks.comE<gt> 2002, 2004.
Copyright (c) 1996, 1997, 1998 Malcolm Beattie
Copyright (C) 2003-2018 Mark Shelor
Copyright(C) 2001-2012, SADAHIRO Tomoyuki. Japan. All rights reserved.
Copyright(C) 2001-2018, SADAHIRO Tomoyuki. Japan. All rights reserved.
Copyright(C) 2004-2018, SADAHIRO Tomoyuki. Japan. All rights reserved.
Copyright 2017 Unicode, Inc.
Copyright (C) 2007-2013, Marcus Holland-Moritz <mhx@cpan.org>.
Copyright (c) 1995-98 Ilya Zakharevich. All rights reserved.
Copyright (C) 2004-2013, Marcus Holland-Moritz.
Copyright (C) 2002 Your Name <your@address.domain>
Copyright (C) 1999, 2000, 2001, 2002, 2003, 2004, 2005, 2006, 2007, 2008 by Larry Wall and others
copyright (c) 2002 by Ilya Zakharevich.
Copyright (C) 1991, 1992, 1993, 1995, 1996, 1997, 1998, 1999, 2000, 2001, by Larry Wall and others
Copyright (C) 2005-2010 Gregory P. Smith (greg@krypto.org)
Copyright 2007 Google, Inc. All Rights Reserved.
Copyright (C) 2004-2005 Gerhard Häring <gh@ghaering.de>
Copyright (C) 2005 Gerhard Häring <gh@ghaering.de>
Copyright (C) 2005-2007 Gerhard Häring <gh@ghaering.de>
Copyright (C) 2004-2010 Gerhard Häring <gh@ghaering.de>
Copyright (C) 2006-2007 Gerhard Häring <gh@ghaering.de>
Copyright 1994 by Lance Ellinghouse Cathedral City, California Republic, United States of America.
Copyright (c) 1998-2001 by Secret Labs AB. All rights reserved.
Copyright (C) 1999-2001 Gregory P. Ward.
Copyright (c) 2006-2008, R Oudkerk Licensed to PSF under a Contributor Agreement.
copyright 2001, Autonomous Zones Industries, Inc
Copyright 2009 Brian Quinlan. All Rights Reserved.
(c) for dummy in range(8)] return ".join(letters)
Copyright 2007 Google Inc. Licensed to PSF under a Contributor Agreement.
Copyright 2001-2017 by Vinay Sajip. All Rights Reserved.
Copyright 1985, 1987, 1988 The Regents of the University of California. All rights reserved.
Copyright (C) 2018 Oracle. All Rights Reserved.
Copyright (C) 2014-2017 Karel Zak <kzak@redhat.com>
Copyright © 2009-2010 Raphaël Hertzog <hertzog@debian.org>
Copyright 2010 by Makamaka Hannyaharamitu
Copyright (C) 1998-2002 - Red Hat, Inc.
Copyright (C) 2001 Alexander S. Guy <a7r@andern.org> Andern Research Labs
Copyright © 1996 Ian Jackson <ijackson@chiark.greenend.org.uk>
Copyright (C) 1994-2018 Free Software Foundation, Inc.
Copyright (C) 1998, 2002, 2006, 2007 Free Software Foundation
Copyright (C) %s The elfutills developers <%s>.
Copyright (C) 2002-2004 Python Software Foundation
Copyright (C) 1996-2018 Free Software Foundation, Inc.
Copyright (c) 2011-2018 Paul Marquess. All rights reserved.
Copyright (C) 1998, 2001, 2002, 2006, 2007 Free Software Foundation
Copyright (C) 2001-2010 Python Software Foundation Contact
Copyright (C) %s Free Software Foundation, Inc.
Copyright © 1995,1996 Erick Branderhorst <branderh@debian.org>.
Copyright (C) 1998, 2002, 2006, 2007 Free Software Foundation
Copyright (C) %s Free Software Foundation, Inc.
Copyright (c) 2014 Intel Corp.
Copyright (c) 2006-7 Paul Sokolovsky

Copyright (C) 2006 Red Hat, Inc.
Copyright (C) 2003, 2005-2007, 2011, 2015-2016 Free Software Foundation, Inc.
Copyright (C) 2002-2006 Python Software Foundation
Copyright (C) 2003-2018 Mark Shelor, All Rights Reserved
Copyright (C) 1994-1995, 1999-2003, 2005-2012 Free Software Foundation, Inc.
Copyright 1999-2001, 2004, 2006, 2008, 2010, 2012-2018 Russ Allbery rra@cpan.org>
Copyright © 1999 Roderick Schertler
Copyright © 2010-2011 Raphaël Hertzog <hertzog@debian.org>
Copyright (C) 1994, 1999-2012 Free Software Foundation, Inc.
Copyright (C) 2003, 2009-2012 Free Software Foundation, Inc.
Copyright (C) 2002, 2003 Red Hat, Inc., CodeFactory AB, and others
Copyright (C) 2014 Free Software Foundation, Inc. This is free software
Copyright %s %d Free Software Foundation, Inc.
Copyright (C) 1995-1998, 2000-2016 Free Software Foundation, Inc.
Copyright (C) 1996-2019 by Julian Seward.
Copyright (C) 1992-1994, 1996, 1998-2012 Free Software Foundation, Inc.
Copyright © 2007 Raphaël Hertzog
Copyright (C) 2001,2002 Python Software Foundation
Copyright (C) 2011-2012 Vinay Sajip.
Copyright (C) 2001, 2002, 2007 Free Software Foundation
Copyright (C) 2003-2013 Python Software Foundation
Copyright (C) 2003 Python Software Foundation
Copyright © 2001 Joey Hess <joeyh@debian.org>
Copyright (C) 2002-2016 Free Software Foundation, Inc.
Copyright (C) 1992-1994, 1996, 1999-2012 Free Software Foundation, Inc.
Copyright 1999-2018 The OpenSSL Project Authors. All Rights Reserved.
Copyright (C) 2003-2015 Free Software Foundation, Inc. This is free software
Copyright (c) 1996-2000 by Bradford Appleton. All rights reserved.
Copyright (c) 1998-2000 by Bradford Appleton. All rights reserved.
Copyright (C) 2003-2006 Red Hat, Inc.
Copyright (C) 2001 Python Software Foundation Barry Warsaw <barry@python.org>, 2000.
Copyright © 1999-2001 Marcus Brinkmann <brinkmd@debian.org>
Copyright (C) 1998-2002 - Red Hat, Inc.
Copyright (C) 2007 Red Hat, Inc.
Copyright © 2007, 2011-2015 Guillem Jover <guillem@debian.org>
Copyright (C) 2001 Carl D. Worth
Copyright (C) 2001-2003, 2005-2012 Free Software Foundation, Inc.
Copyright (C) 2003 Red Hat, Inc.
Copyright (C) 1994, 1999, 2000, 2001, 2002, 2003 Free Software Foundation, Inc.
Copyright %s %s Free Software Foundation, Inc
Copyright (c) 199Adobe Multiple Master font
Copyright (C) 2001-2018 Free Software Foundation, Inc.
Copyright (C) 2008-2018 Free Software Foundation, Inc.
Copyright (C) 1998-2018 Free Software Foundation, Inc.
Copyright (C) 2003-2018 Free Software Foundation, Inc.
Copyright (C) 2011-2012 Vinay Sajip.
Copyright (C) 2012-2018 Free Software Foundation, Inc.
(c) Copyright 2000 Guido van Rossum.
Copyright (C) 2006-2018 Free Software Foundation, Inc.
Copyright (C) 2004-2018 Free Software Foundation, Inc.
Copyright (C) 2002-2018 Free Software Foundation, Inc.
Copyright (C) 1997-2018 Free Software Foundation, Inc.
Copyright (C) 2009-2018 Free Software Foundation, Inc.
Copyright (C) 1999, 2003, 2011-2015 Free Software Foundation, Inc. Written by Thomas Tanner, 1999
Copyright (C) 1998-2000, 2004, 2006-2008, 2011-2015 Free Software Foundation, Inc. Written by Thomas Tanner, 1998
Copyright (C) 1998-2000, 2004-2008, 2010-2015 Free Software Foundation, Inc. Written by Thomas Tanner, 1998

LICENCE TERMS (cont.)

Copyright (C) 1998-2000, 2004, 2006-2008, 2011-2015 Free Software Foundation, Inc. Written by Peter O'Gorman, 1998
Copyright (C) 2003-2005, 2007, 2011-2015 Free Software Foundation, Inc. Written by Gary V. Vaughan, 2003
Copyright (C) 1992-1996, 1998-2012 Free Software Foundation, Inc.
Copyright (C) 2004-2008, 2011-2015 Free Software Foundation, Inc. Written by Gary V. Vaughan, 2004
Copyright (C) 2004, 2007, 2011-2015 Free Software Foundation, Inc. Written by Gary V. Vaughan, 2004
Copyright (C) 2004, 2007-2008, 2011-2015 Free Software Foundation, Inc. Written by Gary V. Vaughan, 2004
Copyright (C) 2004, 2006-2007, 2011-2015 Free Software Foundation, Inc. Written by Gary V. Vaughan, 2004
Copyright (C) 2004, 2011-2015 Free Software Foundation, Inc. Written by Gary V. Vaughan, 2004
Copyright (C) 1999-2001, 2004, 2007, 2011-2015 Free Software Foundation, Inc. Written by Thomas Tanner, 1999
Copyright (C) 2000, 2004, 2009, 2011-2015 Free Software Foundation, Inc. Written by Gary V. Vaughan, 2000
Copyright (C) 2001, 2004, 2006, 2011-2015 Free Software Foundation, Inc. Written by Bob Friesenhahn, 2001
Copyright (C) 2004, 2006, 2011-2015 Free Software Foundation, Inc. Written by Bob Friesenhahn, 2004
Copyright (C) 2001, 2004, 2011-2015 Free Software Foundation, Inc. Written by Bob Friesenhahn, 2001
Copyright (C) 1996-2015 Free Software Foundation, Inc. This is free software
Copyright (C) 1998-2000, 2004-2008, 2011-2015 Free Software Foundation, Inc. Written by Thomas Tanner, 1998
Copyright (C) 2004, 2011-2015 Free Software Foundation, Inc. Written by Bob Friesenhahn, 2004
Copyright (C) 1994-2018 Free Software Foundation, Inc.
Copyright (C) 2004, 2006-2008, 2011-2015 Free Software Foundation, Inc. Written by Gary V. Vaughan, 2004
Copyright (C) 2000, 2004, 2007-2009, 2011-2015 Free Software Foundation, Inc. Written by Gary V. Vaughan, 2000
Copyright (C) 1998-2000, 2004-2005, 2007-2008, 2011-2015 Free Software Foundation, Inc. Written by Thomas Tanner, 1998
Copyright (C) 1999-2001, 2004-2005, 2007, 2011-2015 Free Software Foundation, Inc. Written by Thomas Tanner, 1999
Copyright (C) 2003-2018 Free Software Foundation, Inc. Generated from Config.in; do not edit by hand.
Copyright (C) 2013-2018 Free Software Foundation, Inc.
Copyright (C) 1994-1996, 1999-2002, 2004-2012 Free Software Foundation, Inc.
Copyright (C) 1992-1994, 1996, 1999-2002, 2009-2012 Free Software Foundation, Inc.
Copyright (C) 2000-2002, 2009-2012 Free Software Foundation, Inc.
Copyright (C) 2001-2012 Free Software Foundation, Inc.
Copyright (C) 2000-2012 Free Software Foundation, Inc.
Copyright (C) 2001-2017 Vinay Sajip. All Rights Reserved.
Copyright (C) 1992-1996, 1998-2012 Free Software Foundation, Inc.
Copyright (C) 1992-1996, 1998-2001, 2003-2004, 2006, 2009-2012 Free Software Foundation, Inc.
Copyright (C) 2002, 2009-2012 Free Software Foundation, Inc.
Copyright (C) 1992-1996, 1998-2002, 2008-2012 Free Software Foundation, Inc.
Copyright (C) 2001, 2003-2012 Free Software Foundation, Inc.
Copyright (C) 1992-1996, 1998-2005, 2009-2012 Free Software Foundation, Inc.
Copyright (C) 1992-1996, 1998-2006, 2008-2012 Free Software Foundation, Inc.
Copyright (C) 2000-2002, 2004-2012 Free Software Foundation, Inc.
Copyright (C) 2011-2012 Free Software Foundation, Inc.
Copyright (C) 1988, 1999-2004, 2006, 2008-2012 Free Software Foundation, Inc.
Copyright (C) 1994, 1999-2002, 2006, 2008-2012 Free Software Foundation, Inc.
Copyright (C) 1994, 1999-2001, 2003, 2009-2012 Free Software Foundation, Inc.
Copyright (C) 2006, 2008-2012 Free Software Foundation, Inc.
Copyright (C) 2002-2012 Free Software Foundation, Inc.
Copyright (C) 2003-2012 Free Software Foundation, Inc.
Copyright (C) 2012 Free Software Foundation, Inc.
Copyright (C) 2001-2004, 2006-2007, 2009-2012 Free Software Foundation, Inc.
Copyright (C) 2003, 2006, 2009-2012 Free Software Foundation, Inc.
Copyright (C) 2002-2003, 2006, 2008-2012 Free Software Foundation, Inc.
Copyright (C) 2001-2003, 2009-2012 Free Software Foundation, Inc.
Copyright (C) 1999-2012 Free Software Foundation, Inc.
Copyright (C) 1999, 2000, 2001, 2002, 2006, 2007, 2009 Free Software Foundation, Inc.
Copyright (C) 2000-2012 Free Software Foundation, Inc.
Copyright (C) 2008-2012 Free Software Foundation, Inc.
Copyright (C) 1999-2008, 2011-2015 Free Software Foundation, Inc. Written by Thomas Tanner, 1999

Copyright (C) 2004-2007, 2011-2015 Free Software Foundation, Inc. Written by Gary V. Vaughan <gary@gnu.org>
Copyright (C) 2000-2002, 2004, 2008, 2010-2016 Free Software Foundation, Inc.
Copyright (C) 2005-2016 Free Software Foundation, Inc.
Copyright © 2004 Scott James Remnant <scott@netsplit.com>.
Copyright (C) 2003, 2007-2016 Free Software Foundation, Inc.
Copyright (C) 2002-2003, 2008-2016 Free Software Foundation, Inc.
Copyright (C) 1997-2004, 2006, 2008-2016 Free Software Foundation, Inc.
Copyright (C) 1997-2002, 2006, 2008-2016 Free Software Foundation, Inc.
Copyright (C) 2006, 2009-2016 Free Software Foundation, Inc.
Copyright (C) 2006, 2009-2014, 2016 Free Software Foundation, Inc.
Copyright (C) 2005, 2008, 2010-2016 Free Software Foundation, Inc.
Copyright (C) 2003-2004, 2008-2016 Free Software Foundation, Inc.
Copyright (C) 2002, 2007-2008, 2010-2016 Free Software Foundation, Inc.
Copyright (C) 1997-2004, 2007-2016 Free Software Foundation, Inc.
Copyright (C) 1999-2007, 2009-2016 Free Software Foundation, Inc.
Copyright (C) 2003, 2007, 2009-2016 Free Software Foundation, Inc.
Copyright 2012-2016 Free Software Foundation, Inc.
Copyright (c) 2009 Steve Grubb sgrubb@redhat.com
Copyright (C) 2003, 2005-2006, 2008-2016 Free Software Foundation, Inc.
Copyright (C) 2002-2005, 2008-2016 Free Software Foundation, Inc.
Copyright (C) 2006 Steve Langasek <vorlon@debian.org>
Copyright (C) 2002, 2015-2016 Free Software Foundation, Inc.
Copyright (C) 1995-1998, 2000-2002, 2004-2006, 2009-2016 Free Software Foundation, Inc.
Copyright (C) 1995-2016 Free Software Foundation, Inc.
Copyright (C) 2000, 2015-2016 Free Software Foundation, Inc.
Copyright (C) 2003-2006, 2008-2016 Free Software Foundation, Inc. Written by Bruno Haible <bruno@clisp.org>, 2003.
Copyright (C) 2004-2007, 2015-2016 Free Software Foundation, Inc.
Copyright (C) 1999, 2002-2016 Free Software Foundation, Inc.
Copyright (C) 2002-2004, 2012, 2015-2016 Free Software Foundation, Inc.
Copyright (C) 2001-2002, 2006, 2015-2016 Free Software Foundation, Inc.
Copyright (C) 2000-2003, 2015 Free Software Foundation, Inc.
Copyright (C) 1984, 1989-1990, 2000-2015 Free Software Foundation, Inc.
Copyright (C) 2005-2006, 2009-2016 Free Software Foundation, Inc.
Copyright (C) 1995-2016 Free Software Foundation, Inc. Contributed by Ulrich Drepper <drepper@gnu.ai.mit.edu>, 1995.
Copyright (C) 1995-1997, 2000, 2006, 2015-2016 Free Software Foundation, Inc. Contributed by Bernd Schmidt <crux@Pool.Informatik.RWTH-Aachen.DE>, 1997.
Copyright (C) 2000-2006, 2008-2015 Free Software Foundation, Inc.
Copyright (C) 2005-2008, 2015-2016 Free Software Foundation, Inc.
Copyright (C) 2000-2016 Free Software Foundation, Inc. Written by Ulrich Drepper <drepper@cygnus.com>, 2000.
Copyright (C) 1995-2016 Free Software Foundation, Inc. Written by Ulrich Drepper <drepper@cygnus.com>, 1995.
Copyright (C) 1999-2000, 2002-2003, 2006-2008, 2011, 2015-2016 Free Software Foundation, Inc.
Copyright (C) 1999, 2002-2003, 2005, 2007, 2010-2011, 2015-2016 Free Software Foundation, Inc.
Copyright (C) 2000-2004, 2006-2015 Free Software Foundation, Inc.
Copyright (C) 2006, 2015-2016 Free Software Foundation, Inc. Written by Bruno Haible <bruno@clisp.org>, 2006.
Copyright (C) 1995-1998, 2000-2007, 2009-2016 Free Software Foundation, Inc.
Copyright (C) 1999, 2002-2003, 2005-2007, 2015-2016 Free Software Foundation, Inc.
Copyright (C) 2005-2009, 2015-2016 Free Software Foundation, Inc.
Copyright (C) 2009, 2015-2016 Free Software Foundation, Inc. Written by Bruno Haible <bruno@clisp.org>, 2009.
Copyright (C) 2003, 2006-2007, 2009-2011, 2015-2016 Free Software Foundation, Inc. Written by Bruno Haible <bruno@clisp.org>, 2003.
Copyright (C) 2002-2003, 2015-2016 Free Software Foundation, Inc.
Copyright (C) 1996-2001, 2003, 2007, 2015 Free Software Foundation, Inc.
Copyright (C) 2001-2002, 2015-2016 Free Software Foundation, Inc.
Copyright (C) 2003, 2005, 2008, 2015-2016 Free Software Foundation, Inc. Written by Bruno Haible <bruno@clisp.org>, 2003.

LICENCE TERMS (cont.)

Copyright (C) 1999, 2002-2003, 2006-2007, 2011, 2015-2016 Free Software Foundation, Inc.
Copyright (C) 2006, 2015-2016 Free Software Foundation, Inc.
Copyright (C) 2005, 2015-2016 Free Software Foundation, Inc.
Copyright (C) 1995-2016 Free Software Foundation, Inc.
Copyright (C) 1995-1997, 2000-2016 Free Software Foundation, Inc.
Copyright (C) 2003, 2008-2016 Free Software Foundation, Inc.
Copyright (C) 1995, 2000-2003, 2005, 2015-2016 Free Software Foundation, Inc.
Copyright (C) 1995-2016 Free Software Foundation, Inc. This file is part of the GNU C Library.
Copyright (C) 1996-2016 Free Software Foundation, Inc. This file is part of the GNU C Library. Contributed by Ulrich Drepper <drepper@cygnus.com>, 1996.
Copyright (C) 1995-2016 Free Software Foundation, Inc. Written by Ulrich Drepper <drepper@gnu.org>, 1995.
Copyright (C) 2003, 2005, 2009, 2015-2016 Free Software Foundation, Inc.
Copyright (C) 1995-2016 Free Software Foundation, Inc. Contributed by Ulrich Drepper <drepper@gnu.ai.mit.edu>, 1995.
Copyright (C) 2000-2003, 2007, 2015-2016 Free Software Foundation, Inc.
Copyright (C) 1995-2007 Free Software Foundation, Inc. dnl This file is free software
Copyright 2007 Google, Inc. All Rights Reserved.
Copyright (C) 2000-2002, 2007 Free Software Foundation, Inc.
Copyright (C) 2005-2007 Free Software Foundation, Inc.
Copyright (C) 2001-2005 Free Software Foundation, Inc.
Copyright (C) 2003, 2007 Free Software Foundation, Inc.
Copyright (C) 1997-2004, 2006 Free Software Foundation, Inc.
Copyright 2012-2013 by Larry Hastings. Licensed to the PSF under a contributor agreement.
Copyright (C) 1995-2007 Free Software Foundation, Inc.
Copyright (C) 1996-2003, 2005 Free Software Foundation, Inc.
Copyright (C) 2006 Free Software Foundation, Inc.
Copyright (C) 2004-2007 Free Software Foundation, Inc.
Copyright (C) 1995-2003, 2005-2006 Free Software Foundation, Inc.
Copyright (C) 2002, 2007 Free Software Foundation, Inc.
Copyright (C) 1996-2003 Free Software Foundation, Inc.
Copyright (C) 1997-2004, 2007 Free Software Foundation, Inc.
Copyright (C) 1999-2007 Free Software Foundation, Inc.
Copyright (C) 2001-2007 Free Software Foundation, Inc.
Copyright (C) 2000-2002, 2006 Free Software Foundation, Inc.
Copyright (C) 1995, 1997-1998, 2000-2003, 2005 Free Software Foundation, Inc.
Copyright (C) 2003-2006 Free Software Foundation, Inc. Written by Bruno Haible <bruno@clisp.org>, 2003
Copyright (C) 2004-2006 Free Software Foundation, Inc.
Copyright (C) 1999, 2002-2007 Free Software Foundation, Inc.

Copyright (C) 2002-2004 Free Software Foundation, Inc.
Copyright (C) 2001-2002, 2006 Free Software Foundation, Inc.
Copyright (C) 1984, 1989, 1990, 2000, 2001, 2002, 2003, 2004, 2005, 2006 Free Software Foundation, Inc.
Copyright (C) 1995-1999, 2000-2006 Free Software Foundation, Inc. Contributed by Ulrich Drepper <drepper@gnu.ai.mit.edu>, 1995.
Copyright (C) 1995, 1996, 1997, 2000, 2006 Free Software Foundation, Inc. Contributed by Bernd Schmidt <crux@Pool.Informatik.RWTH-Aachen.DE>, 1997.
Copyright (C) 2000-2006 Free Software Foundation, Inc.
Copyright (C) 2005-2007 Free Software Foundation, Inc.
Copyright (C) 1995-1999, 2000-2001, 2003, 2005-2006 Free Software Foundation, Inc.
Copyright (C) 2000-2001, 2003, 2005-2006 Free Software Foundation, Inc. Written by Ulrich Drepper <drepper@cygnus.com>, 2000.
Copyright (C) 1995-1998, 2000-2003, 2005-2006 Free Software Foundation, Inc.
Copyright (C) 1995-1999, 2000-2007 Free Software Foundation, Inc. Written by Ulrich Drepper <drepper@cygnus.com>, 1995.
Copyright (C) 1999-2000, 2002-2003, 2006-2007 Free Software Foundation, Inc.
Copyright (C) 2000-2001, 2003, 2005-2007 Free Software Foundation, Inc. Written by Ulrich Drepper <drepper@cygnus.com>, 2000.

Copyright (C) 2000-2004, 2006 Free Software Foundation, Inc.
Copyright (C) 2006 Free Software Foundation, Inc. Written by Bruno Haible <bruno@clisp.org>, 2006.
Copyright (C) 1995-1998, 2000-2007 Free Software Foundation, Inc.
Copyright (C) 2005-2006 Free Software Foundation, Inc.
Copyright (C) 1995-1999, 2000-2007 Free Software Foundation, Inc.
Copyright (C) 1999, 2002-2003, 2005-2007 Free Software Foundation, Inc.
Copyright (c) 2001-2006 Twisted Matrix Laboratories.
Copyright (C) 2003, 2006-2007 Free Software Foundation, Inc. Written by Bruno Haible <bruno@clisp.org>, 2003.
Copyright (C) 1996-2001,2003,2007 Free Software Foundation, Inc.
Copyright (C) 2003, 2005 Free Software Foundation, Inc. Written by Bruno Haible <bruno@clisp.org>, 2003.
Copyright (c) 2004 Python Software Foundation. All rights reserved.
Copyright (C) 1999, 2002-2003, 2006-2007 Free Software Foundation, Inc.
Copyright (C) 2006 Free Software Foundation, Inc.
Copyright (C) 2005 Free Software Foundation, Inc.
Copyright (C) 1995-1999, 2000-2007 Free Software Foundation, Inc.

Copyright (C) 1995-1997, 2000-2007 Free Software Foundation, Inc.
Copyright (C) 1995, 2000-2003, 2005 Software Foundation, Inc.
Copyright (C) 2000-2003, 2005-2007 Free Software Foundation, Inc. Written by Ulrich Drepper <drepper@cygnus.com>, 2000.
Copyright (c) IBM Corporation, 1981, 2008. All rights reserved.
Copyright (C) 1995, 1997, 2000-2002, 2004, 2006 Free Software Foundation, Inc.
Copyright (C) 1995, 1997, 1998, 2000, 2003 Free Software Foundation, Inc. This file is part of the GNU C Library.
Copyright (C) 1996-1999, 2000-2003, 2005-2006 Free Software Foundation, Inc. This file is part of the GNU C Library. Contributed by Ulrich Drepper <drepper@cygnus.com>, 1996.
Copyright (C) 1995-1999, 2000-2001, 2003-2007 Free Software Foundation, Inc. Written by Ulrich Drepper <drepper@gnu.org>, 1995.
Copyright (C) 2003, 2005 Free Software Foundation, Inc.
Copyright (C) 1995-1998, 2000-2001, 2003, 2005, 2007 Free Software Foundation, Inc. Contributed by Ulrich Drepper <drepper@gnu.ai.mit.edu>, 1995.
Copyright (C) 2000-2003, 2007 Free Software Foundation, Inc.
Copyright (C) 1995-1997, 2000-2007 by Ulrich Drepper <drepper@gnu.ai.mit.edu>
Copyright (c) IBM Corporation, 2000, 2008. All rights reserved. --
Copyright 1996-2007 Free Software Foundation, Inc. Taken from GNU libtool, 2001 Originally by Gordon Matzigkeit <gord@gnu.ai.mit.edu>, 1996
Copyright (C) 1995-2005 Free Software Foundation, Inc. dnl This file is free software
Copyright (c) IBM Corporation, 2001, 2008. All rights reserved.
Copyright (C) 1995-2003, 2005 Free Software Foundation, Inc.
Copyright (C) 1995-2005 Free Software Foundation, Inc.
Copyright (c) IBM Corporation, 2004, 2008. All rights reserved. --
Copyright (C) 2003-2004 Free Software Foundation, Inc. Written by Bruno Haible <bruno@clisp.org>, 2003
Copyright (C) 2004-2005 Free Software Foundation, Inc.
Copyright (C) 1999, 2002-2005 Free Software Foundation, Inc.
Copyright (c) IBM Corporation, 2003, 2008. All rights reserved. --
Copyright (C) 2000-2001, 2003 Free Software Foundation, Inc. Written by Ulrich Drepper <drepper@cygnus.com>, 2000.
Copyright (C) 1995-1999, 2000-2004 Free Software Foundation, Inc. Contributed by Ulrich Drepper <drepper@gnu.ai.mit.edu>, 1995.
Copyright (C) 2000-2004 Free Software Foundation, Inc.
Copyright (C) 1995-1999, 2000-2005 Free Software Foundation, Inc. Written by Ulrich Drepper <drepper@cygnus.com>, 1995.
Copyright (C) 1999-2000, 2002-2003 Free Software Foundation, Inc.
Copyright (C) 1995-1998, 2000-2005 Free Software Foundation, Inc.
Copyright (C) 1995-1999, 2000-2004 Free Software Foundation, Inc.
Copyright (c) IBM Corporation, 2005, 2008. All rights reserved.
Copyright (C) 1995-1999, 2000-2005 Free Software Foundation, Inc.
Copyright (C) 1995-1997, 2000-2004 Free Software Foundation, Inc.

LICENCE TERMS (cont.)

Copyright (C) 1995-1999, 2000-2005 Free Software Foundation, Inc.
Copyright (C) 1995-1997, 2000-2005 by Ulrich Drepper <drepper@gnu.ai.mit.edu>
Copyright 1996-2005 Free Software Foundation, Inc. Taken from GNU libtool, 2001 Originally by Gordon Matzigkeit <gord@gnu.ai.mit.edu>, 1996
Copyright (C) 1995-2006 Free Software Foundation, Inc. dnl This file is free software
Copyright (C) 2005-2006 Free Software Foundation, Inc.
Copyright (C) 1995-2006 Free Software Foundation, Inc.
Copyright (C) 1999-2006 Free Software Foundation, Inc.
Copyright (c) IBM Corporation, 2005, 2009. All rights reserved. --
Copyright (C) 2001-2006 Free Software Foundation, Inc.
Copyright (C) 1999, 2002-2006 Free Software Foundation, Inc.
Copyright (C) 2000-2001, 2003, 2005 Free Software Foundation, Inc. Written by Ulrich Drepper <drepper@cygnus.com>, 2000.
Copyright (C) 1995-1999, 2000-2001, 2003, 2005 Free Software Foundation, Inc.
Copyright (C) 2000-2001, 2003, 2005 Free Software Foundation, Inc. Written by Ulrich Drepper <drepper@cygnus.com>, 2000.
Copyright (C) 1999-2000, 2002-2003, 2006 Free Software Foundation, Inc.
Copyright (C) 1995-1998, 2000-2006 Free Software Foundation, Inc.
Copyright (C) 1999, 2002-2003, 2005-2006 Free Software Foundation, Inc.
Copyright (C) 2003, 2006 Free Software Foundation, Inc. Written by Bruno Haible <bruno@clisp.org>, 2003.
Copyright (C) 1999, 2002-2003, 2006 Free Software Foundation, Inc.
Copyright (C) 1995-1999, 2000-2006 Free Software Foundation, Inc.
Copyright (C) 1995-1997, 2000-2006 Free Software Foundation, Inc.
Copyright (C) 2000-2003, 2005 Free Software Foundation, Inc. Written by Ulrich Drepper <drepper@cygnus.com>, 2000.
Copyright (C) 1995-1999, 2000-2006 Free Software Foundation, Inc.
Copyright (C) 1995-1999, 2000-2001, 2003-2006 Free Software Foundation, Inc. Written by Ulrich Drepper <drepper@gnu.org>, 1995.
Copyright (C) 1995-1998, 2000-2001, 2003, 2005 Free Software Foundation, Inc. Contributed by Ulrich Drepper <drepper@gnu.ai.mit.edu>, 1995.
Copyright (C) 1995-1997, 2000-2006 by Ulrich Drepper <drepper@gnu.ai.mit.edu>
Copyright 1996-2006 Free Software Foundation, Inc. Taken from GNU libtool, 2001 Originally by Gordon Matzigkeit <gord@gnu.ai.mit.edu>, 1996
Copyright (C) 1995-2014 Free Software Foundation, Inc. dnl This file is free software
Copyright (C) 2000-2002, 2007-2014 Free Software Foundation, Inc.
Copyright (C) 2000-2002, 2004, 2008, 2010-2014 Free Software Foundation, dnl Inc.
Copyright (C) 2001-2005, 2008-2014 Free Software Foundation, Inc.
Copyright (C) 2003, 2007-2014 Free Software Foundation, Inc.
Copyright (C) 2002-2003, 2008-2014 Free Software Foundation, Inc.
Copyright (C) 1997-2004, 2006, 2008-2014 Free Software Foundation, Inc.
Copyright (C) 1997-2002, 2006, 2008-2014 Free Software Foundation, Inc.
Copyright (C) 2006, 2009-2014 Free Software Foundation, Inc.
Copyright (C) 1995-2014 Free Software Foundation, Inc.
Copyright (C) 1996-2003, 2005, 2008-2014 Free Software Foundation, Inc.
Copyright (C) 2006, 2009-2014 Free Software Foundation, Inc.
Copyright (C) 2003-2004, 2008-2014 Free Software Foundation, Inc.
Copyright (C) 1995-2003, 2005-2006, 2008-2014 Free Software Foundation, dnl Inc.
Copyright (C) 2002, 2007-2008, 2010-2014 Free Software Foundation, Inc.
Copyright (C) 1996-2003, 2009-2014 Free Software Foundation, Inc.
Copyright (C) 1997-2004, 2007-2014 Free Software Foundation, Inc.
Copyright (C) 1999-2007, 2009-2014 Free Software Foundation, Inc.
Copyright (C) 2001-2014 Free Software Foundation, Inc.
Copyright (C) 2003, 2007, 2009-2014 Free Software Foundation, Inc.
Copyright 2012-2014 Free Software Foundation, Inc.
Copyright (C) 2003, 2005-2006, 2008-2014 Free Software Foundation, Inc.
Copyright (C) 2002-2005, 2008-2014 Free Software Foundation, Inc.
Copyright (C) 1995-2002, 2004-2005, 2008-2014 Free Software Foundation, dnl Inc.

Copyright (C) 2003-2006, 2008-2011 Free Software Foundation, Inc. Written by Bruno Haible <bruno@clisp.org>, 2003.
Copyright (C) 2004-2007 Free Software Foundation, Inc.
Copyright (C) 1999, 2002-2012 Free Software Foundation, Inc.
Copyright (C) 2002-2004, 2012 Free Software Foundation, Inc.
Copyright (C) 1984, 1989-1990, 2000-2013 Free Software Foundation, Inc.
Copyright (C) 2005-2006, 2009-2014 Free Software Foundation, Inc.
Copyright (C) 1995-1999, 2000-2007 Free Software Foundation, Inc. Contributed by Ulrich Drepper <drepper@gnu.ai.mit.edu>, 1995.
Copyright (C) 2000-2006, 2008-2014 Free Software Foundation, Inc.
Copyright (C) 2005-2008 Free Software Foundation, Inc.
Copyright (C) 1995-1998, 2000-2003, 2005-2006, 2008 Free Software Foundation, Inc.
Copyright (C) 1995-1999, 2000-2007, 2009-2010 Free Software Foundation, Inc. Written by Ulrich Drepper <drepper@cygnus.com>, 1995.
Copyright (C) 1999-2000, 2002-2003, 2006-2008, 2011 Free Software Foundation, Inc.
Copyright (C) 1999, 2002-2003, 2005, 2007, 2010-2011 Free Software Foundation, Inc.
Copyright (C) 2000-2004, 2006-2010 Free Software Foundation, Inc.
Copyright (c) 2004 Python Software Foundation. All rights reserved.
Copyright (c) 1997-2001 by Secret Labs AB. All rights reserved.
Copyright (C) 1995-1998, 2000-2007, 2009-2012 Free Software Foundation, Inc.
Copyright (c) 1999-2008 by Fredrik Lundh
Copyright (c) 2003-2009 by Fredrik Lundh. All rights reserved.
Copyright (C) 1995-1999, 2000-2008, 2010 Free Software Foundation, Inc.
Copyright (c) 2003-2004 by Fredrik Lundh. All rights reserved.
Copyright (C) 2005-2009 Free Software Foundation, Inc.
Copyright (C) 2009 Free Software Foundation, Inc. Written by Bruno Haible <bruno@clisp.org>, 2009.
Copyright (c) 1999-2008 by Fredrik Lundh. All rights reserved.
Copyright (C) 2003, 2006-2007, 2009-2011 Free Software Foundation, Inc. Written by Bruno Haible <bruno@clisp.org>, 2003.
Copyright (C) 2003, 2005, 2008 Free Software Foundation, Inc. Written by Bruno Haible <bruno@clisp.org>, 2003.
Copyright (C) 1999, 2002-2003, 2006-2007, 2011 Free Software Foundation, Inc.
Copyright (C) 1995-1999, 2000-2010, 2012 Free Software Foundation, Inc.
Copyright (C) 1995-1997, 2000-2012 Free Software Foundation, Inc.
Copyright (C) 2003, 2008-2014 Free Software Foundation, Inc.
Copyright (C) 1995, 2000-2003, 2005 Free Software Foundation, Inc.
Copyright (C) 1995-2014 Free Software Foundation, Inc.
Copyright (C) 2003, 2005, 2009 Free Software Foundation, Inc.
Copyright (C) 2001-2002 Free Software Foundation, Inc.
Copyright (C) 1996-2002 Free Software Foundation, Inc.
Copyright (C) 2000 Luke Kenneth Casson Leighton <lkcl@samba.org>
Copyright 2008 by Armin Ronacher. license: Python License.
Copyright (C) 1995, 1997, 1998, 2000, 2001 Free Software Foundation, Inc.
Copyright (C) 2000, 2001 Free Software Foundation, Inc. Written by Ulrich Drepper <drepper@cygnus.com>, 2000.
Copyright (C) 1995-1999, 2000, 2001, 2002 Free Software Foundation, Inc.
Copyright (C) 1995-1997, 2000, 2001, 2002 Free Software Foundation, Inc.
Copyright (C) 2000-2002 Free Software Foundation, Inc.
Copyright (c) 2005-2010 ActiveState Software Inc.
Copyright (C) 1995-1999, 2000, 2001 Free Software Foundation, Inc.
Copyright (C) 2000, 2001 Free Software Foundation, Inc. Written by Ulrich Drepper <drepper@cygnus.com>, 2000.
Copyright (c) 2003-2018 Paul T. McGuire
Copyright (C) 1995-1998, 2000, 2001, 2002 Free Software Foundation, Inc.
Copyright (C) 1995-1999, 2000-2002 Free Software Foundation, Inc. Written by Ulrich Drepper <drepper@cygnus.com>, 1995.
Copyright (c) 2010-2015 Benjamin Peterson
Copyright (C) 1995-1998, 2000-2002 Free Software Foundation, Inc.
Copyright (C) 1995-1999, 2000-2002 Free Software Foundation, Inc.

LICENCE TERMS (cont.)

Copyright (C) 1995, 1997, 2000, 2001, 2002 Free Software Foundation, Inc.
Copyright (C) 1995-1997, 2000-2002 Free Software Foundation, Inc.
Copyright (C) 1995-1999, 2000, 2001, 2002 Free Software Foundation, Inc.
Copyright (C) 1996, 1997, 1998, 1999, 2000, 2001 Free Software Foundation, Inc.
Copyright (C) 1995-1999, 2000-2002 Free Software Foundation, Inc.
Copyright (C) 1995, 2000-2002 Software Foundation, Inc.
Copyright (C) 2000, 2001, 2002 Free Software Foundation, Inc. Written by Ulrich Drepper <drepper@cygnus.com>, 2000.
Copyright (C) 1995, 1997, 2000-2002 Free Software Foundation, Inc.
Copyright (C) 1996-1999, 2000-2002 Free Software Foundation, Inc. This file is part of the GNU C Library.
Contributed by Ulrich Drepper <drepper@cygnus.com>, 1996.
Copyright (C) 1995-1999, 2000, 2001 Free Software Foundation, Inc. Written by Ulrich Drepper <drepper@gnu.org>, 1995.
Copyright (C) 1995-1998, 2000, 2001 Free Software Foundation, Inc. Contributed by Ulrich Drepper <drepper@gnu.ai.mit.edu>, 1995.
Copyright (C) 1995-1997, 2000-2002 by Ulrich Drepper <drepper@gnu.ai.mit.edu>
Copyright 1996-2002 Free Software Foundation, Inc. Taken from GNU libtool, 2001 Originally by Gordon Matzigkeit <gord@gnu.ai.mit.edu>, 1996
Copyright (C) 2016 Jason R Coombs <jaraco@jaraco.com>
Copyright (C) 1995-1999, 2000, 2001 Free Software Foundation, Inc. Contributed by Ulrich Drepper <drepper@gnu.ai.mit.edu>, 1995.
Copyright (C) 1995-1997, 2000, 2001 Free Software Foundation, Inc.
Copyright (C) 1995-1998, 2000, 2001 Free Software Foundation, Inc.
Copyright (C) 1995-1999, 2000, 2001 Free Software Foundation, Inc. Written by Ulrich Drepper <drepper@cygnus.com>, 1995.
Copyright (C) 1995, 1997, 2000, 2001 Free Software Foundation, Inc.
Copyright (C) 1995, 2000, 2001 Software Foundation, Inc.
Copyright (C) 1996-1999, 2000, 2001 Free Software Foundation, Inc. This file is part of the GNU C Library.
Contributed by Ulrich Drepper <drepper@cygnus.com>, 1996.
Copyright (C) 1995-2010 Free Software Foundation, Inc. dnl This file is free software
Copyright (C) 2000-2002, 2007-2010 Free Software Foundation, Inc.
Copyright (C) 2000-2002, 2004, 2008-2010 Free Software Foundation, Inc.
Copyright (C) 2005-2010 Free Software Foundation, Inc.
Copyright (C) 2001-2005, 2008-2010 Free Software Foundation, Inc.
Copyright (C) 2003, 2007-2010 Free Software Foundation, Inc.
Copyright (C) 2002-2003, 2008-2010 Free Software Foundation, Inc.
Copyright (C) 1997-2004, 2006, 2008-2010 Free Software Foundation, Inc.
Copyright (C) 1997-2002, 2006, 2008-2010 Free Software Foundation, Inc.
Copyright (C) 2006, 2009-2010 Free Software Foundation, Inc.
Copyright (C) 1995-2009 Free Software Foundation, Inc.
Copyright (C) 1996-2003, 2005, 2008-2010 Free Software Foundation, Inc.
Copyright (C) 2006, 2009-2010 Free Software Foundation, Inc.
Copyright (C) 2005, 2008-2010 Free Software Foundation, Inc.
Copyright (C) 2004-2010 Free Software Foundation, Inc.
Copyright (C) 2003-2004, 2008-2010 Free Software Foundation, Inc.
Copyright (C) 1995-2003, 2005-2006, 2008-2010 Free Software Foundation, dnl Inc.
Copyright (C) 2002, 2007-2010 Free Software Foundation, Inc.
Copyright (C) 1996-2003, 2009-2010 Free Software Foundation, Inc.
Copyright (C) 1997-2004, 2007-2010 Free Software Foundation, Inc.
Copyright (C) 1999-2007, 2009-2010 Free Software Foundation, Inc.
Copyright (C) 2001-2010 Free Software Foundation, Inc.
Copyright (C) 1995-2010 Free Software Foundation, Inc.
Copyright (C) 2000-2002, 2006, 2008-2010 Free Software Foundation, Inc.
Copyright (C) 2003, 2007, 2009-2010 Free Software Foundation, Inc.
Copyright (C) 2003, 2005-2006, 2008-2010 Free Software Foundation, Inc.
Copyright (C) 2002-2005, 2008-2010 Free Software Foundation, Inc.
Copyright 2012 by Simon Sapin license: BSD, see LICENSE for details.
Copyright (C) 1995-2002, 2004-2005, 2008-2010 Free Software Foundation, dnl Inc.
Copyright 2012 by Simon Sapin license: BSD, see LICENSE for details.
Copyright (C) 2003-2006, 2008-2009 Free Software Foundation, Inc. Written by Bruno Haible <bruno@clisp.org>, 2003.
Copyright (C) 2012 The Python Software Foundation. See LICENSE.txt and CONTRIBUTORS.txt.
Copyright (C) 1999, 2002-2010 Free Software Foundation, Inc.
Copyright (C) 2002 Lars Gustaebel <lars@gustaebel.de> All rights reserved.
Copyright (C) 2000-2006, 2008-2010 Free Software Foundation, Inc.
Copyright (C) 2013 Vinay Sajip.
Copyright (C) 2013-2017 Vinay Sajip.
Copyright (C) 2012-2019 Vinay Sajip.
Copyright (C) 1999-2000, 2002-2003, 2006-2008 Free Software Foundation, Inc.
Copyright (C) 2012-2017 The Python Software Foundation.
Copyright (C) 2012-2013 Python Software Foundation.
Copyright (C) 2013-2015 Vinay Sajip.
Copyright (C) 1995-1998, 2000-2007, 2009-2010 Free Software Foundation, Inc.
Copyright (C) 2012-2015 Vinay Sajip. CONTRIBUTORS.txt.
Copyright (C) 1995-1999, 2000-2008 Free Software Foundation, Inc.
Copyright (C) 2012-2017 Vinay Sajip.
Copyright (C) 2003, 2006-2007, 2009 Free Software Foundation, Inc. Written by Bruno Haible <bruno@clisp.org>, 2003.
copyright: (c) 2017 by Kenneth Reitz.
copyright: (c) 2012 by Kenneth Reitz.
Copyright (C) 1995-1999, 2000-2009 Free Software Foundation, Inc.
Copyright (C) 1995-1997, 2000-2010 Free Software Foundation, Inc.
Copyright (C) 2003, 2008 Free Software Foundation, Inc.
Copyright 2013-2014 Ray Holder
Copyright (C) 1995-1999, 2000-2010 Free Software Foundation, Inc.
Copyright (c) 2003-2019 Paul T. McGuire
Copyright Jonathan Hartley 2013. BSD 3-Clause license, see LICENSE file. from . import win32
Copyright Jonathan Hartley 2013.
Copyright 1996-2010 Free Software Foundation, Inc. Taken from GNU libtool, 2001 Originally by Gordon Matzigkeit <gord@gnu.ai.mit.edu>, 1996
Copyright Jonathan Hartley 2013. BSD 3-Clause license, see LICENSE file.
Copyright (C) 2000-2002, 2004, 2008, 2010-2015 Free Software Foundation, dnl Inc. dnl This file is free software; the Free Software Foundation dnl gives unlimited permission to copy and/or distribute it, dnl with or without modifications, as long as this notice is preserved.
Copyright Jonathan Hartley 2013.
Copyright (C) 2005-2015 Free Software Foundation, Inc.
Copyright Jonathan Hartley 2013.
Copyright (C) 2001-2005, 2008-2015 Free Software Foundation, Inc.
Copyright (C) 2003, 2007-2015 Free Software Foundation, Inc.
Copyright (C) 2002-2003, 2008-2015 Free Software Foundation, Inc.
Copyright (C) 1997-2004, 2006, 2008-2015 Free Software Foundation, Inc.
Copyright (C) 1997-2002, 2006, 2008-2015 Free Software Foundation, Inc.
Copyright (C) 2006, 2009-2015 Free Software Foundation, Inc.
Copyright (C) 1995-2014 Free Software Foundation, Inc.
Copyright (C) 1996-2003, 2005, 2008-2015 Free Software Foundation, Inc.
Copyright (C) 2006, 2009-2014 Free Software Foundation, Inc.
Copyright (C) 2005, 2008, 2010-2015 Free Software Foundation, Inc.
Copyright (C) 2004-2014 Free Software Foundation, Inc.
Copyright (C) 2003-2004, 2008-2015 Free Software Foundation, Inc.
Copyright (C) 1995-2003, 2005-2006, 2008-2014 Free Software Foundation, dnl Inc.
Copyright (C) 2002, 2007-2008, 2010-2015 Free Software Foundation, Inc.
Copyright (C) 1996-2003, 2009-2015 Free Software Foundation, Inc.
Copyright (C) 1997-2004, 2007-2015 Free Software Foundation, Inc.
Copyright (C) 1999-2007, 2009-2015 Free Software Foundation, Inc.

LICENCE TERMS (cont.)

Copyright (C) 2001-2015 Free Software Foundation, Inc.
Copyright (c) 2010-2020 Benjamin Peterson
Copyright 2015,2016,2017 Nir Cohen
Copyright (C) 2003, 2007, 2009-2015 Free Software Foundation, Inc.
Copyright (C) 2001 the Initial Developer. All Rights Reserved.
Copyright (C) 1998 the Initial Developer. All Rights Reserved.
Copyright 2012-2015 Free Software Foundation, Inc.
Copyright (C) 2003, 2005-2006, 2008-2015 Free Software Foundation, Inc.
Copyright (C) 2002-2005, 2008-2015 Free Software Foundation, Inc.
Copyright (C) 1995-2002, 2004-2005, 2008-2014 Free Software Foundation, dnl Inc.
Copyright (C) 1995-2015 Free Software Foundation, Inc.
Copyright (C) 2000, 2015 Free Software Foundation, Inc.
Copyright (C) 2003-2006, 2008-2015 Free Software Foundation, Inc. Written by Bruno Haible <bruno@clisp.org>, 2003.
Copyright (C) 2004-2007, 2015 Free Software Foundation, Inc.
Copyright (C) 1999, 2002-2015 Free Software Foundation, Inc.
Copyright (C) 2002-2004, 2012, 2015 Free Software Foundation, Inc.
Copyright (C) 2001-2002, 2006, 2015 Free Software Foundation, Inc.
Copyright (C) 2005-2006, 2009-2015 Free Software Foundation, Inc.
Copyright (C) 1995-2015 Free Software Foundation, Inc. Contributed by Ulrich Drepper <drepper@gnu.ai.mit.edu>, 1995.
Copyright (C) 1995-1997, 2000, 2006, 2015 Free Software Foundation, Inc. Contributed by Bernd Schmidt <crux@Pool.Informatik.RWTH-Aachen.DE>, 1997.
Copyright (C) 2005-2008, 2015 Free Software Foundation, Inc.
Copyright (C) 2000-2015 Free Software Foundation, Inc. Written by Ulrich Drepper <drepper@cygnus.com>, 2000.
Copyright (C) 1995-2015 Free Software Foundation, Inc. Written by Ulrich Drepper <drepper@cygnus.com>, 1995.
Copyright (C) 1999-2000, 2002-2003, 2006-2008, 2011, 2015 Free Software Foundation, Inc.
Copyright (C) 1999, 2002-2003, 2005, 2007, 2010-2011, 2015 Free Software Foundation, Inc.
Copyright (C) 2006, 2015 Free Software Foundation, Inc. Written by Bruno Haible <bruno@clisp.org>, 2006.
Copyright (C) 1995-1998, 2000-2007, 2009-2015 Free Software Foundation, Inc.
Copyright (C) 2005 the Initial Developer. All Rights Reserved.
Copyright (C) 1999, 2002-2003, 2005-2007, 2015 Free Software Foundation, Inc.
Copyright (C) 2005-2009, 2015 Free Software Foundation, Inc.
Copyright (C) 2009, 2015 Free Software Foundation, Inc. Written by Bruno Haible <bruno@clisp.org>, 2009.
Copyright (C) 2003, 2006-2007, 2009-2011, 2015 Free Software Foundation, Inc. Written by Bruno Haible <bruno@clisp.org>, 2003.
Copyright (C) 2002-2003, 2015 Free Software Foundation, Inc.
Copyright (C) 2001-2002, 2015 Free Software Foundation, Inc.
Copyright (C) 2003, 2005, 2008, 2015 Free Software Foundation, Inc. Written by Bruno Haible <bruno@clisp.org>, 2003.
Copyright (C) 1999, 2002-2003, 2006-2007, 2011, 2015 Free Software Foundation, Inc.
Copyright (C) 2006, 2015 Free Software Foundation, Inc.
Copyright (C) 2005, 2015 Free Software Foundation, Inc.
Copyright (C) 1995-2015 Free Software Foundation, Inc.
Copyright (c) 2015-2016 Will Bond <will@wbond.net>
Copyright (C) 1995-1997, 2000-2015 Free Software Foundation, Inc.
Copyright (C) 2003, 2008-2015 Free Software Foundation, Inc.
Copyright (C) 1995, 2000-2003, 2005, 2015 Free Software Foundation, Inc.
Copyright (c) 2010-2019 Benjamin Peterson
Copyright (c) 2012 Giorgos Verigakis <verigak@gmail.com>
Copyright (C) 1995-2015 Free Software Foundation, Inc.
Copyright (C) 1996-2015 Free Software Foundation, Inc. This file is part of the GNU C Library. Contributed by Ulrich Drepper <drepper@cygnus.com>, 1996.
Copyright (C) 1995-2015 Free Software Foundation, Inc. Written by Ulrich Drepper <drepper@gnu.org>, 1995.
Copyright (C) 2003, 2005, 2009, 2015 Free Software Foundation, Inc.
Copyright (C) 1995-2015 Free Software Foundation, Inc. Contributed by Ulrich Drepper <drepper@gnu.ai.mit.edu>, 1995.

Copyright 2012 Facebook
Copyright (C) 2000-2003, 2007, 2015 Free Software Foundation, Inc.
Copyright (c) 2008-2016 The pip developers (see AUTHORS.txt file)
Copyright (c) 2008-2019 The pip developers (see AUTHORS.txt file)
Copyright 1996-2015 Free Software Foundation, Inc. Taken from GNU libtool, 2001 Originally by Gordon Matzigkeit <gord@gnu.ai.mit.edu>, 1996
Copyright (C) 2000-2001 Free Software Foundation, Inc.
Copyright (c) 1997 by Fredrik Lundh
Copyright (C) 1995-1999, 2000, 2001 Free Software Foundation, Inc.:(C) tests whether C is a directory separator character. IS_ABSOLUTE_PATH(P) tests whether P is an absolute path. If it is not, it may be concatenated to a directory pathname. IS_PATH_WITH_DIR(P) tests whether P contains a directory specification.
Copyright 2006 Google, Inc. All Rights Reserved. Licensed to PSF under a Contributor Agreement.
Copyright (C) 1995-1997, 2000, 2001 by Ulrich Drepper <drepper@gnu.ai.mit.edu>
Copyright (C) 1995-2003 Free Software Foundation, Inc. dnl This file is free software, distributed under the terms of the GNU dnl General Public License. As a special exception to the GNU General dnl Public License, this file may be distributed as part of a program dnl that contains a configuration
Copyright (C) 2001-2003 Free Software Foundation, Inc. dnl This file is free software, distributed under the terms of the GNU dnl General Public License. As a special exception to the GNU General dnl Public License, this file may be distributed as part of a program dnl that contains a configuration
Copyright 2008 Armin Ronacher. Licensed to PSF under a Contributor Agreement.
Copyright (C) 1997-2003 Free Software Foundation, Inc.
Copyright (C) 1996-2003 Free Software Foundation, Inc.
Copyright (C) 1995-2003 Free Software Foundation, Inc.
Copyright (C) 2003 Free Software Foundation, Inc. Written by Bruno Haible <bruno@clisp.org>, 2003
Copyright (C) 1995-1999, 2000-2003 Free Software Foundation, Inc. Written by Ulrich Drepper <drepper@cygnus.com>, 1995.
Copyright 2006 Georg Brandl.
Copyright (C) 1995-1999, 2000-2003 Free Software Foundation, Inc.
Copyright (C) 1995-1997, 2000-2003 by Ulrich Drepper <drepper@gnu.ai.mit.edu>
Copyright (C) 1996-2003, 2005, 2008-2015 Free Software Foundation, Inc.
Copyright 2007 Georg Brandl. Licensed to PSF under a Contributor Agreement.
Copyright (C) 1995-1999, 2000, 2001, 2002 Free Software Foundation, Inc. Contributed by Ulrich Drepper <drepper@gnu.ai.mit.edu>, 1995.
Copyright (C) 1984, 1989-1990, 2000-2012 Free Software Foundation, Inc.
Copyright 2004-2005 Elemental Security, Inc. All Rights Reserved.
Copyright (C) 1995-2013 Free Software Foundation, Inc. dnl This file is free software
Copyright 2004-2005 Elemental Security, Inc. All Rights Reserved. Licensed to PSF under a Contributor Agreement.
Copyright (C) 2000-2002, 2007-2013 Free Software Foundation, Inc.
Copyright (c) 2001, 2002, 2003, 2004, 2005, 2006 Python Software Foundation. All rights reserved.
Copyright (C) 2000-2002, 2004, 2008, 2010-2013 Free Software Foundation, dnl Inc.
Copyright (C) 2005-2013 Free Software Foundation, Inc.
Copyright (C) 2001-2005, 2008-2013 Free Software Foundation, Inc.
Copyright (C) 2003, 2007-2013 Free Software Foundation, Inc.
Copyright (C) 2002-2003, 2008-2013 Free Software Foundation, Inc.
Copyright (C) 1997-2004, 2006, 2008-2013 Free Software Foundation, Inc.
Copyright (C) 1997-2002, 2006, 2008-2013 Free Software Foundation, Inc.
Copyright (C) 2006, 2009-2013 Free Software Foundation, Inc.
Copyright (C) 1995-2013 Free Software Foundation, Inc.
Copyright (C) 1996-2003, 2005, 2008-2013 Free Software Foundation, Inc.
Copyright (C) 2006, 2009-2013 Free Software Foundation, Inc.
Copyright (C) 2005, 2008, 2010-2013 Free Software Foundation, Inc.
Copyright (C) 2003-2004, 2008-2013 Free Software Foundation, Inc.
Copyright (C) 1995-2003, 2005-2006, 2008-2013 Free Software Foundation, dnl Inc.
Copyright (C) 2002, 2007-2008, 2010-2013 Free Software Foundation, Inc.
Copyright (C) 1996-2003, 2009-2013 Free Software Foundation, Inc.
Copyright (C) 1997-2004, 2007-2013 Free Software Foundation, Inc.
Copyright 2001-2016 by Vinay Sajip. All Rights Reserved.

LICENCE TERMS (cont.)

Copyright (C) 1999-2007, 2009-2013 Free Software Foundation, Inc.
Copyright 2001-2019 by Vinay Sajip. All Rights Reserved.
Copyright (C) 2001-2013 Free Software Foundation, Inc.
Copyright (C) 2001-2016 Vinay Sajip. All Rights Reserved.
Copyright (C) 2001-2019 Vinay Sajip. All Rights Reserved.
Copyright (C) 2000-2002, 2006, 2008-2013 Free Software Foundation, Inc.
Copyright (C) 2003, 2007, 2009-2013 Free Software Foundation, Inc.
Copyright 2012-2013 Free Software Foundation, Inc.
Copyright (C) 2001-2017 Vinay Sajip. All Rights Reserved.
Copyright (C) 2003, 2005-2006, 2008-2013 Free Software Foundation, Inc.
Copyright (C) 2002-2005, 2008-2013 Free Software Foundation, Inc.
Copyright (C) 1995-2002, 2004-2005, 2008-2013 Free Software Foundation, dnl Inc.
Copyright (C) 2005-2006, 2009-2013 Free Software Foundation, Inc.
Copyright (C) 2000-2006, 2008-2012 Free Software Foundation, Inc.
Copyright (C) 2003, 2008-2013 Free Software Foundation, Inc.
Copyright (C) 1995-2012 Free Software Foundation, Inc.
Copyright 1995-2010 Mark Adler
Copyright 1995-2005 Mark Adler
Copyright (C) 2000, 2001 Free Software Foundation, Inc.
Copyright 1995-2005 Mark Adler
Copyright (C) 2005, 2006 Martin von Löwis Licensed to PSF under a Contributor Agreement.
Copyright 1995-2013 Mark Adler
Copyright (C) 2003-2005 Free Software Foundation, Inc. Written by Bruno Haible <bruno@clisp.org>, 2003.
Copyright 1995-2013 Mark Adler
Copyright (C) 2003 Free Software Foundation, Inc.
Copyright (C) 2002-2003 Free Software Foundation, Inc.
Copyright (C) 1999-2003 Free Software Foundation, Inc.
Copyright (C) 1995-1999, 2000-2003 Free Software Foundation, Inc. Contributed by Ulrich Drepper <drepper@gnu.ai.mit.edu>, 1995
Copyright (c) 2003-2005 by Peter Astrand <astrand@lysator.liu.se>
Copyright (C) 1995-1997, 2000-2004 by Ulrich Drepper <drepper@gnu.ai.mit.edu>
Copyright (C) 1995-2003 Free Software Foundation, Inc.
Copyright (C) 1995-1999, 2000-2007, 2009 Free Software Foundation, Inc. Written by Ulrich Drepper <drepper@cygnus.com>, 1995.
Copyright (C) 1995, 1997 Free Software Foundation, Inc.
Copyright (C) 1995 Free Software Foundation, Inc. Ulrich Drepper <drepper@gnu.ai.mit.edu>, 1995.
Copyright (C) 1995, 1996, 1997 Free Software Foundation, Inc. Contributed by Ulrich Drepper <drepper@gnu.ai.mit.edu>, 1995.
Copyright (C) 1995, 1996, 1997 Free Software Foundation, Inc.
Copyright (C) 1995, 1996, 1997, 1998 Free Software Foundation, Inc. Written by Ulrich Drepper <drepper@gnu.ai.mit.edu>, 1995.
Copyright (C) 1995, 1996, 1997, 1998 Free Software Foundation, Inc.
Copyright (C) 1995 Software Foundation, Inc.
Copyright (C) 1996, 1997 Free Software Foundation, Inc. This file is part of the GNU C Library. Contributed by Ulrich Drepper <drepper@cygnus.com>, 1996.
Copyright (C) 1995, 1996, 1997, 1998 Free Software Foundation, Inc. Contributed by Ulrich Drepper <drepper@gnu.ai.mit.edu>, 1995.
Copyright (C) 1995, 1996, 1997 by Ulrich Drepper <drepper@gnu.ai.mit.edu>
Copyright (C) 2006-2007, 2015-2016 Free Software Foundation, Inc.
Copyright (C) 2003 Red Hat, Inc.
Copyright 1987-2019, Larry Wall
Copyright (C) 2001,2002 Python Software Foundation, and were written by Barry Warsaw.
Copyright (C) 2001,2002 Python Software Foundation, and were written by Barry Warsaw.
Copyright 1995-2017 Jean-loup Gailly and Mark Adler
(c) 2012 Entrust, Inc.
Copyright (C) 2011-2014 Vinay Sajip. Licensed to the PSF under a contributor agreement.
Copyright (C) 2011-2014 Vinay Sajip. Licensed to the PSF under a contributor agreement.

Copyright 1996 by Sam Rushing
Copyright (c) 1999-2003 Steve Purcell
Copyright 1995-2017 Mark Adle
Copyright (C) 2007-2012 Michael Foord & the mock team
Copyright 2000-2018 The OpenSSL Project Authors. All Rights Reserved.
Copyright 2002-2018 The OpenSSL Project Authors. All Rights Reserved.
copyright (c) 1998 by W. L. Estes <wlestes@uncg.edu>
Copyright (C) 2004 Enrico Scholz <enrico.scholz@informatik.tu-chemnitz.de>
(C) 2005 Novell (<http://www.novell.com>)
Copyright 2010 Per Øyvind Karlsen <proyvind@moondrake.org>
Copyright 2008 by Armin Ronacher.
Copyright (c) 1999-2000, Marc-Andre Lemburg
Copyright (c) 2001-2006 Gregory P. Ward. All rights reserved.
Copyright (c) 1998-2001 by Secret Labs AB. All rights reserved.
Copyright (C) 2001-2006 Python Software Foundation Author: Barry Warsaw Contact: email-sig@python.org
Copyright (C) 2001-2007 Python Software Foundation Author: Barry Warsaw Contact: email-sig@python.org
Copyright (C) 2002-2007 Python Software Foundation Contact: email-sig@python.org
Copyright (C) 2001-2007 Python Software Foundation Author: Ben Gertzfield, Barry Warsaw Contact: email-sig@python.org
Copyright (C) 2001-2007 Python Software Foundation Author: Barry Warsaw, Thomas Wouters, Anthony Baxter Contact: email-sig@python.org
Copyright (C) 2002-2007 Python Software Foundation Author: Ben Gertzfield, Barry Warsaw Contact: email-sig@python.org
Copyright (C) 2002-2007 Python Software Foundation Author: Ben Gertzfield Contact: email-sig@python.org
Copyright (C) 2002-2006 Python Software Foundation Author: Barry Warsaw Contact: email-sig@python.org
Copyright (C) 2001-2006 Python Software Foundation Author: Keith Dart Contact: email-sig@python.org
Copyright (C) 2001-2007 Python Software Foundation Author: Anthony Baxter Contact: email-sig@python.org
Copyright (C) 2004-2006 Python Software Foundation Authors: Baxter, Wouters and Warsaw Contact: email-sig@python.org
Copyright (C) 2001-2010 Python Software Foundation Author: Barry Warsaw Contact: email-sig@python.org
Copyright (C) 2001-2006 Python Software Foundation Author: Ben Gertzfield Contact: email-sig@python.org
Copyright (C) 2006 - 2010 Gregor Lingl email: glingl@aon.at
Copyright (C) 2006-2013 Python Software Foundation.
Copyright (C) 2000 Bastian Kleineidam
Copyright (c) 2001-2020 Python Software Foundation. All Rights Reserved.
Copyright (c) 1997-2002 by Secret Labs
Copyright (c) 2000, BeOpen.com.
Copyright 2000 by Timothy O'Malley <timo@alum.mit.edu>
Copyright (c) 1999-2002 by Secret Labs AB.
Copyright (C) 2001-2003, 2005, 2015-2016 Free Software Foundation, Inc.
Copyright (C) 1996-2017 Markus Franz Xaver Johannes Oberhumer All Rights Reserved.
Copyright (C) 2008-2018 Karel Zak <kzak@redhat.com>
Copyright (c) 1996, 2013 Oracle and/or its affiliates. All rights reserved.
Copyright (c) 1998-2017,2019 Free Software Foundation, Inc. *
Copyright (C) 2000-2012, 2014, 2016 Red Hat, Inc. This file is part of elfutils. Written by Ulrich Drepper <drepper@redhat.com>, 2000.
Copyright (C) 2002, 2005, 2008 Red Hat, Inc. This file is part of elfutils.
Copyright (C) 2000-2010, 2013, 2014, 2015, 2016, 2017 Red Hat, Inc. This file is part of elfutils.
Copyright (C) 2014, 2015, 2016, 2018 Red Hat, Inc. This file is part of elfutils.
Copyright (C) 2008 Red Hat, Inc.
Copyright (C) 2005-2010, 2013 Red Hat, Inc. This file is part of elfutils.
Copyright (C) 2002-2010, 2013, 2014, 2016, 2018 Red Hat, Inc. This file is part of elfutils.
Copyright (c) 2006-2017,2018 Free Software Foundation, Inc. *
Copyright (C) 1990-2011, 2017-2018 Free Software Foundation, Inc.
Copyright (C) 1990-1991, 1993, 2011, 2016-2018 Free Software Foundation, Inc.
Copyright (c) 1998-2009,2017 Free Software Foundation, Inc. *
Copyright (c) 1998-2011,2019 Free Software Foundation, Inc. *

LICENCE TERMS (cont.)

Copyright (c) 2008-2009, Google Inc. All rights reserved.
Copyright (c) Corporation for National Research Initiatives.
Copyright (c) Corporation for National Research Initiatives.
Copyright (C) 1987, 1988 Student Information Processing Board of the Massachusetts Institute of Technology.
Copyright (C) 2001 Andreas Dilger
Copyright (C) 2003-2008, 2010, 2015-2016 Free Software Foundation, Inc. Written by Bruno Haible <bruno@clisp.org>, 2003.
Copyright (c) 1998-2014,2018 Free Software Foundation, Inc. *
Copyright (c) 1998-2018,2019 Free Software Foundation, Inc. *
Copyright (c) 1998-2017,2018 Free Software Foundation, Inc. *
Copyright (c) 1997, 2013 Oracle and/or its affiliates. All rights reserved.
Copyright (C) 1999, 2000, 2001, 2002, 2004, 2005, 2007, 2015 Red Hat, Inc. This file is part of elfutils.
Copyright (C) 1994-1999 RSA Security Inc.
Copyright (c) 1998-2005,2019 Free Software Foundation, Inc. *
Copyright (c) 1998-2001,2018 Free Software Foundation, Inc. *
Copyright (c) Christos Zoulas 2003. All Rights Reserved.
Copyright (C) 2014 Ondrej Oprala <ooprala@redhat.com>
Copyright (C) 1995-2016 Jean-loup Gailly, Mark Adler
Copyright (C) 1995-2001 Red Hat Software */
Copyright (C) The Internet Society (1998). All Rights Reserved.
Copyright (C) 2000-2011, 2014, 2016, 2017, 2018 Red Hat, Inc. This file is part of elfutils.
Copyright (c) 2003-2008 Tim Kientzle
Copyright 2006-2016 The OpenSSL Project Authors. All Rights Reserved.
Copyright 2000-2020 The OpenSSL Project Authors. All Rights Reserved.
Copyright 1995-2018 The OpenSSL Project Authors. All Rights Reserved.
Copyright 2007-2016 The OpenSSL Project Authors. All Rights Reserved.
Copyright 2005-2018 The OpenSSL Project Authors. All Rights Reserved.
Copyright 2015-2016 The OpenSSL Project Authors. All Rights Reserved.
Copyright 2002-2019 The OpenSSL Project Authors. All Rights Reserved.
Copyright 1999-2020 The OpenSSL Project Authors. All Rights Reserved.
Copyright (C) 1998-2010, 2015 Red Hat, Inc. This file is part of elfutils.
Copyright (c) 1998-2008,2009 Free Software Foundation, Inc. *
Copyright (C) 1998, 1999, 2000, 2002 Red Hat, Inc. This file is part of elfutils.
Copyright (c) 1998-2014,2019 Free Software Foundation, Inc. *
Copyright (c) 2003-2010 Tim Kientzle All rights reserved.
Copyright (C) 2012-2014 Karel Zak <kzak@redhat.com>
Copyright (c) 1998-2016,2017 Free Software Foundation, Inc. *
Copyright (c) 2010 Oracle America, Inc.
Copyright (C) 1997-2015 Free Software Foundation, Inc. This file is part of the GNU C Library. Contributed by Thorsten Kukuk <kukuk@suse.de>, 1997.
Copyright (C) 1996-2014 Free Software Foundation, Inc. This file is part of the GNU C Library. Contributed by Thorsten Kukuk <kukuk@suse.de>, 1996.
Copyright (c) 2011, 2014 Anthony Green
Copyright (C) 1996, 1997, 1998 Theodore Ts'o.
Copyright 2009, 2013 Red Hat Inc., Durham, North Carolina. All Rights Reserved.
Copyright (C) 1996-2017 Markus Franz Xavier Johannes Oberhumer All Rights Reserved
Copyright 2003-2004 Martin Quinson (martin.quinson#debian.org)
Copyright 1989 The Regents of the University of California. All rights reserved.
Copyright (c) The Regents of the University of California. All rights reserved.
Copyright 1992-2019 Free Software Foundation, Inc.
Copyright (C) 2011 Free Software Foundation, Inc. This config.lt script is free software
Copyright (C) 2004, 2005 Red Hat, Inc.
Copyright © 2009-2012, 2015 Guillem Jover <guillem@debian.org>
Copyright © 2006-2014 Guillem Jover <guillem@debian.org>
Copyright © 2009-2014, 2017 Guillem Jover <guillem@debian.org>
Copyright © 2001 Wichert Akkerman
Copyright © 2008-2011 Guillem Jover <guillem@debian.org>

Copyright © 2000,2001 Wichert Akkerman
Copyright © 2000,2001 Wichert Akkerman <wichert@debian.org>
Copyright © 2000-2003 Adam Heath <doogie@debian.org>
Copyright © 2005 Scott James Remnant
Copyright © 2000,2001 Wichert Akkerman <wichert@debian.org>
Copyright © Ian Jackson <ijackson@chiark.greenend.org.uk>
Copyright © 2007 Don Armstrong <don@donarmstrong.com>.
Copyright © 2010, 2012-2015 Guillem Jover <guillem@debian.org>
Copyright © 2009-2010 Modestas Vainius <modax@debian.org>
Copyright © 2007-2009,2012-2015,2017-2018 Guillem Jover <guillem@debian.org>
Copyright © 2007,2012 Guillem Jover <guillem@debian.org>
Copyright © 2007-2008, 2012-2015 Guillem Jover <guillem@debian.org>
Copyright © 1999 Darren Benham
Copyright © 2000 Sean 'Shaleh' Perry
Copyright © 2004 Frank Lichtenheld
Copyright © 2006 Russ Allbery
Copyright © 2008-2009,2012-2014 Guillem Jover <guillem@debian.org>
Copyright © 2012-2017 Guillem Jover <guillem@debian.org>
Copyright © 2008 Canonical, Ltd. written by Colin Watson <cjwatson@ubuntu.com>
Copyright © 2008 James Westby <jw+debian@jameswestby.net>
Copyright © 2009, 2011-2017 Guillem Jover <guillem@debian.org>
Copyright © 2009-2011 Kees Cook <kees@debian.org>
Copyright © 2007-2008 Canonical, Ltd.
Copyright © 2008-2009, 2012-2014 Guillem Jover <guillem@debian.org>
Copyright © 2012-2014 Guillem Jover <guillem@debian.org>
Copyright © 2007, 2009-2010, 2012-2017 Guillem Jover <guillem@debian.org>
Copyright © 2010, 2013-2016 Guillem Jover <guillem@debian.org>
Copyright © 2008, 2012-2017 Guillem Jover <guillem@debian.org>
Copyright © 2007-2010 Raphaël Hertzog <hertzog@debian.org>
Copyright © 2008, 2012-2015 Guillem Jover <guillem@debian.org>
Copyright © 2007 Joey Hess <joeyh@debian.org>.
Copyright © 2008 Frank Lichtenheld <djpig@debian.org>
Copyright © 2008-2018 Guillem Jover <guillem@debian.org>
Copyright © 2008, 2012-2015 Guillem Jover <guillem@debian.org>
Copyright © 2011 Linaro Limited
Copyright © 2009, 2012-2015 Guillem Jover <guillem@debian.org>
Copyright © 2005 Frank Lichtenheld <frank@lichtenheld.de>
Copyright © 2012-2017 Guillem Jover <guillem@debian.org>
Copyright © 2010-2013 Guillem Jover <guillem@debian.org>
Copyright © 2007 Raphaël Hertzog <hertzog@debian.org>
Copyright (c) 2000-2017 Expat development team Licensed under the MIT license:
Copyright (C) 1991, 1992 Linus Torvalds
Copyright (c) 1996-2003, 2010 Red Hat, Inc.
Copyright (C) 2008 Free Software Foundation, Inc.
Copyright (C) 1984, Sun Microsystems, Inc.
Copyright (c) 1988 by Sun Microsystems, Inc.
Copyright (c) 1986 by Sun Microsystems, Inc.
Copyright (c) 1984 - 1991 by Sun Microsystems, Inc.
Copyright (C) 1986-1993 by Sun Microsystems, Inc.
Copyright (c) 1986 - 1991 by Sun Microsystems, Inc.
Copyright (C) 1986, Sun Microsystems, Inc.
Copyright (c) 1990, 1991 Sun Microsystems, Inc. */
Copyright (C) 1986, Sun Microsystems, Inc.
Copyright (c) 2002, Oracle and/or its affiliates. All rights reserved
Copyright (c) 2004, EdelKey Project. All Rights Reserved.
Copyright (C) 2006, Network Resonance, Inc. Copyright (C) 2011, RTFM, Inc.
Copyright 2005 Nokia. All rights reserved.

LICENCE TERMS (cont.)

Copyright (c) 2002, Oracle and/or its affiliates. All rights reserved
copyright 1998 The Perl Journal.
Copyright 2013 Tom Christiansen.
Copyright (c) 2008-2009 Bjoern Hoehrmann <bjoern@hoehrmann.de>
Copyright (c) 2008-2009 Bjoern Hoehrmann <bjoern@hoehrmann.de>
Copyright (C) 1995, 1996, 1997, 1998 Doug MacEachern and Jon Orwant. All Rights Reserved.
Copyright 1999, 2000, 2001, 2004, 2006, 2008, 2010, 2015, 2018 Russ Allbery <rra@cpan.org>
Copyright 2010, brian d foy C<< <brian.d.foy@gmail.com> >>
Copyright © 2012 Tom Christiansen <et.al.>
Copyright (C) 1998, 2002, 2003 Jon Orwant. All Rights Reserved.
Copyright 2001-2011 Jarkko Hietaniemi E<lt>jhi@iki.fiE<gt>.
Copyright (c) 2000 Mark Kvale. All rights reserved. Now maintained by Perl porters.
Copyright (c) 2000 Mark Kvale All rights reserved.
Copyright (C) 1990-2012 by Larry Wall and others.
Copyright (c) 2000-2001, Damian Conway. All Rights Reserved.
Copyright 2019 Chad Granum E<lt>exodist@cpan.orgE<gt>.
Copyright 1996 Zenin
Copyright 2012 Kurt Starsinic <kstarsinic@gmail.com>
Copyright 2012 Kurt Starsinic <kstarsinic@gmail.com>
Copyright (c) 1989, 1993 The Regents of the University of California. All rights reserved.
Copyright (c) 2004-2013 by the Perl 5 Porters. All rights reserved.
Copyright (c) 2004 by the Perl 5 Porters. All rights reserved.
Copyright (c) 2004-14 by the Perl 5 Porters. All rights reserved.
Copyright (c) 2004,2007 by the Perl 5 Porters. All rights reserved.
copyright (C) Charles Bailey, Tim Bunce, David Landgren, James Keenan and Richard Elberger 1995-2018. All rights reserved.
Copyright (C) 1990-2011 by Larry Wall and others.
Copyright 2003, 2004, 2005, 2006 by Audrey Tang E<lt>cpan@audreyt.orgE<gt>.
Copyright (c) 1999 Tuomas J. Lukka <lukka@iki.fi>. All rights reserved. This program is free software
Copyright (C) 2004, 2008 Matthijs van Duin. All rights reserved.
Copyright (C) 2014 cPanel Inc. All rights reserved. This program is free software
Copyright 2004, 2005, 2006, 2007 by Audrey Tang E<lt>cpan@audreyt.orgE<gt>.
copyright (c) 2002 - 2009 Jos Boumans E<lt>kane@cpan.orgE<gt>. All rights reserved.
Copyright (c) 2011-2014 Reini Urban. All rights reserved.
Copyright (c) 2014-2017 cPanel Inc. All rights reserved.
Copyright (c) 2014-2017 cPanel Inc. All rights reserved.
Copyright (c) 2001-2018, brian d foy, All Rights Reserved.
Copyright 2001, Lincoln Stein <lstein@cshl.org>.
Copyright 2001, Lincoln Stein <lstein@cshl.org>.
Copyright (c) 1997-2003 Graham Barr <gbarr@pobox.com>. All rights reserved. This program is free software
Copyright (c) 1998-2004 Tom Hughes E<lt>F<tom@compton.nu>E<gt>. All rights reserved. This program is free software
Copyright 2002-2014 Dan Kogai I<< <dankogai@cpan.org> >>.
Copyright (c) 2002, 2003, 2004, 2012 Elizabeth Mattijsen. All rights reserved. This library is free software
Copyright (c) 1998+ Sean M. Burke. All rights reserved.
Copyright (c) 1998-2004 Sean M. Burke. All rights reserved.
Copyright (c) 2001-2002 Michael G. Schwern.
Copyright (c) 2000, 1996, 1991, 2012 O'Reilly Media, Inc. This document may be distributed under the same terms as Perl itself.
Copyright (c) 2002, 2003, 2004, 2005, 2006, 2007, 2008 Jarkko Hietaniemi. All rights reserved.
Copyright (C) 2011, 2012, 2013 Andrew Main (Zefram) <zefram@fysh.org>
Copyright (c) 1997-2010 Tom Christiansen, Nathan Torkington, and other authors as noted. All rights reserved.
Copyright 2006-2008 Curtis "Ovid" Poe, all rights reserved.
Copyright 2007-2011 Andy Armstrong.
copyright 2006-2008 Adam Kennedy.
Copyright 2007-2011 Andy Armstrong.
Copyright 1995-1999, 2001-2004, 2010 Gisle Aas.
Copyright 1991 Bell Communications Research, Inc. (Bellcore)
Copyright 1995-1997,2002-2004 Gisle Aas.
Copyright 1995,1996 Neil Winton.
Copyright (c) 2001-2011 Ken Williams.
Copyright (c) 2010-2011 Matt Trout and David Golden. All rights reserved.
Copyright (c) 1997-8 Graham Barr. All rights reserved. This program is free software
Copyright (C) 1997, 1999 Tom Phoenix
Copyright (c) 1995-2016 Paul Marquess. All rights reserved. This program is free software
Copyright 1997 - 2001 Damian Conway. All Rights Reserved.
copyright 2009 Adam Kennedy.
Copyright (C) 2005 Aristotle Pagaltzis
Copyright (C) 2012-2013 Google, Inc.
Copyright (C) 2012-2013 Google, Inc. T
Copyright (c) 2008 Graham Barr <gbarr@pobox.com>. All rights reserved. This program is free software
Copyright (c) 2002-2014 by the Perl 5 Porters
Copyright (c) 2015-2016 cPanel Inc
Copyright (c) 2017 Reini Urban
Copyright 2012 Steffen Mueller
Copyright 2009, 2010, 2011, 2012 Steffen Mueller
Copyright 2002-2014 by Ken Williams, David Golden and other contributors. All rights reserved.
Copyright (c) 2003-2005 Ken Williams. All rights reserved.
Copyright 2009, 2010, 2011, 2012, 2013 Steffen Mueller
Copyright (c) 2008,2009 Larry Wall and others
Copyright (c) 2017-2018, Reini Urban. All rights reserved.
Copyright (c) 2016, cPanel Inc. All rights reserved.
Copyright (c) 2012, Steve Peters. All rights reserved.
Copyright (c) 2002-2003, Rob Brown. All rights reserved.
Copyright (c) 2001, Colin McMillen. All rights reserved.
Copyright (C) 2013-2016 Steve Hay. All rights reserved. This module is free software
Copyright (C) 2013-2016 Steve Hay. All rights reserved.
Copyright (C) 2013-2014, 2016 Steve Hay. All rights reserved. This module is free software
Copyright (C) 1998-2011 Graham Barr. All rights reserved.
Copyright (C) 2013-2014, 2016 Steve Hay. All rights reserved.
Copyright (C) 2013-2014 Steve Hay. All rights reserved. This module is free software
Copyright (C) 2013-2014 Steve Hay. All rights reserved.
Copyright (C) 2014 Steve Hay. All rights reserved. This module is free software
Copyright (C) 2014 Steve Hay. All rights reserved.
Copyright (c) 2013-2017 Steve Hay. All rights reserved. This module is free software
Copyright (C) 2013-2017 Steve Hay. All rights reserved.
Copyright (C) 1997-1998 Graham Barr. All rights reserved. This document is free
Copyright (C) 1997-1998 Graham Barr. All rights reserved.
Copyright (c) 2002,3,4 Sean M. Burke. All rights reserved.
Copyright (c) 2001-2016 by Marek Rouchal. This file is part of "Pod-Usage". Pod-Usage is free software
Copyright 2001, 2004, 2008, 2014, 2018 by Russ Allbery <rra@cpan.org>
Copyright (c) 1997-2013 Tom Christiansen, Nathan Torkington, and other authors as noted. All rights reserved.
copyright (c) 2018 by Christian Hansen.
Copyright 1998, 1999, 2000, 2001, 2012 by Mark Jason Dominus
Copyright (C) 1994-2013 Larry Wall
Copyright (c) 2004 by the Perl 5 Porters. All rights reserved.
copyright (c) 1994 by the Regents of the University of California. All rights reserved.
copyright (c) 1994 by the Regents of the University of California. All rights reserved.
Copyright 2002-2008 by chromatic E<lt>chromatic@wgz.orgE<gt> and Michael G Schwern E<lt>schwern@pobox.comE<gt>.
Copyright 2001-2008 by Michael G Schwern E<lt>schwern@pobox.comE<gt>.
Copyright 2001 by Michael G Schwern E<lt>schwern@pobox.comE<gt>.
Copyright (c) 1999,2001 by ZeeGee Software Inc. All rights reserved.
Copyright Micheal G Schwern 2001. Used and distributed with permission.

LICENCE TERMS (cont.)

Copyright (c) 2007-2011, Andy Armstrong C<< <andy@hexten.net> >>. All rights reserved.
Copyright 1998-2003 Gisle Aas.
Copyright 1995-1996 Neil Winton.
Copyright 1991-1992 RSA Data Security, Inc.
Copyright (C) 1991-2, RSA Data Security, Inc. Created 1991. All rights reserved.
Copyright (c) 2016 Unicode, Inc.
Copyright (C) 1997, Graham Barr <gbarr@pobox.com>.
Copyright (C) 2007-2013, Marcus Holland-Moritz.
Copyright (c) 1997, Graham Barr.
Copyright (C) 2018, The perl5 porters
Copyright (C) 2001, Paul Marquess.
Copyright (C) 1999, Kenneth Albanowski.
Copyright (c) 2004-2013, Marcus Holland-Moritz.
Copyright (c) 1991 - 1995, Stichting Mathematisch Centrum Amsterdam, The Netherlands. All rights reserved.
Copyright (c) 2001, 2002, 2003, 2004, 2005, 2006, 2007, 2008, 2009, 2010, 2011, 2012, 2013, 2014, 2015, 2016, 2017, 2018, 2019, 2020 Python Software Foundation
Copyright (C) 2002, 2003 Python Software Foundation. Written by Greg Ward <gward@python.net>
Copyright (c) 2002-2006 Python Software Foundation. All rights reserved.
Copyright 2000, Mojam Media, Inc., all rights reserved. Author: Skip Montanaro
Copyright 1999, Bioreason, Inc., all rights reserved. Author: Andrew Dalke
Copyright 1995-1997, Automatrix, Inc., all rights reserved. Author: Skip Montanaro
Copyright 1991-1995, Stichting Mathematisch Centrum, all rights reserved.
Copyright 1989, 1991 The Regents of the University of California. All rights reserved.
Copyright 2001, Russell Nelson <opkg.py@russnelson.com>
Copyright © 1997 Klee Dienes <klee@debian.org>
Copyright © 1999-2003 Wichert Akkerman <wakkerma@debian.org>
Copyright © 1999 Ben Collins <bcollins@debian.org>
Copyright © 2005 Brendan O'Dea <bod@debian.org>
Copyright © 2006-2008 Frank Lichtenheld <djpig@debian.org>
Copyright (c) 2006-2009,2012 Guillem Jover <guillem@debian.org>
Copyright © 2008-2011 Raphaël Hertzog <hertzog@debian.org>
Copyright 2010 Grant McLean E<lt>grantm@cpan.orgE<gt>
Copyright (C) 1993 Jean-loup Gailly
Copyright (c) 2011-2018 Paul Marquess. All rights reserved.
Copyright © 2006-2010, 2012-2015 Guillem Jover <guillem@debian.org>
Copyright (C) 2014 Intel Corp. Distributed under the terms of the MIT license. this_binary
Copyright (C) 2003-2007 Free Software Foundation, Inc. License GPLv2+: GNU GPL version 2 or later <http://gnu.org/licenses/gpl.html> This is free software: you are free to change and redistribute it. There is NO WARRANTY, to the extent permitted by law." echo "Written by" "Bruno Haible"
Copyright (C) 2003-2018 Mark Shelor <mshelor@cpan.org>.
Copyright © 2000 Wichert Akkerman
Copyright © 2006 Frank Lichtenheld
Copyright © 2006-2010,2012-2015 Guillem Jover <guillem@debian.org>
Copyright © 2007, 2016 Raphaël Hertzog <hertzog@debian.org>
Copyright (C) 2012 Free Software Foundation, Inc.
Copyright © 2009,2012 Guillem Jover <guillem@debian.org>
Copyright © 2002 Wichert Akkerman <wakkerma@debian.org>
Copyright © 2006-2009, 2011-2015 Guillem Jover <guillem@debian.org>
Copyright © 2003-2013 Yann Dirson <dirson@debian.org>
Copyright © 2006-2016 Guillem Jover <guillem@debian.org>
Copyright © 2014 Niko Tyni <ntyni@debian.org>
Copyright © 2014-2015 Jérémy Bobbio <lunar@debian.org>
Copyright (C) 1988 Larry WallHunk
Copyright (C) 2004-2015 Free Software Foundation, Inc. This is free software
Copyright (C) 2010-2015 Free Software Foundation, Inc. This is free software
Copyright 2015 Michael LaGrasta and Dan Kogai.
Copyright (c) 2002-2007 by D.H. aka PodMaster

Copyright (C) 1995-1998, 2000-2013 Free Software Foundation, Inc. License GPLv3+: GNU GPL version 3 or later <http://gnu.org/licenses/gpl.html> This is free software: you are free to change and redistribute it. There is NO WARRANTY, to the extent permitted by law." echo "Written by" "Ulrich Drepper
Copyright © 2007-2013 Guillem Jover <guillem@debian.org>
Copyright © 2006-2008,2010,2012-2014 Guillem Jover <guillem@debian.org>
Copyright (C) 1992, 1993 Jean-loup Gailly
Copyright © 2006-2009, 2011-2015 Guillem Jover <guillem@debian.org>
Copyright © 2007-2011 Raphael Hertzog <hertzog@debian.org>
Copyright (C) 2002-2013 Free Software Foundation, Inc. License GPLv3+: GNU GPL version 3 or later <http://gnu.org/licenses/gpl.html> This is free software: you are free to change and redistribute it. There is NO WARRANTY, to the extent permitted by law." echo "Written by" "Bruno Haible"
Copyright © 2006-2010, 2012-2015 Guillem Jover <guillem@debian.org>
Copyright © 2007 Frank Lichtenheld
Copyright (C) 2006 Thiago Macieira
Copyright © 2011-2012 Nokia Corporation
Copyright (C) 2001 Python Software Foundation Barry Warsaw <barry@python.org>, 2000.
Copyright © 2004-2005 Scott James Remnant <scott@netsplit.com>,
Copyright © 2000,2002 Wichert Akkerman
Copyright © 2008 Joey Hess <joeyh@debian.org>
Copyright © 2005 Scott James Remnant (original implementation on www.dpkg.org)
Copyright (C) 1995 Ian Jackson. This version of update-alternatives is command-line compatible with Debian's for a subset of the options, (only --install, --remove, and --help)
Copyright (C) 2002 Michael Meeks This is free software
Copyright (C) 2004 Chris Larson This is free software
Copyright (c) 2001-2015, brian d foy, All Rights Reserved.
Copyright © 2006-2012 Guillem Jover <guillem@debian.org>
copyright(C) STEPANYUKARS-Sfx archive data
copyright(C) CED 87Biosig/CED SMR biosig/ced-smr
Copyright (c) 1984,1998
Copyright 1989-1990 PKWARE Inc.
Copyright (C) 2002-2018 Free Software Foundation, Inc.
Copyright (C) 2001-2018 Free Software Foundation, Inc.
Copyright (C) 1997-2018 Free Software Foundation, Inc.
Copyright (C) 1999-2018 Free Software Foundation, Inc.
Copyright (C) 2003-2018 Free Software Foundation, Inc.
Copyright (C) 2009-2018 Free Software Foundation, Inc.
Copyright (C) 2006-2018 Free Software Foundation, Inc.
Copyright (C) 2012 Free Software Foundation, Inc. This configure script is free software
Copyright (C) 2012 Free Software Foundation, Inc. This config.status script is free software
Copyright (C) 2009-2012 Free Software Foundation, Inc.])
Copyright © 2012-2015 Dan Nicholson <dbn.lists@gmail.com>
Copyright (C) 2011 Jean Delvare <jdelvare@suse.de> Loosely based on C implementation by Andreas Gruenbacher <agruen@suse.de>
Copyright (C) 1984, 1989, 1990, 2000, 2001, 2002 Free Software Foundation, Inc.
Copyright (c) 1999-2009 by Fredrik Lundh
Copyright (C) 1984, 1989, 1990 Free Software Foundation, Inc.
Copyright (c) 2013 Eddy Petrișor
Copyright(c) 1999 VeriSign, Inc.
Copyright(c) 1999 Entrust.net Limited
Copyright(c) 2006 Entrust, Inc.
Copyright(c) 2006 Entrust, Inc.
Copyright(c) 2006 thawte, Inc.
Copyright(c) 2006 VeriSign, Inc. - For authorized use only
Copyright(c) 2006 VeriSign, Inc.
Copyright (c) 2005/OISTE Foundation Endorsed
Copyright(c) 2008 GeoTrust Inc.
Copyright(c) 2007 thawte, Inc. - For authorized use only

LICENCE TERMS (cont.)

Copyright(c) 2007 thawte, Inc.
Copyright(c) 2008 thawte, Inc. - For authorized use only
Copyright(c) 2008 thawte, Inc.
Copyright(c) 2007 GeoTrust Inc.
Copyright(c) 2008 VeriSign, Inc. - For authorized use only
Copyright(c) 2008 VeriSign, Inc.
Copyright(c) 2007 VeriSign, Inc. - For authorized use only
Copyright(c) 2007 VeriSign, Inc.
Copyright(c) 2009 Entrust, Inc. - for authorized use only
Copyright(c) 2009 Entrust, Inc.
Copyright(c) 2012 Entrust, Inc.
Copyright(c) 2015 Entrust, Inc. - for authorized use only
Copyright(c) 2015 Entrust, Inc. - for authorized use only Label: "Entrust Root Certification Authority - G4" Serial: 2893
83649854506086828220374796556676440 MD5 Fingerprint: 89:53:f1:83:23:b7:7c:8e:05:f1:8c:71:38:4e:1f:88 SHA1
Fingerprint: 14:88:4e:86:26:37:b0:26:af:59:62:5c:40:77:ec:35:29:ba:96:01
Copyright 2006 Google, Inc. All Rights Reserved.
copyright 1991-1995 by Stichting Mathematisch Centrum, Amsterdam, The Netherlands.
Copyright 1995-2017 Mark Adler
Copyright(c) 2008 VeriSign, Inc.
Copyright(c) 2008 thawte, Inc.
Copyright(c) 2006 Entrust, Inc
Copyright(c) 1999 Entrust.net Limited1301
Copyright(c) 1999 VeriSign, Inc.
Copyright(c) 1999 VeriSign, Inc.
Copyright(c) 2012 Entrust, Inc.
Copyright(c) 2009 Entrust, Inc.
Copyright(c) 2007 VeriSign, Inc.
Copyright(c) 2007 thawte, Inc.
Copyright(c) 2007 thawte, Inc.
Copyright(c) 2006 VeriSign, Inc.
Copyright(c) 1999 Entrust.net Limited1301 U *Entrust.net Certification Authority
Copyright (c) 2003-2010 Python Software Foundation
Copyright (c) 2002 The OpenTSA Project. All rights reserved.
Copyright 2015 Neal Gomba <ngomba13@gmail.com>
copyright.html">Copyright 2001-2020, Python Software Foundation.
Copyright (c) 2000 BeOpen.com. All Rights Reserved.
Copyright (c) 1995-2001 Corporation for National Research Initiatives. All Rights Reserved.
Copyright (c) 1991-1995 Stichting Mathematisch Centrum, Amsterdam. All Rights Reserved.
Copyright (c) 1997-2002 by Secret Labs AB
Copyright (c) 2000-2010, eGenix.com Software GmbH
Copyright (c) 1995-2000, Corporation for National Research Initiatives.
Copyright (c) 1990-1995, Stichting Mathematisch Centrum. All rights reserved.
Copyright (c) 1999-2002 by Fredrik Lundh.
Copyright (c) 1999-2002 by Secret Labs AB
Copyright (c) 1999-2002 by Fredrik Lundh
Copyright (c) 1999 by Secret Labs AB.
Copyright (c) 1999 by Fredrik Lundh.
Copyright (c) 1999 by Secret Labs AB
Copyright (c) 1999 by Fredrik Lundh
Copyright (C) 2003 Theodore Ts'o
Copyright (C) 2008 Karel Zak <kzak@redhat.com>
Copyright (C) 2014 Karel Zak <kzak@redhat.com>
Copyright (c) 2016 Martin Matuska All rights reserved.
Copyright (c) 2007 KISA(Korea Information Security Agency). All rights reserved.
Copyright (c) 1996-2003, 2007, 2008 Red Hat, Inc.
Copyright (C) 1989, 1991 Free Software Foundation, Inc., 51 Franklin Street, Fifth Floor, Boston, MA 02110-1301
USA Everyone is permitted to copy and distribute verbatim copies of this license document, but changing it is not

allowed.;copyright the software, and 2) offer you this license which gives you legal permission to copy, distribute and/or modify the software.;copyright law: that is to say, a work containing the Program or a portion of it, either verbatim or with modifications and/or translated into another language. (Hereinafter, translation is included without limitation in the term "modification".) Each licensee is addressed as "you".;copyrighted interfaces, the;copyrighted by the Free Software Foundation, write to the Free Software Foundation; we sometimes make exceptions for this. Our decision will be guided by the two goals of preserving the free status of all derivatives of our free software and of promoting the sharing and reuse of software generally.;copyright" line and a pointer to where the full notice is found.;Copyright (C) <year> <name of author>;Copyright (C) year name of author Gnomovision comes with ABSOLUTELY NO WARRANTY; for details type `show w'. This is free software, and you are welcome to redistribute it under certain conditions; type `show c' for details.;copyright disclaimer" for the program, if necessary. Here is a sample; alter the names.;copyright interest in the program Gnomovision' (which makes passes at compilers) written by James Hacker.
Copyright (c) 2006, 2008 Junio C Hamano
Copyright (C) 2002 Roman Zippel <zippel@linux-m68k.org>
Copyright (C) 1991, 1999 Free Software Foundation, Inc.
Copyright (C) 2012 Red Hat, Inc. All Rights Reserved. Written by David Howells (dhowells@redhat.com)
Copyright (c) 1998 Harald Koerfgen
Copyright 2014 Maxime Ripard
Copyright (C) 2017 Jagan Teki <jteki@openedev.com>
Copyright (c) 2017 Icenowy Zheng <icenowy@aosc.xyz>
Copyright (c) 2018 Amllogic, Inc. All rights reserved.
Copyright (C) 2013 Lothar Waßmann <LW@KARO-electronics.de>
Copyright (C) 2015 Rabeeh Khoury <rabeeh@solid-run.com> Based on work by Russell King
Copyright (C) 2017 Icenowy Zheng <icenowy@aosc.io>
Copyright (c) 2018 Collabora Ltd.
Copyright (c) 2004, K A Fraser
Copyright 2015 Hans de Goede <hdegoede@redhat.com>
Copyright (C) 2016 Chen-Yu Tsai <wens@csie.org>
Copyright (c) 2018 ARM Ltd.
Copyright (C) 2014 Rabeeh Khoury (rabeeh@solid-run.com) Based on dt work by Russell King
Copyright (C) 2015 Stefan Wahren <stefan.wahren@i2se.com>
Copyright (C) 2014 Renesas Solutions Corp.
Copyright (C) 2019 PHYTEC Messtechnik GmbH Author: Stefan Riedmueller <s.riedmueller@phytec.de>
Copyright (C) 2015-2017 Socionext Inc. Author: Masahiro Yamada <yamada.masahiro@socionext.com> Kunihiko Hayashi <hayashi.kunihiko@socionext.com>
Copyright (C) 2017 Engicam S.r.l.
Copyright (C) 2016 Hans de Goede <hdegoede@redhat.com>
Copyright (C) 2016 PHYTEC Messtechnik GmbH Author: Christian Hemp <c.hemp@phytec.de>
Copyright (C) 2015 Marek Vasut <marex@denx.de>
Copyright (C) 2015 Renesas Electronics Corp.
Copyright (C) 2019 Bootlin Author: Paul Kocialkowski <paul.kocialkowski@bootlin.com>
Copyright (C) 2016 Amarula Solutions B.V.
Copyright (c) 2018 Baylibre SAS. Author: Jerome Brunet <jbrunet@baylibre.com>
Copyright (C) 2014 STMicroelectronics Limited. Author: Giuseppe Cavallaro <peppe.cavallaro@st.com>
Copyright (C) 2016 Renesas Electronics Corp.
Copyright 2016 Hans de Goede <hdegoede@redhat.com>
Copyright (C) 2015-2016 Renesas Electronics Corp.
Copyright (C) 2018 Renesas Electronics Corp.
Copyright (C) 2016 Texas Instruments Incorporated - http://www.ti.com/
Copyright (C) 2018-2019 SiFive, Inc. Wesley Terpstra Paul Walmsley
Copyright (C) 2018 Renesas Electronics Corp.
Copyright (C) 2015 Broadcom Corporation
Copyright (C) 2015-2017 Socionext Inc. Author: Masahiro Yamada <yamada.masahiro@socionext.com>
Copyright (C) 2015-2016 Socionext Inc. Author: Masahiro Yamada <yamada.masahiro@socionext.com>
Copyright (C) 2017 Chen-Yu Tsai <wens@csie.org>
Copyright (C) 2015 Rabeeh Khoury <rabeeh@solid-run.com> Based on dt work by Russell King
Copyright 2015 Chen-Yu Tsai
Copyright (C) 2015 Rabeeh Khoury <rabeeh@solid-run.com>

LICENCE TERMS (cont.)

(C) Copyright 2018, Xilinx, Inc.
Copyright (C) 2016 Freescale Semiconductor, Inc.
Copyright (C) 2018 Xilinx, Inc.
Copyright (C) STMicroelectronics 2018 - All Rights Reserved Author: Philippe Peurichard <philippe.peurichard@st.com>, Pascal Paillet <p.paillet@st.com> for STMicroelectronics.
Copyright (C) 2016 Socionext Inc. Author: Masahiro Yamada <yamada.masahiro@socionext.com>
Copyright (C) 2014 Renesas Electronics Corporation
Copyright (C) STMicroelectronics 2017 - All Rights Reserved Author: Torgue Alexandre <alexandre.torgue@st.com> for STMicroelectronics.
Copyright (C) 2016 Maxime Ripard <maxime.ripard@free-electrons.com>
Copyright (C) 2017 Icenoway Zheng <icenoway@aosc.xyz>
Copyright (C) 2014 Russell King
Copyright (C) 2013,2014 Russell King
Copyright (c) 2016 BayLibre, SAS Author: Neil Armstrong <narmstrong@baylibre.com>
Copyright (C) 2016 STMicroelectronics (R&D) Limited. Author: Patrice Chotard <patrice.chotard@st.com>
Copyright (c) 2019 BayLibre, SAS Author: Neil Armstrong <narmstrong@baylibre.com>
Copyright (C) 2015 Jens Kuske <jenskuske@gmail.com>
Copyright (c) 2016-2017 Linaro Ltd.
Copyright 2015 - Marcus Cooper <codekipper@gmail.com>
Copyright (C) STMicroelectronics 2017 - All Rights Reserved Author: Alexandre Torgue <alexandre.torgue@st.com> for STMicroelectronics.
Copyright (C) 2013 Texas Instruments Incorporated - <http://www.ti.com/> Contact: Eduardo Valentin <eduardo.valentin@ti.com>
Copyright 2016 Free Electrons
Copyright (C) 2017 Chen-Yu Tsai <wens@csie.org>
Copyright (C) 2018 Jagan Teki <jagan@openedev.com>
Copyright (C) 2016 Icenoway Zheng <icenoway@aosc.xyz>
Copyright (c) 2005, Keir Fraser
Copyright (c) 2016 BayLibre, SAS Author: Neil Armstrong <narmstrong@baylibre.com>
Copyright (C) 2014 Marvell
Copyright 2015 - Ultimaker B.V. Author Olliver Schinagl <oliver@schinagl.nl>
Copyright 2013 Freescale Semiconductor, Inc.
Copyright (C) STMicroelectronics 2019 - All Rights Reserved Author: Alexandre Torgue <alexandre.torgue@st.com>
Copyright (C) 2012 Marvell
Copyright (C) 2016 Renesas Electronics Corp.
Copyright (C) 2018 Jacopo Mondì <jacopo+renesas@jmondi.org>
Copyright (c) 2018 Amlogic, Inc. All rights reserved. Author: Xingyu Chen <xingyu.chen@amlogic.com>
Copyright (C) 2017 Glider bvba
Copyright (c) 2019 Rockchip Electronics Co. Ltd. Author: Finley Xiao <finley.xiao@rock-chips.com>
Copyright (c) 2005, Keir Fraser <keir@xensource.com>
Copyright (C) 2016 Milo Kim <woogyom.kim@gmail.com>
Copyright (C) 2013-2015 Renesas Electronics Corporation
Copyright (C) 2017 Preet Laes <plaes@plaes.org>
Copyright (C) 2013 Simon Baatz <gmbnomis@gmail.com>
Copyright 2016 Freescale Semiconductor, Inc.
Copyright (C) STMicroelectronics 2018 - All Rights Reserved Author: Gabriel Fernandez <gabriel.fernandez@st.com> for STMicroelectronics.
Copyright (c) 2019 BayLibre, SAS. Author: Jerome Brunet <jbrunet@baylibre.com>
Copyright (C) 2018 Chen-Yu Tsai <wens@csie.org>
Copyright 2015 Free Electrons
Copyright (C) 2015 Freescale Semiconductor, Inc.
Copyright (C) 2018 Jacopo Mondì <jacopo+renesas@jmondi.org>
Copyright 2011 Freescale Semiconductor, Inc.
Copyright (c) 2015, Intel Corporation Authors: Tadeusz Struk <tadeusz.struk@intel.com>
Copyright (c) 2019 BayLibre, SAS Author: Neil Armstrong <narmstrong@baylibre.com>
Copyright (C) 2012 David Gibson, IBM Corporation.
Copyright (C) 2018 Engicam S.r.l.
Copyright 2019 NXP
Copyright © 2001-2007 Red Hat, Inc. and others
Copyright (C) 2017 Icenoway Zheng <icenoway@aosc.io>
Copyright 2015 Sjarhei Siamashka <siarhei.siamashka@gmail.com>
Copyright (c) 2019 Shenzhen Wesion Technology Co., Ltd. <https://www.khadas.com>
Copyright (C) 2017 Jacopo Mondì <jacopo+renesas@jmondi.org>
Copyright (C) 2017 Jelle van der Waa <jelle@vdwaa.nl>
Copyright (C) 2019 Amarula Solutions B.V. Author: Jagan Teki <jagan@amarulasolutions.com>
Copyright (C) 2016 Allied Telesis Labs
Copyright (C) 2014 STMicroelectronics Limited. Author: Peter Griffin <peter.griffin@linaro.org>
Copyright (c) 2018 Texas Instruments MMC IOdelay values for TI's DRA76x and AM576x SoCs. Author: Sekhar Nori <nsekhar@ti.com>
Copyright (c) 2017 BayLibre SAS Author: Neil Armstrong <narmstrong@baylibre.com>
Copyright (C) 2014 Renesas Electronics Corporation
Copyright (c) 2018 BayLibre, SAS. Author: Neil Armstrong <narmstrong@baylibre.com> Author: Jerome Brunet <jbrunet@baylibre.com>
Copyright (C) 2014 Linaro Ltd.
Copyright 2014 - 2015 Freescale Semiconductor, Inc.
Copyright (c) 2002-2006, K Fraser
Copyright (c) 2016-2017 Fuzhou Rockchip Electronics Co., Ltd
Copyright (c) 2016-2018 HiSilicon Technologies Co., Ltd.
Copyright (c) 2015 Hisilicon Limited.
Copyright (C) 2015 Amarula Solutions B.V.
Copyright (C) 2013 Altera Corporation <www.altera.com>
Copyright (C) 2015 Christoph Junghans <ottxor@gentoo.org>
Copyright (c) 2016 Endless Computers, Inc. Author: Carlo Caione <carlo@endlessm.com>
Copyright (C) 2014 STMicroelectronics R&D Limited
Copyright (C) 2018 Jernej Skrabec <jernej.skrabec@siol.net>
Copyright (C) 2018 Amarula Solutions Author: Jagan Teki <jagan@amarulasolutions.com>
Copyright 2017 - Alexandre Torgue <alexandre.torgue@st.com>
Copyright (c) 2018 FriendlyElec Computer Tech. Co., Ltd. <http://www.friendlyarm.com>
Copyright (C) 2016 Markus Heiser license: GPL Version 2, June 1991 see Linux/COPYING for details.
Copyright 2019-2020 NXP
Copyright (C) 2016 James Pettigrew <james@innovum.com.au>
Copyright (C) 2014-2015 Renesas Electronics Corporation
Copyright (C) 2016 Freescale Semiconductor, Inc.
Copyright (C) 2006 David Gibson, IBM Corporation. EVEN IF ADVISED OF THE POSSIBILITY OF SUCH DAMAGE.
Copyright (C) 2017 Texas Instruments Incorporated - <http://www.ti.com/>
Copyright (C) 2016 Markus Heiser license: GPL Version 2, June 1991 see linux/COPYING for details.
Copyright 2012 Maxime Ripard
Copyright 2015 Preet Laes
Copyright Altera Corporation (C) 2015. All rights reserved.
Copyright (C) 2015 CompuLab, Ltd. - <http://www.complab.co.il/>
Copyright (C) 2017 Socionext Inc. Author: Masahiro Yamada <yamada.masahiro@socionext.com>
Copyright (C) 2012 Altera Corporation <www.altera.com>
Copyright 2014 Hans de Goede <hdegoede@redhat.com>
Copyright (C) 2015 Renesas Electronics Corporation
Copyright (c) 2017 Amlogic, Inc. All rights reserved. Author: Xingyu Chen <xingyu.chen@amlogic.com>
Copyright (C) 2013 Texas Instruments, Inc.
Copyright (c) 2017 Fuzhou Rockchip Electronics Co., Ltd.
Copyright (c) 2018-2019 SiFive, Inc */
Copyright 2015 Marcus Cooper
Copyright 2017 Olimex Ltd. Stefan Mavrodiev <stefan@olimex.com>
Copyright (C) 2014 Steffen Trumtrar <s.trumtrar@pengutronix.de>
Copyright (C) 2016 STMicroelectronics Author: Gabriel Fernandez for STMicroelectronics.
Copyright 2018 NXP
Copyright (C) 2018 Masahiro Yamada <yamada.masahiro@socionext.com>

LICENCE TERMS (cont.)

Copyright (C) 2015 Marvell
Copyright (C) 2014 Simon Guinot <simon.guinot@sequanux.org>
Copyright 2018-2019 NXP
Copyright (C) 2011 Texas Instruments Incorporated - <http://www.ti.com/>
Copyright 2012 Freescale Semiconductor, Inc.
Copyright (C) 2014-2018 Xilinx, Inc.
Copyright (C) 2006 David Gibson, IBM Corporation.
Copyright (C) 2006 David Gibson, IBM Corporation.
Copyright (C) 2018 Olimex Ltd. Author: Stefan Mavrodiev <stefan@olimex.com>
Copyright (c) 2016 BayLibre, SAS. Author: Neil Armstrong <narmstrong@baylibre.com>
Copyright (C) 2014
Copyright 2015 Technexion Ltd.
Copyright (c) 2016 Icenowy Zheng <icenowy@aosc.xyz>
Copyright (C) 2014 Evgeni Dobrev <evgeni@studio-punkt.com>
Copyright 2015 Maxime Ripard
Copyright 2016 Grinn
Copyright (C) 2015 Chen-Yu Tsai <wens@csie.org>
Copyright (C) 2016 Icenowy Zheng <icenowy@aosc.xyz>
Copyright (c) 2003-2004, K A Fraser.
Copyright (c) 2017 Amllogic, Inc. All rights reserved.
Copyright (C) 2016 PHYTEC Messtechnik Author: Christian Hemp <c.hemp@phytec.de>
Copyright (C) 2014 Marek Vasut <marex@denx.de>
Copyright (C) 2017 Centrum Embedded Systems, Jia-Bin Huang <jb@ces.com.tw>
Copyright (C) 2018 Pengutronix, Lucas Stach <kernel@pengutronix.de>
Copyright (C) 2014 Freescale Semiconductor, Inc.
Copyright (c) 2014, Renesas Electronics Corporation All rights reserved.
Copyright (C) 2014 David Gibson <david@gibson.dropbear.id.au>
Copyright (c) 2016, NVIDIA CORPORATION.
Copyright (C) 2019 Synopsys, Inc. All rights reserved. Author: Eugeniy Paltsev <Eugeniy.Paltsev@synopsys.com>
(C) Copyright 2000 - 2013 Wolfgang Denk, DENX Software Engineering, wd@denx.de.
(C) Copyright 2007 Stanislav Galabov <sgalabov@gmail.com>
(C) Copyright 2007 Semihalf
Copyright (c) 2017, Impinj, Inc.
Copyright (c) 2011 The Chromium OS Authors.
Copyright (C) 2017 Álvaro Fernández Rojas <noltari@gmail.com>
(C) Copyright 2007-2008 Semihalf
Copyright (C) 2017, STMicroelectronics - All Rights Reserved Author(s): Patrice Chotard, <patrice.chotard@st.com> for STMicroelectronics.
Copyright (C) 2019 MediaTek Inc. All Rights Reserved.
(C) Copyright 2017 Rockchip Electronics Co., Ltd
Copyright (c) 2018 BayLibre, SAS. Author: Neil Armstrong <narmstrong@baylibre.com>
(C) Copyright 2000-2006 Wolfgang Denk, DENX Software Engineering, wd@denx.de.
Copyright 2017 Google, Inc
Copyright 2014 Steffen Trumtrar <s.trumtrar@pengutronix.de>
(C) Copyright 2001 Hans-Joerg Frieden, Hyperion Entertainment Hans-JoergF@hyperion-entertainment.com
(C) Copyright 2001 Wolfgang Denk, DENX Software Engineering, wd@denx.de.
Copyright (C) 2018 MediaTek Inc.
(C) Copyright 2000 Wolfgang Denk, DENX Software Engineering, wd@denx.de.
(C) Copyright 2001 Raymond Lo, lo@routefree.com Wolfgang Denk, DENX Software Engineering, wd@denx.de.
(C) Copyright 2001 Denis Peter, MPL AG Switzerland, d.peter@mpl.ch.
(C) Copyright 2001 Denis Peter, MPL AG Switzerland, d.peter@mpl.ch.
Copyright (C) 2018 Amarula Solutions. Author: Jagan Teki <jagan@amarulasolutions.com>
Copyright (C) 2008 RuggedCom, Inc. Richard Retanubun <RichardRetanubun@RuggedCom.com>
Copyright (c) 2019, Linaro Limited
(C) Copyright 2000 Hans-Joerg Frieden, Hyperion Entertainment Hans-JoergF@hyperion-entertainment.com
Copyright 2008-2012 Freescale Semiconductor, Inc. Dave Liu <daveliu@freescale.com>
Copyright 2008-2014 Freescale Semiconductor, Inc.

Copyright 2016 Freescale Semiconductor, Inc.
Copyright (C) 2018 Alexander Graf <agraf@suse.de>
Copyright 2008 Freescale Semiconductor, Inc.
Copyright (C) 2012 Marek Vasut <marex@denx.de>
Copyright (c) 2014 Google, Inc
Copyright (C) 2014 Charles Manning <cdhmanning@gmail.com>
Copyright 2008-2011 Freescale Semiconductor, Inc.
COPYRIGHT (c) 2000 BY ABATRON AG
(C) Copyright 2008 Semihalf;(C) Copyright 2000-2004 DENX Software Engineering Wolfgang Denk, wd@denx.de
Copyright (C) 1993, 1996, 2001, 2002 Free Software Foundation, Inc.
Copyright 2010-2016 Freescale Semiconductor, Inc.
(C) Copyright 2010 Texas Instruments, <www.ti.com>
Copyright 2008-2012 Freescale Semiconductor, Inc.
Copyright 2008-2016 Freescale Semiconductor, Inc.
Copyright 2014 Google, Inc
Copyright 2014-2016 Freescale Semiconductor, Inc.
Copyright (c) 2017 Heinrich Schuchardt <xypron.glpk@gmx.de>
Copyright 2014-2015 Freescale Semiconductor, Inc.
Copyright 2008, 2010-2016 Freescale Semiconductor, Inc.
(c) 2015 Purna Chandra Mandal <purna.mandal@microchip.com>
(C) Copyright 2000-2008 Wolfgang Denk, DENX Software Engineering, wd@denx.de.
(C) Copyright 2002-2006 Wolfgang Denk, DENX Software Engineering, wd@denx.de.
(c) 2015 Paul Thacker <paul.thacker@microchip.com>
(C) Copyright 2000-2010 Wolfgang Denk, DENX Software Engineering, wd@denx.de.:(C) Copyright 2008 Guennadi Liakhovetski, DENX Software Engineering, lg@denx.de.
(C) Copyright 2002-2008 Wolfgang Denk, DENX Software Engineering, wd@denx.de.
Copyright (c) 2013, Google Inc. Written by Simon Glass <sjg@chromium.org>
Copyright 2012-2014 Freescale Semiconductor, Inc.
(C) Copyright 2015 Google, Inc Written by Simon Glass <sjg@chromium.org>
Copyright (C) 2018 MediaTek Inc. Author: Weijie Gao <weijie.gao@mediatek.com>
Copyright (C) 2019 Intel Corporation <www.intel.com>
(C) Copyright 2015 Google, Inc Written by Simon Glass <sjg@chromium.org>;(C) 2017 Theobroma Systems Design und Consulting GmbH
(C) Copyright 2000-2003 Wolfgang Denk, DENX Software Engineering, wd@denx.de.
Copyright (C) 2017-2018 Intel Corporation <www.intel.com>
Copyright Altera Corporation (C) 2012-2015
(C) Copyright 2008 Semihalf;(C) Copyright 2000-2009 DENX Software Engineering Wolfgang Denk, wd@denx.de
Copyright (C) 2016-2018 Intel Corporation <www.intel.com>
(C) Copyright 2014 DENX Software Engineering Heiko Schocher <hs@denx.de>;(C) Copyright 2008 Semihalf;(C) Copyright 2000-2004 DENX Software Engineering Wolfgang Denk, wd@denx.de
Copyright (C) 2017 Intel Corporation <www.intel.com>
Copyright 2008 Extreme Engineering Solutions, Inc.
Copyright (C) 2016-2019 Intel Corporation <www.intel.com>
Copyright (c) 2013 The Chromium OS Authors.
Copyright (C) 2017-2019 Intel Corporation <www.intel.com>
Copyright Altera Corporation (C) 2014-2015
Copyright (c) 2011-2019, Ulf Magnusson SPDX-License-Identifier: ISC
Copyright (c) 2012 The Chromium OS Authors.
Copyright (C) Marvell International Ltd. and its affiliates
Copyright (c) 2013 The Chromium OS Authors.
Copyright (C) 2016 Michal Simek <michals@xilinx.com>
Copyright (c) 2017 Imagination Technologies Ltd.
(C) Copyright 2009 Stefano Babic, DENX Software Engineering, sbabic@denx.de.:(C) Copyright 2008 Marvell Semiconductor <www.marvell.com> Written-by: Prafulla Wadaskar <prafulla@marvell.com>
Copyright (C) 2016 Marvell International Ltd.
Copyright (c) 2013, Google Inc.:(C) Copyright 2008 Semihalf;(C) Copyright 2000-2006 Wolfgang Denk, DENX Software Engineering, wd@denx.de.

LICENCE TERMS (cont.)

(C) Copyright 2013 Thomas Petazzoni thomas.petazzoni@free-electrons.com
Copyright (c) 2019, Simon Goldschmidt simon.k.r.goldschmidt@gmail.com
(C) Copyright 2016 DENX Software Engineering GmbH Written-by: Albert ARIBAUD albert.aribaud@3adev.fr
Copyright 2009 Extreme Engineering Solutions, Inc.
(c) 2012 Daniel Stodden daniel.stodden@gmail.com
(C) Copyright 2006 Wolfgang Denk, DENX Software Engineering, wd@denx.de;(C) Copyright 2000 Murray Jensen Murray.Jensen@csiro.au
Copyright 1988, 91, 92, 93, 94, 95, 96, 97, 98, 1999 Free Software Foundation, Inc.
(C) Copyright 2000 Murray Jensen Murray.Jensen@csiro.au
Copyright (C) 2018 Marvell International Ltd.
(C) Copyright 2008 Marvell Semiconductor www.marvell.com Written-by: Prafulla Wadaskar prafulla@marvell.com
(C) Copyright 2014 Andreas Bießmann andreas@biessmann.org
(C) Copyright 2011 Stefano Babic, DENX Software Engineering, sbabic@denx.de.
(C) Copyright 2001 Murray Jensen Murray.Jensen@cmst.csiro.au
(C) Copyright 2010 Linaro LTD, www.linaro.org Author: John Rigby john.rigby@linaro.org Based on TI's signGP.c;(C) Copyright 2009 Stefano Babic, DENX Software Engineering, sbabic@denx.de;(C) Copyright 2008 Marvell Semiconductor www.marvell.com Written-by: Prafulla Wadaskar prafulla@marvell.com
Copyright (c) 2016 Google, Inc
Copyright (c) 2011 The Chromium OS Authors.
Copyright (c) 2012 The Chromium OS Authors. Use of this source code is governed by a BSD-style license that can be found in the LICENSE file.
(C) Copyright 2000-2004 DENX Software Engineering Wolfgang Denk, wd@denx.de
Copyright (c) 2018, Bootlin Author: Miquel Raynal miquel.raynal@bootlin.com
Copyright (c) 2011 The Chromium OS Authors. All rights reserved.
Copyright (C) 2012 Samsung Electronics
Copyright (c) 2013 Google, Inc
Copyright (C) Microsoft Corporation
(C) Copyright 2010 Linaro LTD, www.linaro.org Author John Rigby john.rigby@linaro.org
Copyright (C) 2016, STMicroelectronics - All Rights Reserved Author(s): Christophe Ricard christophe-h.ricard@st.com for STMicroelectronics.
(C) Copyright 2001 Paolo Scaffardi, AIRVENT SAM s.p.a - RIMINI(ITALY), arsenio@tin.it
Copyright (c) 2015 Google, Inc Written by Simon Glass sjg@chromium.org
Copyright 2019 Google LLC
Copyright (C) 2017 Andes Technology Chih-Mao Chen cmchen@andestech.com
Copyright (C) 2019 Luca Ceresoli luca@lucaceresoli.net
Copyright (C) 2011 Infineon Technologies
Copyright (c) 2015 Google, Inc
Copyright (c) 2016 Google, Inc Written by Simon Glass sjg@chromium.org
Copyright (c) 2017 Google, Inc Written by Simon Glass sjg@chromium.org
Copyright (C) 2013 Guntermann & Drunck, GmbH
Copyright (c) 2018 Google, Inc Written by Simon Glass sjg@chromium.org
Copyright 2018 Google LLC
Copyright (C) 2015-2016 Freescale Semiconductor, Inc.
Copyright (c) 2016, Freescale Semiconductor, Inc. All rights reserved.
Copyright 2020 NXP
Copyright (c) 2016, Freescale Semiconductor, Inc.
Copyright (C) 2015-2016 Freescale Semiconductor, Inc.
Copyright (C) 2016 The Android Open Source Project
Copyright 2019 Google LLC Written by Simon Glass sjg@chromium.org
Copyright 2014 Broadcom Corporation.
(C) Copyright 2008 - 2009 Windriver, www.windriver.com Tom Rix Tom.Rix@windriver.com
Copyright (C) 2017, Bin Meng bmeng.cn@gmail.com
Copyright 2014 Broadcom Corporation.
Copyright (c) 2015 Google, Inc Written by Simon Glass sjg@chromium.org
(C) Copyright 2000-2007 Wolfgang Denk, DENX Software Engineering, wd@denx.de.
Copyright (C) 2015 Google, Inc Written by Simon Glass sjg@chromium.org

(C) Copyright 2001 Denis Peter, MPL AG Switzerland
Copyright (C) 2017 Vasily Khoruzhick anarsoul@gmail.com
Copyright (C) 2018, Bin Meng bmeng.cn@gmail.com
Copyright (C) 2016 BayLibre, SAS Author: Neil Armstrong narmstrong@baylibre.com
Copyright (C) 2018 BayLibre, SAS Author: Jorge Ramirez-Ortiz jramirez@baylibre.com
Copyright (C) 2018 BayLibre, SAS
(C) Copyright 2013-2014 Luc Verhaegen libv@skynet.be;(C) Copyright 2014-2015 Hans de Goede hdegoede@redhat.com;(C) Copyright 2017 Icenowy Zheng icenowy@aosc.io
(C) Copyright 2017 Icenowy Zheng icenowy@aosc.io
Copyright (C) 2015 Amlogic, Inc. All rights reserved.
Copyright (C) 2019 STMicroelectronics - All Rights Reserved Author(s): Yannick Fertre yannick.fertre@st.com for STMicroelectronics. Philippe Cornu philippe.cornu@st.com for STMicroelectronics.
(C) Copyright 2002 ELTEC Elektronik AG Frank Gottschling fgottschling@eltec.de
Copyright (C) 2014 Freescale Semiconductor, Inc. All Rights Reserved.
Copyright (C) 2009 Guennadi Liakhovetski, DENX Software Engineering, lg@denx.de
(C) Copyright 2018 Liviu Dudau liviu@dudau.co.uk;(C) 2012 Texas Instruments
(C) 2015 Hans de Goede hdegoede@redhat.com
Copyright (C) 2013-2018 Hannes Schmelzer oe5hpm@oevsv.at B&R Industrial Automation GmbH - <http://www.br-automation.com>
(C) Copyright 2007 DENX Software Engineering, Anatolij Gustschin, agust@denx.de
Copyright (c) 2017 Google, Inc
Copyright (c) 2015 Google, Inc;(C) Copyright 2001-2015
Copyright (C) 2017 Google, Inc Written by Simon Glass sjg@chromium.org
(C) Copyright 2016 Dirk Eibach, Guntermann & Drunck GmbH, dirk.eibach@gdsys.cc
Copyright (C) 2011-2013 Marek Vasut marex@denx.de
(C) Copyright 2004 Pierre Aubert, Staubli Faverges , p.aubert@staubli.com
(C) Copyright 2001-2002 Wolfgang Denk, DENX Software Engineering -- wd@denx.de
Copyright 2014 Freescale Semiconductor, Inc.
(C) Copyright 2010 Texas Instruments, www.ti.com Syed Mohammed Khasim khasim@ti.com
Copyright (c) 2015 Google, Inc;(C) Copyright 2015 Bernecker & Rainer Industrieelektronik GmbH - <http://www.br-automation.com>
(C) Copyright 2017 Mario Six, Guntermann & Drunck GmbH, mario.six@gdsys.cc;(C) Copyright 2010 Dirk Eibach, Guntermann & Drunck GmbH, dirk.eibach@gdsys.de
Copyright (C) 2016, Bin Meng bmeng.cn@gmail.com
Copyright (c) 2013 Adapted from Linux driver:
Copyright (C) 2012 Atmel Corporation
(C) Copyright 2004 Pierre Aubert, Staubli Faverges , p.aubert@staubli.com
(C) Copyright 2013-2014 Luc Verhaegen libv@skynet.be;(C) Copyright 2014-2015 Hans de Goede hdegoede@redhat.com;(C) Copyright 2017 Jernej Skrabec jernej.skrabec@siol.net
(C) Copyright 2013-2014 Luc Verhaegen libv@skynet.be;(C) Copyright 2014-2015 Hans de Goede hdegoede@redhat.com
(C) Copyright 2017 Vasily Khoruzhick anarsoul@gmail.com
(C) Copyright 2017 Jernej Skrabec jernej.skrabec@siol.net
(C) 2015 Siarhei Siamashka siarhei.siamashka@gmail.com
(C) Copyright 2010 Stefano Babic, DENX Software Engineering, sbabic@denx.de;(C) Copyright 2004-2010 Freescale Semiconductor, Inc.
Copyright 2018 Google, Inc Written by Simon Glass sjg@chromium.org
(C) Copyright 2010 Stefano Babic, DENX Software Engineering, sbabic@denx.de;(C) Copyright 2005-2010 Freescale Semiconductor, Inc.
(C) Copyright 2010 Stefano Babic, DENX Software Engineering, sbabic@denx.de;(C) Copyright 2005-2009 Freescale Semiconductor, Inc.
Copyright 2018 Google, Inc
Copyright 2017-2018 NXP
Copyright (C) 2016 Google, Inc Written by Simon Glass sjg@chromium.org
Copyright (C) 2016-2017 Cadence Design Systems, Inc. All rights reserved worldwide.
Copyright (C) 2017 Cadence Design Systems, Inc. All rights reserved worldwide.
Copyright (C) 2015-2017 Cadence Design Systems, Inc. All rights reserved worldwide.

LICENCE TERMS (cont.)

Copyright (C) 2015-2016 Cadence Design Systems, Inc. All rights reserved worldwide.
(C) Copyright 2007 Heiko Schocher, DENX Software Engineering, <hs@denx.de>
Copyright (C) 2018 Michal Simek <michal.simek@xilinx.com>
Copyright © 2016 NextThing Co.
Copyright 2008 Extreme Engineering Solutions, Inc.
(C) Copyright 2011 Free Electrons David Wagner <david.wagner@free-electrons.com>;(C) Copyright 2001 Paolo Scaffardi, AIRVENT SAM s.p.a - RIMINI(ITALY), arsenio@tin.it
Copyright (c) 2018, Heinrich Schuchardt <xypron.glpk@gmx.de> -->
Copyright (C) 2011 The ChromiumOS Authors.
Copyright (C) 2011 Marek Vasut <marek.vasut@gmail.com> on behalf of DENX Software Engineering GmbH
(C) Copyright 2011 Heiko Schocher, DENX Software Engineering, hs@denx.de.:(C) Copyright 2009 Stefano Babic, DENX Software Engineering, sbabic@denx.de.
Copyright (C) 2015 Nathan Rossi <nathan@nathanrossi.com>
Copyright 2017 NXP
(C) Copyright 2008 Semihalf
Copyright (C) 2018, STMicroelectronics - All Rights Reserved
Copyright (C) 2012-2013 Marek Vasut <marek@denx.de>
(C) Copyright 2007-2011 Allwinner Technology Co., Ltd. <www.allwinnertech.com> Tom Cubie <tangliang@allwinnertech.com>
(C) Copyright 2011 Heiko Schocher, DENX Software Engineering, hs@denx.de.:(C) Copyright 2009 Stefano Babic, DENX Software Engineering, sbabic@denx.de.:(C) Copyright 2008 Marvell Semiconductor <www.marvell.com>
Written-by: Prafulla Wadaskar <prafulla@marvell.com>
(C) Copyright 2015 DENX Software Engineering GmbH Written-by: Albert ARIBAUD <albert.aribaud@3adev.fr>;(C) Copyright 2010 Linaro LTD, www.linaro.org Author: John Rigby <john.rigby@linaro.org> Based on TI's signGP.c.:(C) Copyright 2009 Stefano Babic, DENX Software Engineering, sbabic@denx.de.:(C) Copyright 2008 Marvell Semiconductor <www.marvell.com> Written-by: Prafulla Wadaskar <prafulla@marvell.com>
(C) Copyright 2016 Olliver Schinagl <oliver@schinagl.nl>
Copyright 2015-2017 Freescale Semiconductor, Inc.
(C) Copyright 2010 Stefano Babic, DENX Software Engineering, sbabic@denx.de.:(C) Copyright 2004-2009 Freescale Semiconductor, Inc.
Copyright (c) 2016 Freescale Semiconductor, Inc.
Copyright (C) 2005-2011 Canonical Ltd
Copyright (C) 2016 Freescale Semiconductor, Inc. All Rights Reserved.
Copyright (c) 2005-2016 Freescale Semiconductor, Inc.
Copyright 2016-2019 NXP
Copyright (c) 2012, Pablo Impallari (www.impallari.com|impallari@gmail.com), Rodrigo Fuenzalida (www.rfuenzalida.com|helo@rfuenzalida.com)
(C) Copyright 2000-2010 Wolfgang Denk, DENX Software Engineering, wd@denx.de.:(C) Copyright 2001 Sysgo Real-Time Solutions, GmbH <www.elinos.com> Andreas Heppel <aheppel@sysgo.de>
(c) Copyright 2011 by Tigris Elektronik GmbH
Copyright (URW)++,Copyright 1999 by (URW)++ Design & Development; Cyrillic glyphs added by Valek Filippov (C) 2001-2005Nimbus Sans LNimbus Sans LRegularRegularFontForge 2.0 : Nimbus Sans L Regular : 8-10-2014FontForge 2.0
(C) Copyright 2010-2016 Freescale Semiconductor, Inc.
Copyright (c) 2007 Lithu K Kumar, Hiran Venugopalan <hiran.in|hiran.v@gmail.com>
Copyright (c) 2010, Andrey Makarov (makarov@bmsu.ru, mka-at-mailru@mail.ru), with Reserved Font Name Anka/Coder Narrow.
(C) Copyright 2004-2006 Wolfgang Denk, DENX Software Engineering, wd@denx.de.
(C) Copyright 2011-2012 Freescale Semiconductor, Inc.
(C) Copyright 2011 Stefano Babic, DENX Software Engineering, sbabic@denx.de.
(c) Copyright 2016 by VRT Technology.:(c) Copyright 2011 by Tigris Elektronik GmbH.:(C) Copyright 2011 - 2012 Samsung Electronics EXT4 filesystem implementation in Uboot by Uma Shankar <uma.shankar@samsung.com> Manjunatha C Achar <a.manjunatha@samsung.com>
(C) Copyright 2012 Joe Hershberger, National Instruments, joe.hershberger@ni.com
(C) Copyright 2000-2010 Wolfgang Denk, DENX Software Engineering, wd@denx.de.:(C) Copyright 2008 Stuart Wood, Lab X Technologies <stuart.wood@labxtechnologies.com>;(C) Copyright 2004 Jian Zhang, Texas Instruments, jzhang@ti.com.:(C) Copyright 2001 Sysgo Real-Time Solutions, GmbH <www.elinos.com> Andreas

Heppel <aheppel@sysgo.de>
(C) Copyright 2001 Erik Theisen, Wave 7 Optics, etheisen@mindspring.com.
(C) Copyright 2000-2010 Wolfgang Denk, DENX Software Engineering, wd@denx.de.:(C) Copyright 2001 Sysgo Real-Time Solutions, GmbH <www.elinos.com> Andreas Heppel <aheppel@sysgo.de>;(C) Copyright 2008 Atmel Corporation
(C) Copyright 2010 DENX Software Engineering Wolfgang Denk <wd@denx.de>;(C) Copyright 2005-2009 Samsung Electronics Kyungmin Park <kyungmin.park@samsung.com>
(c) Copyright 2012 by National Instruments, Joe Hershberger <joe.hershberger@ni.com>
(C) Copyright 2008-2011 Freescale Semiconductor, Inc.
Copyright 2003 Tungsten Graphics, Inc., Cedar Park, Texas. All Rights Reserved.
Copyright (C) 2012 Samsung Electronics Donghwa Lee <dh09.lee@samsung.com>
(C) Copyright 2017 Rob Clark
(C) Copyright 2002 Wolfgang Denk, DENX Software Engineering, wd@denx.de.
Copyright (C) STMicroelectronics SA 2017
Copyright (C) 2019 STMicroelectronics - All Rights Reserved Author(s): Philippe Cornu <philippe.cornu@st.com> for STMicroelectronics. Yannick Fertre <yannick.fertre@st.com> for STMicroelectronics.
Copyright (C) 2017-2018 STMicroelectronics - All Rights Reserved Author(s): Philippe Cornu <philippe.cornu@st.com> for STMicroelectronics. Yannick Fertre <yannick.fertre@st.com> for STMicroelectronics.
Copyright (C) 2015 Hans de Goede <hdegoede@redhat.com>
Copyright (C) 2002 Wolfgang Denk <wd@denx.de>
Copyright (c) 2017, Fuzhou Rockchip Electronics Co., Ltd Author: Eric Gao <eric.gao@rock-chips.com>
Copyright (c) 2017 Theobroma Systems Design und Consulting GmbH
Copyright (c) 2015 Google, Inc
Copyright (c) 2017 Theobroma Systems Design und Consulting GmbH
Copyright 2016 Rockchip Inc.
Copyright (C) 1993, 2003, 2004, 2005, 2006, 2007 Free Software Foundation, Inc.
Copyright (C) 2007 Wolfgang Denk, DENX Software Engineering, wd@denx.de.
(C) Copyright 2016-2018 ARM Ltd. Author: Liviu Dudau <liviu.dudau@foss.arm.com>
Copyright (C) 2019 STMicroelectronics - All Rights Reserved Author(s): Yannick Fertre <yannick.fertre@st.com> for STMicroelectronics.
(C) Copyright 2007 Wolfgang Denk, DENX Software Engineering, wd@denx.de.
Copyright (C) 2007 Wolfgang Denk, DENX Software Engineering, wd@denx.de.:(c) if ((c) != ok) failed++ define ORD(a, b) (!__builtin_isunordered ((a), (b))) define UNORD(a, b) (__builtin_isunordered ((a), (b))) define UNEQ(a, b) (__builtin_isunordered ((a), (b)) || ((a) == (b))) define UNLT(a, b) (__builtin_isunordered ((a), (b)) || ((a) < (b))) define UNLE(a, b) (__bu
Copyright (C) 2007 Atmel Corporation
(C) Copyright 2002-2007 Wolfgang Denk, DENX Software Engineering, wd@denx.de.
Copyright 2014 Google Inc.
(C) Copyright 2010 Eastman Kodak Company, <www.kodak.com> Michael Zaidman, <michael.zaidman@kodak.com>
(C) Copyright 2015 Hans de Goede <hdegoede@redhat.com>
Copyright (C) 2013-2018 Hannes Schmelzer <oe5hpm@oevsv.at> - B&R Industrial Automation GmbH - http://www.br-automation.com
Copyright (C) 2014-2016 Freescale Semiconductor, Inc. All Rights Reserved.
Copyright (c) 2005-2011 Analog Devices Inc.
Copyright (C) 2016 Google, Inc
Copyright (C) 2017, STMicroelectronics - All Rights Reserved Author: Patrick Delaunay <patrick.delaunay@st.com>
Copyright (C) 2012-2013, Samsung Electronics, Co., Ltd.
Copyright (c) 2012, The Chromium Authors
Copyright (C) 2016, Fuzhou Rockchip Electronics Co., Ltd
(C) Copyright 2005-2009 Jens Scharsig @ BuS Elektronik GmbH & Co. KG, <esw@bus-elektronik.de>
(C) Copyright 2018 Mario Six, Guntermann & Drunck GmbH, mario.six@gdsys.cc
(C) Copyright 2015 Joe Hershberger, National Instruments, joe.hershberger@ni.com
Copyright (c) 2018, Google Inc. All rights reserved.
Copyright (c) 2015 Stephen Warren
Copyright (c) 2014, NVIDIA Corporation.
Copyright (c) 2011-2013, NVIDIA Corporation.

LICENCE TERMS (cont.)

Copyright (c) 2016, NVIDIA CORPORATION. All rights reserved.
Copyright (c) 2011-2013, NVIDIA Corporation.
Copyright (c) 2015-2016, NVIDIA CORPORATION. All rights reserved.
(C) Copyright 2012 Stephen Warren
(C) Copyright 2017 Mario Six, Guntermann & Drunck GmbH, mario.six@gdsys.cc
Copyright (c) 2018, Linaro Limited
Copyright (C) 2010-2016 Freescale Semiconductor, Inc. All Rights Reserved.
Copyright (c) 2020 Author: Sam Protsenko <joe.skb7@gmail.com>
(C) Copyright 2018 Texas Instruments, <www.ti.com>
Copyright (c) 2016, Google Inc.
Copyright (c) 2016, Xilinx Inc. Michal Simek
Copyright (c) 2016, NVIDIA CORPORATION. All rights reserved.
Copyright 2007, 2010-2011 Freescale Semiconductor, Inc. Authors: York Sun <yorksun@freescale.com> Timur Tabi <timur@freescale.com>
Copyright (C) 2019, STMicroelectronics - All Rights Reserved
Copyright (c) 2017, Heinrich Schuchardt <xypron.glpk@gmx.de>
Copyright 2007 Freescale Semiconductor, Inc. Zhang Wei <wei.zhang@freescale.com> Jason Jin <jason.jin@freescale.com>
(C) Copyright 2014 Freescale Semiconductor, Inc. Author: Nitin Garg <nitin.garg@freescale.com>
Copyright (c) 2020, F-Secure Corporation, <https://foundry.f-secure.com>
(C) Copyright 2014 Freescale Semiconductor, Inc
Copyright (c) 2018, Xilinx Inc.
(C) Copyright 2014 Freescale Semiconductor, Inc. Author: Nitin Garg <nitin.garg@freescale.com> Ye Li <Ye.Li@freescale.com>
Copyright 2017-2019 NXP
Copyright (C) 2018-2019 Texas Instruments Incorporated - <http://www.ti.com/> Lokesh Vutla <lokeshvutla@ti.com>
Copyright (c) 2019, Texas Instrument Author: Jean-Jacques Hiblot <jjhiblot@ti.com>
(C) Copyright 2015 Texas Instruments Incorporated - <http://www.ti.com/>
Copyright (c) 2018, Linaro Limited Author: Takahiro Akashi <takahiro.akashi@linaro.org>
Copyright (C) 2018 Texas Instruments Incorporated - <http://www.ti.com/> Lokesh Vutla <lokeshvutla@ti.com>
Copyright (C) 2018-2019 Texas Instruments Incorporated - <http://www.ti.com/> Lokesh Vutla <lokeshvutla@ti.com> Suman Anna <s-anna@ti.com>
Copyright (c) 2019, Texas Instrument Author: JJ Hiblot <jjhiblot@ti.com>
Copyright (C) 2017-2018 Texas Instruments Incorporated - <http://www.ti.com/> Lokesh Vutla <lokeshvutla@ti.com>
(C) Copyright 2015-2016 Texas Instruments Incorporated - <http://www.ti.com/>
Copyright (c) 2017 Alison Chaiken
Copyright (c) 2013, Google Inc.
Copyright (C) 2020 Sean Anderson
Copyright (c) 2015 Google, Inc Wolfgang Denk, DENX Software Engineering, wd@denx.de.
Copyright (c) 2018, NVIDIA CORPORATION. All rights reserved.
Copyright (c) 2019, Cristian Ciocaltea <cristian.ciocaltea@gmail.com>
Copyright (C) 2017 Álvaro Fernández Rojas <noltari@gmail.com>
Copyright (c) 2016 NextThing Co
(C) Copyright 2016 Cadence Design Systems Inc.
Copyright (C) 2019 Pepperl+Fuchs Simon Goldschmidt <simon.k.r.goldschmidt@gmail.com>
(C) Copyright 2012 The Chromium Authors
Copyright (c) 2015 National Instruments, Inc
(C) Copyright 2019 Roman Kapl, SYSGO, rka@sysgo.com
Copyright (C) 2018 Texas Instruments Incorporated - <http://www.ti.com/> Andreas Dannenberg <dannenberg@ti.com>
Copyright (C) 2013 Google, Inc
Copyright (C) 2017 Masahiro Yamada <yamada.masahiro@socionext.com>
Copyright (c) 2013 Google, Inc;(C) Copyright 2012 Pavel Herrmann <morpheus.ibis@gmail.com>
Copyright (C) 2018 Xilinx, Inc. - Michal Simek
(C) Copyright 2016 Google, Inc
Copyright 2018 Google LLC Written by Simon Glass <sjg@chromium.org>
(C) Copyright 2019 - Texas Instruments Incorporated - <http://www.ti.com/> Jean-Jacques Hiblot <jjhiblot@ti.com>
(C) Copyright 2013 Heiko Schocher, DENX Software Engineering, hs@denx.de.
(C) Copyright 2018 Theobroma Systems Design und Consulting GmbH
Copyright (C) 2019 Ramon Fried
(C) Copyright 2010-2012 Stefan Roese, DENX Software Engineering, sr@denx.de.
Copyright (c) 2017 General Electric Company. All rights reserved.
(C) Copyright 2019 Alex Marginean, NXP
(C) Copyright 2010 Heiko Schocher, DENX Software Engineering, hs@denx.de.
(C) Copyright 2019 Collabora;(C) Copyright 2019 GE
Copyright (C) 2015 Thomas Chou <thomas@wytron.com.tw>
(C) Copyright 2011 Heiko Schocher, DENX Software Engineering, hs@denx.de.
Copyright (c) 2018 Linaro Limited
(C) 2018 Theobroma Systems Design und Consulting GmbH
(C) Copyright 2015 Mateusz Kulikowski <mateusz.kulikowski@gmail.com>
Copyright (c) 2015-2018, Linaro Limited
Copyright (C) 2017 Google, Inc
Copyright (C) 2015 Google, Inc
Copyright (c) 2016-2018, Linaro Limited
Copyright (c) 2014 Google, Inc Written by Simon Glass <sjg@chromium.org>
Copyright (c) 2015 Samsung Electronics Przemyslaw Marczak <p.marczak@samsung.com>
Copyright (C) 2018 Linaro Limited
Copyright (C) 2019 Lukasz Majewski, DENX Software Engineering, lukma@denx.de
(C) Copyright 2007 Matthias Fuchs, esd gmbh, matthias.fuchs@esd-electronics.com.
Copyright (c) 2017, General Electric Company
(C) Copyright 2001-2006 Wolfgang Denk, DENX Software Engineering, wd@denx.de. ccflags-y += -DDEBUG
(C) Copyright 2018 Lukasz Majewski, DENX Software Engineering, lukma@denx.de.:(C) Copyright 2008 Stefan Roese, DENX Software Engineering, sr@denx.de.:(c) mycable GmbH
(C) Copyright 2001 ARIOD Data Networks, Inc. dchiu@ariodata.com
(C) Copyright 2002 ARIOD Data Networks, Inc. dchiu@ariodata.com
(C) Copyright 2019, Vaisala Oyj
(C) Copyright 2009-2012 ADVANSEE
(C) Copyright 2002 SIXNET, dge@sixnetio.com.:(C) Copyright 2004, Li-Pro.Net <www.li-pro.net> Stephan Linz <linz@li-pro.net>
Copyright (c) 2018, STMicroelectronics
Copyright (C) 2012 Philippe Reynes <tremyfr@yahoo.fr>
(C) Copyright 2008 Tor Krill, Excito Elektronik i Skåne , tor@excito.com
(C) Copyright 2001 Sysgo Real-Time Solutions, GmbH <www.elinos.com> Andreas Heppel <aheppel@sysgo.de>
(C) Copyright 2003 David Müller ELISOFT AG Switzerland. d.mueller@elsoft.ch
(C) Copyright 2001, 2002, 2003 Wolfgang Denk, DENX Software Engineering, wd@denx.de. Keith Outwater, keith_outwater@mvis.com` Steven Scholz, steven.scholz@imc-berlin.de
Copyright (C) 2018 Texas Instruments Incorporated <www.ti.com> Grygorii Strashko <grygorii.strashko@ti.com>
Copyright (c) 2015 National Instruments;(C) Copyright 2015 Joe Hershberger <joe.hershberger@ni.com>
(C) Copyright 2007 Stefan Roese, DENX Software Engineering, sr@denx.de.
(C) Copyright 2009 Faraday Technology Po-Yu Chuang <ratbert@faraday-tech.com>
(C) Copyright 2002 Andrew May, Viasat Inc, amay@viasat.com
Copyright (C) 2004 Gary Jennejohn garyj@denx.de;(C) Copyright 2001, 2002, 2003 Wolfgang Denk, DENX Software Engineering, wd@denx.de. Keith Outwater, keith_outwater@mvis.com` Steven Scholz, steven.scholz@imc-berlin.de
Copyright (C) 2008, Guennadi Liakhovetski <lg@denx.de>
(C) Copyright 2007 Larry Johnson, lrj@acm.org;(C) Copyright 2002 Andrew May, Viasat Inc, amay@viasat.com
(C) Copyright 2011 DENX Software Engineering GmbH Heiko Schocher <hs@denx.de>
Copyright (C) 2016 by NXP Semiconductors Inc. Date & Time support for PCF2127 RTC
Copyright 2010 Freescale Semiconductor, Inc.
Copyright (C) 2005-06 Tower Technologies Author: Alessandro Zummo <a.zummo@towertech.it>
(C) Copyright 2001-2008 Wolfgang Denk, DENX Software Engineering, wd@denx.de. Keith Outwater, keith_outwater@mvis.com`
Copyright (C) 2011 Jason Cooper <u-boot@lakedaemon.net>
(C) Copyright 2008 Gururaja Hebbar gururajakr@sanyo.co.in
Copyright (C) 2017 Texas Instruments Incorporated - <http://www.ti.com/> Written by Jean-Jacques Hiblot <jjhiblot@

LICENCE TERMS (cont.)

ti.com>
Copyright (C) 2018 Ramon Fried <ramon.fried@gmail.com>
(C) Copyright 2010 Reinhard Meyer, reinhard.meyer@emk-elektronik.de
(C) Copyright 2006 Markus Klotzbuecher, mk@denx.de;(C) Copyright 2019 NXP Chuanhua Han <chuanhua.han@nxp.com>
Copyright (c) 2018 Heinrich Schuchardt <xypron.glpk@gmx.de>
(C) Copyright 2004 Wolfgang Denk, DENX Software Engineering, wd@denx.de.
(C) Copyright 2018 Mario Six, Guntermann & Drunck GmbH, mario.six@gdsys.cc obj-y += cmd_ut_lib.o obj-y += hexdump.o obj-y += lmb.o obj-y += string.o obj-\$(CONFIG_ERRNO_STR) += test_errno_str.o obj-\$(CONFIG_UT_LIB_ASN1) += asn1.o obj-\$(CONFIG_AES) += test_aes.o
Copyright (C) 2008 Kim B. Heino
Copyright (c) 2019 Heinrich Schuchardt <xypron.glpk@gmx.de>
(C) Copyright 2001 Denis Peter MPL AG Switzerland. d.peter@mpl.ch
Copyright (c) 2019 Philippe Reynes <philippe.reynes@softathome.com>
(C) Copyright 2018 Simon Goldschmidt
Copyright (C) 2004-2007 Freescale Semiconductor, Inc. TsiChung Liew (Tsi-Chung.Liew@freescale.com)
Copyright (c) 2019 Linaro Limited Author: AKASHI Takahiro
Copyright (C) 2017 Marek Vasut <marek.vasut@gmail.com>
Copyright (C) 2019, Theobroma Systems Design und Consulting GmbH
Copyright (c) 2015 Microchip Technology Inc Purna Chandra Mandal <purna.mandal@microchip.com>
Copyright (C) 2015 Bhuvanchandra DV, Toradex, Inc.
Copyright (C) 2008 Magnus Damm
Copyright (C) 2016 Peng Fan <van.freenix@gmail.com>
Copyright (C) 2020 Cortina-Access
Copyright 2008-2013 Analog Devices Inc.
Copyright (c) 2013, The Chromium Authors
(C) Copyright 2011 eInfochips Ltd. <www.einfochips.com> Written-by: Ajay Bhargav <contact@8051projects.net>;(C) Copyright 2010 Marvell Semiconductor <www.marvell.com>
(C) Copyright 2014 Suriyan Ramasami
Copyright 2000-2008 Wolfgang Denk, DENX Software Engineering, wd@denx.de.
(C) Copyright 2015 Stephen Warren
(C) Copyright 2015 Google, Inc.:(C) Copyright 2008-2014 Rockchip Electronics Peter, Software Engineering, <superpeter.cai@gmail.com>.
Copyright (c) 2018, Heinrich Schuchardt <xypron.glpk@gmx.de>
(C) Copyright 2002 Gerald Van Baren, Custom IDEAS, vanbaren@cideas.com
Copyright (C) 2019 Eugeniu Rosca <rosca.eugeniu@gmail.com>
Copyright (C) 2015 Atmel Corporation Wenyou.Yang <wenyou.yang@atmel.com>
Copyright (c) 2018 AKASHI Takahiro, Linaro Limited
(C) Copyright 2010 Marvell Semiconductor <www.marvell.com> Written-by: Prafulla Wadaskar <prafulla@marvell.com>,
Copyright (C) 2015 DAVE Embedded Systems <devel@dave.eu>
(C) Copyright 2000, 2001 Wolfgang Denk, DENX Software Engineering, wd@denx.de.
(C) Copyright 2002 Richard Jones, rjones@nexus-tech.net
(C) Copyright 2003 Stefan Roese, stefan.roese@esd-electronics.com
Copyright 2008 - 2009 Windriver, <www.windriver.com> Author: Tom Rix <Tom.Rix@windriver.com>;(C) Copyright 2014 Linaro, Ltd. Rob Herring <robh@kernel.org>
Copyright (c) 2016 Alexander Graf
Copyright (C) 2011 Corscience GmbH & Co. KG - Simon Schwarz <schwarz@corscience.de>
(C) Copyright 2011 Dirk Eibach, Guntermann & Drunck GmbH, dirk.eibach@gdsys.cc
(C) Copyright 2016 Dirk Eibach, Guntermann & Drunck GmbH, dirk.eibach@gdsys.cc;(C) Copyright 2017, 2018 Mario Six, Guntermann & Drunck GmbH, mario.six@gdsys.cc
Copyright 2013 Texas Instruments, Inc. Author: Dan Murphy <dmurphy@ti.com>
(C) Copyright 2009 Sergey Kubushyn, himself, ksi@koi8.net
Copyright (c) 2018 Microsemi Corporation
Copyright (C) 2000-2005, DENX Software Engineering Wolfgang Denk <wd@denx.de>
Copyright (C) 2016 Texas Instruments Incorporated - http://www.ti.com/
Copyright (c) 2009 Wind River Systems, Inc. Tom Rix <Tom.Rix@windriver.com>

Copyright (C) 2017 Synopsys Author: Eugeniy Paltsev <Eugeniy.Paltsev@synopsys.com>
Copyright 2010-2011 Calxeda, Inc.
Copyright (C) 2018 Stefan Roese <sr@denx.de>
Copyright (C) 2017, STMicroelectronics - All Rights Reserved Author(s): Vikas Manocha, <vikas.manocha@st.com> for STMicroelectronics.
(C) Copyright 2015 Marek Vasut <marex@denx.de>
(C) Copyright 2011 - 2012 Samsung Electronics EXT4 filesystem implementation in Uboot by Uma Shankar <uma.shankar@samsung.com> Manjunatha C Achar <a.manjunatha@samsung.com>;(C) Copyright 2004 esd gmbh <www.esd-electronics.com> Reinhard Arit <reinhard.arit@esd-electronics.com>;(C) Copyright 2003 - 2004 Sysgo Real-Time Solutions, AG <www.elinos.com> Pavel Bartusek <pba@sysgo.com>
Copyright (C) 2012 Vikram Narayanan vikram186@gmail.com>
(C) Copyright 2009 Samsung Electronics Minkyu Kang <mk7.kang@samsung.com>
(C) Copyright 2000-2011 Wolfgang Denk, DENX Software Engineering, wd@denx.de.
Copyright (C) 2016-2017 Socionext Inc. Author: Masahiro Yamada <yamada.masahiro@socionext.com>
Copyright (C) 2015 Lukasz Majewski <l.majewski@majess.pl>
Copyright (C) 2016 Stefan Roese <sr@denx.de>
(C) Copyright 2000-2009 Wolfgang Denk, DENX Software Engineering, wd@denx.de.
Copyright (C) 2015 Linaro Peter Griffin <peter.griffin@linaro.org>
Copyright 2008 Freescale Semiconductor, Inc.
Copyright (C) 2019 Marek Vasut <marek.vasut@gmail.com>
(C) Copyright 2003 - 2004 Sysgo Real-Time Solutions, AG <www.elinos.com> Pavel Bartusek <pba@sysgo.com>
Copyright (C) 2013 Curt Brune <curt@cumulusnetworks.com>
Copyright 2013 Broadcom Corporation.
(C) Copyright 2017 Mario Six, Guntermann & Drunck GmbH, mario.six@gdsys.cc;(C) Copyright 2010 Dirk Eibach, Guntermann & Drunck GmbH, eibach@gdsys.de
(C) Copyright 2011 Guralp Systems Ltd. Laurence Withers <lwithers@guralp.com>
(C) Copyright 2013 Patrice Bouchand <pbfdwlist_gmail_com> lzma uncompress command in Uboot;(C) Copyright 2000 Wolfgang Denk, DENX Software Engineering, wd@denx.de.
(C) Copyright 2010-2012,2015 NVIDIA Corporation <www.nvidia.com>
Copyright (c) 2019, Heinrich Schuchardt <xypron.glpk@gmx.de>
Copyright (c) 2013 - 2018 Xilinx, Michal Simek
(C) Copyright 2016 Mario Six, Guntermann & Drunck GmbH, mario.six@gdsys.cc
Copyright (C) 2016 Toradex Author: Stefan Agner <stefan.agner@toradex.com>
(C) Copyright 2000-2004 Wolfgang Denk, DENX Software Engineering, wd@denx.de.:(C) Copyright 2003 Kai-Uwe Bloem, Auerswald GmbH & Co KG, <linux-development@auerswald.de>
(C) Copyright 2014 DENX Software Engineering GmbH Written-by: Albert ARIBAUD <albert.aribaud@3adev.fr>
(C) Copyright 2011 Freescale Semiconductor, Inc Andy Fleming
Copyright (c) 2010-2016, NVIDIA CORPORATION. based on tegra_gpio.c
Copyright (c) 2012 The Chromium OS Authors.:(C) Copyright 2011 Joe Hershberger, National Instruments, joe.hershberger@ni.com.:(C) Copyright 2000 Wolfgang Denk, DENX Software Engineering, wd@denx.de.
Copyright (C) 2008,2009 STMicroelectronics
(C) Copyright 2011 Andreas Pretzsch, carpe noctem engineering, apr@cn-eng.de
(C) Copyright 2019 Ramon Fried <rfried.dev@gmail.com>
(C) Copyright 2019 DEIF A/S
Copyright (C) 2015 Thomas Chou <thomas@wytron.com.tw>
Copyright (C) 2019 SiFive, Inc.
Copyright (C) 2012-2016 Freescale Semiconductor, Inc.
Copyright (C) 2012 Stefan Roese <sr@denx.de>
(C) Copyright 2018 Microchip Technology, Inc. Eugen Hristev <eugen.hristev@microchip.com>
Copyright (C) 2013 Bo Shen <voice.shen@atmel.com>
(C) Copyright 2012 Lei Wen <leiwen@marvell.com>, Marvell Inc.
(C) Copyright 2012 Henrik Nordstrom <henrik@henriknordstrom.net>;(C) Copyright 2007-2011 Allwinner Technology Co., Ltd. <www.allwinnertech.com> Tom Cubie <tangliang@allwinnertech.com>
(C) Copyright 2011 Joe Hershberger, National Instruments, joe.hershberger@ni.com.:(C) Copyright 2000 Wolfgang Denk, DENX Software Engineering, wd@denx.de.
Copyright: Bootlin, 2018 Author: Miquel Raynal <miquel.raynal@bootlin.com>
(C) Copyright 2000 Subodh Nijssure, SkyStream Networks, snijssure@skystream.com

LICENCE TERMS (cont.)

Copyright (c) 2011-2018 Xilinx Inc.
(C) Copyright 2007 by OpenMoko, Inc. Author: Harald Welte <laforge@openmoko.org>
(C) Copyright 2013 Dirk Eibach, Guntermann & Drunck GmbH, dirk.eibach@gdsys.cc;(C) Copyright 2000 Wolfgang Denk, DENX Software Engineering, wd@denx.de.
Copyright (C) 2018 MediaTek Inc. Author: Ryder Lee <ryder.lee@mediatek.com>
(C) Copyright 2018, Linaro Limited
(C) Copyright 2008 Wolfgang Denk, DENX Software Engineering, wd@denx.de.
Copyright (C) 2019 Texas Instruments Incorporated - http://www.ti.com
(C) Copyright 2000-2013 Wolfgang Denk, DENX Software Engineering, wd@denx.de.
Copyright 2004 Faraday Technology Corp. (www.faraday-tech.com) Based on sa1100_wdt.c by Oleg Drokin <green@crimea.edu> Based on SoftDog driver by Alan Cox <alan@redhat.com>
(C) Copyright 2007 OpenMoko, Inc. Written by Harald Welte <laforge@openmoko.org>
(C) Copyright 2008 Stefan Roesse, DENX Software Engineering, sr@denx.de.
(C) Copyright 2013 Heiko Schocher, DENX Software Engineering, hs@denx.de.
Copyright (c) 2001 William L. Pitts All rights reserved.
(C) Copyright 2007 Gerald Van Baren, Custom IDEAS, vanbaren@cideas.com Based on code written by: Pantelis Antoniou <pantelis.antoniou@gmail.com> and Matthew McClintock <msm@freescale.com>
Copyright 2000-2009 Wolfgang Denk, DENX Software Engineering, wd@denx.de.
Copyright 2017 CS Systemes d'Information
Copyright (c) 2017 Intel Corporation
(C) Copyright 2001 Denis Peter, MPL AG Switzerland;(C) Copyright 2015 Google, Inc
Copyright (C) 2008 Jean-Christophe PLAGNIOL-VILLARD <plagnioj@jcrosoft.com>
Copyright (C) 2018 BayLibre, SAS Author: Neil Armstrong <narmstrong@baylibre.com>
Copyright (C) 2012 Samsung Electronics Minkyu Kang <mk7.kang@samsung.com>
Copyright (C) 2017 NXP Semiconductors
(C) Copyright 2000-2003 Wolfgang Denk, DENX Software Engineering, wd@denx.de.
Copyright (c) 2012, NVIDIA CORPORATION. All rights reserved.:(C) Copyright 2004 esd gmbh <www.esd-electronics.com> Reinhard Arlt <reinhard.arlt@esd-electronics.com>;(C) Copyright 2003 - 2004 Sysgo Real-Time Solutions, AG <www.elinos.com> Pavel Bartusek <pba@sysgo.com>
Copyright (C) 2012-2017 Texas Instruments Incorporated, <www.ti.com>
Copyright (c) 2018 MediaTek Inc.
(C) Copyright 2020 Sam Protsenko <joe.skb7@gmail.com>
Copyright (c) 2008-2011 Analog Devices Inc.
Copyright (C) 2018 MediaTek Inc. Author: Wu Zou <wu.zou@mediatek.com> Ryder Lee <ryder.lee@mediatek.com>
(c) 1999 Machine Vision Holdings, Inc.
(C) Copyright 2002 Wolfgang Denk, DENX Software Engineering, wd@denx.de.
Copyright (c) 2012, NVIDIA CORPORATION. All rights reserved.
(C) Copyright 2001 Kyle Harris, kharris@nexus-tech.net
(C) Copyright 2007 Michal Simek
(C) Copyright 2009-2013 ADVANSEE
(C) Copyright 2018 Lothar Felte, lothar.felten@gmail.com
Copyright (C) Nelson Integration, LLC 2016 Author: Eric Nelson<eric@nelint.com>
(C) Copyright 2016-2017 Rockchip Inc.
Copyright (c) 2012, Google Inc. All rights reserved.
Copyright (C) 2013 Xilinx, Inc.
(C) Copyright 2018 Rockchip Electronics Co., Ltd.
Copyright (c) 2013 Google, Inc;(C) Copyright 2012 Marek Vasut <marex@denx.de>
(C) Copyright 2015 Google, Inc
(C) Copyright 2003 Tait Electronics Limited, Christchurch, New Zealand
Copyright (c) 2018 JJ Hiblot <jjihblot@ti.com>
(C) Copyright 2017 Theobroma Systems Design und Consulting GmbH
(C) Copyright 2019 Rockchip Electronics Co., Ltd.
(C) Copyright 2017 Rockchip Electronics Co., Ltd.
Copyright (c) 2009, Brush Technology
Copyright (C) 2014-2015 Samsung Electronics Przemyslaw Marczak <p.marczak@samsung.com>
(C) Copyright 2018 DENX Software Engineering, Anatolij Gustschin <agust@denx.de>
(C) Copyright 2019 Rockchip Electronics Co., Ltd.:(C) Copyright 2019 Amarula Solutions
(C) Copyright 2011-2013 Pali Rohar <pali.rohar@gmail.com>
Copyright (C) 2012-2018 Cadence Design Systems, Inc.
Copyright (C) 2017 The Android Open Source Project
Copyright (C) 2012-2019 Cadence Design Systems, Inc.
(C) Copyright 2000 Wolfgang Denk, DENX Software Engineering, wd@denx.de.
Copyright 2006 Freescale Semiconductor York Sun (yorksun@freescale.com)
Copyright (C) 2019 Texas Instruments Incorporated - http://www.ti.com/
Copyright 2008-2009 Freescale Semiconductor, Inc.
Copyright (C) 2013 Lukasz Majewski <l.majewski@samsung.com> All rights reserved.
Copyright (C) 2018, Tuomas Tynkkynen <tuomas.tynkkynen@iki.fi>
Copyright (c) 2008 Analog Devices Inc.
Copyright (C) 2017-2018 Cadence Design Systems, Inc.
Copyright (C) 2008 Atmel Corporation
Copyright (c) 2012, Google Inc.
Copyright 2018, Google Inc. Written by Simon Glass <sjg@chromium.org>
Copyright (C) 2005-2008 Samsung Electronics Kyungmin Park <kyungmin.park@samsung.com>
Copyright (C) 2016 Marvell International Ltd. https://spdx.org/licenses
(C) Copyright 2010 Jason Kridner <jkridner@beagleboard.org>;(C) Copyright 2008 Ulf Samuelsson <ulf.samuelsson@atmel.com>
(C) Copyright 2001 Gerald Van Baren, Custom IDEAS, vanbaren@cideas.com
Copyright (c) 2011 The Chromium OS Authors. All rights reserved. Use of this source code is governed by a BSD-style license that can be found in the LICENSE file.
Copyright (c) 2013 The Chromium OS Authors.:(c) 2013 Guntermann & Drunck GmbH
Copyright (C) 2014, Bachmann electronic GmbH
Copyright (C) 2019 Author(s): Giulio Benetti <giulio.benetti@benettiengineering.com>
(C) Copyright 2000, 2001 Rich Ireland, Enterasys Networks, rireland@enterasys.com.
Copyright 2007, 2010-2011 Freescale Semiconductor, Inc
(C) Copyright 2014 Google, Inc
Copyright (C) 2010 Thomas Chou <thomas@wytron.com.tw>
Copyright (C) 2014-2015, Bin Meng <bmeng.cn@gmail.com>
(C) Copyright 2010 Faraday Technology Dante Su <dantesu@faraday-tech.com>
Copyright (c) 2013 Imagination Technologies Author: Paul Burton <paul.burton@imgtec.com>
Copyright (C) 2008 Samsung Electronics Kyungmin Park <kyungmin.park@samsung.com>
Copyright (C) 2016 Marvell, All Rights Reserved.
Copyright (C) ST-Ericsson SA 2010
Copyright (c) 2011 The Chromium OS Authors. All rights reserved.
Copyright (C) 2011 Renesas Solutions Corp.
Copyright (C) 2015, Google, Inc
Copyright 2008,2010 Freescale Semiconductor, Inc Andy Fleming
Copyright (c) 2017 Google, Inc;(C) Copyright 2000-2011 Wolfgang Denk, DENX Software Engineering, wd@denx.de.
(C) Copyright 2013 - 2015 Xilinx, Inc.
(C) Copyright 2009 Reinhard Arlt, reinhard.arlt@esd-electronics.com;(C) Copyright 2003 Stefan Roesse, stefan.roese@esd-electronics.com
Copyright (C) 2010 Rob Emanuele <rob@emanuele.us> Reinhard Meyer, EMK Elektronik <reinhard.meyer@emk-elektronik.de>
(C) Copyright 2015 Miao Yan <yanmiaobest@gmail.com>
Copyright (C) 2019 Synopsys Author: Eugeny Paltsev <Eugeny.Paltsev@synopsys.com>
(C) Copyright 2015 Linaro peter.griffin <peter.griffin@linaro.org>
(C) Copyright 2006 Wolfgang Denk, DENX Software Engineering, wd@denx.de.
Copyright 2015 Freescale Semiconductor, Inc.
(C) Copyright 2018 Cisco Systems, Inc.:(C) Copyright 2019 Synamedia
(C) Copyright 2018 Linaro Ltd. Sam Protsenko <semen.protsenko@linaro.org> Eugeniu Rosca <rosca.eugeniu@gmail.com>
Copyright (c) 2019 Michael Walle <michael@walle.cc>
(C) Copyright 2008 Texas Instruments, <www.ti.com> Sukumar Ghorai <s-ghorai@ti.com>
Copyright (c) 2016 The Chromium OS Authors.

LICENCE TERMS (cont.)

(C) Copyright 2003 Kyle Harris, kharris@nexus-tech.net
(C) Copyright 2012 SAMSUNG Electronics Jaehoon Chung <jh80.chung@samsung.com>
Copyright (C) 2017 Eddie Cai <eddie.cai.linux@gmail.com>
Copyright 2011, Marvell Semiconductor Inc. Lei Wen <leiwen@marvell.com>
Copyright 2018 Michalis Pappas <mpappas@fastmail.fm>
Copyright (C) 2009 Ilya Yanok, <yanok@emcraft.com>
Copyright 2019 Broadcom.
(C) Copyright 2000-2004 Wolfgang Denk, DENX Software Engineering, wd@denx.de.
Copyright 2019 IBM Corp. Eddie James <ejames@linux.ibm.com>
Copyright (C) 2012 Samsung Electronics Rajeshwari Shinde <rajeshwari.s@samsung.com>
(C) Copyright 2009 SAMSUNG Electronics Minkyu Kang <mk7.kang@samsung.com> Jaehoon Chung <jh80.chung@samsung.com>
(C) Copyright 2003 Wolfgang Denk, DENX Software Engineering, wd@denx.de.
Copyright 2012-2014 Marvell Semiconductor <www.marvell.com> Written-by: Maen Suleiman, Gerald Kerma
(C) Copyright 2002 Detlev Zundel, DENX Software Engineering, dzu@denx.de.
Copyright (C) 2015 Microchip Technology Inc. Andrei Pistorica <andrei.pistorica@microchip.com>
(C) Copyright 2001 Sysgo Real-Time Solutions, GmbH <www.elinos.com> Andreas Heppel <aheppel@sysgo.de>;(C) Copyright 2002 Wolfgang Denk, DENX Software Engineering, wd@denx.de. Wolfgang Grandegger, DENX Software Engineering, wg@denx.de.
Copyright (c) 2018 Bootlin Author: Miquel Raynal <miquel.raynal@bootlin.com>
Copyright (C) 2010 Marek Vasut <marek.vasut@gmail.com>
(C) Copyright 2015 Linus Walleij, Linaro
Copyright (C) 2010 Texas Instruments Incorporated
Copyright (C) 2011 Samsung Electronics Lukasz Majewski <l.majewski@samsung.com>
(C) Copyright 2019 Cortina Access Arthur Li <arthur.li@cortina-access.com>
(C) Copyright Linus Torvalds 1999;(C) Copyright Johannes Erdfelt 1999-2001;(C) Copyright Andreas Gal 1999;(C) Copyright Gregory P. Smith 1999;(C) Copyright Deti Fliegl 1999 (new USB architecture);(C) Copyright Randy Dunlap 2000;(C) Copyright David Brownell 2000 (kernel hotplug, usb_device_id);(C) Copyright Yggdrasil Computing, Inc. 2000 usb_device_id matching changes by Adam J. Richter);(C) Copyright 2001 Denis Peter, MPL AG Switzerland
Copyright (c) 2012 The Chromium OS Authors.
Copyright (C) 2018 Marek Vasut <marek.vasut@gmail.com>
Copyright (c) 2008-2009 Analog Devices Inc. Licensed under the GPL-2 or later.
Copyright (C) 2018 Texas Instruments Incorporated - http://www.ti.com/
Copyright (c) 2011 Sebastian Andrzej Siewior <bigeasy@linutronix.de>
Copyright (C) 2016 Google, Inc Written by Amar <amarendra.xt@samsung.com>
(C) Copyright 2014 CompuLab, Ltd. <www.complab.co.il>
Copyright (C) 2011 Andes Technology Corporation Macpaul Lin, Andes Technology Corporation <macpaul@andestech.com>
(C) Copyright 2000 Wolfgang Denk, DENX Software Engineering, wd@denx.de.:(C) Copyright 2005 JinHua Luo, GuangDong Linux Center, <luo.jinhua@gd-linux.com>
(C) Copyright 2016 Fuzhou Rockchip Electronics Co., Ltd
(C) Copyright 2016 Carlo Caione <carlo@caione.org>
(C) Copyright 2013 Altera Corporation <www.altera.com>
Copyright (C) 2011,2013-2017 Renesas Electronics Corporation
(C) Copyright 2009-2016 CompuLab, Ltd.
Copyright 2008, Freescale Semiconductor, Inc Andy Fleming
(C) 2012 Oleksandr Tymoshenko;(C) 2012 Stephen Warren;(c) and license, which is hence propagated to Oleksandr's tree and here.:(c) 2010 Broadcom
(C) Copyright 2007 Gerald Van Baren, Custom IDEAS, vanbaren@cideas.com
(C) Copyright 2007-2011 Allwinner Technology Co., Ltd. <www.allwinnertech.com> Aaron <leafy.myeh@allwinnertech.com>
Copyright (C) 2019 DENX Software Engineering Lukasz Majewski, DENX Software Engineering, lukma@denx.de
Copyright (C) 2013, Boundary Devices <info@boundarydevices.com>
Copyright 2014, Staubli Faverges Pierre Aubert
Copyright (c) 2009 MontaVista Software, Inc.
Copyright (C) 2015-2016 Raspberry Pi (Trading) Ltd. which is based on mmc-bcm2835.c by Gellert Weisz which is, in turn, based on sdhci-bcm2708.c by Broadcom sdhci-bcm2835.c by Stephen Warren and Oleksandr Tymoshenko
sdhci.c and sdhci-pci.c by Pierre Ossman
Copyright (c) 2011 The Chromium OS Authors.:(C) Copyright 2002-2006 Wolfgang Denk, DENX Software Engineering, wd@denx.de.:(C) Copyright 2002 Sysgo Real-Time Solutions, GmbH <www.elinos.com> Marius Groeger <mgroeger@sysgo.de>
(C) Copyright 2014 Texas Instruments, <www.ti.com>
Copyright (C) 2013 ISEE 2007 SL - Enric Balletbo i Serra <eballetbo@iseebcn.com>
(C) Copyright 2012 SAMSUNG Electronics Jaehoon Chung <jh80.chung@samsung.com> Rajeshwari Shinde <rajeshwari.s@samsung.com>
(C) Copyright 2014 Heiko Schocher, DENX Software Engineering, hs@denx.de.
Copyright (C) 2011 OMICRON electronics GmbH
Copyright 2016 Google Inc.
(C) Copyright 2006 Wolfgang Denk, DENX Software Engineering, wd@denx.de.:(C) Copyright 2001 Erik Theisen, Wave 7 Optics, etheisen@mindspring.com.
(C) Copyright 2012 Texas Instruments Incorporated - http://www.ti.com/ Aneesh V <aneesh@ti.com> Based on common/Makefile.
(C) Copyright 2016 Toradex Author: Stefan Agner <stefan.agner@toradex.com>
(C) Copyright 2016 Texas Instruments, <www.ti.com>
(C) Copyright 2013 Texas Instruments, <www.ti.com>
Copyright (c) 2017-2018 Vasily Khoruzhick <anarsoul@gmail.com>
Copyright (C) 2016 Ladislav Michl <ladis@linux-mips.org>
(C) Copyright 2000-2004 Wolfgang Denk, DENX Software Engineering, wd@denx.de.:(C) Copyright 2011 Texas Instruments, <www.ti.com>
Copyright (C) 2018 Texas Instruments Incorporated - http://www.ti.com/ Based on drivers/firmware/ti_sci.h from Linux.
copyright (c) 2013-2016, ARM Limited and Contributors. All rights reserved.
Copyright (C) 2017 Rockchip Electronic Co.,Ltd
(C) Copyright 2016 Xilinx, Inc.:(C) Copyright 2016 Toradex AG
Copyright (C) 2017 Masahiro Yamada <yamada.masahiro@socionext.com>
Copyright (C) 2019 Fraunhofer AISEC, Lukas Auer <lukas.auer@aisec.fraunhofer.de>
Copyright (C) 2018-2019 Xilinx, Inc.
(C) Copyright 2010 Stefano Babic, DENX Software Engineering, sbabic@denx.de.
(C) Copyright 2003 Steven Scholz, imc Measurement & Control, steven.scholz@imc-berlin.de.:(C) Copyright 2002 Rich Ireland, Enterasys Networks, rireland@enterasys.com.
(C) Copyright 2002 Rich Ireland, Enterasys Networks, rireland@enterasys.com. Keith Outwater, keith_outwater@mvis.com
(C) Copyright 2000-2004 Wolfgang Denk, DENX Software Engineering, wd@denx.de.:(C) Copyright 2012 Ilya Yanok <ilya.yanok@gmail.com>
Copyright (C) 2017 Theobroma Systems Design und Consulting GmbH
(C) Copyright 2012-2013, Xilinx, Michal Simek;(C) Copyright 2012 Joe Hershberger <joe.hershberger@ni.com>
(C) Copyright 2002 Rich Ireland, Enterasys Networks, rireland@enterasys.com.
Copyright (C) 2000,2001 Larry Doolittle <larry@doolittle.boa.org>
Copyright (C) 2018 Intel Corporation <www.intel.com>
(C) Copyright 2007 Eran Liberty, Extricom , eran.liberty@gmail.com
(C) Copyright 2015 Stephen Warren <swarren@wwwdotorg.org>
(C) Copyright 2008 Gary Jennejohn, DENX Software Engineering GmbH, garyj@denx.de.
(C) Copyright 2015 - 2016, Xilinx, Inc, Michal Simek <michal.simek@xilinx.com> Siva Durga Prasad <siva.durga.paladugu@xilinx.com>
Copyright (C) 2012-2017 Altera Corporation <www.altera.com> All rights reserved.
(c) 1999-2002 Matthew Dharm (mdharm-usb@one-eyed-alien.net);(c) 2000 David L. Brown, Jr. (usb-storage@davidb.org);(c) 1999 Michael Gee (michael@linuxspecific.com);(c) 2000 Yggdrasil Computing, Inc.:(C) Copyright 2001 Denis Peter, MPL AG Switzerland Driver model conversion.:(C) Copyright 2015 Google, Inc.:(C) Copyright 2003 Gary Jennejohn, DENX Software Engineering <garyj@denx.de>
(C) Copyright 2012-2013, Xilinx, Michal Simek;(C) Copyright 2002 Rich Ireland, Enterasys Networks, rireland@enterasys.com. Keith Outwater, keith_outwater@mvis.com
Copyright (c) 2019, Softathome
(C) Copyright 2006 Heiko Schocher, hs@denx.de Based on ACE1XK.c
(C) Copyright 2019, Xilinx, Inc, Siva Durga Prasad Paladugu <siva.durga.paladugu@xilinx.com>

LICENCE TERMS (cont.)

Copyright (C) 2012 Altera Corporation <www.altera.com> All rights reserved.
Copyright (c) 2015 - 2019 MediaTek Inc. Author: Chunfeng Yun <chunfeng.yun@mediatek.com> Ryder Lee <ryder.lee@mediatek.com>
Copyright (C) 2009 Sergey Kubushyn <ksi@koi8.net>;(C) Copyright 2000 Paolo Scaffardi, AIRVENT SAM s.p.a - RIMINI(ITALY), arsenio@tin.it
Copyright (c) 2000 William L. Pitts and W. Gerald Hicks All rights reserved.
Copyright (C) 2016 Amarula Solutions
Copyright (c) 2011, Google Inc. All rights reserved.
Copyright (C) 2017 Jagan Teki <jagan@amarulasolutions.com>
(C) Copyright 2015 Bernecker & Rainer Industrieelektronik GmbH - http://www.br-automation.com
Copyright (C) 2018 Texas Instruments Incorporated - http://www.ti.com Written by Jean-Jacques Hiblot <jjhiblot@ti.com>
(C) Copyright 2000 Paolo Scaffardi, AIRVENT SAM s.p.a - RIMINI(ITALY), arsenio@tin.it
Copyright (C) 2018 Álvaro Fernández Rojas <noltari@gmail.com>
(C) Copyright 2018 Linaro Ltd. Sam Protsenko <semen.protsenko@linaro.org>
Copyright (C) 2015-2016 Marvell International Ltd.
(C) Copyright 2001 Gerald Van Baren, Custom IDEAS, vanbaren@cideas.com.
(C) Copyright 2017 Texas Instruments, <www.ti.com>
Copyright (C) 2015-2016 Marvell International Ltd.
Copyright 2009 Analog Devices Inc.
Copyright (c) 2014 Google, Inc.
(C) Copyright 2008 Semihalf;(C) Copyright 2000-2006 Wolfgang Denk, DENX Software Engineering, wd@denx.de.
Copyright (c) Orbacom Systems, Inc <www.orbacom.com> All rights reserved.
Copyright (C) 2019 Stefan Roese <sr@denx.de>
Copyright (c) 2008-2019, MontaVista Software, Inc. <source@mvista.com>
Copyright (c) 2012 The Chromium OS Authors. All rights reserved. Use of this source code is governed by a BSD-style license that can be found in the LICENSE file.
Copyright (C) 2017 Martin Blumenstingl <martin.blumenstingl@googlemail.com>
Copyright (C) 2018 Martin Blumenstingl <martin.blumenstingl@googlemail.com>
Copyright (C) 2018 Texas Instruments Author: Kishon Vijay Abraham I <kishon@ti.com>
(C) Copyright 2001-2015 DENX Software Engineering -- wd@denx.de Compulab Ltd - http://compulab.co.il/
Bernecker & Rainer Industrieelektronik GmbH - http://www.br-automation.com
Copyright (C) 2012 Bluegiga Technologies Oy
Copyright (C) 2015-2019 Variscite Ltd.
(C) Copyright 2003 Gerry Hamel, geh@ti.com, Texas Instruments;(C) Copyright 2006 Bryan O'Donoghue, bodonoghue@codehermit.ie
Copyright (C) 2004-2006 Atmel Corporation
(C) Copyright 2003, 2004 ARM Ltd. Philippe Robin, <philippe.robin@arm.com>
Copyright 2019 NXP
Copyright (C) 2013 Marek Vasut <marex@denx.de>
(C) Copyright 2000 Rob Taylor, Flying Pig Systems. robt@flyingpig.com.:(C) Copyright 2004 ARM Ltd. Philippe Robin, <philippe.robin@arm.com>
Copyright (C) 2018 Anup Patel <anup@brainfault.org>
(c) 2007 Sascha Hauer <s.hauer@pengutronix.de>
Copyright (C) 2016, STMicroelectronics - All Rights Reserved Author(s): Vikas Manocha, <vikas.manocha@st.com> for STMicroelectronics.
Copyright (C) 2012 Renesas Solutions Corp.
(C) Copyright 2006-2009 Wolfgang Denk, DENX Software Engineering, wd@denx.de.
Copyright (C) 2012 Nobuhiro Iwamatsu <nobuhiro.iwamatsu.yj@renesas.com>
(C) Copyright 2003 Gerry Hamel, geh@ti.com, Texas Instruments;(C) Copyright 2006 Bryan O'Donoghue, bodonoghue@codehermit.ie, CodeHermit
(C) Copyright 2016 Stephen Warren <swarren@wwwdotorg.org>;(C) Copyright 2000 Rob Taylor, Flying Pig Systems. robt@flyingpig.com.:(C) Copyright 2004 ARM Ltd. Philippe Robin, <philippe.robin@arm.com>
(C) Copyright 2016
(C) Copyright 2012-2016 Stephen Warren
(C) Copyright 2016 Beniamino Galvani <b.galvani@gmail.com>
Copyright (C) 2012-2015 Panasonic Corporation

Copyright (C) 2005-2006 Atmel Corporation
Copyright (C) 2015-2016 Wills Wang <wills.wang@live.com>
Copyright (C) 2013 Synopsys, Inc. (www.synopsys.com)
(C) Copyright 2009 SAMSUNG Electronics Minkyu Kang <mk7.kang@samsung.com> Heungjun Kim <riverful.kim@samsung.com>
Copyright (C) 2011 Marek Vasut <marek.vasut@gmail.com>
Copyright (c) 2014 The Chromium OS Authors.
(C) Copyright 2004, Psynt Corporation <www.psyent.com> Scott McNutt <smcnutt@psyent.com>
(c) Copyright 2010-2014 Xilinx, Inc. All rights reserved.:(c) Copyright 2017 Opal Kelly Inc.
Copyright (C) 2011-2015 Vladimir Zapolskiy <vz@mleia.com>
Copyright (C) 2015 Beckhoff Automation GmbH & Co. KG Patrick Bruenn <p.bruenn@beckhoff.com>
Copyright (C) 2013 Renesas Electronics Corporation
Copyright (C) 2015 Beckhoff Automation GmbH & Co. KG Patrick Bruenn <p.bruenn@beckhoff.com>
Copyright (C) 2012 Michal Simek <monstr@monstr.eu>
Copyright (C) 2015 Beckhoff Automation GmbH Patrick Bruenn <p.bruenn@beckhoff.com>
Copyright (C) 2015 Actions Semi Co., Ltd.
(C) Copyright 2013-2016 Freescale Semiconductor, Inc.
Copyright (c) 2015 National Instruments
Copyright (C) 2019 Jagan Teki <jagan@amarulasolutions.com>
(C) Copyright 2004-2007 Freescale Semiconductor, Inc. TsiChung Liew, Tsi-Chung.Liew@freescale.com.:(C)
Copyright 2015 Angelo Dureghello <angelo@sysam.it>;(C) Copyright 2018 Angelo Dureghello <angelo@sysam.it>
Copyright (C) 2004-2007 ARM Limited.
Copyright (c) 2017 Tuomas Tynkynen
Copyright (c) 2018 Alexander Graf <agraf@suse.de>
Copyright (C) 2015, Bin Meng <bmeng.cn@gmail.com>
(C) Copyright 2020 Cortina-Access Ltd. Common UART Driver for Cortina Access CAXxxx line of SoCs
(C) Copyright 2000 Rob Taylor, Flying Pig Systems. robt@flyingpig.com.
(C) Copyright 2008 - 2015 Michal Simek <monstr@monstr.eu> Clean driver and add xilinx constant from header file.:(C) Copyright 2004 Atmark Techno, Inc. Yasushi SHOJI <yashi@atmark-techno.com>
Copyright 2000, 2001, 2002 Wolfgang Denk, DENX Software Engineering, wd@denx.de.
Copyright (c) 2009 Wind River Systems, Inc. Tom Rix <Tom.Rix@windriver.com>
(C) Copyright 2009 Faraday Technology Po-Yu Chuang <ratbert@faraday-tech.com>
Copyright (C) 2016 David Lechner <david@lechnology.com>
Copyright (C) 2013 Samsung Electronics Piotr Wilczek <p.wilczek@samsung.com>
(C) Copyright 2000, 2001, 2002 Wolfgang Denk, DENX Software Engineering, wd@denx.de.:(C) Copyright 2008 Guennadi Liakhovetki, DENX Software Engineering, <lg@denx.de>
Copyright (C) 2009 Samsung Electronics Kyungmin Park <kyungmin.park@samsung.com> Minkyu Kang <mk7.kang@samsung.com>
Copyright (C) 2008-2009 Samsung Electronics Kyungmin Park <kyungmin.park@samsung.com>
Copyright (C) 2008-2009 Samsung Electronics Minkyu Kang <mk7.kang@samsung.com> Kyungmin Park <kyungmin.park@samsung.com>
Copyright (c) 2009 Wind River Systems, Inc. Tom Rix <Tom.Rix@windriver.com>
Copyright (C) 2014 Samsung Electronics Przemyslaw Marczak <p.marczak@samsung.com>
Copyright (c) 2014 Samsung Electronics Co., Ltd. All rights reserved. Przemyslaw Marczak <p.marczak@samsung.com>
Copyright (C) 2011 Samsung Electronics
Copyright (C) 2011 Samsung Electronics Lukasz Majewski <l.majewski@samsung.com>
Copyright (C) 2012 Samsung Electronics Lukasz Majewski <l.majewski@samsung.com>
(C) Copyright 2002 Gary Jennejohn, DENX Software Engineering, <garyj@denx.de>
Copyright (C) 2013 Samsung Electronics Lukasz Majewski <l.majewski@samsung.com>
Copyright (C) 2011 Samsung Electronics Lukasz Majewski <l.majewski@samsung.com>;(C) Copyright 2010 Stefano Babic, DENX Software Engineering, sbabic@denx.de;(C) Copyright 2008-2009 Freescale Semiconductor, Inc.:(C)
Copyright 2019 NXP
(C) Copyright 2012 Henrik Nordstrom <henrik@henriknordstrom.net>
(C) Copyright 2013 SAMSUNG Electronics Rajeshwari Shinde <rajeshwari.s@samsung.com>
Copyright (C) 2011 Samsung Electronics Lukasz Majewski <l.majewski@samsung.com>;(C) Copyright 2010 Stefano Babic, DENX Software Engineering, sbabic@denx.de;(C) Copyright 2008-2009 Freescale Semiconductor, Inc.

LICENCE TERMS (cont.)

Copyright (C) 2015 Samsung Electronics Przemyslaw Marczak <p.marczak@samsung.com>
Copyright (C) 2013 Samsung Electronics Przemyslaw Marczak <p.marczak@samsung.com>
Copyright (C) 2013 Samsung Electronics
Copyright (C) 2015 Google, Inc Written by Simon Glass <sjg@chromium.org>
Copyright (C) 2013 The Chromium OS Authors.
(C) Copyright 2017 Texas Instruments Incorporated, <www.ti.com>
Copyright (C) 2019 Disruptive Technologies Research AS Sven Schwermer <sven.svenschwermer@disruptive-technologies.com>
(C) Copyright 2016 Texas Instruments Incorporated, <www.ti.com>
Copyright (C) 2016 Rockchip Electronics Co., Ltd
Copyright (C) 2010 Samsung Electronics Minkyu Kang <mk7.kang@samsung.com> Kyungmin Park <kyungmin.park@samsung.com>
Copyright (C) 2015 Samsung Electronics
Copyright (C) 2010 Samsung Electronics Minkyu Kang <mk7.kang@samsung.com>
Copyright (C) 2018 Flowbird Martin Fuzzey <martin.fuzzey@flowbird.group>
Copyright (C) EETS GmbH, 2017, Felix Brack <f.brack@eets.ch>
Copyright (C) 2010 Samsung Electronics Kyungmin Park <kyungmin.park@samsung.com>
(C) Copyright 2019 Texas Instruments Incorporated, <www.ti.com>
Copyright (c) 2000 - 2013 Samsung Electronics Co., Ltd. All rights reserved. Sanghee Kim <sh0130.kim@samsung.com>
(C) Copyright 2016 Texas Instruments Incorporated, <www.ti.com> Jean-Jacques Hiblot <jjhiblot@ti.com>
Copyright (c) 2013 Samsung Electronics Co., Ltd. All rights reserved. Sanghee Kim <sh0130.kim@samsung.com> Piotr Wilczek <p.wilczek@samsung.com>
(C) Copyright 2016 Texas Instruments Incorporated, <www.ti.com> Keerthy <j-keerthy@ti.com>
Copyright (C) 2009 Samsung Electronics Kyungmin Park <kyungmin.park@samsung.com>
Copyright (C) 2019 Texas Instruments Incorporated - http://www.ti.com/ Tero Kristo <t-kristo@ti.com>
Copyright (C) 2019 ROHM Semiconductors
Copyright (C) 2018, STMicroelectronics - All Rights Reserved Author: Fabrice Gasnier <fabrice.gasnier@st.com>
Copyright (C) 2018, STMicroelectronics - All Rights Reserved Author: Christophe Kerello <christophe.kerello@st.com>
Copyright (C) 2012-2015 Samsung Electronics
Copyright (C) 2016 Samsung Electronics Thomas Abraham <thomas.ab@samsung.com>
Copyright (C) 2018 Samsung Electronics Jaehoon Chung <jh80.chung@samsung.com>
Copyright (c) 2012 Samsung Electronics Co., Ltd. http://www.samsung.com Akshay Saraswat <akshay.s@samsung.com>
Copyright (C) 2011 Samsung Electronics Heungjun Kim <riverful.kim@samsung.com> Kyungmin Park <kyungmin.park@samsung.com> Donghwa Lee <dh09.lee@samsung.com>
Copyright (C) 2011 Samsung Electronics Heungjun Kim <riverful.kim@samsung.com>
Copyright 2006, 2008-2009, 2011 Freescale Semiconductor
Copyright 2007-2011 Freescale Semiconductor, Inc.
Copyright (C) 2018 EETS GmbH - http://www.eets.ch/
Copyright (C) 2018 EETS GmbH - http://www.eets.ch/
(C) Copyright 2016 Jelle van der Waa <jelle@vdwaa.nl>
(C) Copyright 2014 Hans de Goede <hdegoede@redhat.com>;(C) Copyright 2013 Oliver Schinagl <oliver@schinagl.nl>
(C) Copyright 2016 Chen-Yu Tsai <wens@csie.org>;(C) Copyright 2014 Hans de Goede <hdegoede@redhat.com>;(C) Copyright 2013 Oliver Schinagl <oliver@schinagl.nl>
Copyright (C) 2018, EETS GmbH, http://www.eets.ch/
Copyright (C) 2015 Freescale Semiconductor, Inc Peng Fan <Peng.Fan@freescale.com>
Copyright (C) 2013 Lars Poeschel, Lemonage Software GmbH
Copyright (C) 2016 Samsung Electronics Jaehoon Chung <jh80.chung@samsung.com>
Copyright (C) 2014 NVIDIA Corporation
Copyright (C) 2015 Freescale Semiconductor, Inc. Fabio Estevam <fabio.estevam@freescale.com>
Copyright (C) 2011, Texas Instruments, Incorporated - http://www.ti.com/
Copyright (C) 2018 Lukasz Majewski, DENX Software Engineering, lukma@denx.de
Copyright (C) 2018 Collabora Ltd.
Copyright (C) 2018 Collabora Ltd.
(C) Copyright 2014 Texas Instruments Incorporated - http://www.ti.com Author: Felipe Balbi <balbi@ti.com>
Copyright (C) 2013 Lemonage Software GmbH Author Lars Poeschel <poeschel@lemonage.de>
Copyright (C) 2014 Gateworks Corporation Tim Harvey <tharvey@gateworks.com>
Copyright (C) 2015 Freescale Semiconductor, Inc. Peng Fan <Peng.Fan@freescale.com>
Copyright (C) 2013, Lemonage Software GmbH Author Lars Poeschel <poeschel@lemonage.de>
Copyright (C) 2017 PHYTEC Messtechnik GmbH Author: Wadim Egorov <w.egorov@phytec.de>
(C) Copyright 2019 Texas Instruments Incorporated, <www.ti.com> Keerthy <j-keerthy@ti.com>
Copyright (C) 2007, Guennadi Liakhovetski <lg@denx.de>;(C) Copyright 2011 Freescale Semiconductor, Inc.
(C) Copyright 2011-2013 Texas Instruments, <www.ti.com>
Copyright (C) 2016 Toradex AG Stefan Agner <stefan.agner@toradex.com>
Copyright (C) 2017 Stefano Babic <sbabic@denx.de>
Copyright 2016 Freescale Semiconductor, Inc. Hou Zhiqiang <Zhiqiang.Hou@freescale.com>
(C) Copyright 2018 Lukasz Majewski, DENX Software Engineering, lukma@denx.de.
Copyright 2015 3ADEV <http://www.3adev.com>
(C) Copyright 2017 Texas Instruments Incorporated, <www.ti.com> Keerthy <j-keerthy@ti.com>
Copyright (C) 2016 Stefano Babic <sbabic@denx.de>
(C) Copyright 2013 Avionic Design GmbH <www.avionic-design.de>
(C) Copyright 2010,2011 NVIDIA Corporation <www.nvidia.com>;(C) Copyright 2011,2012 Avionic Design GmbH <www.avionic-design.de>
(C) Copyright 2010,2011 NVIDIA Corporation <www.nvidia.com>;(C) Copyright 2011-2012 Avionic Design GmbH <www.avionic-design.de>
(C) Copyright 2013 Sergey Kostenbaev <sergey.kostenbaev@atfairwaves.ru>;(C) Copyright 2003-2006 Wolfgang Denk, DENX Software Engineering, wd@denx.de.
Copyright (C) 2013 Sergey Kostenbaev <sergey.kostenbaev@atfairwaves.ru>
(C) Copyright 2012-2013 Texas Instruments, <www.ti.com>
Copyright (c) 2010-2012, NVIDIA CORPORATION. All rights reserved.
Copyright (C) 2019 Frank Wunderlich <frank-w@public-files.de>
Copyright (c) 2011 The Chromium OS Authors.;(C) Copyright 2010,2011 NVIDIA Corporation <www.nvidia.com>
(C) Copyright 2015 Vishnu Patekar <vishnuptekar0510@gmail.com>;(C) Copyright 2014 Hans de Goede <hdegoede@redhat.com>;(C) Copyright 2013 Oliver Schinagl <oliver@schinagl.nl>
(C) Copyright 2015 Inter Act B.V.;(C) Copyright 2003-2008 Wolfgang Denk, DENX Software Engineering, wd@denx.de.;(C) Copyright 2008 Stelian Pop <stelian@popies.net> Lead Tech Design <www.leadtechdesign.com>
Copyright (c) 2012 Samsung Electronics
(C) Copyright 2014 Freescale Semiconductor, Inc. Author: Ruchika Gupta <ruchika.gupta@freescale.com>
(C) Copyright 2015 Inter Act B.V.;(C) Copyright 2007-2008 Stelian Pop <stelian@popies.net> Lead Tech Design <www.leadtechdesign.com>;(C) 2015 Inter Act B.V.;(C) lcd_printf("support@interact.nl\n"); lcd_printf("%s CPU at %s MHz\n", ATME_L_CPU_NAME, strmhertz(temp, get_cpu_clk_rate()));
Copyright 2014 Freescale Semiconductor, Inc.
(C) Copyright 2007-2008 Stelian Pop <stelian@popies.net> Lead Tech Design <www.leadtechdesign.com>
(C) Copyright 2004-2006 Wolfgang Denk, DENX Software Engineering, wd@denx.de.;(C) Copyright 2007 Wind River Systems Inc <www.windriver.com>. Added support for Wind River SBC8548 board
Copyright 2007,2009 Wind River Systems, Inc. <www.windriver.com>
Copyright 2008-2014 Freescale Semiconductor, Inc.
Copyright 2008 Freescale Semiconductor, Inc.;(C) Copyright 2000 Wolfgang Denk, DENX Software Engineering, wd@denx.de.
Copyright (C) 2014, Gumstix, Incorporated - http://www.gumstix.com/
Copyright (C) 2014, Gumstix, Incorporated - http://www.gumstix.com/ Based on board/ti/am335x/board.c from Texas Instruments, Inc.
Copyright (C) 2014, Gumstix, Inc. - http://www.gumstix.com/
(C) Copyright 2000, 2001, 2002 Wolfgang Denk, DENX Software Engineering, wd@denx.de.
(C) Copyright 2013 Gumstix Inc. <www.gumstix.com> Maintainer: Ash Charles <ash@gumstix.com>
Copyright 2009-2014 Freescale Semiconductor, Inc.
Copyright (c) 2013 Samsung Electronics Co., Ltd. http://www.samsung.com
(C) Copyright 2012 Gumstix Incorporated, <www.gumstix.com> Maintainer: Ash Charles <ash@gumstix.com>
(C) Copyright 2014 Freescale Semiconductor, Inc.
(C) Copyright 2013 Siemens Schweiz AG
(C) Copyright 2014 Freescale Semiconductor, Inc Author: Ruchika Gupta <ruchika.gupta@freescale.com>

LICENCE TERMS (cont.)

Copyright (c) 2012-2016, Freescale Semiconductor, Inc. All rights reserved.
(C) Copyright 2013 Siemens AG;(C) Copyright 2003-2008 Wolfgang Denk, DENX Software Engineering, wd@denx.de.:(C) Copyright 2008 Stelian Pop <stelian@popies.net> Lead Tech Design <www.leadtechdesign.com>
(C) Copyright 2013 Siemens AG;(C) Copyright 2007-2008 Stelian Pop <stelian@popies.net> Lead Tech Design <www.leadtechdesign.com>
Copyright 2018 NXP
Copyright 2019 Siemens AG
Copyright 2020, Heinrich Schuchardt <xypron.glpk@gmx.de>
Copyright 2000 MontaVista Software Inc.
Copyright 2017-2019 NXP
(C) Dustin McIntire (dustin@sensoria.com);(C) 2007,2008 Nobuhiro Iwamatsu <iwamatsu@nigauri.org>;(C) 2008 Yusuke Goda <goda.yusuke@renesas.com>
Copyright (C) 2019
(C) Copyright 2013 Siemens Schweiz AG
Copyright (C) 2015 Marvell International Ltd.
Copyright (C) 2016 Imagination Technologies
Copyright 2007-2012 Freescale Semiconductor, Inc.
Copyright (C) 2013 Imagination Technologies Author: Paul Burton <paul.burton@mips.com>
(C) Copyright 2019 Heiko Schocher, DENX Software Engineering, hs@denx.de.
(C) Copyright 2003-2008 Wolfgang Denk, DENX Software Engineering, wd@denx.de.:(C) Copyright 2008 Stelian Pop <stelian@popies.net> Lead Tech Design <www.leadtechdesign.com>;(C) Copyright 2012 Markus Hubig <mhubig@imko.de> IMKO GmbH <www.imko.de>;(C) Copyright 2014 Heiko Schocher <hs@denx.de> DENX Software Engineering GmbH
Copyright 2017-2020 NXP
(C) Copyright 2007-2008 Stelian Pop <stelian@popies.net> Lead Tech Design <www.leadtechdesign.com>;(C) Copyright 2012- Markus Hubig <mhubig@imko.de> IMKO GmbH <www.imko.de>;(C) Copyright 2014 Heiko Schocher <hs@denx.de> DENX Software Engineering GmbH
(C) Dustin McIntire (dustin@sensoria.com);(C) 2007,2008 Nobuhiro Iwamatsu <iwamatsu@nigauri.org>
Copyright (C) 2013 Marek Vasut <marex@denx.de>
Copyright (C) 2013-2018 Intel Corporation. All rights reserved
(C) Copyright Siemens AG;(C) Copyright 2007-2008 Stelian Pop <stelian@popies.net> Lead Tech Design <www.leadtechdesign.com>
Copyright (C) 2018 Manivannan Sadhasivam <manivannan.sadhasivam@linaro.org>
Copyright 2018-2020 NXP
(C) Copyright 2020 - Cortina Access Inc.
Copyright (c) 2014 Google, Inc.:(C) Copyright 2001 Sysgo Real-Time Solutions, GmbH <www.elinos.com> Andreas Heppel <aheppel@sysgo.de>;(C) Copyright 2002, 2003 Wolfgang Denk, DENX Software Engineering, wd@denx.de.
(C) Copyright 2020 Cortina-Access.Inc.
Copyright (C) 2011 Andes Technology Corporation Gavin Guo, Andes Technology Corporation <gavinguo@andestech.com> Macpaul Lin, Andes Technology Corporation <macpaul@andestech.com>
Copyright (c) 2017-2019 MediaTek Inc. Author: Ryder Lee <ryder.lee@mediatek.com> Honghui Zhang <honghui.zhang@mediatek.com>
Copyright (C) 2013 Lothar Felten <lothar.felten@gmail.com>
Copyright (C) 1998 Gabriel Paubert.
Copyright (C) 2014 Google, Inc
Copyright (C) 2019 Hannes Schmelzer <oe5hpm@oevsv.at> B&R Industrial Automation GmbH
Copyright (C) 2013 Hannes Schmelzer <oe5hpm@oevsv.at> Bernecker & Rainer Industrielektronik GmbH
Copyright (C) 2018 Texas Instruments, Inc
Copyright 2000 MontaVista Software Inc.
Copyright (C) 2017 Hannes Schmelzer <hannes.schmelzer@br-automation.com> B&R Industrial Automation GmbH
Copyright (C) 2019 Hannes Schmelzer <oe5hpm@oevsv.at> - B&R Industrial Automation GmbH
Copyright (c) 2010, CompuLab, Ltd. Author: Mike Rapoport <mike@compulab.co.il>
Copyright (C) 2013 Gabor Juhos <juhosg@openwrt.org>
Copyright (C) 2017 Hannes Schmelzer <oe5hpm@oevsv.at> B&R Industrial Automation GmbH
Copyright (C) 2019 Hannes Schmelzer <oe5hpm@oevsv.at> - B&R Industrial Automation GmbH
Copyright (C) 2015 Marvell International Ltd.
Copyright (C) 2019 B&R Industrial Automation GmbH

Copyright (C) 2014 Google, Inc
Copyright (C) 2018-2019 Marek Vasut <marek.vasut@gmail.com>
(C) Copyright 2001 Sysgo Real-Time Solutions, GmbH <www.elinos.com> Andreas Heppel <aheppel@sysgo.de>;(C) Copyright 2002, 2003 Wolfgang Denk, DENX Software Engineering, wd@denx.de.
(C) Copyright 2012-2014 Texas Instruments Incorporated, <www.ti.com>
Copyright (C) 2018 Hannes Schmelzer <oe5hpm@oevsv.at> - B&R Industrial Automation GmbH
Copyright (C) 2014 Hannes Schmelzer <oe5hpm@oevsv.at> - Bernecker & Rainer Industrielektronik GmbH -
Copyright (C) 2018, STMicroelectronics - All Rights Reserved Author: Fabrice Gasnier <fabrice.gasnier@st.com>.
(C) Copyright 2017, Fuzhou Rockchip Electronics Co., Ltd
(C) Copyright 2007 - 2013, Tensilica Inc.
(C) Copyright 2007 - 2013 Tensilica Inc.:(C) Copyright 2014 - 2016 Cadence Design Systems Inc.
Copyright (c) 2011 The Chromium OS Authors.:(C) Copyright 2004 DENX Software Engineering, Wolfgang Denk, wd@denx.de
Copyright (C) 2015 Paul Kocialkowski <contact@paulk.fr>
(C) Copyright 2015 Savoir-faire Linux Inc.
(C) Copyright 2015 Savoir-faire Linux
Copyright (C) 2016 Paul Kocialkowski <contact@paulk.fr>
(C) Copyright 2011 NVIDIA Corporation <www.nvidia.com>
(C) Copyright 2016 Savoir-faire Linux
Copyright (C) 2009-2014 Freescale Semiconductor, Inc. All Rights Reserved.
(C) Copyright 2016 Savoir-faire Linux Inc.
Copyright (c) 2012 The Chromium OS Authors.:(C) Copyright 2004 DENX Software Engineering, Wolfgang Denk, wd@denx.de
Copyright 2007, Embedded Specialties, Inc.
Copyright 2007 Wind River Systemes, Inc. <www.windriver.com>
Copyright (C) 2018 MediaTek Inc. Author: Sam Shih <sam.shih@mediatek.com>
Copyright (C) 2019 MediaTek Inc.
(C) Copyright 2015 Google, Inc
Copyright (C) 2019 BayLibre SAS
(C) Copyright 2000-2003 Wolfgang Denk, DENX Software Engineering, wd@denx.de. modified by Wolfgang Wegner <w.wegner@astro-kom.de> for ASTRO 5373I
(C) Copyright 2006 Wolfgang Wegner, ASTRO Strobel Kommunikationssysteme GmbH, w.wegner@astro-kom.de
Copyright (c) 2019 Baylibre, SAS Jerome Brunet <jbrunet@baylibre.com>
Copyright (C) 2017 DENX Software Engineering Lukasz Majewski, DENX Software Engineering, lukma@denx.de
(C) Copyright 2018 - Beniamino Galvani <b.galvani@gmail.com>;(C) Copyright 2018 - BayLibre, SAS Author: Neil Armstrong <narmstrong@baylibre.com>
Copyright (C) 2017, DENX Software Engineering Lukasz Majewski <lukma@denx.de>
Copyright (C) 2019 MediaTek Inc. Author: Ryder Lee <ryder.lee@mediatek.com>
Copyright (C) 2018 BayLibre, SAS Author: Fabien Parent <fparent@baylibre.com>
(C) Copyright 2019 Lukasz Majewski, DENX Software Engineering, lukma@denx.de.
Copyright (C) 2019 BayLibre, SAS Author: Chen Zhong <chen.zhong@mediatek.com>
Copyright (C) 2016-2017 Lukasz Majewski, DENX Software Engineering, lukma@denx.de
Copyright (C) 2014 Wandboard Author: Tungyi Lin <tungyilin1127@gmail.com> Richard Hu <haku@haku@gmail.com>
(C) Copyright 2016-2017 Lukasz Majewski, DENX Software Engineering, lukma@denx.
Copyright (C) 2012 Atmel Corporation
Copyright 2010 Google LLC
Copyright (C) 2018 Stefan Roese <sr@denx.de>
Copyright (C) 2014 Evgeni Dobrev <evgeni@studio-punkt.com>;(C) Copyright 2009 Marvell Semiconductor <www.marvell.com>
Copyright (C) 2018 Amarula Solutions.
Copyright (C) 2013 Suriyan Ramasami <suriyan.r@gmail.com>
Copyright (C) 2018 Amarula Solutions B.V. Author: Jagan Teki <jagan@amarulasolutions.com>
Copyright (C) 2010 Eric C. Cooper <ecc@cmu.edu>;(C) Copyright 2009 Marvell Semiconductor <www.marvell.com>
Copyright (C) 2010 Eric C. Cooper <ecc@cmu.edu>;(C) Copyright 2009 Marvell Semiconductor <www.marvell.com>
Refer doc/README.kwbimage for more details about how-to configure and create kirkwood boot image
(C) Copyright 2009 Marvell Semiconductor <www.marvell.com> Written-by: Prafulla Wadaskar <prafulla@marvell.com>

LICENCE TERMS (cont.)

Copyright 2019 NXP Peng Fan <peng.fan@nxp.com>
Copyright (C) 2009-2012 Wojciech Dubowik <wojciech.dubowik@neratec.com> Luka Perkov <luka@openwrt.org>
Copyright 2018 NXP Peng Fan <peng.fan@nxp.com>
(C) Copyright 2011 Jason Cooper <u-boot@lakedaemon.net>
Copyright(C) 2019 Author(s): Giulio Benetti <giulio.benetti@benettiengineering.com>
Copyright (C) 2015 Phil Sutter <phil@nwl.cc>
Copyright 2017-2019 NXP.
Copyright (C) 2019 DENX Software Engineering Lukasz Majewski, DENX Software Engineering, lukma@denx.de
(C) Copyright 2012 Stefan Bigler, Keymile AG, stefan.bigler@keymile.com Norbert Mayer, Keymile AG, norbert.mayer@keymile.com Deepak Patel, XENTECH Limited, deepak.patel@xentech.co.uk
(C) Copyright 2009 Marvell Semiconductor <www.marvell.com> Prafulla Wadaskar <prafulla@marvell.com>
(C) Copyright 2012 Valentin Longchamp, Keymile AG, valentin.longchamp@keymile.com
(C) Copyright 2010 Heiko Schocher, DENX Software Engineering, hs@denx.de.
(C) Copyright 2010 Heiko Schocher, DENX Software Engineering, hs@denx.de.:(C) Copyright 2012 Valentin Longchamp, Keymile AG, valentin.longchamp@keymile.com Stefan Bigler, Keymile AG, stefan.bigler@keymile.com.:(C) Copyright 2012
(C) Copyright 2009 Marvell Semiconductor <www.marvell.com> Prafulla Wadaskar <prafulla@marvell.com>.:(C) Copyright 2009 Stefan Roese, DENX Software Engineering, sr@denx.de.:(C) Copyright 2010 Heiko Schocher, DENX Software Engineering, hs@denx.de.
(C) Copyright 2010 Heiko Schocher, DENX Software Engineering, hs@denx.de.:(C) Copyright 2011 Valentin Longchamp, Keymile AG, valentin.longchamp@keymile.com Refer doc/README.kwbimage for more details about how-to configure and create kirkwood boot image
Copyright (C) 2017 WeidMüller Interface GmbH & Co. KG Stefan Herbrechtsmeier <stefan.herbrechtsmeier@weidmueller.com>
(C) Copyright 2001-2007 Wolfgang Denk, DENX Software Engineering, wd@denx.de.
Copyright 2012 Freescale Semiconductor, Inc.
Copyright (C) 2016 Masahiro Yamada <yamada.masahiro@socionext.com>
Copyright (C) 2018 Marek Vasut <marex@denx.de>
(C) Copyright 2013 Keymile AG Valentin Longchamp <valentin.longchamp@keymile.com>
(C) Copyright 2013 Keymile AG Valentin Longchamp <valentin.longchamp@keymile.com>
(C) Copyright 2008 Heiko Schocher, DENX Software Engineering, hs@denx.de.:(C) Copyright 2011 Holger Brunck, Keymile GmbH Hannover, holger.brunck@keymile.com
(C) Copyright 2018 ABB Valentin Longchamp <valentin.longchamp@ch.abb.com>
(C) Copyright 2015 Google, Inc.:(C) Copyright 2016 Heiko Stuebner <heiko@sntech.de>
(C) Copyright 2008 Heiko Schocher, DENX Software Engineering, hs@denx.de.
(C) Copyright 2011 Holger Brunck, Keymile GmbH Hannover, holger.brunck@keymile.com
Copyright (c) 2017 Rockchip Electronics Co., Ltd
Copyright (C) 2006 Freescale Semiconductor, Inc. Dave Liu <daveliu@freescale.com>
(C) Copyright 2018-2019 Rockchip Electronics Co., Ltd
(C) Copyright 2017-2019 Rockchip Electronics Co., Ltd
Copyright (C) 2019, Pascal Linder <pascal.linder@edu.hefr.ch>
(C) Copyright 2016 Rockchip Electronics Co., Ltd Author: Andy Yan <andy.yan@rock-chips.com>
(C) Copyright 2015 Google, Inc.:(C) 2017 Theobroma Systems Design und Consulting GmbH
(C) Copyright 2020 ABB
Copyright (C) 2017-2020 ABB
(C) Copyright 2017 Rockchip Electronics Co., Ltd Author: Andy Yan <andy.yan@rock-chips.com>.:(C) Copyright 2017 Theobroma Systems Design und Consulting GmbH
Copyright (C) 2015 Purna Chandra Mandal <purna.mandal@microchip.com>
Copyright (C) 2016 Atmel Corporation Wenyou.Yang <wenyou.yang@atmel.com>
Copyright (C) 2018 Microhip / Atmel Corporation Wenyou.Yang <wenyou.yang@microchip.com>
Copyright (c) 2011 The Chromium OS Authors.:(C) Copyright 2008 Graeme Russ, graeme.russ@gmail.com.:(C) Copyright 2006 Wolfgang Denk, DENX Software Engineering, wd@denx.de.:(C) Copyright 2002 Daniel Engström, Omicron Ceti AB, daniel@omicron.se.
Copyright (c) 2019 Western Digital Corporation or its affiliates.
Copyright 2018 Google
(C) Copyright 2017 Armadeus Systems
Copyright (C) 2018 Armadeus Systems
(C) Copyright 2000-2004 Wolfgang Denk, DENX Software Engineering, wd@denx.de.:(C) Copyright 2012-2013 Eric Jarrige <eric.jarrige@armadeus.org>
(C) Copyright 2002-2013 Eric Jarrige <eric.jarrige@armadeus.org>
Copyright (C) 2010-2011 Canonical Ltd <jeremy.kerr@canonical.com>
Copyright (C) 2018 Arm Ltd Author: Liviu Dudau <liviududau@foss.arm.com>
(C) Copyright 2013 Philippe Reynes <tremyfr@yahoo.fr>
Copyright (C) 2008-2013 Eric Jarrige <eric.jarrige@armadeus.org>
Copyright (C) 2017 Marek Vasut <marek.vasut@gmail.com>
Copyright (C) 2017 Glider bvba
Copyright (C) 2017-2018 Marek Vasut <marek.vasut@gmail.com>
Copyright (C) 2015-2016 Glider bvba
Copyright (C) 2014, 2015 O.S. Systems Software LTDA.
Copyright (C) 2014 O.S. Systems Software LTDA.
Copyright (C) 2015 Glider bvba
Copyright (C) 2013 Freescale Semiconductor, Inc.
Copyright (C) 2015 Stefan Roese <sr@denx.de>
Copyright (C) 2014 Stefan Roese <sr@denx.de>
Copyright (C) 2018 Marek Vasut <marek.vasut@gmail.com>
Copyright (C) 2016 Cogent Embedded Inc.
(C) Copyright 2010 Marvell Semiconductor <www.marvell.com> Written-by: Prafulla Wadaskar <prafulla@marvell.com> Contributor: Mahavir Jain <mjain@marvell.com>
(C) Copyright 2011 elfnchips Ltd. <www.elfnchips.com> Written-by: Ajay Bhargav <contact@8051projects.net>.:(C) Copyright 2010 Marvell Semiconductor <www.marvell.com> Written-by: Prafulla Wadaskar <prafulla@marvell.com> Contributor: Mahavir Jain <mjain@marvell.com>
Copyright (c) 2013 NVIDIA CORPORATION. All rights reserved.
(C) Copyright 2019 Xilinx, Inc. Siva Durga Prasad Paladugu <siva.durga.paladugu@xilinx.com>
(C) Copyright 2009 Marvell Semiconductor <www.marvell.com> Written-by: Prafulla Wadaskar <prafulla@marvell.com>
(C) Copyright 2009 Net Insight <www.netinsight.net> Written-by: Simon Kagstrom <simon.kagstrom@netinsight.net>.:(C) Copyright 2009 Marvell Semiconductor <www.marvell.com> Written-by: Prafulla Wadaskar <prafulla@marvell.com>
Copyright (C) 2016 Xilinx, Inc.
Copyright (c) 2019 Western Digital Corporation or its affiliates.
(c) 2007 Pengutronix, Sascha Hauer <s.hauer@pengutronix.de>
Copyright 2015-2016 Freescale Semiconductor, Inc.
Copyright (c) 2011 Roberto Cerati <roberto.cerati@bticino.it>
(C) Copyright 2009 Marvell Semiconductor <www.marvell.com> Written-by: Siddarth Gore <gores@marvell.com>
Copyright (C) 2010, 2009 Matthias Kaehlcke <matthias@kaehlcke.net>
Copyright(c) 1999 - 2002 Intel Corporation. All rights reserved.
(C) Copyright 2009 Marvell Semiconductor <www.marvell.com> Written-by: Siddarth Gore <gores@marvell.com> Refer doc/README.kwbimage for more details about how-to configure and create kirkwood boot image
(C) Copyright 2012, Stefan Roese <sr@denx.de>
Copyright 2007, 2010 Freescale Semiconductor, Inc.
(C) Copyright 2002 Sysgo Real-Time Solutions, GmbH <www.elinos.com> Rolf Offermanns <rof@sysgo.de>
Copyright (C) 2009 Matthias Kaehlcke <matthias@kaehlcke.net>
(C) Copyright 2011 elfnchips Ltd. <www.elfnchips.com> Written-by: Ajay Bhargav <contact@8051projects.net>.:(C) Copyright 2010 Marvell Semiconductor <www.marvell.com> Contributor: Mahavir Jain <mjain@marvell.com>
Copyright (C) 2018 Marvell International Ltd. Author: Ken Ma <make@marvell.com>
Copyright (C) 2015 Atmel Corporation Wenyou Yang <wenyou.yang@atmel.com>
(C) Copyright 2003-2008 Wolfgang Denk, DENX Software Engineering, wd@denx.de.:(C) Copyright 2008 Stelian Pop <stelian@popies.net> Lead Tech Design <www.leadtechdesign.com>.:(C) Copyright 2013 Bo Shen <voice.shen@atmel.com>
Copyright (C) 2012 - 2013 Atmel Corporation Bo Shen <voice.shen@atmel.com>
(C) Copyright 2003-2008 Wolfgang Denk, DENX Software Engineering, wd@denx.de.:(C) Copyright 2008 Stelian Pop <stelian@popies.net> Lead Tech Design <www.leadtechdesign.com>
Copyright (C) 2014 Marvell

LICENCE TERMS (cont.)

Copyright 2015-2018 NXP

(C) Copyright 2007-2008 Stelian Pop <stelian@popies.net> Lead Tech Design <www.leadtechdesign.com>;(C) 2008 ATMEL Corp\n"); lcd_printf ("at91support@atmel.com\n"); lcd_printf ("%s CPU at %s MHz\n", ATMEL_CPU_NAME, strmhz(temp, get_cpu_clk_rate()));

Copyright (C) 2014 Atmel Bo Shen <voice.shen@atmel.com>

(C) Copyright 2003-2008 Wolfgang Denk, DENX Software Engineering, wd@denx.de.:(C) Copyright 2008 Stelian Pop <stelian.pop@leadtechdesign.com> Lead Tech Design <www.leadtechdesign.com>;(C) Copyright 2013 Josh Wu <josh.wu@atmel.com> Atmel corporation <www.atmel.com>

Copyright (C) 2015 Freescale Semiconductor

(C) Copyright 2013 Atmel Corporation Josh Wu <josh.wu@atmel.com>

Copyright 2008 Freescale Semiconductor, Inc. This file is licensed under the terms of the GNU General Public License version 2. This program is licensed "as is" without any warranty of any kind, whether express or implied.

(C) Copyright 2014 DENX Software Engineering GmbH Written-by: Albert ARIBAUD - 3ADEV <albert.ari baud@3adev.fr>

(C) Copyright 2013 Faraday Technology Dante Su <dantesu@faraday-tech.com>

(C) Copyright 2003-2008 Wolfgang Denk, DENX Software Engineering, wd@denx.de.

Copyright 2016-2018 Socionext inc.

Copyright (c) 2016, NVIDIA CORPORATION.

(C) Copyright 2010 Andreas Bießmann <andreas@biessmann.org>;(C) Copyright 2002 Sysgo Real-Time Solutions, GmbH <www.elinos.com> Marius Groeger <mgroeger@sysgo.de>

(C) Copyright 2006 Atmel Nordic AB <www.atmel.com> Ulf Samuelsson <ulf@atmel.com>;(C) Copyright 2010

Andreas Bießmann <andreas@biessmann.org>

Copyright (C) 2001 Entity Cyber, Inc.

(C) Copyright 2009 Ilya Yanok, Emcraft Systems Ltd <yanok@emcraft.com>;(C) Copyright 2008 Armadeus Systems, nc;(C) Copyright 2008 Eric Jarrige <eric.jarrige@armadeus.org>;(C) Copyright 2007 Pengutronix, Sascha Hauer <s.hauer@pengutronix.de>;(C) Copyright 2007 Pengutronix, Juergen Beisert <j.beisert@pengutronix.de>;(C)

Copyright 2003 Wolfgang Denk, DENX Software Engineering, wd@denx.de.:(C) Copyright Motorola, Inc., 2000

Copyright 2014-2017 Broadcom.

(C) Copyright 2000-2004 Wolfgang Denk, DENX Software Engineering, wd@denx.de.:(C) Copyright 2007 Freescale Semiconductor, Inc. Tsi-Chung Liew (Tsi-Chung.Liew@freescale.com);(C) 2019 Angelo Dureghello <angelo.dureghello@timesys.com>

Copyright (C) 2015-2017 Renesas Electronics Corporation

Copyright 2013-2015 Freescale Semiconductor Inc.

Copyright 2013-2016 Freescale Semiconductor, Inc.

Copyright (C) 2017 Microchip Wenyou Yang <wenyou.yang@microchip.com>

Copyright (C) 2013-2015 Freescale Semiconductor, Inc. Author: German Rivera <German.Rivera@freescale.com>

Copyright (C) 2019 Microchip Technology Inc. and its subsidiaries

Copyright (C) 2014 Atmel Corporation Bo Shen <voice.shen@atmel.com>

(C) Copyright 2003-2008 Wolfgang Denk, DENX Software Engineering, wd@denx.de.:(C) Copyright 2008 Stelian

Pop <stelian@popies.net> Lead Tech Design <www.leadtechdesign.com>;(C) Copyright 2014 Bo Shen <voice.

shen@atmel.com>

Copyright (C) 2014 Freescale Semiconductor

Copyright (C) 2018 Microchip Technology Inc. and its subsidiaries

Copyright (C) 2017 Microchip Corporation Wenyou Yang <wenyou.yang@microchip.com>

Copyright 2009-2010, 2013 Freescale Semiconductor, Inc. Jun-jie Zhang <b18070@freescale.com> Mingkai Hu

<Mingkai.hu@freescale.com>

(c) 2007 Nobuhiro Iwamatsu <iwamatsu@nigauri.org>

Copyright (C) 2017 Microchip Corporation Wenyou.Yang <wenyou.yang@microchip.com>

Copyright (C) 2007 Sergey Kubushyn <ksi@koi8.net>

Copyright (C) 2011 Ilya Yanok, Emcraft Systems

Copyright (C) 2010-2018 Texas Instruments Incorporated - http://www.ti.com/

Copyright (C) 2018 Microchip Technology, Inc. Eugen Hristev <eugen.hristev@microchip.com>

Copyright (C) 2018 Microchip Technology Inc. Eugen Hristev <eugen.hristev@microchip.com>

Copyright (C) 2019, Texas Instruments, Incorporated

(C) Copyright 2003-2008 Wolfgang Denk, DENX Software Engineering, wd@denx.de.:(C) Copyright 2008 Stelian

Pop <stelian@popies.net> Lead Tech Design <www.leadtechdesign.com>;(C) Copyright 2012 Bo Shen <voice.

shen@atmel.com> Atmel corporation <www.atmel.com>

Copyright (C) 2016, Texas Instruments, Incorporated

Copyright (C) 2019 Amit Singh Tomar <amittomer25@gmail.com>

Copyright (C) 2008, 2011 Renesas Solutions Corp.

Copyright 2004-2011, 2013 Freescale Semiconductor, Inc.:(C) Copyright 2003, Motorola, Inc. author Andy Fleming

Copyright (C) 2011 Michal Simek <monstr@monstr.eu>

Copyright (C) 2007-2008 Avionic Design Development GmbH

Copyright (C) 2016 Marek Vasut <marex@denx.de>

Copyright 2009 Extreme Engineering Solutions, Inc.

(C) 2009 Ben Warren , biggerbadderben@gmail.com Converted to use CONFIG_NET_MULTI API

Copyright (C) 2008 Altera Corporation.

Copyright (C) 2008 Dave S.r.l. <www.dave.eu>

(C) Copyright 2002 Wolfgang Grandegger, wg@denx.de.

Copyright 2015 Microchip Inc. Purna Chandra Mandal <purna.mandal@microchip.com>

Copyright 2007-2008 Freescale Semiconductor, Inc.

(C) Copyright 2007-2009 Michal Simek;(C) Copyright 2003 Xilinx Inc.

(C) Copyright 2016 Author: Amit Singh Tomar, amittomer25@gmail.com

Copyright 2010 Extreme Engineering Solutions, Inc.

Copyright 2010 Extreme Engineering Solutions, Inc.

(C) Copyright 2015 Sjoerd Simons <sjoerd.simons@collabora.co.uk>

(C) Copyright 2009 Ilya Yanok, Emcraft Systems Ltd <yanok@emcraft.com>;(C) Copyright 2008,2009 Eric Jarrige

<eric.jarrige@armadeus.org>;(C) Copyright 2008 Armadeus Systems nc;(C) Copyright 2007 Pengutronix, Sascha

Hauer <s.hauer@pengutronix.de>;(C) Copyright 2007 Pengutronix, Juergen Beisert <j.beisert@pengutronix.de>

Copyright (c) 2018 National Instruments

(C) Copyright 2019 Phytium Technology Ltd <www.phytium.com> shuyiqi <shuyiqi@phytium.com.cn>

Copyright (C) 2019 shuyiqi <shuyiqi@phytium.com.cn> liuhao <liuhao@phytium.com.cn>

Copyright (C) 2008 - 2012 Renesas Solutions Corp.

Copyright (C) 2015 Gerald Kerma <dreagle@doukki.net> Tony Dinh <mibodhi@gmail.com>

Copyright (C) 2017 Broadcom Florian Fainelli <f.fainelli@gmail.com>

(C) Copyright 2015 Elecsys Corporation <www.elecsyscorp.com> Kevin Smith <kevin.smith@elecsyscorp.com>;(C)

Copyright 2009 Marvell Semiconductor <www.marvell.com> Prafulla Wadaskar <prafulla@marvell.com>

Copyright 2010-2011 Freescale Semiconductor, Inc. author Andy Fleming

Copyright 2011, 2013 Freescale Semiconductor, Inc. author Andy Fleming

Copyright (C) 2015 Gerald Kerma <dreagle@doukki.net> Tony Dinh <mibodhi@gmail.com> Refer to doc/README.

kwbimage for more details about how-to configure and create kirkwood boot images.

Copyright 2010-2011, 2015 Freescale Semiconductor, Inc. author Andy Fleming

(C) Copyright 2013 Freescale Semiconductor, Inc.

Copyright (C) 2015 Amlogic, Inc. All rights reserved.

Copyright 2010-2011 Freescale Semiconductor, Inc. author Andy Fleming;(C) 2012 NetModule AG, David Andrey,

added KSZ9031;(C) Copyright 2017 Adaptrum, Inc. Written by Alexandru Gagniuc <alex.g@adaptrum.com> for

Adaptrum, Inc.

Copyright 2010-2011 Freescale Semiconductor, Inc. author Andy Fleming;(C) 2012 NetModule AG, David Andrey,

added KSZ9031

Copyright (C) 2013 Freescale Semiconductor, Inc.

Copyright 2011 Freescale Semiconductor, Inc. author Andy Fleming

Copyright 2017 Bernecker & Rainer Industrieelektronik GmbH

(C) Copyright 2010 Iliev <iliev@ronetix.at> Asen Dimov <dimov@ronetix.at> Ronetix GmbH <www.ronetix.

at>;(C) Copyright 2007-2008 Stelian Pop <stelian@popies.net> Lead Tech Design <www.leadtechdesign.com>

Copyright (C) 2013, Texas Instruments, Incorporated - http://www.ti.com/

(C) Copyright 2003-2008 Wolfgang Denk, DENX Software Engineering, wd@denx.de.:(C) Copyright 2008 Stelian

Pop <stelian@popies.net> Lead Tech Design <www.leadtechdesign.com> Ilko Iliev <www.ronetix.at>

Copyright (C) 2019, IBM Corporation

(C) Copyright 2007-2008 Stelian Pop <stelian@popies.net> Lead Tech Design <www.leadtechdesign.com> Ilko Iliev

<www.ronetix.at>

(C) Copyright 2007-2008 Stelian Pop <stelian@popies.net> Lead Tech Design <www.leadtechdesign.com>

Copyright 2010-2011 Freescale Semiconductor, Inc. author Andy Fleming

Copyright (C) 2015 - 2016 Xilinx, Inc.

Copyright 2010-2014 Freescale Semiconductor, Inc. Original Author: Andy Fleming Add vsc8662 phy support -

LICENCE TERMS (cont.)

Priyanka Jain
Copyright (c) 2016 Microsemi Corporation
(C) Copyright 2009 Industrie Dial Face S.p.A. Luigi 'Comio' Mantellini <luigi.mantellini@idf-hit.com>;(C) Copyright 2001 Gerald Van Baren, Custom IDEAS, vanbaren@ideas.com.
Copyright (c) 2011 The Chromium OS Authors.:(C) Copyright 2008 Graeme Russ, graeme.russ@gmail.com.
Copyright (C) 2014-2015 Stefan Roese <sr@denx.de>
Copyright (c) 2019 Microsemi Corporation
Copyright (C) 2014, Bin Meng <bmeng.cn@gmail.com>
(C) Copyright 2009 Marvell Semiconductor <www.marvell.com> Written-by: Prafulla Wadaskar <prafulla@marvell.com>
(C) Copyright 2010 Vipin Kumar, ST Micoelectronics, vipin.kumar@st.com.
Copyright (c) 2009 Micrel Inc.:(c) 2011 Bticino s.p.a, Roberto Cerati <roberto.cerati@bticino.it>
Copyright (C) 2015, Google, Inc
Copyright (C) 1997 Sten Wang
(C) Copyright 2011 Michal Simek;(C) Copyright 2011 Xilinx
Copyright 2009-2011 Freescale Semiconductor, Inc. Dave Liu <daveliu@freescale.com>
Copyright 2012 Freescale Semiconductor, Inc. Roy Zang <tie-fei.zang@freescale.com>
Copyright 2009-2011 Freescale Semiconductor, Inc.
Copyright 2011 Freescale Semiconductor, Inc.
Copyright 2009-2011 Freescale Semiconductor, Inc. Andy Fleming <afleming@gmail.com> Some part is taken from tsec.c
Copyright 2011-2015 Freescale Semiconductor, Inc.
Copyright (c) 2012-2014 Birdland Audio - <http://birdland.com/oem>
Copyright (C) 2012-2014, Birdland Audio - <http://birdland.com/oem>
Copyright 2009-2012 Freescale Semiconductor, Inc. Dave Liu <daveliu@freescale.com>
Copyright 2012 Freescale Semiconductor, Inc. Andy Fleming <afleming@gmail.com> Roy Zang <tie-fei.zang@freescale.com> Some part is taken from tsec.c
Copyright (c) 2012-2014 Birdland Audio - <http://birdland.com/oem>
Copyright (c) 2012-2014, Birdland Audio - <http://birdland.com/oem>
Copyright (C) 2011, Texas Instruments, Incorporated - <http://www.ti.com/>
Copyright (C) 2015 Toby Churchill Ltd - <http://www.toby-churchill.com/>
Copyright 2010-2011 Calxeda, Inc.
(c) 2010 Graf-Syteco, Matthias Weisser weisserm@arcor.de>
(C) Copyright 2010 Faraday Technology Po-Yu Chuang <ratbert@faraday-tech.com>;(C) Copyright 2010 Andes Technology Macpaul Lin <macpaul@andestech.com>
(C) Copyright 2011 Matthias Weisser <weisserm@arcor.de>;(C) Copyright 2009 DENX Software Engineering Author: John Rigby <jrigby@gmail.com>
(C) Copyright 2001-2015 Wolfgang Denk, DENX Software Engineering, wd@denx.de. Joe Hershberger, National Instruments
(c) 2011 Graf-Syteco, Matthias Weisser weisserm@arcor.de>
(C) Copyright 2014, Cavium Inc.
Copyright (C) 2004-2008 Freescale Semiconductor, Inc. TsiChung Liew (Tsi-Chung.Liew@freescale.com)
Copyright (C) 2009 BuS Elektronik GmbH & Co. KG Jens Scharisig (esw@bus-elektronik.de);(C) Copyright 2003 Author : Hamid Ikdoumi (Atmel)
Copyright 2017-2018 NXP
(C) Copyright 2014 Texas Instruments Incorporated, <www.ti.com>
Copyright 2016 Timesys Corporation
Copyright (C) 2018 Texas Instruments Incorporated - <http://www.ti.com>
Copyright 2015 Timesys Corporation.
Copyright 2016 Freescale Semiconductors, Inc.
Copyright (c) 2015 Texas Instruments Incorporated - <http://www.ti.com>
Copyright (C) 2016 Stefan Roese <sr@denx.de>
(C) Copyright 2003 Gerry Hamel, geh@ti.com, Texas Instruments
Copyright (c) 2011 The Chromium OS Authors.:(C) Copyright 2010 - 2011 NVIDIA Corporation <www.nvidia.com>
(C) Copyright 2010 ISEE 2007 SL, <www.iseebcn.com>
(C) Copyright 2010 Dirk Eibach, Guntermann & Drunck GmbH, dirk.eibach@gdsys.cc
Copyright (C) 2013, ISEE 2007 SL - <http://www.isee.biz/>
Copyright 1994 - 2000 Neil Russell. See License)
Copyright (C) 2013-2017, ISEE 2007 SL - <http://www.isee.biz/>
Copyright (c) 2015 Free Electrons
Copyright (C) 2019 Microchip Technology Inc. Padmarao Begari <padmarao.begari@microchip.com>
(C) Copyright 2016 Chen-Yu Tsai <wens@csie.org>
Copyright (C) 2012 Samsung Electronics authors: Andrzej Pietrasiewicz <andrzej.p@samsung.com> Lukasz Majewski <l.majewski@samsung.com>
(C) Copyright 2015 Purna Chandra Mandal, purna.mandal@microchip.com.
Copyright (C) 2015, Microchip Technology Inc. Purna Chandra Mandal <purna.mandal@microchip.com>
Copyright (C) 2014 Atmel Bo Shen <voice.shen@atmel.com>
Copyright (C) 1997-2001, 2004, 2007 Free Software Foundation, Inc.
"(C) Copyright 2012 Henrik Nordstrom <henrik@henriknordstrom.net>;(C) Copyright 2000-2003 Wolfgang Denk, DENX Software Engineering, wd@denx.de. obj-y += board.o obj-\$(CONFIG_SUN7I_GMAC) += gmac.o obj-\$(CONFIG_MACH_SUN4I) += dram_sun4i_auto.o obj-\$(CONFIG_MACH_SUN5I) += dram_sun5i_auto.o obj-\$(CONFIG_MACH_SUN7I) += dram_sun5i_auto.o"
Copyright (C) 2004-2007 Freescale Semiconductor, Inc.
(C) Copyright 2013 Oliver Schinagl <oliver@schinagl.nl>
(C) Copyright 2012-2013 Henrik Nordstrom <henrik@henriknordstrom.net>;(C) Copyright 2013 Luke Kenneth Casson Leighton <lkl@lkl.net>;(C) Copyright 2007-2011 Allwinner Technology Co., Ltd. <www.allwinnertech.com> Tom Cubie <tangliang@allwinnertech.com>
Copyright (C) 2012-2017 Marek Vasut <marex@denx.de>
(C) Copyright 2000-2009 Wolfgang Denk, DENX Software Engineering, wd@denx.de.
(C) Copyright 2015 Vishnu Patekar <vishnupatekar0510@gmail.com>
(C) Copyright 2014 Pierrick Hascoet, Abilis Systems
Copyright 2006 Freescale Semiconductor. Jeffrey Brown Srikanth Srinivasan (srikanth.srinivasan@freescale.com)
Copyright (C) 2020 Synopsys, Inc. All rights reserved.
Copyright (c) 2014 Texas Instruments Incorporated - <http://www.ti.com>
(C) Copyright 2016 Freescale Semiconductor, Inc.
Copyright 2004, 2007 Freescale Semiconductor.
Copyright (C) 2007, Guennadi Liakhovetski <lg@denx.de>;(C) Copyright 2011 Freescale Semiconductor, Inc.:(C) Copyright 2013 Adeneo Embedded <www.adeneo-embedded.com>
Copyright (C) 2008 The Android Open Source Project
Copyright(c) 2009 Dialog Semiconductor Ltd.
Copyright (C) 2010-2011 Freescale Semiconductor, Inc. Based on mx6qsabrelite.c file
Copyright (C) 2001 Peter Bergner, IBM Corp.
Copyright (C) 2010-2016 Freescale Semiconductor, Inc. All Rights Reserved.
Copyright (c) 2015-2016 Freescale Semiconductor, Inc.
Copyright (C) 2014 Eukréa Electromatique
Copyright (C) 2005-2007 Samsung Electronics Kyungmin Park <kyungmin.park@samsung.com>
Copyright (C) 2010 Marek Vasut <marek.vasut@gmail.com>
(C) Copyright 2001 Denis Peter, MPL AG Switzerland;(C) Copyright 2015 Google, Inc
Copyright 2020 Toradex
(C) Copyright 2001 Sysgo Real-Time Solutions, GmbH <www.elinos.com> Andreas Heppel <aheppel@sysgo.de>;(C) Copyright 2002 Wolfgang Denk, DENX Software Engineering, wd@denx.de.
(C) Copyright 2002 Rich Ireland, Enterasys Networks, rireland@enterasys.com. Keith Outwater, keith_outwater@mvis.com
Copyright (C) 2007 Sergey Kubushyn <ksi@koi8.net>
Copyright 2003 Motorola, Inc. Xianghua Xiao(x.xiao@motorola.com)
Copyright (C) 2018 Toradex AG
(C) Copyright 2007 Eran Liberty, Extricom, eran.liberty@gmail.com
Copyright (C) 2018-2019 Toradex AG
Copyright (c) 2004-2005 Sergey Lyubka <valenok@gmail.com> All rights reserved
Copyright 2019 Toradex
Copyright (C) 2014-2016, Toradex AG
Copyright (C) 2001 Red Hat, Inc.
Copyright (c) 2012-2014 Toradex, Inc. SPDX-License-Identifier: GPL-2.0+
Copyright (C) 2001, Russ Dill Author: Russ Dill <Russ.Dill@asu.edu> Description: Mini deflate implementation

LICENCE TERMS (cont.)

Copyright (C) 2001, Russ Dill Author: Russ Dill <Russ.Dill@asu.edu> Description: header for load kernel modules
Copyright (C) 2014-2019, Toradex AG
Copyright (C) 2010-2013 Freescale Semiconductor, Inc.
Copyright (c) 2013, Compulab Inc.
Copyright (C) 2016 Toradex AG
Copyright (C) 2004-2007, 2015 Freescale Semiconductor, Inc. TsiChung Liew (Tsi-Chung.Liew@freescale.com)
Chao Fu (B44548@freesacle.com) Haikun Wang (B53464@freescale.com)
Copyright (C) 2016-2018 Toradex AG
Copyright (C) 2015 Freescale Semiconductor, Inc. 2015 Toradex AG
Copyright (c) 2016-2020 Toradex
Copyright (c) 2016 Toradex, Inc.
Copyright © International Business Machines Corp., 2006
Copyright © 1999-2010 David Woodhouse <dwmw2@infradead.org> et al.
(C) Copyright 2009 Stefan Roese, DENX Software Engineering, sr@denx.de.
Copyright (c) 2009 Analog Devices Inc.
(C) Copyright 2003 Orbacom Systems, Inc.
Copyright 2017 Toradex AG
Copyright (C) Freescale Semiconductor, Inc. 2006. Author: Jason Jin<Jason.jin@freescale.com> Zhang Wei<wei.zhang@freescale.com>
Copyright 2000-2002 by Hans Reiser, licensing governed by reiserfs/README
Copyright 2015-2019 Toradex, Inc.
Copyright 2014 Toradex, Inc.
(C) Copyright 2012 Lucas Stach
Copyright (C) 2012 Lucas Stach
Copyright 2004, 2007, 2009, 2011, 2013 Freescale Semiconductor, Inc.:(C) Copyright 2003, Motorola, Inc.
maintained by Xianghua Xiao (x.xiao@motorola.com) author Andy Fleming
Copyright (C) 1999,2000,2001,2002,2003,2004 Free Software Foundation, Inc.
Copyright (c) 2013-2014 Stefan Agner SPDX-License-Identifier: GPL-2.0+
Copyright (c) 2013-2014, Stefan Agner
(C) Copyright 2014-2016 Stefan Agner <stefan@agner.ch>
Copyright (c) 2012-2016 Toradex, Inc.
Copyright (c) 2016 Toradex, Inc. SPDX-License-Identifier: GPL-2.0+
Copyright (c) 2016-2018 Toradex, Inc.
Copyright (c) 2016-2019, Toradex, Inc.
Copyright (c) 2014 Marcel Ziswiler SPDX-License-Identifier: GPL-2.0+
(C) Copyright 2014-2018 Marcel Ziswiler <marcel@ziswiler.com>
Copyright (c) 2014, Marcel Ziswiler
Copyright (C) 2013 Boundary Devices
Copyright 2007-2008,2010-2011 Freescale Semiconductor, Inc
Copyright (C) 2012-2013, Guennadi Liakhovetski <lg@denx.de>
Copyright (C) STMicroelectronics SA 2017 Author(s): Patrice CHOTARD, <patrice.chotard@st.com> for
STMicroelectronics.
Copyright (c) 2018 The Chromium OS Authors. All rights reserved. Use of this source code is governed by a BSD-
style license that can be found in the LICENSE file.
Copyright (c) 2016 Andreas Färber
Copyright (C) 2009 Marc Kleine-Budde <mkl@pengutronix.de>
(C) Copyright 2010, 2018 Allied Telesis <www.alliedtelesis.com>
Copyright (C) 2014 Josh Datko, Cryptotronix, jbd@cryptotronix.com 2016 Tomas Hlavacek, CZ.NIC, tmslvck@
gmail.com 2017 Marek Behun, CZ.NIC, marek.behun@nic.cz
(C) Copyright 2018 Allied Telesis
Copyright (C) 2018 Allied Telesis Labs
Copyright (C) 2017 Allied Telesis Labs
(C) Copyright 2011 - 2012 Samsung Electronics EXT4 filesystem implementation in Uboot by Uma Shankar <uma.
shankar@samsung.com> Manjunatha C Achar <a.manjunatha@samsung.com>
Copyright NXP 2020
Copyright 2011 Freescale Semiconductor, Inc. Andy Fleming <afleming@gmail.com>
Copyright (C) 2010-2016 Freescale Semiconductor, Inc.

Copyright (C) 2016 Texas Instruments Incorporated - http://www.ti.com
Copyright (C) 2015 Udoo Author: Tungyi Lin <tungyilin1127@gmail.com> Richard Hu <hakahu@gmail.com> Based
on board/wandboard/spl.c
Copyright (C) 2017 Texas Instruments Incorporated - http://www.ti.com
Copyright (C) 2014-2015 Freescale Semiconductor, Inc.
(C) Copyright 2015 UDOO Team
(C) Copyright 2017 Linaro Ltd. Sam Protsenko <semen.protsenko@linaro.org>
Copyright (C) 2012 David Purdy <david.c.purdy@gmail.com>;(C) Copyright 2009 Marvell Semiconductor <www.
marvell.com> Written-by: Prafulla Wadaskar <prafulla@marvell.com>
Copyright (C) 2016 The Android Open Source Project
Copyright (C) 2012 David Purdy <david.c.purdy@gmail.com>;(C) Copyright 2009 Marvell Semiconductor <www.
marvell.com> Written-by: Prafulla Wadaskar <prafulla@at> marvell.com Refer doc/README.kwbimage for more
details about how-to configure and create kirkwood boot image
Copyright (C) 2019 Linaro Ltd.
Copyright (C) 2017 The Android Open Source Project
Copyright (C) 2015 Altera Corporation <www.altera.com>
Copyright (C) 2018 The Android Open Source Project
(C) Copyright 2001-2006 Wolfgang Denk, DENX Software Engineering, wd@denx.de.:(C) Copyright 2010, Thomas
Chou <thomas@wytron.com.tw>
Copyright (c) 2013 Google, Inc.
Copyright (C) 2016-2017 Intel Corporation <www.intel.com>
Copyright (c) Thomas Gleixner <tglx@linutronix.de>
Copyright (c) 2013 Google, Inc.:(C) Copyright 2012 Pavel Herrmann <morpheus.ibis@gmail.com> Marek Vasut
<marex@denx.de>
(C) Copyright 2016 Rockchip Electronics Co., Ltd
Copyright (c) 2019 Google, Inc
Copyright (C) 2018 Lukasz Majewski, DENX Software Engineering, lukma@denx.de This is an example file to
generate boot.scr - a boot script for U-Boot Generate boot.scr: tools/mkimage -c none -A arm -T script -d tpcboot.
cmd boot.scr
Copyright (C) 2018, DENX Software Engineering Lukasz Majewski <lukma@denx.de>
Copyright (c) 2017 Google, Inc.:(C) Copyright 2012 Pavel Herrmann <morpheus.ibis@gmail.com> Marek Vasut
<marex@denx.de>
Copyright (C) 2018 Lukasz Majewski, DENX Software Engineering, lukma@denx.de
Copyright (C) 1996-2005 Paul Mackerras.
Copyright (C) 2015 Masahiro Yamada <yamada.masahiro@socionext.com>
Copyright (C) 2018 Lukasz Majewski <lukma@denx.de>
Copyright (C) 2015 Masahiro Yamada <yamada.masahiro@socionext.com>
(c) Copyright 2010-2014 Xilinx, Inc. All rights reserved.
Copyright (C) 2013 Google, Inc.:(C) Copyright 2012 Pavel Herrmann <morpheus.ibis@gmail.com> Marek Vasut
<marex@denx.de>
Copyright (C) 2018 Jagan Teki <jagan@amarulasolutions.com>
(C) Copyright 2018 Quentin Schulz, Bootlin, quentin.schulz@bootlin.com
Copyright (c) 2014 Nobuhiro Iwamatsu <nobuhiro.iwamatsu.yj@renesas.com>
Copyright (c) 2016 Marcel Ziswiler <marcel.ziswiler@toradex.com>
Copyright (c) 2015 Angelo Dureghello <angelo@sysam.it>
Copyright (c) 2015 Vladimir Zapolskiy <vz@mleia.com>
(C) Copyright 2016 Stephen Warren <swarren@wwwdotorg.org>
Copyright (c) 2018 Angelo Dureghello <angelo@sysam.it>
Copyright (C) 2016 Cadence Design Systems Inc.
Copyright (c) Xilinx, Inc.
(C) Copyright 2012 Ilya Yanok, ilya.yanok@gmail.com
(C) Copyright 2014 Google, Inc Simon Glass <sjg@chromium.org>
Copyright (c) 2018, Xilinx, Inc.
(C) Copyright 2012 Michal Simek <monstr@monstr.eu>;(C) Copyright 2013 - 2018 Xilinx, Inc.
Copyright 2015 Stephen Warren
(C) Copyright 2015 Google, Inc.:(C) Copyright 2008-2014 Rockchip Electronics
(c) Copyright 2015 Xilinx, Inc. All rights reserved.

LICENCE TERMS (cont.)

(C) Copyright 2018 Xilinx, Inc. Siva Durga Prasad Paladugu <siva.durga.paladugu@xilinx.com>
(C) Copyright 2014 - 2016 Xilinx, Inc. Michal Simek <michal.simek@xilinx.com>
Copyright (C) 2008 Freescale Semiconductor, Inc. Dave Liu <daveliu@freescale.com>
Copyright (C) 1996-1999 SciTech Software, Inc.
(C) Copyright 2019 Luca Ceresoli <luca@lucaceresoli.net>
Copyright (C) 2003 Arabella Software Ltd. Yuli Barcohen <yuli@arabellasw.com>
(C) Copyright 2014 - 2015 Xilinx, Inc. Michal Simek <michal.simek@xilinx.com>
Copyright (C) 2003-2006 Christophe Devine
(C) Copyright 2016 - 2018 Xilinx, Inc. Michal Simek <michal.simek@xilinx.com>
Copyright (c) 2013, Andreas Oetken.
(C) Copyright 2014 - 2018 Xilinx, Inc. Michal Simek <michal.simek@xilinx.com>
(C) Copyright 2014 - 2019 Xilinx, Inc. Michal Simek <michal.simek@xilinx.com>
(C) Copyright 2018 Xilinx, Inc. (Michal Simek)
Copyright (C) 1995-2005 Jean-loup Gailly and Mark Adler
Copyright (c) 2018, Luca Ceresoli <luca@lucaceresoli.net>
(C) Copyright 2007-2018 Michal Simek
(C) Copyright 2007 - 2016 Michal Simek
(C) Copyright 2009 Vipin Kumar, ST Micoelectronics, vipin.kumar@st.com.
(C) Copyright 2010 Faraday Technology Dante Su <dantesu@faraday-tech.com>
Copyright (C) 2005 for Samsung Electronics
Copyright (C) 2008 Intel Corp. Author: Sarah Sharp
Copyright (c) 2005, 2009 Freescale Semiconductor, Inc
Copyright (C) 2011 Jana Rapava <fermata7@gmail.com>
Copyright (C) 2011 Simon Guinot <sguinot@lacie.com>
Copyright (C) 2007 Rodolfo Giometti <giometti@linux.it>
Copyright (C) 2013 Simon Guinot <simon.guinot@sequanux.org>
(C) Copyright 2005 ARM Ltd. Peter Pearce, <Peter.Pearse@arm.com>
Copyright (C) 2011 Simon Guinot <sguinot@lacie.com>;(C) Copyright 2009 Marvell Semiconductor <www.marvell.com> Written-by: Prafulla Wadaskar <prafulla@marvell.com>
Copyright 2009-2012, 2013 Freescale Semiconductor, Inc. Jun-jie Zhang <b18070@freescale.com> Mingkai Hu <Mingkai.hu@freescale.com>
Copyright (C) 2011 Simon Guinot <sguinot@lacie.com>;(C) Copyright 2009 Marvell Semiconductor <www.marvell.com> Written-by: Prafulla Wadaskar <prafulla@marvell.com> Refer doc/README.kwbimage for more details about how-to configure and create kirkwood boot image
(C) 2000 by Paolo Scaffardi (arsenio@tin.it) AIRVENT SAM s.p.a - RIMINI(ITALY)
(C) Copyright 2009 Industrie Dial Face S.p.A.
Copyright 2012 Texas Instruments
Copyright 2013 - 2015 Freescale Semiconductor, Inc.
Copyright (C) 2010 Albert ARIBAUD <albert.u.boot@aribaud.net>;(C) Copyright 2009 Marvell Semiconductor <www.marvell.com> Written-by: Prafulla Wadaskar <prafulla@marvell.com>
(C) Copyright 2017 Jorge Ramirez-Ortiz <jorge.ramirez-ortiz@gmail.com>
(C) Copyright 2017 Jorge Ramirez-Ortiz <jorge.ramirez-ortiz@linaro.org>
Copyright 2007, 2011 Freescale Semiconductor, Inc. Authors: York Sun <yorksun@freescale.com> Timur Tabi <timur@freescale.com>
Copyright (C) 2009, Guennadi Liakhovetski <g.liakhovetski@gmx.de>
Copyright (C) 1999 VA Linux Systems
Copyright (C) 2018 Exceet Electronics GmbH
Copyright (C) 2014 Sean Cross from <https://github.com/xobs/novena-linux.git> commit 3d85836ee1377d445531928361809612aa0a18db
(C) Copyright 2016 Heiko Schocher, DENX Software Engineering, hs@denx.de.
(C) Copyright 2000-2002 Wolfgang Denk, DENX Software Engineering, wd@denx.de.:(C) 1998 Gabriel Paubert, paubert@iram.es
Copyright (C) 2018 Toradex Authors: Stefan Agner <stefan.agner@toradex.com>
Copyright (C) 2018 Robert Bosch Power Tools GmbH
Copyright (C) 2011 Samsung Electronics Lukasz Majewski <l.majewski@samsung.com>
(C) Copyright 2007 Gerald Van Baren, Custom IDEAS, vanbaren@cideas.com
(C) Copyright 2005 2N Telekomunikace, a.s. <www.2n.cz> Ladislav Michl <michl@2n.cz>

Copyright (C) 2010 Texas Instruments Incorporated - <http://www.ti.com/>
Copyright (C) Freescale Semiconductor, Inc. 2006-2007;(C) Copyright 2010 Heiko Schocher, DENX Software Engineering, hs@denx.de.
(C) Copyright 2011 Andes Technology Corp Macpaul Lin <macpaul@andestech.com>
Copyright (c) 2012 Michael Walle Michael Walle <michael@walle.cc>
Copyright 2016 Google Inc.
Copyright (c) 2012 Michael Walle Michael Walle <michael@walle.cc> Refer doc/README.kwbimage for more details about how-to configure and create kirkwood boot image
Copyright (c) 2015 Google, Inc.:(C) Copyright 2000-2002 Wolfgang Denk, DENX Software Engineering, wd@denx.de.
Copyright 2003-2004 Red Hat, Inc. All rights reserved.
Copyright (C) 2009 Sergey Kubushyn <ksi@koi8.net>
Copyright (C) 1996-2002 Julian R Seward. All rights reserved.
(C) Copyright 2002 Wolfgang Denk, DENX Software Engineering, wd@denx.de.:(C) Copyright 2010 Michael Zaidman, Kodak, michael.zaidman@kodak.com post_word_{load|store} cleanup.
(C) Copyright 2009-2012 Wojciech Dubowik <wojciech.dubowik@neratec.com> Luka Perkov <luka@openwrt.org> Refer doc/README.kwbimage for more details about how-to configure and create kirkwood boot image
Copyright (C) 2013 Texas Instruments Incorporated - <http://www.ti.com/>
Copyright (C) 2014, Compulab Ltd - <http://compulab.co.il/>
Copyright (C) 2018 Synopsys, Inc. All rights reserved.
(C) Copyright 2008 Dirk Behme <dirk.behme@gmail.com>
Copyright (c) 2010 Texas Instruments, Inc. Jason Kridner <jkridner@beagleboard.org>
(C) Copyright 2004-2011 Texas Instruments, <www.ti.com>
Copyright (C) 1996 Larry Ewing (lewing@isc.tamu.edu)
(C) Copyright 2008 Semihalf;(C) Copyright 2000-2005 Wolfgang Denk, DENX Software Engineering, wd@denx.de.
Copyright (C) 2013 Bernardo Innocenti <bernie@develer.com> Based on former asm-ppc/div64.h and asm-m68knommu/div64.h
(C) Copyright 2012-2015 Texas Instruments Incorporated, <www.ti.com> SPDX-License-Identifier: GPL-2.0+
(C) Copyright 2011 Graeme Russ, <graeme.russ@gmail.com>
(C) Copyright 2014-2015 Texas Instruments Incorporated, <www.ti.com>
Copyright (C) 2012 Samsung Electronics R. Chandrasekar <rcsekar@samsung.com>
Copyright (C) 2006-2009 Freescale Semiconductor, Inc.
(C) Copyright 2015 Texas Instruments Incorporated, <www.ti.com>
Copyright (C) 2000, 2004, 2005 MIPS Technologies, Inc. All rights reserved. Authors: Carsten Langgaard <carsten@mips.com> Maciej W. Rozycki <macro@mips.com>
(C) Copyright 2011 Helmut Raiger, HALE electronic GmbH, helmut.raiger@hale.at
(C) Copyright 2015 Xilinx, Inc, Michal Simek <michal.simek@xilinx.com>
Copyright (C) 2008 Atmel Corporation
"Copyright (c) Marc A. Viredaz, 1998 DEC Western Research Laboratory, Palo Alto, CA Date January 1998 (April 1997) System StrongARM SA-1100 LanguageC or ARM Assembly Purpose Definition of constants related to the StrongARM SA-1100 microprocessor (Advanced RISC Machine (ARM))"
Copyright (c) 2004-2008 Texas Instruments;(C) Copyright 2002 Gary Jennejohn, DENX Software Engineering, <garyj@denx.de>
Copyright (C) 2015-2016 Texas Instruments Incorporated - <http://www.ti.com/>
Copyright (C) 2015-2016 Texas Instruments Incorporated - <http://www.ti.com/> Lokesh Vutla Steve Kipisz
Copyright (C) 2015-2016 Texas Instruments Incorporated - <http://www.ti.com/>
Copyright (C) 2011 Mistral Solutions Pvt Ltd
(C) Copyright 2013 Texas Instruments Incorporated, <www.ti.com>
(C) Copyright 2014 NVIDIA Corporation <www.nvidia.com>
Copyright (C) 2016 Freescale Semiconductor, Inc. All Rights Reserved.
(C) Copyright 2010 Stefano Babic, DENX Software Engineering, sbabic@denx.de.:(C) Copyright 2009 Freescale Semiconductor, Inc.
Copyright (c) 1999 Dan Malek (dmalek@jlc.net)
(C) Copyright 2010 Texas Instruments Incorporated, <www.ti.com>
Copyright (c) 2017 Rob Clark
(C) Copyright 2010 Texas Instruments Incorporated, <www.ti.com> Steve Sakoman <steve@sakoman.com>
(C) Copyright 2008 Nishanth Menon <menon.nishanth@gmail.com>

LICENCE TERMS (cont.)

Copyright (C) 2014 STMicroelectronics -- All Rights Reserved
Copyright (c) 2013, NVIDIA CORPORATION. All rights reserved.
(C) Copyright 2018 Ramon Fried <ramon.fried@gmail.com>
Copyright (c) 2013 MundoReader S.L. Author: Heiko Stuebner <heiko@sntech.de>
Copyright (C) 2013, Adeneo Embedded <www.adeneo-embedded.com> Antoine Tenart, <atenart@adeneo-embedded.com>
Copyright (C) 2018 Texas Instruments
Copyright (C) 2013 Texas Instruments Incorporated - http://www.ti.com/ Author: Rajendra Nayak <rnayak@ti.com>
Copyright (C) 2013, Adeneo Embedded <www.adeneo-embedded.com> Antoine Tenart, <atenart@adeneo-embedded.com>
Copyright (C) 2013 Jean-Christophe PLAGNIOL-VILLARD <plagnioj@jrcosoft.com>
Copyright (C) 2009 Nokia
(C) Copyright 2010 Texas Instruments Incorporated, <www.ti.com> Aneesh V <aneesh@ti.com> Steve Sakoman <steve@sakoman.com>
Copyright (C) 2018 Álvaro Fernández Rojas <noltari@gmail.com>
Copyright (C) 2013 Ludovic Desroches <ludovic.desroches@atmel.com>
Copyright (C) 2010 Texas Instruments
Copyright (C) 2014 Texas Instruments Incorporated - http://www.ti.com
Copyright (C) 2015, Inverse Path Andrej Rosano <andrej@inversepath.com>
Copyright (C) 2015 Sakari Ailus
(C) Copyright 2013 Reinhard Pfau, Guntermann & Drunck GmbH, reinhard.pfau@gdsys.cc
Copyright 2010-2011 Freescale Semiconductor, Inc. Authors: Timur Tabi <tumur@freescale.com>
(C) Copyright 2013 Dirk Eibach, Guntermann & Drunck GmbH, dirk.eibach@gdsys.cc
Copyright (c) 2015, NVIDIA CORPORATION.
Copyright 2010 Freescale Semiconductor, Inc. Authors: Srikanth Srinivasan <srikanth.srinivasan@freescale.com> Timur Tabi <tumur@freescale.com>
Copyright (C) 2016 Icenowy Zheng <icenowy@aosc.io>
(C) Copyright 2016 Mario Six, Guntermann & Drunck GmbH, mario.six@gdsys.cc
Copyright (C) 2015 Stefan Roese <sr@denx.de>
Copyright (c) 2014, Steffen Trumtrar <s.trumtrar@pengutronix.de>
Copyright 2016 Maxime Ripard
Copyright (C) 2016-2018 Intel Corporation. All rights reserved
(C) Copyright 2015 Dirk Eibach, Guntermann & Drunck GmbH, dirk.eibach@gdsys.cc
(C) Copyright 2014 Dirk Eibach, Guntermann & Drunck GmbH, dirk.eibach@gdsys.cc
(C) Copyright 2007 Stefan Roese, DENX Software Engineering, sr@denx.de.
Copyright (C) 2017 Impinj, Inc.
Copyright (C) 2018 Zodiac Inflight Innovations
Copyright (C) 2013 Texas Instruments Eduardo Valentin <eduardo.valentin@ti.com>
Copyright (C) 2016 Endless Mobile, Inc. Author: Carlo Caione <carlo@endlessm.com>
(C) Copyright 2012 Dirk Eibach, Guntermann & Drunck GmbH, dirk.eibach@gdsys.cc
Copyright (C) 2014 STMicroelectronics All Rights Reserved
Copyright (c) 2019 MediaTek Inc.
Copyright (C) 2016 Cogent Embedded, Inc.
Copyright (C) 2007 Freescale Semiconductor, Inc.
Copyright (c) 2014 MundoReader S.L. Author: Heiko Stuebner <heiko@sntech.de>
Copyright 2017 Texas Instruments, Inc.
(C) Copyright 2015 Dirk Eibach, Guntermann & Drunck GmbH, eibach@gdsys.de
Copyright 2013 Ideas On Board SPRL
Copyright (c) 2015 Heiko Stuebner <heiko@sntech.de>
Copyright (C) 2012 Texas Instruments Incorporated - http://www.ti.com/
Copyright (c) 2016 Rockchip Electronics Co. Ltd.
(C) Copyright 2002 Gary Jennejohn, DENX Software Engineering, <garyj@denx.de>;(C) Copyright 2008 Guennadi Liakhovetki, DENX Software Engineering, <lg@denx.de>
Copyright (C) 2010 Texas Instruments Incorporated - http://www.ti.com/
Copyright (c) 2018 BayLibre, SAS
(C) Copyright 2015 Heiko Stuebner
(C) Copyright 2014 DENX Software Engineering Written-By: Albert ARIBAUD <albert.aribaud@3adev.fr>

Copyright (C) 2019, Intel Corporation
Copyright (c) 2014 DENX Written-by: Albert ARIBAUD <albert.aribaud@3adev.fr>
Copyright (c) 2017 Rockchip Electronics Co. Ltd. Author: Elaine <zhangqing@rock-chips.com>
Copyright (C) DENX Written-by: Albert ARIBAUD <albert.aribaud@3adev.fr>;(C) Copyright 2010 Robert Aigner (ra@spiid.net)
(C) Copyright 2018 Rockchip Electronics Co., Ltd
(C) Copyright 2019 Rockchip Electronics Co., Ltd
Copyright (c) 2015 Hisilicon Limited.
(C) Copyright 2015 Rockchip Electronics Co., Ltd
Copyright (c) 2014 Samsung Electronics Co., Ltd. Author: Naveen Krishna Ch <naveenkrishna.ch@gmail.com>
Copyright 2013 Lucas Stach, Pengutronix <l.stach@pengutronix.de>
Copyright 2016 Rockchip Electronics Co., Ltd Authors: Andy Yan <andy.yan@rock-chips.com>
Copyright (c) 2016 HiSilicon Technologies Co., Ltd.
Copyright (c) 2017 Rockchip Electronics Co. Ltd. Author: Shawn Lin <shawn.lin@rock-chips.com>
Copyright (c) 2017 Andy Yan
Copyright (C) 2014 STMicroelectronics Author: Gabriel Fernandez <gabriel.fernandez@st.com> License terms: GNU General Public License (GPL), version 2
Copyright © 2015 Broadcom
Copyright (C) 2017 Impinj
Copyright (C) 2016 Glider bvba
Copyright (C) 2017 Cogent Embedded Inc.
(C) Copyright 2014 NVIDIA Corporation <www.nvidia.com>
Copyright (c) 2015-2016, NVIDIA CORPORATION.
(C) Copyright 2016 Linaro Jon Medhurst <tixy@linaro.org>
(C) Copyright 2002 Sysgo Real-Time Solutions, GmbH <www.elinos.com> Marius Groeger <mgroeger@sysgo.de>;(C) Copyright 2002 David Mueller, ELISOFT AG, <d.mueller@elsoft.ch>;(C) Copyright 2003 Texas Instruments, <www.ti.com> Kshitij Gupta <Kshitij@ti.com>;(C) Copyright 2004 ARM Ltd. Philippe Robin, <philippe.robin@arm.com>
(C) Copyright 2000-2006 Wolfgang Denk, DENX Software Engineering, wd@denx.de.:(C) Copyright 2004 ARM Ltd. Philippe Robin, <philippe.robin@arm.com>
Copyright (c) 1999-2002 Vojtech Pavlik
(C) Copyright 2004, ARM Ltd. Philippe Robin, <philippe.robin@arm.com>
Copyright (C) ARM Limited
(C) Copyright 2011 Linaro Linus Walleij <linus.walleij@linaro.org> Register definitions for the System Controller (SC) and the similar "CP Controller" found in the ARM Integrator/AP and Integrator/CP reference designs
(C) Copyright 2011 Linaro Linus Walleij <linus.walleij@linaro.org> Register definitions for the External Bus Interface (EBI) found in the ARM Integrator AP and CP reference designs
Copyright (c) 2004, 2008 IBM Corporation
Copyright (c) 2018, Linaro Limited */
(C) Copyright 2002 Sysgo Real-Time Solutions, GmbH <www.elinos.com> Marius Groeger <mgroeger@sysgo.de>;(C) Copyright 2002 David Mueller, ELISOFT AG, <d.mueller@elsoft.ch>;(C) Copyright 2003 Texas Instruments, <www.ti.com> Kshitij Gupta <Kshitij@ti.com>;(C) Copyright 2004 ARM Ltd. Philippe Robin, <philippe.robin@arm.com>;(C) Copyright 2011 Linaro Linus Walleij <linus.walleij@linaro.org>
(C) Copyright 2016 Linaro Limited Andrew F. Davis <andrew.davis@linaro.org>
(C) Copyright 2013 David Feng <fenghua@phytium.com.cn> Sharma Bhupesh <bhupesh.sharma@freescale.com>
Copyright 2010-2011 Freescale Semiconductor, Inc.
Copyright (C) ARM Ltd 2015
(C) Copyright 2011-2012 Pali Rohár <pali.rohar@gmail.com>
(C) Copyright 2012 Ивайло Димитров <freemangordon@abv.bg>;(C) Copyright 2011-2012 Pali Rohár <pali.rohar@gmail.com>;(C) Copyright 2008 Dirk Behme <dirk.behme@gmail.com>
(C) Copyright 2012 Ивайло Димитров <freemangordon@abv.bg>;(C) Copyright 2011-2012 Pali Rohár <pali.rohar@gmail.com>;(C) Copyright 2010 Alistair Buxton <a.j.buxton@gmail.com>;(C) Copyright 2004-2008 Texas Instruments, <www.ti.com>
(C) Copyright 2011-2012 Pali Rohár <pali.rohar@gmail.com>
(C) Copyright 1997-2002 ELTEC Elektronik AG Frank Gottschling <fgottschling@eltec.de>
Copyright (C) 2016 NXP Semiconductors Author: Fabio Estevam <fabio.estevam@nxp.com>
(C) Copyright 2016 NXP Semiconductors

LICENCE TERMS (cont.)

Copyright (C) 2016 NXP Semiconductors
(C) Copyright 2012 Texas Instruments, <www.ti.com>
(C) Copyright 2011 Stefano Babic, DENX Software Engineering, sbabic@denx.de;(C) Copyright 2005-2010 Freescale Semiconductor, Inc.
Copyright 2015 Freescale Semiconductor
Copyright (C) 2016 BayLibre, SAS Author: Neil Armstrong <narmstrong@baylibre.com>
(C) Copyright 2019 BayLibre, SAS Author: Neil Armstrong <narmstrong@baylibre.com>
Copyright (C) 2017 Jagan Teki <jagan@amarulasolutions.com>
Copyright 2009, Matthias Fuchs <matthias.fuchs@esd.eu>
Copyright (C) 2004 by FS Forth-Systeme GmbH. All rights reserved.
Copyright 2009 C.JSC "NII STT", <http://www.niistt.ru/>
(C) Copyright 2016 BayLibre, SAS Author: Neil Armstrong <narmstrong@baylibre.com>
(C) Copyright 2002 Daniel Engström, Omicron Ceti AB <daniel@omicron.se>.
(C) Copyright 2010 Marvell Semiconductor <www.marvell.com> Written-by: Prafulla Wadaskar <prafulla@marvell.com>
(C) Copyright 2009 Faraday Technology Po-Yu Chuang <ratbert@faraday-tech.com>;(C) Copyright 2011 Andes Technology Corp Macpaul Lin <macpaul@andestech.com>
Copyright (C) 2010 Andes Technology Corporation Gavin Guo, Andes Technology Corporation <gavinguo@andestech.com> Macpaul Lin, Andes Technology Corporation <macpaul@andestech.com>
Copyright (C) 2018 STMicroelectronics - All Rights Reserved Author(s): Yannick Fertre <yannick.fertre@st.com> for STMicroelectronics. Philippe Cornu <philippe.cornu@st.com> for STMicroelectronics.
Copyright (C) 2010 The Android Open Source Project
Copyright (C) 2007-2009 Industrie Dial Face S.p.A. Luigi 'Comio' Mantellini (luigi.mantellini@idf-hit.com)
Copyright (C) 2010 Guennadi Liakhovetski <g.liakhovetski@gmx.de>
(C) Copyright 2010,2011 NVIDIA Corporation <www.nvidia.com>
Copyright (c) 2009 esd gmbh.
(C) Copyright 2006 Wolfgang Denk, DENX Software Engineering, wd@denx.de.
Copyright 2019 NXP Yangbo Lu <yangbo.lu@nxp.com>
Copyright (c) 2018 Ramon Fried <ramon.fried@gmail.com>
(C) Copyright 2006 Bryan O'Donoghue, deckard@codehermit.ie, CodeHermit
Copyright (c) 2008-2009 esd gmbh.:(C) Copyright 2006 Wolfgang Denk, DENX Software Engineering, wd@denx.de.
Copyright (C) 2014-2016 Freescale Semiconductor, Inc.
Copyright (c) 2006 Wind River Systems, Inc.
(C) Copyright 2007-2008 Stelian Pop <stelian@popies.net> Lead Tech Design <www.leadtechdesign.com>;(C)
Copyright 2009-2015 Daniel Gorsulowski <daniel.gorsulowski@esd.eu> esd electronic system design gmbh <www.esd.eu>
(C) Copyright 2015 Heiko Schocher, DENX Software Engineering, hs@denx.de.
Copyright 2013-2014 Freescale Semiconductor, Inc.
Copyright (c) 2015 Samsung Electronics
(C) Copyright 2014 Heiko Schocher, DENX Software Engineering, hs@denx.de.
(C) Copyright 2001 Wolfgang Denk, DENX Software Engineering, wd@denx.de.:(c) | (c) << 1 | (c) << 2 | (c) << 3 | \
(C) 2009 by Detlev Zundel, DENX Software Engineering GmbH;(c) Rob Taylor, Flying Pig Systems. 2000.:(C) 2005 Wind River Systems
Copyright 2013-2019 Arcturus Networks Inc. <https://www.arcturusnetworks.com/products/> by Oleksandr G Zhadan et al.
Copyright 2013-2015 Arcturus Networks, Inc. <http://www.arcturusnetworks.com/products/ucp1020/> based on board/freescale/p1_p2_rdb_pc/spl.c
Copyright 2013-2015 Arcturus Networks, Inc. based on board/freescale/p1_p2_rdb_pc/Makefile
(C) Copyright 2000-2005 Wolfgang Denk, DENX Software Engineering, wd@denx.de.
Copyright 2013-2019 Arcturus Networks, Inc. <https://www.arcturusnetworks.com/products/ucp1020/> by Oleksandr G Zhadan et al. based on board/freescale/p1_p2_rdb_pc/spl.c
Copyright 2013-2015 Arcturus Networks, Inc <http://www.arcturusnetworks.com/products/ucp1020/> based on board/freescale/p1_p2_rdb_pc/tlb.c
Copyright 2013-2015 Arcturus Networks, Inc. <http://www.arcturusnetworks.com/products/ucp1020/> based on board/freescale/p1_p2_rdb_pc/spl_minimal.c
Copyright (c) 2018 Toradex, Inc.
Copyright 2013-2019 Arcturus Networks, Inc. <https://www.arcturusnetworks.com/products/ucp1020/> by Oleksandr G

Zhadan et al.
Copyright (C) 2013 Gabor Juhos <juhosg@openwrt.org>
Copyright (C) 2014 Soeren Moch <smoch@web.de>
(C) Copyright 2013-2014 NVIDIA Corporation <www.nvidia.com>
Copyright (C) 2017 Soeren Moch <smoch@web.de>
(C) Copyright 2019 Arkadiusz Karas <arkadiusz.karas@somlabs.com>
Copyright (C) 2015 Renesas Electronics Corporation
Copyright (C) 2017-2019 A. Karas, SomLabs
Copyright (C) Freescale Semiconductor, Inc. 2006.
Copyright (C) 2017 A. Karas
(C) Copyright 2003 Josef Baumgartner <josef.baumgartner@telex.de>
Copyright (C) 2016 Amarula Solutions B.V.
(C) Copyright 2009 Marvell Semiconductor <www.marvell.com> Prafulla Wadaskar <prafulla@marvell.com>;(C)
Copyright 2009 Stefan Roesse, DENX Software Engineering, sr@denx.de.:(C) Copyright 2010-2011 Heiko Schocher, DENX Software Engineering, hs@denx.de.
(C) Copyright 2008-2011 Heiko Schocher, DENX Software Engineering, hs@denx.de.
(C) Copyright 2009-2015 Marvell Semiconductor <www.marvell.com>
Copyright (C) 2016 Hannes Schmelzer <oe5hpm@oevsv.at> - Bernecker & Rainer Industrieelektronik GmbH - <http://www.br-automation.com>
Copyright (C) 2014 Samsung Electronics Sanghee Kim <sh0130.kim@samsung.com> Piotr Wilczek <p.wilczek@samsung.com> Przemyslaw Marczak <p.marczak@samsung.com>
(C) Copyright 2008 Grazvydas Ignatas <notasas@gmail.com>
Copyright (c) 2008, 2009 esd gmbh Hannover Germany;(C) Copyright 2006-2010 Wolfgang Denk, DENX Software Engineering, wd@denx.de.
(C) Copyright 2008 Grazvydas Ignatas <notasas@gmail.com>;(C) Copyright 2004-2008 Texas Instruments, <www.ti.com>
Copyright (C) 2014 Stefan Roesse <sr@denx.de>
Copyright (C) 2018 Philippe Reynes <philippe.reynes@softathome.com>
Copyright (C) 2011-2012 Gerald Kerma <dreagle@doukki.net> Simon Baatz <gmbnomis@gmail.com> Luka Perkov <luka@openwrt.org>
(C) Copyright 2015-2016 Freescale Semiconductor, Inc.
Copyright (C) 2011-2012 Gerald Kerma <dreagle@doukki.net> Luka Perkov <luka@openwrt.org> Simon Baatz <gmbnomis@gmail.com>
Copyright (C) 2011-2012 Gerald Kerma <dreagle@doukki.net> Simon Baatz <gmbnomis@gmail.com> Luka Perkov <luka@openwrt.org> Refer doc/README.kwbimage for more details about how-to configure and create kirkwood boot image
Copyright (C) 2014, Barco (www.barco.com)
Copyright (c) 2006 Wind River Systems, Inc.
Copyright (C) 2019 BayLibre, SAS Author: Jerome Brunet <jbrunet@baylibre.com>
Copyright (c) 2006-2007 Wind River Systems, Inc.
Copyright (C) 2010 Heiko Schocher <hs@denx.de>
(C) Copyright 2013 Texas Instruments Incorporated. Lokesh Vutla <lokeshvutla@ti.com>
Copyright (c) 2010-2012 NVIDIA CORPORATION. All rights reserved.
Copyright (C) 2013, 2014 Renesas Electronics Corporation
(C) Copyright 2011 Linaro Ryan Harkin, <ryan.harkin@linaro.org>
Copyright 2011-2012 Freescale Semiconductor, Inc.
Copyright (C) 2017 Marek Behun <marek.behun@nic.cz>
Copyright (C) 2018 Renesas Electronics Corporation
Copyright (C) 2017 Marek Behun <marek.behun@nic.cz>
(C) Copyright 2005, Psynt Corporation <www.psyent.com> Scott McNutt <smcnutt@psyent.com>;(C) Copyright 2010, Thomas Chou <thomas@wytron.com.tw>
Copyright (C) 2018 Marek Behun <marek.behun@nic.cz>
(C) Copyright 2018 Xilinx, Inc. Michal Simek <michal.simek@xilinx.com> Siva Durga Prasad Paladugu <sivadur@xilinx.com>
Copyright (C) 2016 samtec automotive software & electronics gmbh
Copyright (C) 2015-2016 Stefan Roesse <sr@denx.de>
(C) Copyright 2015 ECA Sinters

LICENCE TERMS (cont.)

Copyright (C) 2018 B&R Industrial Automation GmbH - <http://www.br-automation.com/>
Copyright (C) 2013 Seco USA Inc
Copyright (C) 2007 Freescale Semiconductor, Inc. Kevin Lam <kevin.lam@freescale.com> Joe D'Abbraccio <joe.d'abbraccio@freescale.com>
(C) Copyright 2013-2015 NVIDIA Corporation <www.nvidia.com>
Copyright 2014 Freescale Semiconductor
(C) Copyright 2019 Linaro Author: Manivannan Sadhasivam <manivannan.sadhasivam@linaro.org>
Copyright (C) 2004-2007, 2012 Freescale Semiconductor, Inc. TsiChung Liew (Tsi-Chung.Liew@freescale.com)
(c) Copyright 2010-2014 Xilinx, Inc. All rights reserved.:(c) Copyright 2016 Topic Embedded Products.
Copyright (C) 2006 Freescale Semiconductor, Inc.
Copyright (C) 2009 Samsung Electronics Minkyu Kang <mk7.kang@samsung.com> Kyungmin Park <kyungmin.park@samsung.com>
(C) Copyright 2006-2010 Wolfgang Denk, DENX Software Engineering, wd@denx.de.
(C) Copyright 2019 Vasily Khoruzhick
(C) Copyright 2012 Holger Brunck, Keymile GmbH Hannover, <holger.brunck@keymile.com> Christian Herzig, Keymile AG Switzerland, <christian.herzig@keymile.com>
(C) Copyright 2019 Vasily Khoruzhick <anarsoul@gmail.com>
Copyright 2007,2009 Wind River Systems <www.windriver.com>
(C) Copyright 2016 samtec automotive software & electronics gmbh
Copyright (C) 2016 samtec automotive software & electronics gmbh
Copyright (C) 2011-2012 Gerald Kerma <dreagle@doukki.net> Luka Perkov <luka@openwrt.org>
(C) Copyright 2011 Bluewater Systems Author: Andre Renaud <andre@bluewatersys.com> Author: Ryan Mallon <ryan@bluewatersys.com>
Copyright (C) 2016 Timesys Corporation
Copyright (C) Stefano Babic <sbabic@denx.de>
Copyright (C) 2017 Marek Vasut <marex@denx.de>
Copyright (C) 2017 NXP Semiconductors
Copyright (C) 2014, STMicroelectronics - All Rights Reserved Author(s): Vikas Manocha, <vikas.manocha@st.com> for STMicroelectronics.
Copyright 2016 Broadcom Ltd.
(C) Copyright 2016 Broadcom Ltd.
Copyright (C) 2012 Freescale Semiconductor, Inc.
Copyright (C) 2019 Philippe Reynes <philippe.reynes@softathome.com>
Copyright (C) 2014 Marek Vasut <marex@denx.de>
Copyright (C) 2013, 2014, 2017 Markus Niebel <Markus.Niebel@tq-group.com>
(C) Copyright 2018 Cisco Systems, Inc.
Copyright (C) 2018 Microchip Corporation Eugen Hristev <eugen.hristev@microchip.com>
Copyright (C) 2016 Renesas Electronics Corporation
Copyright (C) 2014 Evgeni Dobrev <evgeni@studio-punkt.com>;(C) Copyright 2009 Marvell Semiconductor <www.marvell.com> Written-by: Prafulla Wadaskar <prafulla@marvell.com>
Copyright (C) 2012 Nobuhiro Iwamatsu <nobuhiro.iwamatsu.yj@renesas.com>
Copyright (C) 2014 Gateworks Corporation Author: Tim Harvey <tharvey@gateworks.com>
(C) Copyright 2010-2012 NVIDIA Corporation <www.nvidia.com>
(C) Copyright 2012-2013 Henrik Nordstrom <henrik@henriknordstrom.net>;(C) Copyright 2013 Luke Kenneth Casson Leighton <lkcl@lkcl.net>
Copyright (C) 2010 Andreas Bießmann <biessmann.devel@googlemail.com>
Copyright (C) 2020 Philippe Reynes <philippe.reynes@softathome.com>
(C) Copyright 2012 Linaro Linus Walleij <linus.walleij@linaro.org> Common ARM Integrator configuration settings
Copyright (C) 2013-2016 Synopsys, Inc. All rights reserved.
Copyright 2015 Timesys Corporation
(C) Copyright 2008-2010 Gražvydas Ignatas <notasas@gmail.com>
Copyright (C) 2011 Mistral Solutions pvt Ltd
Copyright (C) 2013 Hannes Schmelzer <oe5hpm@oevsv.at> - Bernecker & Rainer Industrieelektronik GmbH - <http://www.br-automation.com>
Copyright 2016 General Electric Company
Copyright (C) 2015 Technexion Ltd.
(C) Copyright 2005 Wolfgang Denk, DENX Software Engineering, wd@denx.de.

Copyright 2017 General Electric Company
(C) Copyright 2015 General Electric Company
Copyright 2017 General Electric Company;(C) Copyright 2011 Freescale Semiconductor, Inc. Jason Liu <r64343@freescale.com>
(C) Copyright 2007-2010 Michal Simek
Copyright 2017 General Electric Company
(C) Copyright 2003-2008 Wolfgang Denk, DENX Software Engineering, wd@denx.de;(C) Copyright 2010 egnite GmbH
(C) Copyright 2011 egnite GmbH <info@egnite.de>
(C) Copyright 2011 egnite GmbH <info@egnite.de>;(C) Copyright 2010 Ole Reinhardt <ole.reinhardt@thermotemp.de>
(C) Copyright 2013-2019 NVIDIA Corporation <www.nvidia.com>
Copyright (c) 2010-2013, NVIDIA CORPORATION. All rights reserved.
(C) Copyright 2014 Topic Embedded Products
Copyright (C) 2010-2018 Freescale Semiconductor, Inc.
(C) Copyright 2011 Freescale Semiconductor, Inc. Author: Fabio Estevam <fabio.estevam@freescale.com>
Copyright 2013-2019 Arcturus Networks, Inc. <https://www.arcturusnetworks.com/products/ucp1020/> based on include/configs/p1_p2_rdb_pc.h
(C) Copyright 2008 Magnus Lilja <lilja.magnus@gmail.com>;(C) Copyright 2004 Texas Instruments. Richard Woodruff <r-woodruff2@ti.com> Kshitij Gupta <kshitij@ti.com>
Copyright (C) 2019 Parthiban Nallathambi <parthitce@gmail.com>
Copyright (c) 2016, NVIDIA CORPORATION
Copyright (C) 2020 Cortina Access Inc.
(C) Copyright 2010 Texas Instruments Incorporated. Aneesh V <aneesh@ti.com> Steve Sakoman <steve@sakoman.com>
Copyright (c) 2014, NVIDIA CORPORATION. All rights reserved.
Copyright (C) 2019 MediaTek Inc. Author: Sam Shih <sam.shih@mediatek.com>
(C) Copyright 2013 NVIDIA Corporation <www.nvidia.com>
Copyright 2016 Freescale Semiconductor
Copyright (c) 2015, NVIDIA CORPORATION. All rights reserved.
Copyright 2011-2013 Freescale Semiconductor, Inc.
(C) Copyright 2010-2013 NVIDIA Corporation <www.nvidia.com>
Copyright (C) 2015, Savoir-faire Linux Inc.
(C) Copyright 2007-2013 Stelian Pop <stelian.pop@leadtechdesign.com> Lead Tech Design <www.leadtechdesign.com> Thomas Petazzoni, Free Electrons, <thomas.petazzoni@free-electrons.com> Mateusz Kulikowski <mateusz.kulikowski@gmail.com>
(C) Copyright 2010 Texas Instruments Incorporated. Steve Sakoman <steve@sakoman.com>
(C) Copyright 2018-2019 NVIDIA Corporation <www.nvidia.com>
(C) Copyright 2018 NVIDIA Corporation <www.nvidia.com>
(C) Copyright 2015 Inter Act B.V.:(C) Copyright 2007-2008 Stelian Pop <stelian@popies.net> Lead Tech Design <www.leadtechdesign.com>
Copyright (C) 2015 Gerald Kerma <dreagle@doukki.net> Tony Dinh <mibodhi@gmail.com> Luka Perkov <luka.perkov@sartura.hr>
(C) Copyright 2018 Michal Simek
(C) Copyright 2003-2006 Wolfgang Denk, DENX Software Engineering, wd@denx.de.
(C) Copyright 2007 Vlad Lungu <vlad.lungu@windriver.com>
Copyright (C) 2007, Guennadi Liakhovetski <lg@denx.de>;(C) Copyright 2008-2009 Freescale Semiconductor, Inc.
(C) Copyright 2018-2019 NVIDIA Corporation.
Copyright (C) 2007, Guennadi Liakhovetski <lg@denx.de>
Copyright (C) 2012 Yoshihiro Shimoda <yoshihiro.shimoda.uh@renesas.com>
Copyright (C) 2013 Samsung Electronics Sanghee Kim <sh0130.kim@samsung.com> Piotr Wilczek <p.wilczek@samsung.com>
Copyright (c) 2014-2016 Marcel Ziswiler
Copyright (C) 2007,2008 Nobuhiro Iwamatsu <iwamatsu@nigauri.org>
(c) 2007,2008 Nobuhiro Iwamatsu <iwamatsu@nigauri.org>
Copyright (C) 2008 Renesas Solutions Corp.
Copyright (C) 2009-2010 Freescale Semiconductor, Inc.

LICENCE TERMS (cont.)

Copyright (C) 2015-2017 Renesas Electronics Corporation
Copyright (C) 2017 Synopsys, Inc. All rights reserved.
Copyright (C) 2015 Timesys Corporation
Copyright (C) 2019 Renesas Electronics Corporation
(C) Copyright 2007-2008 Stelian Pop <stelian@popies.net> Lead Tech Design <www.leadtechdesign.com>;(C)
Copyright 2010 Achim Ehrlich <aehrlch@taskit.de> taskit GmbH <www.taskit.de>;(C) Copyright 2012 Markus Hubig
<mhubig@imko.de> IMKO GmbH <www.imko.de>;(C) Copyright 2014 Heiko Schocher <hs@denx.de> DENX
Software Engineering GmbH
Copyright (C) 2013 Seco S.r.l
Copyright (C) 2019 Marek Vasut <marek.vasut@renesas@gmail.com>
(C) Copyright 2011 Freescale Semiconductor, Inc.
Copyright (C) 2013 Renesas Electronics Corporation
(C) Copyright 2009 Vipin Kumar, STMicroelectronics, <vipin.kumar@st.com>
Copyright (C) 2013,2014 Renesas Electronics Corporation
Copyright 2010-2012 Freescale Semiconductor, Inc. Authors: Srikanth Srinivasan <srikanth.srinivasan@freescale.com> Timur Tabi <timur@freescale.com>
Copyright (C) 2007 Nobuhiro Iwamatsu <iwamatsu@nigauri.org>
Copyright (C) 2007-2008 Nobuhiro Iwamatsu <iwamatsu@nigauri.org>
Copyright 2017 NXP
Copyright (C) 2017 Marek Vasut <marek.vasut@renesas@gmail.com>
(C) Copyright 2003 Texas Instruments. Kshitij Gupta <kshitij@ti.com> Configuration settings for the TI OMAP
Innovator board.:(C) Copyright 2004 ARM Ltd. Philippe Robin, <philippe.robin@arm.com> Configuration for Compact
Integrator board.
Copyright (C) 2013 Renesas Solutions Corp.
Copyright 2010-2012 Freescale Semiconductor, Inc. TsiChung Liew (Tsi-Chung.Liew@freescale.com)
Copyright (C) 2014, 2015 Renesas Electronics Corporation
(C) Copyright 2015 Linaro
Copyright (C) 2012-2020 ASPEED Technology Inc. Ryan Chen <ryan_chen@aspeedtech.com>
Copyright (C) 2017 Renesas Electronics Corporation
Copyright (C) 2017 Renesas Electronics Corporation
Copyright (C) DENX GmbH
Copyright (C) 2007, Guennadi Liakhovetski <lg@denx.de>;(C) Copyright 2009 Freescale Semiconductor, Inc.
Copyright 2004, 2007, 2010-2011 Freescale Semiconductor.
Copyright (C) 2015 Renesas Electronics Europe GmbH
(C) Copyright 2018 Michal Simek <monstr@monstr.eu>
Copyright (C) 2007 Freescale Semiconductor, Inc.
Copyright (C) 2017 Andes Technology Corporation Rick Chen, Andes Technology Corporation <rick@andestech.com>
Copyright (c) 2006, 2007 Wind River Systems, Inc.
Copyright (C) 2007,2008 Nobuhiro Iwamatsu
Copyright (C) 2013 Lothar Felten <lothar.felten@gmail.com>
Copyright (C) 2007,2008 Nobuhiro Iwamatsu <iwamatsu@nigauri.org>
(C) Copyright 2006-2008 Texas Instruments. Richard Woodruff <r-woodruff2@ti.com> Syed Mohammed Khasim
<x0khasim@ti.com>;(C) Copyright 2012 Corscience GmbH & Co. KG Thomas Weber <weber@corscience.de>
Copyright (C) 2007 Nobuhiro Iwamatsu
Copyright (C) 2015 Freescale Semiconductor, Inc.
Copyright (C) 2017, Intel Corporation
Copyright (C) 2018 Marek Vasut <marek.vasut@renesas@gmail.com>
Copyright (C) 2017 Renesas Electronics
Copyright 2013-2016 Freescale Semiconductor, Inc.
(C) Copyright 2011, Stefano Babic <sbabic@denx.de>
Copyright (C) 2011 Yoshihiro Shimoda <yoshihiro.shimoda.uh@renesas.com>
Copyright 2013-2019 Toradex, Inc.
Copyright (C) 2017 Amarula Solutions
Copyright (C) 2011 Stefan Herbrechtsmeier <stefan@herbrechtsmeier.net>;(C) Copyright 2009 Marvell
Semiconductor <www.marvell.com> Written-by: Prafulla Wadaskar <prafulla@marvell.com>
Copyright (C) 2014-2015 Stefan Roese <sr@denx.de>

Copyright (C) 2011 Stefan Herbrechtsmeier <stefan@herbrechtsmeier.net>;(C) Copyright 2009 Marvell
Semiconductor <www.marvell.com> Written-by: Prafulla Wadaskar <prafulla@marvell.com> Refer doc/README.
kwbimage for more details about how-to configure and create kirkwood boot image
(C) Copyright 2011 - 2013 CompuLab, Ltd. <www.compulab.co.il>
Copyright (C) 2017 Hannes Schmeizer <oe5hpm@oevsv.at> - B&R Industrial Automation GmbH - http://www.
br-automation.com
(C) Copyright 2015 Kamil Lulko, <kamil.lulko@gmail.com>
Copyright (C) 2013, Compulab Ltd - http://compulab.co.il/
Copyright (C) 2013 Compulab Ltd - http://compulab.co.il/
Copyright (C) Freescale Semiconductor, Inc. 2006, 2010.
Copyright (C) 2015-2019 Altera Corporation <www.altera.com>
(C) Copyright 2011 Logic Product Development <www.logicpd.com> Peter Barada <peter.barada@logicpd.com>
Copyright (C) 2011 Stefano Babic, DENX Software Engineering, sbabic@denx.de.
Copyright (C) 2012 Marek Vasut <marex@denx.de> on behalf of DENX Software Engineering GmbH
Copyright (C) 2014 Compulab Ltd - http://compulab.co.il/
(C) Copyright 2012 ISEE 2007 SL, <www.iseebcn.com>
Copyright (C) 2015 Texas Instruments Incorporated - http://www.ti.com/
(C) Copyright 2011 CompuLab, Ltd. <www.compulab.co.il>
(C) Copyright 2012 - 2013 CompuLab, Ltd. <www.compulab.co.il>
Copyright 2017, 2019-2020 NXP
Copyright (C) 2019 Parthiban Nallathambi <parthitce@gmail.com>
Copyright (C) 2010-2011 Freescale Semiconductor, Inc.
(C) Copyright 2017 CompuLab, Ltd. http://www.compulab.com
Copyright (c) 2013-2016 Stefan Agner
Copyright 2017, 2020 NXP
Copyright (C) 2016 Compulab, Ltd.
(C) Copyright 2012-2013 Henrik Nordstrom <henrik@henriknordstrom.net>;(C) Copyright 2013 Luke Kenneth
Casson Leighton <lkl@lkl.net>;(C) Copyright 2013 Maxime Ripard <maxime.ripard@free-electrons.com>
Copyright (C) 2015 Compulab, Ltd.
Copyright (C) 2016, Imagination Technologies Ltd.
Copyright (C) 2018 Synopsys, Inc. All rights reserved. Author: Eugeny Paltsev <Eugeny.Paltsev@synopsys.com>
Copyright (C) 2018 Simone CIANNI <simone.cianni@bticino.it>
Copyright (C) 2019 MediaTek Inc. Author: Mingming Lee <mingming.lee@mediatek.com>
Copyright (C) 2013 Stefan Roese <sr@denx.de>
Copyright 2016 Freescale Semiconductor
(C) Copyright 2009 Marvell Semiconductor <www.marvell.com> Prafulla Wadaskar <prafulla@marvell.com>;(C)
Copyright 2009 Stefan Roese, DENX Software Engineering, sr@denx.de.:(C) Copyright 2011-2012 Holger Brunck,
Keymile GmbH Hannover, holger.brunck@keymile.com Valentin Longchamp, Keymile AG, valentin.longchamp@
keymile.com
(C) Copyright 2011 ARM Limited;(C) Copyright 2010 Linaro Matt Waddel, <matt.waddel@linaro.org>
Copyright (C) 2015 Synopsys, Inc. All rights reserved.
Copyright (C) 2004-2007 Freescale Semiconductor, Inc. Hayden Fraser (Hayden.Fraser@freescale.com)
Copyright (C) 2013-2014 Synopsys, Inc. All rights reserved.
Copyright (C) 2012 - 2013 Atmel
(C) Copyright 2010, Stefano Babic <sbabic@denx.de>
Copyright (C) 2017 Baylibre, SAS Author: Neil Armstrong <narmstrong@baylibre.com>
Copyright (c) 2017 Toradex, Inc.
Copyright (C) 2015 Atmel Corporation Josh Wu <josh.wu@atmel.com>
Copyright (c) 2013-2016, NVIDIA CORPORATION.
(C) Copyright 2003 Texas Instruments. Kshitij Gupta <kshitij@ti.com> Configuration settings for the TI OMAP
Innovator board.:(C) Copyright 2004 ARM Ltd. Philippe Robin, <philippe.robin@arm.com> Configuration for
Integrator AP board.
(C) Copyright 2016 Allied Telesis <www.alliedtelesis.co.nz>
Copyright (C) 2012 Freescale Semiconductor, Inc. Author: Fabio Estevam <fabio.estevam@freescale.com>
Copyright (C) 2014, Markus Niebel <Markus.Niebel@tq-group.com>
Copyright (C) 2019 BayLibre, SAS Author: Fabien Parent <fparent@baylibre.com>
Copyright (C) 2013, 2014 Markus Niebel <Markus.Niebel@tq-group.com>

LICENCE TERMS (cont.)

(C) Copyright 2006-2008 Texas Instruments. Richard Woodruff <r-woodruff2@ti.com> Syed Mohammed Khasim <x0khasim@ti.com>
Copyright (C) 2013 Boundary Devices
Copyright (C) 2014 - 2015 Markus Niebel <Markus.Niebel@tq-group.com>
Copyright (C) 2013, 2014 TQ Systems Author: Markus Niebel <markus.niebel@tq-group.com>
(C) Copyright 2016 Angelo Dureghello <angelo@sysam.it>
(C) Copyright 2005 Wolfgang Denk, DENX Software Engineering, wd@denx.de.
Copyright (C) 2013 Gateworks Corporation
(C) Copyright 2003-2008 Wolfgang Denk, DENX Software Engineering, wd@denx.de.:(C) Copyright 2008 Stelian Pop <stelian@popies.net> Lead Tech Design <www.leadtechdesign.com>;(C) Copyright 2013 Mateusz Kulikowski <mateusz.kulikowski@gmail.com>
(C) Copyright 2009 Samsung Electronics Minkyu Kang <mk7.kang@samsung.com> HeungJun Kim <riverful.kim@samsung.com> Inki Dae <inki.dae@samsung.com>
(C) Copyright 2009 Vipin Kumar, ST Micoelectronics, vipin.kumar@st.com.
Copyright 2016-2018 Toradex AG
(C) Copyright 2006-2008 Texas Instruments. Richard Woodruff <r-woodruff2@ti.com> Syed Mohammed Khasim <x0khasim@ti.com> Nishanth Menon <nm@ti.com>
(C) Copyright 2009 Ryan Chen, ST Micoelectronics, ryan.chen@st.com. Vipin Kumar, ST Micoelectronics, vipin.kumar@st.com.
Copyright (C) 2019 Stephan Gerhold <stephan@gerhold.net>
(C) Copyright 2014 Chen-Yu Tsai <wens@csie.org>
(C) Copyright 2017 Linaro
(C) Copyright 2000-2004 Wolfgang Denk, DENX Software Engineering, wd@denx.de.:(C) Copyright 2015 Kamil Lulko, <kamil.lulko@gmail.com>
(C) Copyright 2011, 2012, 2013 Yuri Tikhonov, Emcraft Systems, yur@emcraft.com Alexander Potashev, Emcraft Systems, aspotashev@emcraft.com Vladimir Khusainov, Emcraft Systems, vlad@emcraft.com Pavel Boldin, Emcraft Systems, paboldin@emcraft.com;(C) Copyright 2015 Kamil Lulko, <kamil.lulko@gmail.com>
Copyright (C) 2017, STMicroelectronics - All Rights Reserved Author(s): Patrice CHOTARD, <patrice.chotard@st.com> for STMicroelectronics.
Copyright (C) 2020, STMicroelectronics - All Rights Reserved
Copyright (C) 2016 Marek Vasut <marex@denx.de>
(C) Copyright 2013 Texas Instruments Incorporated. Sricharan R <r.sricharan@ti.com>
Copyright 2016-2019 NXP Semiconductors
(c) 2011 Graf-Syteco, Matthias Weisser weisserm@arcor.de>
(C) Copyright 2009-2012 Wojciech Dubowik <wojciech.dubowik@neratec.com> Luka Perkov <luka@openwrt.org>
Copyright (C) 2018, STMicroelectronics - All Rights Reserved Author(s): Patrice CHOTARD, <patrice.chotard@st.com> for STMicroelectronics.
Copyright (C) 2018 Rosy Song <rosysong@rosinson.com>
Copyright (C) 2018, STMicroelectronics - All Rights Reserved Author(s): Patrice Chotard, <patrice.chotard@st.com> for STMicroelectronics.
(C) Copyright 2016 Grinn
(C) Copyright 2017 Grinn
Copyright (C) 2018 Dennis Gilmore <dgilmore@redhat.com>
(C) Copyright 2012 Corscience GmbH & Co. KG, <www.corscience.de> Thomas Weber <weber@corscience.de> Sunil Kumar <sunilsaini05@gmail.com> Shashi Ranjan <shashiranjanmca05@gmail.com>
(C) Copyright 2000, 2001, 2002 Wolfgang Denk, DENX Software Engineering, wd@denx.de.:(C) Copyright 2012 Thomas Weber <weber@corscience.de>
Copyright (C) 2017 Logic PD, Inc.
Copyright (C) 2013 - 2017 Markus Niebel <Markus.Niebel@tq-group.com>
(C) Copyright 2008 Dirk Behme <dirk.behme@gmail.com>;(C) Copyright 2012 Corscience GmbH & Co. KG, <www.corscience.de> Thomas Weber <weber@corscience.de>
Copyright (C) 2011 Freescale Semiconductor, Inc. Jason Liu <r64343@freescale.com>
Copyright (c) 2013 Corscience GmbH & Co.KG Andreas Bießmann <andreas.biessmann@corscience.de>
(C) Copyright 2013 Corscience GmbH & Co. KG, <www.corscience.de> Andreas Bießmann <andreas.biessmann@corscience.de>
Copyright 2004, 2011 Freescale Semiconductor.
Copyright 2020 SolidRun

(C) Copyright 2004 Stefan Roese, esd gmbh germany, stefan.roese@esd-electronics.com
Copyright (C) SolidRun
Copyright (C) 2010-2011 Freescale Semiconductor, Inc. Based on Freescale i.MX6Q Sabre Lite board configuration file.
(C) Copyright 2011-2012 Pali Rohar <pali.rohar@gmail.com>;(C) Copyright 2010 Alistair Buxton <a.j.buxton@gmail.com>;(C) Copyright 2006-2008 Texas Instruments. Richard Woodruff <r-woodruff2@ti.com> Syed Mohammed Khasim <x0khasim@ti.com>
Copyright (C) 2014-2015 Freescale Semiconductor, Inc.
(C) Copyright 2018-2019 Xilinx, Inc. Michal Simek <michal.simek@xilinx.com> Siva Durga Prasad Paladugu <siva.durga.paladugu@xilinx.com>
Copyright 2004, 2011 Freescale Semiconductor.:(C) Copyright 2002,2003 Motorola,Inc. Xianghua Xiao <X.Xiao@motorola.com>
Copyright (C) 2009, STMicroelectronics - All Rights Reserved Author(s): Vipin Kumar, <vipin.kumar@st.com> for STMicroelectronics.
Copyright (C) 2011 Andes Technology Corporation Shawn Lin, Andes Technology Corporation <nobuhiro@andestech.com> Macpaul Lin, Andes Technology Corporation <macpaul@andestech.com>
Copyright (C) 2018 Robert Bosch Power Tools GmbH
(C) Copyright 2014 Angelo Dureghello <angelo@sysam.it>
(C) Copyright 2017 Angelo Dureghello <angelo@sysam.it>
(C) Copyright 2009-2014 Gerald Kerma <dreagle@doukki.net> Marvell Semiconductor <www.marvell.com> Written-by: Siddarth Gore <gores@marvell.com>
(C) Copyright 2012-2013 Henrik Nordstrom <henrik@henriknordstrom.net>
(C) Copyright 2008 Sergei Poselenov, Emcraft Systems, sposelenov@emcraft.com.
Copyright (C) 2011-2014 Pierrick Hascoet, Abilis Systems
(C) Copyright 2008 Sergei Poselenov, Emcraft Systems, sposelenov@emcraft.com.
(C) Copyright 2008 Sergei Poselenov, Emcraft Systems, sposelenov@emcraft.com.:(C) Copyright 2001-2006 Wolfgang Denk, DENX Software Engineering, wd@denx.de.
(C) Copyright: 2013 Gumstix, Inc - http://www.gumstix.com Maintainer: Ash Charles <ash@gumstix.com>
(C) Copyright 2013 - 2017 Xilinx.
(C) Copyright 2011 CompuLab, Ltd. Mike Rapoport <mike@compulab.co.il> Igor Grinberg <grinberg@compulab.co.il>;(C) Copyright 2006-2008 Texas Instruments. Richard Woodruff <r-woodruff2@ti.com> Syed Mohammed Khasim <x0khasim@ti.com>
Copyright (c) 2018 Microsemi Coprporation
(C) Copyright 2012-2012 Henrik Nordstrom <henrik@henriknordstrom.net>;(C) Copyright 2007-2011 Allwinner Technology Co., Ltd. <www.allwinnertech.com> Tom Cubie <tangliang@allwinnertech.com>
(C) Copyright 2006-2008 Texas Instruments. Richard Woodruff <r-woodruff2@ti.com> Syed Mohammed Khasim <x0khasim@ti.com>;(C) Copyright 2009 Frederik Kriewitz <frederik@kriewitz.eu>
Copyright (C) 2015 CompuLab, Ltd.
(C) Copyright 2012 Nobuhiro Iwamatsu <nobuhiro.iwamatsu.yj@renesas.com>;(C) Copyright 2012 Renesas Solutions Corp.
(C) Copyright 2015 Freescale Semiconductor, Inc.
(C) Copyright 2013 Linaro Andre Przywara, <andre.przywara@linaro.org>
Copyright (C) 2014-2016 Freescale Semiconductor, Inc.
Copyright (C) 2017 Microchip Technology Inc. Wenyou Yang <wenyou.yang@microchip.com> Ludovic Desroches <ludovic.desroches@microchip.com>
Copyright 2015 Freescale Semiconductor, Inc.
Copyright (C) 2013 Gumstix, Inc. - http://www.gumstix.com/
Copyright 2007-2009,2010-2012 Freescale Semiconductor, Inc.
Copyright (C) 2017 Armadeus Systems
Copyright 2007, 2010-2011 Freescale Semiconductor, Inc.
Copyright (C) 2011 Freescale Semiconductor, Inc.
Copyright (C) 2014 Samsung Electronics
(C) Copyright 2012 Xilinx;(C) Copyright 2017 Opal Kelly Inc.
Copyright 2007 Freescale Semiconductor, Inc.:(C) Copyright 2001-2006 Wolfgang Denk, DENX Software Engineering, wd@denx.de.
Copyright (C) 2013 Stefan Roese <sr@denx.de>
Copyright 2008-2010 Freescale Semiconductor, Inc.:(C) Copyright 2000 Wolfgang Denk, DENX Software

LICENCE TERMS (cont.)

Engineering, wd@denx.de.
Copyright 2008, 2010 Freescale Semiconductor, Inc.:(C) Copyright 2000 Wolfgang Denk, DENX Software Engineering, wd@denx.de.
(C) Copyright 2018-2019 Xilinx, Inc. Michal Simek <michal.simek@xilinx.com> Siva Durga Prasad Paladugu <svadur@xilinx.com>
Copyright 2014 Freescale Semiconductor, Inc. Author: Priyanka Jain <Priyanka.Jain@freescale.com>
Copyright 2007 Wind River Systems <www.windriver.com>
Copyright (C) 2007-2010 Freescale Semiconductor, Inc.
Copyright 2007-2014 Freescale Semiconductor, Inc.
Copyright (C) 2013 Otavio Salvador <otavio@ossystems.com.br> on behalf of O.S. Systems Software LTDA.
Copyright 2013-2016, NVIDIA CORPORATION.
Copyright 2009-2012 Freescale Semiconductor, Inc.
Copyright (C) 2007 Nobuhiro Iwamatsu <iwamatsu@nigauri.org>
Copyright 2004-2007 Freescale Semiconductor.:(C) Copyright 2001-2006 Wolfgang Denk, DENX Software Engineering, wd@denx.de.
(c) Copyright 2016, Data61 Commonwealth Scientific and Industrial Research Organisation (CSIRO);(C) Copyright 2013-2014 NVIDIA Corporation <www.nvidia.com>
Copyright (C) 2015-2019 Marek Vasut <marex@denx.de>
Copyright 2007 Freescale Semiconductor.
Copyright 2007,2009-2011 Freescale Semiconductor, Inc.:(C) Copyright 2002 Scott McNutt <smcnutt@artesymp.com>
Copyright 2008, 2010-2011 Freescale Semiconductor, Inc.:(C) Copyright 2000 Wolfgang Denk, DENX Software Engineering, wd@denx.de.
Copyright 2007-2008,2010-2011 Freescale Semiconductor, Inc.
Copyright (C) 2015 Freescale Semiconductor
Copyright (C) 2014-2016 Freescale Semiconductor, Inc. Jason Liu <r64343@freescale.com>
Copyright 2018,2020 NXP
Copyright (C) 2012-2016 Freescale Semiconductor, Inc.
Copyright (C) 2011-2016 Freescale Semiconductor, Inc. Jason Liu <r64343@freescale.com>
Copyright (C) 2010 Freescale Semiconductor, Inc.
Copyright 2018 Freescale Semiconductor
Copyright (C) 2017-2019 Renesas Electronics
Copyright (C) 2013 Samsung Electronics Hyungwon Hwang <human.hwang@samsung.com>
Copyright 2018-2019 Toradex AG
(C) Copyright 2013 Atmel Corporation. Josh Wu <josh.wu@atmel.com>
Copyright (C) 2017 Grinn - http://grinn-global.com/
(C) Copyright 2009 Stefano Babic DENX Software Engineering sbabic@denx.de.
Copyright 2006, 2010-2011 Freescale Semiconductor.
(C) Copyright 2014 Texas Instruments Incorporated. Felipe Balbi <balbi@ti.com>
Copyright 2007,2009-2011 Freescale Semiconductor, Inc.
Copyright 2007 Freescale Semiconductor, Inc.
Copyright (C) 2017 Lukasz Majewski, DENX Software Engineering, lukma@denx.de
Copyright 2008,2010 Freescale Semiconductor, Inc.:(C) Copyright 2000 Wolfgang Denk, DENX Software Engineering, wd@denx.de.
Copyright 2007-2011 Freescale Semiconductor, Inc. Authors: York Sun <yorksun@freescale.com> Timur Tabi <timur@freescale.com>
Copyright 2011-2014 Freescale Semiconductor, Inc.
Copyright (C) 2007 Freescale Semiconductor, Inc. Dave Liu <daveliu@freescale.com>
Copyright (C) 2005 Videon Central, Inc.
Copyright (C) 2010-2017 CS Systemes d'Information Christophe Leroy <christophe.leroy@c-s.fr>
Copyright 2014-2015 Freescale Semiconductor, Inc.
Copyright 2011 Freescale Semiconductor
(C) Copyright 2005-2009 BuS Elektronik GmbH & Co.KG <esw@bus-elektronik.de>
Copyright (C) 2006-2011 Texas Instruments Incorporated - http://www.ti.com/
Copyright 2004 Freescale Semiconductor.
(C) Copyright 2009-2014 Gerald Kerma <dreagle@doukki.net> Marvell Semiconductor <www.marvell.com> Written-by: Prafulla Wadaskar <prafulla@marvell.com>

Copyright 2011 Freescale Semiconductor Author: Shengzhou Liu <Shengzhou.Liu@freescale.com>
Copyright 2013 Freescale Semiconductor, Inc. Author: Shaveta Leekha <shaveta@freescale.com>
Copyright 2006 Freescale Semiconductor.
Copyright 2020 NXP
Copyright (C) Freescale Semiconductor, Inc. 2006.:(C) Copyright 2010 Heiko Schocher, DENX Software Engineering, hs@denx.de.
Copyright 2018 NXP.
Copyright 2004-2007, 2010-2011 Freescale Semiconductor.
Copyright 2008-2011 Freescale Semiconductor, Inc.:(C) Copyright 2000 Wolfgang Denk, DENX Software Engineering, wd@denx.de.
Copyright (c) 2017 Intel Corp.
Copyright 2006,2010 Freescale Semiconductor Jeff Brown Srikanth Srinivasan (srikanth.srinivasan@freescale.com)
Copyright (C) 2007-2013 Tensilica, Inc.
Copyright 2010-2011 Freescale Semiconductor Author: Timur Tabi <timur@freescale.com>
Copyright (c) 2015 Google, Inc.:(C) 2000 by Paolo Scaffardi (arsenio@tin.it) AIRVENT SAM s.p.a - RIMINI(ITALY)
Copyright 2006, 2008-2009, 2011 Freescale Semiconductor York Sun (yorksun@freescale.com) Haiying Wang (haiying.wang@freescale.com) Timur Tabi (timur@freescale.com)
Copyright 2016 Google, Inc
Copyright (C) 2012 Samsung Electronics R. Chandrasekar <rcsekar@samsung.com>
Copyright 2006-2009 Solarflare Communications Inc.
Copyright 2017,2019 NXP
Copyright (c) 2016-present, Yann Collet, Facebook, Inc. All rights reserved.
Copyright © 2002 Robert Kaiser <rkaiser@sysgo.de>
Copyright © 1999 Machine Vision Holdings, Inc.
Copyright © 2000-2010 David Woodhouse <dwmw2@infradead.org> Steven J. Hill <sjhill@realitydiluted.com>
Thomas Gleixner <tglx@linutronix.de>
Copyright (C) 2000-2010 Steven J. Hill <sjhill@realitydiluted.com> David Woodhouse <dwmw2@infradead.org>
Thomas Gleixner <tglx@linutronix.de>
(C) Copyright 2004-2008 Texas Instruments, <www.ti.com> Rohit Choraria <rohitkc@ti.com>;(C) Copyright 2013 Andreas Bießmann <andreas@biessmann.org>
Copyright (C) 2014 Freescale Semiconductor, Inc. Synced from Linux v4.19
Copyright (C) 2007 MontaVista Software, Inc. Anton Vorontsov <avorontsov@ru.mvista.com>
Copyright 2017 - Free Electrons
(C) Copyright 2010-2011 Texas Instruments, <www.ti.com> Mansoor Ahamed <mansoor.ahamed@ti.com>
Copyright © 2000-2010 David Woodhouse <dwmw2@infradead.org> et al.
Copyright (C) 2013-2016 Freescale Semiconductor, Inc.
Copyright (c) International Business Machines Corp., 2006
Copyright (c) 2006 Thomas Gleixner <tglx@linutronix.de>
(C) 2000 Nicolas Pitre <nico@fluxnic.net>
Copyright © 2005 Samsung Electronics Kyungmin Park <kyungmin.park@samsung.com>
Copyright (C) 2005-2009 Samsung Electronics Minkyu Kang <mk7.kang@samsung.com> Kyungmin Park <kyungmin.park@samsung.com>
Copyright 2008-2012 Freescale Semiconductor, Inc.:(C) Copyright 2000 Wolfgang Denk, DENX Software Engineering, wd@denx.de.
Copyright (c) 2016-2017 Micron Technology, Inc.
Copyright © 2000 Red Hat UK Limited
Copyright © 2011 Ivan Djelic <ivan.djelic@parrot.com>
Copyright Torsten Duwe <duwe@informatik.uni-erlangen.de> 1993
Copyright (c) 1999-2002 Vojtech Pavlik
Copyright (C) 2006-2008 David Brownell;(c) presumably a wireless_ep wrapping a usb_ep, and reporting wireless-specific parameters like maxburst and maxsequence; d) configurations that are specific to wireless links; e) function drivers that understand wireless configs and will support wireless for (additional) funct
(C) Copyright 2002-2004 by David Brownell All Rights Reserved.
(C) Copyright 2013 Texas Instruments Inc, <www.ti.com>
Copyright (c) 2012 Samsung Electronics Co. Ltd
Copyright (C) 2008 Marvell Semiconductor
(C) 1999 Andrea Arcangeli <andrea@suse.de>;(C) 2002 David Woodhouse <dwmw2@infradead.org>;(C) 2012

LICENCE TERMS (cont.)

Michel Lespinasse <walken@google.com>
Copyright (c) 2005-2007 Analog Devices Inc.
Copyright (c) 2012-2014 The Linux Foundation. All rights reserved.
Copyright (c) 2015, Linaro Limited
Copyright (C) 1996, 1999, 2001 David S. Miller (davem@redhat.com)
Copyright (C) 1996-2005 Markus F.X.J. Oberhumer <markus@oberhumer.com>
Copyright (C) 2014 Felix Fietkau <nbd@nbd.name>
Copyright © 2008 Keith Packard
Copyright (C) 2012-2016, Yann Collet.
Copyright 1994-2001 Stephen Rothwell (sfr@canb.auug.org.au)
Copyright (C) 2006 Red Hat, Inc. All Rights Reserved. Written by David Howells (dhowells@redhat.com)
Copyright © 2011 Parrot S.A.
(C) 1999 Andrea Arcangeli <andrea@suse.de>
Copyright (C) 1992, 1994 by Theodore Ts'o.
Copyright (c) 2006-2009, 2011 Freescale Semiconductor, Inc. Author: Shlomi Gridish <gridish@freescale.com>
(C) Copyright 2001 Linus Torvalds
Copyright (C) 1998 David S. Miller (davem@redhat.com)
Copyright (C) 2002, 2003, 2004 Dell Inc. by Matt Domsch <Matt_Domsch@dell.com>
Copyright 2006, 2007, 2010-2011 Freescale Semiconductor.
Copyright 2008,2010-2011 Freescale Semiconductor, Inc.:(C) Copyright 2000 Wolfgang Denk, DENX Software Engineering, wd@denx.de.
Copyright (C) 2018 Texas Instruments Incorporated - <http://www.ti.com> Author: Peter Ujfalusi <peter.ujfalusi@ti.com>
Copyright 2008,2011 Freescale Semiconductor, Inc.
Copyright 2009-2010 Freescale Semiconductor.:(C) Copyright 2002 Scott McNutt <smcnutt@artesyncp.com>
Copyright (C) 2018 Texas Instruments Incorporated - <http://www.ti.com/> Nishanth Menon Lokesh Vutla <lokeshvutla@ti.com>
Copyright 2004-2009 Freescale Semiconductor.:(C) Copyright 2001-2006 Wolfgang Denk, DENX Software Engineering, wd@denx.de.
Copyright (C) 2014 Linaro Ltd. Author: Anup Patel <anup.patel@linaro.org>
Copyright 2009-2010 Freescale Semiconductor, Inc.:(C) Copyright 2000 Wolfgang Denk, DENX Software Engineering, wd@denx.de.
Copyright (C) 2009 Freescale Semiconductor, Inc.
Copyright 2009-2011 Freescale Semiconductor, Inc.:(C) Copyright 2000 Wolfgang Denk, DENX Software Engineering, wd@denx.de.
Copyright 2009 Freescale Semiconductor, Inc.
Copyright (C) 2014-2015 Samsung Electronics Przemyslaw Marczak <p.marczak@samsung.com>
Copyright 2008-2013 Freescale Semiconductor, Inc.:(C) Copyright 2000 Wolfgang Denk, DENX Software Engineering, wd@denx.de.
Copyright 2009-2013 Freescale Semiconductor, Inc.:(C) => SFP Module, SGMII@3.125bps SD1(D) => SFP Module, SGMII@1.25bps SD1(E:H) => SLOT1 PCIe4 x4;(C) => SLOT6 SGMII SD1(D) => SLOT5 SGMII SD1(E) => SLOT1 PCIe4 x1 SD1(F:H) => SLOT3 SGMII
Copyright (C) 2019 Vasily Khoruzhick <anarsoul@gmail.com>
Copyright 2007-2013 Freescale Semiconductor, Inc.
(C) Copyright 2015 Linaro Peter Griffin <peter.griffin@linaro.org>
Copyright 2007,2009-2010 Freescale Semiconductor, Inc.
Copyright 2007,2009-2014 Freescale Semiconductor, Inc.
Copyright (C) Freescale Semiconductor, Inc. 2006-2007
(C) Copyright 2003 Gerry Hamel, geh@ti.com, Texas Instruments
Copyright (C) 2017 Toradex Author: Stefan Agner <stefan.agner@toradex.com>
(C) Copyright 2019 Xilinx, Inc, Siva Durga Prasad Paladugu <siva.durga.paladugu@xilinx.com>
(C) Copyright 2014 Google, Inc Writte by Simon Glass <sjg@chromium.org>
(C) Copyright 2012 Stefan Roese, DENX Software Engineering, sr@denx.de.
Copyright 2010-2011 Freescale Semiconductor, Inc. Author: Dipen Dudhat <dipen.dudhat@freescale.com>
(C) Copyright 2008 Niklaus Giger, niklaus.giger@member.fsf.org
Copyright (c) 1995, 1996, 2001, 2002 Erik Theisen. All rights reserved.
Copyright 2009-2012 Freescale Semiconductor, Inc.

(C) Copyright 2012 Samsung Electronics Donghwa Lee <dh09.lee@samsung.com>
(C) Copyright 2017, 2018 Mario Six, Guntermann & Drunck GmbH, mario.six@gdsys.cc
Copyright 2012 Freescale Semiconductor, Inc. Author: Sandeep Kumar Singh <sandeep@freescale.com>
Copyright (C) 2007 The Android Open Source Project
(C) Copyright 2012 Pali Rohár <pali.rohar@gmail.com>
Copyright (C) 2006-2008 Nokia Corporation;(C) Copyright 2008-2009 Stefan Roese, DENX Software Engineering, sr@denx.de.
Copyright 2014-15 Freescale Semiconductor
(C) Copyright 2009 Stefano Babic, DENX Software Engineering, sbabic@denx.de.
(C) Copyright 2012 Freescale Semiconductor, Inc.
Copyright 2011 Freescale Semiconductor, Inc.:(C) Copyright 2001-2006 Wolfgang Denk, DENX Software Engineering, wd@denx.de.
Copyright 2011 Freescale Semiconductor Author: Mingkai Hu <Mingkai.hu@freescale.com>
Copyright 2011 Freescale Semiconductor, Inc. Author: Mingkai Hu <Mingkai.hu@freescale.com>
Copyright 2013, 2015 Freescale Semiconductor, Inc.
Copyright (C) 1995-1999, 2000 Free Software Foundation, Inc. This file is part of the GNU C Library.
Copyright 2011,2012 Freescale Semiconductor, Inc.
Copyright (C) 2012 Freescale Semiconductor, Inc. Fabio Estevam <fabio.estevam@freescale.com>
(C) Copyright 2009 Freescale Semiconductor, Inc.
Copyright 2009 Stefano Babic DENX Software Engineering sbabic@denx.de.
Copyright 2013 Freescale Semiconductor Author: Mingkai Hu <Mingkai.Hu@freescale.com> Po Liu <Po.Liu@freescale.com>
Copyright 2019 Ramon Fried <rfried.dev@gmail.com>
Copyright 2013 Freescale Semiconductor Author: Mingkai Hu <Mingkai.hu@freescale.com> Po Liu <Po.Liu@freescale.com>
Copyright Gavin Shan, IBM Corporation 2016.
Copyright (C) 2019, IBM Corporation.
Copyright 1994, 1995, 2000 Neil Russell.
Copyright 2015 Freescale Semiconductor
(C) Copyright 2014 Stephen Warren swarren@wwwdotorg.org
Copyright 2017 Google, Inc Written by Simon Glass <sjg@chromium.org>
Copyright (c) 2013, Henrik Nordstrom <henrik@henriknordstrom.net>
Copyright (c) 2020, Linaro Limited
Copyright (C) 2013 Google Inc.
Copyright 2019 Heinrich Schuchardt <xypron.glpk@gmx.de> endif
Copyright (C) 2017 Texas Instruments Author: Kishon Vijay Abraham I <kishon@ti.com>;(C) Copyright 2019 Ramon Fried <ramon.fried@gmail.com>
(C) Copyright 2012 Marvell Semiconductor <www.marvell.com> Written-by: Maen Suleiman, Gerald Kerma
Copyright (C) 2004-2007, 2010 Freescale Semiconductor, Inc.
Copyright (c) 2017 Heinrich Schuchardt
Copyright (c) 2018 Heinrich Schuchardt
Copyright (C) 2005 Silicon Graphics, Inc. Christoph Lameter
Copyright (c) 2016 Imagination Technologies Ltd.
Copyright (c) 2012 The Chromium OS Authors.:(C) Copyright 2002-2010 Wolfgang Denk, DENX Software Engineering, wd@denx.de.
Copyright (c) 2011 The Chromium OS Authors.:(C) Copyright 2000 - 2002 Wolfgang Denk, DENX Software Engineering, wd@denx.de.
(C) Copyright 2008 Benjamin Warren, biggerbadderben@gmail.com
Copyright (C) 2017 Texas Instruments Written by Franklin Cooper Jr. <fcooper@ti.com>
Copyright (C) 2016 Daniel Schwierzeck <daniel.schwierzeck@gmail.com>
(C) Copyright 2008 Magnus Lilja <lilja.magnus@gmail.com>;(C) Copyright 2000-2006 Wolfgang Denk, DENX Software Engineering, wd@denx.de.
(C) Copyright 2009 Magnus Lilja <lilja.magnus@gmail.com>
(C) Copyright 2009 Magnus Lilja <lilja.magnus@gmail.com>;(c) 2007 Pengutronix, Sascha Hauer <s.hauer@pengutronix.de>
Copyright 2004 Freescale Semiconductor.:(C) Copyright 2001-2006 Wolfgang Denk, DENX Software Engineering, wd@denx.de.

LICENCE TERMS (cont.)

Copyright 2008, 2011 Freescale Semiconductor, Inc.:(C) Copyright 2000 Wolfgang Denk, DENX Software Engineering, wd@denx.de.
Copyright 2004, 2007, 2009-2011 Freescale Semiconductor, Inc.:(C) Copyright 2002 Scott McNutt <smcnutt@artesyinc.com>
(C) Copyright 2011 Freescale Semiconductor, Inc. Jason Liu <r64343@freescale.com>
Copyright 2015 Microchip Technology, Inc. Purna Chandra Mandal, <purna.mandal@microchip.com>
Copyright 2004, 2011 Freescale Semiconductor.:(C) Copyright 2002 Scott McNutt <smcnutt@artesyinc.com>
Copyright 2016 NXP Semiconductor. Author: Wang Dongsheng <dongsheng.wang@freescale.com>
Copyright (C) 2015 Purna Chandra Mandal, purna.mandal@microchip.com
Copyright (C) 2013-2016 Freescale Semiconductor, Inc.
"Copyright (c) 2003 Wolfgang Denk <wd@denx.de>"
(C) Copyright 2003 Wolfgang Denk, DENX Software Engineering, <wd@denx.de>
Copyright (C) 2020 Stefan Roese <sr@denx.de>
Copyright (C) 1996 David S. Miller
Copyright (C) 1994 - 2000, 2001, 2003 Ralf Baechle
Copyright (C) 1994 - 1999, 2000, 01, 06 Ralf Baechle
(C) Copyright 2003 Wolfgang Denk Engineering, <wd@denx.de>
Copyright (C) 2015-2016 Wills Wang <wills.wang@live.com> Based on Atheros LSDK/QSDK and u-boot_mod project
Copyright (C) 2015-2016 Wills Wang <wills.wang@live.com> Based on Atheros LSDK/QSDK
Copyright (C) 2015-2016 Wills Wang <wills.wang@live.com>
Copyright (C) 2007, Guennadi Liakhovetski <lg@denx.de>;(C) Copyright 2008-2010 Freescale Semiconductor, Inc.
(c) 2007 Pengutronix, Sascha Hauer <s.hauer@pengutronix.de>;(C) Copyright 2008-2009 Freescale Semiconductor, Inc.
Copyright (C) 2019 Rosy Song <rosysong@rosinson.com>
Copyright (C) 2018-2019 Rosy Song <rosysong@rosinson.com>
Copyright 2008 Freescale Semiconductor.:(C) Copyright 2001-2006 Wolfgang Denk, DENX Software Engineering, wd@denx.de.
Copyright (C) 2010 Freescale Semiconductor, Inc.
(C) Copyright 2006 Wolfgang Denk, DENX Software Engineering, wd@denx.de.:(C) Copyright 2010 Ilya Yanok, Emcraft Systems, yanok@emcraft.com
Copyright 2010-2011, 2013 Freescale Semiconductor, Inc.
(C) Copyright 1996, 97, 99, 2002, 03 Ralf Baechle;(C) Copyright 1999 Silicon Graphics, Inc.
Copyright (C) 1994 - 1999 by Ralf Baechle
Copyright (C) 1994, 95, 96, 97, 98, 99, 2000 by Ralf Baechle
Copyright (C) 2016 Nelson Integration, LLC Author: Eric Nelson <eric@nelint.com>
Copyright (C) 1994, 1995, 1996, 1997, 2000, 2001 by Ralf Baechle
Copyright (c) 1994 - 1997, 1999, 2000 Ralf Baechle (ralf@gnu.org)
Copyright (C) 1994, 1995 Waldorf GmbH
Copyright (C) 1994 - 2002 by Ralf Baechle
Copyright (C) 2007 Ralf Baechle (ralf@linux-mips.org)
Copyright (C) 2007, Guennadi Liakhovetski <lg@denx.de>;(C) Copyright 2010 Freescale Semiconductor, Inc.
Copyright (C) 1996, 99, 2003 by Ralf Baechle
(C) Copyright 2010 Freescale Semiconductor, Inc.
Copyright (C) 1995, 1996, 1997, 1999, 2001 by Ralf Baechle
Copyright (C) 1994 - 1999, 2000, 03, 04 Ralf Baechle
Copyright (C) 2003, 2004 Ralf Baechle
Copyright (C) 2003 Ralf Baechle
Copyright (C) 1996, 99 Ralf Baechle
Copyright (c) 1994, 95, 96, 97, 98, 2000, 01 Ralf Baechle
Copyright (C) 2003, 2004 Ralf Baechle
Copyright (C) 1994, 1995, 1996, 1999 by Ralf Baechle
Copyright (C) 1985 MIPS Computer Systems, Inc.
Copyright (C) 1996, 1997, 1998, 2000 by Ralf Baechle
Copyright (C) 1997, 1999, 2001, 06 by Ralf Baechle
Copyright (C) 1994, 1995, 1996 by Ralf Baechle
Copyright (C) 1994 Waldorf GMBH

(C) Copyright 2013 O.S. Systems Software LTDA.
Copyright (C) 1995, 1999 by Ralf Baechle
Copyright (C) 1996, 1999, 2001 Ralf Baechle
(C) Copyright 2002-2010 Wolfgang Denk, DENX Software Engineering, wd@denx.de.
Copyright (c) 2010 Xiangfu Liu <xiangfu@sharism.cc>
Copyright (c) 2013 Imagination Technologies Author: Paul Burton <paul.burton@imgtec.com>
Copyright (c) 2015 Imagination Technologies Author: Matt Redfearn <matt.redfearn.com>
(c) 2018 Stefan Roese <sr@denx.de>
Copyright (C) 2010 Albert ARIBAUD <albert.u.boot@aribaud.net>
Copyright (C) 2013-2016 Freescale Semiconductor, Inc. Jason Liu <r64343@freescale.com>
Copyright 2016-2019 NXP Semiconductors
Copyright (C) 2018 Xilinx, Inc. (Michal Simek)
(C) Copyright 2000-2003 Wolfgang Denk, DENX Software Engineering, wd@denx.de.:(C) Copyright 2008 Guennadi Liakhovetski, DENX Software Engineering, <lg@denx.de>
Copyright (C) 2014 Samsung Electronics Minkyu Kang <mk7.kang@samsung.com> Robert Baldyga <r.baldyga@samsung.com>
Copyright (C) 2009 Samsung Electronics Minkyu Kang <mk7.kang@samsung.com> Heungjun Kim <riverful.kim@samsung.com>
Copyright (c) 2009 Samsung Electronics. Minkyu Kang <mk7.kang@samsung.com>
Copyright 2013 Freescale Semiconductor
(C) Copyright 2009 Samsung Electronics Minkyu Kang <mk7.kang@samsung.com> Heungjun Kim <riverful.kim@samsung.com>
(C) Copyright 2009 SAMSUNG Electronics Minkyu Kang <mk7.kang@samsung.com>
(C) Copyright 2010 Samsung Electronics Naveen Krishna Ch <ch.naveen@samsung.com>
Copyright (C) 2011 Samsung Electronics Heungjun Kim <riverful.kim@samsung.com> Minkyu Kang <mk7.kang@samsung.com>
Copyright (C) 2009 Samsung Electronics Minkyu Kang <mk7.kang@samsung.com>
Copyright (c) 2009 Samsung Electronics Kyungmin Park <kyungmin.park@samsung.com> Minkyu Kang <mk7.kang@samsung.com>
Copyright (C) 2012 Samsung Electronics Abhilash Kesavan <a.kesavan@samsung.com>
(C) Copyright 2013-2015, Freescale Semiconductor, Inc.
(C) Copyright 2015, Freescale Semiconductor, Inc.
(C) Copyright 2012,2015 Stephen Warren
Copyright 2009-2011 Freescale Semiconductor, Inc. Author: Srikanth Srinivasan <srikanth.srinivasan@freescale.com>
(C) Copyright 2019 Matthias Brugger
Copyright 2009-2010 Freescale Semiconductor, Inc.
Copyright 2007-2009 Freescale Semiconductor, Inc.:(C) Copyright 2001-2006 Wolfgang Denk, DENX Software Engineering, wd@denx.de.
Copyright 2012 Freescale Semiconductor, Inc. Refer doc/README.pblimage for more details about how-to configure and create PBL boot image
Copyright (C) 2012 Vikram Narayanan vikram186@gmail.com>;(C) Copyright 2012,2015 Stephen Warren
Copyright (C) 2019 Socionext Inc.
Copyright (C) 2011-2014 Panasonic Corporation
Copyright 2009-2011 Freescale Semiconductor, Inc. Author: Timur Tabi <timur@freescale.com>
Copyright (C) 2015 Socionext Inc. Author: Masahiro Yamada <yamada.masahiro@socionext.com>
Copyright (C) 2012-2015 Masahiro Yamada <yamada.masahiro@socionext.com>
(C) 1998,1999 Kenneth Albanowski, D. Jeff Dionne Built 1 zonelists. Total pages: 8128 Kernel command line: rootfstype=romfs PID hash table entries: 128 (order: 7, 512 bytes) Dentry cache hash table entries: 4096 (order: 2, 16384 bytes) Inode-cache hash table entries: 2048 (order: 1, 8192 bytes) Mem:© 2001-2006 Red Hat, Inc. io scheduler noop registered io scheduler cfq registered (default) ColdFire internal UART serial driver version 1.00 ttyS0 at 0xfc060000 (irq = 90) is a builtin ColdFire UART ttyS1 at 0xfc064000 (irq = 91) is a builtin ColdFire UART ttyS2 at 0xfc068000 (irq = 92) is a built
Copyright (C) 2012-2014 Panasonic Corporation
Copyright (C) 2014-2015 Masahiro Yamada <yamada.masahiro@socionext.com>
Copyright (C) 2013-2014 Panasonic Corporation
Copyright (C) 2016-2018 Socionext Inc. Author: Masahiro Yamada <yamada.masahiro@socionext.com>

LICENCE TERMS (cont.)

Copyright (C) 2011-2015 Panasonic Corporation
Copyright (C) 2020 Socionext Inc. Author: Masahiro Yamada <yamada.masahiro@socionext.com>
Copyright (C) 2011-2014 Panasonic Corporation
Copyright (C) 2016 Socionext Inc.
Copyright (C) 2014 Panasonic Corporation
Copyright (C) 2007,2010 Freescale Semiconductor, Inc. Dave Liu <daveliu@freescale.com>
Copyright (C) 2015-2017 Socionext Inc. Author: Masahiro Yamada <yamada.masahiro@socionext.com>
Copyright (C) 2015-2017 Socionext Inc.
Copyright (C) 2016-2017 Socionext Inc.
Copyright (C) 2011-2016 Freescale Semiconductor, Inc.
(C) Copyright 2011 Freescale Semiconductor, Inc.
Copyright (C) 2017 Socionext Inc.
Copyright (C) 2011-2015 Copyright (C) 2011-2015 Panasonic Corporation
Copyright (C) 2019 Socionext Inc. Author: Masahiro Yamada <yamada.masahiro@socionext.com>
Copyright 2008-2014 Freescale Semiconductor, Inc.:(C) Copyright 2000 Wolfgang Denk, DENX Software Engineering, wd@denx.de.
Copyright 2009-2013 Freescale Semiconductor, Inc.
(C) 2001-2006 Red Hat, Inc. io scheduler noop registered io scheduler anticipatory registered io scheduler deadline registered io scheduler cfq registered (default) ColdFire internal UART serial driver version 1.00 ttyS0 at 0xfc060000 (irq = 90) is a builtin ColdFire UART ttyS1 at 0xfc064000 (irq =
Copyright 2016 NXP Semiconductor. Author: Feng Li <feng.li_2@nxp.com>
(C) Copyright 2000-2006 Wolfgang Denk, DENX Software Engineering, wd@denx.de. obj-y += soc.o
(C) Copyright 2015-2016 Texas Instruments Incorporated, <www.ti.com>
Copyright 2012 Calxeda, Inc.
(C) Copyright 2003-2008 Wolfgang Denk, DENX Software Engineering, wd@denx.de.:(C) Copyright 2011 Bluewater Systems Ryan Mallon <ryan@bluewatersys.com>
Copyright (C) 2012-2019 Texas Instruments Incorporated - http://www.ti.com/
Copyright 2015 Texas Instruments Incorporated, <www.ti.com>
(c) 2004 by Andre Renaud from logo_gurnard_small.ppm*/ ifndef __BMP_LOGO_H__ define __BMP_LOGO_H__
define BMP_LOGO_WIDTH 187 define BMP_LOGO_HEIGHT 139 define BMP_LOGO_COLORS 255 define
BMP_LOGO_OFFSET 50
Copyright (C) 2018 BTicino
Copyright (C) 2015, Bachmann electronic GmbH
(C) Copyright 2005-2009 BuS Elektronik GmbH & Co.KG <esw@bus-elektronik.de>;(C) Copyright 2000-2003
Wolfgang Denk, DENX Software Engineering, wd@denx.de.
Copyright (C) 2018 Dennis Gilmore <dgilmore@redhat.com> based on board/solidrun/clearfog/clearfog.c
Copyright (C) 2010-2017 CS Systemes d'Information Florent Trinh Thai <florent.trinh-thai@c-s.fr> Christophe Leroy
<christophe.leroy@c-s.fr>
Copyright (C) 2010-2017 CS Systemes d'Information Christophe Leroy <christophe.leroy@c-s.fr>;(C) Copyright
2001-2003 Wolfgang Denk, DENX Software Engineering, wd@denx.de.
Copyright (C) 2012 Boundary Devices Inc.
Copyright (C) 2016 Andes Technology Corporation Rick Chen, Andes Technology Corporation <rick@andestech.
com>
Copyright (C) 2018 DENX Software Engineering Lukasz Majewski, DENX Software Engineering, lukma@denx.de
Copyright (C) 2014 Gateworks Corporation
Copyright 2020 NXP.
Copyright (C) 2017 Andes Technology Corporation. Rick Chen, Andes Technology Corporation <rick@andestech.
com>
(C) Copyright 2006 Wolfgang Denk, DENX Software Engineering, wd@denx.de.:(C) Copyright 2013 Heiko Schocher,
DENX Software Engineering, <hs@denx.de>
(C) Copyright 2004-2008 Texas Instruments, <www.ti.com>
Copyright 2017-2020 NXP
(C) Copyright 2008 Steve Sakoman <steve@sakoman.com>
Copyright 2019 NXP.
(C) Copyright 2000-2006 Wolfgang Denk, DENX Software Engineering, wd@denx.de.:(C) Copyright 2011 Freescale
Semiconductor, Inc.
(C) Copyright 2007 Sascha Hauer, Pengutronix

Copyright 2018 NXP SPDX-License-Identifier: GPL-2.0+
Copyright 2008-2015 Freescale Semiconductor, Inc.
Copyright (C) 2013 Gateworks Corporation
(C) Copyright 2000-2006 Wolfgang Denk, DENX Software Engineering, wd@denx.de.
Copyright (C) 2010-2011 Freescale Semiconductor, Inc.
(C) Copyright 2014 Gabriel Huau <contact@huau-gabriel.fr>;(C) Copyright 2009 Freescale Semiconductor, Inc.
Copyright (C) 2011 by Vladimir Zapolskiy <vz@mleia.com>
(C) Copyright 2015 Vladimir Zapolskiy <vz@mleia.com>
Copyright (C) 2017 NXP
(C) Copyright 2000, 2001, 2002 Wolfgang Denk, DENX Software Engineering, wd@denx.de.:(C) Copyright 2009
Frederik Kriewitz <frederik@kriewitz.eu>
(C) Copyright 2008 Dirk Behme <dirk.behme@gmail.com>;(C) Copyright 2009 Frederik Kriewitz <frederik@kriewitz.
eu>
(C) Copyright 2019 Author(s): Giulio Benetti <giulio.benetti@benettiengineering.com>
(C) Copyright 2004-2008 Texas Instruments, <www.ti.com>;(C) Copyright 2009 Frederik Kriewitz <frederik@kriewitz.
eu>
(C) Copyright 2009-2016 Freescale Semiconductor, Inc.
(C) Copyright 2015 Technexion Ltd.:(C) Copyright 2015 Freescale Semiconductor, Inc.
(C) Copyright 2007 Sascha Hauer, Pengutronix;(C) Copyright 2009 Freescale Semiconductor, Inc.
(C) Copyright 2000-2006 Wolfgang Denk, DENX Software Engineering, wd@denx.de.:(C) Copyright 2009 Freescale
Semiconductor, Inc.
(C) Copyright TechNexion 2010 Edward Lin <linuxfae@technexion.com>
Copyright (C) 2017 Beckhoff Automation GmbH & Co. KG Patrick Bruenn <p.bruenn@beckhoff.com>
Copyright (C) 2018 Technexion Ltd.
(C) Copyright 2017 NXP Semiconductors
Copyright 2018 Linaro
Copyright (C) 2008 by Sascha Hauer <kernel@pengutronix.de>
Copyright (C) 2010-2015 Freescale Semiconductor, Inc.
Copyright (C) 2012 Boundary Devices Inc.
(C) Copyright 2000-2012 Wolfgang Denk, DENX Software Engineering, wd@denx.de.
Copyright 2015 Toradex, Inc.
Copyright 2013 Stefan Roese <sr@denx.de>
(C) Copyright 2011 Logic Product Development <www.logicpd.com>
Copyright (C) 2012-2020 ASPEED Technology Inc.
(C) Copyright 2008 Texas Instruments Nishanth Menon <nm@ti.com>
(C) Copyright 2006-2008 Texas Instruments, <www.ti.com>
Copyright (C) 2011 Heiko Schocher, DENX Software Engineering, hs@denx.de.
(C) Copyright 2003 Texas Instruments <www.ti.com>
Copyright (C) 2011 OMICRON electronics GmbH
Copyright (C) 2012 Dmitry Bondar <bond@inmys.ru>
Copyright (C) 2009 Nick Thompson, GE Fanuc Ltd, <nick.thompson@gefanuc.com>
"Copyright (C) 2012, Texas Instruments, Incorporated - http://www.ti.com/ ifndef CONFIG_SPL_BUILD ALL-
\$(CONFIG_SPL_FRAMEWORK) += u-boot.ais endif"
Copyright (C) 2004 Texas Instruments.
Copyright (C) 2011 DENX Software Engineering GmbH Heiko Schocher <hs@denx.de>
Copyright (C) 2013 Imagination Technologies
(C) Copyright 2004-2014 Texas Instruments, <www.ti.com>
Copyright (C) 2009 Texas Instruments Incorporated
Copyright (C) 2016, Imagination Technologies Ltd. Zubair Lutfullah Kakakhel <Zubair.Kakakhel@imgtec.com>
Copyright (C) 2008 Lyrtech <www.lyrtech.com>
Copyright (C) 2015-2019 Stefan Roese <sr@denx.de>
Copyright 2009: Marvell Technology Group Ltd.
(C) Copyright 2011 Marvell Semiconductor <www.marvell.com> Written-by: Lei Wen <leiwen@marvell.com>
"Copyright 2017 Linaro Jorge Ramirez-Ortiz <jorge.ramirez-ortiz@linaro.org> obj-y := poplar.o"
(C) Copyright 2003 Texas Instruments <www.ti.com>;(C) Copyright 2002 Sysgo Real-Time Solutions, GmbH <www.
elinos.com> Marius Groeger <mgroeger@sysgo.de>;(C) Copyright 2002 Sysgo Real-Time Solutions, GmbH <www.
elinos.com> Alex Zuepke <azu@sysgo.de>;(C) Copyright 2002-2004 Gary Jennejohn, DENX Software Engineering,

LICENCE TERMS (cont.)

<garyj@denx.de>;(C) Copyright 2004 Philippe Robin, ARM Ltd. <philippe.robin@arm.com>
Copyright (c) 2003 Texas Instruments
(C) Copyright 2017 Linaro Jorge Ramirez-Ortiz <jorge.ramirez-ortiz@linaro.org>
Copyright 2015 - 2016 Xilinx, Inc.
Copyright 2018 Xilinx, Inc.
Copyright 2016 - 2017 Xilinx, Inc.
Copyright 2015 Xilinx, Inc.
Copyright (C) 2014, Barco (www.barco.com)
Copyright (C) 2016-2017 Intel Corporation
Copyright (C) 2012-2017 Altera Corporation <www.altera.com>
copyrighted by Wolfgang Denk and many others who contributed code (see the actual source code and the git commit messages for details). You can redistribute U-Boot and/or modify it under the terms of version 2 of the GNU General Public License as published by the Free Software Foundation. Most of
Copyright (C) 1998, 1999, 2000, 2001, 2002 Red Hat, Inc.
Copyright (C) 2013-2017 Altera Corporation <www.altera.com>
Copyright (C) 1996 X Consortium
Copyright (C) 1991 Free Software Foundation, Inc. 51 Franklin Street, Fifth Floor, Boston, MA 02110-1301 USA
Everyone is permitted to copy and distribute verbatim copies of this license document, but changing it is not allowed.
Copyright (c) 2004-2010 by Internet Systems Consortium, Inc. ("ISC")
Copyright (C) 2012-2019 Altera Corporation <www.altera.com>
Copyright (C) 1991, 1992 Linus Torvalds
Copyright (c) 2004 Cisco Systems, Inc.
Copyright (c) 2013, Google Inc.:(C) Copyright 2000-2007 Wolfgang Denk, DENX Software Engineering, wd@denx.de.
(C) Copyright 2013 Samsung Electronics Przemyslaw Marczak <p.marczak@samsung.com>
Copyright 1994 - 2000 Neil Russell.
(C) Copyright 2000-2002 Wolfgang Denk, DENX Software Engineering, wd@denx.de.
Copyright 2011 Calxeda, Inc.
Copyright (C) 2017-2019 Intel Corporation <www.intel.com> All rights reserved.
Copyright (c) 2009, Google Inc. All rights reserved.
Copyright (C) 2015-2017 Intel Corporation <www.intel.com>
Copyright (C) 2001-2003 Christophe Devine
Copyright (C) 2003 Bernardo Innocenti <bernie@develer.com>
Copyright (C) 2014-2017 Altera Corporation <www.altera.com>
Copyright (C) 2018 Texas Instruments Incorporated - http://www.ti.com/ Andrew F. Davis <afd@ti.com>
Copyright (C) 2019 Texas Instruments Incorporated - http://www.ti.com/ Andreas Dannenberg <dannenberg@ti.com>
Copyright 2016, The Android Open Source Project
Copyright (C) 2018 Texas Instruments, Incorporated - http://www.ti.com/ Andrew F. Davis <afd@ti.com>
Copyright (C) 2018 Texas Instruments Incorporated - http://www.ti.com/ Lokesh Vutla <lokeshvutla@ti.com> This file is derived from arch/arm/mach-zynqmp/cpu.c)
(C) Copyright (C) 2018-2019 Texas Instruments Incorporated - http://www.ti.com/
Copyright (C) 2011-2015, Yann Collet.
Copyright (C) 1995-2005 Jean-loup Gailly.
Copyright (C) 1995-2010 Jean-loup Gailly
Copyright (C) 1995-2003 Mark Adler
(C) Copyright (C) 2018 Texas Instruments Incorporated - http://www.ti.com/
Copyright (C) 1995-2010 Jean-loup Gailly detect_data_type() function provided freely by Cosmin Truta, 2006
Copyright (C) 1995-2005 Mark Adler
Copyright (C) 1995-2004 Mark Adler
Copyright (C) 1995-2010 Jean-loup Gailly and Mark Adler
Copyright (C) 1995-2005 Mark Adler
(C) Copyright 2016 Mateusz Kulikowski <mateusz.kulikowski@gmail.com>
(C) Copyright 2019 Ramon Fried <ramon.fried@gmail.com>
Copyright (C) 2004,2008 Kustaa Nyholm
(C) Copyright 2017 Jorge Ramirez Ortiz <jorge.ramirez-ortiz@linaro.org>
(C) Copyright 2017 Heinrich Schuchardt

Copyright (c) 2016-2018 Alexander Graf et al.
Copyright (c) 2017 Leif Lindholm
(C) Copyright 2016 Alexander Graf
Copyright 2019, Heinrich Schuchardt <xypron.glpk@gmx.de>
(C) Copyright 2013 Oliver Schinagl <oliver@schinagl.nl> http://linux-sunxi.org;(C) Copyright 2006-2013 Allwinner Technology Co., Ltd. <www.allwinnertech.com> Berg Xing <bergxing@allwinnertech.com> Tom Cubie <tangliang@allwinnertech.com>
(C) Copyright 2012 Henrik Nordstrom <henrik@henriknordstrom.net>;(C) Copyright 2000-2003 Wolfgang Denk, DENX Software Engineering, wd@denx.de.
(C) Copyright 2007-2012 Allwinner Technology Co., Ltd. <www.allwinnertech.com> Tom Cubie <tangliang@allwinnertech.com>;(C) Copyright 2013 Luke Kenneth Casson Leighton <lkcl@lkcl.net>
Copyright (c) 2017 Leif Lindholm
(C) Copyright 2007-2015 Allwinner Technology Co. Jerry Wang <wangflord@allwinnertech.com>;(C) Copyright 2015 Vishnu Patekar <vishnupatekar0510@gmail.com>;(C) Copyright 2015 Hans de Goede <hdegoede@redhat.com>;(C) Copyright 2015 Jens Kuske <jenskuske@gmail.com>
Copyright (C) 2016 Siarhei Siamashka <siarhei.siamashka@gmail.com>
(C) Copyright 2007-2015 Allwinner Technology Co. Jerry Wang <wangflord@allwinnertech.com>;(C) Copyright 2015 Vishnu Patekar <vishnupatekar0510@gmail.com>;(C) Copyright 2015 Hans de Goede <hdegoede@redhat.com>
(C) Copyright 2014 Hans de Goede <hdegoede@redhat.com>
(C) Copyright 2007-2015 Allwinner Technology Co., Ltd. <www.allwinnertech.com> Jerry Wang <wangflord@allwinnertech.com>;(C) Copyright 2016 Theobroma Systems Design and Consulting GmbH Philipp Tomsich <philipp.tomsich@theobroma-systems.com>
(C) Copyright 2012 Henrik Nordstrom <henrik@henriknordstrom.net>;(C) Copyright 2013 Luke Kenneth Casson Leighton <lkcl@lkcl.net>;(C) Copyright 2007-2012 Allwinner Technology Co., Ltd. <www.allwinnertech.com> Berg Xing <bergxing@allwinnertech.com> Tom Cubie <tangliang@allwinnertech.com>
(C) Copyright 2014 Hans de Goede <hdegoede@redhat.com>;(C) Copyright 2007-2013 Allwinner Technology Co., Ltd. <www.allwinnertech.com> lixiang <lixiang@allwinnertech.com>
(C) Copyright 2018,2019 Arm Ltd. based on previous work by:;(C) Copyright 2017 Icenowy Zheng <icenowy@aosc.io>
Copyright (C) 2010-2013 Wolfgang Denk <wd@denx.de>
(C) Copyright 2016 Theobroma Systems Design und Consulting GmbH Philipp Tomsich <philipp.tomsich@theobroma-systems.com>
Copyright 2015 Google Inc.
(C) Copyright 2007-2012 Allwinner Technology Co., Ltd. <www.allwinnertech.com> Berg Xing <bergxing@allwinnertech.com> Tom Cubie <tangliang@allwinnertech.com>;(C) Copyright 2014 Hans de Goede <hdegoede@redhat.com>
(C) Copyright 2007-2012 Allwinner Technology Co., Ltd. <www.allwinnertech.com> Tom Cubie <tangliang@allwinnertech.com>;(C) Copyright 2015 Vishnu Patekar <vishnupatekar0510@gmail.com>
Copyright (C) 1991, 1992 Linus Torvalds;(C) Copyright 2000-2009 Wolfgang Denk, DENX Software Engineering, wd@denx.de.
(C) Copyright 2015 Hans de Goede <hdegoede@redhat.com>;(C) Copyright 2016 Theobroma Systems Design und Consulting GmbH Philipp Tomsich <philipp.tomsich@theobroma-systems.com>
Copyright (C) 2016 Microchip Wenyou.Yang <wenyou.yang@microchip.com>
Copyright 2015 Josef Gajdusek <atx@atx.name>
Copyright (C) 2017 Microchip Wenyou.Yang <wenyou.yang@microchip.com>
Copyright (C) 2016 ARM Ltd.
Copyright (c) 2017 Martin Blumenstingl <martin.blumenstingl@googlemail.com>.
Copyright (C) 2016, Freescale Semiconductor
Copyright (C) 2019 Heiko Schocher <hs@denx.de>
Copyright (C) 2013 Steffen Trumtrar <s.trumtrar@pengutronix.de>
Copyright (c) 2019, softathome
Copyright 2019 Lukasz Majewski, DENX Software Engineering, lukma@denx.de
Copyright (c) 2019,Softathome
Copyright (C) 2017 Linaro Bryan O'Donoghue <bryan.odonoghue@linaro.org>
Copyright 2019 Collabora Ltd
Copyright (c) 2016 ARM Ltd.
(C) Copyright 2017 Derald D. Woods <woods.technical@gmail.com>

LICENCE TERMS (cont.)

Copyright (C) 2014-2016 Texas Instruments Incorporated - <http://www.ti.com/>
Copyright (C) 2016, Hisilicon Ltd.
(C) Copyright 2017 Linaro Limited
Copyright (c) 2013 Heiko Stuebner <heiko@sntech.de>
Copyright (C) 2005, 2007 Olivier Gay <olivier.gay@a3.epfl.ch> All rights reserved.
(C) Copyright 2016 Heiko Schocher <hs@denx.de>
Copyright (C) 2015 Atmel, 2015 Josh Wu <josh.wu@atmel.com>
COPYRIGHT (C) 1986 Gary S. Brown. You may use this program, or code or tables extracted from it, as desired without restriction.
Copyright (C) 2016 Marvell
Copyright (C) 2019 Jagan Teki <jagan@amarulasolutions.com>
Copyright 2013-2015 Freescale Semiconductor, Inc.
Copyright 2019 Toradex AG
Copyright 2016 Mylène Jossierand
(C) Copyright 2019-2020 NVIDIA Corporation <www.nvidia.com>
Copyright (C) 2012 Jean-Christophe PLAGNIOL-VILLARD <plagnioj@jcrosoft.com>
Copyright (C) 2015 Xilinx, Inc.
Copyright (C) 2013 Boris BREZILLON <b.brezillon@overkiz.com>
Copyright (C) 2016-2018 Texas Instruments Incorporated - <http://www.ti.com/>
Copyright (c) 2014 Samsung Electronics Co., Ltd. <http://www.samsung.com>
(C) Copyright 2013 Andreas Bießmann <andreas@biessmann.org>
Copyright (C) 2014 Steffen Trumtrar <s.trumtrar@pengutronix.de>
Copyright 2017 - Patrice Chotard <patrice.chotard@st.com>
Copyright (C) 2016, Yann Collet.
Copyright (C) 2019 Nick Xie <nick@khdas.com>
Copyright (c) 2016-present, Przemyslaw Skibinski, Yann Collet, Facebook, Inc. All rights reserved.
Copyright (c) 2019 Akash Gajjar <Akash_Gajjar@mentor.com>
Copyright (c) 2016-present, Yann Collet, Facebook, Inc. All rights reserved.;(c) \
Copyright (C) 2013-2018 Xilinx, Inc.
Copyright (C) 2013-2016, Yann Collet.;(c) \
Copyright (C) 2013-2016, Yann Collet.
Copyright 2013-2014 Texas Instruments, Inc.
Copyright (C) 2015, STMicroelectronics - All Rights Reserved Author: Maxime Coquelin <mcoquelin.stm32@gmail.com> for STMicroelectronics.
Copyright (C) 2013-2015, Yann Collet.;(c) \
Copyright (c) 2017 Martin Blumenstingl <martin.blumenstingl@googlemail.com>.
Copyright (C) 2001 Peter Bergner.
Copyright (C) 2016 Marvell Technology Group Ltd.
Copyright (C) 2017 Microchip Corporation Wenyong Yang <wenyong.yang@microchip.com>
Copyright (C) 2007-2008 Industrie Dial Face S.p.A. Luigi 'Comio' Mantellini (luigi.mantellini@idf-hit.com);(C)
Copyright 2003-2006 Wolfgang Denk, DENX Software Engineering, wd@denx.de.
Copyright (C) 2017 Logic PD - <http://www.logicpd.com>
Copyright (C) 2007-2008 Industrie Dial Face S.p.A. Luigi 'Comio' Mantellini (luigi.mantellini@idf-hit.com)
Copyright (C) 2013 ISEE 2007 SL - <http://www.isee.biz>
Copyright 2014 Google, Inc
Copyright (C) 2007-2009 Industrie Dial Face S.p.A. Luigi 'Comio' Mantellini (luigi.mantellini@idf-hit.com)
Copyright 2013-2019 Boundary Devices, Inc.
Copyright (c) 2013 Google, Inc
Copyright (c) 2014, 2015 FUKAUMI Naoki <naobsd@gmail.com>
Copyright (C) 2019 Amarula Solutions SRO
Copyright (C) 2015 Phytex Messtechnik GmbH Author: Teresa Remmet <t.remmet@phytec.de>
Copyright (C) 2014 Freescale Semiconductor, Inc.
Copyright (C) 2012 Texas Instruments Incorporated - <http://www.ti.com/>
(C) Copyright 2019, Xilinx, Inc.
Copyright (c) 2019 BayLibre, SAS. Author: Neil Armstrong <narmstrong@baylibre.com>
Copyright (C) 2018 Martin Aytte <martinayotte@gmail.com>
Copyright (C) 2014-2016 Topic Embedded Products

Copyright 2015 Hans de Goede <hdegoede@redhat.com>
Copyright (C) 2013 Google, Inc Written by Simon Glass <sjg@chromium.org>
Copyright (C) 2014-2015, Freescale Semiconductor
Copyright 2009 Benjamin Herrenschmidt, IBM Corp benh@kernel.crashing.org
Copyright (C) 1992, 1997 Free Software Foundation, Inc. This file is part of the GNU C Library.
Copyright (C) 2014, Cavium Inc.
Copyright (c) 2011 The Chromium OS Authors.:(C) Copyright 2011 NVIDIA Corporation www.nvidia.com
Copyright (C) 2019 Marek Vasut <marex@denx.de>
Copyright (C) 1995-1998 Mark Adler
Copyright (C) 2017 B&R Industrial Automation GmbH <http://www.br-automation.com>
(C) Copyright 2015 - 2018, Xilinx, Inc.
Copyright (c) 2017 PINE64
(C) Copyright 2016 - 2018, Xilinx, Inc.
Copyright (c) 2017 Fuzhou Rockchip Electronics Co., Ltd.
Copyright (C) 2019 Heiko Schocher <hs@denx.de>
Copyright (c) 2019 BayLibre SAS. All rights reserved.
Copyright (c) 2016-2017 Fuzhou Rockchip Electronics Co., Ltd.
Copyright 2015 Jelle de Jong <jelledejong@powercraft.nl>
(C) Copyright 2017, Heinrich Schuchardt <xypron.glpk@gmx.de>
Copyright (C) 2018 Logic PD, Inc - <http://www.logicpd.com/>
Copyright 2012 Freescale Semiconductor, Inc.
Copyright 2014 Texas Instruments, Inc.
Copyright (c) 2019 Heinrich Schuchardt
Copyright (C) 2017 Jagan Teki <jteki@openedev.com>
Copyright 2016 - Lee Jones <lee.jones@linaro.org>
Copyright (c) 2017 T-Chip Intelligent Technology Co., Ltd
Copyright 2015 Texas Instruments, Inc.
Copyright (c) 2020 Ilias Apalodimas <ilias.apalodimas@linaro.org>
Copyright (c) 2018 Linaro Ltd.
Copyright (C) 2020, Cortina Access Inc.
Copyright Altera Corporation (C) 2014. All rights reserved.
Copyright : STMicroelectronics 2018
(C) Copyright 2019 Rockchip Electronics Co., Ltd;(C) Copyright 2019 Amarula Solutions. Author: Jagan Teki <jagan@amarulasolutions.com>
Copyright (C) 2015, Freescale Semiconductor
Copyright (C) 2011 - 2015 Xilinx
Copyright (c) 2014 Heiko Schocher, DENX Software Engineering, hs@denx.de.
Copyright 2017 Lukasz Majewski, DENX Software Engineering, lukma@denx.de
Copyright (C) 2014 DENX Software Engineering GmbH Heiko Schocher <hs@denx.de>
Copyright (c) 2018 Fuzhou Rockchip Electronics Co., Ltd
Copyright (C) 2018 Armadeus Systems <support@armadeus.com>
Copyright (C) 2019 Logic PD, Inc.
(C) Copyright 2007-2008 Semihalf, Rafal Jaworowski <raj@semihalf.com>
Copyright 2015 Google, Inc
Copyright 2018 B&R Industrial Automation GmbH
Copyright 2004-2009 Analog Devices Inc.
Copyright (C) 1995, 1996, 1997, 1999, 2000 Free Software Foundation, Inc. This file is part of the GNU C Library.
Copyright (c) 2016-2017 HiSilicon Technologies Co., Ltd.
(C) Copyright 2004 Robin Getz rgetz@blacfin.uclinux.org
Copyright 2015 Adam Sampson <ats@offog.org>
Copyright (C) 2013 Jean-Jacques Hiblot <jhiblot@traphandler.com>
Copyright (C) 2013 Atmel, 2013 Josh Wu <josh.wu@atmel.com>
(C) Copyright 2003, Psynt Corporation <www.psyent.com> Scott McNutt <smcnutt@psyent.com>
(c) 2001, Dave Jones. (the file handling bit);(c) 2005, Joel Schopp <jschopp@austin.ibm.com> (the ugly bit);(c) 2007, 2008, Andy Whitcroft <apw@uk.ibm.com> (new conditions, test suite);(c) 2008-2010 Andy Whitcroft <apw@canonical.com>;(c) 2010-2018 Joe Perches <joe@perches.com>
Copyright (c) 2019 BayLibre, SAS. Author: Maxime Jourdan <mjourdan@baylibre.com>

LICENCE TERMS (cont.)

Copyright (c) 1998 Michael Zucchi, All Rights Reserved ##
Copyright 2014, Jason Cooper <jason@lakedaemon.net>
Copyright 2002 by Kai Gernaschewski <kai.gernaschewski@gmx.de>
(C) Copyright 2017 - 2019, Xilinx, Inc.
Copyright: (C) 2014 Himangi Saraogi. GPLv2. Comments: Options:
Copyright (C) 2016 Stefan Wahren <stefan.wahren@i2se.com>
Copyright: (C) 2012 Julia Lawall, INRIA/LIP6. GPLv2.
Copyright: (C) 2010 Nicolas Palix, DIKU. GPLv2.
Copyright 2012 Linaro Ltd
Copyright: (C) 2010-2012 Nicolas Palix. GPLv2.
Copyright (C) 2018 Aleksandr Aleksandrov <aleksandr.aleksandrov@emlid.com>
Copyright: (C) 2014 Fabian Frederick. GPLv2. Comments: - Options: --no-includes --include-headers
Copyright: (C) 2016 Joe Hershberger. GPLv2. Comments: Options: --include-headers --recursive-includes --local-includes -I include
Copyright (C) 2014, Masahiro Yamada <yamada.m@jp.panasonic.com>
(c) 2007, Joe Perches <joe@perches.com> created from checkpatch.pl
Copyright (C) 2013, Masahiro Yamada <yamada.m@jp.panasonic.com>
Copyright (C) 2016-2020 ABB
Copyright Joern Engel <joern@lazybastard.org> Inspired by Linus Torvalds Original idea maybe from Keith Owens s390 port and big speedup by Arnd Bergmann <arnd@bergmann-dalldorf.de> Mips port by Juan Quintela <quintela@mandrakesoft.com> IA64 port via Andreas Dilger Arm port by Holger Schu
Copyright (C) 2017 Google, Inc. Written by Simon Glass <sjg@chromium.org>
Copyright 2011 The Chromium Authors, All Rights Reserved.
(C) Copyright David Gibson <dwg@au1.ibm.com>, IBM Corporation. 2005.
Copyright 2007 Jon Loeliger, Freescale Semiconductor, Inc.
(C) Copyright David Gibson <dwg@au1.ibm.com>, IBM Corporation. 2007.
Copyright (C) 2017 Stefan Wahren <stefan.wahren@i2se.com>
Copyright (C) 2016 Free Electrons
Copyright (C) 2008 Nir Tzachar <nir.tzachar@gmail.com> Released under the terms of the GNU GPL v2.0.
Copyright (C) 2002-2003 Romain Lievin <roms@tilp.info> Released under the terms of the GNU GPL v2.0.
Copyright 2005-2009 - Steven Rostedt Licensed under the terms of the GNU GPL License version 2
Copyright (c) 2017 Andreas Färber
Copyright (c) 2017 BayLibre, SAS. Author: Neil Armstrong <narmstrong@baylibre.com> Author: Jerome Brunet <jbrunet@baylibre.com>
Copyright (c) 2009-2010 Wind River Systems, Inc.
Copyright (C) 2002-2005 Roman Zippel <zippel@linux-m68k.org>
Copyright (c) 2019 MediaTek Inc. Author: Sam Shih <sam.shih@mediatek.com>
Copyright 2017 - Alexandre Torgue <alexandre.torgue@st.com>
Copyright 2012 DENX Software Engineering GmbH Heiko Schocher <hs@denx.de>
Copyright (c) 2016 FUKAUMI Naoki <naobsd@gmail.com>
Copyright (C) 2016 Mario Six <mario.six@gdsys.cc>
Copyright (C) 2002 Roman Zippel <zippel@linux-m68k.org>
Copyright (c) 2011-2012 Samsung Electronics Co., Ltd. http://www.samsung.com
Copyright (C) 1984, 1989-1990, 2000-2015, 2018-2019 Free Software Foundation, Inc.
(C) Copyright 2016-2019 Rockchip Electronics Co., Ltd
Copyright (C) 2019 Rockchip Electronics Co., Ltd
Copyright (C) 2016 Atmel,
Copyright (c) 2016 Google, Inc Script to convert coreboot code to something similar to what U-Boot uses sed -f coreboot.sed <coreboot_file.c> Remember to add attribution to coreboot for new files added to U-Boot. s/REG_RES_ WRITE32(\(.*)\, \(.*)\, \(.*)\),/writel(\3, base + \2);/ s/REG_RES_POLL
Copyright 2013 Maxime Ripard
Copyright (C) 2016, Lukasz Majewski <l.majewski@majess.pl>
(C) Copyright 2000-2011 Wolfgang Denk, DENX Software Engineering, wd@denx.de.;(C) Copyright 2011 Daniel Schwierzeck, daniel.schwierzeck@googlemail.com.:(C) Copyright 2011 Texas Instruments Incorporated - http://www.ti.com/ Aneesh V <aneesh@ti.com> Based on top-level Makefile.
(C) Copyright 2000-2013 Wolfgang Denk, DENX Software Engineering, wd@denx.de.
Copyright 2015 Google, Inc

Copyright 2016 Toradex AG
Copyright (C) 2015 Toby Churchill - http://www.toby-churchill.com/
Copyright (C) 2013 Altera Corporation <www.altera.com>
Copyright (C) 2015
Copyright 2014 Toradex AG
Copyright (C) 2013 - 2016 Xilinx, Inc.
(C) Copyright 2001 Dave Ellis, SIXNET, dge@sixnetio.com
Copyright (C) 2017 Marvell Technology Group Ltd.
Copyright (C) 2019 Georgii Staroselskii <georgii.staroselskii@emlid.com>
Copyright (C) STMicroelectronics 2017 - All Rights Reserved Author: Ludovic Barre <ludovic.barre@st.com> for STMicroelectronics.
(C) Copyright 2014 - 2015, Xilinx, Inc.
Copyright (C) 2011 Atmel, 2011 Nicolas Ferre <nicolas.ferre@atmel.com>
Copyright (C) 2015 Andrea Merello <adnrea.merello@gmail.com>
Copyright (C) 2014 Texas Instruments Incorporated - http://www.ti.com/
Copyright (C) 2018 EETS GmbH - https://www.eets.ch/
Copyright (c) 2017 Icenowy Zheng <icenowy@aosc.io>
Copyright (C) 2017, Tuomas Tynkkynen <tuomas.tynkkynen@iki.fi>
Copyright 2015 - Maxime Coquelin <mcoquelin.stm32@gmail.com>
Copyright (C) 2006 Free Software Foundation, Inc. GDB is free software, covered by the GNU General Public License, and you are welcome to change it and/or distribute copies of it under certain conditions. Type "show copying" to see the conditions. There is absolutely no warranty for GDB.
Copyright (C) 2019 DENX Software Engineering GmbH
Copyright 2016, Freescale Semiconductor
Copyright (c) 2016 Andreas Färber
Copyright (c) 2012 Samsung Electronics Co., Ltd. http://www.samsung.com
(C) Copyright 2013 Xilinx, Inc.
(C) Copyright 2019 Xilinx, Inc.
Copyright(c) 1999 - 2015 Intel Corporation. 0.637382] ehci_hcd: USB 2.0 'Enhanced' Host Controller (EHCI) Driver 0.643799] ehci-pci: EHCI PCI platform driver 0.648261] ehci-platform: EHCI generic platform driver 0.653497] ohci_hcd: USB 1.1 'Open' Host Controller (OHCI)
Copyright 2014 Chen-Yu Tsai
Copyright 2018 Technexion Ltd.
Copyright 2015 Stefan Roese <sr@denx.de>
(C) Copyright 2008-2009 BuS Elektronik GmbH & Co. KG <www.bus-elektronik.de> Jens Scharsig <esw@bus-elektronik.de>
(C) 2003 Arun Dharankar <ADharankar@ATTBI.Com>
Copyright (C) 2011 - 2015 Xilinx
(C) Copyright 2014 Samsung Electronics Lukasz Majewski <l.majewski@samsung.com>
Copyright 2016-2017 Google, Inc
Copyright 2014 Boris Brezillon
Copyright 2014-2019 Toradex AG
Copyright (C) 2012 Atmel, 2012 Nicolas Ferre <nicolas.ferre@atmel.com>
Copyright Altera Corporation (C) 2015
(C) Copyright 2014 Red Hat Inc.
Copyright (C) Thomas Gleixner <tglx@linutronix.de>
(C) Copyright 2003 Dave Ellis, SIXNET, dge@sixnetio.com
Copyright (c) 2010-2011 Samsung Electronics Co., Ltd. http://www.samsung.com
Copyright (C) 2015 - 2017 Xilinx, Inc.
Copyright (C) 2016-2017 Renesas Electronics Corp.
Copyright (c) 2019, Microchip Technology Inc. and its subsidiaries 2019, Eugen Hristev <eugen.hristev@microchip.com>
(c) a memory-schedule (i.e. mapping from physical addresses to the address pins of the memory bus)
Copyright 2018 Einfochips
Copyright 2016 Beckhoff Automation
Copyright (C) 2012 egnite GmbH <info@egnite.de>
Copyright 2017-2019 NXP

LICENCE TERMS (cont.)

Copyright (C) 2013-14 Renesas Solutions Corp.
Copyright (C) 2017 Topic Embedded Products
Copyright (c) 2019 Fuzhou Rockchip Electronics Co., Ltd
Copyright © 2016 Intel Corporation
Copyright (C) 2018 MediaTek Inc. Ryder Lee <ryder.lee@kernel.org>
Copyright 2017 - Vikas MANOCHA <vikas.manocha@st.com>
Copyright 2014 - Hans de Goede <hdegoede@redhat.com>
(C) Copyright 2016, Xilinx, Inc.
(C) Copyright 2014-2015 Samsung Electronics sectionauthor:: Przemyslaw Marczak <p.marczak@samsung.com>
Copyright (C) 2018-2019 Intel Corporation <www.intel.com>
Copyright 2016 Luo Yi <luoyi.ly@gmail.com>
Copyright 2015 Aleksei Mamlin Aleksei Mamlin <mamlinav@gmail.com>
Copyright 2005-2009 Weston Schmidt, Harald Welte and OpenMoko Inc.
Copyright (C) 2013-2014 Renesas Solutions Corp.
Copyright (C) 2018 Vasily Khoruzhick <anarsoul@gmail.com>
Copyright (C) 2007 Free Software Foundation, Inc. License GPLv3+: GNU GPL version 3 or later <http://gnu.org/licenses/gpl.html>
Copyright (c) 2019 Andy Yan <andy.yan@gmail.com>
Copyright 2016 - Stefan Mavrodiev <stefan.mavrodiev@gmail.com> Olimex LTD. <support@olimex.com>
(C) Copyright 2017 - 2018, Xilinx, Inc.
Copyright 2010 Nicolas Palix <npalix@diku.dk>
Copyright (C) 2013-2014 Marvell
(C) Copyright 2015
(C) Copyright 2008 Gary Jennejohn, DENX Software Engineering GmbH <garyj@denx.de>
Copyright (C) 2019 Logic PD <afor173@gmail.com>
Copyright (C) 2014, Simon Glass <sjg@chromium.org>
Copyright (c) 2007,2008 Nobuhiro Iwamatsu <iwamatsu@nigaur.org>
(C) Copyright 2013 SAMSUNG Electronics SAMSUNG EXYNOS5420 SoC device tree source
Copyright (c) 2014 The Chromium OS Authors. sectionauthor:: Simon Glass <sjg@chromium.org>
Copyright (C) 2013, Miao Yan <miao.yan@windriver.com>
Copyright (C) 2016 ARM Ltd.
Copyright (C) 2019 NXP
Copyright 2012 Maxime Ripard <maxime.ripard@free-electrons.com>
Copyright (C) 2015 Google. Inc Written by Simon Glass <sjg@chromium.org>
(C) Copyright 2002 Daniel Engström, Omicron Ceti AB <daniel@omicron.se>.(C) Copyright 2000 Sysgo Real-Time Solutions GmbH Klein-Winternheim, Germany
Copyright (C) 2016 Christoph Fritz <chf.fritz@googlemail.com>
Copyright (C) 2010 Thomas Chou <thomas@wytron.com.tw> Licensed under the GPL-2 or later.
(C) Copyright 2018 Mario Six, Guntermann & Drunck GmbH, mario.six@gdsys.cc
Copyright (C) STMicroelectronics 2017 - All Rights Reserved */
Copyright 2013 Oliver Schinagl
(C) Copyright 2018-2019, Xilinx, Inc.
(C) Copyright 2010 Stefano Babic <sbabic@denx.de>
Copyright (C) 2019 Levin Du <dju@t-chip.com.cn>
Copyright 2017, Theobroma Systems Design und Consulting GmbH Written by Philipp Tomsich <philipp.tomsich@theobroma-systems.com>
Copyright 2015 Freescale Semiconductor, Inc. Author: Zhuoyu Zhang <Zhuoyu.Zhang@freescale.com>
Copyright 2016-2019 Toradex AG
Copyright 2017 Icenowy Zheng <icenowy@aosc.xyz>
Copyright (C) 2015-2019 DH electronics GmbH
Copyright (C) 2014 Alexandre Belloni <alexandre.belloni@free-electrons.com>
Copyright (C) 2012 Javier Martinez Canillas <javier@osg.samsung.com>
Copyright (C) 2019 Georgii Staroselskii <georgii.staroselskii@emlid.com>
Copyright 2013 CompuLab Ltd.
(C) Copyright 2015 Dirk Eibach, Guntermann & Drunck GmbH, eibach@gdsys.de;(C) Copyright 2017 Mario Six, Guntermann & Drunck GmbH, mario.six@gdsys.cc
(C) Copyright 2019, Microchip Technology, Inc. Author: Eugen Hristev <eugen.hristev@microchip.com>
Copyright (C) 2010 Thomas Chou <thomas@wytron.com.tw>
(C) Copyright 2017 Mario Six, Guntermann & Drunck GmbH, mario.six@gdsys.cc;(C) Copyright 2014 Dirk Eibach, Guntermann & Drunck GmbH, dirk.eibach@gdsys.cc
Copyright (C) 2013 Atmel, 2013 Ludovic Desroches <ludovic.desroches@atmel.com>
Copyright 2019 Google, LLC Written by Simon Glass <sjg@chromium.org>
Copyright (C) 2016-2018 Renesas Electronics Corp.
Copyright (C) 2019 Oceanic Systems (UK) Ltd.
(C) Copyright 2017 Mario Six, Guntermann & Drunck GmbH, mario.six@gdsys.cc;(C) Copyright 2014 Dirk Eibach, Guntermann & Drunck GmbH, eibach@gdsys.de
Copyright 2008-2011 Freescale Semiconductor, Inc.
Copyright (C) 2015 Russell King
Copyright (c) 2014 Imagination Technologies Author: Alex Smith <alex.smith@imgtec.com>
Copyright (C) 2011 The ChromiumOS Authors. All rights reserved.
(C) Copyright 2013 ADVANSEE
Copyright (c) 2019 Linaro Ltd.
Copyright (c) 2009 Wind River Systems, Inc. Tom Rix <Tom.Rix@windriver.com>;(C) Copyright 2004-2008 Texas Instruments, <www.ti.com>
Copyright (C) 2016-2019 Texas Instruments Incorporated - http://www.ti.com/
Copyright 2013 Wills Wang
(C) Copyright 2015-2020 NVIDIA Corporation <www.nvidia.com>
Copyright (C) 2019 Linaro Ltd.
(C) Copyright 2002 Gerald Van Baren, Custom IDEAS, vanbaren@cideas.com.
Copyright (c) 2010-2013 NVIDIA Corporation
Copyright (C) 2016-2017 Socionext Inc. Author: Masahiro Yamada <yamada.masahiro@socionext.com> Kunihiro Hayashi <hayashi.kunihiko@socionext.com>
Copyright (c) 2005-2008 Analog Devices Inc.
Copyright (C) 2018 B&R Industrial Automation GmbH http://www.br-automation.com
Copyright (c) 2016 BayLibre, Inc.
Copyright (C) 2009 Texas Instruments Incorporated - http://www.ti.com/
Copyright (C) 2015 Atmel Corporation
Copyright (c) 2015, Microchip Technology Inc. Purna Chandra Mandal <purna.mandal@microchip.com>
Copyright (c) 2019 Michael Walle <michael@walle.cc>
Copyright 2012-2015 Maxime Ripard
Copyright 2019 Socionext, Inc.
Copyright 2017 Andes Technology, Inc. Author: Rick Chen (rick@andestech.com)
Copyright (c) 2001 Navin Boppuri / Prashant Patel nboppuri@trinetcommunication.com>, pmpatel@trinetcommunication.com>
Copyright (c) 2011-12 The Chromium OS Authors.
Copyright (c) 2016 Samsung Electronics Co., Ltd. http://www.samsung.com
Copyright (c) 2018, Microchip Technology Inc. 2018, Eugen Hristev <eugen.hristev@microchip.com>
(C) 2019 Theobroma Systems Design und Consulting GmbH;(C) Copyright 2015 Google, Inc;(C) Copyright 2008-2013 Rockchip Electronics Peter, Software Engineering, <superpeter.cai@gmail.com>.
Copyright 2018 SiFive, Inc.
Copyright (C) 2017 Antony Antony <antony@phenome.org>
Copyright (C) 2016 Jagan Teki <jteki@openedev.com> Christophe Ricard <christophe.ricard@gmail.com>
Copyright (C) 2011-2012 Renesas Solutions Corp.
Copyright (c) 2015 Jagan Teki <jteki@openedev.com>
Copyright (C) 2012 Altera Corporation <www.altera.com> All rights reserved.
(C) Copyright 2012 SAMSUNG Electronics Padmavathi Venna <padma.v@samsung.com>
Copyright : STMicroelectronics 2018
(C) Copyright 2015 Google, Inc;(C) Copyright 2008-2013 Rockchip Electronics Peter, Software Engineering, <superpeter.cai@gmail.com>.
Copyright (c) 2011-2013 The Chromium OS Authors. See file CREDITS for list of people who contributed to this project.
(C) Copyright 2012 Armando Visconti, ST Microelectronics, armando.visconti@st.com.:(C) Copyright 2018 Quentin Schulz, Bootlin, quentin.schulz@bootlin.com
Copyright (C) 2019 BayLibre, SAS Author: Fabien Parent <fparent@baylibre.com>

LICENCE TERMS (cont.)

(C) Copyright 2018 Xilinx
(C) Copyright 2013 Xilinx, Inc.:(C) Copyright 2015 Jagan Teki <jteki@openedev.com>
Copyright (c) 2014 Google, Inc.:(C) Copyright 2002 Gerald Van Baren, Custom IDEAS, vanbaren@cideas.com.
(C) Copyright 2017 Whitebox Systems / Northend Systems B.V. S.J.R. van Schaik <stephan@whiteboxsystems.nl>
M.B.W. Wajer <merlijn@whiteboxsystems.nl>
Copyright (C) 2014 Beniamino Galvani <b.galvani@gmail.com>
Copyright 2010-2011 Freescale Semiconductor, Inc. Author: Mingkai Hu (Mingkai.hu@freescale.com)
Copyright (c) 2010-2013 NVIDIA Corporation With help from the mpc8xxx SPI driver With more help from omap3_spi SPI driver
Copyright (C) 2008, Guennadi Liakhovetski <lg@denx.de>
Copyright 2014 Sjarhei Siamashka <sjarhei.siamashka@gmail.com>
Copyright (c) 2017 Rockchip Electronics Co., Ltd
Copyright (C) 2013, Texas Instruments, Incorporated
Copyright (c) 2006 Ben Warren, Qstreams Networks Inc. With help from the common/soft_spi and arch/powerpc/cpu/mpc8260 drivers
Copyright (c) 2019 Written by Ramon Fried <ramon.fried@gmail.com>
Copyright (c) 2017 Cadence
Copyright (c) 2019 Ramon Fried <ramon.fried@gmail.com>
(C) Copyright 2016 - Beniamino Galvani <b.galvani@gmail.com>
Copyright (C) 2017 Microchip Technology Inc, Ludovic Desroches <ludovic.desroches@microchip.com>
(C) Copyright (C) 2018 Neil Armstrong <narmstrong@baylibre.com>
Copyright (C) 2017 Jerome Brunet <jbrunet@baylibre.com>
(C) Copyright (C) 2019 Jerome Brunet <jbrunet@baylibre.com>
(C) Copyright 2016 - Beniamino Galvani <b.galvani@gmail.com>
Copyright (C) 2016 Atmel, 2016 Nicolas Ferre <nicolas.ferre@atmel.com>
Copyright (C) 2018 Jerome Brunet <jbrunet@baylibre.com>
Copyright (C) 2014 Atmel, 2014 Nicolas Ferre <nicolas.ferre@atmel.com>
Copyright 2015 Gábor Nyers
Copyright 2015 Vishnu Patekar
Copyright (C) 2015 Atmel, 2015 Alexandre Belloni <alexandre.Belloni@free-electrons.com>
Copyright (C) 2017 Intel Corp.
Copyright (C) 2013-2014 Marvell
Copyright (C) 2015 Russell King
Copyright (C) STMicroelectronics 2019 - All Rights Reserved Author: Alexandre Torgue <alexandre.torgue@st.com> for STMicroelectronics.
Copyright (C) 2014, Arnaud EBALARD <arno@natisbad.org>
Copyright 2015-2016 Freescale Semiconductor, Inc.
Copyright (C) 2012 Atmel, 2012 Hong Xu <hong.xu@atmel.com>
Copyright (C) 2018 EETS GmbH - <https://www.eets.ch/>
Copyright (c) 2008 Magnus Damm
Copyright (C) 2018-2019 Renesas Electronics Corp.
Copyright (C) 2016-2017 Renesas Electronics Corp.
(C) 2017 Theobroma Systems Design und Consulting GmbH
Copyright (C) 2013-2014 Renesas Electronics Corporation
Copyright (C) 2008 Magnus Damm
Copyright (C) 2014-2015 Renesas Electronics Corporation
Copyright (C) 2015-2019 Renesas Electronics Corporation
Copyright (C) 2017 Renesas Electronics Corp.
Copyright (C) 2015 Marek Vasut <marex@denx.de>
Copyright (C) 2016-2019 Renesas Electronics Corp.
Copyright (c) 2017 Free Electrons <maxime.ripard@free-electrons.com>
Copyright (C) 2017 Stefan Roese <sr@denx.de>
Copyright 2015 Chen-Yu Tsai <wens@csie.org>
Copyright (c) 2017 Microsemi Corporation
Copyright (C) 2015 Jablotron s.r.o. -- <http://www.jablotron.com/> Author: Rostislav Lisovy <lisovy@jablotron.cz>
Copyright (C) 2018 SolidRun Ltd
Copyright (C) 2014-2019 Texas Instruments Incorporated - <http://www.ti.com/>

Copyright (c) 2015 Microchip Technology Inc. Written by Purna Chandra Mandal <purna.mandal@microchip.com>
Copyright (C) 2005-2007 Samsung Electronics. Kyungmin Park <kyungmin.park@samsung.com>
Copyright (C) 2005-2007 Samsung Electronics Kyungmin Park <kyungmin.park@samsung.com>
Copyright (C) 2016 Derald D. Woods <woods.technical@gmail.com>
Copyright(c) 2005-2008 Samsung Electronics Kyungmin Park <kyungmin.park@samsung.com>
Copyright (C) 2015 Cristian Birsan <cristian.birsan@microchip.com> Purna Chandra Mandal <purna.mandal@microchip.com>
Copyright (C) 2005, Intec Automation Inc.
Copyright (C) 2013 Jagannatha Sutradharudu Teki, Xilinx Inc.
Copyright (C) 2004-2009, 2015 Freescale Semiconductor, Inc. Haikun Wang (haikun.wang@freescale.com);(c) WRITE to buffer could be done while waiting for a previous MWRITE/MWERASE to complete ... d) error handling here seems to be mostly missing.
Copyright (C) 2012-2014 Daniel Schwierzeck, daniel.schwierzeck@gmail.com
Copyright (C) 2017 Touchless Biometric Systems AG Tomas Novotny <tomas@novotny.cz>
Copyright (c) International Business Machines Corp., 2006
Copyright (c) Thomas Gleixner <tglx@linutronix.de>
Copyright 2014 General Electric Company
Copyright © 2000 Nicolas Pitre <nico@fluxnic.net>
Copyright (C) 2016-2017 Micron Technology, Inc.
Copyright (c) 2017 exceet electronics GmbH
Copyright (c) 2018 Macronix
Copyright (c) 2017 Free Electrons
(C) Copyright 2012 SAMSUNG Electronics SAMSUNG EXYNOS5250 SoC device tree source
Copyright (C) STMicroelectronics 2019 Author: Christophe Kerello <christophe.kerello@st.com>
(C) Copyright 2014 3ADEV <<http://3adev.com>> Written by Albert ARIBAUD <albert.aribaud@3adev.fr>
(c) 2009 Magnus Lilja <lilja.magnus@gmail.com>
Copyright (C) 2000 Steven J. Hill (sjhill@realitydiluted.com) 2002-2006 Thomas Gleixner (tglx@linutronix.de)
Copyright 2009-2015 Freescale Semiconductor, Inc. and others
Copyright 2011 Freescale Semiconductor, Inc. Author: Dipen Dudhat <dipen.dudhat@freescale.com>
(C) Copyright 2007-2008 Stelian Pop <stelian@popies.net> Lead Tech Design <www.leadtechdesign.com>;(C)
Copyright 2006 ATMEL Rousset, Lacrosonniere Nicolas;(C) Copyright 2012 ATMEL, Hong Xu
Copyright (C) 2013-2014 Altera Corporation <www.altera.com>
Copyright (C) 2014 - 2015 Xilinx, Inc.
(C) Copyright 2004-2008 Texas Instruments, <www.ti.com> Rohit Chordia <rohitkc@ti.com>
Copyright (c) 2014, Fuzhou Rockchip Electronics Co., Ltd
Copyright (c) 2006-2008 Freescale Semiconductor
(C) Copyright 2009 Magnus Lilja <lilja.magnus@gmail.com>;(C) Copyright 2008 Maxim Artamonov, <scn1874 at yandex.ru>;(C) Copyright 2006-2008 Stefan Roese, DENX Software Engineering, sr at denx.de.
Copyright © 2010-2015 Broadcom Corporation
Copyright (c) 2011 The Chromium OS Authors.:(C) Copyright 2011 NVIDIA Corporation <www.nvidia.com>;(C)
Copyright 2006 Detlev Zundel, dzu@denx.de;(C) Copyright 2006 DENX Software Engineering
Copyright (C) 2000-2004 Steven J. Hill (sjhill@realitydiluted.com) Toshiba America Electronics Components, Inc.
Copyright (c) 2016 Martin Blumenstingl <martin.blumenstingl@googlemail.com>. Based on meson-gx-p23x-q20x.dtsi:
(C) Copyright 2012 Konstantin Kozhevnikov, Cogent Embedded;(C) Copyright 2006-2008 Stefan Roese, DENX Software Engineering, sr@denx.de.
Copyright (c) 2014-2015, Antmicro Ltd <www.antmicro.com>
Copyright © 2005 Intel Corporation
Copyright (C) 2014 Free Electrons
Copyright 2004-2007 Freescale Semiconductor, Inc.
Copyright 2017 Armadeus Systems <support@armadeus.com>
Copyright (c) 2006-2009 Analog Devices Inc. Licensed under the GPL-2 or later.
Copyright (c) 2016 Fuzhou Rockchip Electronics Co., Ltd
(C) Copyright 2006-2008 Stefan Roese, DENX Software Engineering, sr@denx.de.
(C) Copyright 2009 Heiko Schocher, DENX Software Engineering, hs@denx.de
Copyright (C) 2002 Thomas Gleixner (tglx@linutronix.de)
Copyright (C) 2019 BayLibre SAS. Author: Fabien Parent <fparent@baylibre.com>

LICENCE TERMS (cont.)

(C) Copyright 2006 KwikByte <kb9200_dev@kwikbyte.com>;(C) Copyright 2009 Matthias Kaehlcke <matthias@kaehlcke.net>
(C) Copyright 2006-2008 Stefan Roese, DENX Software Engineering, sr@denx.de.
(C) Copyright 2010 Vipin Kumar, ST Microelectronics, vipin.kumar@st.com.:(C) Copyright 2012 Amit Virdi, ST Microelectronics, amit.virdi@st.com.
Copyright 2015 Tyler Baker
Copyright (C) 2011 Marek Vasut <marek.vasut@gmail.com> on behalf of DENX Software Engineering GmbH
Copyright (C) 2017 Aditya Prayoga <aditya@kobol.io>
Copyright © 2004 Thomas Gleixner (tglx@linutronix.de)
Copyright (c) 2012 Freescale Semiconductor, Inc
Copyright (C) 2018 Toradex
Copyright (C) 2017-2019 SoMLabs
(C) Copyright 2015-2018 Vladimir Zapolskiy <vz@mleia.com>
Copyright (C) 2019 Claudius Heine <ch@denx.de>
(C) Copyright 2016 Xilinx, Inc.
Copyright (C) 2006 by Weiss-Electronic GmbH. All rights reserved.
Copyright (C) 2013 Boris BREZILLON <b.brezillon.dev@gmail.com>
Copyright © 1999-2010 David Woodhouse <dwmw2@infradead.org>
(C) Copyright 2002-2004 Brad Kemp, Serano Networks, Brad.Kemp@serano.com
(C) Copyright 2009 Vipin Kumar, ST Microelectronics, vipin.kumar@st.com.
(C) Copyright 2007 Michael Schwingen, <michael@schwingen.org>;(C) 2000 Red Hat. GPL'd. Occasionally maintained by Thayne Harbaugh tharbaugh at lnx dot com
Copyright (c) 2016 Heiko Stuebner <heiko@sntech.de>
Copyright (C) 2015, Hisilicon Ltd.
Copyright (c) 2012 Linutronix GmbH
Copyright 2016-2019 Toradex AG
copyright abandoned. Code was subsequently included in the kernel, thus was re-licensed under the GNU GPL v2.
Copyright (C) 2018 Jacopo Mondi <jacopo@jmondi.org>
Copyright (C) 2019 Texas Instruments Incorporated - <http://www.ti.com/> Author: Vignesh Raghavendra <vigneshr@ti.com>
Copyright (c) 2017 Icenowy Zheng <icenowy@aosc.xyz>
Copyright (C) 2016 Uwe Kleine-König <uwe@kleine-koenig.org>
Copyright © 2002 Robert Kaiser <rkaiser@sysgo.de>
Copyright (C) 2016 Renesas Electronics Corporation
Copyright 2015 Jelle van der Waa <jelle@vbwaa.nl>
Copyright (C) 2018 Texas Instruments Incorporated <www.ti.com>
(C) Copyright 2018 - 2019, Xilinx, Inc.
Copyright 2014 - Iain Paton <ipaton0@gmail.com>
Copyright Altera Corporation (C) 2015
Copyright (C) 2008 by NXP Semiconductors Author: Kevin Wells Descr: LPC3250 DMA controller interface support functions
Copyright 2018 Lukasz Majewski, DENX Software Engineering, lukma@denx.de
Copyright (C) 2017 David Lechner <david@lechnology.com>
Copyright 2004,2007,2008 Freescale Semiconductor, Inc.:(C) Copyright 2002, 2003 Motorola Inc. Xianghua Xiao (X.Xiao@motorola.com);(C) Copyright 2000 Wolfgang Denk, DENX Software Engineering, wd@denx.de.
Copyright (c) 2015, Sony Mobile Communications AB.
Copyright (c) 2018 Flowbird Martin Fuzzey <martin.fuzzey@flowbird.group>
Copyright (C) 2007 Freescale Semiconductor, Inc. Jason Jin <Jason.jin@freescale.com>
(C) Copyright 2017, Xilinx, Inc.
Copyright (C) 2007 Freescale Semiconductor, Inc. Jason Jin<Jason.jin@freescale.com>
Copyright 2015 Lawrence Yu <lyu@micile.com>
Copyright (C) 1991-2004 SciTech Software, Inc.
Copyright (C) 2013 Steffen Trumtrar <s.trumtrar@pengutronix.de>
Copyright (c) 2018 Fuzhou Rockchip Electronics Co., Ltd.
Copyright (C) 1996-1999 SciTech Software, Inc.
Copyright (C) 2018 Texas Instruments Incorporated - <http://www.ti.com/> This file was generated by AM65x_DRA80xM_EMIF_Tool_1.98.xlsm <http://www.ti.com/lit/pdf/spracj0> Configuration Parameters Memory Type: DDR4

Data Rate: 1600 MT/s ECC Enabled: No Data Width: 32 bits
Copyright, (C) 2015 Heiko Schocher <hs@denx.de>
Copyright (C) 2014 Atmel, 2014 Nicolas Ferre <nicolas.ferre@atmel.com>
Copyright (C) 2018 Michal Simek
Copyright (c) 2014 Google, Inc;:(C) Copyright 2012 Pavel Herrmann <morpheus.ibis@gmail.com>
Copyright (c) 2019 Simon Goldschmidt
Copyright (C) 2016 NXP Semiconductors. Author: Fabio Estevam <fabio.estevam@nxp.com>
Copyright (C) 2017 PHYTEC Messtechnik GmbH Author: Wadim Egorov <w.egorov@phytec.de>
Copyright (c) 2017 Google, Inc;:(C) Copyright 2012 Pavel Herrmann <morpheus.ibis@gmail.com>
Copyright 2017-2019 Toradex
Copyright (C) 2012 Samsung Electronics author: Lukasz Majewski <l.majewski@samsung.com>
Copyright (C) 2019,STMicroelectronics - All Rights Reserved
Copyright (C) 2013,2014 - Stefan Roese <sr@denx.de>
Copyright (C) 2012 Altera Corporation <www.altera.com>
(C) Copyright 2015 Lukasz Majewski <l.majewski@majess.pl>
(C) Copyright 2013 Afzal Mohammed <afzal.mohd.ma@gmail.com>
Copyright (C) 2012-2013 Texas Instruments, Inc.
Copyright (C) Harald Geyer <harald@ccbib.org> based on sun50i-a64-olinuxino.dts by Jagan Teki <jteki@openedev.com>
(C) Copyright 2017 Mario Six, Guntermann & Drunck GmbH, mario.six@gdsys.cc obj-y += board-uclass.o obj-\$(CONFIG_BOARD_GAZERBEAM) += gazerbeam.o obj-\$(CONFIG_BOARD_SANDBOX) += sandbox.o
Copyright 2017 Chen-Yu Tsai
Copyright (C) 2013 Henrik Nordstrom <henrik@henriknordstrom.net>
Copyright © 2015 Hans de Goede <hdegoede@redhat.com>
Copyright (c) 2010, by Texas Instruments
Copyright 2005 Mentor Graphics Corporation
Copyright (C) 2005-2007 by Texas Instruments Some code has been taken from tusb6010.c Copyrights for that are attributable to:
(C) Copyright 2018 Lukasz Majewski, DENX Software Engineering, lukma@denx.de.
Copyright (C) 2019-2021 by Mediatek Based on the AllWinner SUNXI "glue layer" code.
Copyright (c) 2019, by Texas Instruments
Copyright (C) 2012, by Texas Instruments
(C) Copyright 2016 Fabian Vogt <fvogt@suse.com>
Copyright (C) 2005-2006 by Texas Instruments
Copyright © 2015 Hans de Goede <hdegoede@redhat.com>
Copyright (C) 2015, Microchip Technology Inc. Cristian Birsan <cristian.birsan@microchip.com> Purna Chandra Mandal <purna.mandal@microchip.com>
Copyright (c) 2009 Daniel Mack <daniel@caiaq.de>
Copyright 2014 Zoltan HERPAI Zoltan HERPAI <wigyori@uid0.hu>
(C) Copyright 2009, 2011 Freescale Semiconductor, Inc.:(C) Copyright 2008, Excito Elektronik i Sk=E5ne AB
Copyright (c) 2015 Realtek Semiconductor Corp. All rights reserved.
Copyright (c) 2017 Microchip Technology Inc. All rights reserved.
Copyright (c) 2014 Rene Griessl <rgriessl@cit-ec.uni-bielefeld.de> based on the U-Boot Asix driver as well as information from the Linux AX88179_178a driver
Copyright (C) Linaro Ltd 2019 - All Rights Reserved Author: Manivannan Sadhasivam <manivannan.sadhasivam@linaro.org>
Copyright (c) 2013 Gerhard Sittig <gsi@denx.de> based on the U-Boot Asix driver as well as information from the Linux Moschip driver
Copyright (C) 2011 Jana Rapava <fermata7@gmail.com>
Copyright (C) 2011 Texas Instruments Incorporated - <http://www.ti.com> Author: Govindraj R <govindraj.raja@ti.com>
Copyright 2014-2019 Soeren Moch <smoch@web.de>
Copyright (C) 2016 Cadence Design Systems - <http://www.cadence.com>
Copyright (C) 2016 Cadence Design Systems - <https://www.cadence.com/>
Copyright (C) 2014 - Lukas Stockmann <lukas.stockmann@siemens.com>
Copyright (C) 2013 Linaro, Ltd.
Copyright (C) 2003-2005,2008 David Brownell
Copyright 2011, Marvell Semiconductor Inc.

LICENCE TERMS (cont.)

Copyright (C) 2004 David Brownell
Copyright (C) 2008 for Samsung Electronics
Copyright (C) 2019 Chen-Yu Tsai <wens@csie.org>
Copyright (C) 2005-2013 Atmel Corporation Bo Shen <voice.shen@atmel.com>
(C) Copyright 2007-2018 Xilinx, Inc.:(C) Copyright 2007-2013 Michal Simek:(C) Copyright 2007-2012 PetaLogix Qld Pty Ltd
Copyright (C) 2003-2008 Alan Stern
Copyright 2011, Marvell Semiconductor Inc. Lei Wen <leiwen@marvell.com>;(c) already applies, then we must force (a) to apply by explicitly sending an extra zero-length packet.
Copyright (C) 2015 Cogent Embedded, Inc.
Copyright (C) 2006-2008 David Brownell U-Boot porting: Lukasz Majewski <l.majewski@samsung.com>
Copyright (C) 2004 by David Brownell updates to merge with Linux 2.6, better match RNDIS spec
Copyright (C) 2013 Samsung Electronics Lukasz Majewski <l.majewski@samsung.com>
Copyright (C) 2002 Intrinsyc, Inc. (Frank Becker)
(C) Copyright 2017
Copyright (C) 2004 by Thomas Rathbone
Copyright (C) 2017 Rask Ingemann Lambertsen <rask@formelder.dk>
Copyright (C) 2015 Texas Instruments Incorporated - http://www.ti.com
Copyright (C) 2003 David Brownell
Copyright 2013 Texas Instruments, Inc.
Copyright 2015 Broadcom Corporation.
Copyright (C) 2003-2008 Alan Stern;(C) 2009 Samsung Electronics Author: Michal Nazarewicz (m.nazarewicz@samsung.com)
Copyright (C) 2004 by Thomas Rathbone, HP Labs
Copyright (C) 2018 Intel Corporation
Copyright (C) 2009 for Samsung Electronics
Copyright (C) 2012 Samsung Electronics authors: Andrzej Pietrasiewicz <andrzej.p@samsung.com> Lukasz Majewski <l.majewski@samsung.com>;(C) 2007 by OpenMoko, Inc. Author: Harald Welte <hforge@openmoko.org>;(C) Copyright 2006 by Harald Welte <hwelte at hmw-consulting.de>
Copyright (C) 2003 Robert Schwebel <r.schwebel@pengutronix.de>, Pengutronix
Copyright 2016-2018 NXP Semiconductors
Copyright (C) 2004 Herbert Poetzi <herbert@13thfloor.at>
Copyright (C) 2019 B&R Industrial Automation GmbH - https://www.br-automation.com/
Copyright (C) 2011-2012 Samsung Electronics author: Andrzej Pietrasiewicz <andrzej.p@samsung.com>
Copyright (C) 2011 Atmel, 2011 Nicolas Ferre <nicolas.ferre@atmel.com>, 2011 Jean-Christophe PLAGNIOL-VILLARD <plagnioj@jcrosoft.com>
Copyright (c) 2009 Wind River Systems, Inc. Tom Rix <Tom.Rix@windriver.com>
Copyright 2016 Rockchip Electronics Co., Ltd
(C) Copyright 2017 Adam Ford, Logic PD, aford173@gmail.com
Copyright (c) 2010 Texas Instruments Incorporated
Copyright (c) 2015 Heiko Stuebner <heiko@sntech.de>
Copyright (c) 2008 Texas Instruments
Copyright 2012 Stefan Roese Stefan Roese <sr@denx.de>
Copyright (C) 2018 Grinn Sp. z o.o. -- http://www.grinn-global.com/ Author: Marcin Niestroj <m.niestroj@grinn-global.com>
Copyright 2008 Mentor Graphics Corporation
Copyright (C) 2014 Atmel, 2014 Nicolas Ferre <nicolas.ferre@atmel.com> 2015 Gregory CLEMENT <gregory.clement@free-electrons.com>
Copyright (C) 2018-2019 Renesas Electronics Corp.
Copyright (c) 2015 Texas Instruments Incorporated - http://www.ti.com
(C) Copyright 2013 Sergey Kostenbaev <sergey.kostenbaev@at> fairwaves.ru >
Copyright (C) 2014 Atmel, 2014 Free Electrons
Copyright (c) 2007-2008, Juniper Networks, Inc.
Copyright (C) 2008 by NXP Semiconductors Author: Based on code by Kevin Wells Descr: USB driver - Embedded Artists LPC3250 OEM Board support functions
Copyright (C) 2012 Oleksandr Tymoshenko <gonzo@freebsd.org>
(C) Copyright 2010 Armando Visconti, ST Micoelectronics, <armando.visconti@st.com>;(C) Copyright 2009 Marvell

Semiconductor <www.marvell.com> Written-by: Prafulla Wadaskar <prafulla@marvell.com>
(C) Copyright 2006 DENX Software Engineering <mk@denx.de>
Copyright (c) 2015, Google, Inc Written by Simon Glass <sjg@chromium.org> All rights reserved.
(C) Copyright 2007 Zhang Wei, Freescale Semiconductor, Inc. <wei.zhang@freescale.com>;(C) Copyright 2003 Gary Jennejohn, DENX Software Engineering <garyj@denx.de>;(C) Copyright 1999 Roman Weissgaerber <weissg@vienna.at>;(C) Copyright 2000-2002 David Brownell;(C) Copyright 2005 Eric Benard ebenard@eukrea.com - based on s3c24x0's driver
Copyright (C) 2012 Samsung Electronics Co.Ltd Vivek Gautam <gautam.vivek@samsung.com> Vikas Sajjan <vikas.sajjan@samsung.com>
Copyright (C) 2012 Samsung Electronics Co.Ltd Vivek Gautam <gautam.vivek@samsung.com>
(C) Copyright 2009 Stefan Roese <sr@denx.de>, DENX Software Engineering
Copyright (C) 2013,2014 Renesas Electronics Corporation
(C) Copyright 2004 Wolfgang Denk, DENX Software Engineering, wd@denx.de.
Copyright (c) 2016 Rockchip, Inc. Authors: Daniel Meng <daniel.meng@rock-chips.com>
Copyright (C) 2012 Sugghosh Ganu <unwithsugghosh@gmail.com>
Copyright 2019 Linaro Ltd.
(C) Copyright 2012 elfinchips Ltd. <www.elfinchips.com> Written-by: Ajay Bhargav <contact@8051projects.net>;(C) Copyright 2009 Marvell Semiconductor <www.marvell.com>
Copyright (C) 2008 Yoshihiro Shimoda <shimoda.yoshihiro@renesas.com>
(C) Copyright 2009, 2011, 2016 Freescale Semiconductor, Inc.:(C) Copyright 2008, Excito Elektronik i Sk=E5ne AB
(C) Copyright 2011 Ilya Yanok, Emcraft Systems
(C) Copyright 1999 Roman Weissgaerber <weissg@vienna.at>;(C) Copyright 2000-2001 David Brownell <dbrownell@users.sourceforge.net>
Copyright (C) 2016 Topic Embedded Products
Copyright (c) 2015 Sanchayan Maity <sanchayan.maity@toradex.com>
Copyright (c) 2007-2008, Juniper Networks, Inc. All rights reserved.
Copyright (C) 2015 Alexey Brodtkin <abrodtkin@synopsys.com>
Copyright (C) 2017 Marcus Cooper <codekipper@gmail.com>
Copyright (C) 2019 Texas Instruments Author: Faiz Abbas <faiz_abbas@ti.com>
(C) Copyright 2014, Xilinx, Inc
Copyright 2015,2016 Freescale Semiconductor, Inc.
(C) Copyright 2012 Atmel Semiconductor <www.atmel.com> Written-by: Bo Shen <voice.shen@atmel.com>
Copyright (c) 2019 Heiko Schocher, DENX Software Engineering, hs@denx.de.
(C) Copyright 2012 elfinchips Ltd. <www.elfinchips.com> Written-by: Ajay Bhargav <contact@8051projects.net>;(C) Copyright 2009 Marvell Semiconductor <www.marvell.com> Written-by: Prafulla Wadaskar <prafulla@marvell.com>
Copyright (c) 2009 Daniel Mack <daniel@caiaq.de>
Copyright (C) 2019 BayLibre, SAS Author: Neil Armstrong <narmstrong@baylibre.com>
Copyright 2018 Armadeus Systems <support@armadeus.com>
Copyright 2016 Quentin Schulz
Copyright 2019 NXP Author: Fabio Estevam <fabio.estevam@nxp.com>
Copyright (C) 2016 - 2018 Xilinx, Inc.
Copyright (C) 2019 DH electronics GmbH
Copyright 2014 Chen-Yu Tsai <wens@csie.org>
Copyright (C) 2006-2011 Freescale Semiconductor, Inc.
Copyright (C) 2019 Clément Péron <peron.clem@gmail.com>
(C) Copyright 2016 Rockchip Electronics Co., Ltd;(C) Copyright 2018 Manivannan Sadhasivam <manivannan.sadhasivam@linaro.org>
Copyright (C) 2005,2010-2011 Freescale Semiconductor, Inc.
Copyright (c) 2013 The Chromium OS Authors SAMSUNG EXYNOS5 SoC device tree source
Copyright (C) 2005, 2011 Freescale Semiconductor, Inc.
Copyright (C) 2006-2010 Freescale Semiconductor, Inc.
Copyright (C) 2019 Texas Instruments Incorporated - http://www.ti.com/ This file was generated by the AM752x_DRA82x_TDA4x_DDRSS_RegConfigTool, Revision: 0.2.0 This file was generated on 10/09/2019
Copyright 2011 Maxim Integrated Products
Copyright 2013 Freescale Semiconductor, Inc.
Copyright (C) 2013 Samsung Electronics D Krishna Mohan <krishna.md@samsung.com>

LICENCE TERMS (cont.)

Copyright (C) 2014-2015 Altera Corporation <www.altera.com>
Copyright 2010 Maxim Integrated Products
Copyright (C) 2019 Karl Palsson <karlp@tweak.net.au>
Copyright 2018 Google, LLC Written by Simon Glass <sjg@chromium.org>
(C) Copyright 2012 Samsung Electronics
Copyright 2018 Google LLC
Copyright 2015 Vishnu Patekar Vishnu Patekar <vishnupatekar0510@gmail.com>
Copyright (C) 2012 Samsung Electronics R. Chadrasekar <rcsekar@samsung.com>
Copyright 2013 Realtek Semiconductor Corp. Author: Oder Chiou <oder_chiou@realtek.com>
Copyright (C) 2008 Advanced Micro Devices, Inc.
Copyright (C) 2020 Chen-Yu Tsai <wens@csie.org>
Copyright (C) STMicroelectronics 2019 - All Rights Reserved
Copyright (C) 2017 Logic PD, Inc.
Copyright 2017 Chen-Yu Tsai <wens@csie.org>
Copyright (C) 2015, Texas Instruments, Incorporated
Copyright (C) 2019 B&R Industrial Automation GmbH <http://www.br-automation.com>
Copyright (C) 2019 Stephan Gerhold <stephan@gerhold.net>
Copyright 2013 Emilio López
Copyright (C) 2016 Synopsys, Inc. All rights reserved.
Copyright (C) 2017 Theobroma Systems Design und Consulting GmbH
Copyright (C) 2014 Javier Martinez Canillas <javier@osg.samsung.com>
(C) Copyright 2016 Rick Chen, NDS32 Software Engineering, rick@andestech.com
Copyright 2015 Marcus Cooper <codekipper@gmail.com>
(C) Copyright 2000-2002 Wolfgang Denk, DENX Software Engineering, wd@denx.de.;(C) Copyright 2004, Psyent Corporation <www.psyent.com> Scott McNutt <smcnutt@psyent.com>
Copyright (C) Excito Elektronik i Skåne AB, 2010. Author: Tor Krill <tor@excito.com>
Copyright (C) 2011 Freescale Semiconductor, Inc.
Copyright (C) Excito Elektronik i Skåne AB, All rights reserved. Author: Tor Krill <tor@excito.com>
Copyright (C) 2008 Freescale Semiconductor, Inc. Dave Liu <daveliu@freescale.com> port from the libata of linux kernel
Copyright (C) 2010 Freescale Semiconductor, Inc. Terry Lv <r65388@freescale.com>
Copyright (C) 2014-2017 Texas Instruments Incorporated - <http://www.ti.com/>
Copyright (C) 2008,2010 Freescale Semiconductor, Inc.
Copyright (C) 2007-2008 Freescale Semiconductor, Inc.
(C) Copyright 2015 - 2016 Xilinx, Inc. Michal Simek <michal.simek@xilinx.com>
Copyright (C) 2010 Albert ARIBAUDA <albert.u.boot@aribaud.net>
Copyright (C) 2010-2011 Freescale Semiconductor, Inc. Terry Lv <r65388@freescale.com>
Copyright (C) 2016 ARM Ltd. based on the Allwinner H3 dtsi:
Copyright (c) 2018 Microchip Technology, Inc.
Copyright 2015 Sutajjo Ko-Usagi PTE LTD
Copyright (C) 2019, Phytium Ltd. shuyiqi <shuyiqi@phytium.com.cn>
Copyright 2014 Open Source Support GmbH
Copyright 2014 Sjarhei Siamashka <sjarhei.siamashka@xxxxxxxxxx>
Copyright (C) 2017 Icenowy Zheng <icenowy@aosc.xyz> Based on sun50i-h5-orangepi-pc2.dts, which is:
Copyright (C) 2019 Andes Technology Corporation Rick Chen, Andes Technology Corporation <rick@andestech.com>
Copyright (c) 2016, Google Inc;(C) Copyright 2002 David Mueller, ELSOFT AG, d.mueller@elsoft.ch
(C) Copyright 2002 David Mueller, ELSOFT AG, d.mueller@elsoft.ch
Copyright (c) 2004 Texas Instruments
(C) Copyright 2000 Paolo Scaffardi, AIRVENT SAM s.p.a - RIMINI(ITALY), arsenio@tin.it;(C) Copyright 2000 Sysgo Real-Time Solutions, GmbH <www.elinos.com> Marius Groeger <mgroeger@sysgo.de>;(C) Copyright 2003 Pengutronix e.K. Robert Schwebel <r.schwebel@pengutronix.de>;(C) Copyright 2011 Marvell Inc. Lei Wen <leiwen@marvell.com>
Copyright (c) 2010 Albert Aribaud.
Copyright 2016 Freescale Semiconductors, Inc.
Copyright (C) 2012 Altera <www.altera.com>
Copyright (C) 2018 Marek Vasut <marex@denx.de>
(C) Copyright 2000-2007 Wolfgang Denk, DENX Software Engineering, wd@denx.de. obj-\$(CONFIG_DM_I2C) += i2c-uclass.o obj-\$(CONFIG_DM_I2C_GPIO) += i2c-gpio.o obj-\$(CONFIG_\$(SPL_)I2C_CROS_EC_TUNNEL) += cros_ec_tunnel.o obj-\$(CONFIG_\$(SPL_)I2C_CROS_EC_LDO) += cros_ec_ldo.o
(c) 2007 Pengutronix, Sascha Hauer <s.hauer@pengutronix.de>
(C) Copyright 2015 Albert ARIBAUDA <albert.u.boot@aribaud.net>
(C) Copyright 2014-2015 DENX Software Engineering GmbH Written-by: Albert ARIBAUDA - 3ADEV <albert.aribaud@3adev.fr>
(C) Copyright 2011 Marvell Inc, <www.marvell.com>
Copyright (C) 2015-2017, STMicroelectronics - All Rights Reserved
Copyright (C) 2009 Sergey Kubushyn <ksi@koi8.net>;(C) Copyright 2012 Heiko Schocher, DENX Software Engineering, hs@denx.de.
(C) Copyright 2016 Vikas Manocha, <vikas.manocha@st.com>
(C) Copyright 2015, Samsung Electronics Przemyslaw Marczak <p.marczak@samsung.com>
Copyright 2006,2009 Freescale Semiconductor, Inc.
(C) Copyright 2017 - Beniamino Galvani <b.galvani@gmail.com>
Copyright (c) 2012 The Chromium OS Authors. All rights reserved.
Copyright (C) 2017 Rockchip Electronics Co., Ltd.
(C) Copyright 2017 STMicroelectronics
Copyright (c) 2014 Google, Inc
Copyright (c) 2018 Arm Ltd. Author: Liviu Dudau <liviududau@foss.arm.com>
Copyright (C) 2011, 2013 Renesas Solutions Corp.
Copyright (c) 2016 Rockchip Electronics Co., Ltd
(C) Copyright 2009 Heiko Schocher, DENX Software Engineering, hs@denx.de. Changes for multibus/multiadapter I2C support.:(C) Copyright 2001, 2002 Wolfgang Denk, DENX Software Engineering, wd@denx.de.
(C) Copyright 2016 Songjun Wu <songjun.wu@atmel.com>
(C) Copyright 2004-2010 Texas Instruments, <www.ti.com>
(C) Copyright 2019 Amarula Solutions(India) Author: Jagan Teki <jagan@amarulasolutions.com>
(C) Copyright 2012-2014 Texas Instruments Incorporated, <www.ti.com>;(C) Copyright 2007 Sergey Kubushyn <ksi@koi8.net>
Copyright (C) 2015 Moritz Fischer <moritz.fischer@ettus.com> IP from Cadence (ID T-CS-PE-0007-100, Version R1p10f2)
Copyright (C) 2015 - 2016 Xilinx, Inc.
Copyright (c) 2015 Google, Inc obj-\$(CONFIG_I2C_ARB_GPIO_CHALLENGE) += i2c-arp-gpio-challenge.o obj-\$(CONFIG_\$(SPL_)I2C_MUX) += i2c-mux-uclass.o obj-\$(CONFIG_I2C_MUX_PCA954x) += pca954x.o obj-\$(CONFIG_I2C_MUX_GPIO) += i2c-mux-gpio.o obj-\$(CONFIG_I2C_MUX_IMX_VIRT) += imx_virt_i2c_mux.o
Copyright (C) 2019 Rockchip Electronic Co.,Ltd
Copyright (c) 2018 Rockchip Electronics Co., Ltd
Copyright (c) 2016 Rockchip Electronics Co., Ltd
Copyright (c) 2016 Andreas Färber obj-y += clk_rk3368.o obj-y += rk3368.o obj-y += syscon_rk3368.o
Copyright (C) 2017 Rockchip Electronics Co., Ltd Author: Andy Yan <andy.yan@rock-chips.org>
(C) Copyright 2019 Rockchip Electronics Co., Ltd Kever Yang <kever.yang@rock-chips.com>;(C) Copyright 2013 David Feng <fenghua@phytium.com.cn>;(C) Copyright 2002 Gary Jennejohn, DENX Software Engineering, <garyj@denx.de>;(C) Copyright 2010 Texas Instruments, <www.ti.com> Aneesh V <aneesh@ti.com>
(C) Copyright 2015-2019 Rockchip Electronics Co., Ltd
Copyright (C) 2019 Collabora Inc - <https://www.collabora.com/> Rohan Garg <rohan.garg@collabora.com>;(C) Copyright 2017 Theobroma Systems Design und Consulting GmbH
Copyright (C) 2019 Rockchip Electronic Co.,Ltd
Copyright (C) 2016 Ladislav Michl <ladis@linux-mips.org>
Copyright 1995, 1996, 1998, 1999, 2000, 2003, 2004, 2005 Free Software Foundation, Inc.
(C) Copyright 2010-2012 Texas Instruments, <www.ti.com>
(C) Copyright 2013 David Feng <fenghua@phytium.com.cn>;(C) Copyright 2012 Albert ARIBAUDA <albert.u.boot@aribaud.net>
Copyright (C) 2014 Linaro Ltd. <ard.biesheuvel@linaro.org>
(C) 2014 Linaro Ltd. <ard.biesheuvel@linaro.org>
Copyright (C) 1994-1999 Russell King
Copyright (c) 2013, Google Inc.
"Copyright (c) 1998 Dan Malek <dmalek@jlc.net>"

LICENCE TERMS (cont.)

Copyright (c) 2012 Albert ARIBAUD <albert.u.boot@aribaud.net>
Copyright 2016 NXP Semiconductor, Inc.
Copyright (c) 2015 Andreas Bießmann <andreas@biessmann.org>
(C) Copyright 2013 Albert ARIBAUD <albert.u.boot@aribaud.net> David Feng <fenghua@phytium.com.cn>
(C) Copyright 2009 Wolfgang Denk <wd@denx.de>
(C) Copyright 2015 Freescale Semiconductor
Copyright 2013 Albert ARIBAUD <albert.u.boot@aribaud.net>
Copyright (C) 2011 Corscience GmbH & Co. KG - Simon Schwarz <schwarz@corscience.de> Added prep subcommand support Reorganized source - modeled after powerpc version
(C) Copyright 2013 David Feng <fenghua@phytium.com.cn>
(C) Copyright 2010 Texas Instruments, <www.ti.com> Aneesh V <aneesh@ti.com>
Copyright 1995, 1996, 1998, 1999, 2000, 2003 Free Software Foundation, Inc.
(C) Copyright 2008-2011 Graeme Russ, <graeme.russ@gmail.com>
(C) Copyright 2002 Sysgo Real-Time Solutions, GmbH <www.elinos.com> Marius Groeger <mgroeger@sysgo.de>;(C) Copyright 2002 Sysgo Real-Time Solutions, GmbH <www.elinos.com> Alex Zuepke <azu@sysgo.de>;(C) Copyright 2002 Gary Jennejohn, DENX Software Engineering, <garyj@denx.de>;(C) Copyright 2004 DAVE Srl http://www.dave-tech.it http://www.wawnet.biz mailto:info@wawnet.biz;(C) Copyright 2004 Texas Instruments
Copyright (C) 1995-2000 Russell King
Copyright (c) 2013 Albert ARIBAUD <albert.u.boot@aribaud.net>
Copyright 2010, Google Inc.
Copyright 2014 Broadcom Corporation
Copyright (C) 2009 Samsung Electronics Minkyu Kang <mk7.kang@samsung.com>
Copyright (C) 2010 Samsung Electronics Naveen Krishna Ch <ch.naveen@samsung.com>
Copyright (C) 2009 Samsung Electronics Heungjun Kim <riverful.kim@samsung.com> Inki Dae <inki.dae@samsung.com> Minkyu Kang <mk7.kang@samsung.com>
Copyright 2015 Freescale Semiconductor, Inc. Author: Wang Dongsheng <dongsheng.wang@freescale.com>
Copyright 2016 Freescale Semiconductor, Inc. Author: Hongbo Zhang <hongbo.zhang@nxp.com> This file implements LS102X platform PSCI SYSTEM-SUSPEND function
"(C) Copyright 2012 Henrik Nordstrom <henrik@henriknordstrom.net>;(C) Copyright 2000-2003 Wolfgang Denk, DENX Software Engineering, wd@denx.de. obj-y += timer.o"
Copyright (C) 2016 Author: Chen-Yu Tsai <wens@csie.org>
(C) Copyright 2015 Chen-Yu Tsai <wens@csie.org>
(C) Copyright 2012 Allwinner Technology Co., Ltd. <www.allwinnertech.com> Tom Cubie <tangliang@allwinnertech.com>;(C) Copyright 2002 Gary Jennejohn, DENX Software Engineering, <garyj@denx.de>;(C) Copyright 2010 Texas Instruments, <www.ti.com> Aneesh V <aneesh@ti.com>
"Copyright (c) 2004 Texas Instruments <r-woodruff2@ti.com>"
(C) Copyright 2013 Andre Przywara, Linaro <andre.przywara@linaro.org>
(C) Copyright 2014 stmicroelectronics
(C) Copyright 2008 Texas Instruments, <www.ti.com>
Copyright (C) 2016 Chen-Yu Tsai Author: Chen-Yu Tsai <wens@csie.org>
Copyright (C) 2013 - ARM Ltd Author: Marc Zyngier <marc.zyngier@arm.com>
Copyright (C) 2013,2014 - ARM Ltd Author: Marc Zyngier <marc.zyngier@arm.com>
(C) Copyright 2002 Gary Jennejohn, DENX Software Engineering, <garyj@denx.de>
(C) Copyright 2008 Texas Instruments;(C) Copyright 2002 Sysgo Real-Time Solutions, GmbH <www.elinos.com> Marius Groeger <mgroeger@sysgo.de>;(C) Copyright 2002 Gary Jennejohn, DENX Software Engineering, <garyj@denx.de>
(C) Copyright 2015 Texas Instruments
"Copyright (c) 2013 Andre Przywara <andre.przywara@linaro.org>"
(C) Copyright 2002 Sysgo Real-Time Solutions, GmbH <www.elinos.com> Marius Groeger <mgroeger@sysgo.de>;(C) Copyright 2002 Sysgo Real-Time Solutions, GmbH <www.elinos.com> Alex Zuepke <azu@sysgo.de>;(C) Copyright 2002 Gary Jennejohn, DENX Software Engineering, <gj@denx.de>;(C) Copyright 2009 Ilya Yanok, Emcraft Systems Ltd, <yanok@emcraft.com>;(C) Copyright 2009 DENX Software Engineering Author: John Rigby <jrigby@gmail.com> Add support for MX25
(C) Copyright 2009 DENX Software Engineering Author: John Rigby <jrigby@gmail.com>
(C) Copyright 2002 Sysgo Real-Time Solutions, GmbH <www.elinos.com> Marius Groeger <mgroeger@sysgo.de>;(C) Copyright 2002 Sysgo Real-Time Solutions, GmbH <www.elinos.com> Alex Zuepke <azu@sysgo.de>;(C) Copyright 2002 Gary Jennejohn, DENX Software Engineering, <gj@denx.de>;(C) Copyright 2009 Ilya Yanok, Emcraft Systems Ltd, <yanok@emcraft.com>
(C) Copyright 2011 Ilya Yanok, EmCraft Systems
Copyright (C) 2011 Marek Vasut <marek.vasut@gmail.com> on behalf of DENX Software Engineering GmbH;(C) Copyright 2009-2010 Freescale Semiconductor, Inc.
Copyright 2004-2006,2010 Freescale Semiconductor, Inc. All Rights Reserved.
Copyright (C) 2011 Vladimir Zapolskiy <vz@mleia.com>
Copyright (C) 2011 by Vladimir Zapolskiy <vz@mleia.com>
Copyright (C) 2011-2015 by Vladimir Zapolskiy <vz@mleia.com>
(C) Copyright 2010 Marvell Semiconductor <www.marvell.com> Written-by: Prafulla Wadaskar <prafulla@marvell.com>, Contributor: Mahavir Jain <mjain@marvell.com>
Copyright (C) 2011 Heiko Schocher, DENX Software Engineering, hs@denx.de.
(C) Copyright 2000-2009 Vipin Kumar, ST Microelectronics, vipin.kumar@st.com
(C) Copyright 2006 Vipin Kumar, ST Microelectronics, vipin.kumar@st.com.
(C) Copyright 2000-2009 Vioresh Kumar, ST Microelectronics, vioresh.kumar@st.com Vipin Kumar, ST Microelectronics, vipin.kumar@st.com
(C) Copyright 2002 Sysgo Real-Time Solutions, GmbH <www.elinos.com> Marius Groeger <mgroeger@sysgo.de>;(C) Copyright 2002 Gary Jennejohn, DENX Software Engineering, <garyj@denx.de>
Copyright (c) 2008 Eric Jarrige <eric.jarrige@armadeus.org>
(C) Copyright 2014 Albert ARIBAUD <albert.u.boot@aribaud.net>;(C) Copyright 2002 Gary Jennejohn, DENX Software Engineering, <garyj@denx.de>;(C) Copyright 2010 Texas Instruments, <www.ti.com> Aneesh V <aneesh@ti.com>
(C) Copyright 2004 Texas Instruments;(C) Copyright 2002 Sysgo Real-Time Solutions, GmbH <www.elinos.com> Marius Groeger <mgroeger@sysgo.de>;(C) Copyright 2002 Gary Jennejohn, DENX Software Engineering, <garyj@denx.de>
(C) Copyright 2000-2006 Wolfgang Denk, DENX Software Engineering, wd@denx.de.:(C) Copyright 2008 Guennadi Liakhovetki, DENX Software Engineering, <lg@denx.de>
"Copyright (c) 2007 Samsung Electronics"
Copyright (C) 2009, 2010 Matthias Kaehlcke <matthias@kaehlcke.net>
Copyright (C) 2009 Matthias Kaehlcke <matthias@kaehlcke.net>
Copyright (C) 2010, 2009 Matthias Kaehlcke <matthias@kaehlcke.net>
"Copyright (c) 2001 Marius Gröger <mag@sysgo.de>"
(C) Copyright 2002 Sysgo Real-Time Solutions, GmbH <www.elinos.com> Marius Groeger <mgroeger@sysgo.de>;(C) Copyright 2002 Sysgo Real-Time Solutions, GmbH <www.elinos.com> Alex Zuepke <azu@sysgo.de>;(C) Copyright 2002 Gary Jennejohn, DENX Software Engineering, <garyj@denx.de>
(c) 2004 Sascha Hauer <sascha@saschahauer.de>
Copyright (C) 2011 Marek Vasut <marek.vasut@gmail.com>
"Copyright (C) 1998 Dan Malek <dmalek@jlc.net>"
(C) Copyright 2002 Sysgo Real-Time Solutions, GmbH <www.elinos.com> Marius Groeger <mgroeger@sysgo.de>;(C) Copyright 2002 Sysgo Real-Time Solutions, GmbH <www.elinos.com> Alex Zuepke <azu@sysgo.de>
(C) Copyright 2016 Vasily Khoruzhick <anarsoul@gmail.com>
(C) Copyright 2006 Markus Klotzbuecher, DENX Software Engineering <mk@denx.de>
(C) Copyright 2002 Sysgo Real-Time Solutions, GmbH <www.elinos.com> Marius Groeger <mgroeger@sysgo.de>
(C) Copyright 2007 Sascha Hauer, Pengutronix
(C) Copyright 2000-2006 Wolfgang Denk, DENX Software Engineering, wd@denx.de.:(C) Copyright 2008-2009 Freescale Semiconductor, Inc.
(C) Copyright 2007 Sascha Hauer, Pengutronix;(C) Copyright 2008-2010 Freescale Semiconductor, Inc.
Copyright (C) 2012, Stefano Babic <sbabic@denx.de>
(C) Copyright 2002 Gary Jennejohn, DENX Software Engineering, <garyj@denx.de>;(C) Copyright 2010 Texas Instruments, <www.ti.com> Aneesh V <aneesh@ti.com>
(C) Copyright 2017 NVIDIA Corporation <www.nvidia.com>
(C) Copyright 2014, Cavium Inc.:(C) Copyright 2017, Xilinx Inc.
(C) Copyright 2014-2016, Freescale Semiconductor, Inc.
(C) Copyright 2013-2016, Freescale Semiconductor, Inc.
Copyright 2014-2015, Freescale Semiconductor
Copyright 2014-2015 Freescale Semiconductor
Copyright 2016-2018 NXP

LICENCE TERMS (cont.)

Copyright 2014-2015, Freescale Semiconductor, Inc.
Copyright 2014-2015 Freescale Semiconductor
(C) Copyright 2014-2015 Freescale Semiconductor
(C) Copyright 2013 David Feng <fenghua@phytium.com.cn>;(C) Copyright 2016 Alexander Graf <agraf@suse.de>
(C) Copyright 2013 David Feng <fenghua@phytium.com.cn>;(C) Copyright 2002 Gary Jennejohn, DENX Software Engineering, <garyj@denx.de>
(C) Copyright 2002 Gary Jennejohn, DENX Software Engineering, <garyj@denx.de> PLATFORM_RELFLAGS += -fno-common -ffixed-x18
(C) Copyright 2013 David Feng <fenghua@phytium.com.cn>;(C) Copyright 2002 Gary Jennejohn, DENX Software Engineering, <garyj@denx.de>;(C) Copyright 2010 Texas Instruments, <www.ti.com> Aneesh V <aneesh@ti.com>
Copyright (C) 2015 Linaro. Peter Griffin <peter.griffin@linaro.org>
(C) Copyright 2010,2011 Vladimir Khusainov, Emcraft Systems, vlad@emcraft.com;(C) Copyright 2015 Kamil Lulko, <kamil.lulko@gmail.com>
(C) Copyright 2017 Renesas Electronics Europe Ltd
(C) Copyright 2010-2015 NVIDIA Corporation <www.nvidia.com>
Copyright (c) 2010-2014, NVIDIA CORPORATION. All rights reserved.
(C) Copyright 2012 NVIDIA Inc, <www.nvidia.com>
Copyright (c) 2018-2019, NVIDIA CORPORATION. All rights reserved.
Copyright (c) 2016-2018, NVIDIA CORPORATION.
(C) Copyright 2010-2019 Nvidia Corporation.:(C) Copyright 2000-2008 Wolfgang Denk, DENX Software Engineering, wd@denx.de.
Copyright (c) 2012-2019, NVIDIA CORPORATION. All rights reserved.:(C) Copyright 2002 Sysgo Real-Time Solutions, GmbH <www.elinos.com> Marius Groeger <mgroeger@sysgo.de>;(C) Copyright 2002 Sysgo Real-Time Solutions, GmbH <www.elinos.com> Alex Zuepke <azu@sysgo.de>;(C) Copyright 2002 Gary Jennejohn, DENX Software Engineering, <garyj@denx.de>;(C) Copyright 2004 DAVE Srl http://www.dave-tech.it http://www.wawnet.biz mailto:info@wawnet.biz;(C) Copyright 2004 Texas Instruments
Copyright (c) 2010-2016, NVIDIA CORPORATION.
(C) Copyright 2014 - 2015 Xilinx, Inc. Michal Simek <michal.simek@xilinx.com> This file derived from arch/arm/mach-zynqmp/cpu.c)
Copyright (c) 2013-2014, NVIDIA CORPORATION. All rights reserved.
Copyright (c) 2010-2019, NVIDIA CORPORATION. All rights reserved.
Copyright (c) 2010-2013, NVIDIA CORPORATION. All rights reserved.
Copyright (c) 2014-2015, NVIDIA CORPORATION. All rights reserved.
(C) Copyright 2010, 2011 NVIDIA Corporation <www.nvidia.com>
(C) Copyright 2010 - 2011 NVIDIA Corporation <www.nvidia.com>
(C) Copyright 2010,2011 Nvidia Corporation.
Copyright (c) 2011 The Chromium OS Authors.:(C) Copyright 2010-2015 NVIDIA Corporation <www.nvidia.com>
(C) Copyright 2010 NVIDIA Corporation <www.nvidia.com>
Copyright (c) 2014-2019, NVIDIA CORPORATION. All rights reserved.
Copyright (C) 2014, NVIDIA
(C) Copyright 2010-2014 NVIDIA Corporation <www.nvidia.com>
(C) Copyright 2013-2020 NVIDIA Corporation <www.nvidia.com>
(C) Copyright 2015, Siemens AG Author: Jan Kiszka <jan.kiszka@siemens.com>
(C) Copyright 2020 Cortina Access Inc.
(C) Copyright 2014 - 2017 Xilinx, Inc. Michal Simek
Copyright (C) 2012 - 2013 Michal Simek <monstr@monstr.eu>
Copyright (C) 2013 - 2015 Xilinx, Inc. All rights reserved.
Copyright (C) 2013 Soren Brinkmann <soren.brinkmann@xilinx.com>
Copyright (c) 2013 - 2017 Xilinx Inc.
Copyright (c) 2013 Xilinx Inc.
Copyright (c) 2013 Xilinx, Inc.
(c) Copyright 2010-2017 Xilinx, Inc. All rights reserved.:(c) Copyright 2016 Topic Embedded Products.
Copyright (c) 2014 Xilinx, Inc. Michal Simek
(C) Copyright 2019 Xilinx, Inc. Siva Durga Prasad <siva.durga.paladugu@xilinx.com>
Copyright 2016 - 2018 Xilinx, Inc.
Copyright (C) 2014-2016 Stefan Roese <sr@denx.de>
Copyright (C) Marvell International Ltd. and its affiliates Written-by: Prafulla Wadaskar <prafulla@marvell.com>

Copyright (C) 2015-2016 Reinhard Pfau <reinhard.pfau@gdsys.cc>
(C) Copyright 2008 Marvell Semiconductor
Copyright (C) 2015 Reinhard Pfau <reinhard.pfau@gdsys.cc>
(C) Copyright 2016 Beniamino Galvani <b.galvani@gmail.com>;(C) Copyright 2018 Neil Armstrong <narmstrong@baylibre.com>
Copyright (c) 2016 Beniamino Galvani <b.galvani@gmail.com>
(C) Copyright 2019 Julien Masson <jmasson@baylibre.com>;(C) Copyright 2019 Neil Armstrong <narmstrong@baylibre.com>
Copyright (c) 2010 Samsung Electronics. Minkyu Kang <mk7.kang@samsung.com>
Copyright (C) 2013 Samsung Electronics Rajeshwari Shinde <rajeshwari.s@samsung.com>
Copyright (C) 2013 Samsung Electronics Akshay Saraswat <akshay.s@samsung.com>
Copyright (c) 2012 Samsung Electronics. Abhilash Kesavan <a.kesavan@samsung.com>
Copyright (C) Albert ARIBAUD <albert.u.boot@aribaud.net>
(C) Copyright 2010 Samsung Electronics Minkyu Kang <mk7.kang@samsung.com> MyungJoo Ham <myungjoo.ham@samsung.com>
Copyright (C) 2010 Samsung Electronics Minkyu Kang <mk7.kang@samsung.com>
Copyright (C) 2010 Samsung Electronics Rajeshwari Shinde <rajeshwari.s@samsung.com>
(C) Copyright 2008 Texas Instruments;(C) Copyright 2002 Sysgo Real-Time Solutions, GmbH <www.elinos.com> Marius Groeger <mgroeger@sysgo.de> Alex Zuepke <azu@sysgo.de>;(C) Copyright 2002 Gary Jennejohn, DENX Software Engineering, <garyj@denx.de>
Copyright (C) 2012 Ilya Yanok <ilya.yanok@gmail.com>
Copyright (C) 2004-2010 Texas Instruments Incorporated - http://www.ti.com/
(C) Copyright 2011, Ilya Yanok, Emcraft Systems
(C) Copyright 2011 Texas Instruments, <www.ti.com>
(C) Copyright 2016-2017 Texas Instruments, <www.ti.com>
Copyright (C) 2016, Texas Instruments, Incorporated - http://www.ti.com/ quiet_cmd_mkomapsecimg = SECURE \$@ ifneq (\$(TI_SECURE_DEV_PKG),) ifneq (\$(wildcard \$(TI_SECURE_DEV_PKG)/scripts/create-boot-image.sh),) ifneq (\$(CONFIG_SPL_BUILD),) cmd_mkomapsecimg = \$(TI_SECURE_DEV_PKG)/scripts/create-boot-image.sh
Copyright (C) 2012 Texas Instruments Incorporated - http://www.ti.com/ Nishanth Menon
(C) Copyright 2000-2010 Wolfgang Denk, DENX Software Engineering, wd@denx.de.
Copyright 2011 Linaro Limited Aneesh V <aneesh@ti.com>
Copyright 2016 Texas Instruments, Inc.
Copyright (C) 2017, Konsulko Group
Copyright (C) 2016, Texas Instruments, Incorporated - http://www.ti.com/
Copyright 2016-2017 Texas Instruments, Inc.
Copyright (C) 2010 Renesas Solutions Corp.
Copyright (C) 2011 Renesas Solutions Corp.
Copyright (C) 2012 Nobuhiro Iwamatsu <nobuhiro.iwamatsu.yj@renesas.com>
Copyright (C) 2012 Renesas Solutions Corp.
(C) Copyright 2015 Renesas Electronics Corporation;(C) Copyright 2013 David Feng <fenghua@phytium.com.cn>
Copyright (C) 2014 Nobuhiro Iwamatsu <nobuhiro.iwamatsu.yj@renesas.com>
Copyright (C) 2013-2017 Renesas Electronics Corporation
Copyright (C) 2013, 2014 Nobuhiro Iwamatsu <nobuhiro.iwamatsu.yj@renesas.com>
Copyright (C) 2013 Atmel Corporation Bo Shen <voice.shen@atmel.com>
(C) Copyright 2000-2008 Wolfgang Denk, DENX Software Engineering, wd@denx.de.:(C) Copyright 2013 Bo Shen <voice.shen@atmel.com>
(C) Copyright 2007-2008 Stelian Pop <stelian@popies.net> Lead Tech Design <www.leadtechdesign.com>;(C) Copyright 2013 Bo Shen <voice.shen@atmel.com>
Copyright (C) 2005 David Brownell
Copyright (C) 2012-2013 Atmel Corporation Bo Shen <voice.shen@atmel.com>
(C) Copyright 2010 Reinhard Meyer, reinhard.meyer@emk-elektronik.de;(C) Copyright 2009 Jean-Christophe PLAGNIOL-VILLARD <plagnioj@jcrosoft.com>;(C) Copyright 2013 Bo Shen <voice.shen@atmel.com>
(C) Copyright 2002 Gary Jennejohn, DENX Software Engineering, <garyj@denx.de>;(C) Copyright 2010 Texas Instruments, <www.ti.com> Aneesh V <aneesh@ti.com>;(C) 2013 Atmel Corporation Bo Shen <voice.shen@atmel.com>
Copyright (C) 1999 2000 2001 Erik Mouw (J.A.K.Mouw@its.tudelft.nl) and Jan-Derk Bakker (J.D.Bakker@its.tudelft.nl)

LICENCE TERMS (cont.)

nl)
(C) Copyright 2007-2008 Stelian Pop <stelian@popies.net> Lead Tech Design <www.leadtechdesign.com>;(C) Copyright 2009-2011 Daniel Gorsulowski <daniel.gorsulowski@esd.eu> esd electronic system design gmbh <www.esd.eu>
(C) Copyright 2010 Reinhard Meyer, reinhard.meyer@emk-elektronik.de;(C) Copyright 2009 Jean-Christophe PLAGNIOL-VILLARD <plagnioj@jrcrosoft.com>
(C) Copyright 2010 Reinhard Meyer, EMK Elektronik, reinhard.meyer@emk-elektronik.de
Copyright (C) 2015 Atmel Corporation Bo Shen <voice.shen@atmel.com>
(C) Copyright 2014 Heiko Schocher, DENX Software Engineering, hs@denx.de.:(C) Copyright 2007-2008 Stelian Pop <stelian@popies.net> Lead Tech Design <www.leadtechdesign.com>
Copyright (C) 2013 Atmel Corporation Bo Shen <voice.shen@atmel.com>
(C) Copyright 2014 DENX Software Engineering Heiko Schocher <hs@denx.de>
(C) Copyright 2011 Andreas Bießmann <andreas@biessmann.org>;(C) Copyright 2007-2008 Stelian Pop <stelian@popies.net> Lead Tech Design <www.leadtechdesign.com>
(C) Copyright 2002 Lineo, Inc. <www.lineo.com> Bernhard Kuhn <bkuhn@lineo.com>;(C) Copyright 2002 Sysgo Real-Time Solutions, GmbH <www.elinos.com> Marius Groeger <mgroeger@sysgo.de>;(C) Copyright 2002 Sysgo Real-Time Solutions, GmbH <www.elinos.com> Alex Zuepke <azu@sysgo.de>
Copyright (C) 1999 2000 2001 Erik Mouw (J.A.K.Mouw@its.tudelft.nl) and Jan-Derk Bakker (J.D.Bakker@its.tudelft.nl);(C) Copyright 2004 Gary Jennejohn, DENX Software Engineering, <garyj@denx.de>
Copyright (C) 2011 Andreas Bießmann
(C) Copyright 2011 Andreas Bießmann, andreas@biessmann.org;(C) Copyright 2010 Reinhard Meyer, reinhard.meyer@emk-elektronik.de;(C) Copyright 2009 Jean-Christophe PLAGNIOL-VILLARD <plagnioj@jrcrosoft.com>
Copyright (C) 2005 Ivan Kokshaysky
Copyright (C) 2009 Jean-Christophe PLAGNIOL-VILLARD <plagnioj@jrcrosoft.com>
Copyright (C) 2006 Atmel Corporation.
Copyright (C) 2010 Reinhard Meyer, reinhard.meyer@emk-elektronik.de
Copyright (C) 2007 Andrew Victor
Copyright (C) 2012-2013 Atmel Corporation.
Copyright (C) 2009 Jens Scharis (js_at_ng@scharsoft.de)
Copyright (C) 2015 Atmel Wenyong Yang <wenyong.yang@atmel.com>
Copyright (C) 2009 Jean-Christophe PLAGNIOL-VILLARD <plagnioj@jrcrosoft.com>
(C) 2008 Atmel Corporation.
Copyright (C) 2012 Atmel Corporation.
(C) 2007 Atmel Corporation.:(C) Copyright 2010 Reinhard Meyer, EMK Elektronik, reinhard.meyer@emk-elektronik.de
Copyright (C) 2008 Atmel Corporation.
Copyright (C) 2015 Atmel Corporation. Wenyong Yang <wenyong.yang@atmel.com>
(C) 2006 Andrew Victor;(C) Copyright 2010 Reinhard Meyer, EMK Elektronik, reinhard.meyer@emk-elektronik.de
Copyright (C) 2007 Atmel Corporation.
Copyright (c) 2015 Atmel Corporation Wenyong.Yang <wenyong.yang@atmel.com>
Copyright (C) SAN People;(C) Copyright 2010 Reinhard Meyer, EMK Elektronik, reinhard.meyer@emk-elektronik.de
Copyright (C) 2017 Microchip Corporation.
(C) Copyright 2007 Stelian Pop <stelian@popies.net> Lead Tech Design <www.leadtechdesign.com>
(C) 2012 - 2013 Atmel Corporation. Bo Shen <voice.shen@atmel.com>
Copyright (C) 2005 HP Labs
Copyright (c) 2016 Marek Vasut <marex@denx.de>
Copyright (C) 2018 MediaTek Inc.
Copyright (C) 1994-2013 Russell King
Copyright 2019 Broadcom
Copyright (C) 2011, Texas Instruments Incorporated - http://www.ti.com/
Copyright (C) 2010 Texas Instruments
Copyright (C) 2017 Grinn
Copyright (C) 2013, Adeneo Embedded <www.adeneo-embedded.com> Antoine Tenart, <atenart@adeneo-embedded.com> Based on TI-PSP-04.00.02.14
Copyright 2016 Broadcom Corporation.
Copyright (c) 2014-2015 NVIDIA CORPORATION. All rights reserved.
Copyright (C) 1997-1999 Russell King
Copyright 2014, Freescale Semiconductor
Copyright 2014-2015, Freescale Semiconductor, Inc.
Copyright 2015-2019 NXP
Copyright 2015, Freescale Semiconductor
Copyright 2017 NXP Semiconductor, Inc.
Copyright 1995, Russell King. Various bits and pieces copyrights include: Linus Torvalds (test_bit).
Copyright (C) 1996-2000 Russell King
Copyright (C) 2012 ARM Limited
Copyright (C) 2011 Freescale Semiconductor, Inc. All Rights Reserved.
Copyright (C) 2012-2015 Freescale Semiconductor, Inc. All Rights Reserved.
(C) Copyright 2009 Stefano Babic, DENX Software Engineering, sbabic@denx.de.
Copyright (C) 2009 by Jan Weitzel Phytex Messtechnik GmbH, armlinux@phytec.de>
Copyright (C) 2012 Anatolij Gustschin, DENX Software Engineering, <agust@denx.de>
Copyright (C) 2011 Stefano Babic, DENX Software Engineering, <sbabic@denx.de>
Copyright (C) 1996 Russell King
Copyright (C) 1996-1999 Russell King
Copyright (C) 1999 Russell King.
Copyright (C) 1996-1999 Russell King.
Copyright (C) 2008 ARM Limited
(C) Copyright 2007 Stelian Pop <stelian@popies.net> Lead Tech Design <www.leadtechdesign.com>
Copyright (C) 2009-2010 Amit Kucheria <amit.kucheria@canonical.com>
Copyright (c) 1996 Russell King.
Copyright (C) 2012 Robert Delien <robert@delien.nl>
Copyright (C) 2013 Andreas Wass <andreas.wass@dalelven.com>
Copyright (C) 2012 Marek Vasut <marek.vasut@gmail.com> on behalf of DENX Software Engineering GmbH
Copyright 2019 Rockchip Electronics Co., Ltd.
(C) Copyright 2014 Freescale Semiconductor, Inc.
(C) Copyright 2017 Theobroma Systems Design und Consulting GmbH;(C) Copyright 2016 Alexander Graf <agraf@suse.de>
Copyright (C) 2012 Freescale Semiconductor, Inc. All Rights Reserved.
Copyright (C) 2013 Boundary Devices Inc.
Copyright 2011 Freescale Semiconductor, Inc. All Rights Reserved.
Copyright (C) 2013 Freescale Semiconductor, Inc. All Rights Reserved.
Copyright (C) 2011-2013 Freescale Semiconductor, Inc. All Rights Reserved.
Copyright (C) 2014 - 2016 Freescale Semiconductor, Inc.
Copyright (C) 2016 Grinn
(C) Copyright 2011 Alexander Holler <holler@ahsoftware.de>
(C) Copyright 2006-2008 Texas Instruments, <www.ti.com> Syed Mohammed Khasim <x0khasim@ti.com>
(C) Copyright 2008 Texas Instruments, <www.ti.com> Syed Mohammed Khasim <khasim@ti.com>
(C) Copyright 2012 Ilya Yanok, <ilya.yanok@gmail.com>
(C) Copyright 2004-2008 Texas Instruments, <www.ti.com> Richard Woodruff <r-woodruff2@ti.com>
(C) Copyright 2006-2008 Texas Instruments, <www.ti.com> Richard Woodruff <r-woodruff2@ti.com>
(c) 2011 Comelit Group SpA, Luca Ceresoli <luca.ceresoli@comelit.it>
(C) Copyright 2006-2008 Texas Instruments, <www.ti.com> Richard Woodruff <r-woodruff2@ti.com> Syed Mohammed Khasim <x0khasim@ti.com>
(C) Copyright 2016 Michael Kurz, michi.kurz@gmail.com.
(C) Copyright 2006-2010 Texas Instruments, <www.ti.com>
"(C) Copyright 2004-2009 Texas Instruments Incorporated Richard Woodruff <r-woodruff2@ti.com> Aneesh V <aneesh@ti.com> Balaji Krishnamoorthy <balajitk@ti.com>"
Copyright (C) 2018 Rockchip Electronics Co., Ltd
(C) Copyright 2017 Rockchip Electronics Co., Ltd Author: Andy Yan <andy.yan@rock-chips.com>
Copyright 2017 Theobroma Systems Design und Consulting GmbH
Copyright (C) 2017 Fuzhou Rockchip Electronics Co., Ltd author: Eric Gao <eric.gao@rock-chips.com>
(C) Copyright 2019 Amarula Solutions. Author: Jagan Teki <jagan@amarulasolutions.com>
Copyright (C) 2016-2017 Rockchip Electronics Co., Ltd
(C) Copyright 2016 Google, Inc;(C) Copyright 2008-2014 Rockchip Electronics
(C) Copyright 2016 Rockchip Electronics Co., Ltd;(C) Copyright 2017 Theobroma Systems Design und Consulting

LICENCE TERMS (cont.)

GmbH

Copyright (C) 2019 Collabora Inc - <https://www.collabora.com/> Rohan Garg <rohan.garg@collabora.com>
(C) Copyright 2016 Rockchip Electronics Co.,Ltd
(C) Copyright 2016 Heiko Stuebner <heiko@sntech.de>
(C) Copyright 2017 Heiko Stuebner <heiko@sntech.de>;(C) Copyright 2017 Theobroma Systems Design und Consulting GmbH
Copyright (C) 2009-2010 Texas Instruments, Inc.
(C) Copyright 2015-2016, Freescale Semiconductor, Inc.
Copyright (c) 2011, Google Inc. All rights reserved.
"Copyright (c) Marc A. Viredaz, 1998 DEC Western Research Laboratory, Palo Alto, CA Date April 1998 (April 1997)
System Advanced RISC Machine (ARM) Language C or ARM Assembly Purpose Definition of macros to operate on bit fields."
Copyright 2004-2009 Freescale Semiconductor, Inc.
(C) Copyright 2007 Marvell Semiconductor <www.marvell.com> 2007-08-21: eric miao <eric.miao@marvell.com>;(C) Copyright 2010 Marvell Semiconductor <www.marvell.com> Written-by: Prafulla Wadaskar <prafulla@marvell.com>
Contributor: Mahavir Jain <mjain@marvell.com>
(C) Copyright 2010 Linaro Matt Waddel, <matt.waddel@linaro.org>
(C) Copyright 2010 Matt Waddel, <matt.waddel@linaro.org>
(C) Copyright 2014 Albert ARIBAUD <albert.u.boot@aribaud.net>
Copyright (C) 2012 Linaro Limited
Copyright (C) 2015 Toradex, Inc.
(C) Copyright 2015 DENX Software Engineering GmbH Written-by: Sylvain Lemieux <slemieux@tycoint.com>
(C) Copyright 2015 DENX Software Engineering GmbH Written-by: Albert ARIBAUD <albert.aribaud@3adev.fr>
Copyright (C) 2008 by NXP Semiconductors Author: Kevin Wells Descr: Definitions for LPC3250 chip References: NXP LPC3250 User's Guide
Copyright (C) 2013 Texas Instruments Incorporated - <http://www.ti.com>* Author: Govindraj R <govindraj.raja@ti.com>
(C) Copyright 2013 Texas Instruments Incorporated
(C) Copyright 2015 Texas Instruments Incorporated
Copyright (C) 2011 Texas Instruments Incorporated - <http://www.ti.com>* Author: Govindraj R <govindraj.raja@ti.com>
Copyright (C) 2000-2002 Russell King
Copyright (C) 1996-1998 Russell King.
Copyright (C) 2009, DENX Software Engineering Author: John Rigby <jcrigby@gmail.com>
(c) 2009 Ilya Yanok, Emcraft Systems <yanok@emcraft.com>
Copyright (C) 2012, Ilya Yanok <ilya.yanok@gmail.com>
(C) Copyright 2011 Yuri Tikhonov, Emcraft Systems, yur@emcraft.com;(C) Copyright 2015 Kamil Lulko, <kamil.lulko@gmail.com>
Copyright (c) 2009 Ilya Yanok <yanok@emcraft.com>
(c) 2007 Pengutronix, Sascha Hauer <s.hauer@pengutronix.de>;(c) 2009 Ilya Yanok, Emcraft Systems <yanok@emcraft.com>
Copyright (C) 2006-2014 Texas Instruments.
Copyright 2010-2011 NVIDIA Corporation
Copyright (c) 2019 NVIDIA Corporation. All rights reserved.
(C) Copyright 2015 NVIDIA Corporation <www.nvidia.com>
Copyright (c) 2014-2016, NVIDIA CORPORATION.
(C) Copyright 2009 SAMSUNG Electronics Minkyu Kang <mk7.kang@samsung.com>
(C) Copyright 2010-2019 NVIDIA Corporation <www.nvidia.com>
Copyright (C) 1995-2002 Russell King
Copyright (C) 2016 BayLibre, SAS Author: Maxime Jourdan <mjourdan@baylibre.com>
Copyright 2017 - Beniamino Galvani <b.galvani@gmail.com>
Copyright 2016 - AmLogic, Inc.
(C) Copyright 2013-2016, NVIDIA CORPORATION.
(C) Copyright 2007-2013 Allwinner Technology Co., Ltd. <www.allwinnertech.com> CPL <cplanxy@allwinnertech.com> Jerry Wang <wangflord@allwinnertech.com>;(C) Copyright 2014 Hans de Goede <hdegoede@redhat.com>
(C) Copyright 2007-2015 Allwinner Technology Co. Jerry Wang <wangflord@allwinnertech.com>;(C) Copyright 2015 Vishnu Patekar <vishnupatekar0510@gmail.com>;(C) Copyright 2014-2015 Hans de Goede <hdegoede@redhat.com>

com>

(C) Copyright 2015 Hans de Goede <hdegoede@redhat.com>;(C) Copyright 2007-2013 Allwinner Technology Co., Ltd. <www.allwinnertech.com> Jerry Wang <wangflord@allwinnertech.com>
(C) Copyright 2007-2012 Allwinner Technology Co., Ltd. <www.allwinnertech.com> Berg Xing <bergxing@allwinnertech.com> Tom Cubie <tangliang@allwinnertech.com>
(C) Copyright 2014 Hans de Goede <hdegoede@redhat.com>;(C) Copyright 2017 Jernej Skrabec <jernejskrabec@siol.net>
(C) Copyright 2007-2011 Allwinner Technology Co., Ltd. <www.allwinnertech.com> Tom Cubie <tangliang@allwinnertech.com>;(C) Copyright 2015 Vishnu Patekar <vishnupatekar0510@gmail.com> from sun6i.h
(C) Copyright 2015 Roy Spliet <rspliet@ultimaker.com>
(c) Copyright 2013 Oliver Schinagl <oliver@schinagl.nl> <http://linux-sunxi.org>
(C) Copyright 2016 Hans de Goede <hdegoede@redhat.com>
Copyright 2014 - Hans de Goede <hdegoede@redhat.com>
(C) Copyright 2007-2012 Allwinner Technology Co., Ltd. <www.allwinnertech.com> Tom Cubie <tangliang@allwinnertech.com>
(C) Copyright 2013 Oliver Schinagl <oliver@schinagl.nl> <http://linux-sunxi.org> Allwinner Technology Co., Ltd. <www.allwinnertech.com> Berg Xing <bergxing@allwinnertech.com> Tom Cubie <tangliang@allwinnertech.com>
(C) Copyright 2007-2015 Allwinner Technology Co. Jerry Wang <wangflord@allwinnertech.com>;(C) Copyright 2016 Theobroma Systems Design und Consulting GmbH Philipp Tomsich <philipp.tomsich@theobroma-systems.com>
(C) Copyright 2014 Hans de Goede <hdegoede@redhat.com>
(C) Copyright 2007-2015 Allwinner Technology Co. Jerry Wang <wangflord@allwinnertech.com>;(C) Copyright 2015 Vishnu Patekar <vishnupatekar0510@gmail.com>;(C) Copyright 2014-2015 Hans de Goede <hdegoede@redhat.com>;(C) Copyright 2015 Jens Kuske <jenskuske@gmail.com>
(C) Copyright 2017 Jernej Skrabec <jernejskrabec@siol.net>
Copyright 2019 Amarula Solutions, BV Written by Michael Trimarchi <michael@amarulasolutions.com>
Copyright (C) 2012 Lukasz Dalek <luk0104@gmail.com>
Copyright (C) 2014 Andrew Ruder <andrew.ruder@elecsyscorp.com>
Copyright (C) 2009 Jean-Christophe PLAGNIOL-VILLARD <plagnioj@jcrosoft.com>
(C) Copyright 2009 Ryan CHEN, ST Micoelectronics, ryan.chen@st.com
Copyright (C) 2009, STMicroelectronics - All Rights Reserved Author(s): Vipin Kumar, <vipin.kumar@st.com> for STMicroelectronics.
Copyright (C) 2010, STMicroelectronics - All Rights Reserved Author(s): Vipin Kumar, <vipin.kumar@st.com> for STMicroelectronics.
Copyright (C) 2015 Freescale Semiconductor, Inc. All Rights Reserved.
Copyright (C) 2001 - 2007 Tensilica Inc.
(C) Copyright 2008 - 2013 Tensilica Inc.:(C) Copyright 2014 - 2016 Cadence Design Systems Inc.
(C) Copyright 2008 - 2013 Tensilica Inc.:(C) Copyright 2014 Cadence Design Systems Inc.
(C) Copyright 2008 - 2013 Tensilica Inc.
(C) Copyright 2007 - 2013 Tensilica, Inc.:(C) Copyright 2014 - 2016 Cadence Design Systems Inc.
(C) Copyright 2008 - 2013 Tensilica, Inc.:(C) Copyright 2014 - 2016 Cadence Design Systems Inc.
Copyright (C) 1999-2007 Tensilica Inc.
Copyright (C) 2001 - 2007 Tensilica Inc.
Copyright (C) 2001 - 2012 Tensilica Inc.
Copyright (C) 2001-2007 Tensilica Inc. Based on the Linux/Xtensa version of this header.
Copyright (C) 1999-2015 Cadence Design Systems Inc.
Copyright (C) 1999-2015 Tensilica Inc.
Copyright (C) 1999-2010 Tensilica Inc.
(C) Copyright 2007 Tensilica, Inc.:(C) Copyright 2014 - 2016 Cadence Design Systems Inc.
(C) Copyright 2008, Tensilica Inc.
Copyright (C) 2005 - 2013 Tensilica Inc.
Copyright (C) 2008-2013 Tensilica Inc.
Copyright (C) 2006 Tensilica Inc.
Copyright (C) 1997 Tensilica Inc.
Copyright (C) 2009 Tensilica Inc.
Copyright (C) 2007, Tensilica Inc.
Copyright (C) 2009 Tensilica Inc.
Copyright (c) 2006 Tensilica, Inc. All Rights Reserved.

LICENCE TERMS (cont.)

Copyright (C) 2001 - 2009 Tensilica Inc.
(C) Copyright 2007, Tensilica Inc.
Copyright (c) 2011 The Chromium OS Authors.:(C) Copyright 2002-2006 Wolfgang Denk, DENX Software Engineering, wd@denx.de.
Copyright (c) 2011 The Chromium OS Authors. Use of this source code is governed by a BSD-style license that can be found in the LICENSE file.
Copyright (c) 2011-2012 The Chromium OS Authors.
Copyright (c) 2011 The Chromium OS Authors.:(C) Copyright 2000-2003 Wolfgang Denk, DENX Software Engineering, wd@denx.de.
Copyright (c) 2015-2018 National Instruments
Copyright (c) 2011-2012 The Chromium OS Authors. Use of this source code is governed by a BSD-style license that can be found in the LICENSE file.
Copyright 2020 Google LLC
(C) 2018 Google, Inc Written by Simon Glass <sjg@chromium.org>
Copyright (c) 2011 The Chromium OS Authors.:(C) Copyright 2002 Sysgo Real-Time Solutions, GmbH <www.elinos.com> Marius Groeger <mgroeger@sysgo.de>;(C) Copyright 2002 Sysgo Real-Time Solutions, GmbH <www.elinos.com> Alex Zuepke <azu@sysgo.de>
Copyright (c) 2011 The Chromium OS Authors.:(C) Copyright 2002-2010 Wolfgang Denk, DENX Software Engineering, wd@denx.de.
Copyright (C) 1994, 1995, 1997, 1998, 1999, 2000, 2001, 2002, 2003, 2004, 2005 Free Software Foundation, Inc.
Copyright (c) 2007 Nobuhiro Iwamatsu <iwamatsu@nigauri.org>
Copyright (C) 1994, 1995, 1997, 1998, 1999, 2000, 2001, 2002, 2003, 2004, 2005, 2006 Free Software Foundation, Inc.
(C) Copyright 2010 Renesas Solutions Corp. Nobuhiro Iwamatsu <nobuhiro.iwamatsu.yj@renesas.com>
Copyright (C) 2016 Vladimir Zapolskiy <vz@mleia.com>
(C) Copyright 2003 Wolfgang Denk, DENX Software Engineering, wd@denx.de.:(c) Copyright 2008 Nobuhiro Iwamatsu <iwamatsu.nobuhiro@renesas.com>;(c) Copyright 2008 Renesas Solutions Corp.
(C) Copyright 2009 Jean-Christophe PLAGNIOL-VILLARD <plagnioj@jcrossoft.com>;(C) Copyright 2007-2012 Nobuhiro Iwamatsu <iwamatsu@nigauri.org>;(C) Copyright 2003 Wolfgang Denk, DENX Software Engineering, wd@denx.de.
Copyright (C) 2007,2008 Nobuhiro Iwamatsu <iwamatsu@nigauri.org>
Copyright (C) 2016 Vladimir Zapolskiy <vz@mleia.com>
Copyright (C) 2006 Free Software Foundation, Inc.
(C) Copyright 2000-2006 Wolfgang Denk, DENX Software Engineering, wd@denx.de.:(C) Copyright 2007 Nobuhiro Iwamatsu <iwamatsu@nigauri.org>
(C) Copyright 2016 Vladimir Zapolskiy <vz@mleia.com>;(C) Copyright 2007 Nobuhiro Iwamatsu <iwamatsu@nigauri.org>
(C) Copyright 2007 Nobuhiro Iwamatsu <iwamatsu@nigauri.org>
(C) Copyright 2000-2004 Wolfgang Denk, DENX Software Engineering, wd@denx.de.:(C) Copyright 2007 Nobuhiro Iwamatsu <iwamatsu@nigauri.org>
Copyright (C) 1999, 2000 Niibe Yutaka & Kaz Kojima
Copyright (C) 1999, 2000 Niibe Yutaka from linux kernel code.
(C) Copyright 2007,2008 Nobuhiro Iwamatsu <iwamatsu@nigauri.org>
(C) Copyright 2008 Renesas Solutions Corp.
Copyright (c) 2007,2008 Nobuhiro Iwamatsu
Copyright (C) 1999 Niibe Yutaka But consider these trivial functions to be public domain.
(C) Copyright 2008, 2011 Renesas Solutions Corp.
(C) Copyright 2002-2010 Wolfgang Denk, DENX Software Engineering, wd@denx.de.:(C) Copyright 2007 Nobuhiro Iwamatsu <iwamatsu@nigauri.org>
(C) Copyright 2007 Michal Simek;(C) Copyright 2004 Atmark Techno, Inc.
(C) Copyright 2013 - 2014 Xilinx, Inc
(C) Copyright 2004 Atmark Techno, Inc.
(C) Copyright 2007-2008 Michal Simek Michal SIMEK <monstr@monstr.eu>;(C) Copyright 2004 Atmark Techno, Inc. Yasushi SHOJI <yashi@atmark-techno.com>
"Copyright (C) 2003 John Williams (jwilliams@itee.uq.edu.au) based upon microblaze version"
Copyright (C) 2003 John Williams <jwilliams@itee.uq.edu.au>
Copyright 1992, Linus Torvalds.

Copyright (C) 2011 Michal Simek <monstr@monstr.eu>
Copyright (C) 2012 Andes Technology Corporation Shawn Lin, Andes Technology Corporation <nobuhiro@andestech.com> Macpaul Lin, Andes Technology Corporation <macpaul@andestech.com>
Copyright (C) 2011 Andes Technology Corporation Rick Chen, Andes Technology Corporation <rick@andestech.com>
(C) Copyright 2002 Sysgo Real-Time Solutions, GmbH <www.elinos.com> Alex Zuepke <azu@sysgo.de>
(C) Copyright 2002 Sysgo Real-Time Solutions, GmbH <www.elinos.com> Marius Groeger <mgroeger@sysgo.de>
"Copyright (C) 2006 Andes Technology Corporation"
(C) Copyright 2000-2002 Wolfgang Denk, DENX Software Engineering, wd@denx.de.:(C) Copyright 2011 Shawn Lin, Andes Technology Corporation <nobuhiro@andestech.com> Macpaul Lin, Andes Technology Corporation <macpaul@andestech.com>
Copyright (C) 2011 Andes Technology Corporation
Copyright (C) 1997-1999 Russell King
Copyright 1995, Russell King. Various bits and pieces copyrights include: Linus Torvalds (test_bit).
Copyright (C) 1996-2000 Russell King
Copyright (C) 2013 Andes Technology Corporation Ken Kuo, Andes Technology Corporation <ken_kuo@andestech.com>
Copyright (C) 2011 Andes Technology Corporation Nobuhiro Lin, Andes Technology Corporation <nobuhiro@andestech.com> Macpaul Lin, Andes Technology Corporation <macpaul@andestech.com>
Copyright (C) 2016 Andes Technology Corporation Nobuhiro Lin, Andes Technology Corporation <nobuhiro@andestech.com> Macpaul Lin, Andes Technology Corporation <macpaul@andestech.com>
Copyright (C) 1996-1998 Russell King.
Copyright (C) 1995-2002 Russell King
Copyright (C) 2013 Altera Corporation
Copyright (C) 2015 Altera Corporation
Copyright (C) 1991, 1992, 1994, 1995, 1996, 1997, 1998, 1999, 2000, 2004, 2005 Free Software Foundation, Inc.
(C) Copyright 2004 Psyent Corporation <www.psyent.com> Scott McNutt <smcnutt@psyent.com>
Copyright (C) 2015-2016, 2020 Synopsys, Inc. (www.synopsys.com)
Copyright (C) 2015 Synopsys, Inc. (www.synopsys.com)
Copyright (C) 1989-2013 Free Software Foundation, Inc.
Copyright (C) 1995, 1997, 2007-2013 Free Software Foundation, Inc.
Copyright (C) 2013-2015 Synopsys, Inc. All rights reserved.
Copyright (C) 2013-2014, 2018 Synopsys, Inc. All rights reserved.
Copyright (C) 2004, 2007-2010, 2011-2012 Synopsys, Inc. All rights reserved.
Copyright (C) 2013-2014, 2020 Synopsys, Inc. All rights reserved.
Copyright (C) 2018 Synopsys Author: Eugeniy Paltsev <Eugeniy.Paltsev@synopsys.com>
Copyright (C) 2004, 2007-2010, 2011-2015 Synopsys, Inc. All rights reserved.
Copyright (C) 2014 Synopsys, Inc. All rights reserved.
Copyright 2013 Freescale Semiconductor Inc.
Copyright 2012 - 2015 Freescale Semiconductor Inc.
Copyright 2013 - 2015 Freescale Semiconductor Inc.
Copyright 2012 Freescale Semiconductor Inc.
Copyright 2006 - 2012 Freescale Semiconductor Inc.
Copyright (C) 2019 Heiko Schocher, DENX Software Engineering, hs@denx.de
Copyright 2011 - 2015 Freescale Semiconductor Inc.
Copyright 2010 - 2015 Freescale Semiconductor Inc.
(C) Copyright 2014 Dirk Eibach, Guntermann & Drunck GmbH, eibach@gdsys.de
Copyright (c) 2008 Emcraft Systems. Sergei Poselenov, <sposelenov@emcraft.com>
Copyright 2011 Freescale Semiconductor Inc.
Copyright (C) 1996 Paul Mackerras.
Copyright 2012 Stefan Roese <sr@denx.de>
(C) Copyright 2000, 2001 Erik Theisen, Wave 7 Optics, etheisen@mindspring.com. base on code by Wolfgang Denk, DENX Software Engineering, wd@denx.de.
copyrights are as follows.:(C) Copyright 1995-1996 Gary Thomas (gdt@linuxppc.org)
Copyright (C) 1998 Dan Malek <dmalek@jlc.net>
Copyright (C) 2009 Wolfgang Denk <wd@denx.de>
(C) Copyright 2000-2002 Wolfgang Denk, DENX Software Engineering, wd@denx.de.:(C) Copyright 2003 Gleb

LICENCE TERMS (cont.)

Natapov <gnatapov@mrv.com>
Copyright (C) 1999 Magnus Damm <klaraypc01.p.y.kie.era.ericsson.se>;(C) Copyright 2000 Wolfgang Denk, DENX Software Engineering, wd@denx.de.
(C) Copyright 2006 Wolfgang Denk, DENX Software Engineering, wd@denx.de.:(C) Copyright 2002,2003 Motorola Inc. Xianghua Xiao,X.Xiao@motorola.com
Copyright 2008-2012 Freescale Semiconductor, Inc. Kumar Gala <kumar.gala@freescale.com>
Copyright 2004, 2007-2012 Freescale Semiconductor, Inc.
Copyright 2011 Freescale Semiconductor, Inc. Author: Prabhakar Kushwaha <prabhakar@freescale.com>
Copyright (c) 2003 Motorola,Inc. Xianghua Xiao, (X.Xiao@motorola.com)
(C) Copyright 2003 Motorola Inc. Xianghua Xiao (X.Xiao@motorola.com) Modified based on 8260 for 8560.:(C) Copyright 2000 Wolfgang Denk, DENX Software Engineering, wd@denx.de.
Copyright 2007-2011 Freescale Semiconductor, Inc.:(C) Copyright 2000 Wolfgang Denk, DENX Software Engineering, wd@denx.de.
Copyright 2013 Freescale Semiconductor, Inc. Author: Prabhakar Kushwaha <prabhakar@freescale.com>
Copyright 2004, 2007-2011 Freescale Semiconductor, Inc.:(C) Copyright 2003 Motorola Inc. Xianghua Xiao, (X.Xiao@motorola.com);(C) Copyright 2000 Wolfgang Denk, DENX Software Engineering, wd@denx.de.
Copyright 2007-2011 Freescale Semiconductor, Inc.:(C) Copyright 2003 Motorola Inc. Modified by Xianghua Xiao, X.Xiao@motorola.com.:(C) Copyright 2000 Wolfgang Denk, DENX Software Engineering, wd@denx.de.
Copyright 2007-2009, 2011 Freescale Semiconductor, Inc.
Copyright 2010-2011 Freescale Semiconductor, Inc. Author: Roy Zang <tie-fei.zang@freescale.com>
(C) Copyright 2000-2002 Wolfgang Denk, DENX Software Engineering, wd@denx.de.:(C) Copyright 2002 (440 port) Scott McNutt, Artesyn Communication Products, smcnutt@artsynpc.com.:(C) Copyright 2003 Motorola Inc. (MPC85xx port) Xianghua Xiao (X.Xiao@motorola.com)
(C) Copyright 2002,2003 Motorola Inc. Xianghua Xiao, X.Xiao@motorola.com
Copyright 2010 Freescale Semiconductor, Inc. Author: Timur Tabi <tumur@freescale.com>
Copyright 2004,2007-2011 Freescale Semiconductor, Inc.:(C) Copyright 2002, 2003 Motorola Inc. Xianghua Xiao (X.Xiao@motorola.com);(C) Copyright 2000 Wolfgang Denk, DENX Software Engineering, wd@denx.de.
Copyright 2009-2012 Freescale Semiconductor, Inc
(C) Copyright 2006 Wolfgang Denk, DENX Software Engineering, wd@denx.de
Copyright 2007 Freescale Semiconductor.
Copyright 2008,2010 Freescale Semiconductor, Inc. Dave Liu <daveliu@freescale.com>
Copyright 2004 Freescale Semiconductor.
Copyright 2012-2016 Freescale Semiconductor, Inc.
Copyright 2007 Freescale Semiconductor, Inc.:(C) Copyright 2002,2003 Motorola Inc. Xianghua Xiao,X.Xiao@motorola.com.:(C) Copyright 2004 Freescale Semiconductor. (MC86xx Port) Jeff Brown
Copyright 2004, 2007, 2008 Freescale Semiconductor. Srikanth Srinivasan <srikanth.srinivaan@freescale.com>
Copyright 2004, 2007, 2011 Freescale Semiconductor. Srikanth Srinivasan <srikanth.srinivaan@freescale.com>
Copyright 2008, 2011 Freescale Semiconductor, Inc.
Copyright 2004 Freescale Semiconductor. Jeff Brown Srikanth Srinivasan (srikanth.srinivasan@freescale.com);(C) Copyright 2000-2002 Wolfgang Denk, DENX Software Engineering, wd@denx.de.
Copyright 2004,2009-2011 Freescale Semiconductor, Inc. Jeff Brown Srikanth Srinivasan (srikanth.srinivasan@freescale.com)
Copyright 2006, 2007 Freescale Semiconductor, Inc.
(C) Copyright 2000-2002 Wolfgang Denk, DENX Software Engineering, wd@denx.de.:(C) Copyright 2002 (440 port) Scott McNutt, Artesyn Communication Products, smcnutt@artsynpc.com.:(C) Copyright 2003 Motorola Inc. (MPC85xx port) Xianghua Xiao (X.Xiao@motorola.com);(C) Copyright 2004, 2007 Freescale Semiconductor. (MPC86xx Port) Jeff Brown Srikanth Srinivasan (srikanth.srinivasan@freescale.com)
Copyright 2008-2010 Freescale Semiconductor, Inc.
(C) Copyright 2004 Freescale Semiconductor. Jeff Brown
Copyright 2006,2009-2010 Freescale Semiconductor, Inc. Jeff Brown Srikanth Srinivasan (srikanth.srinivasan@freescale.com)
Copyright (C) 1995-1996 Gary Thomas (gdt@linuxppc.org);(C) Copyright 2000 Wolfgang Denk, DENX Software Engineering, wd@denx.de.
Copyright 2007,2011 Freescale Semiconductor, Inc.
Copyright 2007 Freescale Semiconductor, Inc.:(C) Copyright 2000 Wolfgang Denk, DENX Software Engineering, wd@denx.de.
Copyright (C) 2004-2008 Freescale Semiconductor, Inc.

(C) Copyright 2000-2002 Wolfgang Denk, DENX Software Engineering, wd@denx.de.
Copyright (C) 2004-2009 Freescale Semiconductor, Inc.
Copyright 2004 Freescale Semiconductor, Inc.
Copyright (C) 2007-2009 Freescale Semiconductor, Inc.
(C) Copyright 2006-2007 Freescale Semiconductor, Inc.
Copyright (C) 2007-2011 Freescale Semiconductor, Inc.
Copyright (C) Freescale Semiconductor, Inc. 2007
Copyright 2008 (C) Bryan O'Donoghue
(C) Copyright 2017 Christophe Leroy, CS Systemes d'Information, christophe.leroy@c-s.fr
Copyright 2004, 2011 Freescale Semiconductor Jeff Brown (Jeffrey@freescale.com) Srikanth Srinivasan (srikanth.srinivasan@freescale.com)
Copyright 2008 Qstreams Networks, Inc.
Copyright 2004-2011 Freescale Semiconductor, Inc.
Copyright 2007,2009-2012 Freescale Semiconductor, Inc.
Copyright (c) 1997 Dan Malek (dmalek@jlc.net);(C) Copyright 2000-2006 Wolfgang Denk, DENX Software Engineering, wd@denx.de.
Copyright 2004 Freescale Semiconductor, Inc. Liberty Eran (liberty@freescale.com)
(C) Copyright 2008 Ricardo Ribalda-Universidad Autonoma de Madrid-ricardo.ribalda@gmail.com This work has been supported by: QTechnology http://qtec.com/ Based on interrupts.c Wolfgang Denk-DENX Software Engineering-wd@denx.de
Copyright 2006 Freescale Semiconductor, Inc.
Copyright 2007-2012 Freescale Semiconductor, Inc.
Copyright 2010 eXMeritus, A Boeing Company
Copyright (c) 2003, Motorola Inc. Xianghua Xiao (X.Xiao@motorola.com)
Copyright (c) 1997 Dan Malek (dmalek@jlc.net)
(C) Copyright 2000 - 2002 Wolfgang Denk, DENX Software Engineering, wd@denx.de.
Copyright (C) 2004-2008,2010-2011 Freescale Semiconductor, Inc.
Copyright (C) 2013, Intel Corporation Redistribution and use in source and binary forms, with or without modification, are permitted provided that the following conditions are met:
Copyright (c) <1995-2014>, Intel Corporation. All rights reserved. Redistribution. Redistribution and use in binary form, without modification, are permitted provided that the following conditions are met:
Copyright (c) <1995-2015>, Intel Corporation. All rights reserved. Redistribution. Redistribution and use in binary form, without modification, are permitted provided that the following conditions are met:
Copyright (C) 2014, Bin Meng <bmeng.cn@gmail.com>
Copyright (c) 2011 The Chromium OS Authors.:(C) Copyright 2002 Daniel Engström, Omicron Ceti AB, <daniel@omicron.se>
Copyright (C) 1999 Hewlett-Packard Co. Contributed by David Mosberger <davidm@hpl.hp.com>.
Copyright (C) 2013, Intel Corporation
Copyright (C) 1999 Hewlett-Packard Co. Contributed by David Mosberger <davidm@hpl.hp.com>.
Copyright (C) 2007 Advanced Micro Devices, Inc.
Copyright (C) 1991,1992,1993,1997,1998,2003, 2005 Free Software Foundation, Inc. This file is part of the GNU C Library.
Copyright (C) 2009-2010 coresystems GmbH
Copyright (C) 2001 Ronald G. Minnich
(C) Copyright 2002 Daniel Engström, Omicron Ceti AB, <daniel@omicron.se>
(C) Copyright 2008-2011 Graeme Russ, <graeme.russ@gmail.com>;(C) Copyright 2002 Daniel Engström, Omicron Ceti AB, <daniel@omicron.se>;(C) Copyright 2002 Wolfgang Denk, DENX Software Engineering, <wd@denx.de>;(C) Copyright 2002 Sysgo Real-Time Solutions, GmbH <www.elinos.com> Marius Groeger <mgroeger@sysgo.de>
(C) Copyright 2009 Graeme Russ, <graeme.russ@gmail.com>;(C) Copyright 2002 Daniel Engström, Omicron Ceti AB, <daniel@omicron.se>
(C) Copyright 2009 Graeme Russ, <graeme.russ@gmail.com>;(C) Copyright 2007 Daniel Hellstrom, Gaisler Research, <daniel@gaisler.com>;(C) Copyright 2006 Detlev Zundel, DENX Software Engineering, <dzu@denx.de>;(C) Copyright -2003 Wolfgang Denk, DENX Software Engineering, <wd@denx.de>;(C) Copyright 2002 Daniel Engström, Omicron Ceti AB, <daniel@omicron.se>;(C) Copyright 2001 Josh Huber, Mission Critical Linux, Inc, <huber@mclx.com>
Copyright (c) 2018 Google, Inc

LICENCE TERMS (cont.)

Copyright (C) 2014 Google Inc.
Copyright (C) 2015-2016 Intel Corp. Written by Andrey Petrov <andrey.petrov@intel.com> for Intel Corp.)
Copyright (C) 2015-2016 Intel Corp. Written by Andrey Petrov <andrey.petrov@intel.com> for Intel Corp.) Written by Alexandru Gagniuc <alexandrux.gagniuc@intel.com> for Intel Corp.) Mostly taken from coreboot fsp2_0/memory_init.c
Copyright (C) 1999 Hewlett-Packard Co. Contributed by David Mosberger <davidm@hpl.hp.com>. All rights reserved.
Copyright (C) 2015, Saket Sinha <saket.sinha89@gmail.com>
Copyright 2017 Intel Corp.
Copyright (C) 2017 Intel Corporation.
Copyright (C) 2011 The Chromium OS Authors. All rights reserved.
Copyright (C) 2015-2016 Intel Corp.
Copyright (C) 2012 Google Inc.
(C) Copyright 2016 Google, Inc Written by Simon Glass <sjg@chromium.org>
(C) Copyright 2006 Wolfgang Denk, DENX Software Engineering, wd@denx.de.:(C) Copyright 2002 Daniel Engström, Omicron Ceti AB, daniel@omicron.se.
(C) Copyright 2014 Google, Inc
(C) Copyright 2008-2011 Graeme Russ, <graeme.russ@gmail.com>;(C) Copyright 2002 Daniel Engström, Omicron Ceti AB, <daniel@omicron.se>;(C) Copyright 2002 Sysgo Real-Time Solutions, GmbH <www.elinos.com> Marius Groeger <mgroeger@sysgo.de>;(C) Copyright 2002 Sysgo Real-Time Solutions, GmbH <www.elinos.com> Alex Zuepke <azu@sysgo.de>
Copyright (C) 2017 Intel Corporation. Take from coreboot project file of the same name
(C) Copyright 2008-2011 Graeme Russ, <graeme.russ@gmail.com>;(C) Copyright 2002 Daniel Engström, Omicron Ceti AB, <daniel@omicron.se>
Copyright (C) 2008-2009 coresystems GmbH
Copyright (C) 2007-2009 coresystems GmbH
Copyright (C) 2010 Google Inc.
Copyright 2019 Google, Inc Written by Simon Glass <sjg@chromium.org>
(C) Copyright 2015 Miao Yan <yanmiaobest@gmail.com>;(C) Copyright 2019 Bin Meng <bmeng.cn@gmail.com>
Copyright (C) 2015, Miao Yan <yanmiaobest@gmail.com>
Copyright (C) 2008-2009 coresystems GmbH
(C) Copyright 2002 Daniel Engström, Omicron Ceti AB, daniel@omicron.se.
Copyright (c) 2011 The Chromium OS Authors.:(C) Copyright 2010-2011 Graeme Russ, <graeme.russ@gmail.com>
Copyright (c) 2018 Emlid Limited
Copyright (c) 2011 The Chromium OS Authors.:(C) Copyright 2010,2011 Graeme Russ, <graeme.russ@gmail.com>
(C) Copyright 2008-2011 Graeme Russ, <graeme.russ@gmail.com>;(C) Copyright 2002,2003 Daniel Engström, Omicron Ceti AB, <daniel@omicron.se>
Copyright (C) 2011 The Chromium Authors.
Copyright (C) 2016 Google, Inc.
Copyright (C) 2011 The Chromium Authors
Copyright (C) 2016 Google Inc.
Copyright (c) 2011 The Chromium OS Authors.:(C) Copyright 2008,2009 Graeme Russ, <graeme.russ@gmail.com>;(C) Copyright 2002 Daniel Engström, Omicron Ceti AB, <daniel@omicron.se>
Copyright (C) 2007-2009 coresystems GmbH 2012 secunet Security Networks AG
(C) Copyright 2002 Daniel Engström, Omicron Ceti AB, daniel@omicron.se
Copyright (c) 2011, Google Inc.
Copyright (C) 2017 Intel Corporation.
Copyright(c) 2009 Intel Corporation. All rights reserved.
Copyright (C) 2015, Intel Corporation
(C) Copyright 2009 Graeme Russ, graeme.russ@gmail.com;:(C) Copyright 2002 Daniel Engström, Omicron Ceti AB, daniel@omicron.se
(C) Copyright 2012 Graeme Russ, <graeme.russ@gmail.com>
Copyright (C) 2015-2016 Intel Corp.
Copyright (c) 2019 Intel Corporation */
Copyright (C) 2013 Google Inc.
Copyright (C) 2016 Bin Meng <bmeng.cn@gmail.com>
Copyright (C) 2015-2016 Intel Corp. Written by Alexandru Gagniuc <alexandrux.gagniuc@intel.com> for Intel Corp.)

Mostly taken from coreboot
Copyright (C) 2008 Advanced Micro Devices, Inc.
Copyright (C) 2014 Google Inc.
Copyright (c) 2015 Google, Inc Written by Simon Glass <sjg@chromium.org>
Copyright (C) 2010 coresystems GmbH
Copyright (C) 2015-2016 Intel Corp. Written by Lance Zhao <lijian.zhao@intel.com> for Intel Corp.)
Copyright (c) 2016, Intel Corporation. All rights reserved.
Copyright (c) 2019, Intel Corporation. All rights reserved.
Copyright (C) 2015 - 2017 Intel Corp. Written by Alexandru Gagniuc <alexandrux.gagniuc@intel.com> for Intel Corp.)
Copyright 2002 Andy Grover <andrew.grover@intel.com>
(C) 2014 Linaro Ltd. <ard.biesheuvel@linaro.org>;(C) 2018 Alexander Graf <agraf@suse.de>
(C) 2018 Alexander Graf <agraf@suse.de>
Copyright (C) 2018, Anup Patel <anup@brainfault.org>
Copyright (C) 2011 Andes Technology Corporation Shawn Lin, Andes Technology Corporation <nobuhiro@andestech.com> Macpaul Lin, Andes Technology Corporation <macpaul@andestech.com> Rick Chen, Andes Technology Corporation <rick@andestech.com>
Copyright (C) 2018 Alexander Graf <agraf@suse.de>
Copyright (C) 2019, Rick Chen <rick@andestech.com>
Copyright (c) 2016-17 Microsemi Corporation. Padmarao Begari, Microsemi Corporation <padmarao.begari@microsemi.com>
Copyright (C) 2019 Western Digital Corporation or its affiliates. Authors: Atish Patra <atish.patra@wdc.com> Based on arm/lib/image.c
Copyright (c) 2020 Western Digital Corporation or its affiliates.
Copyright (c) 2017 Microsemi Corporation.
Copyright (C) 2015 Regents of the University of California
Copyright (c) 2018 Western Digital Corporation or its affiliates.
(C) Copyright 2018 Alexander Graf <agraf@suse.de>
Copyright (C) 2012 ARM Ltd.
Copyright (C) 2015 Regents of the University of California
Copyright (c) 2017 Microsemi Corporation. Padmarao Begari, Microsemi Corporation <padmarao.begari@microsemi.com>
Copyright 2018 SiFive, Inc.
Copyright (C) 2018 Angelo Dureghello <angelo@sysam.it>
Copyright (C) 2019 Angelo Dureghello <angelo@sysam.it>
(C) 2019 Angelo Dureghello <angelo.dureghello@timesys.com>
Copyright (C) 1989, 1992, 1993, 1994, 1995 Free Software Foundation, Inc.
(C) Copyright 2003 Josef Baumgartner <josef.baumgartner@telex.de>;(C) Copyright 2000 Wolfgang Denk, DENX Software Engineering, wd@denx.de.
Copyright (C) 1989-2015 Free Software Foundation, Inc.
(C) Copyright 2000-2004 Wolfgang Denk, DENX Software Engineering, wd@denx.de.:(C) Copyright 2007 Freescale Semiconductor Inc TsiChung Liew (Tsi-Chung.Liew@freescale.com)
"Copyright (C) 2003 Josef Baumgartner <josef.baumgartner@telex.de> Based on code from Bernhard Kuhn <bkuhn@metrowerks.com>"
(C) Copyright 2000-2003 Wolfgang Denk, DENX Software Engineering, wd@denx.de.:(C) Copyright 2007, 2012 Freescale Semiconductor, Inc. TsiChung Liew (Tsi-Chung.Liew@freescale.com)
"Copyright (C) 2003 Josef Baumgartner <josef.baumgartner@telex.de> Based on code from Bernhard Kuhn <bkuhn@metrowerks.com>"
(C) Copyright 2019 Angelo Dureghello <angleo@sysam.it>
(C) Copyright 2000-2003 Wolfgang Denk, DENX Software Engineering, wd@denx.de.:(C) Copyright 2004-2007, 2012 Freescale Semiconductor, Inc. TsiChung Liew (Tsi-Chung.Liew@freescale.com)
(C) Copyright 2000-2004 Wolfgang Denk, DENX Software Engineering, wd@denx.de.
"Copyright (C) 2003 Josef Baumgartner <josef.baumgartner@telex.de> Based on code from Bernhard Kuhn <bkuhn@metrowerks.com>;(C) Copyright 2004-2008 Freescale Semiconductor, Inc. TsiChung Liew (Tsi-Chung.Liew@freescale.com)"
(C) Copyright 2000-2003 Wolfgang Denk, DENX Software Engineering, wd@denx.de.:(C) Copyright 2004-2008, 2012 Freescale Semiconductor, Inc. TsiChung Liew (Tsi-Chung.Liew@freescale.com)
(C) Copyright 2007, 2012 Freescale Semiconductor, Inc. TsiChung Liew (Tsi-Chung.Liew@freescale.com)

LICENCE TERMS (cont.)

(C) Copyright 2000 Wolfgang Denk, DENX Software Engineering, wd@denx.de.;(C) Copyright 2015 Angelo Dureghello, Sysam Firmware, angelo@sysam.it
(C) Copyright 2015 Angelo Dureghello <angelo@sysam.it> Based on code from Bernhard Kuhn <bkuhn@metrowerks.com>
Copyright (c) 2009 Freescale Semiconductor, Inc.
(C) Copyright 2003 Josef Baumgartner <josef.baumgartner@telex.de>
(C) Copyright 1999, Greg Ungerer (gerg@snapgear.com);(C) Copyright 2000, Lineo Inc. (www.lineo.com)
Copyright (c) 2003 Josef Baumgartner <josef.baumgartner@telex.de>
Copyright (C) 2004-2009 Freescale Semiconductor, Inc. TsiChung Liew (Tsi-Chung.Liew@freescale.com)
Copyright (C) 2003-2004, Greg Ungerer (gerg@snapgear.com)
(C) Copyright 2006, Lab X Technologies <zachary.landau@labxtechnologies.com> Based on mcf5272sim.h of uCLinux distribution.:(C) Copyright 1999, Greg Ungerer (gerg@snapgear.com);(C) Copyright 2000, Lineo Inc. (www.lineo.com)
Copyright (c) 2005 Arthur Shipkowski <art@videon-central.com>
Copyright (c) 2003 Josef Baumgartner <josef.baumgartner@telex.de> 2006 Zachary P. Landau <zachary.landau@labxtechnologies.com>
Copyright 2004-2012 Freescale Semiconductor, Inc. TsiChung Liew (Tsi-Chung.Liew@freescale.com)
Copyright (c) 1997 Dan Malek (dmalek@jlc.net)
(C) Copyright 2002 - 2010 Wolfgang Denk, DENX Software Engineering, wd@denx.de.
(C) Copyright 2000 - 2003 Wolfgang Denk, DENX Software Engineering, wd@denx.de.
Copyright 1994 - 2000 Neil Russell. See License
Copyright (C) 2003 by Arthur van Hoff (avh@strangeberry.com)
(C) Masami Komiya <mkomiya@sonare.it> 2004
Copyright 1994, 1995, 2000 Neil Russell. See License
(C) Copyright 2001-2015 Wolfgang Denk, DENX Software Engineering, wd@denx.de. Joe Hershberger, National Instruments
(C) Masami Komiya <mkomiya@sonare.it> 2005
Copyright (c) 2008 Pieter Voorthuisen <pieter.voorthuisen@prodrive.nl>
Copyright 2018 Lothar Felten, lothar.felten@gmail.com
(C) Masami Komiya <mkomiya@sonare.it> 2005
Copyright (C) 2007,2008 Oracle. All rights reserved.
Copyright (C) 2006-2008 Nokia Corporation.
Copyright (C) 2006-2008 Nokia Corporation.:(c) do { \;(c) do { \
(C) Copyright 2006 Wolfgang Denk, DENX Software Engineering, wd@denx.de.:(C) Copyright 2003 Pavel Bartusek, Sysgo Real-Time Solutions AG, pba@sysgo.de
Copyright (C) 2006-2008 Nokia Corporation.:(C) Copyright 2008-2010 Stefan Roese, DENX Software Engineering, sr@denx.de.
Copyright (C) 2006-2008 Nokia Corporation
Copyright (c) 2005 Ben Gardner <bgardner@wabtec.com>
Copyright (C) 2006-2008 Nokia Corporation.
Copyright (C) 2004 Patrik Kluba, University of Szeged, Hungary
copyright 2001 Simon Tatham. Rewritten from original source 2006 by Dan Merillat for use in u-boot.
Copyright © 2004 Ferenc Havasi <havasi@inf.u-szeged.hu>, Zoltan Sogor <weth@inf.u-szeged.hu>, Patrik Kluba <pajko@halom.u-szeged.hu>, University of Szeged, Hungary
Copyright (C) 2001, Russ Dill Author: Russ Dill <Russ.Dill@asu.edu> Description: Module to load kernel from jffs2
Copyright (C) 2001, Russ Dill Author: Russ Dill <Russ.Dill@asu.edu> Description: Mini inflate implementation (RFC 1951)
(C) Copyright 2012 Jorgen Lundman <lundman at lundman.net>
(C) Copyright 2003 - 2004 Sysgo AG, <www.elinos.com>, Pavel Bartusek <pba@sysgo.com>
Copyright (c) 2012, Google Inc.:(C) Copyright 2006 Wolfgang Denk, DENX Software Engineering, wd@denx.de.:(C) Copyright 2003 Pavel Bartusek, Sysgo Real-Time Solutions AG, pba@sysgo.de
(C) Copyright 2011 - 2012 Samsung Electronics EXT4 filesystem implementation in Uboot by Uma Shankar <uma.shankar@samsung.com> Manjunatha C Achar <a.manjunatha@samsung.com>;(C) Copyright 2004 esd gmbh <www.esd-electronics.com> Reinhard Arit <reinhard.arit@esd-electronics.com>;(C) Copyright 2003 - 2004 Sysgo AG, <www.elinos.com>, Pavel Bartusek <pba@sysgo.com>
Copyright (c) 2005 Ben Gardner <bgardner@wabtec.com> This source code is licensed under the GNU General Public License, Version 2. See the file COPYING for more details.

Copyright (C) 1999 Linus Torvalds
Copyright (C) 2002-2011 Aleph One Ltd. for Toby Churchill Ltd and Brightstar Engineering
Copyright (C) 2002-2007 Aleph One Ltd. for Toby Churchill Ltd and Brightstar Engineering
Copyright (C) 2003 Aleph One Ltd.
Copyright (c) 1992, 1993 The Regents of the University of California. All rights reserved.
Copyright (C) 2003 Manuel Novoa III <mjn3@codepoet.org>
copyright the library, and (2) we offer you this license, which gives you legal permission to copy, distribute and/or modify the library.
Copyright (C) <year> <name of author>
copyright the library, and (2) we offer you this license, which gives you legal permission to copy, distribute and/or modify the library.
Copyright (C) <year> <name of author>
Copyright (C) 2018 Diego Rondini <diego.rondini@kynetics.com>
Copyright (C) 2018 Diego Rondini <diego.rondini@kynetics.com>
Copyright (c) 2018 Fuzhou Rockchip Electronics Co., Ltd.
Copyright (c) 2018 Linaro Ltd.
Copyright (C) 2014 Wolfram Sang, Sang Engineering <wsa@sang-engineering.com>
Copyright (C) 2017 Amarula Solutions B.V. Author: Jagan Teki <jagan@amarulasolutions.com>
Copyright (C) 2016 Engicam S.r.l.
Copyright (C) 2016 Cogent Embedded, Inc.
Copyright (C) 2018 Cogent Embedded, Inc.
Copyright (c) 2018 Amlogic, inc. Author: Qiufang Dai <qiuqiang.dai@amlogic.com>
Copyright (c) 2016-2017 HiSilicon Technologies Co., Ltd.
Copyright (C) 2016 Glider bvba
Copyright (C) 2013-2014 Renesas Solutions Corp.
Copyright (C) 2014 Cogent Embedded Inc.
Copyright 2017 NXP
Copyright 2015 NextThing Co
Copyright 2015 NextThing Co
Copyright 2011 Linaro Ltd.
Copyright (c) 2019 Christian Hewitt <christianshewitt@gmail.com>
Copyright (C) 2018 Amarula Solutions B.V. Author: Jagan Teki <jagan@amarulasolutions.com>
Copyright (C) 2016 Renesas Electronics
Copyright 2013 Ideas On Board SPRL
Copyright (c) 2015 Linaro Limited.
Copyright (C) 2015 Engicam S.r.l.
Copyright (c) 2018 Collabora Ltd.
Copyright (c) 2019 Arm Ltd.
Copyright (C) 2016 Milo Kim <woogyom.kim@gmail.com>
Copyright (C) 2016 Milo Kim <woogyom.kim@gmail.com>
Copyright (C) 2017 NXP
Copyright (c) 2018 Akash Gajjar <Akash_Gajjar@mentor.com>
Copyright (C) 2016 Chen-Yu Tsai <wens@csie.org>
Copyright 2012 Kim Phillips, Freescale Semiconductor.
Copyright (c) 2016 BayLibre, SAS. Author: Neil Armstrong <narmstrong@baylibre.com>
Copyright (c) 2016 BayLibre, SAS. Author: Neil Armstrong <narmstrong@baylibre.com>
Copyright (c) 2016 BayLibre, SAS. Author: Neil Armstrong <narmstrong@baylibre.com>
Copyright (C) 2014 Ulrich Hecht
Copyright (C) 2010 Simon Guinot <sguinot@lacie.com>
Copyright (C) 2018 Jonathan McDowell <noodles@earth.li>
Copyright (C) 2016 Hans de Goede <hdegoede@redhat.com>
Copyright (C) 2016 Hans de Goede <hdegoede@redhat.com>
Copyright (C) 2018 embedded brains GmbH
Copyright (C) 2012 Jonas Gorski <jonas.gorski@gmail.com>
Copyright 2013 Maxime Ripard
copyright string */ char abstractfileid[37]
copyright /* abstract file identifier */ char bibliofileid[37]

LICENCE TERMS (cont.)

copyright /* bibliographic file identifier */ unsigned char creationdate[17]
copyright /* creation date */ unsigned char modify[17]
copyright /* modification date */ unsigned char expire[17]
Copyright 2017-2018 NXP Semiconductor
Copyright (C) 2014 Google Inc.\n\n")
Copyright printf("SPDX-License-Identifier: GPL-2.0+\n")
Copyright(C) Copyright 2010, Thomas Chou <thomas@wytron.com.tw>
Copyright (C) 2014 Altera Corporation <www.altera.com>
Copyright (c) 2005-2006 Gianluigi Tiesi <sherpaya@netfarm.it> Parts by Kees Zeelenberg <kzlg@users.sourceforge.net> (LibGW32C)
Copyright (C) 1991,1996-1999,2001,2004,2007 Free Software Foundation, Inc. This file is part of the GNU C Library.
Copyright 2004 Matt Mackall <mpm@selenic.com>
Copyright (C) 2015 Nathan Rossi <nathan@nathanrossi.com>
Copyright (c) 2011, Google Inc. All rights reserved.
Copyright (c) 2003-2005 by Peter Astrand <astrand@lysator.liu.se> Licensed to PSF under a Contributor Agreement. See <http://www.python.org/2.4/license> for licensing details.
Copyright 2011 Sebastian Andrzej Siewior <bigeasy@linutronix.de>
Copyright 2014 Linaro, Ltd. Rob Herring <robh@kernel.org>
Copyright 2015 Free Electrons.
Copyright (c) 2016 Xilinx, Inc Written by Michal Simek
Copyright (C) 2015 Amlogic, Inc. All rights reserved.
Copyright (C) 2011 HALE electronic GmbH, <helmut.raiger@hale.at>
Copyright (C) 2014-2016 Freescale Semiconductor, Inc.
Copyright 2011 Freescale Semiconductor, Inc.
Copyright 2019 Toradex AG
Copyright (c) 2012 Anders Electronics plc. All Rights Reserved.
Copyright (c) 2012 CompuLab, Ltd Dmitry Lifshitz <lifshitz@compulab.co.il> Ilya Ledvich <ilya@compulab.co.il> Inspired by Alberto Panizzo <maramaopercheseimorto@gmail.com> & Marek Vasut work in I4f00242t03.c
Copyright 2017-2018 NXP
Copyright (C) 2019 Luca Ceresoli <luca@lucaceresoli.net>
Copyright(c) Copyright 2015 Xilinx, Inc. All rights reserved.
Copyright © 2016 Free Electrons
Copyright (c) 2010, Andrey Makarov (makarov@bmsu.ru, mka-at-mailru@mail.ru), with Reserved Font Name Anka/Coder Narrow.
Copyright (c) 2010, Andrey Makarov (makarov@bmsu.ru, mka-at-mailru@mail.ru), with Reserved Font Name Anka/Coder Narrow.
Copyright (c) 2010, Andrey Makarov (makarov@bmsu.ru, mka-at-mailru@mail.ru), with Reserved Font Name Anka/Coder Narrow.
Copyright (C) 2008-2009 MontaVista Software Inc.
Copyright (C) 2008-2009 Texas Instruments Inc
Copyright (C) 2017 Vasily Khoruzhick <anarsoul@gmail.com>
Copyright (c) 2015 Google, Inc
Copyright 2014 Rockchip Inc.
Copyright (C) 2019 STMicroelectronics - All Rights Reserved Andrzej Hajda <a.hajda@samsung.com>
Copyright (C) 2019, STMicroelectronics - All Rights Reserved Author(s): Philippe Cornu <philippe.cornu@st.com> for STMicroelectronics. Yannick Fertre <yannick.fertre@st.com> for STMicroelectronics.
Copyright 2014 Rockchip Inc.
Copyright 2017 Jernej Skrabec <jernejskrabec@siol.net>
Copyright (c) 2015-2016, NVIDIA CORPORATION. All rights reserved.
Copyright (c) 2015-2016, NVIDIA CORPORATION. All rights reserved.
Copyright(c) in self._nonprint and ("%%%02x' % ord(c)) or c for c in data) data = html.escape(data) return data
Copyright 2014 Google Inc.
Copyright (c) 2016, NVIDIA CORPORATION. All rights reserved.
Copyright 2008 Embedded Alley Solutions, Inc All Rights Reserved.
Copyright (c) 2017, Xiphos Systems Corp. All rights reserved.
Copyright (c) 2016, Alexander Graf <agraf@suse.de>
Copyright (c) 2017, NVIDIA CORPORATION. All rights reserved.

Copyright (C) 2008 Maxime Bizon <mbizon@freebox.fr>
Copyright (C) 2009 Florian Fainelli <florian@openwrt.org>
Copyright (c) 2016, NVIDIA CORPORATION. All rights reserved. test_fit.py
Copyright (c) 2013, Google Inc.
Copyright (c) 2016 Free Electrons
Copyright (c) 2018 Konsulko Group
Copyright (c) 2016 Free Electrons
Copyright (C) 2013, Applied Micro Circuits Corporation Author: Feng Kan <fkan@apm.com>
Copyright 2008-2009 Freescale Semiconductor, Inc. All Rights Reserved.
Copyright 2010 Orex Computed Radiography
Copyright 2004 Karen Spearel
Copyright 2005 Alessandro Zummo
Copyright (C) 2009 Albin Tonnerre, Free Electrons <albin.tonnerre@free-electrons.com>
Copyright (C) 2008-2011 Florian Fainelli <florian@openwrt.org>
Copyright (C) 2009 - 2014 Xilinx, Inc.
Copyright (C) 2011 Stefano Babic, DENX Software Engineering, <sbabic@denx.de>
Copyright (C) 2015-2016 Freescale Semiconductor, Inc.
Copyright(C) Copyright 2001 Gerald Van Baren. Custom IDEAS, vanbaren@cideas.com.
Copyright (C) Procsys. All rights reserved. Mushtaq Khan <mushtaq_k@procsys.com> mushtaqk_921@yahoo.co.in>
Copyright (C) 2008 Freescale Semiconductor, Inc. Dave Liu <daveliu@freescale.com>
Copyright (C) 2007 David Brownell
Copyright (C) 2003-2005 Nokia Corporation Written by Juha Yrjölä <juha.yrjola@nokia.com>
Copyright (c) 2014, NVIDIA CORPORATION. All rights reserved.
Copyright (C) 2009-2011 Gabor Juhos <juhosg@openwrt.org>
Copyright (C) 2013 John Crispin <blogic@openwrt.org>
Copyright (C) 2012 Samsung Electronics authors: Andrzej Pietrasiewicz <andrzej.p@samsung.com> Lukasz Majewski <l.majewski@samsung.com>
Copyright 2013 Wolfgang Denk <wd@denx.de>
Copyright (C) 2014 Srideep <srideep_devireddy@dell.com>
Copyright (C) 2013 Miles Tseng <miles_tseng@accton.com>
Copyright (C) 2014,2016 david_yang <david_yang@accton.com>
Copyright 2010 eXMeritus, A Boeing Company
Copyright (C) 2009 Alessandro Rubini <rubini@unipv.it> Rewritten based on work by Prafulla WADASKAR <prafulla.wadaskar@st.com>
Copyright (C) 2010 Joakim Axelsson <joakim.axelsson AT stericsson.com>
Copyright (C) 2011 Missing Link Electronics Joachim Foerster <joachim@missinglinkelectronics.com>
Copyright 2018 NXP
Copyright (C) 2009 Jens Scharsig (js_at_ng@scharsoft.de)
Copyright (C) 2005 HP Labs
Copyright(C) Copyright 2001 Sysgo Real-Time Solutions, GmbH <www.elinos.com> Andreas Heppel <aheppel@sysgo.de>
Copyright (C) 2011 Andes Technology Corporation Macpaul Lin, Andes Technology Corporation <macpaul@andestech.com>
Copyright(c) Copyright 2000 Oleg Drokin <green@crimea.edu> Based on SoftDog driver by Alan Cox <alan@lxorguk.ukuu.org.uk>
Copyright (c) 2004 Texas Instruments. 1. Modified to support OMAP1610 32-KHz watchdog timer 2. Ported to 2.6 kernel
Copyright (c) 2005 David Brownell Use the driver model and standard identifiers
Copyright (C) 2008 Renaud CERRATO r.cerrato@til-technologies.fr
Copyright (C) 2017 Bin Meng <bmeng.cn@gmail.com>
Copyright (C) 2007 Miguel Gao <miguel.gao@efixo.com>
Copyright (C) 2008 Florian Fainelli <florian@openwrt.org>
Copyright (C) 2011 Gabor Juhos <juhosg@openwrt.org>
copyright(c) 1999, 2000 David Woodhouse <dwmw2@infradead.org>
copyright(C) 2010 Nanometrics, Inc. dynenv' -- Dynamic environment offset in NAND OOB
copyright(C) Copyright 2006-2007 OpenMoko, Inc. Added 16-bit nand support

LICENCE TERMS (cont.)

copyright(C) 2004 Texas Instruments
Copyright 2010, 2012 Freescale Semiconductor
copyright is held by Freescale and which are not considered a derived work of GPL v2-only code may be distributed and/or modified under the terms of the GNU General Public License as published by the Free Software Foundation
copyright either version 2 of the License, or (at your option) any later
Copyright(c) 1999, 2000 David Woodhouse <dwmw2@infradead.org>
Copyright(C) 2010 Nanometrics, Inc. dynenv' -- Dynamic environment offset in NAND OOB
Copyright(C) Copyright 2006-2007 OpenMoko, Inc. Added 16-bit nand support
Copyright(C) 2004 Texas Instruments
Copyright 2010, 2012 Freescale Semiconductor
copyright is held by Freescale and which are not considered a derived work of GPL v2-only code may be distributed and/or modified under the terms of the GNU General Public License as published by the Free Software Foundation
Copyright either version 2 of the License, or (at your option) any later
Copyright(C) Copyright 2002 Robert Schwebel, Pengutronix, <r.schwebel@pengutronix.de>
Copyright(C) Copyright 2003 Kai-Uwe Bloem, Auerswald GmbH & Co KG, <linux-development@auerswald.de>
Copyright(C) Copyright 2005 Wolfgang Denk, DENX Software Engineering, wd@denx.de.
Copyright 2002 SYSGO Real-Time Solutions GmbH
Copyright (C) 2012 Samsung Electronics author: Lukasz Majewski <l.majewski@samsung.com> author: Piotr Wilczek <p.wilczek@samsung.com>
Copyright 2008 Silicon Turnkey Express, Inc. Martha Marx <mmarx@siliconkx.com>
Copyright (c) 2012: Joe Hershberger, National Instruments, joe.hershberger@ni.com All rights reserved.
Copyright (C) 2019 Texas Instruments Incorporated - http://www.ti.com/
Copyright (c) 1998 by Michael Barr. This software is placed into the public domain and may be used for any purpose.
However, this notice must not be changed or removed and no warranty is either expressed or implied by its publication or distribution.
Copyright (C) 2018, Bin Meng <bmeng.cn@gmail.com>
Copyright (c) 2017 Álvaro Fernández Rojas <noltari@gmail.com>
Copyright(C) Copyright 2008 Harald Welte, OpenMoko, Inc., Harald Welte <laforge@openmoko.org>
Copyright 2019 NXP Semiconductors Andy Fleming
Copyright(C) Copyright 2003 Kyle Harris, Nexus Technologies, Inc. kharris@nexus-tech.net
Copyright 2019 Bhargav Shah <bhargavshah1988@gmail.com>
Copyright 2018 Andes Technology, Inc. Author: Rick Chen (rick@andestech.com)
Copyright 2008-2009 Stefan Roese <sr@denx.de>, DENX Software Engineering
Copyright (c) 2009, Code Aurora Forum. All rights reserved.
Copyright(C) Copyright 2001 Wolfgang Denk, DENX Software Engineering, wd@denx.de.
Copyright (C) 2014, Bin Meng <bmeng.cn@gmail.com>
Copyright (C) 2004-2006 Atmel Corporation
Copyright (c) 2016 National Instruments Corp
Copyright (C) 2008 Sascha Hauer, Pengutronix <s.hauer@pengutronix.de>
Copyright (C) 2006 Pavel Pisa, PIKRON <ppisa@pikron.com>
Copyright 2011-2019 NVIDIA Corporation
Copyright (c) 2015, NVIDIA CORPORATION. All rights reserved.
Copyright(C) Copyright 2010 Petr Stetiar <ynezz@true.cz>
Copyright (C) Nalin Dahyabhai <bigfun@pobox.com>
Copyright 2019 NXP Semiconductors Andy Fleming Yangbo Lu <yangbo.lu@nxp.com>
Copyright (C) 2015-2016 Freescale Semiconductor, Inc.
Copyright (C) 2014 Nobuhiro Iwamatsu <nobuhiro.iwamatsu.yj@renesas.com>
Copyright (C) 2008-2009 Renesas Solutions Corp.
Copyright 2010-2011 Freescale Semiconductor, Inc.
Copyright (C) 2011 Marek Vasut <marek.vasut@gmail.com> on behalf of DENX Software Engineering GmbH
Copyright(C) Copyright 2008-2010 Freescale Semiconductor, Inc. Terry Lv
Copyright 2007, Freescale Semiconductor, Inc Andy Fleming
Copyright (C) 2011 Corscience GmbH & Co. KG - Simon Schwarz <schwarz@corscience.de>
Copyright (C) 2011 Heiko Schocher, DENX Software Engineering, hs@denx.de.
Copyright (C) 2016 Rockchip Electronic Co.,Ltd Written by Kever Yang <kever.yang@rock-chips.com>
Copyright (C) 2017 Theobroma Systems Design und Consulting GmbH
Copyright (C) 2015 ARM Limited

Copyright(C) Copyright 2002 Rich Ireland, Enterasys Networks, rireland@enterasys.com.
Copyright 2009 Lattice Semiconductor Corp.
Copyright (c) 2019 SED Systems, a division of Calian Ltd.
Copyright (C) 2000 by Lineo, Inc., and written by Erik Andersen <andersen@lineo.com>, <andersee@debian.org>.
That, in turn, is based in part on ladsh.c, by Michael K. Johnson and Erik W. Troan, which they placed in the public domain. I don't know how much of the John
Copyright 2009 Lattice Semiconductor Corp.
"Copyright(c) printf("%c", c)"
"Copyright(c) printf("%x", c) define vme_out_string(s) printf("%s", s)"
Copyright (C) 2015 Hans de Goede <hdegoede@redhat.com>
Copyright (C) 2014 Roman Byshko <rbyshko@gmail.com>
Copyright 2008 Maxime Bizon <mbizon@freebox.fr>
Copyright 2013 Florian Fainelli <florian@openwrt.org>
Copyright (c) 2019, NVIDIA CORPORATION. All rights reserved.
Copyright (C) 2016 Stefan Roese <sr@denx.de>
Copyright (C) 2017 John Crispin <john@phrozen.org>
Copyright (C) 2019 BayLibre, SAS Author: Neil Armstrong <narmstron@baylibre.com>
Copyright (C) 2018 BayLibre, SAS Author: Neil Armstrong <narmstron@baylibre.com>
Copyright (C) 2011 Marek Vasut <marek.vasut@gmail.com> on behalf of DENX Software Engineering GmbH
Copyright (C) 2019 Parthiban Nallathambi <parthitce@gmail.com>
Copyright 2013 Freescale Semiconductor, Inc.
Copyright (C) 2015-2016 Socionext Inc. Author: Masahiro Yamada <yamada.masahiro@socionext.com>
Copyright(C) Copyright 2002 Wolfgang Denk, DENX Software Engineering, <wd@denx.de>
Copyright(C) Copyright 2002 Sysgo Real-Time Solutions, GmbH <www.elinos.com> Marius Groeger <mgroeger@sysgo.de>
Copyright(C) Copyright 2002 Sysgo Real-Time Solutions, GmbH <www.elinos.com> Alex Zuepke <azu@sysgo.de>
Copyright (C) 1999 2000 2001 Erik Mouw (J.A.K.Mouw@its.tudelft.nl)
Copyright(C) Copyright 2016 Marcel Ziswiler <marcel.ziswiler@toradex.com>
Copyright (C) 2007,2008,2010, 2014 Nobuhiro Iwamatsu
Copyright (C) 2002 - 2008 Paul Mundt
Copyright (C) 2011 Freescale Semiconductor, Inc.
Copyright (C) 2011-2012 Xilinx, Inc. All rights reserved.
Copyright (C) 2012 Freescale Semiconductor, Inc.
Copyright (C) 2018 Manivannan Sadhasivam <manivannan.sadhasivam@linaro.org>
Copyright (C) 2008 Maxime Bizon <mbizon@freebox.fr>
Copyright (C) 2008 Jean-Christophe PLAGNIOL-VILLARD <plagnioj@jcrosoft.com>
Copyright (C) 2015 - 2016 Xilinx, Inc, Michal Simek
Copyright (C) 2007 Sergey Kubushyn <ksi@koi8.net>
Copyright (C) 2007-2009 Texas Instruments, Inc.
Copyright(C) Copyright 2004-2008 Texas Instruments, <www.ti.com>
Copyright (C) 2010 Andes Technology Corporation Shawn Lin, Andes Technology Corporation <nobuhiro@andestech.com> Macpaul Lin, Andes Technology Corporation <macpaul@andestech.com>
Copyright (C) 2010 Texas Instruments Incorporated - http://www.ti.com/
Copyright (C) 2009 Nick Thompson, GE Fanuc, Ltd. <nick.thompson@gefanuc.com>
Copyright (C) 2012 Samsung Electronics
Copyright (C) 2012 rockchips zyw <zyw@rock-chips.com>
Copyright (C) 2014 - STMicroelectronics Inc. Author: Lee Jones <lee.jones@linaro.org>
Copyright (C) 2011 Texas Instruments Incorporated - http://www.ti.com/
Copyright (C) 2011, Texas Instruments, Incorporated - http://www.ti.com/
Copyright (C) 2019 DENX Software Engineering GmbH
Copyright (C) 2013 Lars Poeschel, Lemonage Software GmbH
Copyright (C) 2015 Wadim Egorov, PHYTEC Messtechnik GmbH
Copyright (C) 2015-2016 Stefan Roese <sr@denx.de>
Copyright (c) 2004-2008 Texas Instruments
Copyright(C) Copyright 2002 Gary Jennejohn, DENX Software Engineering, <garyj@denx.de>
Copyright (C) 2009 Matthias Kaehlcke <matthias <at> kaehlcke.net>
Copyright(C) Copyright 2002 2003 Network Audio Technologies, Inc. <www.netaudiotech.com> Adam Bezanson

LICENCE TERMS (cont.)

<bezanson <at> netaudiotech.com>
Copyright 2007 Embedded Specialties, Inc.
Copyright 2004, 2007 Freescale Semiconductor.
Copyright(C) Copyright 2002 Scott McNutt <smcnutt@artesyincp.com>
Copyright(C) Heiko Schocher, DENX Software Engineering, hs@denx.de.
Copyright 2019 Siemens AG
Copyright 2014-2015 Freescale Semiconductor, Inc. Layerscape PCIe driver
Copyright (C) 2014-2016 Freescale Semiconductor, Inc.
Copyright 2019 NXP
Copyright (C) 2003-2004 Linux Networx Written by Eric Biederman <ebiederman@lnxi.com> for Linux Networx
Copyright (C) 2003-2006 Ronald G. Minnich <rminnich@gmail.com>
Copyright (C) 2004-2005 Li-Ta Lo <ollie@lanl.gov>
Copyright (C) 2005-2006 Tyan Written by Yinghai Lu <yhlu@tyan.com> for Tyan)
Copyright (C) 2005-2009 coresystems GmbH Written by Stefan Reinauer <stepan@coresystems.de> for coresystems GmbH)
Copyright 1993 -- 1997 Drew Eckhardt, Frederic Potter, David Mosberger-Tang
Copyright 1997 -- 1999 Martin Mares <mj@atrey.karlin.mff.cuni.cz>
Copyright 2015 Google, Inc Written by Simon Glass <sjg@chromium.org>
Copyright (c) 2008-2009, NVIDIA Corporation.
Copyright (c) 2013-2014, NVIDIA Corporation.
Copyright (C) 1999, 2000, 2004 MIPS Technologies, Inc. Authors: Carsten Langgaard <carsten@mips.com> Maciej W. Rozycki <macro@mips.com>
Copyright (C) 2014 Renesas Electronics Europe Ltd
Copyright (C) 2009 - 2011 Paul Mundt
Copyright (C) 2018 BayLibre, SAS Author: Neil Armstrong <narmstrong@baylibre.com>
Copyright 2007 Wind River Systems, Inc.
Copyright 2007 Embedded Specialties, Inc. Joe Hamman joe.hamman@embeddedspecialties.com
Copyright 2004 Freescale Semiconductor. Jeff Brown Srikanth Srinivasan (srikanth.srinivasan@freescale.com)
Copyright (C) 2018 DENX Software Engineering Måns Rullgård, DENX Software Engineering, mans@mansr.com
Copyright (C) 2011 Sascha Hauer, Pengutronix <s.hauer@pengutronix.de>
Copyright (C) 2019 Stefan Roese <sr@denx.de>
Copyright (C) 2010 Eric C. Cooper <ecc@cmu.edu>
Copyright(C) Copyright 2009 Marvell Semiconductor <www.marvell.com>
Copyright(C) Copyright 2009 Marvell Semiconductor <www.marvell.com> Refer docs/README.kwimage for more details about how-to configure and create kirkwood boot image
Copyright 2012 Freescale Semiconductor, Inc.
Copyright 2012 Linaro Ltd.
Copyright (C) 2010-2011 Canonical Ltd <jeremy.kerr@canonical.com>
Copyright (C) 2011-2012 Mike Turquette, Linaro Ltd <mturquette@linaro.org>
Copyright (C) 2013 Soren Brinkmann <soren.brinkmann@xilinx.com>
Copyright (C) 2013 Xilinx, Inc. All rights reserved.
Copyright (C) 2011 Sascha Hauer, Pengutronix <s.hauer@pengutronix.de>
Copyright (C) 2011 Richard Zhao, Linaro <richard.zhao@linaro.org>
Copyright 2008-2011 Freescale Semiconductor, Inc.
Copyright(C) Copyright 2000 Wolfgang Denk, DENX Software Engineering, wd@denx.de.
Copyright 2011,2012 Freescale Semiconductor, Inc.
Copyright 2009-2011 Freescale Semiconductor, Inc.
Copyright 2007-2011 Freescale Semiconductor, Inc.
Copyright (C) 2007 Logic Product Development, Inc. Peter Barada <peterb@logicpd.com>
Copyright (C) 2007 MontaVista Software, Inc. Anton Vorontsov <avorontsov@ru.mvista.com>
Copyright(C) Copyright 2008 - 2010 Heiko Schocher, DENX Software Engineering, hs@denx.de.
Copyright (C) 2018 SiFive, Inc. Wesley Terpstra Paul Walmsley
Copyright (c) 2016, NVIDIA CORPORATION.
Copyright (c) 2018, Theobroma Systems Design and Consulting GmbH
Copyright (C) 2011-2012 Mike Turquette, Linaro Ltd <mturquette@linaro.org>
Copyright (C) 2013 Ideas On Board SPRL
Copyright (C) 2016 Glider bvba
Copyright (C) 2015 Glider bvba
Copyright (C) 2015 Renesas Electronics Corp.
Copyright (C) 2018 Cogent Embedded, Inc.
Copyright (C) 2015 Glider bvba
Copyright (C) 2014 Kynetics LLC.
Copyright (C) 2014 Revolution Robotics, Inc.
Copyright (C) 2015-2017 Glider bvba
Copyright (C) 1998, 1999, 2000, 2001, 2002 Red Hat, Inc.
Copyright (C) 1998, 1999, 2000, 2001, 2002 Red Hat, Inc.
Copyright (C) 1998, 1999, 2000, 2001, 2002 Red Hat, Inc.
Copyright (C) 2004, 2005 Cory T. Tusar, Videon Central, Inc., <ctusar@videon-central.com>
Copyright(C) Copyright 2002 2003 Adam Bezanson, Network Audio Technologies, Inc. bezanson@netaudiotech.com>
Copyright(C) Copyright 2010 Andes Technology Macpaul Lin <macpaul@andestech.com>
Copyright (C) 2018, IBM Corporation.
Copyright (C) 2001 Standard Microsystems Corporation (SMSC) Developed by Simple Network Magic Corporation (SNMC)
Copyright (C) 1996 by Erik Stahlman (ES)
Copyright (C) 2004, 2005 Cory T. Tusar, Videon Central, Inc., <ctusar@videon-central.com>
Copyright (C) 2016-2017 Stefan Roese <sr@denx.de>
Copyright 2014 Freescale Semiconductor, Inc.
Copyright 2020 NXP
copyright 1999-2002 by Donald Becker.
Copyright (C) Archway Digital Solutions.
Copyright (C) Linux Networx. Massive upgrade to work with the new intel gigabit NICs. ebiederman at lnxi dot com>
Copyright 2017 NXP Author: Prabhakar Kushwaha <prabhakar@freescale.com>
Copyright (C) 2005 Texas Instruments.
Copyright (C) 2005 Texas Instruments.
Copyright (c) 2014-2017 Broadcom
Copyright 2007 Freescale Semiconductor, Inc.
Copyright(C) Copyright 2001-2006 Wolfgang Denk, DENX Software Engineering, wd@denx.de.
Copyright (c) 2008, 2011, 2014 2014 Nobuhiro Iwamatsu
Copyright (c) 2007 Carlos Munoz <carlos@kenati.com>
Copyright (C) 2013, 2014 Renesas Electronics Corporation
Copyright 2008 Freescale Semiconductor, Inc.
Copyright (C) 2011 PetaLogix
Copyright (C) 2010 Xilinx, Inc. All rights reserved.
Copyright 2008 Freescale Semiconductor, Inc.
Copyright (C) 2008-2009 Avionic Design GmbH Thierry Reding <thierry.reding@avionic-design.de>
Copyright (C) 2010 Thomas Chou <thomas@wytron.com.tw>
Copyright (C) 2016 Cadence Design Systems Inc.
Copyright (C) 2019 Rosy Song <rosysong@rosinson.com>
Copyright 2007-2008 Freescale Semiconductor, Inc.
Copyright (C) 1999 Ben Williamson <benw@pobox.com>
Copyright (C) 2010 Thomas Chou <thomas@wytron.com.tw>
Copyright 2004 Freescale Semiconductor.
Copyright 2004, 2007 Freescale Semiconductor, Inc.
Copyright (c) 2018 Joe Hershberger <joe.hershberger@ni.com>
Copyright (c) 2008 - 2012 Nobuhiro Iwamatsu
Copyright (c) 2007 Carlos Munoz <carlos@kenati.com>
copyright 1999-2001 by Donald Becker.
copyright 1999-2001 by Donald Becker.
Copyright 2016 Karsten Merker <merker@debian.org>
Copyright (C) 2016 BayLibre, SAS. All rights reserved. Author: Neil Armstrong <narmstrong@baylibre.com>
Copyright (C) 2014 O.S. Systems Software LTDA.
Copyright (C) 2008 Ronetix Ilko Iliev (www.ronetix.at)
Copyright (C) 2009 Jean-Christopher PLAGNIOL-VILLARD <plagnioj@jcrosoft.com>

LICENCE TERMS (cont.)

Copyright (c) 2006 Herbert Valerio Riedel <hvr@gnu.org>
Copyright (C) 2009 Jean-Christophe PLAGNIOL-VILLARD <plagnioj@jcrosoft.com>
Copyright (C) 2012 Marvell
Copyright (c) 2017 Intel Corporation
Copyright(C) Copyright 2003 Ingo Assmus <ingo.assmus@keymile.com>
Copyright (C) 2002 rabeeh@galileo.co.il
Copyright 1997-1998 DAVICOM Semiconductor, Inc. All Rights Reserved.
Copyright(C) Copyright 2009 DENX Software Engineering Author: John Rigby <jrigby@gmail.com>
Copyright (C) 2008,2009 Eric Jarrige <jorasse@users.sourceforge.net>
Copyright (C) 2009 Ilya Yanok <yanok@emcraft.com> And:
Copyright (C) 2009 Red Hat
Copyright(C) 2003 Wolfgang Denk, wd@denx.de Extension to synchronize ethaddr environment variable against value in EEPROM
Copyright (C) 2019 Oliver Graute <oliver.graute@kococonnector.com>
Copyright 2016 Advantech Corporation
Copyright 2012 Freescale Semiconductor, Inc.
Copyright 2015 General Electric Company
Copyright 2016 Advantech Corporation
Copyright (C) 2016 George McCollister <george.mccollister@gmail.com>
Copyright (c) 2000, 2001, 2002 Lineo
Copyright (c) 2001 Hewlett Packard
Copyright (c) 2015 NextThing Co
Copyright (C) 2015 Free Electrons Gregory CLEMENT <gregory.clement@free-electrons.com>
Copyright (C) 2014-2017 Olaf Mandel <o.mandel@menlosystems.com>
Copyright 2019 Google LLC
Copyright (C) 2015 - 2018 Texas Instruments Incorporated <www.ti.com> Written by Mugunthan V N <mugunthanvnm@ti.com>
Copyright(c) 2003 Motorola Inc.
Copyright (C) 2013, Adeneo Embedded <www.adeneo-embedded.com> Leo Sartre, <lsartre@adeneo-embedded.com>
Copyright (C) 2012 Freescale Semiconductor, Inc. and on hummingboard.c which is :
Copyright (C) 2013 SolidRun Ltd.
Copyright (C) 2013 Jon Nettleton <jon.nettleton@gmail.com>.
Copyright (C) 2016 Marcel Ziswiler <marcel.ziswiler@toradex.com>
Copyright (C) 2018, STMicroelectronics - All Rights Reserved
Copyright (C) 2018 Toradex AG
Copyright (C) 2013, Boundary Devices <info@boundarydevices.com>
Copyright (C) 2014-2019, Toradex AG copied from nitrogen6x
Copyright (c) 2008 Magnus Damm
Copyright (c) 1992 Simon Glass
Copyright (C) 2000, 2001 Free Software Foundation, Inc.
Copyright(C) Copyright 2003 Sysgo Real-Time Solutions, AG <www.elinos.com> Pavel Bartusek <pba@sysgo.de>
Copyright 2007 Sun Microsystems, Inc. All rights reserved. Use is subject to license terms.
Copyright (c) 2008, 2011, Oracle and/or its affiliates. All rights reserved.
Copyright 2009 Sun Microsystems, Inc. All rights reserved. Use is subject to license terms.
Copyright (c) 2008, 2010, Oracle and/or its affiliates. All rights reserved.
Copyright 2010 Sun Microsystems, Inc. All rights reserved. Use is subject to license terms.
Copyright (c) 2007, 2011, Oracle and/or its affiliates. All rights reserved.
Copyright (C) 2013, Boundary Devices <info@boundarydevices.com>
Copyright(C) Copyright 2012-2013 Freescale Semiconductor, Inc.
Copyright (c) 2015 NextThing Co
Copyright (c) 2018 Microchip Technology, Inc.
Copyright 2004-2009 Freescale Semiconductor, Inc. All Rights Reserved.
Copyright (c) 2003-2006, Cluster File Systems, Inc, info@clusterfs.com Written by Alex Tomas <alex@clusterfs.com>
Copyright (C) 2007-2009 Texas Instruments, Inc.
Copyright 2017-2019 NXP
Copyright (C) Jasbir Matharu
Copyright (C) UDOO Team
Copyright NXP 2018
Copyright NXP 2018
Copyright (C) 2016 NXP Semiconductors
Copyright (C) 2012 TQ-Systems GmbH Daniel Gericke <daniel.gericke@tqs.de>
Copyright (c) 2017 Google, Inc Written by Simon Glass <sjg@chromium.org>
Copyright (c) 2017 Google, Inc
Copyright (c) 2006 SUSE Linux Products GmbH
Copyright (c) 2006 Tejun Heo <teheo@suse.de>
Copyright (c) 2014 Renesas Electronics Corporation
Copyright (c) 2014 Google, Inc
Copyright(C) Copyright 2004 esd gmbh <www.esd-electronics.com> Reinhard Arit <reinhard.arit@esd-electronics.com>
Copyright (C) 2003, 2004 Free Software Foundation, Inc.
Copyright 2009
Copyright (c) 2016, NVIDIA CORPORATION.
Copyright (C) 1995-2005 Jean-loup Gailly.
Copyright (C) 1995-2005 Jean-loup Gailly.
Copyright (C) 2013 Samsung Electronics Co.Ltd Authors: Vivek Gautam <gautam.vivek@samsung.com> Vikas Sajjan <vikas.sajjan@samsung.com>
Copyright (c) 2005 MontaVista Software
Copyright (c) 2008 Excito Elektronik i Sk=E5ne AB
Copyright (C) 2011 CompuLab, Ltd. <www.complab.co.il>
Copyright (C) 2010 Nokia Corporation
Copyright (C) 2007 Eurotech S.p.A. <info@eurotech.it>
Copyright (C) 1999 Walt Drummond <drummond@valinux.com>
Copyright (C) 1999, 2002-2003 Hewlett-Packard Co. David Mosberger-Tang <davidm@hpl.hp.com> Stephane Eranian <eranian@hpl.hp.com>
Copyright (C) 2018 Bootlin
Copyright (C) 2014 Marek Vasut <marex@denx.de>
Copyright (C) 2018 Robert Bosch Power Tools GmbH
Copyright (C) 2016-2017 Rockchip Electronic Co.,Ltd
Copyright (c) 2011 samsung electronics Donghwa Lee <dh09.lee@samsung.com>
Copyright 2003-2004 Jeff Garzik
Copyright (C) 2008 Freescale Semiconductor, Inc. Dave Liu <daveliu@freescale.com> port from libata of linux kernel
Copyright (C) 2009 - 2013 Heiko Schocher <hs@denx.de> Changes for multibus/multiadapter I2C support.
Copyright(C) Copyright 2001 Gerald Van Baren, Custom IDEAS, vanbaren@cideas.com.
Copyright(C) 2000 by Paolo Scaffardi (arsenio@tin.it) AIRVENT SAM s.p.a - RIMINI(ITALY) but has been changed substantially.
Copyright (C) 2018 STMicroelectronics - All Rights Reserved Author(s): Andrzej Hajda <a.hajda@samsung.com>
Yannick Fertre <yannick.fertre@st.com> Philippe Cornu <philippe.cornu@st.com>
Copyright (C) 1996,1998 Jakub Jelinek (jj@sunsite.mff.cuni.cz)
Copyright (C) 2006-2015 Nicolas Pitre
Copyright (C) 2005 Ralf Baechle (ralf@linux-mips.org)
Copyright (C) 2013 Jagannadha Sutradharudu Teki, Xilinx Inc.
Copyright 2014 Red Hat, Inc.
Copyright (C) 2009, Texas Instruments, Incorporated
Copyright (C) 2009-2010 Texas Instruments
Copyright (C) Broadcom Corporation
Copyright (C) 2015 Reinhard Pfau <reinhard.pfau@gdsys.cc>
Copyright (C) 2016 Mario Six <mario.six@gdsys.cc>
Copyright (C) 2016 Maxime Ripard <maxime.ripard@free-electrons.com>
Copyright (c) 2016 Maxime Ripard <maxime.ripard@free-electrons.com>
Copyright (c) 2017 Amllogic, inc. Author: Yixun Lan <yixun.lan@amlogic.com>
Copyright (C) 2016 Altera Corporation. All rights reserved derived from Steffen Trumtrar's "altr,rst-mgr-a10.h"
Copyright (C) 2010 Ilya Yanok, Emcraft Systems, yanok@emcraft.com

LICENCE TERMS (cont.)

Copyright (c) 2018 MediaTek Inc. Author: Fabien Parent <fparent@baylibre.com>
Copyright (C) 2017 Cogent Embedded, Inc.
Copyright 2017 NXP.
Copyright (c) 2015 Hans de Goede <hdegoede@redhat.com>
Copyright (C) 2000-2001 Deep Blue Solutions Ltd.
Copyright (c) 2009 Patrick Hueper <phueper@hueper.net> All rights reserved.
Copyright (c) 2001 William L. Pitts All rights reserved.
Copyright(C) Copyright 2011 marcel@mesa.nl, Mesa Consulting B.V.
Copyright(C) Copyright 2004-2005 Nokia Corporation
"Copyright (C) 2004 Nokia Corporation Written by Juha Yrjölä <juha.yrjola@nokia.com>"
Copyright (C) 2005 Nokia Corporation
Copyright (C) 2011 marcel@mesa.nl, Mesa Consulting B.V.
Copyright (C) 2012 Pali Rohár <pali.rohar@gmail.com>
Copyright (C) 2006 Nokia Corporation Author: Imre Deak <imre.deak@nokia.com>
Copyright (c) 2009 esd gmbh hannover germany.
Copyright 2007-2008,2010-2011 Freescale Semiconductor, Inc
Copyright (C) 2006-2009 Freescale Semiconductor, Inc.
Copyright (c) 2009 esd gmbh.
Copyright (C) 2013 Boundary Devices
Copyright 2013 Freescale Semiconductor, Inc.
Copyright 2010-2011 Freescale Semiconductor, Inc.
Copyright 2011 Freescale Semiconductor, Inc.
Copyright (C) 2015 Freescale Semiconductor, Inc.
Copyright (C) 2016 Engicam S.r.l. Author: Jagan Teki <jagan@amarulasolutions.com>
Copyright (C) 2015 Free Electrons Gregory CLEMENT gregory.clement@free-electrons.com
Copyright (C) 2006-2009 Freescale Semiconductor, Inc.
Copyright (C) 2009 Ilya Yanok <yanok@emcraft.com>
Copyright (C) 2016 Tomas Hlavacek <tomas.hlavacek@nic.cz>
Copyright (C) 2015 ECA Sinters
Copyright 2004, 2007 Freescale Semiconductor.
Copyright (C) 2017-2019 softing automotive electronics gmbH
Copyright (C) 2016 Advantech Corporation
Copyright (C) 2016 Pavel Machek <pavel@denx.de>
Copyright (C) 2012 Renesas Solutions Corp.
Copyright (c) 2013, NVIDIA CORPORATION. All rights reserved.
Copyright 2015 General Electric Company
Copyright (C) 2012 Freescale Semiconductor, Inc. Fabio Estevam <fabio.estevam@freescale.com>
Copyright (C) 2011 Freescale Semiconductor, Inc. Jason Liu <r64343@freescale.com>
Copyright (C) 2015 Cogent Embedded, Inc.
Copyright 2009-2011 Freescale Semiconductor, Inc.
Copyright(C) Copyright 2008-2010 Freescale Semiconductor, Inc.
Copyright (C) 2011, Stefano Babic <sbabic@denx.de>
Copyright (C) 2008 Nobuhiro Iwamatsu <iwamatsu.nobuhiro@renesas.com>
Copyright (C) 2007 Kenati Technologies, Inc.
Copyright(C) Copyright 2008 Heiko Schocher, DENX Software Engineering, hs@denx.de.
Copyright(C) Copyright 2010-2013 Lukas Roggli, KEYMILE Ltd, lukas.roggli@keymile.com Holger Brunck, Keymile GmbH, holger.bruncl@keymile.com
Copyright (C) 2015 Nobuhiro Iwamatsu <iwamatsu@nigauri.org>
Copyright 2004-2008 Freescale Semiconductor, Inc.
Copyright (C) 2015 General Electric Company
Copyright (C) 2014 Advantech
Copyright (C) 2008 Nobuhiro Iwamatsu <iwamatsu.nobuhiro@renesas.com>
Copyright (C) 2013 Nobuhiro Iwamatsu <nobuhiro.iwamatsu.yj@renesas.com>
Copyright (C) 2014 Freescale Semiconductor
Copyright 2016 Google Inc
Copyright (C) 2015 Renesas Electronics Corporation
Copyright(C) Copyright 2010 Heiko Schocher, DENX Software Engineering, hs@denx.de.

Copyright (C) 2013 Nobuhiro Iwamatsu <nobuhiro.iwamatsu.yj@renesas.com>
Copyright (C) 2011 Texas Instruments Inc.
Copyright (C) 2008 Yusuke Goda <goda.yusuke@renesas.com>
Copyright (C) 2017 Chris Brandt
Copyright (C) Chris Brandt
Copyright (C) 2007, Guennadi Liakhovetski <lg@denx.de>
Copyright (C) 2009 TechNexion Ltd.
Copyright 2015 Freescale Semiconductor
Copyright (C) 2018 Raffaele RECALCATI <raffaele.recalcati@bticino.it>
Copyright (C) 2018 Jagan Teki <jagan@amarulasolutions.com>
Copyright (C) 2010-2011 Freescale Semiconductor, Inc.
Copyright 2019-2020 NXP
Copyright (C) 2013, 2014 TQ Systems (ported SabreSD to TQMa6x) Author: Markus Niebel <markus.niebel@tq-group.com>
Copyright (C) 2015 Stefan Roese <sr@denx.de>
Copyright (C) 2013, 2014 TQ Systems (ported SabreSD to TQMa6x) Author: Markus Niebel <markus.niebel@tq-group.com>
Copyright (C) 2013, 2014 Markus Niebel <Markus.Niebel@tq-group.com>
Copyright 2004 Freescale Semiconductor, Inc.
Copyright (C) 2012 Stefan Roese <sr@denx.de>
Copyright 2019 Vladimir Oltean <olteanv@gmail.com>
Copyright 2016 3ADEV <http://3adev.com> Written-by: Albert ARIBAUD <albert.aribaud@3adev.fr>
Copyright (C) 2016 Grinn
Copyright (C) 2017, Grinn - http://grinn-global.com/
Copyright (C) 2013 Jon Nettleton <jon.nettleton@gmail.com>
Copyright (C) 2012, 2015 Stefan Roese <sr@denx.de>
Copyright (C) 2018 sjoerd Simons <sjoerd.simons@collabora.co.uk>
Copyright 2004, 2007 Freescale Semiconductor, Inc.
Copyright(C) Copyright 2003 Motorola Inc. Xianghua Xiao, (X.Xiao@motorola.com)
Copyright(C) Copyright 2002,2003, Motorola Inc. Xianghua Xiao, (X.Xiao@motorola.com)
Copyright (c) 2011 IDS GmbH, Germany Sergej Stepanov <ste@ids.de>
Copyright (C) 2004-2008, 2012 Freescale Semiconductor, Inc. TsiChung Liew (Tsi-Chung.Liew@freescale.com)
Copyright (C) 2004-2007 Freescale Semiconductor, Inc. TsiChung Liew (Tsi-Chung.Liew@freescale.com)
Copyright (C) 2004-2007, 2012 Freescale Semiconductor, Inc. Hayden Fraser (Hayden.Fraser@freescale.com)
Copyright 2007 Embedded Specialties, Inc. Joe Hamman <joe.hamman@embeddedspecialties.com>
Copyright 2006 Freescale Semiconductor.
Copyright (C) 2010-2011 Freescale Semiconductor.
Copyright (C) 2019 NXP
Copyright(C) Copyright 2002,2003 Motorola,Inc. Xianghua Xiao <X.Xiao@motorola.com>
Copyright (C) 2014 Bachmann electronic GmbH
Copyright (C) 2012 Freescale Semiconductor, Inc. All Rights Reserved.
Copyright 2016 IBM Corporation
Copyright(C) Copyright 2016 Google, Inc
Copyright (C) 2004-2007, 2012 Freescale Semiconductor, Inc. TsiChung Liew (Tsi-Chung.Liew@freescale.com)
Copyright (C) 2015-2016 Marcel Ziswiler <marcel@ziswiler.com>
Copyright 2015 UDOO Team
Copyright 2020 NXP Author: Shengzhou Liu <Shengzhou.Liu@freescale.com>
Copyright 2019 NXP Authors: Priyanka Jain <Priyanka.Jain@freescale.com> Wang Dongsheng <dongsheng.wang@freescale.com>
Copyright 2016 Freescale Semiconductor, Inc.
Copyright (C) 2014 - 2016 Cadence Design Systems Inc.
Copyright © 1999-2010 David Woodhouse <dwmw2@infradead.org>
Copyright © 2002-2003 Greg Ungerer <gerg@snapgear.com>
Copyright © 2002-2003 SnapGear Inc
Copyright 2017-2018 nxp
Copyright © 2000-2005 Thomas Gleixner <tglx@linuxtronix.de>
Copyright © 2000-2010 David Woodhouse <dwmw2@infradead.org>

LICENCE TERMS (cont.)

Copyright Motorola 1984 (!). It was written to be part of the Linux operating system.
Copyright (c) 2010-2011 Jeremy Kerr <jeremy.kerr@canonical.com>
Copyright (C) 2011-2012 Linaro Ltd <mturquette@linaro.org>
Copyright (C) 2004 - 2009 Ivo van Doorn <lvdoorn@gmail.com>
Copyright 2001 Jeff Garzik <jgarzik@pobox.com>
Copyright 2001 Sun Microsystems (thockin@sun.com)
Copyright 2002 Intel (eli.kupermann@intel.com, christopher.leech@intel.com, scott.feldman@intel.com)
Copyright (C) Sun Microsystems 2008
Copyright (C) 2011-2012 Samsung Electronics Lukasz Majewski <l.majewski@samsung.com>
Copyright (C) 2011 Freescale Semiconductor, Inc.
Copyright(C) Copyright 2017 Jernej Skrabec <jernej.skrabec@siol.net>
Copyright (C) 2010-2013 Wolfgang Denk <wd@denx.de>
Copyright 2011 Comelit Group SpA Luca Ceresoli <luca.ceresoli@comelit.it> See License
Copyright 2018-2019 NXP
Copyright (c) 2011, NVIDIA Corp. All rights reserved.
Copyright (C) 2017 Álvaro Fernández Rojas <noltari@gmail.com>
Copyright (C) 2005-2008 Arthur Shipkowski (art@videon-central.com)
Copyright (C) 1997, 1998, 1999, 2000, 2001, 2002, 2003 Ralf Baechle
Copyright (C) 1999, 2000 Silicon Graphics, Inc.
Copyright (C) 2000 MIPS Technologies, Inc.
Copyright (C) 2002, 2007 Maciej W. Rozycki
Copyright (C) 2001, 2012 MIPS Technologies, Inc. All rights reserved.
Copyright (C) 1995, 1996 Paul M. Antoine
Copyright (C) 1998 Ulf Carlsson
Copyright (C) 1999 Silicon Graphics, Inc. Kevin D. Kissell, kevink@mips.com and Carsten Langgaard, carsten@mips.com
Copyright (C) 2002, 2003, 2004, 2005, 2007 Maciej W. Rozycki
Copyright (C) 2000, 2001, 2012 MIPS Technologies, Inc. All rights reserved.
Copyright (C) 2014, Imagination Technologies Ltd.
Copyright (C) 2018-2019 Rosy Song <rosysong@rosinson.com>
Copyright (C) 2015-2016 Wills Wang <wills.wang@live.com>
Copyright (C) 2008-2011 Gabor Juhos <juhosg@openwrt.org>
Copyright (C) 2008 Imre Kaloz <kaloz@openwrt.org>
Copyright (C) 2010-2011 Jaiganesh Narayanan <jnarayanan@atheros.com>
Copyright (C) 2008-2010 Gabor Juhos <juhosg@openwrt.org>
Copyright (C) 1996 by Paul M. Antoine
Copyright (C) 1994 - 1999 by Ralf Baechle
Copyright (C) 1999, 2000 Silicon Graphics, Inc.
Copyright (C) 2000 Silicon Graphics, Inc. Modified for further R[236]000 support by Paul M. Antoine, 1996. Kevin D. Kissell, kevink@mips.com and Carsten Langgaard, carsten@mips.com
Copyright (C) 2000, 07 MIPS Technologies, Inc.
Copyright (C) 2003, 2004 Maciej W. Rozycki
Copyright (c) 2000 Silicon Graphics, Inc.
Copyright (C) 1994 - 2000, 06 Ralf Baechle
Copyright (C) 2004, 2005 MIPS Technologies, Inc. All rights reserved. Author: Maciej W. Rozycki <macro@mips.com>
Copyright (C) 1999, 2000, 2001 Silicon Graphics, Inc.
Copyright (C) 2002 Maciej W. Rozycki
Copyright (C) 1999 by Silicon Graphics, Inc.
Copyright (C) 2001 MIPS Technologies, Inc.
Copyright (C) 2000, 2002 Maciej W. Rozycki
Copyright (C) 1990, 1999, 2000 Silicon Graphics, Inc.
Copyright (C) 1990, 1999 by Silicon Graphics, Inc.
Copyright (c) 2000 by Silicon Graphics, Inc.
Copyright (c) 2001 MIPS Technologies, Inc.
Copyright (C) 2004 Maciej W. Rozycki
Copyright (C) 1999 Silicon Graphics, Inc.
Copyright (C) 1994, 95, 99, 2003 by Ralf Baechle
Copyright (C) 1990 - 1992, 1999 Silicon Graphics, Inc.
Copyright (C) 2011 Wind River Systems, written by Ralf Baechle <ralf@linux-mips.org>
Copyright (C) 2013 Imagination Technologies
Copyright (C) 2001 MIPS Technologies, Inc.
Copyright (C) 1995, 1996, 1997, 1998, 1999, 2001, 2002, 2003 Ralf Baechle
Copyright (C) 1996 Paul M. Antoine
Copyright (C) 1995, 1999 Silicon Graphics
Copyright (C) 1999 Silicon Graphics, Inc.
Copyright (c) 2006-2013 Ingenic Semiconductor
Copyright (C) Marvell International Ltd. and its affiliates Written-by: Prafulla Wadaskar <prafulla@marvell.com>
Copyright (C) 2015-2017 Socionext Inc. Author: Masahiro Yamada <yamada.masahiro@socionext.com>
Copyright (C) 2016 Socionext Inc. Author: Masahiro Yamada <yamada.masahiro@socionext.com>
Copyright (C) 2015-2016 Socionext Inc.
Copyright (C) 2015 Socionext Inc.
Copyright (C) 2015-2017 Socionext Inc.
Copyright (C) 2015-2019 Socionext Inc.
Copyright 2017 NXP Jason Liu <r64343@freescale.com>
Copyright (C) 2016-2017 Socionext Inc. Author: Masahiro Yamada <yamada.masahiro@socionext.com>
Copyright (C) 2015-2020 Socionext Inc. Author: Masahiro Yamada <yamada.masahiro@socionext.com>
Copyright (C) 2017 Amarula Solutions B.V.
Copyright (C) 2014, Bachmann electronic GmbH
Copyright (C) 2011-2012 Freescale Semiconductor, Inc.
Copyright (c) 2011 IDS GmbH, Germany ids8313.c - ids8313 board support.
Copyright (C) 2013, Gateworks Corporation
Copyright(C) Copyright 2009-2016 Freescale Semiconductor, Inc.
Copyright 2014\n")
Copyright if (info->model[0]) { printf("Model: %s\n", info->model)
Copyright printf("MFGDate: %02x-%02x-%02x%02x\n", info->mfgdate[0], info->mfgdate[1], info->mfgdate[2], info->mfgdate[3])
Copyright(C) Copyright 2009 Freescale Semiconductor, Inc.
Copyright(C) Copyright 2011 Freescale Semiconductor, Inc.
Copyright (C) 2008, Guennadi Liakhovetski <lg@denx.de>
Copyright (C) 2016 Sergey Kubushyn <ksi@koi8.net>
Copyright (C) 2009 by Jan Weitzel Phytex Messtechnik GmbH, armlinux@phytec.de>
Copyright (C) 2004-2011 Freescale Semiconductor, Inc.
Copyright 2016 Google, Inc
Copyright(C) Copyright 2002-2004 Gary Jennejohn, DENX Software Engineering, <garyj@denx.de>
Copyright(C) Copyright 2004 Philippe Robin, ARM Ltd. <philippe.robin@arm.com>
Copyright (C) 2007 Sergey Kubushyn <ksi@koi8.net>
Copyright (C) 2008 Lyrtech <www.lyrtech.com>
Copyright (C) 2004 Texas Instruments.
Copyright (C) 2009 David Brownell
copyright (C) 2007 Sergey Kubushyn <ksi@koi8.net>
Copyright (C) 2006 Texas Instruments.
"Copyright (c) 2001 Marius Gröger <mag@sysgo.de>"
"Copyright (c) 2002 Alex Zuepke <azu@sysgo.de>"
"Copyright (c) 2002 Gary Jennejohn <garyj@denx.de>"
"Copyright (c) 2003 Richard Woodruff <r-woodruff2@ti.com>"
"Copyright (c) 2003 Kshitij <kshitij@ti.com>"
Copyright (C) 2014 Gateworks Corporation
Copyright (C) 2014 Stefan Roese <sr@denx.de>
Copyright (C) 2012-2017 Altera Corporation <www.altera.com>
Copyright (c) 2011, Pablo Impallari (www.impallari.com|impallari@gmail.com), Rodrigo Fuenzalida (www.rfuenzalida.com) with Reserved Font Name Cantora.
Copyright (c) 2011, Pablo Impallari (www.impallari.com|impallari@gmail.com), Rodrigo Fuenzalida (www.rfuenzalida.com) with Reserved Font Name Cantora.

LICENCE TERMS (cont.)

Copyright (c) 2011, Pablo Impallari (www.impallari.com|impallari@gmail.com), Rodrigo Fuenzalida (www.rfuenzalida.com) with Reserved Font Name Cantora.
copyright the library, and (2) offer you this license which gives you legal permission to copy, distribute and/or modify the library.
copyright the library, and (2) offer you this license which gives you legal permission to copy, distribute and/or modify the library.
Copyright (c) 1995-2003 by Internet Software Consortium
copyright I B M CORPORATION 1995 LICENSED MATERIAL - PROGRAM PROPERTY OF I B M
Copyright (c) 2008 Herbert Xu <herbert@gondor.apana.org.au>
Copyright 2000 Roland Borde
Copyright 2000 Paolo Scaffardi
Copyright 2000-2002 Wolfgang Denk, wd@denx.de
Copyright 2009 Dirk Behme, dirk.behme@googlegmail.com
Copyright (C) 1996-2010 Julian Seward <jseward@bzip.org>
Copyright (C) 1996-2010 Julian Seward <jseward@bzip.org>
Copyright (c) 2009-2014, The Linux Foundation. All rights reserved.
Copyright 2014 Broadcom Corporation.
Copyright (c) 2009-2014, The Linux Foundation. All rights reserved.
Copyright 2014 Broadcom Corporation.
Copyright (C) 1999 Hewlett-Packard Co
Copyright (C) 1999 David Mosberger-Tang <davidm@hpl.hp.com>
Copyright 1995-2010 Jean-loup Gailly and Mark Adler "
Copyright 1995-2010 Jean-loup Gailly and Mark Adler "
Copyright (c) 2018 AKASHI Takahiro, Linaro Limited
Copyright (C) 1993, 1995, 1996, 1997, 2002 Free Software Foundation, Inc. This file is part of the GNU C Library.
Contributed by Ulrich Drepper <drepper@gnu.ai.mit.edu>, 1993.
Copyright 2015 - Marcus Cooper <codekipper@gmail.com>
Copyright 2015 - Marcus Cooper <codekipper@gmail.com>
Copyright (c) 2017 BayLibre, SAS Author: Neil Armstrong <narmstrong@baylibre.com>
Copyright (C) 1991, 1992 Linus Torvalds
Copyright (c) 2018 Simon Goldschmidt
Copyright (C) 2017-2018 Pengutronix, Lucas Stach <kernel@pengutronix.de>
Copyright 2019 General Electric Company
Copyright (C) 2011 Atmel, 2011 Nicolas Ferre <nicolas.ferre@atmel.com>
Copyright (c) 2011 The Chromium OS Authors. All rights reserved. Use of this source code is governed by a BSD-style license that can be found in the LICENSE file.
Copyright (c) 2019 Pragnesh Patel <Pragnesh_Patel@mentor.com>
Copyright (c) 2018 Collabora Ltd.
Copyright (C) 1999-2005 Igor Pavlov
Copyright 2016 Toradex AG
Copyright 2017-2019 NXP SPDX-License-Identifier: GPL-2.0+
Copyright (c) 2014 SUSE LINUX Products GmbH
Copyright (C) 2019 Sunil Mohan Adapa <sunil@medhas.org>
Copyright (C) 2012 Jean-Christophe PLAGNIOL-VILLARD <plagnioj@jcrosoft.com>
Copyright (C) 2015 Heiko Schocher <hs@denx.de>
Copyright (C) 2018 Amarula Solutions B.V.
Copyright 2011 Linaro Ltd.
Copyright 2006 - 2016 Unified EFI, Inc.

Copyright (c) 2010 - 2016, Intel Corporation. All rights reserved.

Copyright (C) 2012 National Instruments Corp.
Copyright (c) 2011 The Chromium OS Authors.
Copyright (C) 2016 Engicam S.r.l.
Copyright (C) 2016 Engicam S.r.l.
Copyright (C) 2012 Texas Instruments Incorporated - http://www.ti.com/
Copyright (C) 2000, 1 Tim Waugh <tw Vaughn@redhat.com> ##
Copyright (C) 2001 Simon Huggins ##
Copyright (C) 2005-2012 Randy Dunlap ##

Copyright (C) 2012 Dan Luedtke ##
Copyright (c) 2000 MontaVista Software, Inc. ##
Copyright: (C) 2012 Gilles Muller, INRIA/LiP6. GPLv2. URL: http://coccinelle.lip6.fr/ Requires: 1.0.0 Options:
Copyright: (C) 2010 Julia Lawall, DIKU. GPLv2.
Copyright: (C) 2010 Gilles Muller, INRIA/LiP6. GPLv2. URL: http://coccinelle.lip6.fr/ Comments: Options: --no-
includes --include-headers
Copyright: (C) 2012 Gilles Muller, INRIA/LIP6. GPLv2. URL: http://coccinelle.lip6.fr/ Comments: Options: --no-
includes --include-headers
Copyright: (C) 2010-2012 Julia Lawall, INRIA/LIP6. GPLv2.
Copyright: (C) 2010-2012 Gilles Muller, INRIA/LiP6. GPLv2. URL: http://coccinelle.lip6.fr/ Comments: Options:
--no-include-headers
Copyright 2008 Jon Loeliger, Freescale Semiconductor, Inc.
Copyright (C) 2016 NextThing Co.
copyright (c) 2002 Romain Lievin <roms@lpg.ticalc.org>.\n" Based on the source code from Roman Zippel.\n")
Copyright (C) 2002 Roman Zippel <zippel@linux-m68k.org> Released under the terms of the GNU GPL v2.0.
Copyright 2011 Linaro
Copyright (C) 2002-2005 Sam Ravnborg <sam@ravnborg.org>
Copyright 2016 Toradex AG
Copyright 2016 Toradex AG
Copyright (C) 2014 Marvell
Copyright (C) 2015 Boris Barbulovski <bbarbulovski@gmail.com> Released under the terms of the GNU GPL v2.0.
Copyright (C) 2002 Roman Zippel <zippel@linux-m68k.org>.\n"
Copyright (C) 2015 Boris Barbulovski <bbarbulovski@gmail.com>.\n\n" Bug reports and feature request can also be
entered at http://bugzilla.kernel.org/\n")
Copyright (c) 2011-2012 Linaro Ltd. www.linaro.org
copyright(C) Copyright ..." is shown in the HTML footer. Default is True. html_show_copyright = True
Copyright 2016 Icenowy Zheng <icenowy@aosc.xyz>
Copyright 2016 Icenowy Zheng <icenowy@aosc.xyz>
Copyright (C) 2017 Alexander Graf <agraf@suse.de>
Copyright (C) 2011 - 2014 Xilinx
Copyright 2018 NXP.
Copyright (c) 2016 BayLibre, Inc. Author: Kevin Hilman <khilman@kernel.org>
Copyright (C) 2014-2015 Renesas Solutions Corp.
Copyright (C) 2014-2015 Cogent Embedded, Inc.
Copyright (c) 2014-2015, NVIDIA CORPORATION. All rights reserved.
Copyright (C) 2015 K. Merker <merker@debian.org>
Copyright (c) 2010-2011 Linaro Ltd. www.linaro.org
Copyright 2019 Linaro Ltd.
Copyright 2011 Freescale Semiconductor, Inc.
Copyright (c) 2016 by Mauro Carvalho Chehab <mchehab+samsung@kernel.org>.
Copyright 2010-2016 Tormod Volden and Stefan Schmidt This program is Free Software and has ABSOLUTELY NO
WARRANTY Please report bugs to http://sourceforge.net/p/dfu-util/tickets/
Copyright (C) 2014 Cogent Embedded, Inc.
Copyright (C) 2015-2016 Renesas Electronics Corporation
Copyright 2010 Julia Lawall <julia@diku.dk>
Copyright 2010 Gilles Muller <Gilles.Muller@lip6.fr>
Copyright (c) 2018 Fuzhou Rockchip Electronics Co., Ltd.
Copyright (C) 2015-2018, Bin Meng <bmeng.cn@gmail.com>
Copyright (C) 2019, Lihua Zhao <lihua.zhao@windriver.com>
Copyright (C) 2018 Hauke Mehrkens <hauke@hauke-m.de>
Copyright 2013 Hans de Goede <hdegoede@redhat.com>
Copyright 2013 Hans de Goede <hdegoede@redhat.com>
Copyright 2007,2011 Freescale Semiconductor, Inc.
Copyright (C) 2008 MontaVista Software, Inc.
Copyright (C) 2018 Marek Vasut <marex@denx.de>
Copyright (C) 2012 Enric Balletbo i Serra <eballetbo@gmail.com>
Copyright (C) 2017 Glider bvba

LICENCE TERMS (cont.)

Copyright (C) 2019 Amarula Solutions B.V. Author: Jagan Teki <jagan@amarulasolutions.com>
Copyright 2015 General Electric Company
Copyright (C) 2017 Opal Kelly Inc.
Copyright (C) 2004-2009 Freescale Semiconductor, Inc. TsiChung Liew (Tsi-Chung.Liew@freescale.com)
Copyright (C) 2018 Angelo Dureghello <angelo@sysam.it>
Copyright (C) 2011 Sergiy <piratfm@gmail.com>
Copyright (C) 2011-2013 Gabor Juhos <juhosg@openwrt.org>
Copyright (C) 2014-2015 Felix Fietkau <nbd@nbd.name>
Copyright (C) 2007 Atmel Corporation
Copyright (C) 2018 Cryptera A/S
Copyright (C) 2000-2010 Broadcom Corporation
Copyright (C) 2012-2013 Jonas Gorski <jogo@openwrt.org>
Copyright (c) 2019 NXP
Copyright (c) 2001 Gerd Mennchen <Gerd.Mennchen@icn.siemens.de>
Copyright (c) 2001 Wolfgang Denk, DENX Software Engineering, <wd@denx.de>.
Copyright (C) 2004-2009, 2015 Freescale Semiconductor, Inc. TsiChung Liew (Tsi-Chung.Liew@freescale.com)
Chao Fu (B44548@freescale.com) Haikun Wang (B53464@freescale.com)
Copyright (C) 2016 Renesas Electronics Corp.
Copyright (C) 2016 ARM Ltd.
Copyright (C) 2010 Dirk Behme <dirk.behme@googlegmail.com>
Copyright (C) 2009 Texas Instruments Incorporated - <http://www.ti.com/>
Copyright (C) 2007 Atmel Corporation
Copyright (C) 2005, 2006 Nokia Corporation
Copyright (c) 2012 Stephan Linz <linz@li-pro.net>
Copyright (c) 2010 Graeme Smecher <graeme.smecher@mail.mcgill.ca>
Copyright (c) 2010 Thomas Chou <thomas@wytron.com.tw>
Copyright (c) 2005-2008 Analog Devices Inc.
Copyright (C) 2009-2012 Florian Fainelli <florian@openwrt.org>
Copyright (C) 2010 Tanguy Bouzeloc <tanguy.bouzeloc@efixo.com>
Copyright (C) Linaro Ltd 2019 - All Rights Reserved Author: Manivannan Sadhasivam <manivannan.sadhasivam@linaro.org>
Copyright (c) 2009, Intel Corporation.
copyright(C) Copyright 2017 Olimex Ltd.. Stefan Mavrodiev <stefan@olimex.com>
copyright follows: linux/drivers/spi/spi-sun4i.c
Copyright (C) 2012 - 2014 Allwinner Tech Pan Nan <pannan@allwinnertech.com>
Copyright (C) 2014 Maxime Ripard Maxime Ripard <maxime.ripard@free-electrons.com>
Copyright(C) Copyright 2017 Olimex Ltd.. Stefan Mavrodiev <stefan@olimex.com>
copyright follows: linux/drivers/spi/spi-sun4i.c
Copyright (C) 2012 - 2014 Allwinner Tech Pan Nan <pannan@allwinnertech.com>
Copyright (C) 2014 Maxime Ripard Maxime Ripard <maxime.ripard@free-electrons.com>
Copyright (C) 2016 Freescale Semiconductor, Inc.
Copyright 2015 Karsten Merker <merker@debian.org>
Copyright 2015 Chen-Yu Tsai <wens@csie.org>
Copyright 2015 Karsten Merker <merker@debian.org>
Copyright 2015 Chen-Yu Tsai <wens@csie.org>
Copyright (c) 2019 Written by Ramon Fried <ramon.fried@gmail.com>
Copyright (c) 2017 Amllogic, Inc. All rights reserved. Author: Xingyu Chen <xingyu.chen@amlogic.com>
Copyright (C) 2017 Xingyu Chen <xingyu.chen@amlogic.com>
Copyright (c) 2018 Amllogic, Inc. All rights reserved. Author: Xingyu Chen <xingyu.chen@amlogic.com> Author: Yixun Lan <yixun.lan@amlogic.com>
Copyright (C) 2016 Endless Mobile, Inc.
Copyright (C) 2017 Icenowy Zheng <icenowy@aosc.io>
Copyright (C) 2017 Icenowy Zheng <icenowy@aosc.io>
Copyright (C) 2017 Jerome Brunet <jbrunet@baylibre.com>
Copyright (C) 2014-2017 Cogent Embedded, Inc.
Copyright (C) 2017 Cogent Embedded, Inc. <source@cogentembedded.com>
Copyright (C) 2015 Renesas Electronics Corporation

Copyright (C) 2018 Vasily Khoruzhick <anarsoul@gmail.com>
Copyright (C) 2016-2017 Renesas Electronics Corp.
Copyright (C) 2016 Cogent Embedded, Inc., <source@cogentembedded.com>
Copyright (C) 2009 - 2012 Paul Mundt
Copyright (C) 2017 Marek Vasut
Copyright (C) 2015 Renesas Solutions Corp.
Copyright (C) 2015-2017 Cogent Embedded, Inc. <source@cogentembedded.com>
Copyright (C) 2016-2019 Renesas Electronics Corp.
Copyright (C) 2013 Magnus Damm
Copyright (C) 2012 Renesas Solutions Corp.
Copyright (C) 2012 Kuninori Morimoto <kuninori.morimoto.gx@renesas.com>
Copyright 2017 - 2018 NXP
Copyright (c) 2019 Wolfgang Grandegger <wg@aries-embedded.de>
Copyright (c) 2014 FUKAUMI Naoki <naobsd@gmail.com>
Copyright (c) 2014 FUKAUMI Naoki <naobsd@gmail.com>
Copyright (C) 2017 Marvell Gregory CLEMENT <gregory.clement@free-electrons.com>
Copyright(C) Copyright 2016 - Beniamino Galvani <b.galvani@gmail.com> Based on code from Linux kernel:
Copyright (C) 2016 Endless Mobile, Inc. <https://spdx.org/licenses>
Copyright (C) Nokia Corporation, 2007
Copyright (C) Samsung Electronics, 2009
Copyright (C) 2005-2009 Samsung Electronics Kyungmin Park <kyungmin.park@samsung.com>
Copyright (C) 2014, Freescale Semiconductor, Inc.
Copyright (C) 2010 Reinhard Meyer, EMK Elektronik
Copyright (C) 2016 Jagan Teki <jagan@openedev.com>
Copyright (C) 2018 Texas Instruments Incorporated - <http://www.ti.com/>
Copyright (c) Thomas Gleixner <tglx@linutronix.de>
Copyright (c) International Business Machines Corp., 2006
Copyright © 2002 Thomas Gleixner <gleixner@linutronix.de>
Copyright (c) 2016-2017 Micron Technology, Inc.
Copyright (C) 2009-2010, Intel Corporation and its suppliers.
Copyright 2019 NXP Author: Tim Harvey <tharvey@gateworks.com>
Copyright (C) 2014-2015 Masahiro Yamada <yamada.masahiro@socionext.com>
Copyright (C) 2006 Thomas Gleixner <tglx@linutronix.de>
Copyright (c) 2016 Endless Computers, Inc. Author: Carlo Caione <carlo@endlessm.com>
Copyright (c) 2016 BayLibre, SAS. Author: Neil Armstrong <narmstrong@baylibre.com>
Copyright (c) 2015, AW-SOM Technologies <www.aw-som.com>
Copyright © 2006 Marvell International Ltd.
Copyright 2008 Sascha Hauer, kernel@pengutronix.de
Copyright 2009 Ilya Yanok, <yanok@emcraft.com>
Copyright (c) 2018 FriendlyElec Computer Tech. Co., Ltd. <http://www.friendlyarm.com>
Copyright (c) 2008 Freescale Semiconductor, Inc. Author: Scott Wood <scottwood@freescale.com>
Copyright (C) 2010 Freescale Semiconductor, Inc.
Copyright (C) 2008 Embedded Alley Solutions, Inc.
Copyright (C) 2013-2014, Altera Corporation <www.altera.com>
Copyright (C) 2006 Texas Instruments.
Copyright (c) 2015 Tyco Fire Protection Products.
Copyright (C) 2008 by NXP Semiconductors Author: Kevin Wells
Copyright (C) 2008 Nokia Corporation: drop_ffs() function by Artem Bityutskiy <dedykind1@gmail.com> from mtd-utils
Copyright 2010 Freescale Semiconductor
Copyright (C) 2015 Roy Spliet <r.spliet@ultimaker.com>
Copyright (C) 2013 Qiang Yu <yuq825@gmail.com>
Copyright (C) 2013 Henrik Nordstrom <Henrik Nordstrom>
Copyright (C) 2013 Dmitriy B. <rzk333@gmail.com>
Copyright (C) 2013 Sergey Lapin <slapin@ossfans.org>
Copyright © 2006 Red Hat UK Limited
Copyright (C) 2003 Arabella Software Ltd. Yuli Barcohen <yuli@arabellasw.com>

LICENCE TERMS (cont.)

Copyright (C) 2004 Ed Okerson
Copyright (C) 2006 Tolunay Orkun <listmember@orkun.us>
Copyright (c) Nokia Corporation, 2006, 2007
Copyright (c) Nokia Corporation, 2007
Copyright (c) 2014 sigma star gmbh Author: Richard Weinberger <richard@nod.at>
Copyright (c) Nokia Corporation, 2006
Copyright (c) 2016 ARM Ltd.
Copyright (c) 2016 ARM Ltd.
Copyright (C) 2016 Tomas Hlavacek <tmshlvkc@gmail.com>
Copyright © 2002-2010 David Woodhouse <dwmw2@infradead.org>
Copyright (C) 2016 Cogent Embedded, Inc.
Copyright (C) 2017 Marek Vasut <marek.vasut@gmail.com>
Copyright (C) 2010-2016 Freescale Semiconductor, Inc. All Rights Reserved.
Copyright (C) 2015 Simon Arlott <simon@fire.lp0.eu>
Copyright (C) 2010 Broadcom Corporation
Copyright (c) 2015 Tyco Fire Protection Products.
Copyright (c) 2012-2013, The Linux Foundation. All rights reserved.
Copyright (c) 2018, Ramon Fried <ramon.fried@gmail.com>
Copyright (c) 2015 NextThing Co.
Copyright (C) 1996-1999 SciTech Software, Inc.
Copyright (C) 1991-2004 SciTech Software, Inc. All rights reserved.
Copyright (C) 1991-2004 SciTech Software, Inc.
Copyright (C) David Mosberger-Tang
Copyright (C) 1999 Egbert Eich
Copyright (C) 2018 VanguardiaSur
Copyright (c) 2006 Tejun Heo <teheo@suse.de>
Copyright (C) 2012 Samsung Electronics author: Lukasz Majewski <l.majewski@samsung.com>
Copyright © 2013 Jussi Kivilinna <jussi.kivilinna@iki.fi>
Copyright 2007-2012 (C) Allwinner Technology Co., Ltd. javen <javen@allwinnertech.com>
Copyright (c) 2008-2009 MontaVista Software, Inc. <source@mvista.com>
Copyright (C) 2005-2006 by Texas Instruments
Copyright (c) 2008-2009, MontaVista Software, Inc. <source@mvista.com>
Copyright (C) 2005-2006 by Texas Instruments
Copyright (C) 2006-2007 Nokia Corporation
Copyright (C) 2006 Nokia Corporation Tony Lindgren <tony@atomide.com>
Copyright (C) 2006-2007 Nokia Corporation
Copyright (C) 2008-2009 MontaVista Software, Inc. <source@mvista.com>
Copyright(c) peripheral initiates, using SRP
Copyright (C) 2008-2009 MontaVista Software, Inc. <source@mvista.com>
Copyright(c) fault modes include iff URB_SHORT_NOT_OK, short RX status is -EREMOTEIO. and that endpoint's dma queue stops immediately overflow (full, PLUS more bytes in the terminal packet)
Copyright 2016 NextThing Co
Copyright 2016 NextThing Co
Copyright (C) 2013 Jussi Kivilinna <jussi.kivilinna@iki.fi>
Copyright (c) 2008-2019, MontaVista Software, Inc. <source@mvista.com>
Copyright (c) 2016 Petr Kulhavy <petr@barix.com> This file is part of the Inventra Controller Driver for Linux.
Copyright (C) 2009 MontaVista Software, Inc. <source@mvista.com>
Copyright (c) 2011 The Chromium OS Authors.
Copyright (C) 2009 NVIDIA, Corporation
Copyright (C) 2007-2008 SMSC (Steve Glendinning)
Copyright (C) 2011 Google, Inc.
Copyright (C) 2009 Daniel Mack <daniel@caiaq.de>
Copyright (C) 2003-2004 Robert Schwebel, Benedikt Spranger
Copyright (C) 2008 Nokia Corporation
"Copyright(c) do {} while (0) define rndis_exit() do {} while (0) endif"
Copyright (C) 2009 Samsung Electronics Author: Michal Nazarewicz <m.nazarewicz@samsung.com> All rights reserved.

Copyright 2015 - Karsten Merker <merker@debian.org>
Copyright 2015 - Karsten Merker <merker@debian.org>
Copyright (C) 2009 Samsung Electronics Minkyu Kang <mk7.kang@samsung.com> Sanghee Kim <sh0130.kim@samsung.com>
Copyright (C) 2003 Robert Schwebel, Pengutronix
Copyright (C) 2003 Benedikt Spranger, Pengutronix
Copyright (C) 2003 David Brownell
Copyright (C) 2003 Joshua Wise
Copyright (C) 2012 Lukasz Dalek <luk0104@gmail.com>
Copyright (C) 2005 by HP Labs
Copyright (C) 2005 by David Brownell
Copyright (C) 2005 by Ivan Kokshaysky
Copyright (C) 2006 by SAN People
Copyright(C) Copyright 2006 Bryan O'Donoghue, deckard@CodeHermit.ie
Copyright (C) 2007 Eurotech S.p.A. <info@eurotech.it>
Copyright (C) 2008 Vivek Kotal <vivek.kotal@azingo.com>
copyright(C) Copyright 2009 Atin Malaviya <atin.malaviya@gmail.com>
Copyright (C) 2004-2007 Texas Instruments
Copyright (C) 2008 Nokia Corporation Contact: Felipe Balbi <felipe.balbi@nokia.com>
Copyright(C) Copyright 2009 Atin Malaviya <atin.malaviya@gmail.com>
Copyright (C) 2004-2007 Texas Instruments
Copyright (C) 2008 Nokia Corporation Contact: Felipe Balbi <felipe.balbi@nokia.com>
Copyright (c) 2009 Texas Instruments
Copyright (c) 2009 Texas Instruments
copyright(C) Copyright 2008 - 2009 Windriver, <www.windriver.com> Tom Rix <Tom.Rix@windriver.com>
copyright(C) Copyright 2008 Texas Instruments Incorporated.
Copyright (c) 2008 Texas Instruments Author: Thomas Abraham t-abraham@ti.com, Texas Instruments
Copyright (c) 2008 Texas Instruments Author: Thomas Abraham t-abraham@ti.com, Texas Instruments
Copyright (C) 2008 by Texas Instruments
Copyright (c) 2009-2015 NVIDIA Corporation
Copyright (c) 2013 Lucas Stach
Copyright (c) 2008, Michael Trimarchi <trimarchimichael@yahoo.it> All rights reserved.
Copyright (C) 2014 Nobuhiro Iwamatsu <nobuhiro.iwamatsu.yj@renesas.com>
Copyright (c) 2003/06, Courage Co., Ltd.
Copyright (C) 2010 Freescale Semiconductor, Inc.
Copyright(C) Copyright 2004-2008 Texas Instruments, <www.ti.com>
Copyright (C) 2015 Toradex AG
Copyright (C) 2017-2018 Samuel Holland <samuel@sholland.org>
Copyright (C) 2017-2018 Samuel Holland <samuel@sholland.org>
Copyright (c) 2008, Excito Elektronik i Skåne AB
Copyright (c) 2008, Michael Trimarchi <trimarchimichael@yahoo.it>
Copyright (C) 2014 Cogent Embedded, Inc.
Copyright 2014 Rockchip Electronics Co., Ltd. Taken from dc i2s/rockchip.c
Copyright (C) 2018 Methode
Copyright (C) 2018 Telus
Copyright 2018 Google LLC
Copyright (C) 2008-2009 coresystems GmbH
Copyright (C) 2011 The ChromiumOS Authors.
Copyright (C) Adam Ford
Copyright 2017 Icenowy Zheng <icenowy@aosc.io>
Copyright 2017 Icenowy Zheng <icenowy@aosc.io>
Copyright (C) 2010 Linaro Limited John Rigby <john.rigby@linaro.org>
Copyright (C) 2009 Alessandro Rubini
Copyright (C) 2010 ST-Ericsson
Copyright (C) 2010 Linus Walleij for ST-Ericsson
Copyright (C) 2014 Enric Balletbo i Serra <eballetbo@gmail.com>
Copyright 2018 General Electric Company Based on imx6q-ba16.dtsi and imx6q-bx50v3.dtsi from kernel 4.20.5.

LICENCE TERMS (cont.)

Copyright (C) 2015, 2019 Stefan Roese <sr@denx.de>
Copyright 2019 NXP Author: Tang Yuantian <b29983@freescale.com>
Copyright 2019 NXP Author: Dave Liu <daveliu@freescale.com>
Copyright (C) 2015 Jens Kuske <jenskuske@gmail.com>
Copyright (C) 2015 Jens Kuske <jenskuske@gmail.com>
Copyright (c) 2016 Endless Computers, Inc. Author: Carlo Caione <carlo@endlessm.com>
Copyright (c) 2003 Wolfgang Denk, wd@denx.de Rewritten to fit into the current U-Boot framework
Copyright (c) 2013 Lubomir Popov <lpopov@mm-sol.com>, MM Solutions New i2c_read, i2c_write and i2c_probe functions, tested on OMAP4 4430/60/70), OMAP5 (5430) and AM335X (3359)
Copyright should work on older OMAPs and derivatives as well. The only anticipated exception would be the OMAP2420, whic
Copyright (c) 2014 Hannes Schmelzer <oe5hpm@oevsv.at>, B&R Added support for set_speed
Copyright (C) 2014-15 Wolfram Sang <wsa@sang-engineering.com>
Copyright (C) 2011-2015 Renesas Electronics Corporation
Copyright (C) 2012-14 Renesas Solutions Corp. Kuninori Morimoto <kuninori.morimoto.gx@renesas.com>
Copyright (c) 2002-2007 Xilinx Inc.
Copyright (c) 2009-2010 Intel Corporation
Copyright(c) 2011 Marek Vasut <marek.vasut@gmail.com>
Copyright (C) 2016 Freescale Semiconductor, Inc.
Copyright (C) 2005 Torsten Koschorrek <koschorrek at synertronixx.de>
Copyright (C) 2005 Matthias Blaschke <blaschke at synertronixx.de>
Copyright (C) 2007 RightHand Technologies, Inc.
Copyright (C) 2008 Darius Augulis <darius.augulis at teltonika.lt>
Copyright 2017 Google, Inc.
Copyright (c) 2010-2011 NVIDIA Corporation NVIDIA Corporation <www.nvidia.com>
Copyright (c) 2019 Rockchip Electronics Co., Ltd.
Copyright (C) 2011, 2013 Renesas Solutions Corp.
Copyright (C) 2011, 2013 Nobuhiro Iwamatsu <nobuhiro.iwamatsu.yj@renesas.com>
Copyright (C) 2017 National Instruments Corp Written by Michal Simek
Copyright 2019 Google Inc
Copyright (c) 2016 Andreas Färber
Copyright (C) 2017-2019 Rockchip Electronic Co.,Ltd
Copyright (C) 2012 Marek Vasut <marek.vasut@gmail.com>
Copyright (C) 1999 Hewlett-Packard Co. Contributed by David Mosberger <davidm@hpl.hp.com>.
Copyright (C) 1999 Hewlett-Packard Co. Contributed by David Mosberger <davidm@hpl.hp.com>.
Copyright (C) 1999 Hewlett-Packard Co. Contributed by David Mosberger <davidm@hpl.hp.com>.
Copyright (C) 2011 Corscience GmbH & Co. KG - Simon Schwarz <schwarz@corscience.de> Added prep subcommand support Reorganized source - modeled after powerpc version
Copyright (C) 2001 Erik Mouw (J.A.K.Mouw@its.tudelft.nl)
"Copyright (c) 1999 Magnus Damm <kieraypc01.p.y.kie.era.ericsson.se>"
"Copyright (c) 2000 Wolfgang Denk <wd@denx.de>"
"Copyright (c) 2001 Alex Zuepke <azu@sysgo.de>"
"Copyright (c) 2002 Kyle Harris <kharris@nexus-tech.net>"
Copyright(C) Copyright 2002-2006 Wolfgang Denk, DENX Software Engineering, wd@denx.de.
Copyright(C) Copyright 2002 Sysgo Real-Time Solutions, GmbH <www.elinos.com> Marius Groeger <mgroeger@sysgo.de>
Copyright(C) Copyright 2002 Daniel Engström, Omicron Ceti AB, <daniel@omicron.se>
Copyright 2015 ATS Advanced Telematics Systems GmbH
Copyright 2015 Konsulko Group, Matt Porter <mporter@konsulko.com>
"Copyright (c) 2003 Kshitij <kshitij@ti.com>"
Copyright (c) 2006-2008 Syed Mohammed Khasim <x0khasim@ti.com>
"Copyright (c) 2010 Albert Aribaud <albert.u.boot@aribaud.net>"
Copyright (c) 2008 Eric Jarrige <eric.jarrige@armadeus.org>
Copyright (c) 2009 Ilya Yanok <yanok@emcraft.com>
"Copyright (c) 2001 Marius Groger <mag@sysgo.de>"
"Copyright (c) 2002 Alex Zupke <azu@sysgo.de>"
"Copyright (c) 2010 Albert Aribaud <albert.u.boot@aribaud.net>"

Copyright (c) 2011 Marek Vasut <marek.vasut@gmail.com> on behalf of DENX Software Engineering GmbH
Copyright (C) 2008 by Sascha Hauer <kernel@pengutronix.de>
Copyright (C) 2009 by Jan Weitzel Phytec Messtechnik GmbH, armlinux@phytec.de>
Copyright (C) 2010-2014 Freescale Semiconductor, Inc.
Copyright (C) 2008 Guennadi Liakhovetki, DENX Software Engineering, <lg@denx.de>
Copyright (C) 2006 Dominic Rath <Dominic.Rath@gmx.de>
Copyright(C) Copyright 2000, 2001, 2002 Wolfgang Denk, DENX Software Engineering, wd@denx.de.
Copyright (C) 2013 Sergey Kostanabev <sergey.kostanbaev <at> fairwaves.ru>
Copyright (C) 2006 Cirrus Logic Inc.
"Copyright (c) 2002 Gary Jennejohn <garyj@denx.de>"
"Copyright (C) 1999 Magnus Damm <kieraypc01.p.y.kie.era.ericsson.se>"
"Copyright (C) 2000 Wolfgang Denk <wd@denx.de>"
"Copyright (C) 2001 Alex Zuepke <azu@sysgo.de>"
"Copyright (C) 2001 Marius Groger <mag@sysgo.de>"
"Copyright (C) 2002 Alex Zupke <azu@sysgo.de>"
"Copyright (C) 2002 Gary Jennejohn <garyj@denx.de>"
"Copyright (C) 2002 Kyle Harris <kharris@nexus-tech.net>"
"Copyright (C) 2003 Kai-Uwe Bloem <kai-uwe.bloem@auerswald.de>"
"Copyright (C) 2003 Kshitij <kshitij@ti.com>"
"Copyright (C) 2003 Richard Woodruff <r-woodruff2@ti.com>"
"Copyright (C) 2003 Robert Schwebel <r.schwebel@pengutronix.de>"
"Copyright (C) 2004 Texas Instruments <r-woodruff2@ti.com>"
"Copyright (C) 2010 Marek Vasut <marek.vasut@gmail.com>"
"Copyright (c) 2001 Alex Zuepke <azu@sysgo.de>"
"Copyright (c) 2002 Alex Zuepke <azu@sysgo.de>"
Copyright (C) 1996-2000 Russell King
Copyright (C) 2012 ARM Ltd.
Copyright (C) 1994-2002 Russell King
"Copyright (C) 2003-2012 ARM Ltd. Authors: Catalin Marinas <catalin.marinas@arm.com> Will Deacon <will.deacon@arm.com>"
Copyright (C) 2014 ARM Ltd.
Copyright 2014-2015, Freescale Semiconductor
Copyright 2019 NXP.
Copyright 2014-2015 Freescale Semiconductor, Inc.
Copyright 2019 NXP Semiconductors
Copyright(C) Copyright 2015 Kamil Lulko, <kamil.lulko@gmail.com>
Copyright (C) 2015, Siemens AG
Copyright (C) 2012 Michal Simek <monstr@monstr.eu>
Copyright (C) 2011-2017 Xilinx, Inc. All rights reserved.
Copyright(C) Copyright 2008 Guennadi Liakhovetki, DENX Software Engineering, <lg@denx.de>
Copyright(C) Copyright 2002-2004 Gary Jennejohn, DENX Software Engineering, <gj@denx.de>
Copyright(C) Copyright 2003 Texas Instruments <www.ti.com>
Copyright(C) Copyright 2002 Sysgo Real-Time Solutions, GmbH <www.elinos.com> Alex Zuepke <azu@sysgo.de>
Copyright (C) 2012 - 2017 Xilinx, Inc. All rights reserved.
Copyright (C) 2012 Xilinx, Inc. All rights reserved.
Copyright (c) 2015 DAVE Embedded Systems
Copyright (C) 2010 NISHIMOTO Hiroki
Copyright (C) 2011 Kuninori Morimoto <kuninori.morimoto.gx@renesas.com>
Copyright (C) 2012 Nobuhiro Iwamatsu <nobuhiro.iwamatsu.yj@renesas.com>
Copyright (C) 2014 Renesas Electronics Corporation
Copyright (C) 2005 Ivan Kokshaysky
Copyright (C) 2009 Jean-Christophe PLAGNIOL-VILLARD <plagnioj@jrcrosoft.com>
Copyright (C) 2013 Bo Shen <voice.shen@atmel.com>
Copyright (C) 2015 Wenyou Yang <wenyou.yang@atmel.com>
Copyright (C) 2015 Atmel Corporation Wenyou Yang <wenyou.yang@atmel.com>
Copyright (C) 2013 Atmel Corporation Bo Shen <voice.shen@atmel.com>
Copyright (C) 2005 David Brownell

LICENCE TERMS (cont.)

Copyright (C) SAN People
Copyright (C) 2007 Andrew Victor
Copyright (C) 2007 Atmel Corporation.
Copyright (C) 2018 Microchip Technology Inc.
Copyright (C) SAN People
Copyright (C) 2009 Jens Scharsig (js_at_ng@scharsoft.de)
Copyright(C) Copyright 2012 Markus Hubig <mhubig@imko.de> IMKO GmbH <www.imko.de>
Copyright (C) 2013 DENX Software Engineering, hs@denx.de
Copyright (C) 2019 BayLibre, SAS Author: Fabien Parent <fparent@baylibre.com>
Copyright 2015 Freescale Semiconductor, Inc.
Copyright 2015, Freescale Semiconductor
Copyright 2008-2010 Freescale Semiconductor, Inc. All Rights Reserved.
Copyright 2018-2020 NXP
Copyright 2008-2010 Freescale Semiconductor, Inc. All Rights Reserved.
Copyright 2008-2010, 2016 Freescale Semiconductor, Inc. All Rights Reserved.
Copyright (C) 2009 Matthias Kaehlcke <matthias@kaehlcke.net>
Copyright (C) 2004 Ray Lehtiniemi
Copyright (C) 2003 Cirrus Logic, Inc
Copyright (C) 1999 ARM Limited.
Copyright (C) 2009-2012 Genesi USA, Inc.
Copyright (C) 2010-2011 Freescale Semiconductor, Inc. All Rights Reserved.
Copyright (C) 2008 Embedded Alley Solutions Inc.
Copyright(C) Copyright 2009-2010 Freescale Semiconductor, Inc.
Copyright (C) 2010 Freescale Semiconductor, Inc. All Rights Reserved.
Copyright 2008-2009 Freescale Semiconductor, Inc. All Rights Reserved.
copyright_OFFSET = 0, HDMI_FC_AUDSCHNLS0_COPYRIGHT_MASK = 0x01,
copyright in armv7.h was:
copyright(C) Copyright 2010 Texas Instruments, <www.ti.com> Aneesh V <aneesh@ti.com>
Copyright (c) 2010-2012 NVIDIA Corporation <www.nvidia.com>
Copyright 2011-2012 NVIDIA Corporation
Copyright (C) 2009 by Jan Weitzel Phytex Messtechnik GmbH <armlinux@phytec.de>
Copyright (C) 2009 by Lothar Wassmann <LW@KARO-electronics.de>
Copyright 2008 Freescale Semiconductor, Inc. All Rights Reserved. and Linux arch/arm/plat-mxc/include/mach/
iomux-mx35.h:
Copyright (C) 2009 Ilya Yanok, Emcraft Systems <yanok@emcraft.com> and arch-mx27/imx-regs.h
Copyright (C) 2007 Pengutronix, Sascha Hauer <s.hauer@pengutronix.de>
Copyright (C) 2009 Ilya Yanok, Emcraft Systems <yanok@emcraft.com>
Copyright (c) 2011-2013, NVIDIA CORPORATION. All rights reserved.
Copyright (c) 2013 NVIDIA Corporation
Copyright (C) 2011-2012,2019 NVIDIA Corporation
Copyright (c) 2013, NVIDIA CORPORATION. All rights reserved.
Copyright 2018 - Beniamino Galvani <b.galvani@gmail.com>
Copyright 2018 - BayLibre, SAS Author: Neil Armstrong <narmstrong@baylibre.com>
Copyright 2018 - Beniamino Galvani <b.galvani@gmail.com>
Copyright 2006-2013 Allwinner Technology Co., Ltd. <www.allwinnertech.com> Berg Xing <bergxing@allwinnertech.
com> Tom Cubie <tangliang@allwinnertech.com>
Copyright (C) 2016 Jean-Francois Moine <moinejf@free.fr>
Copyright (c) 2016 Allwinnertech Co., Ltd.
Copyright (C) 1996-1998 Russell King.
Copyright (c) 2015 Sjoerd Simons <sjoerd.simons@collabora.co.uk>
Copyright (c) 2015-2018 Joe Hershberger <joe.hershberger@ni.com>
Copyright 1995, Russell King. Various bits and pieces copyrights include: Linus Torvalds (test_bit).
Copyright (C) 2007, 2010 Nobuhiro Iwamatsu <iwamatsu@nigauri.org>
Copyright (C) 2008 Renesas Solutions Corp.
Copyright(C) Copyright 2003 Wolfgang Denk, DENX Software Engineering, wd@denx.de.
Copyright (C) 2008-2009 Yoshihiro Shimoda <shimoda.yoshihiro@renesas.com>
Copyright (C) 2008 Mark Jonas <mark.jonas@de.bosch.com>
Copyright (C) 2007 Nobuhiro Iwamatsu <iwamatsu@nigauri.org>
Copyright (C) 2002 Paul Mundt
Copyright (c) 2008 Yusuke Goda <goda.yusuke@renesas.com>
Copyright (C) 2007,2008 Nobuhiro Iwamatsu
"Copyright (C) 2001 NEC Corporation"
"Copyright (C) 2001 Miles Bader <miles@gnu.org>"
Copyright (C) 2001,2002 NEC Corporation
Copyright (C) 2001,2002 Miles Bader <miles@gnu.org>
Copyright (C) 2001,02 NEC Corporation
Copyright (C) 2001,02 Miles Bader <miles@gnu.org>
Copyright (C) 2001 NEC Corporation
Copyright (C) 2001 Miles Bader <miles@gnu.org>
Copyright (C) 2011 Andes Technology Corporation Shawn Lin, Andes Technology Corporation <nobuhiro@
andestech.com> Macpaul Lin, Andes Technology Corporation <macpaul@andestech.com>
Copyright(C) Copyright 2002 Gary Jennejohn, DENX Software Engineering, <gj@denx.de>
"Copyright (C) 2006 Shawn Lin <nobuhiro@andestech.com>"
"Copyright (C) 2011 Macpaul Lin <macpaul@andestech.com> Greentime Hu <greentime@andestech.com>"
Copyright (C) 2010 Shawn Lin (nobuhiro@andestech.com)
Copyright (C) 2011 Macpaul Lin (macpaul@andestech.com)
Copyright (C) 2008 Andes Technology Corporation
Copyright (C) 2013 Ken Kuo (ken_kuo@andestech.com)
Copyright (C) 2011 Andes Technology Corporation Shawn Lin, Andes Technology Corporation <nobuhiro@
andestech.com>
Copyright (C) 2011 Andes Technology Corporation
Copyright (C) 2009, Wind River Systems Inc Implemented by fredrik.markstrom@gmail.com and ivarholmqvist@
gmail.com
Copyright 2009 Freescale Semiconductor Inc.
Copyright 2010 Ilya Yanok, Emcraft Systems, yanok@emcraft.com
Copyright (C) 1999 Magnus Damm <kieraypc01.p.y.kie.era.ericsson.se>
Copyright (C) 2000, 2001,2002 Wolfgang Denk <wd@denx.de>
Copyright Freescale Semiconductor, Inc. 2004, 2006.
Copyright (C) 2003 Motorola, Inc.
Copyright(C) of CCSRAR at the old location. Follow this with a sync instruction.
Copyright (c) 2000 MontaVista Software, Inc. Dan Malek (dmalek@jlc.net)
Copyright(C) Copyright 2000 Sysgo Real-Time Solutions, GmbH <www.elinos.com> Marius Groeger <mgroeger@
sysgo.de>
Copyright (c) 1999 Dan Malek (dmalek@jlc.net)
Copyright (c) 2000 MontaVista Software, Inc (source@mvista.com) 2.3.99 Updates
Copyright (c) 2003 Motorola, Inc.
Copyright 2009 Freescale Semiconductor, Inc.
Copyright (C) 2003 Motorola Modified by Xianghua Xiao(x.xiao@motorola.com)
Copyright (C) 1995-1996 Gary Thomas (gdt@linuxppc.org)
Copyright (C) 2003 Motorola Inc. Xianghua Xiao (x.xiao@motorola.com)
Copyright Freescale Semiconductor, Inc. 2004, 2006, 2008.
Copyright (C) 2004-2007 Freescale Semiconductor, Inc.
Copyright (C) 2008-2009 MontaVista Software, Inc.
Copyright (C) 1995-1996 Gary Thomas (gdt@linuxppc.org)
Copyright(C) Copyright 2006 Wolfgang Denk, DENX Software Engineering, wd@denx.de.
Copyright (C) 2004-2006 Freescale Semiconductor, Inc.
Copyright(C) Copyright 2003 Motorola Inc. Xianghua Xiao (X.Xiao@motorola.com)
Copyright (C) 2000,2001,2002 Wolfgang Denk <wd@denx.de>
Copyright(c) 2002,2003 Motorola Inc. Xianghua Xiao (x.xiao@motorola.com)
Copyright (c) 1999 Dan Malek (dmalek@jlc.net)
Copyright (C) 2016, George McCollister <george.mccollister@gmail.com>
Copyright (C) 2005 Intel Co. Contributed by Fenghua Yu <fenghua.yu@intel.com>.
Copyright (C) 2009-2010 coresystems GmbH
Copyright (C) 2005 Intel Corporation Contributed by Fenghua Yu <fenghua.yu@intel.com>.

LICENCE TERMS (cont.)

Copyright (C) 2005 Nick.Barker9@btinternet.com
Copyright (C) 2007-2009 coresystems GmbH
Copyright (C) 2015 Bin Meng <bmeng.cn@gmail.com>
Copyright (C) 2016, Bin Meng <bmeng.cn@gmail.com>
Copyright 2019 Google LLC Taken from coreboot file exit_car.S
Copyright (C) 2017 Siemens AG
Copyright (C) 2000 Ronald G. Minnich
Copyright (C) 2000,2007 Ronald G. Minnich <rminnich@gmail.com>
Copyright (C) 2005 Tyan (written by Yinghai Lu for Tyan)
Copyright (C) 2007-2008 coresystems GmbH
Copyright (C) 2012 Kyösti Mälkki <kyosti.malkki@gmail.com>
Copyright (c) 2016 Google, Inc
Copyright (C) 2015-2018 Intel Corporation.
Copyright (C) 2018 Siemens AG Some code taken from coreboot cpulib.c
Copyright (C) 1991, 1992, 1993 Linus Torvalds
Copyright(C) Copyright 2010,2011 Graeme Russ, <graeme.russ@gmail.com>
Copyright (C) 2007-2010 coresystems GmbH
Copyright (C) 2011 Google Inc.
Copyright (C) 2011 The Chromium Authors
Copyright(C) Copyright 2008 Graeme Russ, graeme.russ@gmail.com.
Copyright (C) 2014 Google, Inc
Copyright (C) 2009 coresystems GmbH
Copyright (C) 2014, Bin Meng <bmeng.cn@gmail.com>
Copyright (C) 2015, Kodak Alaris, Inc
Copyright (C) 2015, Bin Meng <bmeng.cn@gmail.com>
Copyright (C) 2012 The Chromium OS Authors. All rights reserved.
Copyright (C) 2017, Bin Meng <bmeng.cn@gmail.com>
Copyright (C) 2016 Bin Meng <bmeng.cn@gmail.com>
Copyright (C) 2013 Google Inc.
Copyright (C) 2014 Sage Electronics Engineering, LLC.
Copyright (C) 2015 Google, Inc
Copyright (C) 2015, Google, Inc
Copyright(C) Copyright 2008-2011 Graeme Russ, <graeme.russ@gmail.com>
Copyright (C) 2017 Andes Technology Corporation Rick Chen, Andes Technology Corporation <rick@andestech.com>
Copyright (C) 2014 Linaro Ltd. <ard.biesheuvel@linaro.org>
Copyright (C) 2014 Linaro Ltd. <ard.biesheuvel@linaro.org>
Copyright (C) 2017 Andes Technology Corporation Rick Chen, Andes Technology Corporation <rick@andestech.com>
Copyright (C) 2019 Sean Anderson <seanga2@gmail.com>
Copyright (c) 2017 Padmarao Begari <Padmarao.Begari@microsemi.com>
Copyright (c) 2017 Microsemi Corporation. Padmarao Begari, Microsemi Corporation <padmarao.begari@microsemi.com>
Copyright (c) 2017 Padmarao Begari <Padmarao.Begari@microsemi.com>
Copyright (c) 2020 Western Digital Corporation or its affiliates.
Copyright (C) 2013 Regents of the University of California
Copyright (C) 2017 SiFive
Copyright (C) 2011 Macpaul Lin (macpaul@andestech.com)
Copyright (C) 2017 Rick Chen (rick@andestech.com)
Copyright (c) 2017 Microsemi Corporation. Padmarao Begari, Microsemi Corporation <padmarao.begari@microsemi.com>
Copyright 2010-2012 Freescale Semiconductor, Inc. TsiChung Liew (Tsi-Chung.Liew@freescale.com)
Copyright(C) Copyright 2005 BuS Elektronik GmbH & Co. KG <esw@bus-elektronik.de>
Copyright(c) Copyright 2010 Arcturus Networks Inc. <www.arcturusnetworks.com>
Copyright (C) 2004-2007, 2012 Freescale Semiconductor, Inc. TsiChung Liew (Tsi-Chung.Liew@freescale.com)
Hayden Fraser (Hayden.Fraser@freescale.com)
Copyright (C) 2008 Arthur Shipkowski (art@videon-central.com)

Copyright (C) 2008 Arthur Shipkowski (art@videon-central.com)
Copyright (C) 2004-2008 Arthur Shipkowski (art@videon-central.com)
Copyright (c) 2003 Josef Baumgartner josef.baumgartner@telex.de>
Copyright 2000-2002 Wolfgang Denk, wd@denx.de
Copyright (C) 2004 by David Brownell
Copyright (C) 2010 by Joe Hershberger
Copyright (C) 2004 by David Brownell
Copyright 2000 Paolo Scaffardi
Copyright 2000, 2001 DENX Software Engineering, Wolfgang Denk, wd@denx.de
Copyright 2011 Comelit Group SpA, Luca Ceresoli <luca.ceresoli@comelit.it>
Copyright (c) 2009 Robin Getz <rgetz@blackfin.uclinux.org>
Copyright (c) 2004-2005 Sergey Lyubka <valenok@gmail.com>
Copyright (c) 2009 Robin Getz <rgetz@blackfin.uclinux.org>
Copyright (c) 2004-2005 Sergey Lyubka <valenok@gmail.com>
Copyright 2000-2004 Wolfgang Denk, wd@denx.de
Copyright 2009, Robin Getz <rgetz@blackfin.uclinux.org>
Copyright (C) 2006, 2007 University of Szeged, Hungary
Copyright (C) 1996-2002 Markus Franz Xaver Johannes Oberhumer All Rights Reserved.
Copyright (C) 2001 Red Hat, Inc.
Copyright (c) 2012, NVIDIA CORPORATION. All rights reserved.
"Copyright 2004 Sun Microsystems, Inc."
Copyright 1998-2000 Red Hat, Inc --- All Rights Reserved
Copyright (C) 2000-2002 Transmeta Corporation
Copyright (C) 2003 Kai-Uwe Bloem, Auerswald GmbH & Co KG, <linux-development@auerswald.de> adapted from the www.tuxbox.org u-boot tree, added "ls" command
Copyright (C) 2000-2002 Transmeta Corporation
Copyright(C) Copyright 2003 - 2004 Sysgo AG, <www.elinos.com>, Pavel Bartusek <pba@sysgo.com>
Copyright (C) 1989, 1991 Free Software Foundation, Inc. 59 Temple Place, Suite 330, Boston, MA 02111-1307 USA
Everyone is permitted to copy and distribute verbatim copies of this license document, but changing it is not allowed.;copyright the software, and 2) offer you this license which gives you legal permission to copy, distribute and/or modify the software.;copyright law: that is to say, a work containing the Program or a portion of it, either verbatim or with modifications and/or translated into another language. (Hereinafter, translation is included without limitation in the term "modification".) Each licensee is addressed as "you".;copyrighted interfaces, the;copyrighted by the Free Software Foundation, write to the Free Software Foundation; we sometimes make exceptions for this. Our decision will be guided by the two goals of preserving the free status of all derivatives of our free software and of promoting the sharing and reuse of software generally.;copyright" line and a pointer to where the full notice is found.;Copyright (C) <year> <name of author>;Copyright (C) year name of author Gnomovision comes with ABSOLUTELY NO WARRANTY; for details type `show w'. This is free software, and you are welcome to redistribute it under certain conditions; type `show c' for details.;copyright disclaimer" for the program, if necessary. Here is a sample; alter the names.;copyright interest in the program Gnomovision' (which makes passes at compilers) written by James Hacker.
Copyright (C) 2001 Alexander S. Guy <a7r@andern.org> Andern Research Labs
Copyright (c) 2006-7 Paul Sokolovsky
Copyright (C) 2001 Carl D. Worth
Copyright 2001, Russell Nelson <opkg.py@russnelson.com> Changed render_control() to __repr__().
Copyright (C) 1995 Ian Jackson.
Copyright (c) 2006, 2008 Junio C Hamano
(c) 2003, 2004 Phil Blundell <pb@handhelds.org>
Copyright (C) 1994 X Consortium
Copyright (C) 1996-2015 Free Software Foundation, Inc. This is free software
Copyright (C) 1999-2018 Free Software Foundation, Inc. Written by Tom Tromey <tromey@cygnus.com>.
Copyright 1992-2019 Free Software Foundation, Inc.
Copyright (C) 1999-2018 Free Software Foundation, Inc.
Copyright (C) 2004-2005, 2007, 2009, 2011-2015 Free Software Foundation, Inc. Written by Scott James Remnant, 2004.
Copyright (C) 2004, 2011-2015 Free Software Foundation, Inc. Written by Scott James Remnant, 2004
Copyright (C) 1996-2001, 2003-2015 Free Software Foundation, Inc. Written by Gordon Matzigkeit, 1996
Copyright (C) 2004-2005, 2007-2008, 2011-2015 Free Software Foundation, Inc. Written by Gary V. Vaughan, 2004

LICENCE TERMS (cont.)

Copyright (C) 2004-2005, 2007-2009, 2011-2015 Free Software Foundation, Inc. Written by Gary V. Vaughan, 2004
Copyright (C) 1996-2018 Free Software Foundation, Inc. Originally written by Fran,cois Pinard <pinard@iro.umontreal.ca>, 1996.
Copyright (C) 1989, 1991 Free Software Foundation, Inc.
Copyright (C) 2010-2018 Free Software Foundation, Inc. Written by Peter Rosin <peda@lysator.liu.se>.
Copyright (C) 1996-2018 Free Software Foundation, Inc.
Copyright (C) 2010 Nikolai Kondrashov
Copyright (c) 2009,2010 Greg Kroah-Hartman <gregkh@suse.de>
Copyright (C) 1999, 2000 Thomas Sailer (sailer@ife.ee.ethz.ch)
Copyright (C) 1994-2018 Free Software Foundation, Inc.
Copyright (C) 2007 Free Software Foundation, Inc.
Copyright (C) 2010-2011 Nikolai Kondrashov
Copyright (C) 2017-2018 Michael Drake <michael.drake@codethink.co.uk>
Copyright 2016 Stephan Linz <linz@li-pro.net>
Copyright (c) 2004 Thomas Sailer <sailer@ife.ee.ethz.ch>
Copyright (C) 1992-1996, 1998-2012 Free Software Foundation, Inc.
Copyright (c) 1999 Thomas Sailer <sailer@ife.ee.ethz.ch> TH Isusb 8 "11 February 2019" "usbutils-VERSION"
"Linux USB Utilities" IX Isusb SH NAME Isusb \- list USB devices SH SYNOPSIS B Isusb
Copyright (C) 2009-2010 Nikolai Kondrashov
Copyright (C) 2010-2011 Nikolai Kondrashov
Copyright (c) 2009 Kurt Garloff <garloff@suse.de>
Copyright (c) 2010 Nikolai Kondrashov <spbnick@gmail.com>
Copyright (c) 2009-2016 Alan Stern */ To build: gcc -o usbreset usbreset.c */
Copyright (C) 2011 Free Software Foundation, Inc.
Copyright (C) 1999, 2000 Thomas Sailer (sailer@ife.ee.ethz.ch)
Copyright (C) 2017 Michael Drake <michael.drake@codethink.co.uk>
Copyright (C) 2003 Aurelien Jarno (aurelien@aurel32.net)
Copyright 2011 (c) Greg Kroah-Hartman <gregkh@suse.de>
Copyright (c) 2009 Greg Kroah-Hartman <gregkh@suse.de>
Copyright (c) 2004 Thomas Sailer <sailer@ife.ee.ethz.ch>
Copyright (c) 2009 Kay Sievers <kay.sievers@vrfy.org>
Copyright (c) 2018 Greg Kroah-Hartman <gregkh@linuxfoundation.org>
Copyright (c) 2004 Greg Kroah-Hartman <greg@kroah.com>
Copyright (C) 2013 Tom Gundersen <teg@jklm.no>
Copyright (c) 2010 Nikolai Kondrashov
Copyright (C) 1999-2001, 2003 Thomas Sailer (t.sailer@alumni.ethz.ch)
Copyright (c) 2009 Greg Kroah-Hartman <greg@kroah.com>
Copyright (c) 2018 Greg Kroah-Hartman <gregkh@linuxfoundation.org>
Copyright (C) 2004-2015 Free Software Foundation, Inc. This is free software
Copyright (C) 2010-2015 Free Software Foundation, Inc. This is free software
Copyright 1992-2019 Free Software Foundation, Inc.
Copyright (C) 2014 Free Software Foundation, Inc. This is free software
Copyright (C) 2011 Free Software Foundation, Inc. This config.lt script is free software
Copyright (C) 2002-2018 Free Software Foundation, Inc.
Copyright (C) 2001-2018 Free Software Foundation, Inc.
Copyright (C) 1997-2018 Free Software Foundation, Inc.
Copyright (C) 1999-2018 Free Software Foundation, Inc.
Copyright (C) 1996-2018 Free Software Foundation, Inc.
Copyright (C) 2003-2018 Free Software Foundation, Inc.
Copyright (C) 2009-2018 Free Software Foundation, Inc.
Copyright (C) 2006-2018 Free Software Foundation, Inc.
Copyright (C) 2004-2018 Free Software Foundation, Inc.
Copyright © 2004 Scott James Remnant <scott@netsplit.com>.
Copyright © 2012-2015 Dan Nicholson <dbn.lists@gmail.com> dnl dnl This program is free software
Copyright either version 2 of the License, or dnl (at your option)
Copyright (C) 2013 Tom Gundersen (teg@jklm.no)
Copyright (C) 2010 Nikolai Kondrashov

Copyright (c) 2005-2006 David Brownell <dbrownell@users.sourceforge.net>
Copyright (c) 2009 Kay Sievers <kay.sievers@vrfy.org>
Copyright (c) 2009 Greg Kroah-Hartman <gregkh@suse.de>
Copyright (C) 2012 Free Software Foundation, Inc.
Copyright (C) 2012 Free Software Foundation, Inc.
Copyright (C) 2010 Nikolai Kondrashov
Copyright (c) 2013,2018 Kurt Garloff <kurt@garloff.de>
Copyright (C) 2011-2018 Free Software Foundation, Inc.
Copyright (C) 1996-2001, 2003-2015 Free Software Foundation, Inc. Written by Gordon Matzigkeit, 1996
Copyright (C) 2004-2005, 2007-2009, 2011-2015 Free Software Foundation, Inc. Written by Gary V. Vaughan, 2004
Copyright (C) 2004-2005, 2007-2008, 2011-2015 Free Software Foundation, Inc. Written by Gary V. Vaughan, 2004
Copyright (C) 2004, 2011-2015 Free Software Foundation, Inc. Written by Scott James Remnant, 2004
Copyright (C) 2004-2005, 2007, 2009, 2011-2015 Free Software Foundation, Inc. Written by Scott James Remnant, 2004.
Copyright (C) 2009-2010 Nikolai Kondrashov
Copyright (c) 2004 Thomas Sailer <sailer@ife.ee.ethz.ch>
Copyright (c) 2010 Nikolai Kondrashov <spbnick@gmail.com>
Copyright 2016 Stephan Linz <linz@li-pro.net>
Copyright (c) 2009 Greg Kroah-Hartman <gregkh@suse.de>
Copyright (c) 2018 Greg Kroah-Hartman <gregkh@linuxfoundation.org>
Copyright (c) 2009,2010 Greg Kroah-Hartman <gregkh@suse.de>
Copyright (C) 2017-2018 Michael Drake <michael.drake@codethink.co.uk>
Copyright (C) 2017 Michael Drake <michael.drake@codethink.co.uk>
Copyright (c) 1999 Thomas Sailer <sailer@ife.ee.ethz.ch>
Copyright (C) 1999-2001, 2003 Thomas Sailer (t.sailer@alumni.ethz.ch)
Copyright (C) 2003-2005 David Brownell
Copyright 2011 (c) Greg Kroah-Hartman <gregkh@suse.de>
Copyright (c) 2009 Kurt Garloff <garloff@suse.de>
Copyright (c) 2013,2018 Kurt Garloff <kurt@garloff.de>
Copyright (C) 1999, 2000 Thomas Sailer (sailer@ife.ee.ethz.ch)
Copyright (C) 2013 Tom Gundersen (teg@jklm.no)
Copyright (c) 2009 Frans Pop <elendil@planet.nl>
Copyright (c) 2009 Greg Kroah-Hartman <greg@kroah.com>
Copyright (c) 2009 Randy Dunlap <rdunlap@xenotime.net>
Copyright (c) 2004 Frans Pop <elendil@planet.nl>
Copyright (c) 2004 Greg Kroah-Hartman <greg@kroah.com>
Copyright (c) 2004 Randy Dunlap <rdunlap@xenotime.net>
Copyright (C) 2013 Tom Gundersen <teg@jklm.no>
Copyright (C) 2009-2010 Nikolai Kondrashov
Copyright (c) 2010 Nikolai Kondrashov
Copyright (C) 2010 Nikolai Kondrashov
Copyright (C) 2003 Aurelien Jarno (aurelien@aurel32.net)
Copyright (c) 2009-2016 Alan Stern<
Copyright (c) 2004 Frans Pop <elendil@planet.nl>
Copyright (C) 2003-2005 David Brownell
Copyright (c) 2009 Frans Pop <elendil@planet.nl>
Copyright (C) 1994 X Consortium
Copyright (C) 1996-2015 Free Software Foundation, Inc. This is free software
Copyright (C) 1999-2018 Free Software Foundation, Inc. Written by Tom Tromey <tromey@cygnus.com>.
Copyright 1992-2019 Free Software Foundation, Inc.
Copyright (C) 1999-2018 Free Software Foundation, Inc.
Copyright (C) 2004-2005, 2007, 2009, 2011-2015 Free Software Foundation, Inc. Written by Scott James Remnant, 2004.
Copyright (C) 2004, 2011-2015 Free Software Foundation, Inc. Written by Scott James Remnant, 2004
Copyright (C) 1996-2001, 2003-2015 Free Software Foundation, Inc. Written by Gordon Matzigkeit, 1996
Copyright (C) 2004-2005, 2007-2008, 2011-2015 Free Software Foundation, Inc. Written by Gary V. Vaughan, 2004

LICENCE TERMS (cont.)

Copyright (C) 2004-2005, 2007-2009, 2011-2015 Free Software Foundation, Inc. Written by Gary V. Vaughan, 2004
Copyright (C) 1996-2018 Free Software Foundation, Inc. Originally written by Fran,cois Pinard <pinard@iro.umontreal.ca>, 1996.
Copyright (C) 1995-1997, 2000-2007, 2009-2010 by Ulrich Drepper <drepper@gnu.ai.mit.edu>
Copyright 1996-2016 Free Software Foundation, Inc. Taken from GNU libtool, 2001 Originally by Gordon Matzigkeit <gord@gnu.ai.mit.edu>, 1996
Copyright (C) 1989, 1991 Free Software Foundation, Inc.,
Copyright (C) 2000-2018 Free Software Foundation, Inc.
Copyright (C) 2010-2018 Free Software Foundation, Inc. Written by Peter Rosin <peda@lysator.liu.se>.
Copyright (C) 1991, 1999 Free Software Foundation, Inc.
Copyright (C) 1996, 1997 Theodore Ts'o.
Copyright (C) 1996-2018 Free Software Foundation, Inc.
Copyright 1996-2013 Free Software Foundation, Inc. Taken from GNU libtool, 2001 Originally by Gordon Matzigkeit <gord@gnu.ai.mit.edu>, 1996
Copyright (C) 2004-2013 Free Software Foundation, Inc.
Copyright (C) 1996, 1997, 1998 Theodore Ts'o.
Copyright (C) 2006-2010 - Karel Zak <kzak@redhat.com>
Copyright (C) 2007-2011 Free Software Foundation, Inc.
Copyright (C) 2007 Matthias Koenig <mkoenig@suse.de>
Copyright abandoned, 2000, Niels Kristian Bech Jensen <nkbj@image.dk>.
Copyright (C) 2016 Karel Zak <kzak@redhat.com>
Copyright 1999 Andreas Dilger (adilger@enel.ucalgary.ca)
Copyright (C) 2008 Cai Qian <qcai@redhat.com>
Copyright (C) 2007 Karel Zak <kzak@redhat.com>
Copyright (C) 2010 Karel Zak <kzak@redhat.com>
Copyright (C) 2010 Karel Zak <kzak@redhat.com>
Copyright (C) 2016 Stanislav Brabec <sbrabec@suse.cz>
Copyright (C) 1996, 1997, 1998, 1999 Theodore Ts'o.
Copyright (C) 2014 Ondrej Oprala <ooprala@redhat.com>
Copyright (C) 2007 Theodore Ts'o.
Copyright (C) 2011 Karel Zak <kzak@redhat.com>
Copyright (C) 2017 Philip Prindeville
Copyright (C) 2011-2017 Kareil Zak <kzak@redhat.com>
Copyright (C) 1998, 1999 Theodore Ts'o.
Copyright (C) 1996-2018 Free Software Foundation, Inc.
Copyright (c) 1988, 1990 The Regents of the University of California.
Copyright (c) 1980, 1990 The Regents of the University of California. All rights reserved.
Copyright (C) 2009 Karel Zak <kzak@redhat.com>
Copyright (c) 1989, 1990, 1993 The Regents of the University of California. All rights reserved.
Copyright (C) 2018 Ruediger Meier <ruediger.meier@ga-group.nl>
Copyright (c) 1989 The Regents of the University of California. All rights reserved.
Copyright (C) 2018 Vaclav Dolezal <vdolezal@redhat.com>
Copyright (c) 1980, 1993 The Regents of the University of California. All rights reserved.
Copyright (C) 2000 by Theodore Ts'o.
Copyright (c) 1980, 1991, 1993 The Regents of the University of California. All rights reserved.
Copyright 2001 Gunnar Ritter
Copyright (C) 2016 Sami Kerola <kerolasa@iki.fi>
Copyright (c) 2000-2001 Gunnar Ritter. All rights reserved.
Copyright (c) 1980, 1990, 1993 The Regents of the University of California. All rights reserved.
Copyright (c) 1990 The Regents of the University of California. All rights reserved.
Copyright (C) 1980 The Regents of the University of California. All rights reserved.
Copyright (c) 1980 Regents of the University of California. All rights reserved.
Copyright (C) 2004 Robert Love
Copyright (c) 1985, 1992 The Regents of the University of California. All rights reserved.
Copyright (c) 1989, 1993, 1994 The Regents of the University of California. All rights reserved.
Copyright (C) 2005 Jens Axboe <jens@axboe.dk>
Copyright (C) 2004 Robert Love

Copyright (c) 1987, 1992 The Regents of the University of California. All rights reserved.
Copyright 2001 Andreas Dilger (adilger@turbolinux.com)
Copyright (C) 1992-1996, 1998-2012 Free Software Foundation, Inc.
Copyright (C) 2010-2014 Karel Zak <kzak@redhat.com>
Copyright (C) 1994-2018 Free Software Foundation, Inc.
copyright 2009-2017 Karel Zak
Copyright (C) 2009-2014 Karel Zak <kzak@redhat.com>
Copyright (C) 2008-2009 Karel Zak <kzak@redhat.com>
Copyright (C) 2008 Kay Sievers <kay.sievers@vrfy.org>
Copyright (C) 2018 Karel Zak <kzak@redhat.com>
Copyright (C) 2001 by Andreas Dilger
Copyright (C) 2001 Andreas Dilger
copyright 2014-2018 Karel Zak
Copyright (C) 1994, 1995, 1996, 1997 Theodore Ts'o.
Copyright (C) 2014-2016 Karel Zak <kzak@redhat.com>
Copyright (C) 2000, 2001, 2003 Theodore Ts'o
Copyright (C) 2014 Ondrej Oprala <ooprala@redhat.com>
Copyright (C) 2010-2014 Karel Zak <kzak@redhat.com>
Copyright (C) 1999 by Andries Brouwer
Copyright (C) 2015 by Philipp Marek <philipp.marek@linbit.com>
Copyright (C) 2008 Karel Zak <kzak@redhat.com>
Copyright (C) 2014 Karel Zak <kzak@redhat.com>
Copyright (C) 2009 Mike Hommey <mh@glandium.org>
Copyright (C) 2009-2014 Karel Zak <kzak@redhat.com>
Copyright (C) 2009-2010 by Andreas Dilger <adilger@sun.com>
Copyright (C) 2016 Micron Technology, Inc.
Copyright (C) 2013 Alejandro Martinez Ruiz <alex@nowcomputing.com>
Copyright (C) 2008 Karel Zak <kzak@redhat.com>
Copyright (C) 2014 Karel Zak <kzak@redhat.com>
Copyright (C) 1999, 2001 by Andries Brouwer
Copyright (c) 1990, 1993 The Regents of the University of California. All rights reserved.
Copyright (C) 2018 Tony Asleson <tasleson@redhat.com>
Copyright 2007 by Theodore Ts'o. All Rights Reserved. This file may be copied under the terms of the GNU Public License.
Copyright (C) 2009 Corentin Chary <corentincj@iksaif.net>
Copyright (C) 2006 Hewlett-Packard Development Company, L.P. Huschaam Hussain <Huschaam.Hussain@hp.com> TSG Solution Alliances Engineering SAP Technology Group
Copyright (c) 1980 The Regents of the University of California. All rights reserved.
Copyright (c) 1983, 1993 The Regents of the University of California. All rights reserved.
Copyright (c) 2017 Sami Kerola
Copyright (C) 2010 Jeroen Oortwijn <oortwijn@gmail.com>
Copyright (C) 2010 Andrew Nayenko <resver@gmail.com>
Copyright (C) 2007 Theodore Ts'o
Copyright (C) 2011 by Philipp Marek <philipp.marek@linbit.com>
Copyright 2000 Andreas Dilger (adilger@turbolinux.com)
Copyright 1999 Andreas Dilger (adilger@enel.ucalgary.ca)
Copyright (C) 2013 Rolf Fokkens <rolf@fokkens.nl>
Copyright (C) 2004 Kay Sievers <kay.sievers@vrfy.org>
Copyright (C) 2012 Davidlohr Bueso <dave@gnu.org>
Copyright 1993, 1994, 1995 by Theodore Ts'o. All Rights Reserved. This file may be copied under the terms of the GNU Public License.
Copyright (c) 1997-2014 Frodo Looijaard <frodo@frodo.looijaard.name>
Copyright (C) 2018 Harry Mallon <hjmallon@gmail.com>
Copyright (c) 1988, 1993, 1994 The Regents of the University of California. All rights reserved.
Copyright 2012 Davidlohr Bueso <dave@gnu.org> May be distributed under the GNU General Public License
Copyright (C) 2001 Andreas Dilger
Copyright (c) 1983, 1990, 1993 The Regents of the University of California. All rights reserved.

LICENCE TERMS (cont.)

Copyright (C) 2017 Red Hat, Inc.
Copyright (C) 2010-2018 Red Hat, Inc. All rights reserved. Written by Milan Broz <mbroz@redhat.com> Karel Zak <kzak@redhat.com>
Copyright (C) 2018 by Kenneth Van Alstyne <kvanals@kvanals.org>
Copyright (C) 2010 by Jiro SEKIBA <jir@unicus.jp>
Copyright (C) 2010-2015 Red Hat, Inc. All rights reserved. Written by Karel Zak <kzak@redhat.com>
Copyright (C) 2017 Rafał Milecki <rafal@milecki.pl>
Copyright (C) 2004-2008 Kay Sievers <kay.sievers@vrfy.org>
Copyright (C) 2009 Red Hat, Inc. All rights reserved. Written by Karel Zak <kzak@redhat.com>
Copyright (C) 2018 Red Hat, Inc. All rights reserved. Written by Jakub Jelinek <jakub@redhat.com>
Copyright (C) 1999, Andreas Dilger and Theodore Ts'o
Copyright 2017 Red Hat, Inc.
Copyright (C) 2017 Red Hat, Inc. All rights reserved. Written by Masatake YAMATO <yamato@redhat.com>
Copyright (c) 1991, 1993 The Regents of the University of California. All rights reserved.
Copyright (C) 2009 by Bastian Friedrich <bastian.friedrich@collax.com>
Copyright 1994 Salvatore Valente (svalente@mit.edu)
Copyright (C) 2009 Red Hat, Inc.
Copyright 2009 by Karel Zak. All Rights Reserved.
Copyright (C) 2013 Karel Zak <kzak@redhat.com>
Copyright (C) 2001, 2003 Theodore Ts'o.
Copyright (C) 2008-2013 Karel Zak <kzak@redhat.com>
Copyright (C) Andries Brouwer
Copyright 2009 Red Hat, Inc. All rights reserved.
Copyright (C) 2004 Theodore Ts'o.
Copyright 2008 Tilman Schmidt (tilman@imap.cc)
Copyright (C) 2001, 2003 Theodore Y. Ts'o
Copyright 2002 Andre C. Mazzone (linuxdev@karagee.com)
Copyright 2015 Karel Zak <kzak@redhat.com>
Copyright (C) 1995, 1995 Theodore Ts'o.
Copyright (C) 1994-2005 Jeff Tranter (tranter@pobox.com)
Copyright (C) 2008-2009 Red Hat, Inc. All rights reserved. Written by Eric Sandeen <sandeen@redhat.com> Karel Zak <kzak@redhat.com>
Copyright (c) 1996-2004 Andries Brouwer
Copyright (C) 2012 Karel Zak <kzak@redhat.com>
Copyright (C) 2010 Hajime Taira <htaira@redhat.com> Masatake Yamato <yamato@redhat.com>
Copyright (c) 1983, 1991, 1993 The Regents of the University of California. All rights reserved.
Copyright (c) 2008 Roy Peled, the.roy.peled -at- gmail
Copyright (C) 2015,2016 Seagate Technology PLC Written by Shaun Tancheff <shaun.tancheff@seagate.com>
Copyright (C) 1995 Andries E. Brouwer (aeb@cwi.nl)
Copyright (C) 1993 Theodore Ts'o <tytso@athena.mit.edu>
Copyright 1992, 1993 Rickard E. Faith (faith@cs.unc.edu)
(C) 1991, 1992 Linus Torvalds. This file may be redistributed as per the GNU copyleft.
Copyright 2007 Karel Zak <kzak@redhat.com>
Copyright 1998 Andries E. Brouwer (aeb@cwi.nl)
Copyright (C) 2015 Karel Zak <kzak@redhat.com>
Copyright (c) 2008 Roy Peled, the.roy.peled -at- gmail.com
Copyright (C) 1994,1996 Alessandro Rubini (rubini@ipvvis.unipv.it)
Copyright 2012 Vivek Goyal <vgoyal@redhat.com>
Copyright (C) 2012-2013 Eric Biederman <ebiederm@xmission.com>
Copyright 1992, 1993, 1994 Rickard E. Faith (faith@cs.unc.edu) May be freely distributed.
Copyright (C) 2012 Andy Lutomiński <luto@amacapital.net>
Copyright 2010 Jason Borden <jborden@bluehost.com>
Copyright (C) 2011 Red Hat, Inc. All rights reserved. Written by Karel Zak <kzak@redhat.com>
Copyright (C) 2011 Karel Zak <kzak@redhat.com> Originally from Ted's losetup.c
Copyright (C) 2000-2002 Transmeta Corporation 2005 Adrian Bunk
Copyright 1992, 1993, 1994 Rickard E. Faith (faith@cs.unc.edu)
Copyright (C) 1992 A. V. Le Blanc (LeBlanc@mcc.ac.uk)
Copyright (c) 2007, SUSE LINUX Products GmbH Bernhard Walle <bwalle@suse.de>
Copyright 1998 Andries E. Brouwer (aeb@cwi.nl)
Copyright (C) 1999-2002 Transmeta Corporation
Copyright (C) 1993, 1994, 1995, 1996, 1997, 1998, 1999, 2000, 2001, 2002, 2003, 2004, 2005 by Theodore Ts'o.
Copyright (C) 2014-2015 Karel Zak <kzak@redhat.com>
Copyright 1993 Rickard E. Faith (faith@cs.unc.edu)
Copyright (C) 1991 Linus Torvalds 20.12.91 - time began. Got VM working yesterday by doing this by hand.
Copyright (C) 2015 Ondrej Oprala <ooprala@redhat.com>
Copyright 1992, 1993 Rickard E. Faith (faith@cs.unc.edu)
Copyright 1994 Kevin E. Martin (martin@cs.unc.edu)
Copyright 2002-2009 Red Hat, Inc. All rights reserved.
Copyright (C) 2010 Davidlohr Bueso <dave@gnu.org>
Copyright (C) 2011 Davidlohr Bueso <dave@gnu.org>
Copyright 2003-2005 H. Peter Anvin - All Rights Reserved
(C) 1991 Linus Torvalds. This file may be redistributed as per
Copyright (C) 2010 Jason Borden <jborden@bluehost.com>
Copyright (C) 2008 Hayden A. James (hayden.james@gmail.com)
Copyright (c) 1983, 1989, 1993 The Regents of the University of California. All rights reserved.
Copyright (C) 1992-1997 Michael K. Johnson, johnsonm@redhat.com
Copyright 1999 Andries E. Brouwer (aeb@cwi.nl) May be freely distributed.
Copyright (C) 2009 Mikhail Gusarov <dottedmag@dottedmag.net>
Copyright Red Hat Software, 1999, 2000
Copyright 2003-2006 H. Peter Anvin - All Rights Reserved
Copyright 2009 Johannes Berg <johannes@sipsolutions.net>
Copyright (C) 2012 Ondrej Oprala <ooprala@redhat.com>
Copyright (C) 2010 Red Hat, Inc. All rights reserved. Written by Lukas Czermer <lczerner@redhat.com> Karel Zak <kzak@redhat.com>
Copyright (C) 2000-2003, 2006, 2008-2017 Free Software Foundation, Inc.
Copyright (c) 1980, 1989, 1991 The Regents of the University of California. All rights reserved.
Copyright (C) 2000 Werner Almesberger
Copyright (C) 2010 Davidlohr Bueso <dave@gnu.org>
Copyright 2010 Lennart Poettering
Copyright 1993 Rickard E. Faith (faith@cs.unc.edu)
Copyright (C) 2009-2010 Free Software Foundation, Inc.
Copyright (c) 1980, 1991 Regents of the University of California. All rights reserved.
Copyright IBM Corp. 2011 Author(s): Heiko Carstens <heiko.carstens@de.ibm.com>,
Copyright 2008 Hayden A. James (hayden.james@gmail.com)
Copyright (c) 2016 SUSE Linux GmbH, All rights reserved.
Copyright (c) 2014 Timofey Titovets <Nefelim4ag@gmail.com>
Copyright (C) 2012-2015 Karel Zak <kzak@redhat.com>
Copyright (c) 1996 Andries Brouwer
Copyright (C) 2013, Red Hat, Inc. All rights reserved. Written by Ondrej Oprala and Karel Zak
Copyright (C) 2012 Lennart Poettering
Copyright 2011 Davidlohr Bueso <dave@gnu.org> May be distributed under the GNU General Public License
Copyright (C) 2008 Cai Qian <qcai@redhat.com>
copyright 2010-2018 Karel Zak
Copyright (C) 2008-2018 Karel Zak <kzak@redhat.com>
Copyright IBM Corp. 2016
Copyright (C) 2010-2018 Karel Zak <kzak@redhat.com>
Copyright (C) 2003-2007 Red Hat, Inc.
Copyright (C) 1992-1997 Michael K. Johnson <johnsonm@redhat.com>
Copyright (C) 2011-2018 Karel Zak <kzak@redhat.com>
Copyright (C) 2012 Red Hat, Inc. All rights reserved. Written by Lukas Czermer <lczerner@redhat.com>
Copyright IBM Corp. 2016
Copyright (C) 2018 Riku Voipio <riku.voipio@iki.fi>
Copyright (C) 2009-2018 Karel Zak <kzak@redhat.com>
Copyright 2015 Ondrej Oprala (ooprala@redhat.com)

LICENCE TERMS (cont.)

Copyright (C) 2008-2011 Free Software Foundation, Inc.
Copyright (C) 2016 David Sterba <dsterba@suse.cz>
Copyright (c) 2014 Kevin Cernekee <cernekee@gmail.com>
COPYRIGHT (C) 1986 Gary S. Brown.
Copyright (C) 2014-2018 Karel Zak <kzak@redhat.com>
Copyright 2010 Lennart Poettering
Copyright (C) 1984, 1989-1990, 2000-2015, 2018 Free Software Foundation, Inc.
Copyright (C) 2009-2013 Karel Zak <kzak@redhat.com>
Copyright (c) 1988, 1993, 1994, 2017 The Regents of the University of California. All rights reserved.
Copyright (C) 1999-2000, 2002-2017 Free Software Foundation, Inc.
Copyright (C) 2010 Karel Zak <kzak@redhat.com>
Copyright (C) 2012 Sami Kerola <kerolasa@iki.fi>
Copyright (C) 2009-2010 Free Software Foundation, Inc.
Copyright (C) 2017 Karel Zak <kzak@redhat.com>
Copyright (C) 1995,1996,1997,1998,1999,2000,2008 Theodore Ts'o.
Copyright 2014 Ondrej Oprala <ooprala@redhat.com>
Copyright 2014 Ondrej Oprala (ondrej.oprala@gmail.com)
Copyright (C) 1991-2004 Miquel van Smoorenburg.
Copyright (C) 1998-2004 Miquel van Smoorenburg.
(c) 1994 by salvatore valente <svalente@athena.mit.edu>;(c) 2012 by Cody Maloney <cmaloney@theoreticalchaos.com>
Copyright (C) 2003, 2004, 2005 Thorsten Kukuk Author: Thorsten Kukuk <kukuk@suse.de>
Copyright (C) 2010 Michael Krapp
Copyright (C) 1998-2003 Miquel van Smoorenburg.
(c) 2012 by Cody Maloney <cmaloney@theoreticalchaos.com>
Copyright (c) 1987 Regents of the University of California. All rights reserved.
Copyright (c) 1983, 1991 The Regents of the University of California. All rights reserved.
Copyright (C) 1992-2006 Free Software Foundation, Inc.
(c) 1994 by salvatore valente <svalente@athena.mit.edu>
(c) 1994 Salvatore Valente <svalente@mit.edu>
Copyright (c) 2011 SuSE LINUX Products GmbH, All rights reserved.
Copyright (C) 1991-2000 Miquel van Smoorenburg <miquels@cistron.nl>
Copyright (C) 2011 Karel Zak <kzak@redhat.com> Rewritten to PAM-only version.
Copyright (C) 1998-2006 Miquel van Smoorenburg.
(c) 1994 Martin Schulze <joey@infodrom.north.de>
(c) The contribution was provided directly to me by some other
Copyright (C) 1997 The Open Group
copyright (c) 1997-2005 by Frodo Looijaard frodo@frodo.looijaard.name>
Copyright (C) 2012 Davidlohr Bueso <dave@gnu.org> 2013 Karel Zak <kzak@redhat.com>
Copyright (C) 2007-2013 Karel Zak <kzak@redhat.com> 2012 Davidlohr Bueso <dave@gnu.org>
Copyright (C) 2007 Karel Zak <kzak@redhat.com>
Copyright (C) 2012 Karel Zak <kzak@redhat.com>
Copyright (C) 2014-2015 Karel Zak <kzak@redhat.com>
Copyright (C) 2007-2013 Karel Zak <kzak@redhat.com>
Copyright (C) 2012-2014 Karel Zak <kzak@redhat.com>
Copyright © 2004 Nilgün Belma Bugüner.
Copyright (C) 2008-2016, util-linux's authors. This file is distributed under the same license as the util-linux package.
Ray Wang <swanglei1123@gmail.com>, 2008. Wylmer Wang <wantinghard@gmail.com>, 2012, 2013, 2014, 2015, 2016. Boyuan Yang <073plan@gmail.com>, 2019. msgid "" msgstr "" Proj
Copyright © 2001, 2002, 2003, 2004, 2007, 2016, 2017, 2018, 2019 Free Software Foundation, Inc. Christian Rose <menthos@menthos.com>, 2001, 2002, 2003, 2004. Daniel Nylander <po@danielnylander.se>, 2007. Sebastian Rasmussen <sebras@gmail.com>, 2016, 2017, 2018, 2019.
Copyright (C) 2019 Free Software Foundation, Inc. og nedenstående oversættelse. This file is distributed under the same license as the util-linux package. Claus Sørensen <cs@klid.dk>, 2000. Keld Jørn Simonsen <keld@dkuug.dk>, 2000. Claus Hindsgaul <claus_h@image.dk>, 2001-2002, 2004, 2005
Copyright (C) 2004 Free Software Foundation, Inc This file is put in the public domain.
Copyright (c) 2000-2001 Gunnar Ritter. All rights reserved.

Copyright (C) 2003 Free Software Foundation Inc. This file is put in the public domain. Pavel Maryanov <acid@jakkiev.ua>, 2003, 2004, 2005, 2006, 2015. Evgeniy Yakushev <yen81@mail.ru>, 2015.
Copyright (C) 2000, 2005, 2006, 2008 Free Software Foundation, Inc. This file is distributed under the same license as the util-linux package. Marco Colombo <m.colombo@ed.ac.uk>, 2005, 2006, 2008. Beth Powell <bpowell@turbolinux.com>, 2000.
Copyright © 2015 Free Software Foundation, Inc. This file is distributed under the same license as the util-linux package. Phan Vinh Thinh <teppi82@gmail.com>, 2005-2007. Clytie Siddall <clytie@riverland.net.au>, 2007-2010. <vnwildman@gmail.com>, 2012-2014, 2015.
Copyright © 1996-2006, 2008-2018 Free Software Foundation, Inc.
Copyright (C) 2010 Free Software Foundation, Inc. This file is distributed under the same license as the util-linux package. Mikel Olasagasti Uranga <hey_neken@mundurat.net>, 2005, 2009, 2010. fuzzy
Copyright (C) 2005 Adrian Bunk <bunk@stusta.de>
Copyright (C) 2005 Free Software Foundation, Inc. This file is distributed under the same license as the util-linux package. Wei-Lun Chao <bluebat@member.fsf.org>, 2010.
Copyright (C) 2002 Free Software Foundation, Inc.
Copyright (C) 2005 Free Software Foundation, Inc. This file is distributed under the same license as the util-linux package. Andrzej Krzysztofowicz <ankry@mif.pg.gda.pl>, 2006. Jakub Bogusz <qboosh@pld-linux.org>, 2009-2019.
Copyright © 2002-2018 Lauri Nurmi <laurumi@iki.fi> Lauri Nurmi <laurumi@iki.fi>, 2002-2018. Tommi Nieminen <translator@legisign.org>, 2017.
Copyright © 2002, 2003, 2004, 2005 Free Software Foundation, Inc. Antoni Bella Perez <bella5@teletel.es>, 2002, 2003. Jordi Mallach <jordi@gnu.org>, 2004, 2005. Josep Puigdemont <josep.puigdemont@gmail.com>, 2005
Copyright (c) 2000-2001 Gunnar Ritter. All rights reserved.
Copyright (C) 2000 Beth Powell <bpowell@turbolinux.com>.
Copyright (c) 2010 Rosetta Contributors and Canonical Ltd 2010 This file is distributed under the same license as the util-linux-ng package. FIRST AUTHOR <EMAIL@ADDRESS>, 2010. Fran Dieguez <frandieguez@ubuntu.com>, 2010.
Copyright © 1999, 2000, 2001, 2014 Elrond <Elrond@Wunder-Nett.org>
Copyright (C) 2002, 2003 Free Software Foundation, Inc. Primož Peterlin <primoz.peterlin@biofiz.mf.uni-lj.si>, 2002, 2003. Simon Mihevč <simonmihevč@volja.net>
Copyright (C) 2002, 2007, 2008, 2010 Free Software Foundation, Inc. This file is distributed under the same license as the util-linux-ng package.
Copyright (C) 1999 Free Software Foundation, Inc. This file is distributed under the same license as the util-linux package. includes cfdisk original translation by Hidenobu NABETANI <nabetani@kern.phys.sci.osaka-u.ac.jp> Daisuke Yamashita <yamad@mb.infoweb.ne.jp>, 1999-2001. Makoto Kato <
Copyright © 1996-2006, 2008-2018 Free Software Foundation, Inc.
Copyright (C) 2019 Free Software Foundation, Inc.
Copyright (C) YEAR Karel Zak <kzak@redhat.com>
Copyright (c) 1989, 1993 The Regents of the University of California. All rights reserved.
Copyright (c) 1988, 1990, 1993 The Regents of the University of California. All rights reserved.
Copyright (c) 1987, 1990, 1993 The Regents of the University of California. All rights reserved.
Copyright (c) 1987, 1993 The Regents of the University of California. All rights reserved.
Copyright (c) 1989, 1990 The Regents of the University of California. All rights reserved.
Copyright 1990 Gordon Irlam (gordon@cs.ua.oz.au)
Copyright (C) 1990 Gordon Irlam (gordon@cs.ua.oz.au). Conditions of use,
Copyright (C) 2008, Karel Zak <kzak@redhat.com>
Copyright (c) 1980, 1990 Regents of the University of California. All rights reserved.
(C) 1993 E.YOUNGDALE (C) 1997-2006 J.PEARSON/J.SCHILLING (C) 2006-2007 CDRKIT TEAM ID_FS_LABEL
Copyright (C) 2011 Sami Kerola <kerolasa@iki.fi>
Copyright (C) 2014 Sami Kerola <kerolasa@iki.fi>
Copyright (C) 2011 Sami Kerola <kerolasa@iki.fi> 2011 Karel Zak <kzak@redhat.com>
Copyright (C) 2014 Federico Simoncelli <fsimonce@redhat.com>
Copyright (C) 2015 Sami Kerola <kerolasa@iki.fi>
Copyright (C) 2017 Sami Kerola <kerolasa@iki.fi>
Copyright (C) 2017 Masatake YAMATO <yamato@redhat.com>
Copyright (C) 2008 James Youngman <jay@gnu.org>
Copyright (C) 2011 Karel Zak <kzak@redhat.com> This file is part of util-linux.
Copyright (C) 2007-2018 Karel Zak <kzak@redhat.com>

LICENCE TERMS (cont.)

Copyright (C) 2004-2015 Free Software Foundation, Inc. This is free software
Copyright (C) 2010-2015 Free Software Foundation, Inc. This is free software
Copyright 1992-2019 Free Software Foundation, Inc.
Copyright (C) 2014 Free Software Foundation, Inc. This is free software
Copyright (C) 2011 Free Software Foundation, Inc. This config.lt script is free software
Copyright (C) 2008 Karel Zak <kzak@redhat.com>
Copyright (C) 2002-2018 Free Software Foundation, Inc.
Copyright (C) 2011-2018 Free Software Foundation, Inc.
Copyright (C) 2001-2018 Free Software Foundation, Inc.
Copyright (C) 1997-2018 Free Software Foundation, Inc.
Copyright (C) 1999-2018 Free Software Foundation, Inc.
Copyright (C) 1996-2018 Free Software Foundation, Inc.
Copyright (C) 2003-2018 Free Software Foundation, Inc.
Copyright (C) 2009-2018 Free Software Foundation, Inc.
Copyright (C) 2006-2018 Free Software Foundation, Inc.
Copyright (C) 2004-2018 Free Software Foundation, Inc.
Copyright (C) 1995-2014, 2016 Free Software Foundation, Inc. dnl This file is free software
Copyright (C) 2000-2002, 2007-2014, 2016 Free Software Foundation, Inc. dnl This file is free software
Copyright (C) 1996-2003, 2009-2016 Free Software Foundation, Inc. dnl This file is free software
Copyright (C) 2001-2016 Free Software Foundation, Inc. dnl This file is free software
Copyright (C) 2001-2005, 2008-2016 Free Software Foundation, Inc. dnl This file is free software
Copyright (C) 1995-2003, 2005-2006, 2008-2014, 2016 Free Software dnl Foundation, Inc. dnl This file is free software
Copyright © 2004 Scott James Remnant <scott@netsplit.com>.
Copyright © 2012-2015 Dan Nicholson <dbn.lists@gmail.com> dnl dnl This program is free software
Copyright (C) 1996-2003, 2005, 2008-2016 Free Software Foundation, Inc.
Copyright (c) 2014 Kevin Cernekee <cernekee@gmail.com>
Copyright (C) 2008-2011 Free Software Foundation, Inc.
Copyright (C) 2004-2013 Free Software Foundation, Inc.
Copyright (C) 1996-2001, 2003-2015 Free Software Foundation, Inc. Written by Gordon Matzigkeit, 1996
Copyright (C) 2014 Free Software Foundation, Inc.
Copyright (C) 2011 Free Software Foundation, Inc.
Copyright (C) 2004-2005, 2007-2009, 2011-2015 Free Software Foundation, Inc. Written by Gary V. Vaughan, 2004
Copyright (C) 2004-2005, 2007-2008, 2011-2015 Free Software Foundation, Inc. Written by Gary V. Vaughan, 2004
Copyright (C) 2004, 2011-2015 Free Software Foundation, Inc. Written by Scott James Remnant, 2004
Copyright (C) 2004-2005, 2007, 2009, 2011-2015 Free Software Foundation, Inc. Written by Scott James Remnant, 2004.
Copyright (C) 2002-2018 Free Software Foundation, Inc.
Copyright (C) 2011-2018 Free Software Foundation, Inc.
Copyright (C) 2001-2018 Free Software Foundation, Inc.
Copyright (C) 1997-2018 Free Software Foundation, Inc.
Copyright (C) 1999-2018 Free Software Foundation, Inc.
Copyright (C) 1996-2018 Free Software Foundation, Inc.
Copyright (C) 2003-2018 Free Software Foundation, Inc.
Copyright (C) 2009-2018 Free Software Foundation, Inc.
Copyright (C) 2006-2018 Free Software Foundation, Inc.
Copyright (C) 2004-2018 Free Software Foundation, Inc.
Copyright (C) 1995-2014, 2016 Free Software Foundation, Inc.
Copyright (C) 2000-2002, 2007-2014, 2016 Free Software Foundation, Inc.
Copyright (C) 1996-2003, 2009-2016 Free Software Foundation, Inc.
Copyright (C) 2001-2016 Free Software Foundation, Inc.
Copyright (C) 2001-2005, 2008-2016 Free Software Foundation, Inc.
Copyright (C) 1995-2003, 2005-2006, 2008-2014, 2016 Free Software dnl Foundation, Inc.
Copyright © 2004 Scott James Remnant <scott@netsplit.com>
Copyright © 2012-2015 Dan Nicholson <dbn.lists@gmail.com>
Copyright (C) 1996-2003, 2005, 2008-2016 Free Software Foundation, Inc.
Copyright (c) 2014 Kevin Cernekee <cernekee@gmail.com>

Copyright (C) 2008-2011 Free Software Foundation, Inc.
Copyright (C) 2004-2013 Free Software Foundation, Inc.
Copyright (C) 1996-2001, 2003-2015 Free Software Foundation, Inc. Written by Gordon Matzigkeit, 1996
Copyright (C) 2004-2005, 2007-2009, 2011-2015 Free Software Foundation, Inc. Written by Gary V. Vaughan, 2004
Copyright (C) 2004-2005, 2007-2008, 2011-2015 Free Software Foundation, Inc. Written by Gary V. Vaughan, 2004
Copyright (C) 2004, 2011-2015 Free Software Foundation, Inc. Written by Scott James Remnant, 2004
Copyright (C) 2004-2005, 2007, 2009, 2011-2015 Free Software Foundation, Inc. Written by Scott James Remnant, 2004.
Copyright (c) 1988 Mark Nudleman All rights reserved.
Copyright (c) 1992 Rik Faith (faith@cs.unc.edu)
Copyright (c) 1988 Mark Nudleman All rights reserved.
Copyright (c) 1992 Rik Faith (faith@cs.unc.edu)
Copyright (C) 2016 Karel Zak <kzak@redhat.com>
Copyright (c) 1980, 1993 The Regents of the University of California. All rights reserved.
Copyright (C) 2016 Karel Zak <kzak@redhat.com>
Copyright (c) 1980, 1993 The Regents of the University of California. All rights reserved.
Copyright (c) 2000-2001 Gunnar Ritter. All rights reserved.), program_invocation_short_name, PACKAGE_VERSION)
Copyright (C) 2010 Karel Zak <kzak@redhat.com>
Copyright (C) 2017 Karel Zak <kzak@redhat.com>
Copyright (C) 2017 Karel Zak <kzak@redhat.com>
Copyright (C) 2015 Karel Zak <kzak@redhat.com>
Copyright (C) 2012 Free Software Foundation, Inc. This configure script is free software
Copyright (C) 2012 Free Software Foundation, Inc.
Copyright (C) 2012 Free Software Foundation, Inc.
Copyright (C) 2012 Free Software Foundation, Inc. This config.status script is free software
Copyright (C) 2009 Karel Zak <kzak@redhat.com>
Copyright (C) 2003 Theodore Ts'o
Copyright (C) 2003 Theodore Ts'o
Copyright (C) 2001 Andreas Dilger
Copyright (C) 2016 Igor Gnatenko <i.gnatenko.brain@gmail.com>
Copyright (C) 1999, 2000, 2003 by Theodore Ts'o
Copyright (C) 2001 by Andreas Dilger
Copyright (C) 2004 Kay Sievers <kay.sievers@vrfy.org>
Copyright (C) 2014 Ondrej Oprala <ooprala@redhat.com>
Copyright (C) 2014 Karel Zak <kzak@redhat.com>
Copyright (C) 2005 Kay Sievers <kay.sievers@vrfy.org>
Copyright (C) 2014 Ondrej Oprala <ooprala@redhat.com>
Copyright (C) 2008 Karel Zak <kzak@redhat.com>
Copyright (C) 2012 Milan Broz <mbroz@redhat.com>
Copyright (C) 2013 Karel Zak <kzak@redhat.com> 2013 Sami Kerola <kerolasa@iki.fi>
Copyright (C) 2013 Karel Zak <kzak@redhat.com> 2013 Sami Kerola <kerolasa@iki.fi>
Copyright (C) 2018 Milan Broz <gmazyland@gmail.com>
Copyright (C) 2013 Eric Sandeen <sandeen@redhat.com>
Copyright (C) 2014 Sami Kerola <kerolasa@iki.fi>
Copyright (C) 2014 Karel Zak <kzak@redhat.com>
Copyright (C) 2014 Sami Kerola <kerolasa@iki.fi>
Copyright (C) 2013 Eric Sandeen <sandeen@redhat.com>
Copyright (C) 2017 Hewlett Packard Enterprise Development LP
Copyright (C) 2019 Karel Zak <kzak@redhat.com>
Copyright (C) 2014-2017 Pali Rohár <pali.rohar@gmail.com>
Copyright 1992 Rickard E. Faith (faith@cs.unc.edu)
copyright(C) 2017 Sami Kerola The 3-Clause BSD License
Copyright (C) 2008-2013 Karel Zak <kzak@redhat.com>
Copyright (C) 1999, 2000, 2001, 2002, 2003 Theodore Ts'o
Copyright (C) 2012 Karel Zak <kzak@redhat.com>
Copyright (c) 2003-2005 Silicon Graphics, Inc.

LICENCE TERMS (cont.)

Copyright (C) 2006-2012 Karel Zak <kzak@redhat.com>
Copyright(c) 1980, 1989, 1991 The Regents of the University of California and had been heavily modified by Rik Faith and myself. Probably no BSD text remains.) Fragments of text were written by Werner Almesberger, Remy Card, Stephen Tweedie and Eric Youngdale.
Copyright (C) 2012 Karel Zak <kzak@redhat.com>
Copyright (C) Michal Luscon <mluscon@redhat.com>
Copyright (c) 2004-2006 by Juliane Holzt, kju -at- fqdn.org
Copyright (C) 2017 Karel Zak <kzak@redhat.com>
Copyright (C) 2011 Karel Zak <kzak@redhat.com>
Copyright 1998 Andries E. Brouwer (aeb@cw.nl)
Copyright 2012 Davidlohr Bueso <dave@gnu.org>
Copyright (C) 2013 Karel Zak <kzak@redhat.com>
Copyright IBM Corp. 2011
Copyright (C) 1993, 1994 Theodore Ts'o.
Copyright 2007 Red Hat, Inc.
Copyright 2012 Red Hat, Inc.
Copyright 2007 Red Hat, Inc.
Copyright (C) 2012 Davidlohr Bueso <dave@gnu.org>
Copyright (C) 2007-2013 Karel Zak <kzak@redhat.com>
Copyright 2007 Karel Zak <kzak@redhat.com>
Copyright (C) 2009-2014 Karel Zak <kzak@redhat.com>
Copyright (C) 1994 Kevin E. Martin (martin@cs.unc.edu)
Copyright (C) 2014-2017 Karel Zak <kzak@redhat.com>
Copyright (C) 1999 Jakub Jelinek <jj@ultra.linux.cz>
Copyright (C) 2007-2014 Karel Zak <kzak@redhat.com>
Copyright (C) 2015 Karel Zak <ooprala@redhat.com>
Copyright 2010 Davidlohr Bueso <dave@gnu.org>
Copyright \co 2003\ -2006 H. Peter Anvin.
Copyright \co 2003\ -2006 H. Peter Anvin.
Copyright 2009 Marcel Holtmann <marcel@holtmann.org>
Copyright 2009 Tim Gardner <tim.gardner@canonical.com>
Copyright 2017 Sami Kerola <kerolasa@iki.fi>
Copyright (C) 2012-2014 Karel Zak <kzak@redhat.com>
Copyright (C) 2010-2013 Karel Zak <kzak@redhat.com>
Copyright (C) 1999-2008 by Theodore Ts'o
Copyright (c) 2016 Werner Fink <werner@suse.de>
Copyright (C) 1998 Andrea Arcangeli <andrea@e-mind.com>
Copyright (C) 2016 Karel Zak <kzak@redhat.com>
Copyright (C) 2016 Stanislav Brabec <sbrabec@suse.cz>
Copyright (C) 1999-2000, 2002-2017 Free Software Foundation, Inc.
Copyright (C) 2014 Karel Zak <kzak@redhat.com>
Copyright (C) 2017 Niklas Hambüchen <mail@nh2.me>
Copyright (C) 2014 Karel Zak <kzak@redhat.com>
Copyright (C) 2017 Niklas Hambüchen <mail@nh2.me>
Copyright (C) 2015 Karel Zak <kzak@redhat.com> Modified the original version from systemd project for util-linux.
Copyright (C) 2010 Davidlohr Bueso <dave@gnu.org>
Copyright (C) 2013 Ondrej Oprala <ooprala@redhat.com> Karel Zak <kzak@redhat.com>
Copyright (C) 2012 Werner Fink <werner@suse.de>
Copyright (C) 2012 SUSE Linux Products GmbH, Nuernberg
Copyright (C) 2016-2017 Karel Zak <kzak@redhat.com>
Copyright (c) 2012 Werner Fink <werner@suse.de>
Copyright (C) 1998 Danek Duvall <duvall@alumni.princeton.edu>
Copyright (c) 1980, 1987, 1988 The Regents of the University of California. All rights reserved.
Copyright (C) 1997 The Open Group
copyright (C) 1987, 88, 89, 90, 91, 92, 93, 94, 95, 96, 97 Free Software Foundation, Inc.
Copyright (C) 2012 Davidlohr Bueso <dave@gnu.org>
Copyright (c) 2000-2001 Gunnar Ritter. All rights reserved.

Copyright(c) 2000-2001 Gunnar Ritter.
Copyright (C) 1994-1999 Kevin E. Martin & aeb"
Copyright(C) 1994-1999 Kevin E. Martin & aeb"
Copyright (C) 1994-2002 Kevin E. Martin & aeb
Copyright© 1994-2002 Kevin E. Martin & aeb
Copyright (C) 2014 Karel Zak <kzak@redhat.com> "
Copyright(C) 1994-2002 Kevin E. Martin & aeb
Copyright (c) 2000-2001 Gunnar Ritter.
Copyright © 2000-2001 Gunnar Ritter.
Copyright © 1994-1999 Kevin E. Martin och aeb
Copyright © 1994-2002 Kevin E. Martin och aeb
Copyright (c) 2000-2001 Gunnar Ritter. All rights reserved.
Copyright© Gunnar Ritter, 2000—2001.
Copyright (c) 2000-2001 Gunnar Ritter. All rights reserved.
Copyright (c) 2000-2001 Gunnar Ritter. All rights reserved.
Copyright(c) 2000-2001 Gunnar Ritter.
Copyright(C) 2014 Karel Zak <kzak@redhat.com> "
Copyright (c) 2000-2001 Gunnar Ritter.
Copyright (C) 1994-2002 Kevin E. Martin & aeb
Copyright (c) 2000-2001 Gunnar Ritter. Todos los derechos reservados.
Copyright (C) 2002 Meelis Roos <mroos@linux.ee> Meelis Roos <mroos@linux.ee>, 2002
Copyright (C) 1994-2000 Kevin E. Martin & aeb
Copyright (c) 2000-2001 Gunnar Ritter.
Copyright © 2014 Karel Zak <kzak@redhat.com> "
Copyright © 1994-1999 Kevin E. Martin & aeb"
Copyright © 1994-2002 Kevin E. Martin & aeb
Copyright © 1994-1999 Kevin E. Martin i aeb"
Copyright © 1994-2002 Kevin E. Martin i aeb
Copyright © 2014 Karel Žak <kzak@redhat.com> "
Copyright (C) 2001, 2002, 2003 Santiago Vila Doncel <sanvila@unex.es>.
Copyright (C) 2014 Karel Zak <kzak@redhat.com> "
Copyright © 2001, 2002 Karl Eichwalder.
Copyright © Michael Piefel <piefel@informatik.hu-berlin.de>, 2002, 2004, 2005, 2007, 2008.
Copyright © 2011,2015,2016 Philipp Thomas <pth@suse.de>
Copyright © 2012 Arun Persaud <arun@nubati.net>
Copyright © 2014 Benjamin Weis <benjamin.weis@gmx.com>
Copyright (C) 1999, 2000, 2001 Elrond <Elrond@Wunder-Nett.org>.
Copyright (c) 2000-2001 Gunnar Ritter. Alle Rechte vorbehalten.
Copyright (c) 2000-2001 Gunnar Ritter. Tous droits reserves.
Copyright© Microsoft"
Copyright (C) 2000-2001 Gunnar Ritter. Alle rechten voorbehouden.
Copyright (c) 2000-2001 Gunnar Ritter. Todos os direitos reservados.
Copyright © Karel Zak <kzak@redhat.com> 2014 "
Copyright (C) 2019 Karel Zak <kzak@redhat.com> This file is distributed under the same license as the util-linux package. Permission is granted to freely copy and distribute this file and modified versions, provided that this header is not removed and modified versions are marked as such.
Copyright (C) 2014 Karel Zak <kzak@redhat.com>"
Copyright \co 2008 James Youngman br
Copyright \co 2008 Karel Zak PP
Copyright 1992 Rickard E. Faith (faith@cs.unc.edu)
Copyright 2000 Colin Watson (cjw44@cam.ac.uk)
Copyright (C) 2008, James Youngman <jay@gnu.org>
Copyright (C) 1994 X Consortium
Copyright (C) 1999-2018 Free Software Foundation, Inc. Written by Tom Tromey <tromey@cygnus.com>.
Copyright 1992-2019 Free Software Foundation, Inc.
Copyright (C) 1999-2018 Free Software Foundation, Inc.
Copyright (C) 2004-2005, 2007, 2009, 2011-2015 Free Software Foundation, Inc. Written by Scott James Remnant,

2004.

Copyright (C) 2004, 2011-2015 Free Software Foundation, Inc. Written by Scott James Remnant, 2004
Copyright (C) 1996-2001, 2003-2015 Free Software Foundation, Inc. Written by Gordon Matzigkeit, 1996
Copyright (C) 2004-2005, 2007-2008, 2011-2015 Free Software Foundation, Inc. Written by Gary V. Vaughan, 2004
Copyright (C) 2004-2005, 2007-2009, 2011-2015 Free Software Foundation, Inc. Written by Gary V. Vaughan, 2004
Copyright (C) 1996-2018 Free Software Foundation, Inc. Originally written by Fran,cois Pinard <pinard@iro.umontreal.ca>, 1996.
Copyright (C) 2011-2018 Free Software Foundation, Inc.
Copyright (C) 2007 Free Software Foundation, Inc. <http://fsf.org/> Everyone is permitted to copy and distribute verbatim copies of this license document, but changing it is not allowed.
Copyright (c) 2006, 2008 Junio C Hamano
Copyright (C) 2010-2018 Free Software Foundation, Inc. Written by Peter Rosin <peda@lysator.liu.se>.
Copyright (C) 1991, 1999 Free Software Foundation, Inc. 51 Franklin Street, Fifth Floor, Boston, MA 02110-1301 USA Everyone is permitted to copy and distribute verbatim copies of this license document, but changing it is not allowed.
Copyright (C) 2004, 2006 The Linux Foundation and its contributors. 660 York Street, Suite 102, San Francisco, CA 94110 USA
Copyright (c) 2005 WISeKey
Copyright (c) 2003-2006 Thomas Graf <tgraf@suug.ch>
Copyright (c) 2003-2008 Thomas Graf <tgraf@suug.ch>
Copyright (c) 2011 Thomas Graf <tgraf@suug.ch>
Copyright (c) 2016 Sushma Sitaram <sushma.sitaram@intel.com>
Copyright (c) 2015 Cong Wang <xiyou.wangcong@gmail.com>
Copyright (c) 2013 Cong Wang <xiyou.wangcong@gmail.com>
Copyright (c) 2018 Volodymyr Bendiuga <volodymyr.bendiuga@gmail.com>
Copyright (c) 2017 David Ahern <dsa@cumulusnetworks.com>
Copyright (c) 2010 Thomas Graf <tgraf@suug.ch>
Copyright (c) 2003-2011 Thomas Graf <tgraf@suug.ch>
Copyright (c) 2013 Thomas Graf <tgraf@suug.ch>
Copyright (c) 2003-2010 Thomas Graf <tgraf@suug.ch>
copyright = u'2011, Thomas Graf <tgraf@suug.ch>'

Copyright (c) 2019 Eyal Birger <eyal.birger@gmail.com>
Copyright (c) 2016 Sabrina Dubroca <sd@queasysnail.net>
Copyright (c) 2014 Susant Sahani <susant@redhat.com>
Copyright (c) 2012 Benedikt Spranger <b.spranger@linutronix.de>
Copyright (c) 2015 Beniamino Galvani <bgalvani@redhat.com>
Copyright (c) 2013 Michael Braun <michael-dev@fami-braun.de>
Copyright (c) 2011-2013 Thomas Graf <tgraf@suug.ch>
Copyright (c) 2015 Cumulus Networks. All rights reserved.
Copyright (c) 2016 Jonas Johansson <jonasj76@gmail.com>
Copyright (c) 2014 Dan Williams <dcbw@redhat.com>
Copyright (c) 2003-2012 Thomas Graf <tgraf@suug.ch>
Copyright (c) 2013 Yasunobu Chiba <yasu@dsl.gr.jp>
Copyright (c) 2016 Intel Corp. All rights reserved.
Copyright (c) 2015 Cong Wang <cwang@twopensource.com>
Copyright (c) 2003-2013 Thomas Graf <tgraf@suug.ch>
Copyright (c) 2003-2011 Thomas Graf <tgraf@suug.ch>
Copyright (c) 2008-2013 Thomas Graf <tgraf@suug.ch>
Copyright (c) 2014 Cong Wang <xiyou.wangcong@gmail.com>
Copyright (c) 2018 Volodymyr Bendiuga <volodymyr.bendiuga@westermo.se>
Copyright (c) 2012 Shriram Rajagopalan <shriram@cs.ubc.ca>
Copyright (c) 2018 Wang Jian <jianjian.wang1@gmail.com>
Copyright (c) 2010-2013 Thomas Graf <tgraf@suug.ch>
Copyright (c) 2003-2006 Thomas Graf <tgraf@suug.ch>
Copyright (c) 2008-2010 Thomas Graf <tgraf@suug.ch>
Copyright (c) 2009-2010 Thomas Graf <tgraf@suug.ch>
Copyright (c) 2017 Volodymyr Bendiuga <volodymyr.bendiuga@gmail.com>

Copyright (c) 2008-2011 Thomas Graf <tgraf@suug.ch>
Copyright (c) 2003-2012 Thomas Graf <tgraf@suug.ch>
Copyright (c) 2008 Thomas Graf <tgraf@suug.ch>
Copyright (c) 2012 Cumulus Networks, Inc
Copyright (c) 2013 Sassano Systems LLC <joe@sassanosystems.com>
Copyright (C) 2012 Texas Instruments Incorporated - http://www.ti.com/
Copyright (c) 2003-2013 Thomas Graf <tgraf@suug.ch>
Copyright (c) 2003-2008 Thomas Graf <tgraf@suug.ch>
Copyright (c) 2007, 2008 Patrick McHardy <kaber@trash.net>
Copyright (c) 2008 Patrick McHardy <kaber@trash.net>
Copyright (c) 2009-2013 Thomas Graf <tgraf@suug.ch>
Copyright (c) 2008-2009 Thomas Graf <tgraf@suug.ch>
Copyright (c) 2012 Rich Fought <Rich.Fought@watchguard.com>
Copyright (c) 2010-2011 Thomas Graf <tgraf@suug.ch>
Copyright (c) 2003-2009 Thomas Graf <tgraf@suug.ch>
(c) UCB 1986-1988 Portions taken from the KA9Q/NOS (v2.00m PA0GRI) source. Ross Biro Fred N. van Kempen, <waltje@uWalt.NL.Mugnet.ORG> Florian La Roche, Jonathan Layes <layes@loran.com> Arnaldo Carvalho de Melo <acme@conectiva.com.br> ARPHRD_HWX25
Copyright (c) 2015 Sabrina Dubroca <sd@queasysnail.net>
(c) UCB 1982-1988 Ross Biro Fred N. van Kempen, <waltje@uWalt.NL.Mugnet.ORG>
Copyright (c) 2008, Intel Corporation.
Copyright (c) 2014 Jiri Pirko <jiri@resnulli.us>
Copyright (c) 2009 Wolfgang Grandegger <wg@grandegger.com>
Copyright (c) 2014 Thomas Graf <tgraf@suug.ch>
Copyright (c) 2007, 2008 Patrick McHardy <kaber@trash.net>
Copyright (c) 2003-2009 Thomas Graf <tgraf@suug.ch>
Copyright (c) 2011 Adrian Ban <adrian.ban@mantech.ro>
Copyright (c) 2008-2009 Thomas Graf <tgraf@suug.ch>
Copyright (c) 2018 Avast software
Copyright 1999-2018 The OpenSSL Project Authors. All Rights Reserved.
Copyright 2015-2019 The OpenSSL Project Authors. All Rights Reserved.
Copyright 2011-2017 The OpenSSL Project Authors. All Rights Reserved.
Copyright 1995-2016 The OpenSSL Project Authors. All Rights Reserved.
Copyright 2000-2018 The OpenSSL Project Authors. All Rights Reserved.
Copyright 2016-2018 The OpenSSL Project Authors. All Rights Reserved.
Copyright 2017 The OpenSSL Project Authors. All Rights Reserved.
Copyright 1995-2018 The OpenSSL Project Authors. All Rights Reserved.
Copyright 1995-2019 The OpenSSL Project Authors. All Rights Reserved.
Copyright 2000-2019 The OpenSSL Project Authors. All Rights Reserved.
Copyright 2018 The OpenSSL Project Authors. All Rights Reserved.
Copyright 2016-2017 The OpenSSL Project Authors. All Rights Reserved.
Copyright 2006-2018 The OpenSSL Project Authors. All Rights Reserved.
Copyright 2015-2017 The OpenSSL Project Authors. All Rights Reserved.
Copyright 2017-2018 The OpenSSL Project Authors. All Rights Reserved.
Copyright 2005-2016 The OpenSSL Project Authors. All Rights Reserved.
Copyright 2016-2019 The OpenSSL Project Authors. All Rights Reserved.
Copyright 2015-2016 The OpenSSL Project Authors. All Rights Reserved.
Copyright 2015-2018 The OpenSSL Project Authors. All Rights Reserved.
Copyright 1995-2017 The OpenSSL Project Authors. All Rights Reserved.
Copyright 1999-2020 The OpenSSL Project Authors. All Rights Reserved.
Copyright 2006-2016 The OpenSSL Project Authors. All Rights Reserved.
Copyright 2016-2020 The OpenSSL Project Authors. All Rights Reserved.
Copyright 2014-2018 The OpenSSL Project Authors. All Rights Reserved.
Copyright 2017-2019 The OpenSSL Project Authors. All Rights Reserved.
Copyright 2007-2016 The OpenSSL Project Authors. All Rights Reserved.
Copyright 1999-2016 The OpenSSL Project Authors. All Rights Reserved.
Copyright 2004-2016 The OpenSSL Project Authors. All Rights Reserved.

LICENCE TERMS (cont.)

Copyright 2011-2016 The OpenSSL Project Authors. All Rights Reserved.
Copyright 2017 The OpenSSL Project Authors. All Rights Reserved.
Copyright 2017-2019 The OpenSSL Project Authors. All Rights Reserved.
Copyright 2013-2016 The OpenSSL Project Authors. All Rights Reserved.
Copyright 2001-2019 The OpenSSL Project Authors. All Rights Reserved.
Copyright 1995-2020 The OpenSSL Project Authors. All Rights Reserved.
Copyright 2002-2018 The OpenSSL Project Authors. All Rights Reserved.
Copyright 2014-2017 The OpenSSL Project Authors. All Rights Reserved.
Copyright 2002-2019 The OpenSSL Project Authors. All Rights Reserved.
Copyright 2011-2018 The OpenSSL Project Authors. All Rights Reserved.
Copyright 2018-2019 The OpenSSL Project Authors. All Rights Reserved.
Copyright 1998-2018 The OpenSSL Project Authors. All Rights Reserved.
Copyright 2002-2017 The OpenSSL Project Authors. All Rights Reserved.
Copyright 2002-2018 The OpenSSL Project Authors. All Rights Reserved.
Copyright 2006-2017 The OpenSSL Project Authors. All Rights Reserved.
Copyright 2000-2016 The OpenSSL Project Authors. All Rights Reserved.
Copyright 2002-2019 The OpenSSL Project Authors. All Rights Reserved.
Copyright 2001-2019 The OpenSSL Project Authors. All Rights Reserved.
Copyright 2011-2018 The OpenSSL Project Authors. All Rights Reserved.
Copyright 1999-2019 The OpenSSL Project Authors. All Rights Reserved.
Copyright 2001-2018 The OpenSSL Project Authors. All Rights Reserved.
Copyright 2011-2020 The OpenSSL Project Authors. All Rights Reserved.
Copyright 2011-2019 The OpenSSL Project Authors. All Rights Reserved.
Copyright 2017-2018 The OpenSSL Project Authors. All Rights Reserved.
Copyright 2019 The OpenSSL Project Authors. All Rights Reserved.
Copyright 2017-2020 The OpenSSL Project Authors. All Rights Reserved.
Copyright 2006-2018 The OpenSSL Project Authors. All Rights Reserved.
Copyright 2006-2019 The OpenSSL Project Authors. All Rights Reserved.
Copyright 2001-2020 The OpenSSL Project Authors. All Rights Reserved.
Copyright 2002-2020 The OpenSSL Project Authors. All Rights Reserved.
Copyright 2002-2016 The OpenSSL Project Authors. All Rights Reserved.
Copyright 2001-2018 The OpenSSL Project Authors. All Rights Reserved.
Copyright 2001-2016 The OpenSSL Project Authors. All Rights Reserved.
Copyright 2014-2016 The OpenSSL Project Authors. All Rights Reserved.
Copyright 2016 The OpenSSL Project Authors. All Rights Reserved.
Copyright 1995-2019 The OpenSSL Project Authors. All Rights Reserved.
Copyright 2001-2017 The OpenSSL Project Authors. All Rights Reserved.
Copyright 2014-2019 The OpenSSL Project Authors. All Rights Reserved.
Copyright 1995-2018 The OpenSSL Project Authors. All Rights Reserved.
Copyright 1995-2017 The OpenSSL Project Authors. All Rights Reserved.
Copyright 2005-2018 The OpenSSL Project Authors. All Rights Reserved.
Copyright 2011-2016 The OpenSSL Project Authors. All Rights Reserved.
Copyright 2004-2018 The OpenSSL Project Authors. All Rights Reserved.
Copyright 2012-2018 The OpenSSL Project Authors. All Rights Reserved.
Copyright 2004-2018 The OpenSSL Project Authors. All Rights Reserved.
Copyright 2005-2019 The OpenSSL Project Authors. All Rights Reserved.
Copyright 2002-2020 The OpenSSL Project Authors. All Rights Reserved.
Copyright 1998-2017 The OpenSSL Project Authors. All Rights Reserved.
Copyright 2006-2020 The OpenSSL Project Authors. All Rights Reserved.
Copyright 1995-2020 The OpenSSL Project Authors. All Rights Reserved.
Copyright 2015-2020 The OpenSSL Project Authors. All Rights Reserved.
Copyright 2005-2017 The OpenSSL Project Authors. All Rights Reserved.
Copyright 2004-2020 The OpenSSL Project Authors. All Rights Reserved.
Copyright 2000-2017 The OpenSSL Project Authors. All Rights Reserved.
Copyright 2000-2020 The OpenSSL Project Authors. All Rights Reserved.
Copyright 1999-2017 The OpenSSL Project Authors. All Rights Reserved.

Copyright 2008-2020 The OpenSSL Project Authors. All Rights Reserved.
Copyright 2010-2016 The OpenSSL Project Authors. All Rights Reserved.
Copyright 2001-2020 The OpenSSL Project Authors. All Rights Reserved.
Copyright 2012-2017 The OpenSSL Project Authors. All Rights Reserved.
Copyright 2008-2018 The OpenSSL Project Authors. All Rights Reserved.
Copyright 2004-2019 The OpenSSL Project Authors. All Rights Reserved.
Copyright 2000-2018 The OpenSSL Project Authors. All Rights Reserved.
Copyright 2008-2016 The OpenSSL Project Authors. All Rights Reserved.
Copyright 2008-2019 The OpenSSL Project Authors. All Rights Reserved.
Copyright 2007-2018 The OpenSSL Project Authors. All Rights Reserved.
Copyright 2004-2016 The OpenSSL Project Authors. All Rights Reserved.
Copyright 2003-2018 The OpenSSL Project Authors. All Rights Reserved.
Copyright 2003-2016 The OpenSSL Project Authors. All Rights Reserved.
Copyright 1995-2016 The OpenSSL Project Authors. All Rights Reserved.
Copyright 2018 The OpenSSL Project Authors. All Rights Reserved.
Copyright 1998-2019 The OpenSSL Project Authors. All Rights Reserved.
Copyright 2013-2019 The OpenSSL Project Authors. All Rights Reserved.
Copyright 2008-2018 The OpenSSL Project Authors. All Rights Reserved.
Copyright 2016-2017 The OpenSSL Project Authors. All Rights Reserved.
Copyright 1998-2016 The OpenSSL Project Authors. All Rights Reserved.
Copyright 2016 The OpenSSL Project Authors. All Rights Reserved.
Copyright 2016-2019 The OpenSSL Project Authors. All Rights Reserved.
Copyright 2004-2019 The OpenSSL Project Authors. All Rights Reserved.
Copyright 2013-2018 The OpenSSL Project Authors. All Rights Reserved.
Copyright (C) 1996-2015 Free Software Foundation, Inc. This is free software
Copyright 2000-2020 The OpenSSL Project Authors. All Rights Reserved.
Copyright 2007-2016 The OpenSSL Project Authors. All Rights Reserved.
copyright: 2008 Johannes Berg license: ISC, see LICENSE for details.
Copyright (c) 2008, Luis R. Rodriguez <mcgrof@gmail.com>
Copyright (c) 2005-2009, Jouni Malinen <j@w1.fi>
Copyright (c) 2003-2013, Jouni Malinen <j@w1.fi>
Copyright (c) 2012, Intel Corporation. All rights reserved.
Copyright(c) 2015 Intel Deutschland GmbH
Copyright (c) 2003-2005, Jouni Malinen <j@w1.fi>
Copyright (c) 2004-2016, Jouni Malinen <j@w1.fi>
Copyright (c) 2003-2015, Jouni Malinen <j@w1.fi>
Copyright (c) 2010, Jouni Malinen <j@w1.fi>
Copyright (c) 2002-2014, Jouni Malinen <j@w1.fi>
Copyright (c) 2004-2006, Jouni Malinen <j@w1.fi>
Copyright (c) 2002-2015, Jouni Malinen <j@w1.fi>
Copyright (c) 2002-2009, Jouni Malinen <j@w1.fi>
Copyright (c) 2002-2014, Jouni Malinen <j@w1.fi>
Copyright (c) 2004, Sam Leffler <sam@errno.com>
Copyright (c) 2016, Sabrina Dubroca <sd@queasysnail.net> and Red Hat, Inc.
Copyright (c) 2003-2011, Jouni Malinen <j@w1.fi>
Copyright (c) 2002-2010, Jouni Malinen <j@w1.fi>
Copyright (c) 2003-2019, Jouni Malinen <j@w1.fi> and contributors All Rights Reserved.
Copyright (c) 2004-2005, Jouni Malinen <j@w1.fi>
Copyright (c) 2009-2010, Jouni Malinen <j@w1.fi>
Copyright (c) 2012, Jouni Malinen <j@w1.fi>
Copyright (c) 2004-2015, Jouni Malinen <j@w1.fi>
Copyright (c) 2003-2009, Jouni Malinen <j@w1.fi>
Copyright (c) 2005, Jouni Malinen <j@w1.fi>
Copyright (c) 2009-2010, Atheros Communications
Copyright (c) 2014-2017, Jouni Malinen <j@w1.fi>
Copyright (c) 2009-2010, Atheros Communications
Copyright (c) 2011, Jouni Malinen <j@w1.fi>

Copyright (C) 2010 The Android Open Source Project
Copyright (c) 2003-2018, Jouni Malinen <j@w1.fi>
Copyright (c) 2012, Intel Corporation. All rights reserved.
Copyright (c) 2006-2007 <j@w1.fi>
Copyright (c) 2011-2012, Qualcomm Atheros
Copyright (c) 2003-2007, Jouni Malinen <j@w1.fi>
Copyright (c) 2015-2017, Jouni Malinen <j@w1.fi>
Copyright (c) 2004-2012, Jouni Malinen <j@w1.fi>
Copyright (c) 2011-2013, Qualcomm Atheros, Inc.
Copyright (c) 2003-2017, Jouni Malinen <j@w1.fi>
Copyright (c) 2011-2012, Qualcomm Atheros, Inc.
Copyright (c) 2014-2015, Jouni Malinen <j@w1.fi>
Copyright (c) 2006-2009, Jouni Malinen <j@w1.fi>
Copyright (c) 2009-2014, Jouni Malinen <j@w1.fi>
Copyright (c) 2007, Jouni Malinen <j@w1.fi>
Copyright (c) 2017, Qualcomm Atheros, Inc.
Copyright (c) 2007-2009, Jouni Malinen <j@w1.fi>
Copyright (c) 2004-2017, Jouni Malinen <j@w1.fi>
Copyright(c) 2014, Intel Mobile Communication GmbH.
Copyright (c) 2003-2012, Jouni Malinen <j@w1.fi>
Copyright (c) 2006, Dan Williams <dcw@redhat.com> and Red Hat, Inc.
Copyright (c) 2005-2006, Jouni Malinen <j@w1.fi>
Copyright (c) 2011-2012, Intel Corporation
Copyright (c) 2010-2011, Jouni Malinen <j@w1.fi>
Copyright (c) 2006, Dan Williams <dcw@redhat.com> and Red Hat, Inc.
Copyright (c) 2015, Pali Rohar <pali.rohar@gmail.com>
Copyright (c) 2009, 2012, Jouni Malinen <j@w1.fi>
Copyright (c) 2003-2009, Jouni Malinen <j@w1.fi>
Copyright (c) 2013 Cozybit, Inc.
Copyright (c) 2011, Atheros Communications, Inc.
Copyright (c) 2004-2009, Jouni Malinen <j@w1.fi>
Copyright (c) 2003-2016, Jouni Malinen <j@w1.fi>
Copyright (c) 2009, Atheros Communications
Copyright (c) 2004-2016, Jouni Malinen <j@w1.fi>
Copyright (c) 2012, Intel Corporation
Copyright (c) 2009-2019, Jouni Malinen <j@w1.fi>
Copyright (c) 2006-2007, Jouni Malinen <j@w1.fi>
Copyright (c) 2004-2019, Jouni Malinen <j@w1.fi>
Copyright (c) 2017, Qualcomm Atheros, Inc.
Copyright (c) 2003-2006, Jouni Malinen <j@w1.fi>
Copyright (c) 2015, Jouni Malinen <j@w1.fi>
Copyright (c) 2011-2013, Qualcomm Atheros, Inc.
Copyright (c) 2006, Jouni Malinen <j@w1.fi>
Copyright (c) 2008-2012, Jouni Malinen <j@w1.fi>
Copyright (c) 2003-2008, Jouni Malinen <j@w1.fi>
Copyright (c) 2010-2012, Jouni Malinen <j@w1.fi>
Copyright (c) 2004-2019, Jouni Malinen <j@w1.fi>
Copyright (c) 2009-2013, Jouni Malinen <j@w1.fi>
Copyright (c) 2017, Jouni Malinen <j@w1.fi>
Copyright (c) 2013-2014, Qualcomm Atheros, Inc.
Copyright (C) 2008 The Android Open Source Project
Copyright (c) 2003-2005, Jouni Malinen <j@w1.fi>
Copyright (c) 2012-2013, Jouni Malinen <j@w1.fi>
Copyright (c) 2014, Jouni Malinen <j@w1.fi>
Copyright (c) 2002-2005, Jouni Malinen <j@w1.fi>
Copyright (c) 2003-2019, Jouni Malinen <j@w1.fi>
Copyright (c) 2013-2014, cozybit, Inc. All rights reserved.
Copyright (c) 2004-2013, Jouni Malinen <j@w1.fi>
Copyright (c) 2003-2014, Jouni Malinen <j@w1.fi>
Copyright (c) 2009, Jouni Malinen <j@w1.fi>
Copyright (c) 2006-2011, Jouni Malinen <j@w1.fi>
Copyright (c) 2004-2014, Jouni Malinen <j@w1.fi>
copyright (c) 2003-2019, Jouni Malinen <email>j@w1.fi</email> and contributors. All Rights Reserved.</para>
Copyright (c) 2005-2015, Jouni Malinen <j@w1.fi>
Copyright (c) 2005-2008, Jouni Malinen <j@w1.fi>
Copyright (c) 2004-2007, Jouni Malinen <j@w1.fi>
Copyright (c) 2010, Dan Harkins <dharkins@lounge.org>
Copyright (c) 2004-2008, Jouni Malinen <j@w1.fi>
Copyright (c) 2004-2008, 2012-2015, Jouni Malinen <j@w1.fi>
Copyright(c) 2015 Intel Deutschland GmbH Contact Information: Intel Linux Wireless <iilw@linux.intel.com> Intel Corporation, 5200 N.E. Elam Young Parkway, Hillsboro, OR 97124-6497
Copyright (c) 2003-2009, Jouni Malinen <j@w1.fi> and contributors All Rights Reserved.
Copyright (c) 2004-2009, 2012, Jouni Malinen <j@w1.fi>
Copyright (c) 2009, Atheros Communications, Inc.
Copyright (c) 2007-2014, Jouni Malinen <j@w1.fi>
Copyright (c) 2013, Jouni Malinen <j@w1.fi>
Copyright (c) 2006, Jouni Malinen <j@w1.fi>
Copyright (c) 2013 Qualcomm Atheros, Inc.
Copyright (c) 2015, Adrian Nowicki <adinowicki@gmail.com>
Copyright (c) 2007-2009, 2012, Jouni Malinen <j@w1.fi>
Copyright (c) 2009, Atheros Communications
Copyright (c) 2006-2014, Jouni Malinen <j@w1.fi>
Copyright (c) 2005-2011, Jouni Malinen <j@w1.fi>
Copyright (c) 2006-2019, Jouni Malinen <j@w1.fi>
Copyright (c) 2011-2013 Qualcomm Atheros, Inc.
Copyright (c) 2010, Atheros Communications
Copyright (c) 2008 Bernard Gray <bernard.gray@gmail.com>
Copyright (c) 2008, Jouni Malinen <j@w1.fi>
Copyright (c) 2011, Kel Modderman <kel@otaku42.de>
Copyright (c) 2002-2019, Jouni Malinen <j@w1.fi> and contributors All Rights Reserved.
Copyright (c) 2002-2019, Jouni Malinen <j@w1.fi> and contributors All Rights Reserved.
Copyright (C) 2004, 2006 The Linux Foundation and its contributors. 660 York Street, Suite 102, San Francisco, CA 94110 USA
Copyright (c) 2012-2014, Qualcomm Atheros, Inc.
Copyright (c) 2007-2008, Jouni Malinen <j@w1.fi>
Copyright (c) 2005-2012, Jouni Malinen <j@w1.fi>
Copyright (c) 2005-2007, Jouni Malinen <j@w1.fi>
Copyright (c) 2007-2010, Jouni Malinen <j@w1.fi>
Copyright (c) 2005-2010, 2012, Jouni Malinen <j@w1.fi>
Copyright (c) 2005-2008, 2012, Jouni Malinen <j@w1.fi>
Copyright (c) 2004-2011, Jouni Malinen <j@w1.fi>
Copyright (c) 2002-2009, 2012, 2014-2015, Jouni Malinen <j@w1.fi>
Copyright (c) 2002-2009, 2011-2015, Jouni Malinen <j@w1.fi>
Copyright (c) 2005-2009, 2011, Jouni Malinen <j@w1.fi>
Copyright (c) 2005-2009, 2011-2019, Jouni Malinen <j@w1.fi>
Copyright (c) 2002-2015, Jouni Malinen <j@w1.fi>
Copyright (c) 2002-2013, Jouni Malinen <j@w1.fi>
Copyright (c) 2011-2013, Jouni Malinen <j@w1.fi>
Copyright (c) 2008-2019, Jouni Malinen <j@w1.fi>
Copyright (c) 2007-2009, Jouni Malinen <j@w1.fi>
Copyright (c) 2008-2011, Jouni Malinen <j@w1.fi>
Copyright (c) 2009, Dan Harkins <dharkins@lounge.org>
Copyright (c) 2013, Qualcomm Atheros, Inc.
Copyright (c) 2016, Jouni Malinen <j@w1.fi>

LICENCE TERMS (cont.)

Copyright (c) 2002-2009, 2012-2015, Jouni Malinen <j@w1.fi>
Copyright 2002-2003, Instant802 Networks, Inc.
Copyright (c) 2014, Qualcomm Atheros, Inc.
Copyright (c) 2015 Google, Inc.
Copyright 2003, Instant802 Networks, Inc.
Copyright (c) 2011-2014, Qualcomm Atheros, Inc.
Copyright (c) 2012, Michael Braun <michael-dev@fami-braun.de>
Copyright (c) 2002-2009, Jouni Malinen <j@w1.fi>
Copyright 2003-2006, Jouni Malinen <j@w1.fi>
Copyright (c) 2011, Atheros Communications
Copyright (c) 2002-2012, Jouni Malinen <j@w1.fi>
Copyright (c) 2016-2017, Qualcomm Atheros, Inc.
Copyright (c) 2018-2019, Toke Høiland-Jørgensen <toke@toke.dk>
Copyright (c) 2019, The Linux Foundation
Copyright 2003, Jouni Malinen <j@w1.fi>
Copyright (c) 2002-2003, Jouni Malinen <j@w1.fi>
Copyright(c) 2013 - 2016 Intel Mobile Communications GmbH.
Copyright (c) 2002-2007, Jouni Malinen <j@w1.fi>
Copyright (c) 2016, Qualcomm Atheros, Inc.
Copyright (c) 2002-2013, Jouni Malinen <j@w1.fi>
Copyright (c) 2004-2018, Jouni Malinen <j@w1.fi>
Copyright (c) 2002-2019, Jouni Malinen <j@w1.fi>
Copyright (c) 2002-2004, Instant802 Networks, Inc.
Copyright (c) 2002-2017, Jouni Malinen <j@w1.fi>
Copyright (c) 2004-2008, 2012, Jouni Malinen <j@w1.fi>
Copyright (c) 2018, Mathy Vanhoef
Copyright (c) 2014-2019, Jouni Malinen <j@w1.fi>
Copyright (c) 2012-2016, Jouni Malinen <j@w1.fi>
Copyright (c) 2002-2018, Jouni Malinen <j@w1.fi>
Copyright (c) 2012-2016, Jouni Malinen <j@w1.fi>
Copyright (c) 2010-2011, Atheros Communications, Inc.
Copyright (c) 2014-2017, Qualcomm Atheros, Inc.
Copyright (c) 2014-2017, Qualcomm Atheros, Inc.
Copyright (c) 2005-2009, Jouni Malinen <j@w1.fi>
Copyright (c) 2004-2006, 2012, Jouni Malinen <j@w1.fi>
Copyright (c) 2012-2013, Qualcomm Atheros, Inc.
Copyright (c) 2004-2007, 2012, Jouni Malinen <j@w1.fi>
Copyright (c) 2002-2006, Jouni Malinen <j@w1.fi>
Copyright (c) 2005-2019, Jouni Malinen <j@w1.fi>
Copyright (c) 2003, 2004 David Young. All rights reserved.
Copyright 2007 Andy Green <andy@warmcat.com>
Copyright (c) 2007-2012, Jouni Malinen <j@w1.fi>
Copyright (c) 2010-2011, Atheros Communications
Copyright (c) 2003-2009, 2011-2012, Jouni Malinen <j@w1.fi>
Copyright (c) 2003-2018, Jouni Malinen <j@w1.fi>
Copyright (c) 2004-2009, 2011-2015, Jouni Malinen <j@w1.fi>
Copyright (c) 2006-2018, Jouni Malinen <j@w1.fi>
Copyright (c) 2006-2015, Jouni Malinen <j@w1.fi>
Copyright (c) 2009-2015, Jouni Malinen <j@w1.fi>
Copyright (c) 2000-2003 Intel Corporation
Copyright 2008 Atheros Communications
Copyright (c) 2009-2012, Masashi Honma <masashi.honma@gmail.com>
Copyright (c) 2008-2016, Jouni Malinen <j@w1.fi>
Copyright (c) 2010, Atheros Communications, Inc.
Copyright (c) 2007-2016, Jouni Malinen <j@w1.fi>
Copyright (c) 2008-2012 Jouke Witteveen
Copyright (c) 2008, Atheros Communications

Copyright (c) 2013, Mark Kettenis
Copyright (C) 2011-2012 Texas Instruments Author: Pavan Savoy <pavan_savoy@ti.com>
Copyright (c) 1002 WiSeKey
Copyright (C) 2012 Texas Instruments Incorporated - <http://www.ti.com/>
Copyright (c) 2005 WiSeKey
Copyright (c) 2005 WiSeKey
Copyright(c) 1998 - 2010 Texas Instruments. All rights reserved. All rights reserved.
Copyright (c) 2011, Texas Instruments Incorporated.
Copyright (C) 2012 Texas Instruments Inc.
Copyright (C) 2009 Nokia Corporation
Copyright (C) 2011 Texas Instruments
Copyright 2006, 2007, 2008 Johannes Berg <johannes@sipsolutions.net>
Copyright (C) 2010 Nokia Corporation
Copyright (c) 1998 - 2009 Texas Instruments Incorporated [** ALL RIGHTS RESERVED]**
Copyright (c) 2001 ʘ 2013 Texas Instruments Incorporated
Copyright (c) 2003-2019, Jouni Malinen <j@w1.fi>
Copyright (c) 2008-2014, Jouni Malinen <j@w1.fi>
Copyright (c) 2003-2012, Jouni Malinen <j@w1.fi>
Copyright (c) 2002-2019, Jouni Malinen <j@w1.fi>
Copyright 2004-2020 The OpenSSL Project Authors. All Rights Reserved.
Copyright 2005 Henrik Brix Andersen <brix@gentoo.org>
Copyright 2010-2020 The OpenSSL Project Authors. All Rights Reserved.
Copyright (c) 2005-2007, 2012-2017, Jouni Malinen <j@w1.fi>
Copyright (c) 2004-2019, Jouni Malinen <j@w1.fi> and contributors
Copyright (c) 2002-2019, Jouni Malinen <j@w1.fi> and contributors
Copyright 2015-2020 The OpenSSL Project Authors. All Rights Reserved.
Copyright (c) 2002-2016, Jouni Malinen <j@w1.fi>
Copyright 2013-2020 The OpenSSL Project Authors. All Rights Reserved.
Copyright 2014-2020 The OpenSSL Project Authors. All Rights Reserved.
Copyright 2012-2020 The OpenSSL Project Authors. All Rights Reserved.
Copyright (c) 2004-2019, Jouni Malinen <j@w1.fi> and contributors
Copyright (c) 2004, Jouni Malinen <j@w1.fi>
Copyright 2011-2019 The OpenSSL Project Authors. All Rights Reserved.
Copyright 2010-2018 The OpenSSL Project Authors. All Rights Reserved.
Copyright 2007-2020 The OpenSSL Project Authors. All Rights Reserved.
Copyright (c) 2013, Jouni Malinen <j@w1.fi> and contributors All Rights Reserved.
Copyright 2005-2020 The OpenSSL Project Authors. All Rights Reserved.
Copyright 1998-2020 The OpenSSL Project Authors. All Rights Reserved.
Copyright 2009-2020 The OpenSSL Project Authors. All Rights Reserved.
Copyright 2011-2020 The OpenSSL Project Authors. All Rights Reserved.
Copyright (c) 2018, The Linux Foundation
Copyright 2009-2019 The OpenSSL Project Authors. All Rights Reserved.
Copyright 2013-2018 The OpenSSL Project Authors. All Rights Reserved.
Copyright 2013-2016 The OpenSSL Project Authors. All Rights Reserved.
Copyright 2012-2016 The OpenSSL Project Authors. All Rights Reserved.
Copyright 2013-2020 The OpenSSL Project Authors. All Rights Reserved.
Copyright 2010-2020 The OpenSSL Project Authors. All Rights Reserved.
Copyright 2010-2019 The OpenSSL Project Authors. All Rights Reserved.
Copyright 2018-2020 The OpenSSL Project Authors. All Rights Reserved.
Copyright (c) 2010-2013, Jouni Malinen <j@w1.fi>
Copyright (c) 2010-2015, Jouni Malinen <j@w1.fi>
Copyright 2014-2020 The OpenSSL Project Authors. All Rights Reserved.
Copyright 2000-2019 The OpenSSL Project Authors. All Rights Reserved.
Copyright 2004-2017 The OpenSSL Project Authors. All Rights Reserved.
Copyright (c) 2014, Intel Corporation
Copyright (c) 2013-2016, Jouni Malinen <j@w1.fi>
Copyright (c) 2015, Intel Deutschland GmbH

LICENCE TERMS (cont.)

Copyright (c) 2013, Intel Corporation
Copyright (c) 2015, Qualcomm Atheros, Inc.
Copyright 2008-2020 The OpenSSL Project Authors. All Rights Reserved.
Copyright (c) 2013-2019, Jouni Malinen <j@w1.fi>
Copyright (c) 2013, Luciano Coelho <luciano.coelho@intel.com>
Copyright (c) 2014, cozybit Inc.
Copyright 2006-2016 The OpenSSL Project Authors. All Rights Reserved.
Copyright (c) 2013-2014, Jouni Malinen <j@w1.fi>
Copyright (c) 2015, Jouni Malinen
Copyright (c) 2018-2019, Jouni Malinen <j@w1.fi>
Copyright (c) 2013-2015, Jouni Malinen <j@w1.fi>
Copyright (c) 2014-2015, Qualcomm Atheros, Inc.
Copyright (c) 2015-2017, Qualcomm Atheros, Inc.
Copyright (c) 2013, Qualcomm Atheros, Inc.
"Copyright (c) 2015 Intel Corporation"
Copyright (c) 2014, Jouni Malinen <j@w1.fi>
Copyright (c) 2013-2017, Jouni Malinen <j@w1.fi>
Copyright (c) 2014-2016, Jouni Malinen <j@w1.fi>
Copyright 2007-2020 The OpenSSL Project Authors. All Rights Reserved.
Copyright 2002-2020 The OpenSSL Project Authors. All Rights Reserved.
Copyright 2015-2016 The OpenSSL Project Authors. All Rights Reserved.
Copyright (c) 2016, Intel Deutschland GmbH
"Copyright (c) 2007 Johannes Berg <johannes@sipsolutions.net>"
"Copyright (c) 2014 Intel Corporation"
Copyright 2015-2018 The OpenSSL Project Authors. All Rights Reserved.
Copyright (c) 2017, Jouni Malinen
Copyright (c) 2014, Qualcomm Atheros, Inc.
Copyright (c) 2019, Jouni Malinen <j@w1.fi>
Copyright 2017-2020 The OpenSSL Project Authors. All Rights Reserved.
Copyright (c) 2013-2018, Jouni Malinen <j@w1.fi>
Copyright (c) 2011-2019, Jouni Malinen <j@w1.fi>
Copyright (c) 2015-2019, Jouni Malinen <j@w1.fi>
Copyright 2007-2018 The OpenSSL Project Authors. All Rights Reserved.
Copyright 2003-2019 The OpenSSL Project Authors. All Rights Reserved.
Copyright (c) 2016, Tieto Corporation
Copyright (C) 2019 Free Software Foundation, Inc. This is free software
Copyright (C) 1994-2018 Free Software Foundation, Inc.
Copyright (C) 1996-2018 Free Software Foundation, Inc.
Copyright (c) 2013 Nicolas PLANEL <nicolas.planel@enovance.com>
Copyright (C) 2012 Free Software Foundation, Inc. This config.status script is free software
Copyright (C) 1992-1996, 1998-2012 Free Software Foundation, Inc.
Copyright (C) 1984, 1989-1990, 2000-2015, 2018-2019 Free Software Foundation, Inc.
Copyright (c) 2005-2010 W3C (MIT, ERCIM, Keio), All Rights Reserved. W3C liability, trademark, document use and software licensing rules apply, see:
Copyright (c) 2002-2017, Jouni Malinen <j@w1.fi>
Copyright 2006-2010 Johannes Berg <johannes@sipsolutions.net>
Copyright (C) 2012 Free Software Foundation, Inc. This config.status script is free software; the Free Software Foundation gives unlimited permission to copy, distribute and modify it."
Copyright (C) {2011} Texas Instruments Incorporated - <http://www.ti.com/>
Copyright (c) 1998-2020 The OpenSSL Project
Copyright 20xx-20yy The OpenSSL Project Authors. All Rights Reserved.
Copyright (C) 2014 Free Software Foundation, Inc. This is free software
Copyright (C) 2003-2010 Thomas Graf <tgraf@redhat.com>
Copyright (C) 1989, 1991 Free Software Foundation, Inc. 59 Temple Place - Suite 330, Boston, MA 02111-1307, USA. Everyone is permitted to copy and distribute verbatim copies of this license document, but changing it is not allowed.
Copyright 2013 M. J. Dominus. You may copy and distribute this program under the same terms as Perl itself. If in doubt, write to mjd-perl-template+@plover.com for a license.
Copyright 2013 Mark Jason Dominus
Copyright 1998-2001 The OpenSSL Project Authors. All Rights Reserved.
Copyright 2016-2016 The OpenSSL Project Authors. All Rights Reserved.
Copyright 1995-2023 The OpenSSL Project Authors. All Rights Reserved.
Copyright 2014-2017 The OpenSSL Project Authors. All Rights Reserved.
Copyright 2016-2018 The OpenSSL Project Authors. All Rights Reserved.
Copyright 1999-2019 The OpenSSL Project Authors. All Rights Reserved.
Copyright 2015-2019 The OpenSSL Project Authors. All Rights Reserved.
Copyright (c) 1998-2019 The OpenSSL Project. All rights reserved.
Copyright 2012-2019 The OpenSSL Project Authors. All Rights Reserved.
Copyright 2013-2017 The OpenSSL Project Authors. All Rights Reserved.
Copyright 1992-2019 Free Software Foundation, Inc.
Copyright (C) 2014 Free Software Foundation, Inc. This is free software
Copyright (C) 2011 Free Software Foundation, Inc. This config.lt script is free software
Copyright (c) 2015 David Ahern <dsa@cumulusnetworks.com>
Copyright (c) 2016 Jef Oliver <jef.oliver@intel.com>
Copyright (c) 2005 Petr Gotthard <petr.gotthard@siemens.com>
Copyright (c) 2005 Siemens AG Oesterreich
Copyright (c) 2006 Petr Gotthard <petr.gotthard@siemens.com>
Copyright (c) 2006 Siemens AG Oesterreich
Copyright (c) 2003-2006 Baruch Even <baruch@ev-en.org>, Mediatrix Telecom, inc. <ericb@mediatrix.com>
Copyright (c) 2005-2006 Petr Gotthard <petr.gotthard@siemens.com>
Copyright (c) 2005-2006 Siemens AG Oesterreich
Copyright (c) 2007 Philip Craig <philipc@snapgear.com>
Copyright (c) 2007 Secure Computing Corporation
Copyright (c) 2007 Secure Computing Corporation
Copyright (c) 2012 Rich Fought <rich.fought@watchguard.com>
Copyright (c) 2008 Patrick McHardy <kaber@trash.net>
Copyright (c) 2008-2009 Thomas Graf <tgraf@suug.ch>
Copyright (c= 2008 Patrick McHardy <kaber@trash.net>
Copyright (c) 2010 Karl Hiramoto <karl@hiramoto.org>
Copyright (c) 2013 Sassano Systems LLC <joe@sassanosystems.com>
Copyright (c= 2008 Patrick McHardy <kaber@trash.net>
Copyright (C) 2003-2010 Thomas Graf <tgraf@redhat.com>\n"
Copyright 2017 BaishanCloud. All rights reserved.
Copyright (c) 2017, Oracle and/or its affiliates. All rights reserved.
Copyright (c) 2002, Oracle and/or its affiliates. All rights reserved
Copyright 2011 Google Inc.
Copyright 2014 Cryptography Research, Inc.
Copyright 2014-2016 Cryptography Research, Inc.
Copyright 2016 Cryptography Research, Inc.
Copyright 2015-2016 Cryptography Research, Inc.
Copyright 2015 Cryptography Research, Inc.
Copyright (c) 2002, Oracle and/or its affiliates. All rights reserved
Copyright 2005 Nokia. All rights reserved.
Copyright (C) 2006, Network Resonance, Inc. Copyright (C) 2011, RTFM, Inc.
Copyright (c) 2004, EdelKey Project. All Rights Reserved.
Copyright (c) 2013-2014 Timo Teräs <timo.teras@gmail.com>
Copyright (c) 2004 Kungliga Tekniska Högskolan Royal Institute of Technology, Stockholm, Sweden). All rights reserved.
Copyright (c) 2004, Richard Levitte <richard@levitte.org> All rights reserved.
Copyright (c) 2017, Oracle and/or its affiliates. All rights reserved.
Copyright (c) 2017 National Security Research Institute. All rights reserved.
Copyright (c) 2018, Oracle and/or its affiliates. All rights reserved.
Copyright 2012, Samuel Neves <sneves@dei.uc.pt> More information about the BLAKE2 hash function and its implementations can be found at <https://blake2.net>.

LICENCE TERMS (cont.)

Copyright (C) 2017 National Security Research Institute. All Rights Reserved.
Copyright (c) 2004, 2018, Richard Levitte <richard@levitte.org> All rights reserved.
Copyright (C) 2004-2015 Free Software Foundation, Inc. This is free software
Copyright (C) 2010-2015 Free Software Foundation, Inc. This is free software
Copyright (c) 2002 The OpenTSA Project. All rights reserved.
Copyright (c) 2007 KISA(Korea Information Security Agency). All rights reserved.
Copyright (c) 2008, Johannes Berg <johannes@sipsolutions.net>
Copyright (c) 2008, Michael Green <Michael.Green@Atheros.com>
Copyright (c) 2004, Gunter Burchardt <tira@isx.de>
Copyright (c) 2002-2014, Jouni Malinen <j@w1.fi>
Copyright (c) 2007, Johannes Berg <johannes@sipsolutions.net>
Copyright (c) 2009-2010, Atheros Communications
Copyright (c) 2004-2016, Roshan Pius <rpius@google.com>
Copyright (c) 2003-2004, Instant802 Networks, Inc.
Copyright (c) 2005-2006, Devicescape Software, Inc.
Copyright (c) 2004, 2Wire, Inc
Copyright (c) 2019, The Linux Foundation
Copyright (c) 2009, Atheros Communications
Copyright (c) 2011, Qualcomm Atheros
Copyright (c) 2010-2014, Jouni Malinen <j@w1.fi>
"Copyright 2015 Intel Deutschland GmbH"
Copyright (c) 2007-2017, Jouni Malinen <j@w1.fi> and " contributors\n"
Copyright(c) 2014, Intel Corporation. All rights reserved.
Copyright (c) 2009-2010, Witold Sowa <witold.sowa@gmail.com>
Copyright (c) 2009, Jouni Malinen <j@w1.fi>
Copyright (c) 2009-2010, Witold Sowa <witold.sowa@gmail.com>
Copyright (c) 2009-2015, Jouni Malinen <j@w1.fi>
Copyright (c) 2009, Witold Sowa <witold.sowa@gmail.com>
Copyright (c) 2009, Witold Sowa <witold.sowa@gmail.com>
Copyright (c) 2010, Jouni Malinen <j@w1.fi>
Copyright (c) 2011-2012, Qualcomm Atheros, Inc.
Copyright (c) 2004-2019, Jouni Malinen <j@w1.fi> and contributors"
Copyright (c) 2018-2019, The Linux Foundation
Copyright (c) 2011-2014, Jouni Malinen <j@w1.fi>
Copyright (c) 2011-2014, Qualcomm Atheros, Inc.
Copyright (c) 2011-2013, Qualcomm Atheros, Inc.
Copyright (c) 2003-2015,\n" Jouni Malinen <j@w1.fi>\n" and contributors.\n"
copyright(c) The contribution was provided directly to me by some other
Copyright (c) 2002-2019, Jouni Malinen <j@w1.fi> and contributors All Rights Reserved.
Copyright (c) 2002-2019, Jouni Malinen <j@w1.fi> and contributors All Rights Reserved.
Copyright (c) 2002-2019, Jouni Malinen <j@w1.fi> and contributors All Rights Reserved.
Copyright 2005-2006, Devicescape Software, Inc.
Copyright 2005-2006, Devicescape Software, Inc.
Copyright (c) 2006, Devicescape Software, Inc.
Copyright 2003-2004, Instant802 Networks, Inc.
Copyright (c) 2013, Qualcomm Atheros, Inc.
Copyright (c) 2007-2008, Intel Corporation
Copyright (c) 2019 John Crispin <john@phrozen.org>
Copyright(c) 2011 - 2016 Intel Corporation. All rights reserved.
Copyright(c) 2011 - 2016 Intel Corporation. All rights reserved.
Copyright (c) 2016-2017, Jouni Malinen <j@w1.fi>
Copyright (c) 2011-2017, Qualcomm Atheros
Copyright (c) 2013-2017, Qualcomm Atheros, Inc.
Copyright 2005, Devicescape Software, Inc.
Copyright (c) 2005-2006, Devicescape Software, Inc.
Copyright (c) 2011-2017, Qualcomm Atheros, Inc.
Copyright (c) 2011-2012, Qualcomm Atheros

Copyright (c) 2015, Qualcomm Atheros, Inc.
Copyright (c) 2005, Sam Leffler <sam@errno.com>
Copyright 2009 Johannes Berg <johannes@sipsolutions.net>
Copyright(c) 2015 Intel Deutschland GmbH
Copyright (c) 2006-2007 Sony Corporation
Copyright (c) 2008-2009 Atheros Communications
Copyright (c) 2006-2007 Sony Corporation
Copyright (c) 2008-2009 Atheros Communications
Copyright (c) 2009-2010, Jouni Malinen <j@w1.fi>
Copyright 2008 Atheros Communications.
Copyright (c) 2006-2007 Sony Corporation. All Rights Reserved.
Copyright (c) 2000-2003 Intel Corporation All rights reserved.
Copyright (c) 2006-2007 Sony Corporation
Copyright (c) 2008-2009 Atheros Communications
Copyright (c) 2009-2010, Jouni Malinen <j@w1.fi>
Copyright 2008 Atheros Communications.
Copyright (c) 2006-2007 Sony Corporation. All Rights Reserved.
Copyright (c) 2000-2003 Intel Corporation All rights reserved.
Copyright (c) 2009-2010, Jouni Malinen <j@w1.fi>
Copyright 2008 Atheros Communications.
Copyright (c) 2006-2007 Sony Corporation. All Rights Reserved.
Copyright (c) 2000-2003 Intel Corporation All rights reserved.
Copyright (c) 2009-2013, Jouni Malinen <j@w1.fi>
Copyright (c) 2009-2010, Jouni Malinen <j@w1.fi>
Copyright (c) 2004, Gunter Burchardt <tira@isx.de>
Copyright (c) 2013-2014, Qualcomm Atheros, Inc.
Copyright (c) 2004, Video54 Technologies
Copyright (c) 2005-2007, Jouni Malinen <j@w1.fi>
Copyright (c) 2007, 2008, Johannes Berg <johannes@sipsolutions.net>
"Copyright (c) 2007, Andy Lutomirski"
Copyright (c) 2007, Mike Kershaw
Copyright (c) 2008-2009, Luis R. Rodriguez <mcgrof@gmail.com>
Copyright (c) 2007, 2008, Johannes Berg <johannes@sipsolutions.net>
"Copyright (c) 2007, Andy Lutomirski"
Copyright (c) 2007, Mike Kershaw
Copyright (c) 2008-2009, Luis R. Rodriguez <mcgrof@gmail.com>
Copyright (c) 2007, 2008, Johannes Berg <johannes@sipsolutions.net>
"Copyright (c) 2007, Andy Lutomirski"
Copyright (c) 2007, Mike Kershaw
Copyright (c) 2008-2009, Luis R. Rodriguez <mcgrof@gmail.com>
Copyright (c) 2007, 2008, Johannes Berg <johannes@sipsolutions.net>
"Copyright (c) 2007, Andy Lutomirski"
Copyright (c) 2007, Mike Kershaw
Copyright (c) 2008-2009, Luis R. Rodriguez <mcgrof@gmail.com>
copyright 40 OWNER OR CONTRIBUTORS BE LIABLE FOR ANY DIRECT, INDIRECT, INCIDENTAL, 41 SPECIAL, EXEMPLARY, OR CONSEQUENTIAL DAMAGES (INCLUDING, BUT NOT 42 LIMITED TO, PROCUREMENT OF SUBSTITUTE GOODS OR SERVICES COPYRIGHT LOSS OF USE, 43 DATA, OR PROFITS
Copyright 2008 Michael Wu <flamingice@sourmilk.net>
Copyright 2008 Luis Carlos Cobo <luisca@cozybit.com>
Copyright 2008 Michael Buesch <mb@bu3sch.de>
Copyright 2008, 2009 Luis R. Rodriguez <lrodriguez@atheros.com>
Copyright 2008 Jouni Malinen <jouni.malinen@atheros.com>
Copyright 2008 Colin McCabe <colin@cozybit.com>
Copyright (c) 2003-2019, Jouni Malinen <j@w1.fi> and contributors"
Copyright (c) 2003-2019, Jouni Malinen <j@w1.fi> and contributors"
Copyright (c) 2003-2019, Jouni Malinen <j@w1.fi> and contributors"
Copyright 2017 Ribose Inc. All Rights Reserved.
Copyright 2017 Ribose Inc. All Rights Reserved. Ported from Ribose contributions from Botan.
Copyright (c) 2002-2019, Jouni Malinen <j@w1.fi> " and contributors\n"
Copyright (c) 2002-2019, Jouni Malinen <j@w1.fi> and contributors

LICENCE TERMS (cont.)

Copyright (c) 2005-2017, Jouni Malinen <j@w1.fi>\n"
Copyright (c) 2004, Richard Levitte <richard@levitte.org> All rights reserved.
Copyright (c) 2012, Intel Corporation. All Rights Reserved.
Copyright 1998-\$YEAR The OpenSSL Project Authors. All Rights Reserved.
Copyright 2000-2016 The OpenSSL Project Authors. All Rights Reserved.
Copyright (c) 2012-2016 Jean-Philippe Aumasson
Copyright (c) 2012-2014 Daniel J. Bernstein
Copyright (c) 2012-2016 Jean-Philippe Aumasson
Copyright (c) 2012-2014 Daniel J. Bernstein
Copyright (c) 2014, Intel Corporation. All Rights Reserved.
Copyright (c) 2014, Intel Corporation. All Rights Reserved.
Copyright (c) 2015 CloudFlare, Inc.
Copyright (c) 2015, CloudFlare, Inc.
Copyright 2000-\$YEAR The OpenSSL Project Authors. All Rights Reserved. Licensed under the OpenSSL license (the "License"). You may not use this file except in compliance with the License. You can obtain a copy in the file LICENSE in the source distribution or at <https://www.openssl.org>
Copyright 1995-\$YEAR The OpenSSL Project Authors. All Rights Reserved. Licensed under the OpenSSL license (the "License"). You may not use this file except in compliance with the License. You can obtain a copy in the file LICENSE in the source distribution or at <https://www.openssl.org>
Copyright (c) 2008 Andy Polyakov <appro@openssl.org>
Copyright 2006 NTT (Nippon Telegraph and Telephone Corporation) . ALL RIGHTS RESERVED.
Copyright 2000-\$YEAR The OpenSSL Project Authors. All Rights Reserved.
Copyright (c) 2017, Jouni Malinen <j@w1.fi>
Copyright (c) 2013-2015, Jouni Malinen <j@w1.fi>
Copyright Patrick Powell 1995 This code is based on code written by Patrick Powell <papowell@astart.com> It may be used for any purpose as long as this notice remains intact on all source code distributions.
"Copyright (c) 2014 Intel Corporation"
Copyright 2004-2014, Akamai Technologies. All Rights Reserved.
Copyright (c) 2015, Intel Mobile Communications GmbH
Copyright (c) 2013, Intel Corporation
Copyright (C) 2019 Free Software Foundation, Inc. This is free software
Copyright (c) 2008-2012, Jouni Malinen <j@w1.fi>
Copyright © 2004 Scott James Remnant <scott@netsplit.com>.
Copyright © 2012-2015 Dan Nicholson <dbn.lists@gmail.com> dnl dnl This program is free software
Copyright either version 2 of the License, or dnl (at your option)
Copyright (C) 2002-2018 Free Software Foundation, Inc.
Copyright (C) 2011-2018 Free Software Foundation, Inc.
Copyright (C) 2001-2018 Free Software Foundation, Inc.
Copyright (C) 1997-2018 Free Software Foundation, Inc.
Copyright (C) 1999-2018 Free Software Foundation, Inc.
Copyright (C) 1996-2018 Free Software Foundation, Inc.
Copyright (C) 2003-2018 Free Software Foundation, Inc.
Copyright (C) 2009-2018 Free Software Foundation, Inc.
Copyright (C) 2006-2018 Free Software Foundation, Inc.
Copyright (C) 2004-2018 Free Software Foundation, Inc.
Copyright (c) 2008-2011, Jouni Malinen <j@w1.fi>
Copyright (C) 2012 Free Software Foundation, Inc. This configure script is free software
Copyright (C) 2012 Free Software Foundation, Inc. This config.status script is free software
Copyright (c) 2010-2013 Thomas Graf <tgraf@suug.ch>
Copyright (c) 2007-2008 Intel Corporation
Copyright 2008 Michael Buesch <m@buesch.ch>
Copyright 2008 Colin McCabe <colin@cozybit.com>
"Copyright 2015-2017 Intel Deutschland GmbH"
Copyright (C) 2018-2019 Intel Corporation
Copyright (c) 1995-1998 Eric A. Young, Tim J. Hudson All rights reserved.
Copyright (C) 1996-2015 Free Software Foundation, Inc. This is free software
Copyright (C) 2003-2010 Thomas Graf <tgraf@redhat.com>

Copyright (C) 19yy <name of author>
Copyright (C) 19yy name of author Gnomovision comes with ABSOLUTELY NO WARRANTY
Copyright (C) 19yy <name of author>
Copyright (C) 19yy name of author Gnomovision comes with ABSOLUTELY NO WARRANTY
Copyright 2013 Mark Jason Dominus
Copyright 2017 [Ribose Inc.](<https://www.ribose.com>). All Rights Reserved.
Copyright (c) 2016 Viktor Dukhovni <openssl-users@dukhovni.org>. All rights reserved.
Copyright 2016 VMS Software, Inc. All Rights Reserved.
Copyright 1995-\$YEAR The OpenSSL Project Authors. All Rights Reserved.
Copyright", "Copyright 1998-\$YEAR The OpenSSL Authors. All rights reserved.
Copyright 2014-2017 The OpenSSL Project Authors. All Rights Reserved.
Copyright 2013-2018 The OpenSSL Project Authors. All Rights Reserved.
Copyright 2013-2018 The OpenSSL Project Authors. All Rights Reserved.
Copyright 1995-\$YEAR The OpenSSL Project Authors. All Rights Reserved.
Copyright 1999-\$YEAR The OpenSSL Project Authors. All Rights Reserved.
Copyright (C) 1995-1998 Eric Young (eay@cryptsoft.com) All rights reserved.
Copyright (C) 1995-1998 Eric Young (eay@cryptsoft.com) All rights reserved.
Copyright 2017-2018 The OpenSSL Project Authors. All Rights Reserved.
Copyright 2017-2020 The OpenSSL Project Authors. All Rights Reserved.
Copyright 2000-2017 The OpenSSL Project Authors. All Rights Reserved.
Copyright 2000-2018 The OpenSSL Project Authors. All Rights Reserved.
Copyright 2003-2017 The OpenSSL Project Authors. All Rights Reserved.
Copyright 2016-2018 The OpenSSL Project Authors. All Rights Reserved.
Copyright 2018-2019 The OpenSSL Project Authors. All Rights Reserved.
Copyright 2016-2017 The OpenSSL Project Authors. All Rights Reserved.
Copyright 2000-2019 The OpenSSL Project Authors. All Rights Reserved.
Copyright 2018-2020 The OpenSSL Project Authors. All Rights Reserved.
Copyright 2017-2019 The OpenSSL Project Authors. All Rights Reserved.
Copyright 2019 The OpenSSL Project Authors. All Rights Reserved.
Copyright 2018 The OpenSSL Project Authors. All Rights Reserved.
Copyright 2016-2019 The OpenSSL Project Authors. All Rights Reserved.
Copyright 2002-2016 The OpenSSL Project Authors. All Rights Reserved.
Copyright 2001-2018 The OpenSSL Project Authors. All Rights Reserved.
Copyright 2001-2019 The OpenSSL Project Authors. All Rights Reserved.
Copyright 2016 The OpenSSL Project Authors. All Rights Reserved.
Copyright 2009-2016 The OpenSSL Project Authors. All Rights Reserved.
Copyright 2001-2016 The OpenSSL Project Authors. All Rights Reserved.
Copyright 2000-2020 The OpenSSL Project Authors. All Rights Reserved.
Copyright 2017 The OpenSSL Project Authors. All Rights Reserved.
Copyright 2009-2019 The OpenSSL Project Authors. All Rights Reserved.
Copyright 2015-2020 The OpenSSL Project Authors. All Rights Reserved.
Copyright 2008-2016 The OpenSSL Project Authors. All Rights Reserved.
Copyright 2020 The OpenSSL Project Authors. All Rights Reserved.
Copyright 2015-2016 The OpenSSL Project Authors. All Rights Reserved.
Copyright 2002-2018 The OpenSSL Project Authors. All Rights Reserved.
Copyright 2012-2018 The OpenSSL Project Authors. All Rights Reserved.
Copyright 2001-2017 The OpenSSL Project Authors. All Rights Reserved.
Copyright 2015-2019 The OpenSSL Project Authors. All Rights Reserved.
Copyright 2015-2018 The OpenSSL Project Authors. All Rights Reserved.
Copyright 2013-2017 The OpenSSL Project Authors. All Rights Reserved.
Copyright 2012-2016 The OpenSSL Project Authors. All Rights Reserved.
Copyright 2006-2016 The OpenSSL Project Authors. All Rights Reserved.
Copyright 2002-2020 The OpenSSL Project Authors. All Rights Reserved.
Copyright 2004-2018 The OpenSSL Project Authors. All Rights Reserved.
Copyright 2012-2019 The OpenSSL Project Authors. All Rights Reserved.
Copyright 2006-2018 The OpenSSL Project Authors. All Rights Reserved.
Copyright 2008-2018 The OpenSSL Project Authors. All Rights Reserved.

LICENCE TERMS (cont.)

Copyright 2001-2020 The OpenSSL Project Authors. All Rights Reserved.
Copyright 2006-2019 The OpenSSL Project Authors. All Rights Reserved.
Copyright 2007-2016 The OpenSSL Project Authors. All Rights Reserved.
Copyright 2002-2017 The OpenSSL Project Authors. All Rights Reserved.
Copyright 2004-2019 The OpenSSL Project Authors. All Rights Reserved.
Copyright 2008-2019 The OpenSSL Project Authors. All Rights Reserved.
Copyright 2015-2017 The OpenSSL Project Authors. All Rights Reserved.
Copyright 2014-2018 The OpenSSL Project Authors. All Rights Reserved.
Copyright 2013-2016 The OpenSSL Project Authors. All Rights Reserved.
Copyright 2013-2019 The OpenSSL Project Authors. All Rights Reserved.
Copyright 2002-2019 The OpenSSL Project Authors. All Rights Reserved.
Copyright 2014-2019 The OpenSSL Project Authors. All Rights Reserved.
Copyright 2017-2018 The OpenSSL Project Authors. All Rights Reserved.
Copyright 1998-2018 The OpenSSL Project Authors. All Rights Reserved.
Copyright 2016-2020 The OpenSSL Project Authors. All Rights Reserved.
Copyright 2005-2017 The OpenSSL Project Authors. All Rights Reserved.
Copyright 2006-2017 The OpenSSL Project Authors. All Rights Reserved.
Copyright 2014-2016 The OpenSSL Project Authors. All Rights Reserved.
Copyright 2011-2018 The OpenSSL Project Authors. All Rights Reserved.
Copyright 1998-2020 The OpenSSL Project Authors. All Rights Reserved.
Copyright 2019-2020 The OpenSSL Project Authors. All Rights Reserved. Licensed under the Apache License 2.0 (the "License"). You may not use this file except in compliance with the License. You can obtain a copy in the file LICENSE in the source distribution or at [L<https://www.openssl.org/source/li](https://www.openssl.org/source/li)
Copyright 2006-2020 The OpenSSL Project Authors. All Rights Reserved.
Copyright 2003-2018 The OpenSSL Project Authors. All Rights Reserved.
Copyright 2003-2019 The OpenSSL Project Authors. All Rights Reserved.
Copyright 2004-2020 The OpenSSL Project Authors. All Rights Reserved.
Copyright (C) 2004, 2006 The Linux Foundation and its contributors. 660 York Street, Suite 102, San Francisco, CA 94110 USA;(c) The contribution was provided directly to me by some other;(c) and I have not modified it.
copyright: 2008 Johannes Berg license: ISC, see LICENSE for details.
Copyright (c) 2008, Luis R. Rodriguez <mcgrof@gmail.com>
Copyright (c) 2008, Johannes Berg <johannes@sipsolutions.net>
Copyright (c) 2008, Michael Green <Michael.Green@Atheros.com>
Copyright (C) 1989, 1991 Free Software Foundation, Inc. 59 Temple Place, Suite 330, Boston, MA 02111-1307 USA
Everyone is permitted to copy and distribute verbatim copies of this license document, but changing it is not allowed.;copyright the software, and 2) offer you this license which gives you legal permission to copy, distribute and/ or modify the software.;copyright law: that is to say, a work containing the Program or a portion of it, either verbatim or with modifications and/or translated into another language. (Hereinafter, translation is included without limitation in the term "modification".) Each licensee is addressed as "you".;copyrighted interfaces, the;copyrighted by the Free Software Foundation, write to the Free Software Foundation; we sometimes make exceptions for this. Our decision will be guided by the two goals of preserving the free status of all derivatives of our free software and of promoting the sharing and reuse of software generally.;copyright" line and a pointer to where the full notice is found.;Copyright (C) <year> <name of author>;Copyright (C) year name of author Gnomovision comes with ABSOLUTELY NO WARRANTY; for details type `show w'. This is free software, and you are welcome to redistribute it under certain conditions; type `show c' for details.;copyright disclaimer" for the program, if necessary. Here is a sample; alter the names.;copyright interest in the program Gnomovision' (which makes passes at compilers) written by James Hacker.
Copyright (c) 1997-2004 Jean Tourrilhes <jt@hpl.hp.com>
Copyright (c) 1997-2007 Jean Tourrilhes <jt@hpl.hp.com>
Copyright (c) 1997-2002 Jean Tourrilhes <jt@hpl.hp.com>
Copyright (c) 1997-2009 Jean Tourrilhes <jt@hpl.hp.com>
Copyright (c) 1997-2005 Jean Tourrilhes, All Rights Reserved.
Copyright (c) 1997-2001 Jean Tourrilhes, All Rights Reserved.
Copyright (c) 1997-2002 Jean Tourrilhes, All Rights Reserved.
Copyright (c) 1997-2006 Jean Tourrilhes, All Rights Reserved.
Copyright (c) 1997-2007 Jean Tourrilhes, All Rights Reserved.
Copyright (c) 1997-2004 Jean Tourrilhes, All Rights Reserved.
Copyright (c) 2007 Jean Tourrilhes <jt@hpl.hp.com>

Copyright (c) 2005-2009, Jouni Malinen <j@w1.fi>;Copyright (c) 2004, Gunter Burchardt <tira@isx.de>
Copyright (c) 2003-2013, Jouni Malinen <j@w1.fi>
Copyright (c) 2012, Intel Corporation. All rights reserved.
Copyright(c) 2015 Intel Deutschland GmbH
Copyright (c) 2003-2005, Jouni Malinen <j@w1.fi>
Copyright (c) 2004-2016, Jouni Malinen <j@w1.fi>
Copyright (c) 2003-2015, Jouni Malinen <j@w1.fi>
Copyright (c) 2010, Jouni Malinen <j@w1.fi>
Copyright (c) 2002-2014, Jouni Malinen <j@w1.fi>
Copyright (c) 2004-2006, Jouni Malinen <j@w1.fi>
Copyright (c) 2002-2015, Jouni Malinen <j@w1.fi>
Copyright (c) 2002-2009, Jouni Malinen <j@w1.fi>
Copyright (c) 2002-2014, Jouni Malinen <j@w1.fi>
Copyright (c) 2004, Sam Leffler <sam@errno.com>
Copyright (c) 2016, Sabrina Dubroca <sd@queasysnail.net> and Red Hat, Inc.
Copyright (c) 2003-2011, Jouni Malinen <j@w1.fi>
Copyright (c) 2002-2010, Jouni Malinen <j@w1.fi>
Copyright (c) 2003-2019, Jouni Malinen <j@w1.fi> and contributors All Rights Reserved.
Copyright (c) 2004-2005, Jouni Malinen <j@w1.fi>
Copyright (c) 2009-2010, Jouni Malinen <j@w1.fi>
Copyright (c) 2012, Jouni Malinen <j@w1.fi>
Copyright (c) 2004-2015, Jouni Malinen <j@w1.fi>
Copyright (c) 2003-2009, Jouni Malinen <j@w1.fi>
Copyright (c) 2005, Jouni Malinen <j@w1.fi>
Copyright (c) 2009-2010, Atheros Communications
Copyright (c) 2014-2017, Jouni Malinen <j@w1.fi>
Copyright (c) 2009-2010, Atheros Communications
Copyright (c) 2011, Jouni Malinen <j@w1.fi>
Copyright (C) 2010 The Android Open Source Project
Copyright (c) 2003-2018, Jouni Malinen <j@w1.fi>
Copyright (c) 2012, Intel Corporation. All rights reserved.
Copyright (c) 2006-2007 <j@w1.fi>
Copyright (c) 2011-2012, Qualcomm Atheros
Copyright (c) 2003-2007, Jouni Malinen <j@w1.fi>
Copyright (c) 2015-2017, Jouni Malinen <j@w1.fi>
Copyright (c) 2004-2012, Jouni Malinen <j@w1.fi>
Copyright (c) 2011-2013, Qualcomm Atheros, Inc.
Copyright (c) 2003-2017, Jouni Malinen <j@w1.fi>
Copyright (c) 2011-2012, Qualcomm Atheros, Inc.
Copyright (c) 2014-2015, Jouni Malinen <j@w1.fi>
Copyright (c) 2006-2009, Jouni Malinen <j@w1.fi>
Copyright (c) 2009-2014, Jouni Malinen <j@w1.fi>
Copyright (c) 2007, Jouni Malinen <j@w1.fi>
Copyright (c) 2017, Qualcomm Atheros, Inc.
Copyright (c) 2007-2009, Jouni Malinen <j@w1.fi>
Copyright (c) 2004-2017, Jouni Malinen <j@w1.fi>
Copyright(c) 2014, Intel Mobile Communication GmbH.
Copyright (c) 2003-2012, Jouni Malinen <j@w1.fi>
Copyright (c) 2006, Dan Williams <dcbw@redhat.com> and Red Hat, Inc.
Copyright (c) 2005-2006, Jouni Malinen <j@w1.fi>
Copyright (c) 2011-2012, Intel Corporation
Copyright (c) 2010-2011, Jouni Malinen <j@w1.fi>
Copyright (c) 2006, Dan Williams <dcbw@redhat.com> and Red Hat, Inc.
Copyright (c) 2015, Pali Rohár <pali.rohar@gmail.com>
Copyright (c) 2009, 2012, Jouni Malinen <j@w1.fi>
Copyright (c) 2003-2009, Jouni Malinen <j@w1.fi>
Copyright (c) 2013 Cozybit, Inc.

Copyright (c) 2011, Atheros Communications, Inc.
 Copyright (c) 2004-2009, Jouni Malinen <j@w1.fi>
 Copyright (c) 2003-2016, Jouni Malinen <j@w1.fi>
 Copyright (c) 2009, Atheros Communications
 Copyright (c) 2004-2016, Jouni Malinen <j@w1.fi>
 Copyright (c) 2012, Intel Corporation
 Copyright (c) 2009-2019, Jouni Malinen <j@w1.fi>
 Copyright (c) 2006-2007, Jouni Malinen <j@w1.fi>
 Copyright (c) 2004-2019, Jouni Malinen <j@w1.fi>
 Copyright (c) 2017, Qualcomm Atheros, Inc.
 Copyright (c) 2003-2006, Jouni Malinen <j@w1.fi>
 Copyright (c) 2015, Jouni Malinen <j@w1.fi>
 Copyright (c) 2011-2013, Qualcomm Atheros, Inc.
 Copyright (c) 2006, Jouni Malinen <j@w1.fi>
 Copyright (c) 2008-2012, Jouni Malinen <j@w1.fi>
 Copyright (c) 2003-2008, Jouni Malinen <j@w1.fi>
 Copyright (c) 2010-2012, Jouni Malinen <j@w1.fi>
 Copyright (c) 2004-2019, Jouni Malinen <j@w1.fi>
 Copyright (c) 2009-2013, Jouni Malinen <j@w1.fi>
 Copyright (c) 2017, Jouni Malinen <j@w1.fi>
 Copyright (c) 2013-2014, Qualcomm Atheros, Inc.
 Copyright (C) 2008 The Android Open Source Project
 Copyright (c) 2003-2005, Jouni Malinen <j@w1.fi>
 Copyright (c) 2012-2013, Jouni Malinen <j@w1.fi>
 Copyright (c) 2014, Jouni Malinen <j@w1.fi>
 Copyright (c) 2002-2005, Jouni Malinen <j@w1.fi>
 Copyright (c) 2003-2019, Jouni Malinen <j@w1.fi>
 Copyright (c) 2013-2014, cozybit, Inc. All rights reserved.
 Copyright (c) 2004-2013, Jouni Malinen <j@w1.fi>
 Copyright (c) 2003-2014, Jouni Malinen <j@w1.fi>
 Copyright (c) 2009, Jouni Malinen <j@w1.fi>
 Copyright (c) 2006-2011, Jouni Malinen <j@w1.fi>
 Copyright (c) 2004-2014, Jouni Malinen <j@w1.fi>
 copyright (c) 2003-2019, Jouni Malinen <email>j@w1.fi</email> and contributors. All Rights Reserved.</para>
 Copyright (c) 2005-2015, Jouni Malinen <j@w1.fi>
 Copyright (c) 2005-2008, Jouni Malinen <j@w1.fi>
 Copyright (c) 2004-2007, Jouni Malinen <j@w1.fi>
 Copyright (c) 2010, Dan Harkins <dharkins@lounge.org>
 Copyright (c) 2004-2008, Jouni Malinen <j@w1.fi>
 Copyright (c) 2004-2008, 2012-2015, Jouni Malinen <j@w1.fi>
 Copyright(c) 2015 Intel Deutschland GmbH Contact Information: Intel Linux Wireless <ilw@linux.intel.com> Intel Corporation, 5200 N.E. Elam Young Parkway, Hillsboro, OR 97124-6497
 Copyright (c) 2003-2009, Jouni Malinen <j@w1.fi> and contributors All Rights Reserved.
 Copyright (c) 2004-2009, 2012, Jouni Malinen <j@w1.fi>
 Copyright (c) 2009, Atheros Communications, Inc.
 Copyright (c) 2007-2014, Jouni Malinen <j@w1.fi>
 Copyright (c) 2013, Jouni Malinen <j@w1.fi>
 Copyright (c) 2006, Jouni Malinen <j@w1.fi>
 Copyright (c) 2013 Qualcomm Atheros, Inc.
 Copyright (c) 2015, Adrian Nowicki <adinowicki@gmail.com>
 Copyright (c) 2007-2009, 2012, Jouni Malinen <j@w1.fi>
 Copyright (c) 2009, Atheros Communications
 Copyright (c) 2006-2014, Jouni Malinen <j@w1.fi>
 Copyright (c) 2005-2011, Jouni Malinen <j@w1.fi>
 Copyright (c) 2006-2019, Jouni Malinen <j@w1.fi>
 Copyright (c) 2011-2013 Qualcomm Atheros, Inc.
 Copyright (c) 2010, Atheros Communications

Copyright (c) 2008 Bernard Gray <bernard.gray@gmail.com>
 Copyright (c) 2008, Jouni Malinen <j@w1.fi>
 Copyright (c) 2011, Kel Modderman <kel@otaku42.de>
 Copyright (c) 2002-2019, Jouni Malinen <j@w1.fi> and contributors All Rights Reserved.
 Copyright (c) 2002-2019, Jouni Malinen <j@w1.fi> and contributors All Rights Reserved.
 Copyright (C) 2004, 2006 The Linux Foundation and its contributors. 660 York Street, Suite 102, San Francisco, CA 94110 USA
 Copyright (c) 2012-2014, Qualcomm Atheros, Inc.
 Copyright (c) 2007-2008, Jouni Malinen <j@w1.fi>
 Copyright (c) 2005-2012, Jouni Malinen <j@w1.fi>
 Copyright (c) 2005-2007, Jouni Malinen <j@w1.fi>
 Copyright (c) 2007-2010, Jouni Malinen <j@w1.fi>
 Copyright (c) 2005-2010, 2012, Jouni Malinen <j@w1.fi>
 Copyright (c) 2005-2008, 2012, Jouni Malinen <j@w1.fi>
 Copyright (c) 2004-2011, Jouni Malinen <j@w1.fi>
 Copyright (c) 2003-2019, Jouni Malinen <j@w1.fi>
 Copyright (c) 2002-2009, 2012, 2014-2015, Jouni Malinen <j@w1.fi>
 Copyright (c) 2002-2009, 2011-2015, Jouni Malinen <j@w1.fi>
 Copyright (c) 2008-2014, Jouni Malinen <j@w1.fi>
 Copyright (c) 2005-2009, 2011, Jouni Malinen <j@w1.fi>
 Copyright (c) 2003-2012, Jouni Malinen
 Copyright (c) 2005-2009, 2011-2019, Jouni Malinen <j@w1.fi>
 copyright (c) 2003-2019, Jouni Malinen <j@w1.fi> and contributors. All Rights Reserved. PP This program is licensed under the BSD license (the one with advertisement clause removed).
 Copyright (c) 2002-2015, Jouni Malinen <j@w1.fi>
 Copyright (c) 2002-2013, Jouni Malinen <j@w1.fi>
 Copyright (c) 2011-2013, Jouni Malinen <j@w1.fi>
 Copyright (c) 2008-2019, Jouni Malinen <j@w1.fi>
 Copyright (c) 2007-2009, Jouni Malinen <j@w1.fi>
 Copyright (c) 2008-2011, Jouni Malinen <j@w1.fi>
 Copyright (c) 2004-2019, Jouni Malinen <j@w1.fi> and contributors%
 Copyright (c) 2004-2019, Jouni Malinen <j@w1.fi> and contributors%
 Copyright (c) 2000-2003 Intel Corporation
 Copyright (c) 2002-2017, Jouni Malinen <j@w1.fi>
 Copyright (c) 2009, Dan Harkins <dharkins@lounge.org>
 Copyright (c) 2013, Qualcomm Atheros, Inc.
 Copyright (c) 2002-2004, Instant802 Networks, Inc.
 Copyright 2002-2003, Instant802 Networks, Inc.
 Copyright (c) 2011, Atheros Communications
 Copyright (c) 2016, Jouni Malinen <j@w1.fi>
 Copyright (c) 2002-2009, 2012-2015, Jouni Malinen <j@w1.fi>
 Copyright (c) 2014, Qualcomm Atheros, Inc.
 Copyright (c) 2015 Google, Inc.
 Copyright 2003, Instant802 Networks, Inc.
 Copyright (c) 2002-2019, Jouni Malinen <j@w1.fi>
 Copyright (c) 2011-2014, Qualcomm Atheros, Inc.
 Copyright (c) 2012, Michael Braun <michael-dev@fami-braun.de>
 Copyright (c) 2002-2009, Jouni Malinen <j@w1.fi>
 Copyright 2003-2006, Jouni Malinen <j@w1.fi>
 Copyright (c) 2008-2016, Jouni Malinen <j@w1.fi>
 Copyright (c) 2002-2012, Jouni Malinen <j@w1.fi>
 Copyright (c) 2016-2017, Qualcomm Atheros, Inc.
 Copyright (c) 2002-2013, Jouni Malinen <j@w1.fi>
 Copyright (c) 2018-2019, Toke Høiland-Jørgensen <toke@toke.dk>
 Copyright (c) 2019, The Linux Foundation
 Copyright 2003, Jouni Malinen <j@w1.fi>
 Copyright (c) 2002-2003, Jouni Malinen <j@w1.fi>

LICENCE TERMS (cont.)

Copyright(c) 2013 - 2016 Intel Mobile Communications GmbH.
Copyright (c) 2002-2019, Jouni Malinen <j@w1.fi>
Copyright (c) 2002-2007, Jouni Malinen <j@w1.fi>
Copyright (c) 2016, Qualcomm Atheros, Inc.
Copyright (c) 2004-2018, Jouni Malinen <j@w1.fi>
Copyright (c) 2002-2017, Jouni Malinen <j@w1.fi>
Copyright (c) 2004-2008, 2012, Jouni Malinen <j@w1.fi>
Copyright 2006-2010 Johannes Berg <johannes@sipsolutions.net>
Copyright (c) 2018, Mathy Vanhoef
Copyright (c) 2014-2019, Jouni Malinen <j@w1.fi>
Copyright (c) 2012-2016, Jouni Malinen <j@w1.fi>
Copyright (c) 2002-2018, Jouni Malinen <j@w1.fi>
Copyright (c) 2012-2016, Jouni Malinen <j@w1.fi>
Copyright (c) 2010-2011, Atheros Communications, Inc.
Copyright (c) 2014-2017, Qualcomm Atheros, Inc.
Copyright (c) 2014-2017, Qualcomm Atheros, Inc.
Copyright (c) 2005-2009, Jouni Malinen <j@w1.fi>
Copyright (c) 2004-2006, 2012, Jouni Malinen <j@w1.fi>
Copyright (c) 2012-2013, Qualcomm Atheros, Inc.
Copyright (c) 2004-2007, 2012, Jouni Malinen <j@w1.fi>
Copyright (c) 2002-2006, Jouni Malinen <j@w1.fi>
Copyright (c) 2005-2019, Jouni Malinen <j@w1.fi>
Copyright (c) 2003, 2004 David Young. All rights reserved.
Copyright 2007 Andy Green <andy@warmcat.com>
Copyright (c) 2007-2012, Jouni Malinen <j@w1.fi>
Copyright (c) 2010-2011, Atheros Communications
Copyright (c) 2003-2009, 2011-2012, Jouni Malinen <j@w1.fi>
Copyright (c) 2003-2018, Jouni Malinen <j@w1.fi>
Copyright (c) 2004-2009, 2011-2015, Jouni Malinen <j@w1.fi>
Copyright (c) 2006-2018, Jouni Malinen <j@w1.fi>
Copyright (c) 2006-2015, Jouni Malinen <j@w1.fi>
Copyright (c) 2009-2015, Jouni Malinen <j@w1.fi>
Copyright 2008 Atheros Communications
Copyright (c) 2009-2012, Masashi Honma <masashi.honma@gmail.com>
Copyright (c) 2010, Atheros Communications, Inc.
Copyright (c) 2007-2016, Jouni Malinen <j@w1.fi>
Copyright (c) 2008-2012 Jouke Witteveen
Copyright (c) 2008, Atheros Communications
Copyright (c) 2005-2009, Jouni Malinen <j@w1.fi>
Copyright (c) 2013, Mark Kettenis
Copyright (c) 2002-2014, Jouni Malinen <j@w1.fi>
Copyright (c) 2007, Johannes Berg <johannes@sipsolutions.net>
Copyright (c) 2009-2010, Atheros Communications
Copyright (c) 2004-2016, Roshan Pius <rpius@google.com>
Copyright (c) 2003-2004, Instant802 Networks, Inc.
Copyright (c) 2005-2006, Devicescape Software, Inc.
Copyright (c) 2004, 2Wire, Inc
Copyright (c) 2019, The Linux Foundation
Copyright (c) 2009, Atheros Communications
Copyright (c) 2011, Qualcomm Atheros
Copyright (c) 2010-2014, Jouni Malinen <j@w1.fi>
"Copyright 2015 Intel Deutschland GmbH"
Copyright (c) 2007-2017, Jouni Malinen <j@w1.fi> and " contributors\n"
Copyright(c) 2014, Intel Corporation. All rights reserved.
Copyright (c) 2009-2010, Witold Sowa <witold.sowa@gmail.com>
Copyright (c) 2009, Jouni Malinen <j@w1.fi>
Copyright (c) 2009-2010, Witold Sowa <witold.sowa@gmail.com>

Copyright (c) 2009-2015, Jouni Malinen <j@w1.fi>
Copyright (c) 2009, Witold Sowa <witold.sowa@gmail.com>
Copyright (c) 2009, Witold Sowa <witold.sowa@gmail.com>
Copyright (c) 2010, Jouni Malinen <j@w1.fi>
Copyright (c) 2011-2012, Qualcomm Atheros, Inc.
Copyright (c) 2004-2019, Jouni Malinen <j@w1.fi> and contributors"
Copyright (c) 2018-2019, The Linux Foundation
Copyright (c) 2011-2014, Jouni Malinen <j@w1.fi>
copyright do with it what you wish. Todd C. Miller modified the MD5 code to do MD4 based on RFC 1186.
Copyright (c) 2011-2014, Qualcomm Atheros, Inc.
Copyright (c) 2011-2013, Qualcomm Atheros, Inc.
Copyright (c) 2003-2015,\n" Jouni Malinen <j@w1.fi>\n" and contributors.\n"
Copyright (c) 2002-2019, Jouni Malinen <j@w1.fi> and contributors All Rights Reserved.
Copyright (c) 2002-2019, Jouni Malinen <j@w1.fi> and contributors All Rights Reserved.
Copyright (c) 2002-2019, Jouni Malinen <j@w1.fi> and contributors All Rights Reserved.
Copyright (c) 2003-2019, Jouni Malinen <j@w1.fi> and contributors
Copyright (c) 2003-2019, Jouni Malinen <j@w1.fi> and contributors
Copyright (c) 2003-2019, Jouni Malinen <j@w1.fi> and contributors
Copyright (c) 2003-2019, Jouni Malinen <j@w1.fi> and contributors
Copyright (c) 2003-2019, Jouni Malinen <j@w1.fi> and contributors
Copyright (c) 2003-2019, Jouni Malinen <j@w1.fi> and contributors
Copyright (c) 2003-2019, Jouni Malinen <j@w1.fi> and contributors
Copyright (c) 2003-2019, Jouni Malinen <j@w1.fi> and contributors
Copyright (c) 2003-2019, Jouni Malinen <j@w1.fi> and contributors
Copyright (c) 2003-2019, Jouni Malinen <j@w1.fi> and contributors
Copyright (c) 2006-2007 Sony Corporation
Copyright (c) 2008-2009 Atheros Communications
Copyright (c) 2009-2010, Jouni Malinen <j@w1.fi>
Copyright 2008 Atheros Communications.
Copyright (c) 2006-2007 Sony Corporation. All Rights Reserved.
Copyright (c) 2000-2003 Intel Corporation All rights reserved.
Copyright (c) 2006-2007 Sony Corporation
Copyright (c) 2008-2009 Atheros Communications
Copyright (c) 2009-2010, Jouni Malinen <j@w1.fi>
Copyright 2008 Atheros Communications.
Copyright (c) 2006-2007 Sony Corporation. All Rights Reserved.
Copyright (c) 2000-2003 Intel Corporation All rights reserved.
Copyright (c) 2006-2007 Sony Corporation
Copyright (c) 2008-2009 Atheros Communications
Copyright (c) 2009-2010, Jouni Malinen <j@w1.fi>
Copyright 2008 Atheros Communications.
Copyright (c) 2006-2007 Sony Corporation. All Rights Reserved.
Copyright (c) 2000-2003 Intel Corporation All rights reserved.
Copyright (c) 2009-2010, Jouni Malinen <j@w1.fi>
Copyright (c) 2008-2012, Jouni Malinen <j@w1.fi>
Copyright 2005-2006, Devicescape Software, Inc.
Copyright (c) 2008-2011, Jouni Malinen <j@w1.fi>
Copyright (c) 2013, Qualcomm Atheros, Inc.
Copyright 2005-2006, Devicescape Software, Inc.
Copyright (c) 2006, Devicescape Software, Inc.
Copyright 2003-2004, Instant802 Networks, Inc.
Copyright (c) 2007-2008, Intel Corporation
Copyright (c) 2019 John Crispin <john@phrozen.org>
Copyright (c) 2013-2017, Qualcomm Atheros, Inc.
Copyright(c) 2011 - 2016 Intel Corporation. All rights reserved.
Copyright(c) 2011 - 2016 Intel Corporation. All rights reserved.
Copyright (c) 2016-2017, Jouni Malinen <j@w1.fi>
Copyright (c) 2007-2008 Intel Corporation

LICENCE TERMS (cont.)

Copyright (c) 2011-2017, Qualcomm Atheros
Copyright 2005, Devicescape Software, Inc.
Copyright (c) 2005-2006, Devicescape Software, Inc.
Copyright (c) 2011-2017, Qualcomm Atheros, Inc.
Copyright 2008 Michael Wu <flamingice@sourmilk.net>
Copyright 2008 Luis Carlos Cobo <luisca@cozybit.com>
Copyright 2008 Michael Buesch <m@bues.ch>
Copyright 2008, 2009 Luis R. Rodriguez <lrodriguez@atheros.com>
Copyright 2008 Jouni Malinen <jouni.malinen@atheros.com>
Copyright 2008 Colin McCabe <colin@cozybit.com>
"Copyright 2015-2017 Intel Deutschland GmbH"
Copyright (C) 2018-2019 Intel Corporation
Copyright (c) 2011-2012, Qualcomm Atheros
Copyright (c) 2015, Qualcomm Atheros, Inc.
Copyright (c) 2005, Sam Leffler <sam@errno.com>
Copyright 2009 Johannes Berg <johannes@sipsolutions.net>
Copyright(c) 2015 Intel Deutschland GmbH
Copyright (c) 2009-2013, Jouni Malinen <j@w1.fi>
Copyright (c) 2004, Gunter Burchardt <tira@isx.de>
Copyright (c) 2013-2014, Qualcomm Atheros, Inc.
Copyright (c) 2004, Video54 Technologies
Copyright (c) 2005-2007, Jouni Malinen <j@w1.fi>
Copyright (c) 1990-1999 Info-ZIP. All rights reserved.
Copyright (c) 1990-2007 Info-ZIP. All rights reserved.
Copyright (c) 1990-2008 Info-ZIP. All rights reserved.
Copyright (c) 1990-2008 Info-ZIP. All rights reserved.
Copyright (c) 1990-2007 Info-ZIP. All rights reserved.
Copyright (c) 1990-2001 Info-ZIP. All rights reserved.
Copyright (c) 1990-2000 Info-ZIP. All rights reserved.
Copyright (c) 1990-2000 Info-ZIP. All rights reserved.
Copyright (c) 1990-2002 Info-ZIP. All rights reserved.
Copyright (c) 1995-1998 Jim Luther and Apple Computer, Inc. All rights reserved.
Copyright 1992-1998 Apple Computer, Inc.
Copyright (c) 1990-2003 Info-ZIP. All rights reserved.
Copyright (c) 1990-1999 Info-ZIP. All rights reserved.
Copyright (c) 1990-2008 Info-ZIP. All rights reserved. For the purposes of this copyright and license, "Info-ZIP" is defined as the following set of individuals: Mark Adler, John Bush, Karl Davis, Harald Denker, Jean-Michel Dubois, Jean-loup Gailly, Hunter Goatley, Ed Gordon, Ian Gorm
Copyright (C) 1999-2007 Info-ZIP Chris Herborth (chrish@pobox.com) Ruslan Nickolaev (nruslan@hotmail.com)
Copyright (c) 1990-2005 Info-ZIP. All rights reserved.
Copyright (c) 1990-2004 Info-ZIP. All rights reserved.
Copyright © 1999 Info-ZIP Chris Herborth (chrish@pobox.com)
Copyright (c) 1990-2006 Info-ZIP. All rights reserved.
Copyright (c) 1990-2005 Info-ZIP. All rights reserved.
copyrighted by Info-ZIP; see the enclosed LICENSE file for details. Older versions remain in the public domain.
Zcrypt was originally written in Europe and, as of April 2000, can be freely distributed from the US as well as other countries.
Copyright (C) 1995-2005 Jean-loup Gailly, Brian Raiter and Gilles Vollant.
Copyright", "Copyright © Info-ZIP 1997 - 2008
Copyright", "Info-ZIP 1997 - 2008
Copyright (C) 1997-2008 Info-ZIP.
Copyright (c) 1990-2008 Info-ZIP. All rights reserved.
Copyright (c) 1990-2008 Info-ZIP
copyright 1995 Jim Luther All rights reserved.
Copyright (c) 1990-2007 Info-ZIP. All rights reserved.
Copyright (C) 1995 Mark Adler
copyright = (C) Copyright 199x NONAME, INC. All Rights Reserved

Copyright (c) 1996 Scott Field
Copyright (C) 1997-2008 Info-ZIP.
Copyright (C) 1990-1997 Mark Adler, Richard B. Wales, Jean-loup Gailly, Onno van der Linden, Kai Uwe Rommel, Igor Mandrichenko, John Bush and Paul Kienitz. LP
Copyright (C) 1997-2008 Info-ZIP. LP Currently distributed under the Info-ZIP license. LP
Copyright (C) 1990-1997 Mark Adler, Richard B. Wales, Jean-loup Gailly, Onno van der Linden, Kai Uwe Rommel, Igor Mandrichenko, John Bush and Paul Kienitz. LP
copyright history: Previous versions of this source package (up to version 2.8) were not copyrighted and put in the public domain. If you cannot comply with the Info-ZIP LICENSE, you may want to look for one of those public domain versions.
Copyright (C) 1990-1997 Mark Adler, Richard B. Wales, Jean-loup Gailly, Onno van der Linden, Kai Uwe Rommel, Igor Mandrichenko, John Bush and Paul Kienitz.
Copyright (C) 1990-1997 Mark Adler, Richard B. Wales, Jean-loup Gailly, Onno van der Linden, Kai Uwe Rommel, Igor Mandrichenko, John Bush and Paul Kienitz.
Copyright (C) 1995-2016 Jean-loup Gailly
Copyright (C) 1995-2003, 2010 Mark Adler
Copyright (C) 1995-2016 Jean-loup Gailly, Mark Adler
Copyright (C) 1995-2005, 2010 Mark Adler
Copyright (C) 1995-2016 Mark Adler
Copyright (C) 1995-2017 Jean-loup Gailly and Mark Adler
Copyright (C) 2004, 2005, 2010, 2011, 2012, 2013, 2016 Mark Adler
Copyright (C) 1995-2016 Jean-loup Gailly, Mark Adler
(C) 1995-2017 Jean-loup Gailly and Mark Adler
Copyright (C) 1995-2017 Jean-loup Gailly and Mark Adler
Copyright (C) 1995-2003, 2010, 2014, 2016 Jean-loup Gailly, Mark Adler
Copyright 1995-2017 Jean-loup Gailly and Mark Adler
Copyright (C) 1995-2017 Jean-loup Gailly
Copyright (C) 1995-2017 Jean-loup Gailly, Mark Adler
Copyright (C) 1995-2017 Mark Adler
Copyright (C) 1995-2011, 2016 Mark Adler
Copyright (C) 1995-2006, 2010, 2011, 2016 Jean-loup Gailly
Copyright (C) 1995-2006, 2011, 2016 Jean-loup Gailly
Copyright (C) 2011, 2016 Mark Adler
Copyright (C) 1995-1998 Jean-loup Gailly.
Copyright (C) 1995-2017 Jean-loup Gailly and Mark Adler
Copyright (C) 1998, 2007 Brian Raiter <breadbox@muppetlabs.com>
Copyright (C) 1995-2003 Mark Adler
Copyright 1995-2017 Mark Adler
Copyright (C) 1995-2008 Mark Adler
Copyright (C) 1995-2017 Mark Adler
Copyright (C) 2003 Mark Adler
Copyright (C) 1995-2003 Mark Adler
Copyright (c) 2004 by Henrik Ravn
Copyright Henrik Ravn 2004
copyright (C) 1995-2017 Jean-loup Gailly and Mark Adler
Copyright (C) 1995-2003 Jean-loup Gailly.
"Copyright", ""(C) 1995-2017 Jean-loup Gailly & Mark Adler"
Copyright (C) 1995-2005, 2014, 2016 Jean-loup Gailly, Mark Adler
©Copyright (c) Henrik Ravn 2004
Copyright (C) 1995-2010 Jean-loup Gailly, Brian Raiter and Gilles Vollant.
Copyright (C) 1995-2017 Jean-loup Gailly
Copyright (C) 2004-2017 Mark Adler
Copyright (C) 2007, 2008, 2012 Mark Adler Version 1.4 18 August 2012 Mark Adler
Copyright (C) 2003, 2012 Mark Adler, all rights reserved version 1.2, 11 Oct 2012
Copyright (C) 2005, 2012 Mark Adler
Copyright (c) 2004, 2005 Mark Adler.
copyrighted -- provided to the public domain Version 1.1 25 November 2004 Mark Adler

LICENCE TERMS (cont.)

Copyright (C) 2004, 2005, 2012 Mark Adler, all rights reserved version 1.2, 14 Aug 2012
Copyright (C) 2003 Cosmin Truta. Derived from original sources by Bob Dellaca.
Copyright (C) 2003, 2005, 2008, 2010, 2012 Mark Adler
copyrighted -- provided to the public domain Version 1.4 11 December 2005 Mark Adler
Copyright (C) 1995-2003 Jean-loup Gailly.
Copyright (C) 1995-2003 Jean-loup Gailly and Mark Adler.
Copyright (C) 2004, 2008, 2012, 2016 Mark Adler, all rights reserved
Copyright (C) 2004, 2008, 2012 Mark Adler, all rights reserved version 2.2, 14 Aug 2012
Copyright (C) 1998-2010 Gilles Vollant (minizip) (<http://www.winimage.com/zLibDll/minizip.html>)
Copyright (C) 1998-2005 Gilles Vollant
Copyright 1995-2017 Jean-loup Gailly and Mark Adler
Copyright (c) 1997,99 Borland Corporation
Copyright (c) 1997,99 Borland Corp., and is based on zlib version 1.0.4. There are a series of bugs and security problems associated with that old zlib version, and we recommend the users to update their ZLib unit.
Copyright (c) 1998-2010 - by Gilles Vollant - version 1.1 64 bits from Mathias Svensson
Copyright (C) 2003, 2012, 2013 Mark Adler version 1.3, 24 Aug 2013
Copyright (C) 2003, 2012, 2013 Mark Adler
Copyright (C) 1995-1996 Jean-loup Gailly, Brian Raiter and Gilles Vollant. File written by Gilles Vollant, by converting match686.S from Brian Raiter for MASM. This is as assembly version of longest_match from Jean-loup Gailly in deflate.c
Copyright", "(C) 1995-2017 Jean-loup Gailly & Mark Adler
Copyright (c) 1997 Christian Michelsen Research AS Advanced Computing Fantoftvegen 38, 5036 BERGEN, Norway <http://www.cmr.no>
Copyright (C) 2002-2004 Dmitry Anisimkov --
Copyright (C) 2002-2003 Dmitry Anisimkov --
Copyright (C) 2002-2013 Mark Adler, all rights reserved version 2.3, 21 Jan 2013
Copyright (C) 2002-2013 Mark Adler
Copyright (c) 1996 L. Peter Deutsch
Copyright (c) 1996 L. Peter Deutsch and Jean-Loup Gailly
Copyright Jean-loup Gailly Osmo Ahvenlampi <Osmo.Ahvenlampi@hut.fi> Amiga, SAS/C 6.56 & Smake
Copyright (C) 1998 by Andreas R. Kleinert
copyright, "Copyright (C) 1995-2017 Jean-Loup Gailly, Mark Adler. OS/400 version by P. Monnerat."
Copyright (C) 1995-2006, 2010, 2011, 2012, 2016 Mark Adler
Copyright 1995-2017 Mark Adler
Copyright (C) 2004, 2010 Mark Adler
Copyright 1995-2017 Mark Adler
Copyright 1995-2017 Jean-loup Gailly and Mark Adler "
Copyright 1995-2017 Jean-loup Gailly and Mark Adler "
Copyright (C) 2003 Chris Anderson <christop@charm.net>
Copyright (C) 2003, 2012 Mark Adler\n"
Copyright (c) 2004, 2005 by Mark Adler Last modified 11 December 2005
Copyright (C) 2003-2010 Mark Adler
Copyright (C) 1998 by Jacques Nomssi Nzali.
Copyright (C) 2003 by Cosmin Truta.
Copyright (C) 1998 by Bob Dellaca.
Copyright (C) 2003 by Cosmin Truta.
Copyright (C) 1995-2003 by Jean-loup Gailly.
Copyright (C) 1998,1999,2000 by Jacques Nomssi Nzali.
Copyright (C) 2007-2008 Even Rouault
Copyright (C) 2009-2010 Mathias Svensson (<http://result42.com>)
copyright[] =" zip 1.01 Copyright 1998-2004 Gilles Vollant - <http://www.winimage.com/zLibDll>"
Copyright (C) 1998 Brian Raiter <breadcrumb@muppetlabs.com> You can look at <http://www.muppetlabs.com/~breadcrumb/software/assembly.html>
Copyright (C) 2007-2008 Even Rouault
Copyright (c) 1990-2000 Info-ZIP. All rights reserved.
Copyright (C) 1998 - 2010 Gilles Vollant, Even Rouault, Mathias Svensson
Copyright (c) 1990-2000 Info-ZIP. All rights reserved.

Copyright (C) 1998 - 2010 Gilles Vollant, Even Rouault, Mathias Svensson
Copyright 1998-2004 Gilles Vollant - <http://www.winimage.com/zLibDll>
Copyright;Dept. of Energy). All rights reserved.
Copyright 1992-2019 Free Software Foundation, Inc.
Copyright (c) 2017, The Regents of the University of California, through Lawrence Berkeley National Laboratory (subject to receipt of any required approvals from the U.S. Dept. of Energy). All rights reserved.
Copyright (c) 2014-2019, The Regents of the University of California, through Lawrence Berkeley National Laboratory (subject to receipt of any required approvals from the U.S. Dept. of Energy). All rights reserved.
Copyright (c) 2014-2018, The Regents of the University of California, through Lawrence Berkeley National Laboratory (subject to receipt of any required approvals from the U.S. Dept. of Energy). All rights reserved.
Copyright (c) 2014-2017, The Regents of the University of California, through Lawrence Berkeley National Laboratory (subject to receipt of any required approvals from the U.S. Dept. of Energy). All rights reserved.
Copyright (c) 2014, The Regents of the University of California, through Lawrence Berkeley National Laboratory (subject to receipt of any required approvals from the U.S. Dept. of Energy). All rights reserved.
Copyright (c) 2014, ESnet All rights reserved.
Copyright (c) 2014, 2017, The Regents of the University of California, through Lawrence Berkeley National Laboratory (subject to receipt of any required approvals from the U.S. Dept. of Energy). All rights reserved.
Copyright (c) 2014, 2016, 2017, The Regents of the University of California, through Lawrence Berkeley National Laboratory (subject to receipt of any required approvals from the U.S. Dept. of Energy). All rights reserved.
Copyright (c) 2014, 2015, 2017, 2019, The Regents of the University of California, through Lawrence Berkeley National Laboratory (subject to receipt of any required approvals from the U.S. Dept. of Energy). All rights reserved.
Copyright (C) 2014 Free Software Foundation, Inc.
Copyright (C) 2012 Free Software Foundation, Inc.
Copyright (C) 2011-2018 Free Software Foundation, Inc.
Copyright (c) 2011 The NetBSD Foundation, Inc. All rights reserved.
Copyright (C) 2011 Free Software Foundation, Inc.
Copyright (C) 2009-2018 Free Software Foundation, Inc.
Copyright (c) 2009-2017 Dave Gamble and cJSON contributors
Copyright (c) 2009,2010 Zmanda Inc. <<http://www.zmanda.com/>>;Copyright (c) 2009,2010 Dustin J. Mitchell <dustin@zmanda.com>
Copyright (c) 2009 Dave Gamble
Copyright (C) 2006-2018 Free Software Foundation, Inc.
Copyright (c) 2006, 2008 Junio C Hamano
Copyright (c) 2005-2007 Russ Cox, Massachusetts Institute of Technology
Copyright (c) 2005,2006 Damien Miller. All rights reserved.
Copyright (C) 2004-2018 Free Software Foundation, Inc.
Copyright (C) 2004-2005, 2007-2009, 2011-2015 Free Software Foundation, Inc. Written by Gary V. Vaughan, 2004
Copyright (C) 2004-2005, 2007, 2009, 2011-2015 Free Software Foundation, Inc. Written by Scott James Remnant, 2004.
Copyright (C) 2004, 2011-2015 Free Software Foundation, Inc. Written by Scott James Remnant, 2004
Copyright (C) 2003-2018 Free Software Foundation, Inc.
Copyright (c) 2003 by Lucent Technologies.
Copyright (C) 2002-2018 Free Software Foundation, Inc.
Copyright (C) 2001-2018 Free Software Foundation, Inc.
Copyright (c) 2001 Eric Jackson <ericj@monkey.org>;Copyright: <http://swtch.com/libtask/COPYRIGHT>
Copyright (c) 2001 Eric Jackson <ericj@monkey.org>
Copyright (c) 2000 Markus Friedl. All rights reserved.
Copyright (C) 1999-2018 Free Software Foundation, Inc. Written by Tom Tromey <tromey@cygnus.com>.
Copyright (C) 1999-2018 Free Software Foundation, Inc.
Copyright (c) 1999,2000,2001,2002,2003 The Board of Trustees of the University of Illinois All Rights Reserved.
Copyright (C) 1997-2018 Free Software Foundation, Inc.
Copyright (C) 1996-2018 Free Software Foundation, Inc. Originally written by Fran,cois Pinard <pinard@iro.umontreal.ca>, 1996.
Copyright (C) 1996-2018 Free Software Foundation, Inc.
Copyright (C) 1996-2015 Free Software Foundation, Inc. ;Copyright (C) 2010-2015 Free Software Foundation, Inc.
Copyright (C) 1996-2001, 2003-2015 Free Software Foundation, Inc. Written by Gordon Matzigkeit, 1996
Copyright (C) 1994-2018 Free Software Foundation, Inc.

LICENCE TERMS (cont.)

Copyright (C) 1994, 1995, 1996, 1999, 2000, 2001, 2002, 2004, 2005 Free Software Foundation, Inc.
Copyright (C) 1994 X Consortium
Copyright (C) 1992-1996, 1998-2012 Free Software Foundation, Inc.
Copyright (c) 1991, 1993 The Regents of the University of California. All rights reserved.

• Licenses

GNU GENERAL PUBLIC LICENSE Version 1, February 1989

Copyright (C) 1989 Free Software Foundation, Inc.
51 Franklin St, Fifth Floor, Boston, MA 02110-1301 USA

Everyone is permitted to copy and distribute verbatim copies of this license document, but changing it is not allowed.

Preamble

The license agreements of most software companies try to keep users at the mercy of those companies. By contrast, our General Public License is intended to guarantee your freedom to share and change free software--to make sure the software is free for all its users. The General Public License applies to the Free Software Foundation's software and to any other program whose authors commit to using it. You can use it for your programs, too.

When we speak of free software, we are referring to freedom, not price. Specifically, the General Public License is designed to make sure that you have the freedom to give away or sell copies of free software, that you receive source code or can get it if you want it, that you can change the software or use pieces of it in new free programs; and that you know you can do these things.

To protect your rights, we need to make restrictions that forbid anyone to deny you these rights or to ask you to surrender the rights. These restrictions translate to certain responsibilities for you if you distribute copies of the software, or if you modify it.

For example, if you distribute copies of a such a program, whether gratis or for a fee, you must give the recipients all the rights that you have. You must make sure that they, too, receive or can get the source code. And you must tell them their rights.

We protect your rights with two steps: (1) copyright the software, and (2) offer you this license which gives you legal permission to copy, distribute and/or modify the software.

Also, for each author's protection and ours, we want to make certain that everyone understands that there is no warranty for this free software. If the software is modified by someone else and passed on, we want its recipients to know that what they have is not the original, so that any problems introduced by others will not reflect on the original authors' reputations.

The precise terms and conditions for copying, distribution and modification follow.

GNU GENERAL PUBLIC LICENSE TERMS AND CONDITIONS FOR COPYING, DISTRIBUTION AND MODIFICATION

0. This License Agreement applies to any program or other work which contains a notice placed by the copyright holder saying it may be distributed under the terms of this General Public License. The ""Program"", below, refers to any such program or work, and a ""work based on the Program"" means either the Program or any work containing the Program or a portion of it, either verbatim or with modifications. Each licensee is addressed as ""you"".

1. You may copy and distribute verbatim copies of the Program's source code as you receive it, in any medium, provided that you conspicuously and appropriately publish on each copy an appropriate copyright notice and disclaimer of warranty; keep intact all the notices that refer to this General Public License and to the absence of any warranty; and give any other recipients of the Program a copy of this General Public License along with the Program. You may charge a fee for the physical act of transferring a copy.

2. You may modify your copy or copies of the Program or any portion of it, and copy and distribute such modifications under the terms of Paragraph 1 above, provided that you also do the following:

a) cause the modified files to carry prominent notices stating that you changed the files and the date of any change; and

b) cause the whole of any work that you distribute or publish, that in whole or in part contains the Program or any part thereof, either with or without modifications, to be licensed at no charge to all third parties under the terms of this General Public License (except that you may choose to grant warranty protection to some or all third parties, at your option).

c) If the modified program normally reads commands interactively when run, you must cause it, when started running for such interactive use in the simplest and most usual way, to print or display an announcement including an appropriate copyright notice and a notice that there is no warranty (or else, saying that you provide a warranty) and that users may redistribute the program under these conditions, and telling the user how to view a copy of this General Public License.

d) You may charge a fee for the physical act of transferring a copy, and you may at your option offer warranty protection in exchange for a fee.

Mere aggregation of another independent work with the Program (or its derivative) on a volume of a storage or distribution medium does not bring the other work under the scope of these terms.

3. You may copy and distribute the Program (or a portion or derivative of it, under Paragraph 2) in object code or executable form under the terms of Paragraphs 1 and 2 above provided that you also do one of the following:

LICENCE TERMS (cont.)

a) accompany it with the complete corresponding machine-readable source code, which must be distributed under the terms of Paragraphs 1 and 2 above; or,

b) accompany it with a written offer, valid for at least three years, to give any third party free (except for a nominal charge for the cost of distribution) a complete machine-readable copy of the corresponding source code, to be distributed under the terms of Paragraphs 1 and 2 above; or,

c) accompany it with the information you received as to where the corresponding source code may be obtained. (This alternative is allowed only for noncommercial distribution and only if you received the program in object code or executable form alone.)

Source code for a work means the preferred form of the work for making modifications to it. For an executable file, complete source code means all the source code for all modules it contains; but, as a special exception, it need not include source code for modules which are standard libraries that accompany the operating system on which the executable file runs, or for standard header files or definitions files that accompany that operating system.

4. You may not copy, modify, sublicense, distribute or transfer the Program except as expressly provided under this General Public License. Any attempt otherwise to copy, modify, sublicense, distribute or transfer the Program is void, and will automatically terminate your rights to use the Program under this License. However, parties who have received copies, or rights to use copies, from you under this General Public License will not have their licenses terminated so long as such parties remain in full compliance.

5. By copying, distributing or modifying the Program (or any work based on the Program) you indicate your acceptance of this license to do so, and all its terms and conditions.

6. Each time you redistribute the Program (or any work based on the Program), the recipient automatically receives a license from the original licensor to copy, distribute or modify the Program subject to these terms and conditions. You may not impose any further restrictions on the recipients' exercise of the rights granted herein.

7. The Free Software Foundation may publish revised and/or new versions of the General Public License from time to time. Such new versions will be similar in spirit to the present version, but may differ in detail to address new problems or concerns.

Each version is given a distinguishing version number. If the Program specifies a version number of the license which applies to it and ""any later version"", you have the option of following the terms and conditions either of that version or of any later version published by the Free Software Foundation. If the Program does not specify a version number of the license, you may choose any version ever published by the Free Software Foundation.

8. If you wish to incorporate parts of the Program into other free programs whose distribution conditions are different, write to the author

to ask for permission. For software which is copyrighted by the Free Software Foundation, write to the Free Software Foundation; we sometimes make exceptions for this. Our decision will be guided by the two goals of preserving the free status of all derivatives of our free software and of promoting the sharing and reuse of software generally.

NO WARRANTY

9. BECAUSE THE PROGRAM IS LICENSED FREE OF CHARGE, THERE IS NO WARRANTY FOR THE PROGRAM, TO THE EXTENT PERMITTED BY APPLICABLE LAW. EXCEPT WHEN OTHERWISE STATED IN WRITING THE COPYRIGHT HOLDERS AND/OR OTHER PARTIES PROVIDE THE PROGRAM ""AS IS"" WITHOUT WARRANTY OF ANY KIND, EITHER EXPRESSED OR IMPLIED, INCLUDING, BUT NOT LIMITED TO, THE IMPLIED WARRANTIES OF MERCHANTABILITY AND FITNESS FOR A PARTICULAR PURPOSE. THE ENTIRE RISK AS TO THE QUALITY AND PERFORMANCE OF THE PROGRAM IS WITH YOU. SHOULD THE PROGRAM PROVE DEFECTIVE, YOU ASSUME THE COST OF ALL NECESSARY SERVICING, REPAIR OR CORRECTION.

10. IN NO EVENT UNLESS REQUIRED BY APPLICABLE LAW OR AGREED TO IN WRITING WILL ANY COPYRIGHT HOLDER, OR ANY OTHER PARTY WHO MAY MODIFY AND/OR REDISTRIBUTE THE PROGRAM AS PERMITTED ABOVE, BE LIABLE TO YOU FOR DAMAGES, INCLUDING ANY GENERAL, SPECIAL, INCIDENTAL OR CONSEQUENTIAL DAMAGES ARISING OUT OF THE USE OR INABILITY TO USE THE PROGRAM (INCLUDING BUT NOT LIMITED TO LOSS OF DATA OR DATA BEING RENDERED INACCURATE OR LOSSES SUSTAINED BY YOU OR THIRD PARTIES OR A FAILURE OF THE PROGRAM TO OPERATE WITH ANY OTHER PROGRAMS), EVEN IF SUCH HOLDER OR OTHER PARTY HAS BEEN ADVISED OF THE POSSIBILITY OF SUCH DAMAGES.

END OF TERMS AND CONDITIONS

Appendix: How to Apply These Terms to Your New Programs

If you develop a new program, and you want it to be of the greatest possible use to humanity, the best way to achieve this is to make it free software which everyone can redistribute and change under these terms.

To do so, attach the following notices to the program. It is safest to attach them to the start of each source file to most effectively convey the exclusion of warranty; and each file should have at least the ""copyright"" line and a pointer to where the full notice is found.

```
<one line to give the program's name and a brief idea of what it does.>
Copyright (C) 19yy <name of author>
```

```
This program is free software; you can redistribute it and/or modify
it under the terms of the GNU General Public License as published by
the Free Software Foundation; either version 1, or (at your option)
any later version.
```

```
This program is distributed in the hope that it will be useful,
but WITHOUT ANY WARRANTY; without even the implied warranty of
MERCHANTABILITY or FITNESS FOR A PARTICULAR PURPOSE. See the
GNU General Public License for more details.
```

You should have received a copy of the GNU General Public License along with this program; if not, write to the Free Software

LICENCE TERMS (cont.)

Foundation, Inc., 51 Franklin Street, Fifth Floor, Boston MA 02110-1301 USA

Also add information on how to contact you by electronic and paper mail.

If the program is interactive, make it output a short notice like this when it starts in an interactive mode:

```
Gnomovision version 69, Copyright (C) 19xx name of author
Gnomovision comes with ABSOLUTELY NO WARRANTY; for details type `show w'.
This is free software, and you are welcome to redistribute it
under certain conditions; type `show c' for details.
```

The hypothetical commands `show w' and `show c' should show the appropriate parts of the General Public License. Of course, the commands you use may be called something other than `show w' and `show c'; they could even be mouse-clicks or menu items--whatever suits your program.

You should also get your employer (if you work as a programmer) or your school, if any, to sign a ""copyright disclaimer"" for the program, if necessary. Here a sample; alter the names:

```
Yoyodyne, Inc., hereby disclaims all copyright interest in the
program `Gnomovision' (a program to direct compilers to make passes
at assemblers) written by James Hacker.
```

```
<signature of Ty Coon>, 1 April 1989
Ty Coon, President of Vice
```

That's all there is to it!

GNU GENERAL PUBLIC LICENSE Version 2, June 1991

Copyright (C) 1989, 1991 Free Software Foundation, Inc.
51 Franklin Street, Fifth Floor, Boston, MA 02110-1301 USA
Everyone is permitted to copy and distribute verbatim copies
of this license document, but changing it is not allowed.

Preamble

The licenses for most software are designed to take away your freedom to share and change it. By contrast, the GNU General Public License is intended to guarantee your freedom to share and change free software--to make sure the software is free for all its users. This General Public License applies to most of the Free Software Foundation's software and to any other program whose authors commit to using it. (Some other Free Software Foundation software is covered by the GNU Library General Public License instead.) You can apply it to your programs, too.

When we speak of free software, we are referring to freedom, not price. Our General Public Licenses are designed to make sure that you have the freedom to distribute copies of free software (and charge for

this service if you wish), that you receive source code or can get it if you want it, that you can change the software or use pieces of it in new free programs; and that you know you can do these things.

To protect your rights, we need to make restrictions that forbid anyone to deny you these rights or to ask you to surrender the rights. These restrictions translate to certain responsibilities for you if you distribute copies of the software, or if you modify it.

For example, if you distribute copies of such a program, whether gratis or for a fee, you must give the recipients all the rights that you have. You must make sure that they, too, receive or can get the source code. And you must show them these terms so they know their rights.

We protect your rights with two steps: (1) copyright the software, and (2) offer you this license which gives you legal permission to copy, distribute and/or modify the software.

Also, for each author's protection and ours, we want to make certain that everyone understands that there is no warranty for this free software. If the software is modified by someone else and passed on, we want its recipients to know that what they have is not the original, so that any problems introduced by others will not reflect on the original authors' reputations.

Finally, any free program is threatened constantly by software patents. We wish to avoid the danger that redistributors of a free program will individually obtain patent licenses, in effect making the program proprietary. To prevent this, we have made it clear that any patent must be licensed for everyone's free use or not licensed at all.

The precise terms and conditions for copying, distribution and modification follow.

GNU GENERAL PUBLIC LICENSE TERMS AND CONDITIONS FOR COPYING, DISTRIBUTION AND MODIFICATION

0. This License applies to any program or other work which contains a notice placed by the copyright holder saying it may be distributed under the terms of this General Public License. The "Program", below, refers to any such program or work, and a "work based on the Program" means either the Program or any derivative work under copyright law: that is to say, a work containing the Program or a portion of it, either verbatim or with modifications and/or translated into another language. (Hereinafter, translation is included without limitation in the term "modification".) Each licensee is addressed as "you".

Activities other than copying, distribution and modification are not covered by this License; they are outside its scope. The act of running the Program is not restricted, and the output from the Program is covered only if its contents constitute a work based on the Program (independent of having been made by running the Program). Whether that is true depends on what the Program does.

1. You may copy and distribute verbatim copies of the Program's source code as you receive it, in any medium, provided that you

LICENCE TERMS (cont.)

conspicuously and appropriately publish on each copy an appropriate copyright notice and disclaimer of warranty; keep intact all the notices that refer to this License and to the absence of any warranty; and give any other recipients of the Program a copy of this License along with the Program.

You may charge a fee for the physical act of transferring a copy, and you may at your option offer warranty protection in exchange for a fee.

2. You may modify your copy or copies of the Program or any portion of it, thus forming a work based on the Program, and copy and distribute such modifications or work under the terms of Section 1 above, provided that you also meet all of these conditions:

a) You must cause the modified files to carry prominent notices stating that you changed the files and the date of any change.

b) You must cause any work that you distribute or publish, that in whole or in part contains or is derived from the Program or any part thereof, to be licensed as a whole at no charge to all third parties under the terms of this License.

c) If the modified program normally reads commands interactively when run, you must cause it, when started running for such interactive use in the most ordinary way, to print or display an announcement including an appropriate copyright notice and a notice that there is no warranty (or else, saying that you provide a warranty) and that users may redistribute the program under these conditions, and telling the user how to view a copy of this License. (Exception: if the Program itself is interactive but does not normally print such an announcement, your work based on the Program is not required to print an announcement.)

These requirements apply to the modified work as a whole. If identifiable sections of that work are not derived from the Program, and can be reasonably considered independent and separate works in themselves, then this License, and its terms, do not apply to those sections when you distribute them as separate works. But when you distribute the same sections as part of a whole which is a work based on the Program, the distribution of the whole must be on the terms of this License, whose permissions for other licensees extend to the entire whole, and thus to each and every part regardless of who wrote it.

Thus, it is not the intent of this section to claim rights or contest your rights to work written entirely by you; rather, the intent is to exercise the right to control the distribution of derivative or collective works based on the Program.

In addition, mere aggregation of another work not based on the Program with the Program (or with a work based on the Program) on a volume of a storage or distribution medium does not bring the other work under the scope of this License.

3. You may copy and distribute the Program (or a work based on it, under Section 2) in object code or executable form under the terms of Sections 1 and 2 above provided that you also do one of the following:

a) Accompany it with the complete corresponding machine-readable source code, which must be distributed under the terms of Sections 1 and 2 above on a medium customarily used for software interchange; or,

b) Accompany it with a written offer, valid for at least three years, to give any third party, for a charge no more than your cost of physically performing source distribution, a complete machine-readable copy of the corresponding source code, to be distributed under the terms of Sections 1 and 2 above on a medium customarily used for software interchange; or,

c) Accompany it with the information you received as to the offer to distribute corresponding source code. (This alternative is allowed only for noncommercial distribution and only if you received the program in object code or executable form with such an offer, in accord with Subsection b above.)

The source code for a work means the preferred form of the work for making modifications to it. For an executable work, complete source code means all the source code for all modules it contains, plus any associated interface definition files, plus the scripts used to control compilation and installation of the executable. However, as a special exception, the source code distributed need not include anything that is normally distributed (in either source or binary form) with the major components (compiler, kernel, and so on) of the operating system on which the executable runs, unless that component itself accompanies the executable.

If distribution of executable or object code is made by offering access to copy from a designated place, then offering equivalent access to copy the source code from the same place counts as distribution of the source code, even though third parties are not compelled to copy the source along with the object code.

4. You may not copy, modify, sublicense, or distribute the Program except as expressly provided under this License. Any attempt otherwise to copy, modify, sublicense or distribute the Program is void, and will automatically terminate your rights under this License. However, parties who have received copies, or rights, from you under this License will not have their licenses terminated so long as such parties remain in full compliance.

5. You are not required to accept this License, since you have not signed it. However, nothing else grants you permission to modify or distribute the Program or its derivative works. These actions are prohibited by law if you do not accept this License. Therefore, by modifying or distributing the Program (or any work based on the Program), you indicate your acceptance of this License to do so, and all its terms and conditions for copying, distributing or modifying the Program or works based on it.

6. Each time you redistribute the Program (or any work based on the Program), the recipient automatically receives a license from the original licensor to copy, distribute or modify the Program subject to these terms and conditions. You may not impose any further restrictions on the recipients' exercise of the rights granted herein. You are not responsible for enforcing compliance by third parties to this License.

7. If, as a consequence of a court judgment or allegation of patent infringement or for any other reason (not limited to patent issues), conditions are imposed on you (whether by court order, agreement or otherwise) that contradict the conditions of this License, they do not excuse you from the conditions of this License. If you cannot distribute so as to satisfy simultaneously your obligations under this License and any other pertinent obligations, then as a consequence you may not distribute the Program at all. For example, if a patent license would not permit royalty-free redistribution of the Program by all those who receive copies directly or indirectly through you, then the only way you could satisfy both it and this License would be to refrain entirely from distribution of the Program.

If any portion of this section is held invalid or unenforceable under any particular circumstance, the balance of the section is intended to apply and the section as a whole is intended to apply in other circumstances.

It is not the purpose of this section to induce you to infringe any patents or other property right claims or to contest validity of any such claims; this section has the sole purpose of protecting the integrity of the free software distribution system, which is implemented by public license practices. Many people have made generous contributions to the wide range of software distributed through that system in reliance on consistent application of that system; it is up to the author/donor to decide if he or she is willing to distribute software through any other system and a licensee cannot impose that choice.

This section is intended to make thoroughly clear what is believed to be a consequence of the rest of this License.

8. If the distribution and/or use of the Program is restricted in certain countries either by patents or by copyrighted interfaces, the original copyright holder who places the Program under this License may add an explicit geographical distribution limitation excluding those countries, so that distribution is permitted only in or among countries not thus excluded. In such case, this License incorporates the limitation as if written in the body of this License.

9. The Free Software Foundation may publish revised and/or new versions of the General Public License from time to time. Such new versions will be similar in spirit to the present version, but may differ in detail to address new problems or concerns.

Each version is given a distinguishing version number. If the Program specifies a version number of this License which applies to it and "any later version", you have the option of following the terms and conditions either of that version or of any later version published by the Free Software Foundation. If the Program does not specify a version number of this License, you may choose any version ever published by the Free Software Foundation.

10. If you wish to incorporate parts of the Program into other free programs whose distribution conditions are different, write to the author to ask for permission. For software which is copyrighted by the Free Software Foundation, write to the Free Software Foundation; we sometimes

make exceptions for this. Our decision will be guided by the two goals of preserving the free status of all derivatives of our free software and of promoting the sharing and reuse of software generally.

NO WARRANTY

11. BECAUSE THE PROGRAM IS LICENSED FREE OF CHARGE, THERE IS NO WARRANTY FOR THE PROGRAM, TO THE EXTENT PERMITTED BY APPLICABLE LAW. EXCEPT WHEN OTHERWISE STATED IN WRITING THE COPYRIGHT HOLDERS AND/OR OTHER PARTIES PROVIDE THE PROGRAM "AS IS" WITHOUT WARRANTY OF ANY KIND, EITHER EXPRESSED OR IMPLIED, INCLUDING, BUT NOT LIMITED TO, THE IMPLIED WARRANTIES OF MERCHANTABILITY AND FITNESS FOR A PARTICULAR PURPOSE. THE ENTIRE RISK AS TO THE QUALITY AND PERFORMANCE OF THE PROGRAM IS WITH YOU. SHOULD THE PROGRAM PROVE DEFECTIVE, YOU ASSUME THE COST OF ALL NECESSARY SERVICING, REPAIR OR CORRECTION.

12. IN NO EVENT UNLESS REQUIRED BY APPLICABLE LAW OR AGREED TO IN WRITING WILL ANY COPYRIGHT HOLDER, OR ANY OTHER PARTY WHO MAY MODIFY AND/OR REDISTRIBUTE THE PROGRAM AS PERMITTED ABOVE, BE LIABLE TO YOU FOR DAMAGES, INCLUDING ANY GENERAL, SPECIAL, INCIDENTAL OR CONSEQUENTIAL DAMAGES ARISING OUT OF THE USE OR INABILITY TO USE THE PROGRAM (INCLUDING BUT NOT LIMITED TO LOSS OF DATA OR DATA BEING RENDERED INACCURATE OR LOSSES SUSTAINED BY YOU OR THIRD PARTIES OR A FAILURE OF THE PROGRAM TO OPERATE WITH ANY OTHER PROGRAMS), EVEN IF SUCH HOLDER OR OTHER PARTY HAS BEEN ADVISED OF THE POSSIBILITY OF SUCH DAMAGES.

END OF TERMS AND CONDITIONS

How to Apply These Terms to Your New Programs

If you develop a new program, and you want it to be of the greatest possible use to the public, the best way to achieve this is to make it free software which everyone can redistribute and change under these terms.

To do so, attach the following notices to the program. It is safest to attach them to the start of each source file to most effectively convey the exclusion of warranty; and each file should have at least the "copyright" line and a pointer to where the full notice is found.

```
<one line to give the program's name and a brief idea of what it does.>  
Copyright (C) <year> <name of author>
```

This program is free software; you can redistribute it and/or modify it under the terms of the GNU General Public License as published by the Free Software Foundation; either version 2 of the License, or (at your option) any later version.

This program is distributed in the hope that it will be useful, but WITHOUT ANY WARRANTY; without even the implied warranty of MERCHANTABILITY or FITNESS FOR A PARTICULAR PURPOSE. See the GNU General Public License for more details.

You should have received a copy of the GNU General Public License along with this program; if not, write to the Free Software Foundation, Inc., 51 Franklin Street, Fifth Floor, Boston, MA 02110-1301 USA

LICENCE TERMS (cont.)

Also add information on how to contact you by electronic and paper mail.

If the program is interactive, make it output a short notice like this when it starts in an interactive mode:

```
Gnomovision version 69, Copyright (C) year name of author
Gnomovision comes with ABSOLUTELY NO WARRANTY; for details type `show w'.
This is free software, and you are welcome to redistribute it
under certain conditions; type `show c' for details.
```

The hypothetical commands `show w' and `show c' should show the appropriate parts of the General Public License. Of course, the commands you use may be called something other than `show w' and `show c'; they could even be mouse-clicks or menu items--whatever suits your program.

You should also get your employer (if you work as a programmer) or your school, if any, to sign a "copyright disclaimer" for the program, if necessary. Here is a sample; alter the names:

```
Yoyodyne, Inc., hereby disclaims all copyright interest in the program
`Gnomovision' (which makes passes at compilers) written by James Hacker.
```

```
<signature of Ty Coon>, 1 April 1989
Ty Coon, President of Vice
```

This General Public License does not permit incorporating your program into proprietary programs. If your program is a subroutine library, you may consider it more useful to permit linking proprietary applications with the library. If this is what you want to do, use the GNU Library General Public License instead of this License.

GNU GENERAL PUBLIC LICENSE Version 2, June 1991

Copyright (C) 1989, 1991 Free Software Foundation, Inc.
59 Temple Place, Suite 330, Boston, MA 02111-1307 USA
Everyone is permitted to copy and distribute verbatim copies
of this license document, but changing it is not allowed.

Preamble

The licenses for most software are designed to take away your freedom to share and change it. By contrast, the GNU General Public License is intended to guarantee your freedom to share and change free software--to make sure the software is free for all its users. This General Public License applies to most of the Free Software Foundation's software and to any other program whose authors commit to using it. (Some other Free Software Foundation software is covered by the GNU Library General Public License instead.) You can apply it to your programs, too.

When we speak of free software, we are referring to freedom, not price. Our General Public Licenses are designed to make sure that you have the freedom to distribute copies of free software (and charge for this service if you wish), that you receive source code or can get it

if you want it, that you can change the software or use pieces of it in new free programs; and that you know you can do these things.

To protect your rights, we need to make restrictions that forbid anyone to deny you these rights or to ask you to surrender the rights. These restrictions translate to certain responsibilities for you if you distribute copies of the software, or if you modify it.

For example, if you distribute copies of such a program, whether gratis or for a fee, you must give the recipients all the rights that you have. You must make sure that they, too, receive or can get the source code. And you must show them these terms so they know their rights.

We protect your rights with two steps: (1) copyright the software, and (2) offer you this license which gives you legal permission to copy, distribute and/or modify the software.

Also, for each author's protection and ours, we want to make certain that everyone understands that there is no warranty for this free software. If the software is modified by someone else and passed on, we want its recipients to know that what they have is not the original, so that any problems introduced by others will not reflect on the original authors' reputations.

Finally, any free program is threatened constantly by software patents. We wish to avoid the danger that redistributors of a free program will individually obtain patent licenses, in effect making the program proprietary. To prevent this, we have made it clear that any patent must be licensed for everyone's free use or not licensed at all.

The precise terms and conditions for copying, distribution and modification follow.

GNU GENERAL PUBLIC LICENSE TERMS AND CONDITIONS FOR COPYING, DISTRIBUTION AND MODIFICATION

0. This License applies to any program or other work which contains a notice placed by the copyright holder saying it may be distributed under the terms of this General Public License. The "Program", below, refers to any such program or work, and a "work based on the Program" means either the Program or any derivative work under copyright law: that is to say, a work containing the Program or a portion of it, either verbatim or with modifications and/or translated into another language. (Hereinafter, translation is included without limitation in the term "modification".) Each licensee is addressed as "you".

Activities other than copying, distribution and modification are not covered by this License; they are outside its scope. The act of running the Program is not restricted, and the output from the Program is covered only if its contents constitute a work based on the Program (independent of having been made by running the Program). Whether that is true depends on what the Program does.

1. You may copy and distribute verbatim copies of the Program's source code as you receive it, in any medium, provided that you conspicuously and appropriately publish on each copy an appropriate

LICENCE TERMS (cont.)

copyright notice and disclaimer of warranty; keep intact all the notices that refer to this License and to the absence of any warranty; and give any other recipients of the Program a copy of this License along with the Program.

You may charge a fee for the physical act of transferring a copy, and you may at your option offer warranty protection in exchange for a fee.

2. You may modify your copy or copies of the Program or any portion of it, thus forming a work based on the Program, and copy and distribute such modifications or work under the terms of Section 1 above, provided that you also meet all of these conditions:

a) You must cause the modified files to carry prominent notices stating that you changed the files and the date of any change.

b) You must cause any work that you distribute or publish, that in whole or in part contains or is derived from the Program or any part thereof, to be licensed as a whole at no charge to all third parties under the terms of this License.

c) If the modified program normally reads commands interactively when run, you must cause it, when started running for such interactive use in the most ordinary way, to print or display an announcement including an appropriate copyright notice and a notice that there is no warranty (or else, saying that you provide a warranty) and that users may redistribute the program under these conditions, and telling the user how to view a copy of this License. (Exception: if the Program itself is interactive but does not normally print such an announcement, your work based on the Program is not required to print an announcement.)

These requirements apply to the modified work as a whole. If identifiable sections of that work are not derived from the Program, and can be reasonably considered independent and separate works in themselves, then this License, and its terms, do not apply to those sections when you distribute them as separate works. But when you distribute the same sections as part of a whole which is a work based on the Program, the distribution of the whole must be on the terms of this License, whose permissions for other licensees extend to the entire whole, and thus to each and every part regardless of who wrote it.

Thus, it is not the intent of this section to claim rights or contest your rights to work written entirely by you; rather, the intent is to exercise the right to control the distribution of derivative or collective works based on the Program.

In addition, mere aggregation of another work not based on the Program with the Program (or with a work based on the Program) on a volume of a storage or distribution medium does not bring the other work under the scope of this License.

3. You may copy and distribute the Program (or a work based on it, under Section 2) in object code or executable form under the terms of Sections 1 and 2 above provided that you also do one of the following:

a) Accompany it with the complete corresponding machine-readable

source code, which must be distributed under the terms of Sections 1 and 2 above on a medium customarily used for software interchange; or,

b) Accompany it with a written offer, valid for at least three years, to give any third party, for a charge no more than your cost of physically performing source distribution, a complete machine-readable copy of the corresponding source code, to be distributed under the terms of Sections 1 and 2 above on a medium customarily used for software interchange; or,

c) Accompany it with the information you received as to the offer to distribute corresponding source code. (This alternative is allowed only for noncommercial distribution and only if you received the program in object code or executable form with such an offer, in accord with Subsection b above.)

The source code for a work means the preferred form of the work for making modifications to it. For an executable work, complete source code means all the source code for all modules it contains, plus any associated interface definition files, plus the scripts used to control compilation and installation of the executable. However, as a special exception, the source code distributed need not include anything that is normally distributed (in either source or binary form) with the major components (compiler, kernel, and so on) of the operating system on which the executable runs, unless that component itself accompanies the executable.

If distribution of executable or object code is made by offering access to copy from a designated place, then offering equivalent access to copy the source code from the same place counts as distribution of the source code, even though third parties are not compelled to copy the source along with the object code.

4. You may not copy, modify, sublicense, or distribute the Program except as expressly provided under this License. Any attempt otherwise to copy, modify, sublicense or distribute the Program is void, and will automatically terminate your rights under this License. However, parties who have received copies, or rights, from you under this License will not have their licenses terminated so long as such parties remain in full compliance.

5. You are not required to accept this License, since you have not signed it. However, nothing else grants you permission to modify or distribute the Program or its derivative works. These actions are prohibited by law if you do not accept this License. Therefore, by modifying or distributing the Program (or any work based on the Program), you indicate your acceptance of this License to do so, and all its terms and conditions for copying, distributing or modifying the Program or works based on it.

6. Each time you redistribute the Program (or any work based on the Program), the recipient automatically receives a license from the original licensor to copy, distribute or modify the Program subject to these terms and conditions. You may not impose any further restrictions on the recipients' exercise of the rights granted herein. You are not responsible for enforcing compliance by third parties to this License.

7. If, as a consequence of a court judgment or allegation of patent infringement or for any other reason (not limited to patent issues), conditions are imposed on you (whether by court order, agreement or otherwise) that contradict the conditions of this License, they do not excuse you from the conditions of this License. If you cannot distribute so as to satisfy simultaneously your obligations under this License and any other pertinent obligations, then as a consequence you may not distribute the Program at all. For example, if a patent license would not permit royalty-free redistribution of the Program by all those who receive copies directly or indirectly through you, then the only way you could satisfy both it and this License would be to refrain entirely from distribution of the Program.

If any portion of this section is held invalid or unenforceable under any particular circumstance, the balance of the section is intended to apply and the section as a whole is intended to apply in other circumstances.

It is not the purpose of this section to induce you to infringe any patents or other property right claims or to contest validity of any such claims; this section has the sole purpose of protecting the integrity of the free software distribution system, which is implemented by public license practices. Many people have made generous contributions to the wide range of software distributed through that system in reliance on consistent application of that system; it is up to the author/donor to decide if he or she is willing to distribute software through any other system and a licensee cannot impose that choice.

This section is intended to make thoroughly clear what is believed to be a consequence of the rest of this License.

8. If the distribution and/or use of the Program is restricted in certain countries either by patents or by copyrighted interfaces, the original copyright holder who places the Program under this License may add an explicit geographical distribution limitation excluding those countries, so that distribution is permitted only in or among countries not thus excluded. In such case, this License incorporates the limitation as if written in the body of this License.

9. The Free Software Foundation may publish revised and/or new versions of the General Public License from time to time. Such new versions will be similar in spirit to the present version, but may differ in detail to address new problems or concerns.

Each version is given a distinguishing version number. If the Program specifies a version number of this License which applies to it and "any later version", you have the option of following the terms and conditions either of that version or of any later version published by the Free Software Foundation. If the Program does not specify a version number of this License, you may choose any version ever published by the Free Software Foundation.

10. If you wish to incorporate parts of the Program into other free programs whose distribution conditions are different, write to the author to ask for permission. For software which is copyrighted by the Free Software Foundation, write to the Free Software Foundation; we sometimes

make exceptions for this. Our decision will be guided by the two goals of preserving the free status of all derivatives of our free software and of promoting the sharing and reuse of software generally.

NO WARRANTY

11. BECAUSE THE PROGRAM IS LICENSED FREE OF CHARGE, THERE IS NO WARRANTY FOR THE PROGRAM, TO THE EXTENT PERMITTED BY APPLICABLE LAW. EXCEPT WHEN OTHERWISE STATED IN WRITING THE COPYRIGHT HOLDERS AND/OR OTHER PARTIES PROVIDE THE PROGRAM "AS IS" WITHOUT WARRANTY OF ANY KIND, EITHER EXPRESSED OR IMPLIED, INCLUDING, BUT NOT LIMITED TO, THE IMPLIED WARRANTIES OF MERCHANTABILITY AND FITNESS FOR A PARTICULAR PURPOSE. THE ENTIRE RISK AS TO THE QUALITY AND PERFORMANCE OF THE PROGRAM IS WITH YOU. SHOULD THE PROGRAM PROVE DEFECTIVE, YOU ASSUME THE COST OF ALL NECESSARY SERVICING, REPAIR OR CORRECTION.

12. IN NO EVENT UNLESS REQUIRED BY APPLICABLE LAW OR AGREED TO IN WRITING WILL ANY COPYRIGHT HOLDER, OR ANY OTHER PARTY WHO MAY MODIFY AND/OR REDISTRIBUTE THE PROGRAM AS PERMITTED ABOVE, BE LIABLE TO YOU FOR DAMAGES, INCLUDING ANY GENERAL, SPECIAL, INCIDENTAL OR CONSEQUENTIAL DAMAGES ARISING OUT OF THE USE OR INABILITY TO USE THE PROGRAM (INCLUDING BUT NOT LIMITED TO LOSS OF DATA OR DATA BEING RENDERED INACCURATE OR LOSSES SUSTAINED BY YOU OR THIRD PARTIES OR A FAILURE OF THE PROGRAM TO OPERATE WITH ANY OTHER PROGRAMS), EVEN IF SUCH HOLDER OR OTHER PARTY HAS BEEN ADVISED OF THE POSSIBILITY OF SUCH DAMAGES.

END OF TERMS AND CONDITIONS

How to Apply These Terms to Your New Programs

If you develop a new program, and you want it to be of the greatest possible use to the public, the best way to achieve this is to make it free software which everyone can redistribute and change under these terms.

To do so, attach the following notices to the program. It is safest to attach them to the start of each source file to most effectively convey the exclusion of warranty; and each file should have at least the "copyright" line and a pointer to where the full notice is found.

```
<one line to give the program's name and a brief idea of what it does.>  
Copyright (C) <year> <name of author>
```

This program is free software; you can redistribute it and/or modify it under the terms of the GNU General Public License as published by the Free Software Foundation; either version 2 of the License, or (at your option) any later version.

This program is distributed in the hope that it will be useful, but WITHOUT ANY WARRANTY; without even the implied warranty of MERCHANTABILITY or FITNESS FOR A PARTICULAR PURPOSE. See the GNU General Public License for more details.

You should have received a copy of the GNU General Public License along with this program; if not, write to the Free Software Foundation, Inc., 59 Temple Place, Suite 330, Boston, MA 02111-1307 USA

LICENCE TERMS (cont.)

Also add information on how to contact you by electronic and paper mail.

If the program is interactive, make it output a short notice like this when it starts in an interactive mode:

```
Gnomovision version 69, Copyright (C) year name of author
Gnomovision comes with ABSOLUTELY NO WARRANTY; for details type `show w'.
This is free software, and you are welcome to redistribute it
under certain conditions; type `show c' for details.
```

The hypothetical commands `show w' and `show c' should show the appropriate parts of the General Public License. Of course, the commands you use may be called something other than `show w' and `show c'; they could even be mouse-clicks or menu items--whatever suits your program.

You should also get your employer (if you work as a programmer) or your school, if any, to sign a ""copyright disclaimer"" for the program, if necessary. Here is a sample; alter the names:

```
Yoyodyne, Inc., hereby disclaims all copyright interest in the program
`Gnomovision' (which makes passes at compilers) written by James Hacker.
```

```
<signature of Ty Coon>, 1 April 1989
Ty Coon, President of Vice
```

This General Public License does not permit incorporating your program into proprietary programs. If your program is a subroutine library, you may consider it more useful to permit linking proprietary applications with the library. If this is what you want to do, use the GNU Library General Public License instead of this License.

GNU LESSER GENERAL PUBLIC LICENSE Version 2.1, February 1999

Copyright (C) 1991, 1999 Free Software Foundation, Inc.
51 Franklin Street, Fifth Floor, Boston, MA 02110-1301 USA
Everyone is permitted to copy and distribute verbatim copies
of this license document, but changing it is not allowed.

[This is the first released version of the Lesser GPL. It also counts
as the successor of the GNU Library Public License, version 2, hence
the version number 2.1.]

Preamble

The licenses for most software are designed to take away your freedom to share and change it. By contrast, the GNU General Public Licenses are intended to guarantee your freedom to share and change free software--to make sure the software is free for all its users.

This license, the Lesser General Public License, applies to some specially designated software packages--typically libraries--of the Free Software Foundation and other authors who decide to use it. You can use it too, but we suggest you first think carefully about whether this license or the ordinary General Public License is the better

strategy to use in any particular case, based on the explanations below.

When we speak of free software, we are referring to freedom of use, not price. Our General Public Licenses are designed to make sure that you have the freedom to distribute copies of free software (and charge for this service if you wish); that you receive source code or can get it if you want it; that you can change the software and use pieces of it in new free programs; and that you are informed that you can do these things.

To protect your rights, we need to make restrictions that forbid distributors to deny you these rights or to ask you to surrender these rights. These restrictions translate to certain responsibilities for you if you distribute copies of the library or if you modify it.

For example, if you distribute copies of the library, whether gratis or for a fee, you must give the recipients all the rights that we gave you. You must make sure that they, too, receive or can get the source code. If you link other code with the library, you must provide complete object files to the recipients, so that they can relink them with the library after making changes to the library and recompiling it. And you must show them these terms so they know their rights.

We protect your rights with a two-step method: (1) we copyright the library, and (2) we offer you this license, which gives you legal permission to copy, distribute and/or modify the library.

To protect each distributor, we want to make it very clear that there is no warranty for the free library. Also, if the library is modified by someone else and passed on, the recipients should know that what they have is not the original version, so that the original author's reputation will not be affected by problems that might be introduced by others.

Finally, software patents pose a constant threat to the existence of any free program. We wish to make sure that a company cannot effectively restrict the users of a free program by obtaining a restrictive license from a patent holder. Therefore, we insist that any patent license obtained for a version of the library must be consistent with the full freedom of use specified in this license.

Most GNU software, including some libraries, is covered by the ordinary GNU General Public License. This license, the GNU Lesser General Public License, applies to certain designated libraries, and is quite different from the ordinary General Public License. We use this license for certain libraries in order to permit linking those libraries into non-free programs.

When a program is linked with a library, whether statically or using a shared library, the combination of the two is legally speaking a combined work, a derivative of the original library. The ordinary General Public License therefore permits such linking only if the entire combination fits its criteria of freedom. The Lesser General Public License permits more lax criteria for linking other code with the library.

We call this license the ""Lesser"" General Public License because it

LICENCE TERMS (cont.)

does Less to protect the user's freedom than the ordinary General Public License. It also provides other free software developers Less of an advantage over competing non-free programs. These disadvantages are the reason we use the ordinary General Public License for many libraries. However, the Lesser license provides advantages in certain special circumstances.

For example, on rare occasions, there may be a special need to encourage the widest possible use of a certain library, so that it becomes a de-facto standard. To achieve this, non-free programs must be allowed to use the library. A more frequent case is that a free library does the same job as widely used non-free libraries. In this case, there is little to gain by limiting the free library to free software only, so we use the Lesser General Public License.

In other cases, permission to use a particular library in non-free programs enables a greater number of people to use a large body of free software. For example, permission to use the GNU C Library in non-free programs enables many more people to use the whole GNU operating system, as well as its variant, the GNU/Linux operating system.

Although the Lesser General Public License is Less protective of the users' freedom, it does ensure that the user of a program that is linked with the Library has the freedom and the wherewithal to run that program using a modified version of the Library.

The precise terms and conditions for copying, distribution and modification follow. Pay close attention to the difference between a ""work based on the library"" and a ""work that uses the library"". The former contains code derived from the library, whereas the latter must be combined with the library in order to run.

GNU LESSER GENERAL PUBLIC LICENSE TERMS AND CONDITIONS FOR COPYING, DISTRIBUTION AND MODIFICATION

0. This License Agreement applies to any software library or other program which contains a notice placed by the copyright holder or other authorized party saying it may be distributed under the terms of this Lesser General Public License (also called ""this License""). Each licensee is addressed as ""you"".

A ""library"" means a collection of software functions and/or data prepared so as to be conveniently linked with application programs (which use some of those functions and data) to form executables.

The ""Library"", below, refers to any such software library or work which has been distributed under these terms. A ""work based on the Library"" means either the Library or any derivative work under copyright law: that is to say, a work containing the Library or a portion of it, either verbatim or with modifications and/or translated straightforwardly into another language. (Hereinafter, translation is included without limitation in the term ""modification".")

""Source code"" for a work means the preferred form of the work for making modifications to it. For a library, complete source code means all the source code for all modules it contains, plus any associated

interface definition files, plus the scripts used to control compilation and installation of the library.

Activities other than copying, distribution and modification are not covered by this License; they are outside its scope. The act of running a program using the Library is not restricted, and output from such a program is covered only if its contents constitute a work based on the Library (independent of the use of the Library in a tool for writing it). Whether that is true depends on what the Library does and what the program that uses the Library does.

1. You may copy and distribute verbatim copies of the Library's complete source code as you receive it, in any medium, provided that you conspicuously and appropriately publish on each copy an appropriate copyright notice and disclaimer of warranty; keep intact all the notices that refer to this License and to the absence of any warranty; and distribute a copy of this License along with the Library.

You may charge a fee for the physical act of transferring a copy, and you may at your option offer warranty protection in exchange for a fee.

2. You may modify your copy or copies of the Library or any portion of it, thus forming a work based on the Library, and copy and distribute such modifications or work under the terms of Section 1 above, provided that you also meet all of these conditions:

- a) The modified work must itself be a software library.
- b) You must cause the files modified to carry prominent notices stating that you changed the files and the date of any change.
- c) You must cause the whole of the work to be licensed at no charge to all third parties under the terms of this License.
- d) If a facility in the modified Library refers to a function or a table of data to be supplied by an application program that uses the facility, other than as an argument passed when the facility is invoked, then you must make a good faith effort to ensure that, in the event an application does not supply such function or table, the facility still operates, and performs whatever part of its purpose remains meaningful.

(For example, a function in a library to compute square roots has a purpose that is entirely well-defined independent of the application. Therefore, Subsection 2d requires that any application-supplied function or table used by this function must be optional: if the application does not supply it, the square root function must still compute square roots.)

These requirements apply to the modified work as a whole. If identifiable sections of that work are not derived from the Library, and can be reasonably considered independent and separate works in themselves, then this License, and its terms, do not apply to those sections when you distribute them as separate works. But when you distribute the same sections as part of a whole which is a work based

LICENCE TERMS (cont.)

on the Library, the distribution of the whole must be on the terms of this License, whose permissions for other licensees extend to the entire whole, and thus to each and every part regardless of who wrote it.

Thus, it is not the intent of this section to claim rights or contest your rights to work written entirely by you; rather, the intent is to exercise the right to control the distribution of derivative or collective works based on the Library.

In addition, mere aggregation of another work not based on the Library with the Library (or with a work based on the Library) on a volume of a storage or distribution medium does not bring the other work under the scope of this License.

3. You may opt to apply the terms of the ordinary GNU General Public License instead of this License to a given copy of the Library. To do this, you must alter all the notices that refer to this License, so that they refer to the ordinary GNU General Public License, version 2, instead of to this License. (If a newer version than version 2 of the ordinary GNU General Public License has appeared, then you can specify that version instead if you wish.) Do not make any other change in these notices.

Once this change is made in a given copy, it is irreversible for that copy, so the ordinary GNU General Public License applies to all subsequent copies and derivative works made from that copy.

This option is useful when you wish to copy part of the code of the Library into a program that is not a library.

4. You may copy and distribute the Library (or a portion or derivative of it, under Section 2) in object code or executable form under the terms of Sections 1 and 2 above provided that you accompany it with the complete corresponding machine-readable source code, which must be distributed under the terms of Sections 1 and 2 above on a medium customarily used for software interchange.

If distribution of object code is made by offering access to copy from a designated place, then offering equivalent access to copy the source code from the same place satisfies the requirement to distribute the source code, even though third parties are not compelled to copy the source along with the object code.

5. A program that contains no derivative of any portion of the Library, but is designed to work with the Library by being compiled or linked with it, is called a "work that uses the Library". Such a work, in isolation, is not a derivative work of the Library, and therefore falls outside the scope of this License.

However, linking a "work that uses the Library" with the Library creates an executable that is a derivative of the Library (because it contains portions of the Library), rather than a "work that uses the library". The executable is therefore covered by this License. Section 6 states terms for distribution of such executables.

When a "work that uses the Library" uses material from a header file

that is part of the Library, the object code for the work may be a derivative work of the Library even though the source code is not. Whether this is true is especially significant if the work can be linked without the Library, or if the work is itself a library. The threshold for this to be true is not precisely defined by law.

If such an object file uses only numerical parameters, data structure layouts and accessors, and small macros and small inline functions (ten lines or less in length), then the use of the object file is unrestricted, regardless of whether it is legally a derivative work. (Executables containing this object code plus portions of the Library will still fall under Section 6.)

Otherwise, if the work is a derivative of the Library, you may distribute the object code for the work under the terms of Section 6. Any executables containing that work also fall under Section 6, whether or not they are linked directly with the Library itself.

6. As an exception to the Sections above, you may also combine or link a "work that uses the Library" with the Library to produce a work containing portions of the Library, and distribute that work under terms of your choice, provided that the terms permit modification of the work for the customer's own use and reverse engineering for debugging such modifications.

You must give prominent notice with each copy of the work that the Library is used in it and that the Library and its use are covered by this License. You must supply a copy of this License. If the work during execution displays copyright notices, you must include the copyright notice for the Library among them, as well as a reference directing the user to the copy of this License. Also, you must do one of these things:

- a) Accompany the work with the complete corresponding machine-readable source code for the Library including whatever changes were used in the work (which must be distributed under Sections 1 and 2 above); and, if the work is an executable linked with the Library, with the complete machine-readable "work that uses the Library", as object code and/or source code, so that the user can modify the Library and then relink to produce a modified executable containing the modified Library. (It is understood that the user who changes the contents of definitions files in the Library will not necessarily be able to recompile the application to use the modified definitions.)
- b) Use a suitable shared library mechanism for linking with the Library. A suitable mechanism is one that (1) uses at run time a copy of the library already present on the user's computer system, rather than copying library functions into the executable, and (2) will operate properly with a modified version of the library, if the user installs one, as long as the modified version is interface-compatible with the version that the work was made with.
- c) Accompany the work with a written offer, valid for at least three years, to give the same user the materials specified in Subsection 6a, above, for a charge no more than the cost of performing this distribution.

d) If distribution of the work is made by offering access to copy from a designated place, offer equivalent access to copy the above specified materials from the same place.

e) Verify that the user has already received a copy of these materials or that you have already sent this user a copy.

For an executable, the required form of the ""work that uses the Library"" must include any data and utility programs needed for reproducing the executable from it. However, as a special exception, the materials to be distributed need not include anything that is normally distributed (in either source or binary form) with the major components (compiler, kernel, and so on) of the operating system on which the executable runs, unless that component itself accompanies the executable.

It may happen that this requirement contradicts the license restrictions of other proprietary libraries that do not normally accompany the operating system. Such a contradiction means you cannot use both them and the Library together in an executable that you distribute.

7. You may place library facilities that are a work based on the Library side-by-side in a single library together with other library facilities not covered by this License, and distribute such a combined library, provided that the separate distribution of the work based on the Library and of the other library facilities is otherwise permitted, and provided that you do these two things:

a) Accompany the combined library with a copy of the same work based on the Library, uncombined with any other library facilities. This must be distributed under the terms of the Sections above.

b) Give prominent notice with the combined library of the fact that part of it is a work based on the Library, and explaining where to find the accompanying uncombined form of the same work.

8. You may not copy, modify, sublicense, link with, or distribute the Library except as expressly provided under this License. Any attempt otherwise to copy, modify, sublicense, link with, or distribute the Library is void, and will automatically terminate your rights under this License. However, parties who have received copies, or rights, from you under this License will not have their licenses terminated so long as such parties remain in full compliance.

9. You are not required to accept this License, since you have not signed it. However, nothing else grants you permission to modify or distribute the Library or its derivative works. These actions are prohibited by law if you do not accept this License. Therefore, by modifying or distributing the Library (or any work based on the Library), you indicate your acceptance of this License to do so, and all its terms and conditions for copying, distributing or modifying the Library or works based on it.

10. Each time you redistribute the Library (or any work based on the Library), the recipient automatically receives a license from the

original licensor to copy, distribute, link with or modify the Library subject to these terms and conditions. You may not impose any further restrictions on the recipients' exercise of the rights granted herein. You are not responsible for enforcing compliance by third parties with this License.

11. If, as a consequence of a court judgment or allegation of patent infringement or for any other reason (not limited to patent issues), conditions are imposed on you (whether by court order, agreement or otherwise) that contradict the conditions of this License, they do not excuse you from the conditions of this License. If you cannot distribute so as to satisfy simultaneously your obligations under this License and any other pertinent obligations, then as a consequence you may not distribute the Library at all. For example, if a patent license would not permit royalty-free redistribution of the Library by all those who receive copies directly or indirectly through you, then the only way you could satisfy both it and this License would be to refrain entirely from distribution of the Library.

If any portion of this section is held invalid or unenforceable under any particular circumstance, the balance of the section is intended to apply, and the section as a whole is intended to apply in other circumstances.

It is not the purpose of this section to induce you to infringe any patents or other property right claims or to contest validity of any such claims; this section has the sole purpose of protecting the integrity of the free software distribution system which is implemented by public license practices. Many people have made generous contributions to the wide range of software distributed through that system in reliance on consistent application of that system; it is up to the author/donor to decide if he or she is willing to distribute software through any other system and a licensee cannot impose that choice.

This section is intended to make thoroughly clear what is believed to be a consequence of the rest of this License.

12. If the distribution and/or use of the Library is restricted in certain countries either by patents or by copyrighted interfaces, the original copyright holder who places the Library under this License may add an explicit geographical distribution limitation excluding those countries, so that distribution is permitted only in or among countries not thus excluded. In such case, this License incorporates the limitation as if written in the body of this License.

13. The Free Software Foundation may publish revised and/or new versions of the Lesser General Public License from time to time. Such new versions will be similar in spirit to the present version, but may differ in detail to address new problems or concerns.

Each version is given a distinguishing version number. If the Library specifies a version number of this License which applies to it and ""any later version"", you have the option of following the terms and conditions either of that version or of any later version published by the Free Software Foundation. If the Library does not specify a license version number, you may choose any version ever published by the Free Software Foundation.

LICENCE TERMS (cont.)

14. If you wish to incorporate parts of the Library into other free programs whose distribution conditions are incompatible with these, write to the author to ask for permission. For software which is copyrighted by the Free Software Foundation, write to the Free Software Foundation; we sometimes make exceptions for this. Our decision will be guided by the two goals of preserving the free status of all derivatives of our free software and of promoting the sharing and reuse of software generally.

NO WARRANTY

15. BECAUSE THE LIBRARY IS LICENSED FREE OF CHARGE, THERE IS NO WARRANTY FOR THE LIBRARY, TO THE EXTENT PERMITTED BY APPLICABLE LAW. EXCEPT WHEN OTHERWISE STATED IN WRITING THE COPYRIGHT HOLDERS AND/OR OTHER PARTIES PROVIDE THE LIBRARY "AS IS" WITHOUT WARRANTY OF ANY KIND, EITHER EXPRESSED OR IMPLIED, INCLUDING, BUT NOT LIMITED TO, THE IMPLIED WARRANTIES OF MERCHANTABILITY AND FITNESS FOR A PARTICULAR PURPOSE. THE ENTIRE RISK AS TO THE QUALITY AND PERFORMANCE OF THE LIBRARY IS WITH YOU. SHOULD THE LIBRARY PROVE DEFECTIVE, YOU ASSUME THE COST OF ALL NECESSARY SERVICING, REPAIR OR CORRECTION.

16. IN NO EVENT UNLESS REQUIRED BY APPLICABLE LAW OR AGREED TO IN WRITING WILL ANY COPYRIGHT HOLDER, OR ANY OTHER PARTY WHO MAY MODIFY AND/OR REDISTRIBUTE THE LIBRARY AS PERMITTED ABOVE, BE LIABLE TO YOU FOR DAMAGES, INCLUDING ANY GENERAL, SPECIAL, INCIDENTAL OR CONSEQUENTIAL DAMAGES ARISING OUT OF THE USE OR INABILITY TO USE THE LIBRARY (INCLUDING BUT NOT LIMITED TO LOSS OF DATA OR DATA BEING RENDERED INACCURATE OR LOSSES SUSTAINED BY YOU OR THIRD PARTIES OR A FAILURE OF THE LIBRARY TO OPERATE WITH ANY OTHER SOFTWARE), EVEN IF SUCH HOLDER OR OTHER PARTY HAS BEEN ADVISED OF THE POSSIBILITY OF SUCH DAMAGES.

END OF TERMS AND CONDITIONS

How to Apply These Terms to Your New Libraries

If you develop a new library, and you want it to be of the greatest possible use to the public, we recommend making it free software that everyone can redistribute and change. You can do so by permitting redistribution under these terms (or, alternatively, under the terms of the ordinary General Public License).

To apply these terms, attach the following notices to the library. It is safest to attach them to the start of each source file to most effectively convey the exclusion of warranty; and each file should have at least the "copyright" line and a pointer to where the full notice is found.

<one line to give the library's name and a brief idea of what it does.>
Copyright (C) <year> <name of author>

This library is free software; you can redistribute it and/or modify it under the terms of the GNU Lesser General Public License as published by the Free Software Foundation; either version 2.1 of the License, or (at your option) any later version.

This library is distributed in the hope that it will be useful, but WITHOUT ANY WARRANTY; without even the implied warranty of

MERCHANTABILITY or FITNESS FOR A PARTICULAR PURPOSE. See the GNU Lesser General Public License for more details.

You should have received a copy of the GNU Lesser General Public License along with this library; if not, write to the Free Software Foundation, Inc., 51 Franklin Street, Fifth Floor, Boston, MA 02110-1301 USA

Also add information on how to contact you by electronic and paper mail.

You should also get your employer (if you work as a programmer) or your school, if any, to sign a "copyright disclaimer" for the library, if necessary. Here is a sample; alter the names:

Yoyodyne, Inc., hereby disclaims all copyright interest in the library 'Frob' (a library for tweaking knobs) written by James Random Hacker.

<signature of Ty Coon>, 1 April 1990
Ty Coon, President of Vice

That's all there is to it!

GNU LESSER GENERAL PUBLIC LICENSE Version 2.1, February 1999

Copyright (C) 1991, 1999 Free Software Foundation, Inc.
59 Temple Place, Suite 330, Boston, MA 02111-1307 USA
Everyone is permitted to copy and distribute verbatim copies of this license document, but changing it is not allowed.

[This is the first released version of the Lesser GPL. It also counts as the successor of the GNU Library Public License, version 2, hence the version number 2.1.]

Preamble

The licenses for most software are designed to take away your freedom to share and change it. By contrast, the GNU General Public Licenses are intended to guarantee your freedom to share and change free software--to make sure the software is free for all its users.

This license, the Lesser General Public License, applies to some specially designated software packages--typically libraries--of the Free Software Foundation and other authors who decide to use it. You can use it too, but we suggest you first think carefully about whether this license or the ordinary General Public License is the better strategy to use in any particular case, based on the explanations below.

When we speak of free software, we are referring to freedom of use, not price. Our General Public Licenses are designed to make sure that you have the freedom to distribute copies of free software (and charge for this service if you wish); that you receive source code or can get it if you want it; that you can change the software and use pieces of it in new free programs; and that you are informed that you can do these things.

LICENCE TERMS (cont.)

To protect your rights, we need to make restrictions that forbid distributors to deny you these rights or to ask you to surrender these rights. These restrictions translate to certain responsibilities for you if you distribute copies of the library or if you modify it.

For example, if you distribute copies of the library, whether gratis or for a fee, you must give the recipients all the rights that we gave you. You must make sure that they, too, receive or can get the source code. If you link other code with the library, you must provide complete object files to the recipients, so that they can relink them with the library after making changes to the library and recompiling it. And you must show them these terms so they know their rights.

We protect your rights with a two-step method: (1) we copyright the library, and (2) we offer you this license, which gives you legal permission to copy, distribute and/or modify the library.

To protect each distributor, we want to make it very clear that there is no warranty for the free library. Also, if the library is modified by someone else and passed on, the recipients should know that what they have is not the original version, so that the original author's reputation will not be affected by problems that might be introduced by others.

^L

Finally, software patents pose a constant threat to the existence of any free program. We wish to make sure that a company cannot effectively restrict the users of a free program by obtaining a restrictive license from a patent holder. Therefore, we insist that any patent license obtained for a version of the library must be consistent with the full freedom of use specified in this license.

Most GNU software, including some libraries, is covered by the ordinary GNU General Public License. This license, the GNU Lesser General Public License, applies to certain designated libraries, and is quite different from the ordinary General Public License. We use this license for certain libraries in order to permit linking those libraries into non-free programs.

When a program is linked with a library, whether statically or using a shared library, the combination of the two is legally speaking a combined work, a derivative of the original library. The ordinary General Public License therefore permits such linking only if the entire combination fits its criteria of freedom. The Lesser General Public License permits more lax criteria for linking other code with the library.

We call this license the ""Lesser"" General Public License because it does Less to protect the user's freedom than the ordinary General Public License. It also provides other free software developers Less of an advantage over competing non-free programs. These disadvantages are the reason we use the ordinary General Public License for many libraries. However, the Lesser license provides advantages in certain special circumstances.

For example, on rare occasions, there may be a special need to encourage the widest possible use of a certain library, so that it becomes a de-facto standard. To achieve this, non-free programs must

be allowed to use the library. A more frequent case is that a free library does the same job as widely used non-free libraries. In this case, there is little to gain by limiting the free library to free software only, so we use the Lesser General Public License.

In other cases, permission to use a particular library in non-free programs enables a greater number of people to use a large body of free software. For example, permission to use the GNU C Library in non-free programs enables many more people to use the whole GNU operating system, as well as its variant, the GNU/Linux operating system.

Although the Lesser General Public License is Less protective of the users' freedom, it does ensure that the user of a program that is linked with the Library has the freedom and the wherewithal to run that program using a modified version of the Library.

The precise terms and conditions for copying, distribution and modification follow. Pay close attention to the difference between a ""work based on the library"" and a ""work that uses the library"". The former contains code derived from the library, whereas the latter must be combined with the library in order to run.

^L

GNU LESSER GENERAL PUBLIC LICENSE TERMS AND CONDITIONS FOR COPYING, DISTRIBUTION AND MODIFICATION

0. This License Agreement applies to any software library or other program which contains a notice placed by the copyright holder or other authorized party saying it may be distributed under the terms of this Lesser General Public License (also called ""this License""). Each licensee is addressed as ""you"".

A ""library"" means a collection of software functions and/or data prepared so as to be conveniently linked with application programs (which use some of those functions and data) to form executables.

The ""Library"", below, refers to any such software library or work which has been distributed under these terms. A ""work based on the Library"" means either the Library or any derivative work under copyright law: that is to say, a work containing the Library or a portion of it, either verbatim or with modifications and/or translated straightforwardly into another language. (Hereinafter, translation is included without limitation in the term ""modification"".)

""Source code"" for a work means the preferred form of the work for making modifications to it. For a library, complete source code means all the source code for all modules it contains, plus any associated interface definition files, plus the scripts used to control compilation and installation of the library.

Activities other than copying, distribution and modification are not covered by this License; they are outside its scope. The act of running a program using the Library is not restricted, and output from such a program is covered only if its contents constitute a work based on the Library (independent of the use of the Library in a tool for writing it). Whether that is true depends on what the Library does and what the program that uses the Library does.

1. You may copy and distribute verbatim copies of the Library's complete source code as you receive it, in any medium, provided that you conspicuously and appropriately publish on each copy an appropriate copyright notice and disclaimer of warranty; keep intact all the notices that refer to this License and to the absence of any warranty; and distribute a copy of this License along with the Library.

You may charge a fee for the physical act of transferring a copy, and you may at your option offer warranty protection in exchange for a fee.

2. You may modify your copy or copies of the Library or any portion of it, thus forming a work based on the Library, and copy and distribute such modifications or work under the terms of Section 1 above, provided that you also meet all of these conditions:

- a) The modified work must itself be a software library.
- b) You must cause the files modified to carry prominent notices stating that you changed the files and the date of any change.
- c) You must cause the whole of the work to be licensed at no charge to all third parties under the terms of this License.
- d) If a facility in the modified Library refers to a function or a table of data to be supplied by an application program that uses the facility, other than as an argument passed when the facility is invoked, then you must make a good faith effort to ensure that, in the event an application does not supply such function or table, the facility still operates, and performs whatever part of its purpose remains meaningful.

(For example, a function in a library to compute square roots has a purpose that is entirely well-defined independent of the application. Therefore, Subsection 2d requires that any application-supplied function or table used by this function must be optional: if the application does not supply it, the square root function must still compute square roots.)

These requirements apply to the modified work as a whole. If identifiable sections of that work are not derived from the Library, and can be reasonably considered independent and separate works in themselves, then this License, and its terms, do not apply to those sections when you distribute them as separate works. But when you distribute the same sections as part of a whole which is a work based on the Library, the distribution of the whole must be on the terms of this License, whose permissions for other licensees extend to the entire whole, and thus to each and every part regardless of who wrote it.

Thus, it is not the intent of this section to claim rights or contest your rights to work written entirely by you; rather, the intent is to exercise the right to control the distribution of derivative or collective works based on the Library.

In addition, mere aggregation of another work not based on the Library

with the Library (or with a work based on the Library) on a volume of a storage or distribution medium does not bring the other work under the scope of this License.

3. You may opt to apply the terms of the ordinary GNU General Public License instead of this License to a given copy of the Library. To do this, you must alter all the notices that refer to this License, so that they refer to the ordinary GNU General Public License, version 2, instead of to this License. (If a newer version than version 2 of the ordinary GNU General Public License has appeared, then you can specify that version instead if you wish.) Do not make any other change in these notices.

^L

Once this change is made in a given copy, it is irreversible for that copy, so the ordinary GNU General Public License applies to all subsequent copies and derivative works made from that copy.

This option is useful when you wish to copy part of the code of the Library into a program that is not a library.

4. You may copy and distribute the Library (or a portion or derivative of it, under Section 2) in object code or executable form under the terms of Sections 1 and 2 above provided that you accompany it with the complete corresponding machine-readable source code, which must be distributed under the terms of Sections 1 and 2 above on a medium customarily used for software interchange.

If distribution of object code is made by offering access to copy from a designated place, then offering equivalent access to copy the source code from the same place satisfies the requirement to distribute the source code, even though third parties are not compelled to copy the source along with the object code.

5. A program that contains no derivative of any portion of the Library, but is designed to work with the Library by being compiled or linked with it, is called a ""work that uses the Library"". Such a work, in isolation, is not a derivative work of the Library, and therefore falls outside the scope of this License.

However, linking a ""work that uses the Library"" with the Library creates an executable that is a derivative of the Library (because it contains portions of the Library), rather than a ""work that uses the library"". The executable is therefore covered by this License. Section 6 states terms for distribution of such executables.

When a ""work that uses the Library"" uses material from a header file that is part of the Library, the object code for the work may be a derivative work of the Library even though the source code is not. Whether this is true is especially significant if the work can be linked without the Library, or if the work is itself a library. The threshold for this to be true is not precisely defined by law.

If such an object file uses only numerical parameters, data structure layouts and accessors, and small macros and small inline functions (ten lines or less in length), then the use of the object file is unrestricted, regardless of whether it is legally a derivative work. (Executables containing this object code plus portions of the

LICENCE TERMS (cont.)

Library will still fall under Section 6.)

Otherwise, if the work is a derivative of the Library, you may distribute the object code for the work under the terms of Section 6. Any executables containing that work also fall under Section 6, whether or not they are linked directly with the Library itself.

^L

6. As an exception to the Sections above, you may also combine or link a ""work that uses the Library"" with the Library to produce a work containing portions of the Library, and distribute that work under terms of your choice, provided that the terms permit modification of the work for the customer's own use and reverse engineering for debugging such modifications.

You must give prominent notice with each copy of the work that the Library is used in it and that the Library and its use are covered by this License. You must supply a copy of this License. If the work during execution displays copyright notices, you must include the copyright notice for the Library among them, as well as a reference directing the user to the copy of this License. Also, you must do one of these things:

a) Accompany the work with the complete corresponding machine-readable source code for the Library including whatever changes were used in the work (which must be distributed under Sections 1 and 2 above); and, if the work is an executable linked with the Library, with the complete machine-readable ""work that uses the Library"", as object code and/or source code, so that the user can modify the Library and then relink to produce a modified executable containing the modified Library. (It is understood that the user who changes the contents of definitions files in the Library will not necessarily be able to recompile the application to use the modified definitions.)

b) Use a suitable shared library mechanism for linking with the Library. A suitable mechanism is one that (1) uses at run time a copy of the library already present on the user's computer system, rather than copying library functions into the executable, and (2) will operate properly with a modified version of the library, if the user installs one, as long as the modified version is interface-compatible with the version that the work was made with.

c) Accompany the work with a written offer, valid for at least three years, to give the same user the materials specified in Subsection 6a, above, for a charge no more than the cost of performing this distribution.

d) If distribution of the work is made by offering access to copy from a designated place, offer equivalent access to copy the above specified materials from the same place.

e) Verify that the user has already received a copy of these materials or that you have already sent this user a copy.

For an executable, the required form of the ""work that uses the Library"" must include any data and utility programs needed for reproducing the executable from it. However, as a special exception,

the materials to be distributed need not include anything that is normally distributed (in either source or binary form) with the major components (compiler, kernel, and so on) of the operating system on which the executable runs, unless that component itself accompanies the executable.

It may happen that this requirement contradicts the license restrictions of other proprietary libraries that do not normally accompany the operating system. Such a contradiction means you cannot use both them and the Library together in an executable that you distribute.

^L

7. You may place library facilities that are a work based on the Library side-by-side in a single library together with other library facilities not covered by this License, and distribute such a combined library, provided that the separate distribution of the work based on the Library and of the other library facilities is otherwise permitted, and provided that you do these two things:

a) Accompany the combined library with a copy of the same work based on the Library, uncombined with any other library facilities. This must be distributed under the terms of the Sections above.

b) Give prominent notice with the combined library of the fact that part of it is a work based on the Library, and explaining where to find the accompanying uncombined form of the same work.

8. You may not copy, modify, sublicense, link with, or distribute the Library except as expressly provided under this License. Any attempt otherwise to copy, modify, sublicense, link with, or distribute the Library is void, and will automatically terminate your rights under this License. However, parties who have received copies, or rights, from you under this License will not have their licenses terminated so long as such parties remain in full compliance.

9. You are not required to accept this License, since you have not signed it. However, nothing else grants you permission to modify or distribute the Library or its derivative works. These actions are prohibited by law if you do not accept this License. Therefore, by modifying or distributing the Library (or any work based on the Library), you indicate your acceptance of this License to do so, and all its terms and conditions for copying, distributing or modifying the Library or works based on it.

10. Each time you redistribute the Library (or any work based on the Library), the recipient automatically receives a license from the original licensor to copy, distribute, link with or modify the Library subject to these terms and conditions. You may not impose any further restrictions on the recipients' exercise of the rights granted herein. You are not responsible for enforcing compliance by third parties with this License.

^L

11. If, as a consequence of a court judgment or allegation of patent infringement or for any other reason (not limited to patent issues), conditions are imposed on you (whether by court order, agreement or otherwise) that contradict the conditions of this License, they do not

excuse you from the conditions of this License. If you cannot distribute so as to satisfy simultaneously your obligations under this License and any other pertinent obligations, then as a consequence you may not distribute the Library at all. For example, if a patent license would not permit royalty-free redistribution of the Library by all those who receive copies directly or indirectly through you, then the only way you could satisfy both it and this License would be to refrain entirely from distribution of the Library.

If any portion of this section is held invalid or unenforceable under any particular circumstance, the balance of the section is intended to apply, and the section as a whole is intended to apply in other circumstances.

It is not the purpose of this section to induce you to infringe any patents or other property right claims or to contest validity of any such claims; this section has the sole purpose of protecting the integrity of the free software distribution system which is implemented by public license practices. Many people have made generous contributions to the wide range of software distributed through that system in reliance on consistent application of that system; it is up to the author/donor to decide if he or she is willing to distribute software through any other system and a licensee cannot impose that choice.

This section is intended to make thoroughly clear what is believed to be a consequence of the rest of this License.

12. If the distribution and/or use of the Library is restricted in certain countries either by patents or by copyrighted interfaces, the original copyright holder who places the Library under this License may add an explicit geographical distribution limitation excluding those countries, so that distribution is permitted only in or among countries not thus excluded. In such case, this License incorporates the limitation as if written in the body of this License.

13. The Free Software Foundation may publish revised and/or new versions of the Lesser General Public License from time to time. Such new versions will be similar in spirit to the present version, but may differ in detail to address new problems or concerns.

Each version is given a distinguishing version number. If the Library specifies a version number of this License which applies to it and "any later version", you have the option of following the terms and conditions either of that version or of any later version published by the Free Software Foundation. If the Library does not specify a license version number, you may choose any version ever published by the Free Software Foundation.

^L

14. If you wish to incorporate parts of the Library into other free programs whose distribution conditions are incompatible with these, write to the author to ask for permission. For software which is copyrighted by the Free Software Foundation, write to the Free Software Foundation; we sometimes make exceptions for this. Our decision will be guided by the two goals of preserving the free status of all derivatives of our free software and of promoting the sharing and reuse of software generally.

NO WARRANTY

15. BECAUSE THE LIBRARY IS LICENSED FREE OF CHARGE, THERE IS NO WARRANTY FOR THE LIBRARY, TO THE EXTENT PERMITTED BY APPLICABLE LAW. EXCEPT WHEN OTHERWISE STATED IN WRITING THE COPYRIGHT HOLDERS AND/OR OTHER PARTIES PROVIDE THE LIBRARY "AS IS" WITHOUT WARRANTY OF ANY KIND, EITHER EXPRESSED OR IMPLIED, INCLUDING, BUT NOT LIMITED TO, THE IMPLIED WARRANTIES OF MERCHANTABILITY AND FITNESS FOR A PARTICULAR PURPOSE. THE ENTIRE RISK AS TO THE QUALITY AND PERFORMANCE OF THE LIBRARY IS WITH YOU. SHOULD THE LIBRARY PROVE DEFECTIVE, YOU ASSUME THE COST OF ALL NECESSARY SERVICING, REPAIR OR CORRECTION.

16. IN NO EVENT UNLESS REQUIRED BY APPLICABLE LAW OR AGREED TO IN WRITING WILL ANY COPYRIGHT HOLDER, OR ANY OTHER PARTY WHO MAY MODIFY AND/OR REDISTRIBUTE THE LIBRARY AS PERMITTED ABOVE, BE LIABLE TO YOU FOR DAMAGES, INCLUDING ANY GENERAL, SPECIAL, INCIDENTAL OR CONSEQUENTIAL DAMAGES ARISING OUT OF THE USE OR INABILITY TO USE THE LIBRARY (INCLUDING BUT NOT LIMITED TO LOSS OF DATA OR DATA BEING RENDERED INACCURATE OR LOSSES SUSTAINED BY YOU OR THIRD PARTIES OR A FAILURE OF THE LIBRARY TO OPERATE WITH ANY OTHER SOFTWARE), EVEN IF SUCH HOLDER OR OTHER PARTY HAS BEEN ADVISED OF THE POSSIBILITY OF SUCH DAMAGES.

END OF TERMS AND CONDITIONS

^L

How to Apply These Terms to Your New Libraries

If you develop a new library, and you want it to be of the greatest possible use to the public, we recommend making it free software that everyone can redistribute and change. You can do so by permitting redistribution under these terms (or, alternatively, under the terms of the ordinary General Public License).

To apply these terms, attach the following notices to the library. It is safest to attach them to the start of each source file to most effectively convey the exclusion of warranty; and each file should have at least the "copyright" line and a pointer to where the full notice is found.

<one line to give the library's name and a brief idea of what it does.>
Copyright (C) <year> <name of author>

This library is free software; you can redistribute it and/or modify it under the terms of the GNU Lesser General Public License as published by the Free Software Foundation; either version 2.1 of the License, or (at your option) any later version.

This library is distributed in the hope that it will be useful, but WITHOUT ANY WARRANTY; without even the implied warranty of MERCHANTABILITY or FITNESS FOR A PARTICULAR PURPOSE. See the GNU Lesser General Public License for more details.

You should have received a copy of the GNU Lesser General Public License along with this library; if not, write to the Free Software Foundation, Inc., 59 Temple Place, Suite 330, Boston, MA 02111-1307 USA

LICENCE TERMS (cont.)

Also add information on how to contact you by electronic and paper mail.

You should also get your employer (if you work as a programmer) or your school, if any, to sign a ""copyright disclaimer"" for the library, if necessary. Here is a sample; alter the names:

Yoyodyne, Inc., hereby disclaims all copyright interest in the library 'Frob' (a library for tweaking knobs) written by James Random Hacker.

<signature of Ty Coon>, 1 April 1990
Ty Coon, President of Vice

That's all there is to it!

GNU GENERAL PUBLIC LICENSE Version 3, 29 June 2007

Copyright (C) 2007 Free Software Foundation, Inc. <<http://fsf.org/>>
Everyone is permitted to copy and distribute verbatim copies of this license document, but changing it is not allowed.

Preamble

The GNU General Public License is a free, copyleft license for software and other kinds of works.

The licenses for most software and other practical works are designed to take away your freedom to share and change the works. By contrast, the GNU General Public License is intended to guarantee your freedom to share and change all versions of a program--to make sure it remains free software for all its users. We, the Free Software Foundation, use the GNU General Public License for most of our software; it applies also to any other work released this way by its authors. You can apply it to your programs, too.

When we speak of free software, we are referring to freedom, not price. Our General Public Licenses are designed to make sure that you have the freedom to distribute copies of free software (and charge for them if you wish), that you receive source code or can get it if you want it, that you can change the software or use pieces of it in new free programs, and that you know you can do these things.

To protect your rights, we need to prevent others from denying you these rights or asking you to surrender the rights. Therefore, you have certain responsibilities if you distribute copies of the software, or if you modify it: responsibilities to respect the freedom of others.

For example, if you distribute copies of such a program, whether gratis or for a fee, you must pass on to the recipients the same freedoms that you received. You must make sure that they, too, receive or can get the source code. And you must show them these terms so they know their rights.

Developers that use the GNU GPL protect your rights with two steps:

(1) assert copyright on the software, and (2) offer you this License giving you legal permission to copy, distribute and/or modify it.

For the developers' and authors' protection, the GPL clearly explains that there is no warranty for this free software. For both users' and authors' sake, the GPL requires that modified versions be marked as changed, so that their problems will not be attributed erroneously to authors of previous versions.

Some devices are designed to deny users access to install or run modified versions of the software inside them, although the manufacturer can do so. This is fundamentally incompatible with the aim of protecting users' freedom to change the software. The systematic pattern of such abuse occurs in the area of products for individuals to use, which is precisely where it is most unacceptable. Therefore, we have designed this version of the GPL to prohibit the practice for those products. If such problems arise substantially in other domains, we stand ready to extend this provision to those domains in future versions of the GPL, as needed to protect the freedom of users.

Finally, every program is threatened constantly by software patents. States should not allow patents to restrict development and use of software on general-purpose computers, but in those that do, we wish to avoid the special danger that patents applied to a free program could make it effectively proprietary. To prevent this, the GPL assures that patents cannot be used to render the program non-free.

The precise terms and conditions for copying, distribution and modification follow.

TERMS AND CONDITIONS

0. Definitions.

"This License" refers to version 3 of the GNU General Public License.

"Copyright" also means copyright-like laws that apply to other kinds of works, such as semiconductor masks.

"The Program" refers to any copyrightable work licensed under this License. Each licensee is addressed as "you". "Licensees" and "recipients" may be individuals or organizations.

To "modify" a work means to copy from or adapt all or part of the work in a fashion requiring copyright permission, other than the making of an exact copy. The resulting work is called a "modified version" of the earlier work or a work "based on" the earlier work.

A "covered work" means either the unmodified Program or a work based on the Program.

To "propagate" a work means to do anything with it that, without permission, would make you directly or secondarily liable for infringement under applicable copyright law, except executing it on a computer or modifying a private copy. Propagation includes copying, distribution (with or without modification), making available to the public, and in some countries other activities as well.

To "convey" a work means any kind of propagation that enables other parties to make or receive copies. Mere interaction with a user through a computer network, with no transfer of a copy, is not conveying.

An interactive user interface displays "Appropriate Legal Notices" to the extent that it includes a convenient and prominently visible feature that (1) displays an appropriate copyright notice, and (2) tells the user that there is no warranty for the work (except to the extent that warranties are provided), that licensees may convey the work under this License, and how to view a copy of this License. If the interface presents a list of user commands or options, such as a menu, a prominent item in the list meets this criterion.

1. Source Code.

The "source code" for a work means the preferred form of the work for making modifications to it. "Object code" means any non-source form of a work.

A "Standard Interface" means an interface that either is an official standard defined by a recognized standards body, or, in the case of interfaces specified for a particular programming language, one that is widely used among developers working in that language.

The "System Libraries" of an executable work include anything, other than the work as a whole, that (a) is included in the normal form of packaging a Major Component, but which is not part of that Major Component, and (b) serves only to enable use of the work with that Major Component, or to implement a Standard Interface for which an implementation is available to the public in source code form. A "Major Component", in this context, means a major essential component (kernel, window system, and so on) of the specific operating system (if any) on which the executable work runs, or a compiler used to produce the work, or an object code interpreter used to run it.

The "Corresponding Source" for a work in object code form means all the source code needed to generate, install, and (for an executable work) run the object code and to modify the work, including scripts to control those activities. However, it does not include the work's System Libraries, or general-purpose tools or generally available free programs which are used unmodified in performing those activities but which are not part of the work. For example, Corresponding Source includes interface definition files associated with source files for the work, and the source code for shared libraries and dynamically linked subprograms that the work is specifically designed to require, such as by intimate data communication or control flow between those subprograms and other parts of the work.

The Corresponding Source need not include anything that users can regenerate automatically from other parts of the Corresponding Source.

The Corresponding Source for a work in source code form is that same work.

2. Basic Permissions.

All rights granted under this License are granted for the term of copyright on the Program, and are irrevocable provided the stated conditions are met. This License explicitly affirms your unlimited permission to run the unmodified Program. The output from running a covered work is covered by this License only if the output, given its content, constitutes a covered work. This License acknowledges your rights of fair use or other equivalent, as provided by copyright law.

You may make, run and propagate covered works that you do not convey, without conditions so long as your license otherwise remains in force. You may convey covered works to others for the sole purpose of having them make modifications exclusively for you, or provide you with facilities for running those works, provided that you comply with the terms of this License in conveying all material for which you do not control copyright. Those thus making or running the covered works for you must do so exclusively on your behalf, under your direction and control, on terms that prohibit them from making any copies of your copyrighted material outside their relationship with you.

Conveying under any other circumstances is permitted solely under the conditions stated below. Sublicensing is not allowed; section 10 makes it unnecessary.

3. Protecting Users' Legal Rights From Anti-Circumvention Law.

No covered work shall be deemed part of an effective technological measure under any applicable law fulfilling obligations under article 11 of the WIPO copyright treaty adopted on 20 December 1996, or similar laws prohibiting or restricting circumvention of such measures.

When you convey a covered work, you waive any legal power to forbid circumvention of technological measures to the extent such circumvention is effected by exercising rights under this License with respect to the covered work, and you disclaim any intention to limit operation or modification of the work as a means of enforcing, against the work's users, your or third parties' legal rights to forbid circumvention of technological measures.

4. Conveying Verbatim Copies.

You may convey verbatim copies of the Program's source code as you receive it, in any medium, provided that you conspicuously and appropriately publish on each copy an appropriate copyright notice; keep intact all notices stating that this License and any non-permissive terms added in accord with section 7 apply to the code; keep intact all notices of the absence of any warranty; and give all recipients a copy of this License along with the Program.

You may charge any price or no price for each copy that you convey, and you may offer support or warranty protection for a fee.

5. Conveying Modified Source Versions.

You may convey a work based on the Program, or the modifications to produce it from the Program, in the form of source code under the terms of section 4, provided that you also meet all of these conditions:

- a) The work must carry prominent notices stating that you modified it, and giving a relevant date.
- b) The work must carry prominent notices stating that it is released under this License and any conditions added under section 7. This requirement modifies the requirement in section 4 to "keep intact all notices".
- c) You must license the entire work, as a whole, under this License to anyone who comes into possession of a copy. This License will therefore apply, along with any applicable section 7 additional terms, to the whole of the work, and all its parts, regardless of how they are packaged. This License gives no permission to license the work in any other way, but it does not invalidate such permission if you have separately received it.
- d) If the work has interactive user interfaces, each must display Appropriate Legal Notices; however, if the Program has interactive interfaces that do not display Appropriate Legal Notices, your work need not make them do so.

A compilation of a covered work with other separate and independent works, which are not by their nature extensions of the covered work, and which are not combined with it such as to form a larger program, in or on a volume of a storage or distribution medium, is called an "aggregate" if the compilation and its resulting copyright are not used to limit the access or legal rights of the compilation's users beyond what the individual works permit. Inclusion of a covered work in an aggregate does not cause this License to apply to the other parts of the aggregate.

6. Conveying Non-Source Forms.

You may convey a covered work in object code form under the terms of sections 4 and 5, provided that you also convey the machine-readable Corresponding Source under the terms of this License, in one of these ways:

- a) Convey the object code in, or embodied in, a physical product (including a physical distribution medium), accompanied by the Corresponding Source fixed on a durable physical medium customarily used for software interchange.
- b) Convey the object code in, or embodied in, a physical product (including a physical distribution medium), accompanied by a written offer, valid for at least three years and valid for as long as you offer spare parts or customer support for that product model, to give anyone who possesses the object code either (1) a copy of the Corresponding Source for all the software in the product that is covered by this License, on a durable physical medium customarily used for software interchange, for a price no more than your reasonable cost of physically performing this conveying of source, or (2) access to copy the Corresponding Source from a network server at no charge.
- c) Convey individual copies of the object code with a copy of the written offer to provide the Corresponding Source. This

alternative is allowed only occasionally and noncommercially, and only if you received the object code with such an offer, in accord with subsection 6b.

- d) Convey the object code by offering access from a designated place (gratis or for a charge), and offer equivalent access to the Corresponding Source in the same way through the same place at no further charge. You need not require recipients to copy the Corresponding Source along with the object code. If the place to copy the object code is a network server, the Corresponding Source may be on a different server (operated by you or a third party) that supports equivalent copying facilities, provided you maintain clear directions next to the object code saying where to find the Corresponding Source. Regardless of what server hosts the Corresponding Source, you remain obligated to ensure that it is available for as long as needed to satisfy these requirements.
- e) Convey the object code using peer-to-peer transmission, provided you inform other peers where the object code and Corresponding Source of the work are being offered to the general public at no charge under subsection 6d.

A separable portion of the object code, whose source code is excluded from the Corresponding Source as a System Library, need not be included in conveying the object code work.

A "User Product" is either (1) a "consumer product", which means any tangible personal property which is normally used for personal, family, or household purposes, or (2) anything designed or sold for incorporation into a dwelling. In determining whether a product is a consumer product, doubtful cases shall be resolved in favor of coverage. For a particular product received by a particular user, "normally used" refers to a typical or common use of that class of product, regardless of the status of the particular user or of the way in which the particular user actually uses, or expects or is expected to use, the product. A product is a consumer product regardless of whether the product has substantial commercial, industrial or non-consumer uses, unless such uses represent the only significant mode of use of the product.

"Installation Information" for a User Product means any methods, procedures, authorization keys, or other information required to install and execute modified versions of a covered work in that User Product from a modified version of its Corresponding Source. The information must suffice to ensure that the continued functioning of the modified object code is in no case prevented or interfered with solely because modification has been made.

If you convey an object code work under this section in, or with, or specifically for use in, a User Product, and the conveying occurs as part of a transaction in which the right of possession and use of the User Product is transferred to the recipient in perpetuity or for a fixed term (regardless of how the transaction is characterized), the Corresponding Source conveyed under this section must be accompanied by the Installation Information. But this requirement does not apply if neither you nor any third party retains the ability to install modified object code on the User Product (for example, the work has been installed in ROM).

The requirement to provide Installation Information does not include a requirement to continue to provide support service, warranty, or updates for a work that has been modified or installed by the recipient, or for the User Product in which it has been modified or installed. Access to a network may be denied when the modification itself materially and adversely affects the operation of the network or violates the rules and protocols for communication across the network.

Corresponding Source conveyed, and Installation Information provided, in accord with this section must be in a format that is publicly documented (and with an implementation available to the public in source code form), and must require no special password or key for unpacking, reading or copying.

7. Additional Terms.

"Additional permissions" are terms that supplement the terms of this License by making exceptions from one or more of its conditions. Additional permissions that are applicable to the entire Program shall be treated as though they were included in this License, to the extent that they are valid under applicable law. If additional permissions apply only to part of the Program, that part may be used separately under those permissions, but the entire Program remains governed by this License without regard to the additional permissions.

When you convey a copy of a covered work, you may at your option remove any additional permissions from that copy, or from any part of it. (Additional permissions may be written to require their own removal in certain cases when you modify the work.) You may place additional permissions on material, added by you to a covered work, for which you have or can give appropriate copyright permission.

Notwithstanding any other provision of this License, for material you add to a covered work, you may (if authorized by the copyright holders of that material) supplement the terms of this License with terms:

- a) Disclaiming warranty or limiting liability differently from the terms of sections 15 and 16 of this License; or
- b) Requiring preservation of specified reasonable legal notices or author attributions in that material or in the Appropriate Legal Notices displayed by works containing it; or
- c) Prohibiting misrepresentation of the origin of that material, or requiring that modified versions of such material be marked in reasonable ways as different from the original version; or
- d) Limiting the use for publicity purposes of names of licensors or authors of the material; or
- e) Declining to grant rights under trademark law for use of some trade names, trademarks, or service marks; or
- f) Requiring indemnification of licensors and authors of that material by anyone who conveys the material (or modified versions of it) with contractual assumptions of liability to the recipient, for any liability that these contractual assumptions directly impose on

those licensors and authors.

All other non-permissive additional terms are considered "further restrictions" within the meaning of section 10. If the Program as you received it, or any part of it, contains a notice stating that it is governed by this License along with a term that is a further restriction, you may remove that term. If a license document contains a further restriction but permits relicensing or conveying under this License, you may add to a covered work material governed by the terms of that license document, provided that the further restriction does not survive such relicensing or conveying.

If you add terms to a covered work in accord with this section, you must place, in the relevant source files, a statement of the additional terms that apply to those files, or a notice indicating where to find the applicable terms.

Additional terms, permissive or non-permissive, may be stated in the form of a separately written license, or stated as exceptions; the above requirements apply either way.

8. Termination.

You may not propagate or modify a covered work except as expressly provided under this License. Any attempt otherwise to propagate or modify it is void, and will automatically terminate your rights under this License (including any patent licenses granted under the third paragraph of section 11).

However, if you cease all violation of this License, then your license from a particular copyright holder is reinstated (a) provisionally, unless and until the copyright holder explicitly and finally terminates your license, and (b) permanently, if the copyright holder fails to notify you of the violation by some reasonable means prior to 60 days after the cessation.

Moreover, your license from a particular copyright holder is reinstated permanently if the copyright holder notifies you of the violation by some reasonable means, this is the first time you have received notice of violation of this License (for any work) from that copyright holder, and you cure the violation prior to 30 days after your receipt of the notice.

Termination of your rights under this section does not terminate the licenses of parties who have received copies or rights from you under this License. If your rights have been terminated and not permanently reinstated, you do not qualify to receive new licenses for the same material under section 10.

9. Acceptance Not Required for Having Copies.

You are not required to accept this License in order to receive or run a copy of the Program. Ancillary propagation of a covered work occurring solely as a consequence of using peer-to-peer transmission to receive a copy likewise does not require acceptance. However, nothing other than this License grants you permission to propagate or modify any covered work. These actions infringe copyright if you do

not accept this License. Therefore, by modifying or propagating a covered work, you indicate your acceptance of this License to do so.

10. Automatic Licensing of Downstream Recipients.

Each time you convey a covered work, the recipient automatically receives a license from the original licensors, to run, modify and propagate that work, subject to this License. You are not responsible for enforcing compliance by third parties with this License.

An "entity transaction" is a transaction transferring control of an organization, or substantially all assets of one, or subdividing an organization, or merging organizations. If propagation of a covered work results from an entity transaction, each party to that transaction who receives a copy of the work also receives whatever licenses to the work the party's predecessor in interest had or could give under the previous paragraph, plus a right to possession of the Corresponding Source of the work from the predecessor in interest, if the predecessor has it or can get it with reasonable efforts.

You may not impose any further restrictions on the exercise of the rights granted or affirmed under this License. For example, you may not impose a license fee, royalty, or other charge for exercise of rights granted under this License, and you may not initiate litigation (including a cross-claim or counterclaim in a lawsuit) alleging that any patent claim is infringed by making, using, selling, offering for sale, or importing the Program or any portion of it.

11. Patents.

A "contributor" is a copyright holder who authorizes use under this License of the Program or a work on which the Program is based. The work thus licensed is called the contributor's "contributor version".

A contributor's "essential patent claims" are all patent claims owned or controlled by the contributor, whether already acquired or hereafter acquired, that would be infringed by some manner, permitted by this License, of making, using, or selling its contributor version, but do not include claims that would be infringed only as a consequence of further modification of the contributor version. For purposes of this definition, "control" includes the right to grant patent sublicenses in a manner consistent with the requirements of this License.

Each contributor grants you a non-exclusive, worldwide, royalty-free patent license under the contributor's essential patent claims, to make, use, sell, offer for sale, import and otherwise run, modify and propagate the contents of its contributor version.

In the following three paragraphs, a "patent license" is any express agreement or commitment, however denominated, not to enforce a patent (such as an express permission to practice a patent or covenant not to sue for patent infringement). To "grant" such a patent license to a party means to make such an agreement or commitment not to enforce a patent against the party.

If you convey a covered work, knowingly relying on a patent license,

and the Corresponding Source of the work is not available for anyone to copy, free of charge and under the terms of this License, through a publicly available network server or other readily accessible means, then you must either (1) cause the Corresponding Source to be so available, or (2) arrange to deprive yourself of the benefit of the patent license for this particular work, or (3) arrange, in a manner consistent with the requirements of this License, to extend the patent license to downstream recipients. "Knowingly relying" means you have actual knowledge that, but for the patent license, your conveying the covered work in a country, or your recipient's use of the covered work in a country, would infringe one or more identifiable patents in that country that you have reason to believe are valid.

If, pursuant to or in connection with a single transaction or arrangement, you convey, or propagate by procuring conveyance of, a covered work, and grant a patent license to some of the parties receiving the covered work authorizing them to use, propagate, modify or convey a specific copy of the covered work, then the patent license you grant is automatically extended to all recipients of the covered work and works based on it.

A patent license is "discriminatory" if it does not include within the scope of its coverage, prohibits the exercise of, or is conditioned on the non-exercise of one or more of the rights that are specifically granted under this License. You may not convey a covered work if you are a party to an arrangement with a third party that is in the business of distributing software, under which you make payment to the third party based on the extent of your activity of conveying the work, and under which the third party grants, to any of the parties who would receive the covered work from you, a discriminatory patent license (a) in connection with copies of the covered work conveyed by you (or copies made from those copies), or (b) primarily for and in connection with specific products or compilations that contain the covered work, unless you entered into that arrangement, or that patent license was granted, prior to 28 March 2007.

Nothing in this License shall be construed as excluding or limiting any implied license or other defenses to infringement that may otherwise be available to you under applicable patent law.

12. No Surrender of Others' Freedom.

If conditions are imposed on you (whether by court order, agreement or otherwise) that contradict the conditions of this License, they do not excuse you from the conditions of this License. If you cannot convey a covered work so as to satisfy simultaneously your obligations under this License and any other pertinent obligations, then as a consequence you may not convey it at all. For example, if you agree to terms that obligate you to collect a royalty for further conveying from those to whom you convey the Program, the only way you could satisfy both those terms and this License would be to refrain entirely from conveying the Program.

13. Use with the GNU Affero General Public License.

Notwithstanding any other provision of this License, you have permission to link or combine any covered work with a work licensed under version 3 of the GNU Affero General Public License into a single

combined work, and to convey the resulting work. The terms of this License will continue to apply to the part which is the covered work, but the special requirements of the GNU Affero General Public License, section 13, concerning interaction through a network will apply to the combination as such.

14. Revised Versions of this License.

The Free Software Foundation may publish revised and/or new versions of the GNU General Public License from time to time. Such new versions will be similar in spirit to the present version, but may differ in detail to address new problems or concerns.

Each version is given a distinguishing version number. If the Program specifies that a certain numbered version of the GNU General Public License "or any later version" applies to it, you have the option of following the terms and conditions either of that numbered version or of any later version published by the Free Software Foundation. If the Program does not specify a version number of the GNU General Public License, you may choose any version ever published by the Free Software Foundation.

If the Program specifies that a proxy can decide which future versions of the GNU General Public License can be used, that proxy's public statement of acceptance of a version permanently authorizes you to choose that version for the Program.

Later license versions may give you additional or different permissions. However, no additional obligations are imposed on any author or copyright holder as a result of your choosing to follow a later version.

15. Disclaimer of Warranty.

THERE IS NO WARRANTY FOR THE PROGRAM, TO THE EXTENT PERMITTED BY APPLICABLE LAW. EXCEPT WHEN OTHERWISE STATED IN WRITING THE COPYRIGHT HOLDERS AND/OR OTHER PARTIES PROVIDE THE PROGRAM "AS IS" WITHOUT WARRANTY OF ANY KIND, EITHER EXPRESSED OR IMPLIED, INCLUDING, BUT NOT LIMITED TO, THE IMPLIED WARRANTIES OF MERCHANTABILITY AND FITNESS FOR A PARTICULAR PURPOSE. THE ENTIRE RISK AS TO THE QUALITY AND PERFORMANCE OF THE PROGRAM IS WITH YOU. SHOULD THE PROGRAM PROVE DEFECTIVE, YOU ASSUME THE COST OF ALL NECESSARY SERVICING, REPAIR OR CORRECTION.

16. Limitation of Liability.

IN NO EVENT UNLESS REQUIRED BY APPLICABLE LAW OR AGREED TO IN WRITING WILL ANY COPYRIGHT HOLDER, OR ANY OTHER PARTY WHO MODIFIES AND/OR CONVEYS THE PROGRAM AS PERMITTED ABOVE, BE LIABLE TO YOU FOR DAMAGES, INCLUDING ANY GENERAL, SPECIAL, INCIDENTAL OR CONSEQUENTIAL DAMAGES ARISING OUT OF THE USE OR INABILITY TO USE THE PROGRAM (INCLUDING BUT NOT LIMITED TO LOSS OF DATA OR DATA BEING RENDERED INACCURATE OR LOSSES SUSTAINED BY YOU OR THIRD PARTIES OR A FAILURE OF THE PROGRAM TO OPERATE WITH ANY OTHER PROGRAMS), EVEN IF SUCH HOLDER OR OTHER PARTY HAS BEEN ADVISED OF THE POSSIBILITY OF SUCH DAMAGES.

17. Interpretation of Sections 15 and 16.

If the disclaimer of warranty and limitation of liability provided above cannot be given local legal effect according to their terms, reviewing courts shall apply local law that most closely approximates an absolute waiver of all civil liability in connection with the Program, unless a warranty or assumption of liability accompanies a copy of the Program in return for a fee.

END OF TERMS AND CONDITIONS

How to Apply These Terms to Your New Programs

If you develop a new program, and you want it to be of the greatest possible use to the public, the best way to achieve this is to make it free software which everyone can redistribute and change under these terms.

To do so, attach the following notices to the program. It is safest to attach them to the start of each source file to most effectively state the exclusion of warranty; and each file should have at least the "copyright" line and a pointer to where the full notice is found.

```
<one line to give the program's name and a brief idea of what it does.>
Copyright (C) <year> <name of author>
```

This program is free software: you can redistribute it and/or modify it under the terms of the GNU General Public License as published by the Free Software Foundation, either version 3 of the License, or (at your option) any later version.

This program is distributed in the hope that it will be useful, but WITHOUT ANY WARRANTY; without even the implied warranty of MERCHANTABILITY or FITNESS FOR A PARTICULAR PURPOSE. See the GNU General Public License for more details.

You should have received a copy of the GNU General Public License along with this program. If not, see <http://www.gnu.org/licenses/>.

Also add information on how to contact you by electronic and paper mail.

If the program does terminal interaction, make it output a short notice like this when it starts in an interactive mode:

```
<program> Copyright (C) <year> <name of author>
This program comes with ABSOLUTELY NO WARRANTY; for details type `show w'.
This is free software, and you are welcome to redistribute it
under certain conditions; type `show c' for details.
```

The hypothetical commands `show w' and `show c' should show the appropriate parts of the General Public License. Of course, your program's commands might be different; for a GUI interface, you would use an "about box".

You should also get your employer (if you work as a programmer) or school, if any, to sign a "copyright disclaimer" for the program, if necessary. For more information on this, and how to apply and follow the GNU GPL, see <http://www.gnu.org/licenses/>.

The GNU General Public License does not permit incorporating your program into proprietary programs. If your program is a subroutine library, you

LICENCE TERMS (cont.)

may consider it more useful to permit linking proprietary applications with the library. If this is what you want to do, use the GNU Lesser General Public License instead of this License. But first, please read <http://www.gnu.org/philosophy/why-not-lgpl.html>.

GNU LESSER GENERAL PUBLIC LICENSE

Version 3, 29 June 2007

Copyright © 2007 Free Software Foundation, Inc. <https://fsf.org/>

Everyone is permitted to copy and distribute verbatim copies of this license document, but changing it is not allowed.

This version of the GNU Lesser General Public License incorporates the terms and conditions of version 3 of the GNU General Public License, supplemented by the additional permissions listed below.

0. Additional Definitions.

As used herein, “this License” refers to version 3 of the GNU Lesser General Public License, and the “GNU GPL” refers to version 3 of the GNU General Public License.

“The Library” refers to a covered work governed by this License, other than an Application or a Combined Work as defined below.

An “Application” is any work that makes use of an interface provided by the Library, but which is not otherwise based on the Library. Defining a subclass of a class defined by the Library is deemed a mode of using an interface provided by the Library.

A “Combined Work” is a work produced by combining or linking an Application with the Library. The particular version of the Library with which the Combined Work was made is also called the “Linked Version”.

The “Minimal Corresponding Source” for a Combined Work means the Corresponding Source for the Combined Work, excluding any source code for portions of the Combined Work that, considered in isolation, are based on the Application, and not on the Linked Version.

The “Corresponding Application Code” for a Combined Work means the object code and/or source code for the Application, including any data and utility programs needed for reproducing the Combined Work from the Application, but excluding the System Libraries of the Combined Work.

1. Exception to Section 3 of the GNU GPL.

You may convey a covered work under sections 3 and 4 of this License without being bound by section 3 of the GNU GPL.

2. Conveying Modified Versions.

If you modify a copy of the Library, and, in your modifications, a facility refers to a function or data to be supplied by an Application that uses the facility (other than as an argument passed when the facility is invoked), then you may convey a copy of the modified version:

- a) under this License, provided that you make a good faith effort to ensure that, in the event an Application does not supply the function or data, the facility still operates, and performs whatever part of its purpose remains meaningful, or
- b) under the GNU GPL, with none of the additional permissions of this License applicable to that copy.

3. Object Code Incorporating Material from Library Header Files.

The object code form of an Application may incorporate material from a header file that is part of the Library. You may convey such object code under terms of your choice, provided that, if the incorporated material is not limited to numerical parameters, data structure layouts and accessors, or small macros, inline functions and templates (ten or fewer lines in length), you do both of the following:

- a) Give prominent notice with each copy of the object code that the Library is used in it and that the Library and its use are covered by this License.
- b) Accompany the object code with a copy of the GNU GPL and this license document.

4. Combined Works.

You may convey a Combined Work under terms of your choice that, taken together, effectively do not restrict modification of the portions of the Library contained in the Combined Work and reverse engineering for debugging such modifications, if you also do each of the following:

- a) Give prominent notice with each copy of the Combined Work that the Library is used in it and that the Library and its use are covered by this License.
- b) Accompany the Combined Work with a copy of the GNU GPL and this license document.
- c) For a Combined Work that displays copyright notices during execution, include the copyright notice for the Library among these notices, as well as a reference directing the user to the copies of the GNU GPL and this license document.
- d) Do one of the following:
 - 0) Convey the Minimal Corresponding Source under the terms of this License, and the Corresponding Application Code in a form suitable for, and under terms that permit, the user to recombine or relink the Application with a modified version of the Linked Version to produce a modified Combined Work, in the manner specified by section 6 of the GNU GPL for conveying Corresponding Source.

1) Use a suitable shared library mechanism for linking with the Library. A suitable mechanism is one that (a) uses at run time a copy of the Library already present on the user's computer system, and (b) will operate properly with a modified version of the Library that is interface-compatible with the Linked Version.

e) Provide Installation Information, but only if you would otherwise be required to provide such information under section 6 of the GNU GPL, and only to the extent that such information is necessary to install and execute a modified version of the Combined Work produced by recombining or relinking the Application with a modified version of the Linked Version. (If you use option 4d0, the Installation Information must accompany the Minimal Corresponding Source and Corresponding Application Code. If you use option 4d1, you must provide the Installation Information in the manner specified by section 6 of the GNU GPL for conveying Corresponding Source.)

5. Combined Libraries.

You may place library facilities that are a work based on the Library side by side in a single library together with other library facilities that are not Applications and are not covered by this License, and convey such a combined library under terms of your choice, if you do both of the following:

- a) Accompany the combined library with a copy of the same work based on the Library, uncombined with any other library facilities, conveyed under the terms of this License.
- b) Give prominent notice with the combined library that part of it is a work based on the Library, and explaining where to find the accompanying uncombined form of the same work.

6. Revised Versions of the GNU Lesser General Public License.

The Free Software Foundation may publish revised and/or new versions of the GNU Lesser General Public License from time to time. Such new versions will be similar in spirit to the present version, but may differ in detail to address new problems or concerns.

Each version is given a distinguishing version number. If the Library as you received it specifies that a certain numbered version of the GNU Lesser General Public License “or any later version” applies to it, you have the option of following the terms and conditions either of that published version or of any later version published by the Free Software Foundation. If the Library as you received it does not specify a version number of the GNU Lesser General

LICENCE TERMS (cont.)

Public License, you may choose any version of the GNU Lesser General Public License ever published by the Free Software Foundation.

If the Library as you received it specifies that a proxy can decide whether future versions of the GNU Lesser General Public License shall apply, that proxy's public statement of acceptance of any version is permanent authorization for you to choose that version for the Library.

GCC RUNTIME LIBRARY EXCEPTION

Version 3.1, 31 March 2009

Copyright (C) 2009 Free Software Foundation, Inc. <<http://fsf.org/>>

Everyone is permitted to copy and distribute verbatim copies of this license document, but changing it is not allowed.

This GCC Runtime Library Exception ("Exception") is an additional permission under section 7 of the GNU General Public License, version 3 ("GPLv3"). It applies to a given file (the "Runtime Library") that bears a notice placed by the copyright holder of the file stating that the file is governed by GPLv3 along with this Exception.

When you use GCC to compile a program, GCC may combine portions of certain GCC header files and runtime libraries with the compiled program. The purpose of this Exception is to allow compilation of non-GPL (including proprietary) programs to use, in this way, the header files and runtime libraries covered by this Exception.

0. Definitions.

A file is an "Independent Module" if it either requires the Runtime Library for execution after a Compilation Process, or makes use of an interface provided by the Runtime Library, but is not otherwise based on the Runtime Library.

"GCC" means a version of the GNU Compiler Collection, with or without modifications, governed by version 3 (or a specified later version) of the GNU General Public License (GPL) with the option of using any subsequent versions published by the FSF.

"GPL-compatible Software" is software whose conditions of propagation, modification and use would permit combination with GCC in accord with the license of GCC.

"Target Code" refers to output from any compiler for a real or virtual target processor architecture, in executable form or suitable for input to an assembler, loader, linker and/or execution phase. Notwithstanding that, Target Code does not include data in any format that is used as a compiler intermediate representation, or used for producing a compiler intermediate representation.

The "Compilation Process" transforms code entirely represented in non-intermediate languages designed for human-written code, and/or in Java Virtual Machine byte code, into Target Code. Thus, for example, use of source code generators and preprocessors need not be considered

part of the Compilation Process, since the Compilation Process can be understood as starting with the output of the generators or preprocessors.

A Compilation Process is "Eligible" if it is done using GCC, alone or with other GPL-compatible software, or if it is done without using any work based on GCC. For example, using non-GPL-compatible Software to optimize any GCC intermediate representations would not qualify as an Eligible Compilation Process.

1. Grant of Additional Permission.

You have permission to propagate a work of Target Code formed by combining the Runtime Library with Independent Modules, even if such propagation would otherwise violate the terms of GPLv3, provided that all Target Code was generated by Eligible Compilation Processes. You may then convey such a combination under terms of your choice, consistent with the licensing of the Independent Modules.

2. No Weakening of GCC Copyleft.

The availability of this Exception does not imply any general presumption that third-party software is unaffected by the copyleft requirements of the license of GCC.

This is the Debian GNU/Linux package `debianutils`.

It is an original Debian package. Programs in it were maintained by Guy Maor <maor@debian.org>, and are now maintained by Clint Adams <schizo@debian.org>.

All its programs except `savelog`, and which may be redistributed under the terms of the GNU GPL, Version 2 or later, found on Debian systems in the file `/usr/share/common-licenses/GPL`.

which is in the public domain.

`savelog` may be redistributed under the following terms: (The rest of this file consists of `savelog`'s distribution terms.)

SMAIL GENERAL PUBLIC LICENSE
(Clarified 11 Feb 1988)

Copyright (C) 1988 Landon Curt Noll & Ronald S. Karr
Copyright (C) 1992 Ronald S. Karr
Copyleft (GNU) 1988 Landon Curt Noll & Ronald S. Karr

Everyone is permitted to copy and distribute verbatim copies of this license, but changing it is not allowed. You can also use this wording to make the terms for other programs.

The license agreements of most software companies keep you at the mercy of those companies. By contrast, our general public license is intended to give everyone the right to share SMAIL. To make sure that

LICENCE TERMS (cont.)

you get the rights we want you to have, we need to make restrictions that forbid anyone to deny you these rights or to ask you to surrender the rights. Hence this license agreement.

Specifically, we want to make sure that you have the right to give away copies of SMAIL, that you receive source code or else can get it if you want it, that you can change SMAIL or use pieces of it in new free programs, and that you know you can do these things.

To make sure that everyone has such rights, we have to forbid you to deprive anyone else of these rights. For example, if you distribute copies of SMAIL, you must give the recipients all the rights that you have. You must make sure that they, too, receive or can get the source code. And you must tell them their rights.

Also, for our own protection, we must make certain that everyone finds out that there is no warranty for SMAIL. If SMAIL is modified by someone else and passed on, we want its recipients to know that what they have is not what we distributed, so that any problems introduced by others will not reflect on our reputation.

Therefore we (Landon Curt Noll and Ronald S. Karr) make the following terms which say what you must do to be allowed to distribute or change SMAIL.

COPYING POLICIES

1. You may copy and distribute verbatim copies of SMAIL source code as you receive it, in any medium, provided that you conspicuously and appropriately publish on each copy a valid copyright notice ""Copyright (C) 1988 Landon Curt Noll & Ronald S. Karr"" (or with whatever year is appropriate); keep intact the notices on all files that refer to this License Agreement and to the absence of any warranty; and give any other recipients of the SMAIL program a copy of this License Agreement along with the program. You may charge a distribution fee for the physical act of transferring a copy.

2. You may modify your copy or copies of SMAIL or any portion of it, and copy and distribute such modifications under the terms of Paragraph 1 above, provided that you also do the following:

a) cause the modified files to carry prominent notices stating that you changed the files and the date of any change; and

b) cause the whole of any work that you distribute or publish, that in whole or in part contains or is a derivative of SMAIL or any part thereof, to be licensed at no charge to all third parties on terms identical to those contained in this License Agreement (except that you may choose to grant more extensive warranty protection to some or all third parties, at your option).

c) You may charge a distribution fee for the physical act of transferring a copy, and you may at your option offer warranty protection in exchange for a fee.

Mere aggregation of another unrelated program with this program (or its

derivative) on a volume of a storage or distribution medium does not bring the other program under the scope of these terms.

3. You may copy and distribute SMAIL (or a portion or derivative of it, under Paragraph 2) in object code or executable form under the terms of Paragraphs 1 and 2 above provided that you also do one of the following:

a) accompany it with the complete corresponding machine-readable source code, which must be distributed under the terms of Paragraphs 1 and 2 above; or,

b) accompany it with a written offer, valid for at least three years, to give any third party free (except for a nominal shipping charge) a complete machine-readable copy of the corresponding source code, to be distributed under the terms of Paragraphs 1 and 2 above; or,

c) accompany it with the information you received as to where the corresponding source code may be obtained. (This alternative is allowed only for non-commercial distribution and only if you received the program in object code or executable form alone.)

For an executable file, complete source code means all the source code for all modules it contains; but, as a special exception, it need not include source code for modules which are standard libraries that accompany the operating system on which the executable file runs.

4. You may not copy, sublicense, distribute or transfer SMAIL except as expressly provided under this License Agreement. Any attempt otherwise to copy, sublicense, distribute or transfer SMAIL is void and your rights to use the program under this License agreement shall be automatically terminated. However, parties who have received computer software programs from you with this License Agreement will not have their licenses terminated so long as such parties remain in full compliance.

5. If you wish to incorporate parts of SMAIL into other free programs whose distribution conditions are different, write to Landon Curt Noll & Ronald S. Karr via the Free Software Foundation at 51 Franklin St, Fifth Floor, Boston, MA 02110-1301, USA. We have not yet worked out a simple rule that can be stated here, but we will often permit this. We will be guided by the two goals of preserving the free status of all derivatives of our free software and of promoting the sharing and reuse of software.

Your comments and suggestions about our licensing policies and our software are welcome! This contract was based on the contract made by the Free Software Foundation. Please contact the Free Software Foundation, Inc., 51 Franklin St, Fifth Floor, Boston, MA 02110-1301, USA, or call (617) 542-5942 for details on copylefted material in general.

NO WARRANTY

BECAUSE SMAIL IS LICENSED FREE OF CHARGE, WE PROVIDE ABSOLUTELY NO WARRANTY, TO THE EXTENT PERMITTED BY APPLICABLE STATE LAW. EXCEPT WHEN OTHERWISE STATED IN WRITING, LANDON CURT NOLL & RONALD S. KARR AND/OR OTHER PARTIES PROVIDE SMAIL ""AS IS"" WITHOUT WARRANTY OF ANY KIND,

LICENCE TERMS (cont.)

EITHER EXPRESSED OR IMPLIED, INCLUDING, BUT NOT LIMITED TO, THE IMPLIED WARRANTIES OF MERCHANTABILITY AND FITNESS FOR A PARTICULAR PURPOSE. THE ENTIRE RISK AS TO THE QUALITY AND PERFORMANCE OF SMAIL IS WITH YOU. SHOULD SMAIL PROVE DEFECTIVE, YOU ASSUME THE COST OF ALL NECESSARY SERVICING, REPAIR OR CORRECTION.

IN NO EVENT UNLESS REQUIRED BY APPLICABLE LAW WILL LONDON CURT NOLL & RONALD S. KARR AND/OR ANY OTHER PARTY WHO MAY MODIFY AND REDISTRIBUTE SMAIL AS PERMITTED ABOVE, BE LIABLE TO YOU FOR DAMAGES, INCLUDING ANY LOST PROFITS, LOST MONIES, OR OTHER SPECIAL, INCIDENTAL OR CONSEQUENTIAL DAMAGES ARISING OUT OF THE USE OR INABILITY TO USE (INCLUDING BUT NOT LIMITED TO LOSS OF DATA OR DATA BEING RENDERED INACCURATE OR LOSSES SUSTAINED BY THIRD PARTIES OR A FAILURE OF THE PROGRAM TO OPERATE WITH ANY OTHER PROGRAMS) SMAIL, EVEN IF YOU HAVE BEEN ADVISED OF THE POSSIBILITY OF SUCH DAMAGES, OR FOR ANY CLAIM BY ANY OTHER PARTY.

Mozilla Public License Version 2.0

1. Definitions

1.1. "Contributor"

means each individual or legal entity that creates, contributes to the creation of, or owns Covered Software.

1.2. "Contributor Version"

means the combination of the Contributions of others (if any) used by a Contributor and that particular Contributor's Contribution.

1.3. "Contribution"

means Covered Software of a particular Contributor.

1.4. "Covered Software"

means Source Code Form to which the initial Contributor has attached the notice in Exhibit A, the Executable Form of such Source Code Form, and Modifications of such Source Code Form, in each case including portions thereof.

1.5. "Incompatible With Secondary Licenses"

means

(a) that the initial Contributor has attached the notice described in Exhibit B to the Covered Software; or

(b) that the Covered Software was made available under the terms of version 1.1 or earlier of the License, but not also under the terms of a Secondary License.

1.6. "Executable Form"

means any form of the work other than Source Code Form.

1.7. "Larger Work"

means a work that combines Covered Software with other material, in

a separate file or files, that is not Covered Software.

1.8. "License"

means this document.

1.9. "Licensable"

means having the right to grant, to the maximum extent possible, whether at the time of the initial grant or subsequently, any and all of the rights conveyed by this License.

1.10. "Modifications"

means any of the following:

(a) any file in Source Code Form that results from an addition to, deletion from, or modification of the contents of Covered Software; or

(b) any new file in Source Code Form that contains any Covered Software.

1.11. "Patent Claims" of a Contributor

means any patent claim(s), including without limitation, method, process, and apparatus claims, in any patent Licensable by such Contributor that would be infringed, but for the grant of the License, by the making, using, selling, offering for sale, having made, import, or transfer of either its Contributions or its Contributor Version.

1.12. "Secondary License"

means either the GNU General Public License, Version 2.0, the GNU Lesser General Public License, Version 2.1, the GNU Affero General Public License, Version 3.0, or any later versions of those licenses.

1.13. "Source Code Form"

means the form of the work preferred for making modifications.

1.14. "You" (or "Your")

means an individual or a legal entity exercising rights under this License. For legal entities, "You" includes any entity that controls, is controlled by, or is under common control with You. For purposes of this definition, "control" means (a) the power, direct or indirect, to cause the direction or management of such entity, whether by contract or otherwise, or (b) ownership of more than fifty percent (50%) of the outstanding shares or beneficial ownership of such entity.

2. License Grants and Conditions

2.1. Grants

Each Contributor hereby grants You a world-wide, royalty-free, non-exclusive license:

(a) under intellectual property rights (other than patent or trademark) Licensable by such Contributor to use, reproduce, make available,

LICENCE TERMS (cont.)

modify, display, perform, distribute, and otherwise exploit its Contributions, either on an unmodified basis, with Modifications, or as part of a Larger Work; and

(b) under Patent Claims of such Contributor to make, use, sell, offer for sale, have made, import, and otherwise transfer either its Contributions or its Contributor Version.

2.2. Effective Date

The licenses granted in Section 2.1 with respect to any Contribution become effective for each Contribution on the date the Contributor first distributes such Contribution.

2.3. Limitations on Grant Scope

The licenses granted in this Section 2 are the only rights granted under this License. No additional rights or licenses will be implied from the distribution or licensing of Covered Software under this License. Notwithstanding Section 2.1(b) above, no patent license is granted by a Contributor:

(a) for any code that a Contributor has removed from Covered Software; or

(b) for infringements caused by: (i) Your and any other third party's modifications of Covered Software, or (ii) the combination of its Contributions with other software (except as part of its Contributor Version); or

(c) under Patent Claims infringed by Covered Software in the absence of its Contributions.

This License does not grant any rights in the trademarks, service marks, or logos of any Contributor (except as may be necessary to comply with the notice requirements in Section 3.4).

2.4. Subsequent Licenses

No Contributor makes additional grants as a result of Your choice to distribute the Covered Software under a subsequent version of this License (see Section 10.2) or under the terms of a Secondary License (if permitted under the terms of Section 3.3).

2.5. Representation

Each Contributor represents that the Contributor believes its Contributions are its original creation(s) or it has sufficient rights to grant the rights to its Contributions conveyed by this License.

2.6. Fair Use

This License is not intended to limit any rights You have under applicable copyright doctrines of fair use, fair dealing, or other equivalents.

2.7. Conditions

Sections 3.1, 3.2, 3.3, and 3.4 are conditions of the licenses granted in Section 2.1.

3. Responsibilities

3.1. Distribution of Source Form

All distribution of Covered Software in Source Code Form, including any Modifications that You create or to which You contribute, must be under the terms of this License. You must inform recipients that the Source Code Form of the Covered Software is governed by the terms of this License, and how they can obtain a copy of this License. You may not attempt to alter or restrict the recipients' rights in the Source Code Form.

3.2. Distribution of Executable Form

If You distribute Covered Software in Executable Form then:

(a) such Covered Software must also be made available in Source Code Form, as described in Section 3.1, and You must inform recipients of the Executable Form how they can obtain a copy of such Source Code Form by reasonable means in a timely manner, at a charge no more than the cost of distribution to the recipient; and

(b) You may distribute such Executable Form under the terms of this License, or sublicense it under different terms, provided that the license for the Executable Form does not attempt to limit or alter the recipients' rights in the Source Code Form under this License.

3.3. Distribution of a Larger Work

You may create and distribute a Larger Work under terms of Your choice, provided that You also comply with the requirements of this License for the Covered Software. If the Larger Work is a combination of Covered Software with a work governed by one or more Secondary Licenses, and the Covered Software is not Incompatible With Secondary Licenses, this License permits You to additionally distribute such Covered Software under the terms of such Secondary License(s), so that the recipient of the Larger Work may, at their option, further distribute the Covered Software under the terms of either this License or such Secondary License(s).

3.4. Notices

You may not remove or alter the substance of any license notices (including copyright notices, patent notices, disclaimers of warranty, or limitations of liability) contained within the Source Code Form of the Covered Software, except that You may alter any license notices to the extent required to remedy known factual inaccuracies.

3.5. Application of Additional Terms

You may choose to offer, and to charge a fee for, warranty, support,

indemnity or liability obligations to one or more recipients of Covered Software. However, You may do so only on Your own behalf, and not on behalf of any Contributor. You must make it absolutely clear that any such warranty, support, indemnity, or liability obligation is offered by You alone, and You hereby agree to indemnify every Contributor for any liability incurred by such Contributor as a result of warranty, support, indemnity or liability terms You offer. You may include additional disclaimers of warranty and limitations of liability specific to any jurisdiction.

4. Inability to Comply Due to Statute or Regulation

If it is impossible for You to comply with any of the terms of this License with respect to some or all of the Covered Software due to statute, judicial order, or regulation then You must: (a) comply with the terms of this License to the maximum extent possible; and (b) describe the limitations and the code they affect. Such description must be placed in a text file included with all distributions of the Covered Software under this License. Except to the extent prohibited by statute or regulation, such description must be sufficiently detailed for a recipient of ordinary skill to be able to understand it.

5. Termination

5.1. The rights granted under this License will terminate automatically if You fail to comply with any of its terms. However, if You become compliant, then the rights granted under this License from a particular Contributor are reinstated (a) provisionally, unless and until such Contributor explicitly and finally terminates Your grants, and (b) on an ongoing basis, if such Contributor fails to notify You of the non-compliance by some reasonable means prior to 60 days after You have come back into compliance. Moreover, Your grants from a particular Contributor are reinstated on an ongoing basis if such Contributor notifies You of the non-compliance by some reasonable means, this is the first time You have received notice of non-compliance with this License from such Contributor, and You become compliant prior to 30 days after Your receipt of the notice.

5.2. If You initiate litigation against any entity by asserting a patent infringement claim (excluding declaratory judgment actions, counter-claims, and cross-claims) alleging that a Contributor Version directly or indirectly infringes any patent, then the rights granted to You by any and all Contributors for the Covered Software under Section 2.1 of this License shall terminate.

5.3. In the event of termination under Sections 5.1 or 5.2 above, all end user license agreements (excluding distributors and resellers) which have been validly granted by You or Your distributors under this License prior to termination shall survive termination.

6. Disclaimer of Warranty

* Covered Software is provided under this License on an "as is" *
* basis, without warranty of any kind, either expressed, implied, or *
* statutory, including, without limitation, warranties that the *
* Covered Software is free of defects, merchantable, fit for a *
* particular purpose or non-infringing. The entire risk as to the *
* quality and performance of the Covered Software is with You. *
* Should any Covered Software prove defective in any respect, You *
* (not any Contributor) assume the cost of any necessary servicing, *
* repair, or correction. This disclaimer of warranty constitutes an *
* essential part of this License. No use of any Covered Software is *
* authorized under this License except under this disclaimer. *

7. Limitation of Liability

* Under no circumstances and under no legal theory, whether tort *
* (including negligence), contract, or otherwise, shall any *
* Contributor, or anyone who distributes Covered Software as *
* permitted above, be liable to You for any direct, indirect, *
* special, incidental, or consequential damages of any character *
* including, without limitation, damages for lost profits, loss of *
* goodwill, work stoppage, computer failure or malfunction, or any *
* and all other commercial damages or losses, even if such party *
* shall have been informed of the possibility of such damages. This *
* limitation of liability shall not apply to liability for death or *
* personal injury resulting from such party's negligence to the *
* extent applicable law prohibits such limitation. Some *
* jurisdictions do not allow the exclusion or limitation of *
* incidental or consequential damages, so this exclusion and *
* limitation may not apply to You. *

8. Litigation

Any litigation relating to this License may be brought only in the courts of a jurisdiction where the defendant maintains its principal place of business and such litigation shall be governed by laws of that jurisdiction, without reference to its conflict-of-law provisions. Nothing in this Section shall prevent a party's ability to bring cross-claims or counter-claims.

9. Miscellaneous

This License represents the complete agreement concerning the subject matter hereof. If any provision of this License is held to be unenforceable, such provision shall be reformed only to the extent necessary to make it enforceable. Any law or regulation which provides that the language of a contract shall be construed against the drafter shall not be used to construe this License against a Contributor.

10. Versions of the License

10.1. New Versions

Mozilla Foundation is the license steward. Except as provided in Section 10.3, no one other than the license steward has the right to modify or publish new versions of this License. Each version will be given a distinguishing version number.

10.2. Effect of New Versions

You may distribute the Covered Software under the terms of the version of the License under which You originally received the Covered Software, or under the terms of any subsequent version published by the license steward.

10.3. Modified Versions

If you create software not governed by this License, and you want to create a new license for such software, you may create and use a modified version of this License if you rename the license and remove any references to the name of the license steward (except to note that such modified license differs from this License).

10.4. Distributing Source Code Form that is Incompatible With Secondary Licenses

If You choose to distribute Source Code Form that is Incompatible With Secondary Licenses under the terms of this version of the License, the notice described in Exhibit B of this License must be attached.

Exhibit A - Source Code Form License Notice

This Source Code Form is subject to the terms of the Mozilla Public License, v. 2.0. If a copy of the MPL was not distributed with this file, You can obtain one at <http://mozilla.org/MPL/2.0/>.

If it is not possible or desirable to put the notice in a particular file, then You may include the notice in a location (such as a LICENSE file in a relevant directory) where a recipient would be likely to look for such a notice.

You may add additional accurate notices of copyright ownership.

Exhibit B - "Incompatible With Secondary Licenses" Notice

This Source Code Form is "Incompatible With Secondary Licenses", as defined by the Mozilla Public License, v. 2.0.

The "Artistic License"

Preamble

The intent of this document is to state the conditions under which a Package may be copied, such that the Copyright Holder maintains some semblance of artistic control over the development of the package, while giving the users of the package the right to use and distribute the Package in a more-or-less customary fashion, plus the right to make reasonable modifications.

Definitions:

"Package" refers to the collection of files distributed by the Copyright Holder, and derivatives of that collection of files created through textual modification.

"Standard Version" refers to such a Package if it has not been modified, or has been modified in accordance with the wishes of the Copyright Holder as specified below.

"Copyright Holder" is whoever is named in the copyright or copyrights for the package.

"You" is you, if you're thinking about copying or distributing this Package.

"Reasonable copying fee" is whatever you can justify on the basis of media cost, duplication charges, time of people involved, and so on. (You will not be required to justify it to the Copyright Holder, but only to the computing community at large as a market that must bear the fee.)

"Freely Available" means that no fee is charged for the item itself, though there may be fees involved in handling the item. It also means that recipients of the item may redistribute it under the same conditions they received it.

1. You may make and give away verbatim copies of the source form of the Standard Version of this Package without restriction, provided that you duplicate all of the original copyright notices and associated disclaimers.
2. You may apply bug fixes, portability fixes and other modifications derived from the Public Domain or from the Copyright Holder. A Package modified in such a way shall still be considered the Standard Version.
3. You may otherwise modify your copy of this Package in any way, provided that you insert a prominent notice in each changed file stating how and when you changed that file, and provided that you do at least ONE of the following:
 - a) place your modifications in the Public Domain or otherwise make them Freely Available, such as by posting said modifications to Usenet or an equivalent medium, or placing the modifications on a major archive site such as uunet.uu.net, or by allowing the Copyright Holder to include your modifications in the Standard Version of the Package.
 - b) use the modified Package only within your corporation or organization.

LICENCE TERMS (cont.)

c) rename any non-standard executables so the names do not conflict with standard executables, which must also be provided, and provide a separate manual page for each non-standard executable that clearly documents how it differs from the Standard Version.

d) make other distribution arrangements with the Copyright Holder.

4. You may distribute the programs of this Package in object code or executable form, provided that you do at least ONE of the following:

a) distribute a Standard Version of the executables and library files, together with instructions (in the manual page or equivalent) on where to get the Standard Version.

b) accompany the distribution with the machine-readable source of the Package with your modifications.

c) give non-standard executables non-standard names, and clearly document the differences in manual pages (or equivalent), together with instructions on where to get the Standard Version.

d) make other distribution arrangements with the Copyright Holder.

5. You may charge a reasonable copying fee for any distribution of this Package. You may charge any fee you choose for support of this Package. You may not charge a fee for this Package itself. However, you may distribute this Package in aggregate with other (possibly commercial) programs as part of a larger (possibly commercial) software distribution provided that you do not advertise this Package as a product of your own. You may embed this Package's interpreter within an executable of yours (by linking); this shall be construed as a mere form of aggregation, provided that the complete Standard Version of the interpreter is so embedded.

6. The scripts and library files supplied as input to or produced as output from the programs of this Package do not automatically fall under the copyright of this Package, but belong to whoever generated them, and may be sold commercially, and may be aggregated with this Package. If such scripts or library files are aggregated with this Package via the so-called "undump" or "unexec" methods of producing a binary executable image, then distribution of such an image shall neither be construed as a distribution of this Package nor shall it fall under the restrictions of Paragraphs 3 and 4, provided that you do not represent such an executable image as a Standard Version of this Package.

7. C subroutines (or comparably compiled subroutines in other languages) supplied by you and linked into this Package in order to emulate subroutines and variables of the language defined by this Package shall not be considered part of this Package, but are the equivalent of input as in Paragraph 6, provided these subroutines do not change the language in any way that would cause it to fail the regression tests for the language.

8. Aggregation of this Package with a commercial distribution is always permitted provided that the use of this Package is embedded; that is, when no overt attempt is made to make this Package's interfaces visible

to the end user of the commercial distribution. Such use shall not be construed as a distribution of this Package.

9. The name of the Copyright Holder may not be used to endorse or promote products derived from this software without specific prior written permission.

10. THIS PACKAGE IS PROVIDED "AS IS" AND WITHOUT ANY EXPRESS OR IMPLIED WARRANTIES, INCLUDING, WITHOUT LIMITATION, THE IMPLIED WARRANTIES OF MERCHANTABILITY AND FITNESS FOR A PARTICULAR PURPOSE.

The End

"This program, "bzip2", the associated library "libbzip2", and all documentation, are copyright (C) 1996-2019 Julian R Seward. All rights reserved.

Redistribution and use in source and binary forms, with or without modification, are permitted provided that the following conditions are met:

1. Redistributions of source code must retain the above copyright notice, this list of conditions and the following disclaimer.
2. The origin of this software must not be misrepresented; you must not claim that you wrote the original software. If you use this software in a product, an acknowledgment in the product documentation would be appreciated but is not required.
3. Altered source versions must be plainly marked as such, and must not be misrepresented as being the original software.
4. The name of the author may not be used to endorse or promote products derived from this software without specific prior written permission.

THIS SOFTWARE IS PROVIDED BY THE AUTHOR "AS IS" AND ANY EXPRESS OR IMPLIED WARRANTIES, INCLUDING, BUT NOT LIMITED TO, THE IMPLIED WARRANTIES OF MERCHANTABILITY AND FITNESS FOR A PARTICULAR PURPOSE ARE DISCLAIMED. IN NO EVENT SHALL THE AUTHOR BE LIABLE FOR ANY DIRECT, INDIRECT, INCIDENTAL, SPECIAL, EXEMPLARY, OR CONSEQUENTIAL DAMAGES (INCLUDING, BUT NOT LIMITED TO, PROCUREMENT OF SUBSTITUTE GOODS OR SERVICES; LOSS OF USE, DATA, OR PROFITS; OR BUSINESS INTERRUPTION) HOWEVER CAUSED AND ON ANY THEORY OF LIABILITY, WHETHER IN CONTRACT, STRICT LIABILITY, OR TORT (INCLUDING NEGLIGENCE OR OTHERWISE) ARISING IN ANY WAY OUT OF THE USE OF THIS SOFTWARE, EVEN IF ADVISED OF THE POSSIBILITY OF SUCH DAMAGE."

Copyright Notice

jpg "Clone me," says Dolly sheepishly.

Last update: 2-Jan-2017 11:58 UTC

LICENCE TERMS (cont.)

The following copyright notice applies to all files collectively called the Network Time Protocol Version 4 Distribution. Unless specifically declared otherwise in an individual file, this entire notice applies as if the text was explicitly included in the file.

* Copyright (c) University of Delaware 1992-2015 *

* Permission to use, copy, modify, and distribute this software and *
* its documentation for any purpose with or without fee is hereby *
* granted, provided that the above copyright notice appears in all *
* copies and that both the copyright notice and this permission *
* notice appear in supporting documentation, and that the name *
* University of Delaware not be used in advertising or publicity *
* pertaining to distribution of the software without specific, *
* written prior permission. The University of Delaware makes no *
* representations about the suitability this software for any *
* purpose. It is provided ""as is"" without express or implied *
* warranty. *

Content starting in 2011 from Harlan Stenn, Danny Mayer, and Martin Burnicki is:

* Copyright (c) Network Time Foundation 2011-2017 *

* All Rights Reserved *

* Redistribution and use in source and binary forms, with or without *
* modification, are permitted provided that the following conditions *
* are met: *

1. Redistributions of source code must retain the above copyright *
* notice, this list of conditions and the following disclaimer. *
2. Redistributions in binary form must reproduce the above *
* copyright notice, this list of conditions and the following *
* disclaimer in the documentation and/or other materials provided *
* with the distribution. *

* THIS SOFTWARE IS PROVIDED BY THE AUTHORS ``AS IS'' AND ANY EXPRESS *
* OR IMPLIED WARRANTIES, INCLUDING, BUT NOT LIMITED TO, THE IMPLIED *
* WARRANTIES OF MERCHANTABILITY AND FITNESS FOR A PARTICULAR PURPOSE *
* ARE DISCLAIMED. IN NO EVENT SHALL THE AUTHORS OR CONTRIBUTORS BE *
* LIABLE FOR ANY DIRECT, INDIRECT, INCIDENTAL, SPECIAL, EXEMPLARY, OR *
* CONSEQUENTIAL DAMAGES (INCLUDING, BUT NOT LIMITED TO, PROCUREMENT *
* OF SUBSTITUTE GOODS OR SERVICES; LOSS OF USE, DATA, OR PROFITS; OR *
* BUSINESS INTERRUPTION) HOWEVER CAUSED AND ON ANY THEORY OF *
* LIABILITY, WHETHER IN CONTRACT, STRICT LIABILITY, OR TORT *
* (INCLUDING NEGLIGENCE OR OTHERWISE) ARISING IN ANY WAY OUT OF THE *
* USE OF THIS SOFTWARE, EVEN IF ADVISED OF THE POSSIBILITY OF SUCH *
* DAMAGE. *

The following individuals contributed in part to the Network Time

Protocol Distribution Version 4 and are acknowledged as authors of this work.

1. [1]Takao Abe <takao_abe@xurb.jp> Clock driver for JJY receivers
2. [2]Mark Andrews <mark_andrews@isc.org> Leitch atomic clock controller
3. [3]Bernd Altmeier <altmeier@atsoft.de> hopf Elektronik serial line and PCI-bus devices
4. [4]Viraj Bais <vbais@mailman1.intel.com> and [5]Clayton Kirkwood <kirkwood@striderfm.intel.com> port to WindowsNT 3.5
5. [6]Michael Barone <michael.barone@lmco.com> GPSVME fixes
6. [7]Karl Berry <karl@owl.HQ.ileaf.com> syslog to file option
7. [8]Greg Brackley <greg.brackley@bigfoot.com> Major rework of WINNT port. Clean up recvbuf and iosignal code into separate modules.
8. [9]Marc Brett <Marc.Brett@westgeo.com> Magnavox GPS clock driver
9. [10]Piete Brooks <Piete.Brooks@cl.cam.ac.uk> MSF clock driver, Trimble PARSE support
10. [11]Nelson B Bolyard <nelson@bolyard.me> update and complete broadcast and crypto features in sntp
11. [12]Jean-Francois Boudreault <Jean-Francois.Boudreault@viagenie.qc.ca> IPv6 support
12. [13]Reg Clemens <reg@dwf.com> Oncore driver (Current maintainer)
13. [14]Steve Clift <clift@ml.csiro.au> OMEGA clock driver
14. [15]Casey Crellin <casey@csc.co.za> vxWorks (Tornado) port and help with target configuration
15. [16]Sven Dietrich <sven_dietrich@trimble.com> Palisade reference clock driver, NT adj. residuals, integrated Greg's Winnt port.
16. [17]John A. Dundas III <dundas@salt.jpl.nasa.gov> Apple A/UX port
17. [18]Torsten Duwe <duwe@immd4.informatik.uni-erlangen.de> Linux port
18. [19]Dennis Ferguson <dennis@mrbill.canet.ca> foundation code for NTP Version 2 as specified in RFC-1119
19. [20]John Hay <jhay@icomtek.csiro.co.za> IPv6 support and testing
20. [21]Dave Hart <davehart@davehart.com> General maintenance, Windows port interpolation rewrite
21. [22]Claas Hilbrecht <neoclock4x@linum.com> NeoClock4X clock driver
22. [23]Glenn Hollinger <glenn@herald.usask.ca> GOES clock driver
23. [24]Mike Iglesias <iglesias@uci.edu> DEC Alpha port
24. [25]Jim Jagielski <jim@jagubox.gsfc.nasa.gov> A/UX port
25. [26]Jeff Johnson <jbj@chatham.usdesign.com> massive prototyping overhaul
26. [27]Hans Lambermont <Hans.Lambermont@nl.origin-it.com> or [28]<H.Lambermont@chello.nl> ntpswEEP
27. [29]Poul-Henning Kamp <phk@FreeBSD.ORG> Oncore driver (Original author)
28. [30]Frank Kardel [31]<kardel(at)ntp(dot)org> PARSE <GENERIC> (driver 14 reference clocks), STREAMS modules for PARSE, support scripts, syslog cleanup, dynamic interface handling
29. [32]Johannes Maximilian Kuehn <kuehn@ntp.org> Rewrote sntp to comply with NTPv4 specification, ntpq saveconfig
30. [33]William L. Jones <jones@hermes.chpc.utexas.edu> RS/6000 AIX modifications, HPUX modifications
31. [34]Dave Katz <dkatz@cisco.com> RS/6000 AIX port
32. [35]Craig Leres <leres@ee.lbl.gov> 4.BSD port, ppsclock, Magnavox GPS clock driver
33. [36]George Lindholm <lindholm@ucs.ubc.ca> SunOS 5.1 port
34. [37]Louis A. Mamakos <louie@ni.umd.edu> MD5-based authentication
35. [38]Lars H. Mathiesen <thorinn@diku.dk> adaptation of foundation code for Version 3 as specified in RFC-1305

LICENCE TERMS (cont.)

36. [39]Danny Mayer <mayer@ntp.org> Network I/O, Windows Port, Code Maintenance
37. [40]David L. Mills <mills@udel.edu> Version 4 foundation, precision kernel; clock drivers: 1, 3, 4, 6, 7, 11, 13, 18, 19, 22, 36
38. [41]Wolfgang Moeller <moeller@gwdgv1.dnet.gwdg.de> VMS port
39. [42]Jeffrey Mogul <mogul@pa.dec.com> ntptrace utility
40. [43]Tom Moore <tmoore@fielvel.daytonoh.ncr.com> i386 svr4 port
41. [44]Kamal A Mostafa <kamal@whence.com> SCO OpenServer port
42. [45]Derek Mulcahy <derek@toybox.demon.co.uk> and [46]Damon Hart-Davis <d@hd.org> ARCRON MSF clock driver
43. [47]Rob Neal <neal@ntp.org> Bancomm refclock and config/parse code maintenance
44. [48]Rainer Pruy <Rainer.Pruy@informatik.uni-erlangen.de> monitoring/trap scripts, statistics file handling
45. [49]Dirce Richards <dirce@zk3.dec.com> Digital UNIX V4.0 port
46. [50]Wilfredo Sanchez <wsanchez@apple.com> added support for NetInfo
47. [51]Nick Sayer <mrapple@quack.kfu.com> SunOS streams modules
48. [52]Jack Sasportas <jack@innovativeinternet.com> Saved a Lot of space on the stuff in the html/pic/ subdirectory
49. [53]Ray Schnitzler <schnitz@unipress.com> Unixware1 port
50. [54]Michael Shields <shields@tembel.org> USNO clock driver
51. [55]Jeff Steinman <jss@pebbles.jpl.nasa.gov> Datum PTS clock driver
52. [56]Harlan Stenn <harlan@pfcs.com> GNU automake/autoconfigure makeover, various other bits (see the ChangeLog)
53. [57]Kenneth Stone <ken@sdd.hp.com> HP-UX port
54. [58]Ajit Thyagarajan <ajit@ee.udel.edu> IP multicast/anycast support
55. [59]Tomoaki TSURUOKA <tsuruoka@nc.fukuoka-u.ac.jp> TRAK clock driver
56. [60]Brian Utterback <brian.utterback@oracle.com> General codebase, Solaris issues
57. [61]Loganaden Velvindron <loganaden@gmail.com> Sandboxing (libseccomp) support
58. [62]Paul A Vixie <vixie@vix.com> TrueTime GPS driver, generic TrueTime clock driver
59. [63]Ulrich Windl <Ulrich.Windl@rz.uni-regensburg.de> corrected and validated HTML documents according to the HTML DTD

References

1. mailto:%20takao_abe@xurb.jp
2. mailto:%20mark_andrews@isc.org
3. mailto:%20altmeier@atsoft.de
4. mailto:%20vbais@mailman1.intel.co
5. mailto:%20kirkwood@striderfm.intel.com
6. mailto:%20michael.barone@lmco.com
7. mailto:%20karl@owl.HQ.ileaf.com
8. mailto:%20greg.brackley@bigfoot.com
9. mailto:%20Marc.Brett@westgeo.com
10. mailto:%20Piete.Brooks@cl.cam.ac.uk
11. mailto:%20nelson@bolyard.me
12. mailto:%20Jean-Francois.Boudreault@viagenie.qc.ca
13. mailto:%20reg@dwf.com
14. mailto:%20clift@ml.csiro.au
15. mailto:%20casey@csc.co.za
16. mailto:%20Sven_Dietrich@trimble.COM
17. mailto:%20dundas@salt.jpl.nasa.gov
18. mailto:%20duwe@immd4.informatik.uni-erlangen.de

19. mailto:%20dennis@mrbill.canet.ca
20. mailto:%20jhay@icomtek.csir.co.za
21. mailto:%20davehart@davehart.com
22. mailto:%20neoclock4x@linum.com
23. mailto:%20glenn@herald.usask.ca
24. mailto:%20iglesias@uci.edu
25. mailto:%20jagubox.gsfc.nasa.gov
26. mailto:%20jbj@chatham.usdesign.com
27. mailto:%20Hans.Lambermont@nl.origin-it.com
28. mailto:H.Lambermont@chello.nl
29. mailto:%20phk@FreeBSD.ORG
30. http://www4.informatik.uni-erlangen.de/%7ekardel
31. mailto:%20kardel%20%28at%29%20ntp%20%28dot%29%20org
32. mailto:kuehn@ntp.org
33. mailto:%20jones@hermes.chpc.utexas.edu
34. mailto:%20dkatz@cisco.com
35. mailto:%20leres@ee.lbl.gov
36. mailto:%20lindholm@ucs.ubc.ca
37. mailto:%20louie@ni.umd.edu
38. mailto:%20thorinn@diku.dk
39. mailto:%20mayer@ntp.org
40. mailto:%20mills@udel.edu
41. mailto:%20moeller@gwdgv1.dnet.gwdg.de
42. mailto:%20mogul@pa.dec.com
43. mailto:%20tmoore@fielvel.daytonoh.ncr.com
44. mailto:%20kamal@whence.com
45. mailto:%20derek@toybox.demon.co.uk
46. mailto:%20d@hd.org
47. mailto:%20neal@ntp.org
48. mailto:%20Rainer.Pruy@informatik.uni-erlangen.de
49. mailto:%20dirce@zk3.dec.com
50. mailto:%20wsanchez@apple.com
51. mailto:%20mrapple@quack.kfu.com
52. mailto:%20jack@innovativeinternet.com
53. mailto:%20schnitz@unipress.com
54. mailto:%20shields@tembel.org
55. mailto:%20pebbles.jpl.nasa.gov
56. mailto:%20harlan@pfcs.com
57. mailto:%20ken@sdd.hp.com
58. mailto:%20ajit@ee.udel.edu
59. mailto:%20tsuruoka@nc.fukuoka-u.ac.jp
60. mailto:%20brian.utterback@oracle.com
61. mailto:%20loganaden@gmail.com
62. mailto:%20vixie@vix.com
63. mailto:%20Ulrich.Windl@rz.uni-regensburg.de"

LICENSE ISSUES

The OpenSSL toolkit stays under a double license, i.e. both the conditions of the OpenSSL License and the original SSLLeay license apply to the toolkit. See below for the actual license texts.

OpenSSL License

LICENCE TERMS (cont.)

=====
Copyright (c) 1998-2019 The OpenSSL Project. All rights reserved.

Redistribution and use in source and binary forms, with or without modification, are permitted provided that the following conditions are met:

1. Redistributions of source code must retain the above copyright notice, this list of conditions and the following disclaimer.
2. Redistributions in binary form must reproduce the above copyright notice, this list of conditions and the following disclaimer in the documentation and/or other materials provided with the distribution.
3. All advertising materials mentioning features or use of this software must display the following acknowledgment:
"This product includes software developed by the OpenSSL Project for use in the OpenSSL Toolkit. (<http://www.openssl.org/>)"
4. The names "OpenSSL Toolkit" and "OpenSSL Project" must not be used to endorse or promote products derived from this software without prior written permission. For written permission, please contact openssl-core@openssl.org.
5. Products derived from this software may not be called "OpenSSL" nor may "OpenSSL" appear in their names without prior written permission of the OpenSSL Project.
6. Redistributions of any form whatsoever must retain the following acknowledgment:
"This product includes software developed by the OpenSSL Project for use in the OpenSSL Toolkit (<http://www.openssl.org/>)"

THIS SOFTWARE IS PROVIDED BY THE OpenSSL PROJECT ``AS IS'' AND ANY EXPRESSED OR IMPLIED WARRANTIES, INCLUDING, BUT NOT LIMITED TO, THE IMPLIED WARRANTIES OF MERCHANTABILITY AND FITNESS FOR A PARTICULAR PURPOSE ARE DISCLAIMED. IN NO EVENT SHALL THE OpenSSL PROJECT OR ITS CONTRIBUTORS BE LIABLE FOR ANY DIRECT, INDIRECT, INCIDENTAL, SPECIAL, EXEMPLARY, OR CONSEQUENTIAL DAMAGES (INCLUDING, BUT NOT LIMITED TO, PROCUREMENT OF SUBSTITUTE GOODS OR SERVICES; LOSS OF USE, DATA, OR PROFITS; OR BUSINESS INTERRUPTION) HOWEVER CAUSED AND ON ANY THEORY OF LIABILITY, WHETHER IN CONTRACT, STRICT LIABILITY, OR TORT (INCLUDING NEGLIGENCE OR OTHERWISE) ARISING IN ANY WAY OUT OF THE USE OF THIS SOFTWARE, EVEN IF ADVISED OF THE POSSIBILITY OF SUCH DAMAGE.

=====

This product includes cryptographic software written by Eric Young (eay@cryptsoft.com). This product includes software written by Tim Hudson (tjh@cryptsoft.com).

Original SSLeay License

Copyright (C) 1995-1998 Eric Young (eay@cryptsoft.com)
All rights reserved.

This package is an SSL implementation written by Eric Young (eay@cryptsoft.com). The implementation was written so as to conform with Netscapes SSL.

This library is free for commercial and non-commercial use as long as the following conditions are aheared to. The following conditions apply to all code found in this distribution, be it the RC4, RSA, lhash, DES, etc., code; not just the SSL code. The SSL documentation included with this distribution is covered by the same copyright terms except that the holder is Tim Hudson (tjh@cryptsoft.com).

Copyright remains Eric Young's, and as such any Copyright notices in the code are not to be removed. If this package is used in a product, Eric Young should be given attribution as the author of the parts of the library used. This can be in the form of a textual message at program startup or in documentation (online or textual) provided with the package.

Redistribution and use in source and binary forms, with or without modification, are permitted provided that the following conditions are met:

1. Redistributions of source code must retain the copyright notice, this list of conditions and the following disclaimer.
2. Redistributions in binary form must reproduce the above copyright notice, this list of conditions and the following disclaimer in the documentation and/or other materials provided with the distribution.
3. All advertising materials mentioning features or use of this software must display the following acknowledgement:
"This product includes cryptographic software written by Eric Young (eay@cryptsoft.com)"
The word 'cryptographic' can be left out if the rouines from the library being used are not cryptographic related :-).
4. If you include any Windows specific code (or a derivative thereof) from the apps directory (application code) you must include an acknowledgement:
"This product includes software written by Tim Hudson (tjh@cryptsoft.com)"

THIS SOFTWARE IS PROVIDED BY ERIC YOUNG ``AS IS'' AND ANY EXPRESS OR IMPLIED WARRANTIES, INCLUDING, BUT NOT LIMITED TO, THE IMPLIED WARRANTIES OF MERCHANTABILITY AND FITNESS FOR A PARTICULAR PURPOSE ARE DISCLAIMED. IN NO EVENT SHALL THE AUTHOR OR CONTRIBUTORS BE LIABLE FOR ANY DIRECT, INDIRECT, INCIDENTAL, SPECIAL, EXEMPLARY, OR CONSEQUENTIAL DAMAGES (INCLUDING, BUT NOT LIMITED TO, PROCUREMENT OF SUBSTITUTE GOODS OR SERVICES; LOSS OF USE, DATA, OR PROFITS; OR BUSINESS INTERRUPTION) HOWEVER CAUSED AND ON ANY THEORY OF LIABILITY, WHETHER IN CONTRACT, STRICT LIABILITY, OR TORT (INCLUDING NEGLIGENCE OR OTHERWISE) ARISING IN ANY WAY OUT OF THE USE OF THIS SOFTWARE, EVEN IF ADVISED OF THE POSSIBILITY OF SUCH DAMAGE.

The licence and distribution terms for any publically available version or derivative of this code cannot be changed. i.e. this code cannot simply be copied and put under another distribution licence [including the GNU Public Licence.]

The PHP License, version 3.01

Copyright (c) 1999 - 2021 The PHP Group. All rights reserved.

Redistribution and use in source and binary forms, with or without modification, is permitted provided that the following conditions are met:

1. Redistributions of source code must retain the above copyright notice, this list of conditions and the following disclaimer.
2. Redistributions in binary form must reproduce the above copyright notice, this list of conditions and the following disclaimer in the documentation and/or other materials provided with the distribution.
3. The name "PHP" must not be used to endorse or promote products derived from this software without prior written permission. For written permission, please contact group@php.net.
4. Products derived from this software may not be called "PHP", nor may "PHP" appear in their name, without prior written permission from group@php.net. You may indicate that your software works in conjunction with PHP by saying "Foo for PHP" instead of calling it "PHP Foo" or "phpfoo".
5. The PHP Group may publish revised and/or new versions of the license from time to time. Each version will be given a distinguishing version number.
Once covered code has been published under a particular version of the license, you may always continue to use it under the terms of that version. You may also choose to use such covered code under the terms of any subsequent version of the license published by the PHP Group. No one other than the PHP Group has the right to modify the terms applicable to covered code created under this License.
6. Redistributions of any form whatsoever must retain the following acknowledgment:
"This product includes PHP software, freely available from <http://www.php.net/software/>".

THIS SOFTWARE IS PROVIDED BY THE PHP DEVELOPMENT TEAM "AS IS" AND ANY EXPRESSED OR IMPLIED WARRANTIES, INCLUDING, BUT NOT LIMITED TO, THE IMPLIED WARRANTIES OF MERCHANTABILITY AND FITNESS FOR A PARTICULAR PURPOSE ARE DISCLAIMED. IN NO EVENT SHALL THE PHP DEVELOPMENT TEAM OR ITS CONTRIBUTORS BE LIABLE FOR ANY DIRECT, INDIRECT, INCIDENTAL, SPECIAL, EXEMPLARY, OR CONSEQUENTIAL DAMAGES (INCLUDING, BUT NOT LIMITED TO, PROCUREMENT OF SUBSTITUTE GOODS OR SERVICES; LOSS OF USE, DATA, OR PROFITS; OR BUSINESS INTERRUPTION) HOWEVER CAUSED AND ON ANY THEORY OF LIABILITY, WHETHER IN CONTRACT, STRICT LIABILITY, OR TORT (INCLUDING NEGLIGENCE OR OTHERWISE) ARISING IN ANY WAY OUT OF THE USE OF THIS SOFTWARE, EVEN IF ADVISED OF THE POSSIBILITY OF SUCH DAMAGE.

This software consists of voluntary contributions made by many individuals on behalf of the PHP Group.

The PHP Group can be contacted via Email at group@php.net.

For more information on the PHP Group and the PHP project, please see <http://www.php.net>.

PHP includes the Zend Engine, freely available at <http://www.zend.com>.

This software is provided 'as-is', without any express or implied warranty. In no event will the authors be held liable for any damages arising from the use of this software.

Permission is granted to anyone to use this software for any purpose, including commercial applications, and to alter it and redistribute it freely, subject to the following restrictions:

1. The origin of this software must not be misrepresented; you must not claim that you wrote the original software. If you use this software in a product, an acknowledgment in the product documentation would be appreciated but is not required.
2. Altered source versions must be plainly marked as such, and must not be misrepresented as being the original software.
3. This notice may not be removed or altered from any source distribution.

Jean-loup Gailly Mark Adler
jloup@gzip.org madler@alumni.caltech.edu

Files from Sun fdlibm are copyright Sun Microsystems, Inc.:

Copyright (C) 1993 by Sun Microsystems, Inc. All rights reserved.

Developed at SunPro, a Sun Microsystems, Inc. business.
Permission to use, copy, modify, and distribute this software is freely granted, provided that this notice is preserved.

The DNS resolver code, taken from BIND 4.9.5, is copyrighted by UC Berkeley, by Digital Equipment Corporation and by Internet Software Consortium. The DEC portions are under the following license:

Portions Copyright (C) 1993 by Digital Equipment Corporation.

Permission to use, copy, modify, and distribute this software for any purpose with or without fee is hereby granted, provided that the above copyright notice and this permission notice appear in all copies, and that the name of Digital Equipment Corporation not be used in

LICENCE TERMS (cont.)

advertising or publicity pertaining to distribution of the document or software without specific, written prior permission.

THE SOFTWARE IS PROVIDED ``AS IS'' AND DIGITAL EQUIPMENT CORP. DISCLAIMS ALL WARRANTIES WITH REGARD TO THIS SOFTWARE, INCLUDING ALL IMPLIED WARRANTIES OF MERCHANTABILITY AND FITNESS. IN NO EVENT SHALL DIGITAL EQUIPMENT CORPORATION BE LIABLE FOR ANY SPECIAL, DIRECT, INDIRECT, OR CONSEQUENTIAL DAMAGES OR ANY DAMAGES WHATSOEVER RESULTING FROM LOSS OF USE, DATA OR PROFITS, WHETHER IN AN ACTION OF CONTRACT, NEGLIGENCE OR OTHER TORTIOUS ACTION, ARISING OUT OF OR IN CONNECTION WITH THE USE OR PERFORMANCE OF THIS SOFTWARE.

The ISC portions are under the following license:

Portions Copyright (c) 1996-1999 by Internet Software Consortium.

Permission to use, copy, modify, and distribute this software for any purpose with or without fee is hereby granted, provided that the above copyright notice and this permission notice appear in all copies.

THE SOFTWARE IS PROVIDED ""AS IS"" AND INTERNET SOFTWARE CONSORTIUM DISCLAIMS ALL WARRANTIES WITH REGARD TO THIS SOFTWARE INCLUDING ALL IMPLIED WARRANTIES OF MERCHANTABILITY AND FITNESS. IN NO EVENT SHALL INTERNET SOFTWARE CONSORTIUM BE LIABLE FOR ANY SPECIAL, DIRECT, INDIRECT, OR CONSEQUENTIAL DAMAGES OR ANY DAMAGES WHATSOEVER RESULTING FROM LOSS OF USE, DATA OR PROFITS, WHETHER IN AN ACTION OF CONTRACT, NEGLIGENCE OR OTHER TORTIOUS ACTION, ARISING OUT OF OR IN CONNECTION WITH THE USE OR PERFORMANCE OF THIS SOFTWARE.

The file posix/runtests.c is copyright Tom Lord:

Copyright 1995 by Tom Lord

All Rights Reserved

Permission to use, copy, modify, and distribute this software and its documentation for any purpose and without fee is hereby granted, provided that the above copyright notice appear in all copies and that both that copyright notice and this permission notice appear in supporting documentation, and that the name of the copyright holder not be used in advertising or publicity pertaining to distribution of the software without specific, written prior permission.

Tom Lord DISCLAIMS ALL WARRANTIES WITH REGARD TO THIS SOFTWARE, INCLUDING ALL IMPLIED WARRANTIES OF MERCHANTABILITY AND FITNESS, IN NO EVENT SHALL TOM LORD BE LIABLE FOR ANY SPECIAL, INDIRECT OR CONSEQUENTIAL DAMAGES OR ANY DAMAGES WHATSOEVER RESULTING FROM LOSS OF USE, DATA OR PROFITS, WHETHER IN AN ACTION OF CONTRACT, NEGLIGENCE OR OTHER TORTIOUS ACTION, ARISING OUT OF OR IN CONNECTION WITH THE USE OR PERFORMANCE OF THIS SOFTWARE.

Internet Software Consortium.
Todd C. Miller
Reyk Floeter
Chad Mynhier

Permission to use, copy, modify, and distribute this software for any purpose with or without fee is hereby granted, provided that the above copyright notice and this permission notice appear in all copies.

THE SOFTWARE IS PROVIDED ""AS IS"" AND TODD C. MILLER DISCLAIMS ALL WARRANTIES WITH REGARD TO THIS SOFTWARE INCLUDING ALL IMPLIED WARRANTIES OF MERCHANTABILITY AND FITNESS. IN NO EVENT SHALL TODD C. MILLER BE LIABLE FOR ANY SPECIAL, DIRECT, INDIRECT, OR CONSEQUENTIAL DAMAGES OR ANY DAMAGES WHATSOEVER RESULTING FROM LOSS OF USE, DATA OR PROFITS, WHETHER IN AN ACTION OF CONTRACT, NEGLIGENCE OR OTHER TORTIOUS ACTION, ARISING OUT OF OR IN CONNECTION WITH THE USE OR PERFORMANCE OF THIS SOFTWARE.]

Copyright (c) 2008, Luis R. Rodriguez <mcgrof@gmail.com>
Copyright (c) 2008, Johannes Berg <johannes@sipsolutions.net>
Copyright (c) 2008, Michael Green <Michael.Green@Atheros.com>

Permission to use, copy, modify, and/or distribute this software for any purpose with or without fee is hereby granted, provided that the above copyright notice and this permission notice appear in all copies.

THE SOFTWARE IS PROVIDED ""AS IS"" AND THE AUTHOR DISCLAIMS ALL WARRANTIES WITH REGARD TO THIS SOFTWARE INCLUDING ALL IMPLIED WARRANTIES OF MERCHANTABILITY AND FITNESS. IN NO EVENT SHALL THE AUTHOR BE LIABLE FOR ANY SPECIAL, DIRECT, INDIRECT, OR CONSEQUENTIAL DAMAGES OR ANY DAMAGES WHATSOEVER RESULTING FROM LOSS OF USE, DATA OR PROFITS, WHETHER IN AN ACTION OF CONTRACT, NEGLIGENCE OR OTHER TORTIOUS ACTION, ARISING OUT OF OR IN CONNECTION WITH THE USE OR PERFORMANCE OF THIS SOFTWARE.

Copyright OpenJS Foundation and other contributors, <https://openjsf.org/>

Permission is hereby granted, free of charge, to any person obtaining a copy of this software and associated documentation files (the "Software"), to deal in the Software without restriction, including without limitation the rights to use, copy, modify, merge, publish, distribute, sublicense, and/or sell copies of the Software, and to permit persons to whom the Software is furnished to do so, subject to the following conditions:

The above copyright notice and this permission notice shall be included in all copies or substantial portions of the Software.

THE SOFTWARE IS PROVIDED "AS IS", WITHOUT WARRANTY OF ANY KIND, EXPRESS OR IMPLIED, INCLUDING BUT NOT LIMITED TO THE WARRANTIES OF MERCHANTABILITY, FITNESS FOR A PARTICULAR PURPOSE AND NONINFRINGEMENT. IN NO EVENT SHALL THE AUTHORS OR COPYRIGHT HOLDERS BE LIABLE FOR ANY CLAIM, DAMAGES OR OTHER LIABILITY, WHETHER IN AN ACTION OF CONTRACT, TORT OR OTHERWISE, ARISING FROM, OUT OF OR IN CONNECTION WITH THE SOFTWARE OR THE USE OR OTHER DEALINGS IN THE SOFTWARE.

Copyright (c) 2014-2021 Chart.js Contributors
Copyright (c) 2016-2021 chartjs-plugin-annotation Contributors
Copyright (c) 2013-2021 chartjs-plugin-zoom contributors
Copyright (C) 2011-2014 by Jorik Tangelder (Eight Media)

Permission is hereby granted, free of charge, to any person obtaining a copy of this software and associated documentation files (the "Software"), to deal in the Software without restriction, including without limitation the rights to use, copy, modify, merge, publish, distribute, sublicense, and/or sell copies of the Software, and to permit persons to whom the Software is furnished to do so, subject to the following conditions:

The above copyright notice and this permission notice shall be included in all copies or substantial portions of the Software.

THE SOFTWARE IS PROVIDED "AS IS", WITHOUT WARRANTY OF ANY KIND, EXPRESS OR IMPLIED, INCLUDING BUT NOT LIMITED TO THE WARRANTIES OF MERCHANTABILITY, FITNESS FOR A PARTICULAR PURPOSE AND NONINFRINGEMENT. IN NO EVENT SHALL THE AUTHORS OR COPYRIGHT HOLDERS BE LIABLE FOR ANY CLAIM, DAMAGES OR OTHER LIABILITY, WHETHER IN AN ACTION OF CONTRACT, TORT OR OTHERWISE, ARISING FROM, OUT OF OR IN CONNECTION WITH THE SOFTWARE OR THE USE OR OTHER DEALINGS IN THE SOFTWARE.

Copyright (c) 1993, 1994, 1995, 1996, 1997

The Regents of the University of California. All rights reserved.

Redistribution and use in source and binary forms, with or without modification, are permitted provided that the following conditions are met:

1. Redistributions of source code must retain the above copyright notice, this list of conditions and the following disclaimer.
2. Redistributions in binary form must reproduce the above copyright notice, this list of conditions and the following disclaimer in the documentation and/or other materials provided with the distribution.
3. All advertising materials mentioning features or use of this software must display the following acknowledgement:
This product includes software developed by the Computer Systems Engineering Group at Lawrence Berkeley Laboratory.
4. Neither the name of the University nor of the Laboratory may be used to endorse or promote products derived from this software without specific prior written permission.

THIS SOFTWARE IS PROVIDED BY THE REGENTS AND CONTRIBUTORS "AS IS" AND ANY EXPRESS OR IMPLIED WARRANTIES, INCLUDING, BUT NOT LIMITED TO, THE IMPLIED WARRANTIES OF MERCHANTABILITY AND FITNESS FOR A PARTICULAR PURPOSE ARE DISCLAIMED. IN NO EVENT SHALL THE REGENTS OR CONTRIBUTORS BE LIABLE FOR ANY DIRECT, INDIRECT, INCIDENTAL, SPECIAL, EXEMPLARY, OR CONSEQUENTIAL DAMAGES (INCLUDING, BUT NOT LIMITED TO, PROCUREMENT OF SUBSTITUTE GOODS OR SERVICES; LOSS OF USE, DATA, OR PROFITS; OR BUSINESS INTERRUPTION) HOWEVER CAUSED AND ON ANY THEORY OF LIABILITY, WHETHER IN CONTRACT, STRICT LIABILITY, OR TORT (INCLUDING NEGLIGENCE OR OTHERWISE) ARISING IN ANY WAY OUT OF THE USE OF THIS SOFTWARE, EVEN IF ADVISED OF THE POSSIBILITY OF SUCH DAMAGE.

Copyright (c) 1989 The Regents of the University of California.
All rights reserved.

Redistribution and use in source and binary forms, with or without modification, are permitted provided that the following conditions are met:

1. Redistributions of source code must retain the above copyright notice, this list of conditions and the following disclaimer.
2. Redistributions in binary form must reproduce the above copyright notice, this list of conditions and the following disclaimer in the documentation and/or other materials provided with the distribution.
3. All advertising materials mentioning features or use of this software must display the following acknowledgement:
This product includes software developed by the University of California, Berkeley and its contributors.
4. Neither the name of the University nor the names of its contributors may be used to endorse or promote products derived from this software without specific prior written permission.

THIS SOFTWARE IS PROVIDED BY THE REGENTS AND CONTRIBUTORS "AS IS" AND ANY EXPRESS OR IMPLIED WARRANTIES, INCLUDING, BUT NOT LIMITED TO, THE IMPLIED WARRANTIES OF MERCHANTABILITY AND FITNESS FOR A PARTICULAR PURPOSE ARE DISCLAIMED. IN NO EVENT SHALL THE REGENTS OR CONTRIBUTORS BE LIABLE FOR ANY DIRECT, INDIRECT, INCIDENTAL, SPECIAL, EXEMPLARY, OR CONSEQUENTIAL DAMAGES (INCLUDING, BUT NOT LIMITED TO, PROCUREMENT OF SUBSTITUTE GOODS OR SERVICES; LOSS OF USE, DATA, OR PROFITS; OR BUSINESS INTERRUPTION) HOWEVER CAUSED AND ON ANY THEORY OF LIABILITY, WHETHER IN CONTRACT, STRICT LIABILITY, OR TORT (INCLUDING NEGLIGENCE OR OTHERWISE) ARISING IN ANY WAY OUT OF THE USE OF THIS SOFTWARE, EVEN IF ADVISED OF THE POSSIBILITY OF SUCH DAMAGE.

"This program, "bzip2", the associated library "libbzip2", and all documentation, are copyright (C) 1996-2019 Julian R Seward. All rights reserved.

Redistribution and use in source and binary forms, with or without modification, are permitted provided that the following conditions are met:

1. Redistributions of source code must retain the above copyright notice, this list of conditions and the following disclaimer.
2. The origin of this software must not be misrepresented; you must not claim that you wrote the original software. If you use this software in a product, an acknowledgment in the product documentation would be appreciated but is not required.
3. Altered source versions must be plainly marked as such, and must not be misrepresented as being the original software.
4. The name of the author may not be used to endorse or promote products derived from this software without specific prior written permission.

LICENCE TERMS (cont.)

THIS SOFTWARE IS PROVIDED BY THE AUTHOR ``AS IS" AND ANY EXPRESS OR IMPLIED WARRANTIES, INCLUDING, BUT NOT LIMITED TO, THE IMPLIED WARRANTIES OF MERCHANTABILITY AND FITNESS FOR A PARTICULAR PURPOSE ARE DISCLAIMED. IN NO EVENT SHALL THE AUTHOR BE LIABLE FOR ANY DIRECT, INDIRECT, INCIDENTAL, SPECIAL, EXEMPLARY, OR CONSEQUENTIAL DAMAGES (INCLUDING, BUT NOT LIMITED TO, PROCUREMENT OF SUBSTITUTE GOODS OR SERVICES; LOSS OF USE, DATA, OR PROFITS; OR BUSINESS INTERRUPTION) HOWEVER CAUSED AND ON ANY THEORY OF LIABILITY, WHETHER IN CONTRACT, STRICT LIABILITY, OR TORT (INCLUDING NEGLIGENCE OR OTHERWISE) ARISING IN ANY WAY OUT OF THE USE OF THIS SOFTWARE, EVEN IF ADVISED OF THE POSSIBILITY OF SUCH DAMAGE."

Copyright (C) 1996, 1997, 1998 Theodore Ts'o.

Redistribution and use in source and binary forms, with or without modification, are permitted provided that the following conditions are met:

1. Redistributions of source code must retain the above copyright notice, and the entire permission notice in its entirety, including the disclaimer of warranties.
2. Redistributions in binary form must reproduce the above copyright notice, this list of conditions and the following disclaimer in the documentation and/or other materials provided with the distribution.
3. The name of the author may not be used to endorse or promote products derived from this software without specific prior written permission.

THIS SOFTWARE IS PROVIDED ``AS IS" AND ANY EXPRESS OR IMPLIED WARRANTIES, INCLUDING, BUT NOT LIMITED TO, THE IMPLIED WARRANTIES OF MERCHANTABILITY AND FITNESS FOR A PARTICULAR PURPOSE, ALL OF WHICH ARE HEREBY DISCLAIMED. IN NO EVENT SHALL THE AUTHOR BE LIABLE FOR ANY DIRECT, INDIRECT, INCIDENTAL, SPECIAL, EXEMPLARY, OR CONSEQUENTIAL DAMAGES (INCLUDING, BUT NOT LIMITED TO, PROCUREMENT OF SUBSTITUTE GOODS OR SERVICES; LOSS OF USE, DATA, OR PROFITS; OR BUSINESS INTERRUPTION) HOWEVER CAUSED AND ON ANY THEORY OF LIABILITY, WHETHER IN CONTRACT, STRICT LIABILITY, OR TORT (INCLUDING NEGLIGENCE OR OTHERWISE) ARISING IN ANY WAY OUT OF THE USE OF THIS SOFTWARE, EVEN IF NOT ADVISED OF THE POSSIBILITY OF SUCH DAMAGE.

Copyright (C) 2017 - 2018, Stephan Mueller <smueller@chronox.de>

Redistribution and use in source and binary forms, with or without modification, are permitted provided that the following conditions are met:

1. Redistributions of source code must retain the above copyright notice, and the entire permission notice in its entirety, including the disclaimer of warranties.
2. Redistributions in binary form must reproduce the above copyright notice, this list of conditions and the following disclaimer in the documentation and/or other materials provided with the distribution.
3. The name of the author may not be used to endorse or promote products derived from this software without specific prior

written permission.

ALTERNATIVELY, this product may be distributed under the terms of the GNU General Public License, in which case the provisions of the GPL2 are required INSTEAD OF the above restrictions. (This clause is necessary due to a potential bad interaction between the GPL and the restrictions contained in a BSD-style copyright.)

THIS SOFTWARE IS PROVIDED ``AS IS" AND ANY EXPRESS OR IMPLIED WARRANTIES, INCLUDING, BUT NOT LIMITED TO, THE IMPLIED WARRANTIES OF MERCHANTABILITY AND FITNESS FOR A PARTICULAR PURPOSE, ALL OF WHICH ARE HEREBY DISCLAIMED. IN NO EVENT SHALL THE AUTHOR BE LIABLE FOR ANY DIRECT, INDIRECT, INCIDENTAL, SPECIAL, EXEMPLARY, OR CONSEQUENTIAL DAMAGES (INCLUDING, BUT NOT LIMITED TO, PROCUREMENT OF SUBSTITUTE GOODS OR SERVICES; LOSS OF USE, DATA, OR PROFITS; OR BUSINESS INTERRUPTION) HOWEVER CAUSED AND ON ANY THEORY OF LIABILITY, WHETHER IN CONTRACT, STRICT LIABILITY, OR TORT (INCLUDING NEGLIGENCE OR OTHERWISE) ARISING IN ANY WAY OUT OF THE USE OF THIS SOFTWARE, EVEN IF NOT ADVISED OF THE POSSIBILITY OF SUCH DAMAGE.

Redistribution and use in source and binary forms of libcap, with or without modification, are permitted provided that the following conditions are met:

1. Redistributions of source code must retain any existing copyright notice, and this entire permission notice in its entirety, including the disclaimer of warranties.
2. Redistributions in binary form must reproduce all prior and current copyright notices, this list of conditions, and the following disclaimer in the documentation and/or other materials provided with the distribution.
3. The name of any author may not be used to endorse or promote products derived from this software without their specific prior written permission.

THIS SOFTWARE IS PROVIDED ``AS IS" AND ANY EXPRESS OR IMPLIED WARRANTIES, INCLUDING, BUT NOT LIMITED TO, THE IMPLIED WARRANTIES OF MERCHANTABILITY AND FITNESS FOR A PARTICULAR PURPOSE ARE DISCLAIMED. IN NO EVENT SHALL THE AUTHOR(S) BE LIABLE FOR ANY DIRECT, INDIRECT, INCIDENTAL, SPECIAL, EXEMPLARY, OR CONSEQUENTIAL DAMAGES (INCLUDING, BUT NOT LIMITED TO, PROCUREMENT OF SUBSTITUTE GOODS OR SERVICES; LOSS OF USE, DATA, OR PROFITS; OR BUSINESS INTERRUPTION) HOWEVER CAUSED AND ON ANY THEORY OF LIABILITY, WHETHER IN CONTRACT, STRICT LIABILITY, OR TORT (INCLUDING NEGLIGENCE OR OTHERWISE) ARISING IN ANY WAY OUT OF THE USE OF THIS SOFTWARE, EVEN IF ADVISED OF THE POSSIBILITY OF SUCH DAMAGE.

Redistribution and use in source and binary forms of Linux-PAM, with

LICENCE TERMS (cont.)

or without modification, are permitted provided that the following conditions are met:

1. Redistributions of source code must retain any existing copyright notice, and this entire permission notice in its entirety, including the disclaimer of warranties.
2. Redistributions in binary form must reproduce all prior and current copyright notices, this list of conditions, and the following disclaimer in the documentation and/or other materials provided with the distribution.
3. The name of any author may not be used to endorse or promote products derived from this software without their specific prior written permission.

ALTERNATIVELY, this product may be distributed under the terms of the GNU General Public License, in which case the provisions of the GNU GPL are required INSTEAD OF the above restrictions. (This clause is necessary due to a potential conflict between the GNU GPL and the restrictions contained in a BSD-style copyright.)

THIS SOFTWARE IS PROVIDED ``AS IS" AND ANY EXPRESS OR IMPLIED WARRANTIES, INCLUDING, BUT NOT LIMITED TO, THE IMPLIED WARRANTIES OF MERCHANTABILITY AND FITNESS FOR A PARTICULAR PURPOSE ARE DISCLAIMED. IN NO EVENT SHALL THE AUTHOR(S) BE LIABLE FOR ANY DIRECT, INDIRECT, INCIDENTAL, SPECIAL, EXEMPLARY, OR CONSEQUENTIAL DAMAGES (INCLUDING, BUT NOT LIMITED TO, PROCUREMENT OF SUBSTITUTE GOODS OR SERVICES; LOSS OF USE, DATA, OR PROFITS; OR BUSINESS INTERRUPTION) HOWEVER CAUSED AND ON ANY THEORY OF LIABILITY, WHETHER IN CONTRACT, STRICT LIABILITY, OR TORT (INCLUDING NEGLIGENCE OR OTHERWISE) ARISING IN ANY WAY OUT OF THE USE OF THIS SOFTWARE, EVEN IF ADVISED OF THE POSSIBILITY OF SUCH DAMAGE.

Redistribution and use in source and binary forms of Linux-PAM, with or without modification, are permitted provided that the following conditions are met:

1. Redistributions of source code must retain any existing copyright notice, and this entire permission notice in its entirety, including the disclaimer of warranties.
2. Redistributions in binary form must reproduce all prior and current copyright notices, this list of conditions, and the following disclaimer in the documentation and/or other materials provided with the distribution.
3. The name of any author may not be used to endorse or promote products derived from this software without their specific prior written permission.

ALTERNATIVELY, this product may be distributed under the terms of the GNU General Public License, in which case the provisions of the GNU GPL are required INSTEAD OF the above restrictions. (This clause is necessary due to a potential conflict between the GNU GPL and the

restrictions contained in a BSD-style copyright.)

THIS SOFTWARE IS PROVIDED ``AS IS" AND ANY EXPRESS OR IMPLIED WARRANTIES, INCLUDING, BUT NOT LIMITED TO, THE IMPLIED WARRANTIES OF MERCHANTABILITY AND FITNESS FOR A PARTICULAR PURPOSE ARE DISCLAIMED. IN NO EVENT SHALL THE AUTHOR(S) BE LIABLE FOR ANY DIRECT, INDIRECT, INCIDENTAL, SPECIAL, EXEMPLARY, OR CONSEQUENTIAL DAMAGES (INCLUDING, BUT NOT LIMITED TO, PROCUREMENT OF SUBSTITUTE GOODS OR SERVICES; LOSS OF USE, DATA, OR PROFITS; OR BUSINESS INTERRUPTION) HOWEVER CAUSED AND ON ANY THEORY OF LIABILITY, WHETHER IN CONTRACT, STRICT LIABILITY, OR TORT (INCLUDING NEGLIGENCE OR OTHERWISE) ARISING IN ANY WAY OUT OF THE USE OF THIS SOFTWARE, EVEN IF ADVISED OF THE POSSIBILITY OF SUCH DAMAGE.

Redistribution and use in source and binary forms, with or without modification, are permitted provided that the following conditions are met:

1. Redistributions of source code must retain the above copyright notice, this list of conditions and the following disclaimer.
2. Redistributions in binary form must reproduce the above copyright notice, this list of conditions and the following disclaimer in the documentation and/or other materials provided with the distribution.
3. The names of the authors may not be used to endorse or promote products derived from this software without specific prior written permission.

THIS SOFTWARE IS PROVIDED ``AS IS" AND WITHOUT ANY EXPRESS OR IMPLIED WARRANTIES, INCLUDING, WITHOUT LIMITATION, THE IMPLIED WARRANTIES OF MERCHANTABILITY AND FITNESS FOR A PARTICULAR PURPOSE.

Copyright (c) Copyright (c) Bull S.A. 2005 All Rights Reserved. Redistribution and use in source and binary forms, with or without modification, are permitted provided that the following conditions are met:

1. Redistributions of source code must retain the above copyright notice, this list of conditions and the following disclaimer.
2. Redistributions in binary form must reproduce the above copyright notice, this list of conditions and the following disclaimer in the documentation and/or other materials provided with the distribution.
3. The name of the author may not be used to endorse or promote products derived from this software without specific prior written permission.

THIS SOFTWARE IS PROVIDED BY THE AUTHOR ``AS IS" AND ANY EXPRESS OR IMPLIED WARRANTIES, INCLUDING, BUT NOT LIMITED TO, THE IMPLIED WARRANTIES OF MERCHANTABILITY AND FITNESS FOR A PARTICULAR PURPOSE ARE DISCLAIMED. IN NO EVENT SHALL THE AUTHOR BE LIABLE FOR ANY DIRECT, INDIRECT, INCIDENTAL, SPECIAL, EXEMPLARY, OR CONSEQUENTIAL DAMAGES (INCLUDING, BUT NOT LIMITED TO, PROCUREMENT OF SUBSTITUTE GOODS OR SERVICES; LOSS OF USE, DATA, OR PROFITS; OR BUSINESS INTERRUPTION) HOWEVER CAUSED AND ON ANY THEORY OF LIABILITY, WHETHER IN CONTRACT, STRICT LIABILITY, OR TORT (INCLUDING NEGLIGENCE OR OTHERWISE) ARISING IN ANY WAY OUT OF THE USE OF

LICENCE TERMS (cont.)

THIS SOFTWARE, EVEN IF ADVISED OF THE POSSIBILITY OF SUCH DAMAGE.

Copyright (c) 2010, Oracle America, Inc.
Copyright (c) 2009, Sun Microsystems, Inc. All rights reserved.

Redistribution and use in source and binary forms, with or without modification, are permitted provided that the following conditions are met:

- Redistributions of source code must retain the above copyright notice, this list of conditions and the following disclaimer.
- Redistributions in binary form must reproduce the above copyright notice, this list of conditions and the following disclaimer in the documentation and/or other materials provided with the distribution.
- Neither the name of Sun Microsystems, Inc. nor the names of its contributors may be used to endorse or promote products derived from this software without specific prior written permission.

THIS SOFTWARE IS PROVIDED BY THE COPYRIGHT HOLDERS AND CONTRIBUTORS "AS IS" AND ANY EXPRESS OR IMPLIED WARRANTIES, INCLUDING, BUT NOT LIMITED TO, THE IMPLIED WARRANTIES OF MERCHANTABILITY AND FITNESS FOR A PARTICULAR PURPOSE ARE DISCLAIMED. IN NO EVENT SHALL THE COPYRIGHT HOLDER OR CONTRIBUTORS BE LIABLE FOR ANY DIRECT, INDIRECT, INCIDENTAL, SPECIAL, EXEMPLARY, OR CONSEQUENTIAL DAMAGES (INCLUDING, BUT NOT LIMITED TO, PROCUREMENT OF SUBSTITUTE GOODS OR SERVICES; LOSS OF USE, DATA, OR PROFITS; OR BUSINESS INTERRUPTION) HOWEVER CAUSED AND ON ANY THEORY OF LIABILITY, WHETHER IN CONTRACT, STRICT LIABILITY, OR TORT (INCLUDING NEGLIGENCE OR OTHERWISE) ARISING IN ANY WAY OUT OF THE USE OF THIS SOFTWARE, EVEN IF ADVISED OF THE POSSIBILITY OF SUCH DAMAGE.

Copyright (c) 2002-2019, Jouni Malinen <j@w1.fi> and contributors. All Rights Reserved.
Copyright (c) 2007-2012, Google Inc. All rights reserved.
Copyright (c) 1997-2012 University of Cambridge

Redistribution and use in source and binary forms, with or without modification, are permitted provided that the following conditions are met:

- * Redistributions of source code must retain the above copyright notice, this list of conditions and the following disclaimer.
- * Redistributions in binary form must reproduce the above copyright notice, this list of conditions and the following disclaimer in the documentation and/or other materials provided with the distribution.
- * Neither the name of the University of Cambridge nor the names of its contributors may be used to endorse or promote products derived from this software without specific prior written permission.

THIS SOFTWARE IS PROVIDED BY THE COPYRIGHT HOLDERS AND CONTRIBUTORS ""AS IS"" AND ANY EXPRESS OR IMPLIED WARRANTIES, INCLUDING, BUT NOT LIMITED TO, THE IMPLIED WARRANTIES OF MERCHANTABILITY AND FITNESS FOR A PARTICULAR PURPOSE ARE DISCLAIMED. IN NO EVENT SHALL THE COPYRIGHT OWNER OR CONTRIBUTORS BE LIABLE FOR ANY DIRECT, INDIRECT, INCIDENTAL, SPECIAL, EXEMPLARY, OR CONSEQUENTIAL DAMAGES (INCLUDING, BUT NOT LIMITED TO, PROCUREMENT OF SUBSTITUTE GOODS OR SERVICES; LOSS OF USE, DATA, OR PROFITS; OR BUSINESS

INTERRUPTION) HOWEVER CAUSED AND ON ANY THEORY OF LIABILITY, WHETHER IN CONTRACT, STRICT LIABILITY, OR TORT (INCLUDING NEGLIGENCE OR OTHERWISE) ARISING IN ANY WAY OUT OF THE USE OF THIS SOFTWARE, EVEN IF ADVISED OF THE POSSIBILITY OF SUCH DAMAGE.

Copyright (c) 1989 - 1994, Julianne Frances Haugh
Copyright (c) 1996 - 2000, Marek Michalkiewicz
Copyright (c) 2001 - 2006, Tomasz Kłoczko
Copyright (c) 2007 - 2011, Nicolas François
All rights reserved.

Redistribution and use in source and binary forms, with or without modification, are permitted provided that the following conditions are met:

1. Redistributions of source code must retain the above copyright notice, this list of conditions and the following disclaimer.
2. Redistributions in binary form must reproduce the above copyright notice, this list of conditions and the following disclaimer in the documentation and/or other materials provided with the distribution.
3. The name of the copyright holders or contributors may not be used to endorse or promote products derived from this software without specific prior written permission.

THIS SOFTWARE IS PROVIDED BY THE COPYRIGHT HOLDERS AND CONTRIBUTORS "AS IS" AND ANY EXPRESS OR IMPLIED WARRANTIES, INCLUDING, BUT NOT LIMITED TO, THE IMPLIED WARRANTIES OF MERCHANTABILITY AND FITNESS FOR A PARTICULAR PURPOSE ARE DISCLAIMED. IN NO EVENT SHALL THE COPYRIGHT HOLDERS OR CONTRIBUTORS BE LIABLE FOR ANY DIRECT, INDIRECT, INCIDENTAL, SPECIAL, EXEMPLARY, OR CONSEQUENTIAL DAMAGES (INCLUDING, BUT NOT LIMITED TO, PROCUREMENT OF SUBSTITUTE GOODS OR SERVICES; LOSS OF USE, DATA, OR PROFITS; OR BUSINESS INTERRUPTION) HOWEVER CAUSED AND ON ANY THEORY OF LIABILITY, WHETHER IN CONTRACT, STRICT LIABILITY, OR TORT (INCLUDING NEGLIGENCE OR OTHERWISE) ARISING IN ANY WAY OUT OF THE USE OF THIS SOFTWARE, EVEN IF ADVISED OF THE POSSIBILITY OF SUCH DAMAGE.

Copyright (c) 1983, 1990, 1992, 1993, 1995
The Regents of the University of California. All rights reserved.

Redistribution and use in source and binary forms, with or without modification, are permitted provided that the following conditions are met:

1. Redistributions of source code must retain the above copyright notice, this list of conditions and the following disclaimer.
2. Redistributions in binary form must reproduce the above copyright notice, this list of conditions and the following disclaimer in the documentation and/or other materials provided with the distribution.
3. Neither the name of the University nor the names of its contributors may be used to endorse or promote products derived from this software without specific prior written permission.

THIS SOFTWARE IS PROVIDED BY THE REGENTS AND CONTRIBUTORS "AS IS" AND ANY EXPRESS OR IMPLIED WARRANTIES, INCLUDING, BUT NOT LIMITED TO, THE IMPLIED WARRANTIES OF MERCHANTABILITY AND FITNESS FOR A PARTICULAR PURPOSE

LICENCE TERMS (cont.)

ARE DISCLAIMED. IN NO EVENT SHALL THE REGENTS OR CONTRIBUTORS BE LIABLE FOR ANY DIRECT, INDIRECT, INCIDENTAL, SPECIAL, EXEMPLARY, OR CONSEQUENTIAL DAMAGES (INCLUDING, BUT NOT LIMITED TO, PROCUREMENT OF SUBSTITUTE GOODS OR SERVICES; LOSS OF USE, DATA, OR PROFITS; OR BUSINESS INTERRUPTION) HOWEVER CAUSED AND ON ANY THEORY OF LIABILITY, WHETHER IN CONTRACT, STRICT LIABILITY, OR TORT (INCLUDING NEGLIGENCE OR OTHERWISE) ARISING IN ANY WAY OUT OF THE USE OF THIS SOFTWARE, EVEN IF ADVISED OF THE POSSIBILITY OF SUCH DAMAGE."

Todd C. Miller
Theo de Raadt
Damien Miller
Eric P. Allman
The Regents of the University of California
Constantin S. Svintsoff

Redistribution and use in source and binary forms, with or without modification, are permitted provided that the following conditions are met:

1. Redistributions of source code must retain the above copyright notice, this list of conditions and the following disclaimer.
2. Redistributions in binary form must reproduce the above copyright notice, this list of conditions and the following disclaimer in the documentation and/or other materials provided with the distribution.
3. Neither the name of the University nor the names of its contributors may be used to endorse or promote products derived from this software without specific prior written permission.

THIS SOFTWARE IS PROVIDED BY THE REGENTS AND CONTRIBUTORS "AS IS" AND ANY EXPRESS OR IMPLIED WARRANTIES, INCLUDING, BUT NOT LIMITED TO, THE IMPLIED WARRANTIES OF MERCHANTABILITY AND FITNESS FOR A PARTICULAR PURPOSE ARE DISCLAIMED. IN NO EVENT SHALL THE REGENTS OR CONTRIBUTORS BE LIABLE FOR ANY DIRECT, INDIRECT, INCIDENTAL, SPECIAL, EXEMPLARY, OR CONSEQUENTIAL DAMAGES (INCLUDING, BUT NOT LIMITED TO, PROCUREMENT OF SUBSTITUTE GOODS OR SERVICES; LOSS OF USE, DATA, OR PROFITS; OR BUSINESS INTERRUPTION) HOWEVER CAUSED AND ON ANY THEORY OF LIABILITY, WHETHER IN CONTRACT, STRICT LIABILITY, OR TORT (INCLUDING NEGLIGENCE OR OTHERWISE) ARISING IN ANY WAY OUT OF THE USE OF THIS SOFTWARE, EVEN IF ADVISED OF THE POSSIBILITY OF SUCH DAMAGE.

Copyright (c) 2000, Intel Corporation All rights reserved.

Redistribution and use in source and binary forms, with or without modification, are permitted provided that the following conditions are met:

* Redistributions of source code must retain the above copyright notice, this list of conditions and the following disclaimer.

* Redistributions in binary form must reproduce the above copyright notice, this list of conditions and the following disclaimer in the documentation and/or other materials provided with the distribution.

* The name of Intel Corporation may not be used to endorse or promote products derived from this software without specific prior written permission.

THIS SOFTWARE IS PROVIDED BY THE COPYRIGHT HOLDERS AND CONTRIBUTORS "AS IS" AND ANY EXPRESS OR IMPLIED WARRANTIES, INCLUDING, BUT NOT LIMITED TO, THE IMPLIED WARRANTIES OF MERCHANTABILITY AND FITNESS FOR A PARTICULAR PURPOSE ARE DISCLAIMED. IN NO EVENT SHALL INTEL OR CONTRIBUTORS BE LIABLE FOR ANY DIRECT, INDIRECT, INCIDENTAL, SPECIAL, EXEMPLARY, OR CONSEQUENTIAL DAMAGES (INCLUDING, BUT NOT LIMITED TO, PROCUREMENT OF SUBSTITUTE GOODS OR SERVICES; LOSS OF USE, DATA, OR PROFITS; OR BUSINESS INTERRUPTION) HOWEVER CAUSED AND ON ANY THEORY OF LIABILITY, WHETHER IN CONTRACT, STRICT LIABILITY, OR TORT (INCLUDING NEGLIGENCE OR OTHERWISE) ARISING IN ANY WAY OUT OF THE USE OF THIS SOFTWARE, EVEN IF ADVISED OF THE POSSIBILITY OF SUCH DAMAGE."

Copyright (C) 1998 WIDE Project. All rights reserved.

Redistribution and use in source and binary forms, with or without modification, are permitted provided that the following conditions are met:

1. Redistributions of source code must retain the above copyright notice, this list of conditions and the following disclaimer.
2. Redistributions in binary form must reproduce the above copyright notice, this list of conditions and the following disclaimer in the documentation and/or other materials provided with the distribution.
3. Neither the name of the project nor the names of its contributors may be used to endorse or promote products derived from this software without specific prior written permission.

THIS SOFTWARE IS PROVIDED BY THE PROJECT AND CONTRIBUTORS "AS IS" AND ANY EXPRESS OR IMPLIED WARRANTIES, INCLUDING, BUT NOT LIMITED TO, THE IMPLIED WARRANTIES OF MERCHANTABILITY AND FITNESS FOR A PARTICULAR PURPOSE ARE DISCLAIMED. IN NO EVENT SHALL THE PROJECT OR CONTRIBUTORS BE LIABLE FOR ANY DIRECT, INDIRECT, INCIDENTAL, SPECIAL, EXEMPLARY, OR CONSEQUENTIAL DAMAGES (INCLUDING, BUT NOT LIMITED TO, PROCUREMENT OF SUBSTITUTE GOODS OR SERVICES; LOSS OF USE, DATA, OR PROFITS; OR BUSINESS INTERRUPTION) HOWEVER CAUSED AND ON ANY THEORY OF LIABILITY, WHETHER IN CONTRACT, STRICT LIABILITY, OR TORT (INCLUDING NEGLIGENCE OR OTHERWISE) ARISING IN ANY WAY OUT OF THE USE OF THIS SOFTWARE, EVEN IF ADVISED OF THE POSSIBILITY OF SUCH DAMAGE.

Copyright (C) 1991 Regents of the University of California.
All rights reserved.

Redistribution and use in source and binary forms, with or without modification, are permitted provided that the following conditions are met:

1. Redistributions of source code must retain the above copyright notice, this list of conditions and the following disclaimer.
2. Redistributions in binary form must reproduce the above copyright notice, this list of conditions and the following disclaimer in the

LICENCE TERMS (cont.)

documentation and/or other materials provided with the distribution.

3. [This condition was removed.]

4. Neither the name of the University nor the names of its contributors may be used to endorse or promote products derived from this software without specific prior written permission.

THIS SOFTWARE IS PROVIDED BY THE REGENTS AND CONTRIBUTORS "AS IS" AND ANY EXPRESS OR IMPLIED WARRANTIES, INCLUDING, BUT NOT LIMITED TO, THE IMPLIED WARRANTIES OF MERCHANTABILITY AND FITNESS FOR A PARTICULAR PURPOSE ARE DISCLAIMED. IN NO EVENT SHALL THE REGENTS OR CONTRIBUTORS BE LIABLE FOR ANY DIRECT, INDIRECT, INCIDENTAL, SPECIAL, EXEMPLARY, OR CONSEQUENTIAL DAMAGES (INCLUDING, BUT NOT LIMITED TO, PROCUREMENT OF SUBSTITUTE GOODS OR SERVICES; LOSS OF USE, DATA, OR PROFITS; OR BUSINESS INTERRUPTION) HOWEVER CAUSED AND ON ANY THEORY OF LIABILITY, WHETHER IN CONTRACT, STRICT LIABILITY, OR TORT (INCLUDING NEGLIGENCE OR OTHERWISE) ARISING IN ANY WAY OUT OF THE USE OF THIS SOFTWARE, EVEN IF ADVISED OF THE POSSIBILITY OF SUCH DAMAGE.

This is version 2007-Mar-4 of the Info-ZIP license.

The definitive version of this document should be available at <ftp://ftp.info-zip.org/pub/infozip/license.html> indefinitely and a copy at <http://www.info-zip.org/pub/infozip/license.html>.

Copyright (c) 1990-2007 Info-ZIP. All rights reserved.

For the purposes of this copyright and license, "Info-ZIP" is defined as the following set of individuals:

Mark Adler, John Bush, Karl Davis, Harald Denker, Jean-Michel Dubois, Jean-loup Gailly, Hunter Goatley, Ed Gordon, Ian Gorman, Chris Herborth, Dirk Haase, Greg Hartwig, Robert Heath, Jonathan Hudson, Paul Kienitz, David Kirschbaum, Johnny Lee, Onno van der Linden, Igor Mandrichenko, Steve P. Miller, Sergio Monesi, Keith Owens, George Petrov, Greg Roelofs, Kai Uwe Rommel, Steve Salisbury, Dave Smith, Steven M. Schweda, Christian Spieler, Cosmin Truta, Antoine Verheijen, Paul von Behren, Rich Wales, Mike White.

This software is provided "as is," without warranty of any kind, express or implied. In no event shall Info-ZIP or its contributors be held liable for any direct, indirect, incidental, special or consequential damages arising out of the use of or inability to use this software.

Permission is granted to anyone to use this software for any purpose, including commercial applications, and to alter it and redistribute it freely, subject to the above disclaimer and the following restrictions:

1. Redistributions of source code (in whole or in part) must retain the above copyright notice, definition, disclaimer, and this list of conditions.
2. Redistributions in binary form (compiled executables and libraries) must reproduce the above copyright notice, definition, disclaimer, and this list of conditions in documentation and/or other materials provided with the distribution. The sole exception to this condition is redistribution of a standard UnZipSFX binary (including SFXWiz) as

part of a self-extracting archive; that is permitted without inclusion of this license, as long as the normal SFX banner has not been removed from the binary or disabled.

3. Altered versions--including, but not limited to, ports to new operating systems, existing ports with new graphical interfaces, versions with modified or added functionality, and dynamic, shared, or static library versions not from Info-ZIP--must be plainly marked as such and must not be misrepresented as being the original source or, if binaries, compiled from the original source. Such altered versions also must not be misrepresented as being Info-ZIP releases--including, but not limited to, labeling of the altered versions with the names "Info-ZIP" (or any variation thereof, including, but not limited to, different capitalizations), "Pocket UnZip," "WiZ" or "MacZip" without the explicit permission of Info-ZIP. Such altered versions are further prohibited from misrepresentative use of the Zip-Bugs or Info-ZIP e-mail addresses or the Info-ZIP URL(s), such as to imply Info-ZIP will provide support for the altered versions.

4. Info-ZIP retains the right to use the names "Info-ZIP," "Zip," "UnZip," "UnZipSFX," "WiZ," "Pocket UnZip," "Pocket Zip," and "MacZip" for its own source and binary releases.

Copyright (c) 2012, Intel Corporation
All rights reserved.

Redistribution and use in source and binary forms, with or without modification, are permitted provided that the following conditions are met:

* Redistributions of source code must retain the above copyright notice, this list of conditions and the following disclaimer.

* Redistributions in binary form must reproduce the above copyright notice, this list of conditions and the following disclaimer in the documentation and/or other materials provided with the distribution.

* Neither the name of the Intel Corporation nor the names of its contributors may be used to endorse or promote products derived from this software without specific prior written permission.

THIS SOFTWARE IS PROVIDED BY INTEL CORPORATION "AS IS" AND ANY EXPRESS OR IMPLIED WARRANTIES, INCLUDING, BUT NOT LIMITED TO, THE IMPLIED WARRANTIES OF MERCHANTABILITY AND FITNESS FOR A PARTICULAR PURPOSE ARE DISCLAIMED. IN NO EVENT SHALL INTEL CORPORATION OR CONTRIBUTORS BE LIABLE FOR ANY DIRECT, INDIRECT, INCIDENTAL, SPECIAL, EXEMPLARY, OR CONSEQUENTIAL DAMAGES (INCLUDING, BUT NOT LIMITED TO, PROCUREMENT OF SUBSTITUTE GOODS OR SERVICES; LOSS OF USE, DATA, OR PROFITS; OR BUSINESS INTERRUPTION) HOWEVER CAUSED AND ON ANY THEORY OF LIABILITY, WHETHER IN CONTRACT, STRICT LIABILITY, OR TORT (INCLUDING NEGLIGENCE OR OTHERWISE) ARISING IN ANY WAY OUT OF THE USE OF THIS SOFTWARE, EVEN IF ADVISED OF THE POSSIBILITY OF SUCH DAMAGE.

LICENCE TERMS (cont.)

Copyright Stephan Mueller <smueller@chronox.de>, 2013

License
=====

Redistribution and use in source and binary forms, with or without modification, are permitted provided that the following conditions are met:

1. Redistributions of source code must retain the above copyright notice, and the entire permission notice in its entirety, including the disclaimer of warranties.
2. Redistributions in binary form must reproduce the above copyright notice, this list of conditions and the following disclaimer in the documentation and/or other materials provided with the distribution.
3. The name of the author may not be used to endorse or promote products derived from this software without specific prior written permission.

ALTERNATIVELY, this product may be distributed under the terms of the GNU General Public License, in which case the provisions of the GPL are required INSTEAD OF the above restrictions. (This clause is necessary due to a potential bad interaction between the GPL and the restrictions contained in a BSD-style copyright.)

THIS SOFTWARE IS PROVIDED "AS IS" AND ANY EXPRESS OR IMPLIED WARRANTIES, INCLUDING, BUT NOT LIMITED TO, THE IMPLIED WARRANTIES OF MERCHANTABILITY AND FITNESS FOR A PARTICULAR PURPOSE, ALL OF WHICH ARE HEREBY DISCLAIMED. IN NO EVENT SHALL THE AUTHOR BE LIABLE FOR ANY DIRECT, INDIRECT, INCIDENTAL, SPECIAL, EXEMPLARY, OR CONSEQUENTIAL DAMAGES (INCLUDING, BUT NOT LIMITED TO, PROCUREMENT OF SUBSTITUTE GOODS OR SERVICES; LOSS OF USE, DATA, OR PROFITS; OR BUSINESS INTERRUPTION) HOWEVER CAUSED AND ON ANY THEORY OF LIABILITY, WHETHER IN CONTRACT, STRICT LIABILITY, OR TORT (INCLUDING NEGLIGENCE OR OTHERWISE) ARISING IN ANY WAY OUT OF THE USE OF THIS SOFTWARE, EVEN IF ADVISED OF THE POSSIBILITY OF SUCH DAMAGE.

Copyright (C) 2002-2019 Igor Sysoev All rights reserved.
Copyright (C) 2011-2019 Nginx, Inc. All rights reserved.
Copyright (c) 2006-2019 Roy Marples <roy@marples.name> All rights reserved.

Redistribution and use in source and binary forms, with or without modification, are permitted provided that the following conditions are met:

1. Redistributions of source code must retain the above copyright notice, this list of conditions and the following disclaimer.
2. Redistributions in binary form must reproduce the above copyright notice, this list of conditions and the following disclaimer in the documentation and/or other materials provided with the distribution.

THIS SOFTWARE IS PROVIDED BY THE AUTHOR AND CONTRIBUTORS "AS IS" AND ANY EXPRESS OR IMPLIED WARRANTIES, INCLUDING, BUT NOT LIMITED TO, THE IMPLIED WARRANTIES OF MERCHANTABILITY AND FITNESS FOR A PARTICULAR PURPOSE

ARE DISCLAIMED. IN NO EVENT SHALL THE AUTHOR OR CONTRIBUTORS BE LIABLE FOR ANY DIRECT, INDIRECT, INCIDENTAL, SPECIAL, EXEMPLARY, OR CONSEQUENTIAL DAMAGES (INCLUDING, BUT NOT LIMITED TO, PROCUREMENT OF SUBSTITUTE GOODS OR SERVICES; LOSS OF USE, DATA, OR PROFITS; OR BUSINESS INTERRUPTION) HOWEVER CAUSED AND ON ANY THEORY OF LIABILITY, WHETHER IN CONTRACT, STRICT LIABILITY, OR TORT (INCLUDING NEGLIGENCE OR OTHERWISE) ARISING IN ANY WAY OUT OF THE USE OF THIS SOFTWARE, EVEN IF ADVISED OF THE POSSIBILITY OF SUCH DAMAGE.

Copyright (c) 2015, Linaro Limited All rights reserved.

Redistribution and use in source and binary forms, with or without modification, are permitted provided that the following conditions are met:

1. Redistributions of source code must retain the above copyright notice, this list of conditions and the following disclaimer.
2. Redistributions in binary form must reproduce the above copyright notice, this list of conditions and the following disclaimer in the documentation and/or other materials provided with the distribution.

THIS SOFTWARE IS PROVIDED BY THE COPYRIGHT HOLDERS AND CONTRIBUTORS "AS IS" AND ANY EXPRESS OR IMPLIED WARRANTIES, INCLUDING, BUT NOT LIMITED TO, THE IMPLIED WARRANTIES OF MERCHANTABILITY AND FITNESS FOR A PARTICULAR PURPOSE ARE DISCLAIMED. IN NO EVENT SHALL THE COPYRIGHT HOLDER OR CONTRIBUTORS BE LIABLE FOR ANY DIRECT, INDIRECT, INCIDENTAL, SPECIAL, EXEMPLARY, OR CONSEQUENTIAL DAMAGES (INCLUDING, BUT NOT LIMITED TO, PROCUREMENT OF SUBSTITUTE GOODS OR SERVICES; LOSS OF USE, DATA, OR PROFITS; OR BUSINESS INTERRUPTION) HOWEVER CAUSED AND ON ANY THEORY OF LIABILITY, WHETHER IN CONTRACT, STRICT LIABILITY, OR TORT (INCLUDING NEGLIGENCE OR OTHERWISE) ARISING IN ANY WAY OUT OF THE USE OF THIS SOFTWARE, EVEN IF ADVISED OF THE POSSIBILITY OF SUCH DAMAGE.

Markus Friedl
Theo de Raadt
Niels Provos
Dug Song
Aaron Campbell
Damien Miller
Kevin Steves
Daniel Kouril
Wesley Griffin
Per Allansson
Nils Nordman
Simon Wilkinson
Ben Lindstrom
Tim Rice
Andre Lucas
Chris Adams
Corinna Vinschen
Cray Inc.
Denis Parker
Gert Doering

LICENCE TERMS (cont.)

Jakob Schlyter
Jason Downs
Juha Yrjö
Michael Stone
Networks Associates Technology, Inc.
Solar Designer
Todd C. Miller
Wayne Schroeder
William Jones
Darren Tucker
Sun Microsystems
The SCO Group
Daniel Walsh
Red Hat, Inc
Simon Vallet / Genoscope

Redistribution and use in source and binary forms, with or without modification, are permitted provided that the following conditions are met:

1. Redistributions of source code must retain the above copyright notice, this list of conditions and the following disclaimer.
2. Redistributions in binary form must reproduce the above copyright notice, this list of conditions and the following disclaimer in the documentation and/or other materials provided with the distribution.

THIS SOFTWARE IS PROVIDED BY THE AUTHOR ``AS IS" AND ANY EXPRESS OR IMPLIED WARRANTIES, INCLUDING, BUT NOT LIMITED TO, THE IMPLIED WARRANTIES OF MERCHANTABILITY AND FITNESS FOR A PARTICULAR PURPOSE ARE DISCLAIMED. IN NO EVENT SHALL THE AUTHOR BE LIABLE FOR ANY DIRECT, INDIRECT, INCIDENTAL, SPECIAL, EXEMPLARY, OR CONSEQUENTIAL DAMAGES (INCLUDING, BUT NOT LIMITED TO, PROCUREMENT OF SUBSTITUTE GOODS OR SERVICES; LOSS OF USE, DATA, OR PROFITS; OR BUSINESS INTERRUPTION) HOWEVER CAUSED AND ON ANY THEORY OF LIABILITY, WHETHER IN CONTRACT, STRICT LIABILITY, OR TORT (INCLUDING NEGLIGENCE OR OTHERWISE) ARISING IN ANY WAY OUT OF THE USE OF THIS SOFTWARE, EVEN IF ADVISED OF THE POSSIBILITY OF SUCH DAMAGE."

Copyright 1992, 1993, 1994, 1997 Henry Spencer. All rights reserved.
This software is not subject to any license of the American Telephone and Telegraph Company or of the Regents of the University of California.

Permission is granted to anyone to use this software for any purpose on any computer system, and to alter it and redistribute it, subject to the following restrictions:

1. The author is not responsible for the consequences of use of this software, no matter how awful, even if they arise from flaws in it.
2. The origin of this software must not be misrepresented, either by explicit claim or by omission. Since few users ever read sources, credits must appear in the documentation.
3. Altered versions must be plainly marked as such, and must not be misrepresented as being the original software. Since few users ever read sources, credits must appear in the documentation.

4. This notice may not be removed or altered.

The files inet/getnameinfo.c and sysdeps/posix/getaddrinfo.c are copyright (C) by Craig Metz and are distributed under the following license:

/* The Inner Net License, Version 2.00

The author(s) grant permission for redistribution and use in source and binary forms, with or without modification, of the software and documentation provided that the following conditions are met:

0. If you receive a version of the software that is specifically labelled as not being for redistribution (check the version message and/or README), you are not permitted to redistribute that version of the software in any way or form.
1. All terms of the all other applicable copyrights and licenses must be followed.
2. Redistributions of source code must retain the authors' copyright notice(s), this list of conditions, and the following disclaimer.
3. Redistributions in binary form must reproduce the authors' copyright notice(s), this list of conditions, and the following disclaimer in the documentation and/or other materials provided with the distribution.
4. [The copyright holder has authorized the removal of this clause.]
5. Neither the name(s) of the author(s) nor the names of its contributors may be used to endorse or promote products derived from this software without specific prior written permission.

THIS SOFTWARE IS PROVIDED BY ITS AUTHORS AND CONTRIBUTORS ``AS IS" AND ANY EXPRESS OR IMPLIED WARRANTIES, INCLUDING, BUT NOT LIMITED TO, THE IMPLIED WARRANTIES OF MERCHANTABILITY AND FITNESS FOR A PARTICULAR PURPOSE ARE DISCLAIMED. IN NO EVENT SHALL THE AUTHORS OR CONTRIBUTORS BE LIABLE FOR ANY DIRECT, INDIRECT, INCIDENTAL, SPECIAL, EXEMPLARY, OR CONSEQUENTIAL DAMAGES (INCLUDING, BUT NOT LIMITED TO, PROCUREMENT OF SUBSTITUTE GOODS OR SERVICES; LOSS OF USE, DATA, OR PROFITS; OR BUSINESS INTERRUPTION) HOWEVER CAUSED AND ON ANY THEORY OF LIABILITY, WHETHER IN CONTRACT, STRICT LIABILITY, OR TORT (INCLUDING NEGLIGENCE OR OTHERWISE) ARISING IN ANY WAY OUT OF THE USE OF THIS SOFTWARE, EVEN IF ADVISED OF THE POSSIBILITY OF SUCH DAMAGE.

If these license terms cause you a real problem, contact the author.

Permission is granted to anyone to use this software for any purpose on any computer system, and to redistribute it freely, subject to the following restrictions:

1. This software is distributed in the hope that it will be useful, but WITHOUT ANY WARRANTY; without even the implied warranty of MERCHANTABILITY or FITNESS FOR A PARTICULAR PURPOSE.
2. The origin of this software must not be misrepresented, either by explicit claim or by omission. In practice, this means that if you use PCRE in software that you distribute to others, commercially or otherwise, you must put a sentence like this

Regular expression support is provided by the PCRE library package, which is open source software, written by Philip Hazel, and copyright by the University of Cambridge, England.

somewhere reasonably visible in your documentation and in any relevant files or online help data or similar. A reference to the ftp site for the source, that is, to

<ftp://ftp.csx.cam.ac.uk/pub/software/programming/pcre/>

should also be given in the documentation. However, this condition is not intended to apply to whole chains of software. If package A includes PCRE, it must acknowledge it, but if package B is software that includes package A, the condition is not imposed on package B (unless it uses PCRE independently).

3. Altered versions must be plainly marked as such, and must not be misrepresented as being the original software.

4. If PCRE is embedded in any software that is released under the GNU General Purpose Licence (GPL), or Lesser General Purpose Licence (LGPL), then the terms of that licence shall supersede any condition above with which it is incompatible.

Files from Sun fdlibm are copyright Sun Microsystems, Inc.:

Copyright (C) 1993 by Sun Microsystems, Inc. All rights reserved.

Developed at SunPro, a Sun Microsystems, Inc. business.
Permission to use, copy, modify, and distribute this software is freely granted, provided that this notice is preserved.

Permission is hereby granted, free of charge, to any person obtaining a copy of this software and associated documentation files (the "Software"), to deal in the Software without restriction, including without limitation the rights to use, copy, modify, merge, publish, distribute, sublicense, and/or sell copies of the Software, and to permit persons to whom the Software is furnished to do so, subject to the following conditions:

The above copyright notice and this permission notice shall be included in all copies or substantial portions of the Software.

THE SOFTWARE IS PROVIDED "AS IS", WITHOUT WARRANTY OF ANY KIND, EXPRESS OR IMPLIED, INCLUDING BUT NOT LIMITED TO THE WARRANTIES OF MERCHANTABILITY, FITNESS FOR A PARTICULAR PURPOSE AND NONINFRINGEMENT. IN NO EVENT SHALL THE X CONSORTIUM BE LIABLE FOR ANY CLAIM, DAMAGES OR OTHER LIABILITY, WHETHER IN AN ACTION OF CONTRACT, TORT OR OTHERWISE, ARISING FROM, OUT OF OR IN CONNECTION WITH THE SOFTWARE OR THE USE OR OTHER DEALINGS IN THE SOFTWARE.

Except as contained in this notice, the name of the X Consortium shall not be used in advertising or otherwise to promote the sale, use or other dealings in this Software without prior written authorization from the X Consortium.

OCB is covered by several patents but may be used freely by most software. See <http://web.cs.ucdavis.edu/~rogaway/ocb/license.htm>. In particular license 1 is suitable for Libgcrypt: See <http://web.cs.ucdavis.edu/~rogaway/ocb/license1.pdf> for the full license document; it basically says:

License 1 — License for Open-Source Software Implementations of OCB
(Jan 9, 2013)

Under this license, you are authorized to make, use, and distribute open-source software implementations of OCB. This license terminates for you if you sue someone over their open-source software implementation of OCB claiming that you have a patent covering their implementation.

License for Open Source Software Implementations of OCB
January 9, 2013

1 Definitions

1.1 "Licensor" means Phillip Rogaway.

1.2 "Licensed Patents" means any patent that claims priority to United States Patent Application No. 09/918,615 entitled "Method and Apparatus for Facilitating Efficient Authenticated Encryption," and any utility, divisional, provisional, continuation, continuations-in-part, reexamination, reissue, or foreign counterpart patents that may issue with respect to the aforesaid patent application. This includes, but is not limited to, United States Patent No. 7,046,802; United States Patent No. 7,200,227; United States Patent No. 7,949,129; United States Patent No. 8,321,675 ; and any patent that issues out of United States Patent Application No. 13/669,114.

1.3 "Use" means any practice of any invention claimed in the Licensed Patents.

1.4 "Software Implementation" means any practice of any invention claimed in the Licensed Patents that takes the form of software executing on a user-programmable, general-purpose computer or that takes the form of a computer-readable medium storing such software. Software Implementation does not include, for example, application-specific integrated circuits (ASICs), field-programmable gate arrays (FPGAs), embedded systems, or IP cores.

1.5 "Open Source Software" means software whose source code is published and made available for inspection and use by anyone because either (a) the source code is subject to a license that permits recipients to copy, modify, and distribute the source code without payment of fees or royalties, or (b) the source code is in the public domain, including code released for public use through a CC0 waiver. All licenses certified by the Open Source Initiative at opensource.org as of January 9, 2013 and all Creative Commons licenses identified on the creativecommons.org website as of January 9, 2013, including the Public License Fallback of the CC0 waiver, satisfy these requirements for the purposes of this license.

LICENCE TERMS (cont.)

1.6 "Open Source Software Implementation" means a Software Implementation in which the software implicating the Licensed Patents is Open Source Software. Open Source Software Implementation does not include any Software Implementation in which the software implicating the Licensed Patents is combined, so as to form a larger program, with software that is not Open Source Software.

2 License Grant

2.1 License. Subject to your compliance with the terms of this license, including the restriction set forth in Section 2.2, Licensor hereby grants to you a perpetual, worldwide, non-exclusive, non-transferable, non-sublicenseable, no-charge, royalty-free, irrevocable license to practice any invention claimed in the Licensed Patents in any Open Source Software Implementation.

2.2 Restriction. If you or your affiliates institute patent litigation (including, but not limited to, a cross-claim or counterclaim in a lawsuit) against any entity alleging that any Use authorized by this license infringes another patent, then any rights granted to you under this license automatically terminate as of the date such litigation is filed.

3 Disclaimer

YOUR USE OF THE LICENSED PATENTS IS AT YOUR OWN RISK AND UNLESS REQUIRED BY APPLICABLE LAW, LICENSOR MAKES NO REPRESENTATIONS OR WARRANTIES OF ANY KIND CONCERNING THE LICENSED PATENTS OR ANY PRODUCT EMBODYING ANY LICENSED PATENT, EXPRESS OR IMPLIED, STATUTORY OR OTHERWISE, INCLUDING, WITHOUT LIMITATION, WARRANTIES OF TITLE, MERCHANTABILITY, FITNESS FOR A PARTICULAR PURPOSE, OR NON-INFRINGEMENT. IN NO EVENT WILL LICENSOR BE LIABLE FOR ANY CLAIM, DAMAGES OR OTHER LIABILITY, WHETHER IN CONTRACT, TORT OR OTHERWISE, ARISING FROM OR RELATED TO ANY USE OF THE LICENSED PATENTS, INCLUDING, WITHOUT LIMITATION, DIRECT, INDIRECT, INCIDENTAL, CONSEQUENTIAL, PUNITIVE OR SPECIAL DAMAGES, EVEN IF LICENSOR HAS BEEN ADVISED OF THE POSSIBILITY OF SUCH DAMAGES PRIOR TO SUCH AN OCCURRENCE.

This file is part of the OpenSSH software.

The licences which components of this software fall under are as follows. First, we will summarize and say that all components are under a BSD licence, or a licence more free than that.

OpenSSH contains no GPL code.

1)

- * Copyright (c) 1995 Tatu Ylonen <yo@cs.hut.fi>, Espoo, Finland
- * All rights reserved
- *
- * As far as I am concerned, the code I have written for this software
- * can be used freely for any purpose. Any derived versions of this
- * software must be clearly marked as such, and if the derived work is
- * incompatible with the protocol description in the RFC file, it must be
- * called by a name other than "ssh" or "Secure Shell".

[Tatu continues]

- * However, I am not implying to give any licenses to any patents or

- * copyrights held by third parties, and the software includes parts that
- * are not under my direct control. As far as I know, all included
- * source code is used in accordance with the relevant license agreements
- * and can be used freely for any purpose (the GNU license being the most
- * restrictive); see below for details.

[However, none of that term is relevant at this point in time. All of these restrictively licenced software components which he talks about have been removed from OpenSSH, i.e.,

- RSA is no longer included, found in the OpenSSL library
- IDEA is no longer included, its use is deprecated
- DES is now external, in the OpenSSL library
- GMP is no longer used, and instead we call BN code from OpenSSL
- Zlib is now external, in a library
- The make-ssh-known-hosts script is no longer included
- TSS has been removed
- MD5 is now external, in the OpenSSL library
- RC4 support has been replaced with ARC4 support from OpenSSL
- Blowfish is now external, in the OpenSSL library

[The licence continues]

Note that any information and cryptographic algorithms used in this software are publicly available on the Internet and at any major bookstore, scientific library, and patent office worldwide. More information can be found e.g. at <http://www.cs.hut.fi/crypto>.

The legal status of this program is some combination of all these permissions and restrictions. Use only at your own responsibility. You will be responsible for any legal consequences yourself; I am not making any claims whether possessing or using this is legal or not in your country, and I am not taking any responsibility on your behalf.

NO WARRANTY

BECAUSE THE PROGRAM IS LICENSED FREE OF CHARGE, THERE IS NO WARRANTY FOR THE PROGRAM, TO THE EXTENT PERMITTED BY APPLICABLE LAW. EXCEPT WHEN OTHERWISE STATED IN WRITING THE COPYRIGHT HOLDERS AND/OR OTHER PARTIES PROVIDE THE PROGRAM "AS IS" WITHOUT WARRANTY OF ANY KIND, EITHER EXPRESSED OR IMPLIED, INCLUDING, BUT NOT LIMITED TO, THE IMPLIED WARRANTIES OF MERCHANTABILITY AND FITNESS FOR A PARTICULAR PURPOSE. THE ENTIRE RISK AS TO THE QUALITY AND PERFORMANCE OF THE PROGRAM IS WITH YOU. SHOULD THE PROGRAM PROVE DEFECTIVE, YOU ASSUME THE COST OF ALL NECESSARY SERVICING, REPAIR OR CORRECTION.

IN NO EVENT UNLESS REQUIRED BY APPLICABLE LAW OR AGREED TO IN WRITING WILL ANY COPYRIGHT HOLDER, OR ANY OTHER PARTY WHO MAY MODIFY AND/OR REDISTRIBUTE THE PROGRAM AS PERMITTED ABOVE, BE LIABLE TO YOU FOR DAMAGES, INCLUDING ANY GENERAL, SPECIAL, INCIDENTAL OR CONSEQUENTIAL DAMAGES ARISING OUT OF THE USE OR INABILITY TO USE THE PROGRAM (INCLUDING BUT NOT LIMITED TO LOSS OF DATA OR DATA BEING RENDERED INACCURATE OR LOSSES SUSTAINED BY YOU OR THIRD PARTIES OR A FAILURE OF THE PROGRAM TO OPERATE WITH ANY OTHER PROGRAMS), EVEN IF SUCH HOLDER OR OTHER PARTY HAS BEEN ADVISED OF THE POSSIBILITY OF SUCH DAMAGES.

LICENCE TERMS (cont.)

3) ssh-keyscan was contributed by David Mazieres under a BSD-style license.

* Copyright 1995, 1996 by David Mazieres <dm@lcs.mit.edu>.

*

* Modification and redistribution in source and binary forms is permitted provided that due credit is given to the author and the OpenBSD project by leaving this copyright notice intact.

4)

The Rijndael implementation by Vincent Rijmen, Antoon Bosselaers and Paulo Barreto is in the public domain and distributed with the following license:

* @version 3.0 (December 2000)

*

* Optimised ANSI C code for the Rijndael cipher (now AES)

*

* @author Vincent Rijmen <vincent.rijmen@esat.kuleuven.ac.be>

* @author Antoon Bosselaers <antoon.bosselaers@esat.kuleuven.ac.be>

* @author Paulo Barreto <paulo.barreto@terra.com.br>

*

* This code is hereby placed in the public domain.

*

* THIS SOFTWARE IS PROVIDED BY THE AUTHORS "AS IS" AND ANY EXPRESS OR IMPLIED WARRANTIES, INCLUDING, BUT NOT LIMITED TO, THE IMPLIED WARRANTIES OF MERCHANTABILITY AND FITNESS FOR A PARTICULAR PURPOSE ARE DISCLAIMED. IN NO EVENT SHALL THE AUTHORS OR CONTRIBUTORS BE LIABLE FOR ANY DIRECT, INDIRECT, INCIDENTAL, SPECIAL, EXEMPLARY, OR CONSEQUENTIAL DAMAGES (INCLUDING, BUT NOT LIMITED TO, PROCUREMENT OF SUBSTITUTE GOODS OR SERVICES; LOSS OF USE, DATA, OR PROFITS; OR BUSINESS INTERRUPTION) HOWEVER CAUSED AND ON ANY THEORY OF LIABILITY, WHETHER IN CONTRACT, STRICT LIABILITY, OR TORT (INCLUDING NEGLIGENCE OR OTHERWISE) ARISING IN ANY WAY OUT OF THE USE OF THIS SOFTWARE, EVEN IF ADVISED OF THE POSSIBILITY OF SUCH DAMAGE.

5)

One component of the ssh source code is under a 3-clause BSD license, held by the University of California, since we pulled these parts from original Berkeley code.

* Copyright (c) 1983, 1990, 1992, 1993, 1995

* The Regents of the University of California. All rights reserved.

*

* Redistribution and use in source and binary forms, with or without modification, are permitted provided that the following conditions are met:

* 1. Redistributions of source code must retain the above copyright notice, this list of conditions and the following disclaimer.

* 2. Redistributions in binary form must reproduce the above copyright notice, this list of conditions and the following disclaimer in the documentation and/or other materials provided with the distribution.

* 3. Neither the name of the University nor the names of its contributors may be used to endorse or promote products derived from this software without specific prior written permission.

*

* THIS SOFTWARE IS PROVIDED BY THE REGENTS AND CONTRIBUTORS "AS IS" AND ANY EXPRESS OR IMPLIED WARRANTIES, INCLUDING, BUT NOT LIMITED TO, THE IMPLIED WARRANTIES OF MERCHANTABILITY AND FITNESS FOR A PARTICULAR PURPOSE ARE DISCLAIMED. IN NO EVENT SHALL THE REGENTS OR CONTRIBUTORS BE LIABLE FOR ANY DIRECT, INDIRECT, INCIDENTAL, SPECIAL, EXEMPLARY, OR CONSEQUENTIAL DAMAGES (INCLUDING, BUT NOT LIMITED TO, PROCUREMENT OF SUBSTITUTE GOODS OR SERVICES; LOSS OF USE, DATA, OR PROFITS; OR BUSINESS INTERRUPTION) HOWEVER CAUSED AND ON ANY THEORY OF LIABILITY, WHETHER IN CONTRACT, STRICT LIABILITY, OR TORT (INCLUDING NEGLIGENCE OR OTHERWISE) ARISING IN ANY WAY OUT OF THE USE OF THIS SOFTWARE, EVEN IF ADVISED OF THE POSSIBILITY OF SUCH DAMAGE.

6)

Remaining components of the software are provided under a standard 2-term BSD licence with the following names as copyright holders:

Markus Friedl
Theo de Raadt
Niels Provos
Dug Song
Aaron Campbell
Damien Miller
Kevin Steves
Daniel Kouril
Wesley Griffin
Per Allansson
Niels Nordman
Simon Wilkinson

Portable OpenSSH additionally includes code from the following copyright holders, also under the 2-term BSD license:

Ben Lindstrom
Tim Rice
Andre Lucas
Chris Adams
Corinna Vinschen
Cray Inc.
Denis Parker
Gert Doering
Jakob Schlyter
Jason Downs
Juha Yrjö
Michael Stone
Networks Associates Technology, Inc.
Solar Designer
Todd C. Miller
Wayne Schroeder
William Jones
Darren Tucker
Sun Microsystems
The SCO Group
Daniel Walsh
Red Hat, Inc
Simon Vallet / Genoscope

* Redistribution and use in source and binary forms, with or without

LICENCE TERMS (cont.)

* modification, are permitted provided that the following conditions
* are met:

- * 1. Redistributions of source code must retain the above copyright
* notice, this list of conditions and the following disclaimer.
- * 2. Redistributions in binary form must reproduce the above copyright
* notice, this list of conditions and the following disclaimer in the
* documentation and/or other materials provided with the distribution.

* THIS SOFTWARE IS PROVIDED BY THE AUTHOR "AS IS" AND ANY EXPRESS OR
* IMPLIED WARRANTIES, INCLUDING, BUT NOT LIMITED TO, THE IMPLIED WARRANTIES
* OF MERCHANTABILITY AND FITNESS FOR A PARTICULAR PURPOSE ARE DISCLAIMED.
* IN NO EVENT SHALL THE AUTHOR BE LIABLE FOR ANY DIRECT, INDIRECT,
* INCIDENTAL, SPECIAL, EXEMPLARY, OR CONSEQUENTIAL DAMAGES (INCLUDING, BUT
* NOT LIMITED TO, PROCUREMENT OF SUBSTITUTE GOODS OR SERVICES; LOSS OF USE,
* DATA, OR PROFITS; OR BUSINESS INTERRUPTION) HOWEVER CAUSED AND ON ANY
* THEORY OF LIABILITY, WHETHER IN CONTRACT, STRICT LIABILITY, OR TORT
* (INCLUDING NEGLIGENCE OR OTHERWISE) ARISING IN ANY WAY OUT OF THE USE OF
* THIS SOFTWARE, EVEN IF ADVISED OF THE POSSIBILITY OF SUCH DAMAGE.

8) Portable OpenSSH contains the following additional licenses:

a) md5crypt.c, md5crypt.h

* ""THE BEER-WARE LICENSE"" (Revision 42):

* <phk@login.dknet.dk> wrote this file. As long as you retain this
* notice you can do whatever you want with this stuff. If we meet
* some day, and you think this stuff is worth it, you can buy me a
* beer in return. Poul-Henning Kamp

b) snprintf replacement

* Copyright Patrick Powell 1995
* This code is based on code written by Patrick Powell
* (papowell@astart.com) It may be used for any purpose as long as this
* notice remains intact on all source code distributions

c) Compatibility code (openbsd-compat)

Apart from the previously mentioned licenses, various pieces of code
in the openbsd-compat/ subdirectory are licensed as follows:

Some code is licensed under a 3-term BSD license, to the following
copyright holders:

Todd C. Miller
Theo de Raadt
Damien Miller
Eric P. Allman
The Regents of the University of California
Constantin S. Svintsoff

* Redistribution and use in source and binary forms, with or without
* modification, are permitted provided that the following conditions
* are met:
* 1. Redistributions of source code must retain the above copyright
* notice, this list of conditions and the following disclaimer.
* 2. Redistributions in binary form must reproduce the above copyright

* notice, this list of conditions and the following disclaimer in the
* documentation and/or other materials provided with the distribution.
* 3. Neither the name of the University nor the names of its contributors
* may be used to endorse or promote products derived from this software
* without specific prior written permission.

* THIS SOFTWARE IS PROVIDED BY THE REGENTS AND CONTRIBUTORS "AS IS" AND
* ANY EXPRESS OR IMPLIED WARRANTIES, INCLUDING, BUT NOT LIMITED TO, THE
* IMPLIED WARRANTIES OF MERCHANTABILITY AND FITNESS FOR A PARTICULAR PURPOSE
* ARE DISCLAIMED. IN NO EVENT SHALL THE REGENTS OR CONTRIBUTORS BE LIABLE
* FOR ANY DIRECT, INDIRECT, INCIDENTAL, SPECIAL, EXEMPLARY, OR CONSEQUENTIAL
* DAMAGES (INCLUDING, BUT NOT LIMITED TO, PROCUREMENT OF SUBSTITUTE GOODS
* OR SERVICES; LOSS OF USE, DATA, OR PROFITS; OR BUSINESS INTERRUPTION)
* HOWEVER CAUSED AND ON ANY THEORY OF LIABILITY, WHETHER IN CONTRACT, STRICT
* LIABILITY, OR TORT (INCLUDING NEGLIGENCE OR OTHERWISE) ARISING IN ANY WAY
* OUT OF THE USE OF THIS SOFTWARE, EVEN IF ADVISED OF THE POSSIBILITY OF
* SUCH DAMAGE.

Some code is licensed under an ISC-style license, to the following
copyright holders:

Internet Software Consortium.
Todd C. Miller
Reyk Floeter
Chad Mynhier

* Permission to use, copy, modify, and distribute this software for any
* purpose with or without fee is hereby granted, provided that the above
* copyright notice and this permission notice appear in all copies.
*

* THE SOFTWARE IS PROVIDED "AS IS" AND TODD C. MILLER DISCLAIMS ALL
* WARRANTIES WITH REGARD TO THIS SOFTWARE INCLUDING ALL IMPLIED WARRANTIES
* OF MERCHANTABILITY AND FITNESS. IN NO EVENT SHALL TODD C. MILLER BE LIABLE
* FOR ANY SPECIAL, DIRECT, INDIRECT, OR CONSEQUENTIAL DAMAGES OR ANY DAMAGES
* WHATSOEVER RESULTING FROM LOSS OF USE, DATA OR PROFITS, WHETHER IN AN ACTION
* OF CONTRACT, NEGLIGENCE OR OTHER TORTIOUS ACTION, ARISING OUT OF OR IN
* CONNECTION WITH THE USE OR PERFORMANCE OF THIS SOFTWARE.

Some code is licensed under a MIT-style license to the following
copyright holders:

Free Software Foundation, Inc.

* Permission is hereby granted, free of charge, to any person obtaining a
* copy of this software and associated documentation files (the
* ""Software""), to deal in the Software without restriction, including
* without limitation the rights to use, copy, modify, merge, publish,
* distribute, distribute with modifications, sublicense, and/or sell
* copies of the Software, and to permit persons to whom the Software is
* furnished to do so, subject to the following conditions:
*

* The above copyright notice and this permission notice shall be included
* in all copies or substantial portions of the Software.
*

* THE SOFTWARE IS PROVIDED "AS IS", WITHOUT WARRANTY OF ANY KIND, EXPRESS
* OR IMPLIED, INCLUDING BUT NOT LIMITED TO THE WARRANTIES OF
* MERCHANTABILITY, FITNESS FOR A PARTICULAR PURPOSE AND NONINFRINGEMENT. *

LICENCE TERMS (cont.)

* IN NO EVENT SHALL THE ABOVE COPYRIGHT HOLDERS BE LIABLE FOR ANY CLAIM, *
* DAMAGES OR OTHER LIABILITY, WHETHER IN AN ACTION OF CONTRACT, TORT OR *
* OTHERWISE, ARISING FROM, OUT OF OR IN CONNECTION WITH THE SOFTWARE OR *
* THE USE OR OTHER DEALINGS IN THE SOFTWARE. *

* Except as contained in this notice, the name(s) of the above copyright *
* holders shall not be used in advertising or otherwise to promote the *
* sale, use or other dealings in this Software without prior written *
* authorization. *

*****/

This documents purpose is to state the conditions under which this Package (See definition below) viz: ""Shadow"", the Shadow Password Suite which is held by Julianne Frances Haugh, may be copied, such that the copyright holder maintains some semblance of artistic control over the development of the package, while giving the users of the package the right to use and distribute the Package in a more-or-less customary fashion, plus the right to make reasonable modifications.

So there.

Definitions:

A ""Package"" refers to the collection of files distributed by the Copyright Holder, and derivatives of that collection of files created through textual modification, or segments thereof.

""Standard Version"" refers to such a Package if it has not been modified, or has been modified in accordance with the wishes of the Copyright Holder.

""Copyright Holder"" is whoever is named in the copyright or copyrights for the package.

""You"" is you, if you're thinking about copying or distributing this Package.

""Reasonable copying fee"" is whatever you can justify on the basis of media cost, duplication charges, time of people involved, and so on. (You will not be required to justify it to the Copyright Holder, but only to the computing community at large as a market that must bear the fee.)

""Freely Available"" means that no fee is charged for the item itself, though there may be fees involved in handling the item. It also means that recipients of the item may redistribute it under the same conditions they received it.

1. You may make and give away verbatim copies of the source form of the Standard Version of this Package without restriction, provided that you duplicate all of the original copyright notices and associated

disclaimers.

2. You may apply bug fixes, portability fixes and other modifications derived from the Public Domain or from the Copyright Holder. A Package modified in such a way shall still be considered the Standard Version.

3. You may otherwise modify your copy of this Package in any way, provided that you insert a prominent notice in each changed file stating how and when AND WHY you changed that file, and provided that you do at least ONE of the following:

a) place your modifications in the Public Domain or otherwise make them Freely Available, such as by posting said modifications to Usenet or an equivalent medium, or placing the modifications on a major archive site such as uunet.uu.net, or by allowing the Copyright Holder to include your modifications in the Standard Version of the Package.

b) use the modified Package only within your corporation or organization.

c) rename any non-standard executables so the names do not conflict with standard executables, which must also be provided, and provide separate documentation for each non-standard executable that clearly documents how it differs from the Standard Version.

d) make other distribution arrangements with the Copyright Holder.

4. You may distribute the programs of this Package in object code or executable form, provided that you do at least ONE of the following:

a) distribute a Standard Version of the executables and library files, together with instructions (in the manual page or equivalent) on where to get the Standard Version.

b) accompany the distribution with the machine-readable source of the Package with your modifications.

c) accompany any non-standard executables with their corresponding Standard Version executables, giving the non-standard executables non-standard names, and clearly documenting the differences in manual pages (or equivalent), together with instructions on where to get the Standard Version.

d) make other distribution arrangements with the Copyright Holder.

5. You may charge a reasonable copying fee for any distribution of this Package. You may charge any fee you choose for support of this Package. YOU MAY NOT CHARGE A FEE FOR THIS PACKAGE ITSELF. However, you may distribute this Package in aggregate with other (possibly commercial) programs as part of a larger (possibly commercial) software distribution provided that YOU DO NOT ADVERTISE this package as a product of your own.

6. The name of the Copyright Holder may not be used to endorse or promote products derived from this software without specific prior written permission.

7. THIS PACKAGE IS PROVIDED ""AS IS"" AND WITHOUT ANY EXPRESS OR IMPLIED

LICENCE TERMS (cont.)

WARRANTIES, INCLUDING, WITHOUT LIMITATION, THE IMPLIED WARRANTIES OF MERCHANTABILITY AND FITNESS FOR A PARTICULAR PURPOSE.

The End

Firmware provided by Pierrick Hascoet <pierrick.hascoet@abiliss.com> to Devin Heitmueller <dheitmueller@kernellabs.com> on January 15, 2010.

The USB firmware files "dvh-as102_data1_st.hex" and "as102_data2_st.hex" for Abilis's AS10X, used together with the AS10X USB Kernel driver, is provided under the following licensing terms:

Copyright (c) 2010, Abilis Systems Sarl

Permission to use, copy, modify, and/or distribute this software for any purpose with or without fee is hereby granted, provided that the above copyright notice and this permission notice appear in all copies.

THE SOFTWARE IS PROVIDED "AS IS" AND THE AUTHOR DISCLAIMS ALL WARRANTIES WITH REGARD TO THIS SOFTWARE INCLUDING ALL IMPLIED WARRANTIES OF MERCHANTABILITY AND FITNESS. IN NO EVENT SHALL THE AUTHOR BE LIABLE FOR ANY SPECIAL, DIRECT, INDIRECT, OR CONSEQUENTIAL DAMAGES OR ANY DAMAGES WHATSOEVER RESULTING FROM LOSS OF USE, DATA OR PROFITS, WHETHER IN AN ACTION OF CONTRACT, NEGLIGENCE OR OTHER TORTUOUS ACTION, ARISING OUT OF OR IN CONNECTION WITH THE USE OR PERFORMANCE OF THIS SOFTWARE.

***** INTEL BINARY FIRMWARE RELEASE LICENCE *****

Copyright (c) 2014-15 Intel Corporation.
All rights reserved.

Redistribution.

Redistribution and use in binary form, without modification, are permitted provided that the following conditions are met:

- * Redistributions must reproduce the above copyright notice and the following disclaimer in the documentation and/or other materials provided with the distribution.
- * Neither the name of Intel Corporation nor the names of its suppliers may be used to endorse or promote products derived from this software without specific prior written permission.
- * No reverse engineering, decompilation, or disassembly of this software is permitted.

Limited patent license.

Intel Corporation grants a world-wide, royalty-free, non-exclusive license under patents it now or hereafter owns or controls to make, have made, use,

import, offer to sell and sell ("Utilize") this software, but solely to the extent that any such patent is necessary to Utilize the software alone. The patent license shall not apply to any combinations which include this software. No hardware per se is licensed hereunder.

DISCLAIMER.

THIS SOFTWARE IS PROVIDED BY THE COPYRIGHT HOLDERS AND CONTRIBUTORS "AS IS" AND ANY EXPRESS OR IMPLIED WARRANTIES, INCLUDING, BUT NOT LIMITED TO, THE IMPLIED WARRANTIES OF MERCHANTABILITY AND FITNESS FOR A PARTICULAR PURPOSE ARE DISCLAIMED. IN NO EVENT SHALL THE COPYRIGHT OWNER OR CONTRIBUTORS BE LIABLE FOR ANY DIRECT, INDIRECT, INCIDENTAL, SPECIAL, EXEMPLARY, OR CONSEQUENTIAL DAMAGES (INCLUDING, BUT NOT LIMITED TO, PROCUREMENT OF SUBSTITUTE GOODS OR SERVICES; LOSS OF USE, DATA, OR PROFITS; OR BUSINESS INTERRUPTION) HOWEVER CAUSED AND ON ANY THEORY OF LIABILITY, WHETHER IN CONTRACT, STRICT LIABILITY, OR TORT (INCLUDING NEGLIGENCE OR OTHERWISE) ARISING IN ANY WAY OUT OF THE USE OF THIS SOFTWARE, EVEN IF ADVISED OF THE POSSIBILITY OF SUCH DAMAGE.

***** NEW LIBC LICENCE*****

The newlib subdirectory is a collection of software from several sources.

Each file may have its own copyright/license that is embedded in the source file. Unless otherwise noted in the body of the source file(s), the following copyright notices will apply to the contents of the newlib subdirectory:

(1) Red Hat Incorporated

Copyright (c) 1994-2009 Red Hat, Inc. All rights reserved.

This copyrighted material is made available to anyone wishing to use, modify, copy, or redistribute it subject to the terms and conditions of the BSD License. This program is distributed in the hope that it will be useful, but WITHOUT ANY WARRANTY expressed or implied, including the implied warranties of MERCHANTABILITY or FITNESS FOR A PARTICULAR PURPOSE. A copy of this license is available at <http://www.opensource.org/licenses>. Any Red Hat trademarks that are incorporated in the source code or documentation are not subject to the BSD License and may only be used or replicated with the express permission of Red Hat, Inc.

(2) University of California, Berkeley

Copyright (c) 1981-2000 The Regents of the University of California.
All rights reserved.

Redistribution and use in source and binary forms, with or without modification, are permitted provided that the following conditions are met:

- * Redistributions of source code must retain the above copyright notice, this list of conditions and the following disclaimer.
- * Redistributions in binary form must reproduce the above copyright notice, this list of conditions and the following disclaimer in the documentation and/or other materials provided with the distribution.

LICENCE TERMS (cont.)

* Neither the name of the University nor the names of its contributors may be used to endorse or promote products derived from this software without specific prior written permission.

THIS SOFTWARE IS PROVIDED BY THE COPYRIGHT HOLDERS AND CONTRIBUTORS "AS IS" AND ANY EXPRESS OR IMPLIED WARRANTIES, INCLUDING, BUT NOT LIMITED TO, THE IMPLIED WARRANTIES OF MERCHANTABILITY AND FITNESS FOR A PARTICULAR PURPOSE ARE DISCLAIMED. IN NO EVENT SHALL THE COPYRIGHT OWNER OR CONTRIBUTORS BE LIABLE FOR ANY DIRECT, INDIRECT, INCIDENTAL, SPECIAL, EXEMPLARY, OR CONSEQUENTIAL DAMAGES (INCLUDING, BUT NOT LIMITED TO, PROCUREMENT OF SUBSTITUTE GOODS OR SERVICES; LOSS OF USE, DATA, OR PROFITS; OR BUSINESS INTERRUPTION) HOWEVER CAUSED AND ON ANY THEORY OF LIABILITY, WHETHER IN CONTRACT, STRICT LIABILITY, OR TORT (INCLUDING NEGLIGENCE OR OTHERWISE) ARISING IN ANY WAY OUT OF THE USE OF THIS SOFTWARE, EVEN IF ADVISED OF THE POSSIBILITY OF SUCH DAMAGE.

(3) David M. Gay (AT&T 1991, Lucent 1998)

The author of this software is David M. Gay.

Copyright (c) 1991 by AT&T.

Permission to use, copy, modify, and distribute this software for any purpose without fee is hereby granted, provided that this entire notice is included in all copies of any software which is or includes a copy or modification of this software and in all copies of the supporting documentation for such software.

THIS SOFTWARE IS BEING PROVIDED "AS IS", WITHOUT ANY EXPRESS OR IMPLIED WARRANTY. IN PARTICULAR, NEITHER THE AUTHOR NOR AT&T MAKES ANY REPRESENTATION OR WARRANTY OF ANY KIND CONCERNING THE MERCHANTABILITY OF THIS SOFTWARE OR ITS FITNESS FOR ANY PARTICULAR PURPOSE.

The author of this software is David M. Gay.

Copyright (C) 1998-2001 by Lucent Technologies
All Rights Reserved

Permission to use, copy, modify, and distribute this software and its documentation for any purpose and without fee is hereby granted, provided that the above copyright notice appear in all copies and that both that the copyright notice and this permission notice and warranty disclaimer appear in supporting documentation, and that the name of Lucent or any of its entities not be used in advertising or publicity pertaining to distribution of the software without specific, written prior permission.

LUCENT DISCLAIMS ALL WARRANTIES WITH REGARD TO THIS SOFTWARE, INCLUDING ALL IMPLIED WARRANTIES OF MERCHANTABILITY AND FITNESS. IN NO EVENT SHALL LUCENT OR ANY OF ITS ENTITIES BE LIABLE FOR ANY SPECIAL, INDIRECT OR CONSEQUENTIAL DAMAGES OR ANY DAMAGES WHATSOEVER RESULTING FROM LOSS OF USE, DATA OR PROFITS, WHETHER IN AN ACTION OF CONTRACT, NEGLIGENCE OR OTHER TORTIOUS ACTION, ARISING OUT OF OR IN CONNECTION WITH THE USE OR PERFORMANCE OF THIS SOFTWARE.

(4) Advanced Micro Devices

Copyright 1989, 1990 Advanced Micro Devices, Inc.

This software is the property of Advanced Micro Devices, Inc (AMD) which specifically grants the user the right to modify, use and distribute this software provided this notice is not removed or altered. All other rights are reserved by AMD.

AMD MAKES NO WARRANTY OF ANY KIND, EXPRESS OR IMPLIED, WITH REGARD TO THIS SOFTWARE. IN NO EVENT SHALL AMD BE LIABLE FOR INCIDENTAL OR CONSEQUENTIAL DAMAGES IN CONNECTION WITH OR ARISING FROM THE FURNISHING, PERFORMANCE, OR USE OF THIS SOFTWARE.

So that all may benefit from your experience, please report any problems or suggestions about this software to the 29K Technical Support Center at 800-29-29-AMD (800-292-9263) in the USA, or 0800-89-1131 in the UK, or 0031-11-1129 in Japan, toll free. The direct dial number is 512-462-4118.

Advanced Micro Devices, Inc.
29K Support Products
Mail Stop 573
5900 E. Ben White Blvd.
Austin, TX 78741
800-292-9263

(5)

(6)

(7) Sun Microsystems

Copyright (C) 1993 by Sun Microsystems, Inc. All rights reserved.

Developed at SunPro, a Sun Microsystems, Inc. business.
Permission to use, copy, modify, and distribute this software is freely granted, provided that this notice is preserved.

(8) Hewlett Packard

(c) Copyright 1986 HEWLETT-PACKARD COMPANY

To anyone who acknowledges that this file is provided "AS IS" without any express or implied warranty:

permission to use, copy, modify, and distribute this file for any purpose is hereby granted without fee, provided that the above copyright notice and this notice appears in all copies, and that the name of Hewlett-Packard Company not be used in advertising or publicity pertaining to distribution of the software without specific, written prior permission. Hewlett-Packard Company makes no representations about the suitability of this software for any purpose.

(9) Hans-Peter Nilsson

Copyright (C) 2001 Hans-Peter Nilsson

LICENCE TERMS (cont.)

Permission to use, copy, modify, and distribute this software is freely granted, provided that the above copyright notice, this notice and the following disclaimer are preserved with no changes.

THIS SOFTWARE IS PROVIDED "AS IS" AND WITHOUT ANY EXPRESS OR IMPLIED WARRANTIES, INCLUDING, WITHOUT LIMITATION, THE IMPLIED WARRANTIES OF MERCHANTABILITY AND FITNESS FOR A PARTICULAR PURPOSE.

(10) Stephane Carrez (m68hc11-elf/m68hc12-elf targets only)

Copyright (C) 1999, 2000, 2001, 2002 Stephane Carrez (stcarrez@nerim.fr)

The authors hereby grant permission to use, copy, modify, distribute, and license this software and its documentation for any purpose, provided that existing copyright notices are retained in all copies and that this notice is included verbatim in any distributions. No written agreement, license, or royalty fee is required for any of the authorized uses. Modifications to this software may be copyrighted by their authors and need not follow the licensing terms described here, provided that the new terms are clearly indicated on the first page of each file where they apply.

(11) Christopher G. Demetriou

Copyright (c) 2001 Christopher G. Demetriou
All rights reserved.

Redistribution and use in source and binary forms, with or without modification, are permitted provided that the following conditions are met:

1. Redistributions of source code must retain the above copyright notice, this list of conditions and the following disclaimer.
2. Redistributions in binary form must reproduce the above copyright notice, this list of conditions and the following disclaimer in the documentation and/or other materials provided with the distribution.
3. The name of the author may not be used to endorse or promote products derived from this software without specific prior written permission.

THIS SOFTWARE IS PROVIDED BY THE AUTHOR "AS IS" AND ANY EXPRESS OR IMPLIED WARRANTIES, INCLUDING, BUT NOT LIMITED TO, THE IMPLIED WARRANTIES OF MERCHANTABILITY AND FITNESS FOR A PARTICULAR PURPOSE ARE DISCLAIMED. IN NO EVENT SHALL THE AUTHOR BE LIABLE FOR ANY DIRECT, INDIRECT, INCIDENTAL, SPECIAL, EXEMPLARY, OR CONSEQUENTIAL DAMAGES (INCLUDING, BUT NOT LIMITED TO, PROCUREMENT OF SUBSTITUTE GOODS OR SERVICES; LOSS OF USE, DATA, OR PROFITS; OR BUSINESS INTERRUPTION) HOWEVER CAUSED AND ON ANY THEORY OF LIABILITY, WHETHER IN CONTRACT, STRICT LIABILITY, OR TORT (INCLUDING NEGLIGENCE OR OTHERWISE) ARISING IN ANY WAY OUT OF THE USE OF THIS SOFTWARE, EVEN IF ADVISED OF THE POSSIBILITY OF SUCH DAMAGE.

(12) SuperH, Inc.

Copyright 2002 SuperH, Inc. All rights reserved

This software is the property of SuperH, Inc (SuperH) which specifically grants the user the right to modify, use and distribute this software provided this notice is not removed or altered. All other rights are

reserved by SuperH.

SUPERH MAKES NO WARRANTY OF ANY KIND, EXPRESS OR IMPLIED, WITH REGARD TO THIS SOFTWARE. IN NO EVENT SHALL SUPERH BE LIABLE FOR INDIRECT, SPECIAL, INCIDENTAL OR CONSEQUENTIAL DAMAGES IN CONNECTION WITH OR ARISING FROM THE FURNISHING, PERFORMANCE, OR USE OF THIS SOFTWARE.

So that all may benefit from your experience, please report any problems or suggestions about this software to the SuperH Support Center via e-mail at softwaresupport@superh.com.

SuperH, Inc.
405 River Oaks Parkway
San Jose
CA 95134
USA

(13) Royal Institute of Technology

Copyright (c) 1999 Kungliga Tekniska Högskolan
(Royal Institute of Technology, Stockholm, Sweden).
All rights reserved.

Redistribution and use in source and binary forms, with or without modification, are permitted provided that the following conditions are met:

1. Redistributions of source code must retain the above copyright notice, this list of conditions and the following disclaimer.
2. Redistributions in binary form must reproduce the above copyright notice, this list of conditions and the following disclaimer in the documentation and/or other materials provided with the distribution.
3. Neither the name of KTH nor the names of its contributors may be used to endorse or promote products derived from this software without specific prior written permission.

THIS SOFTWARE IS PROVIDED BY KTH AND ITS CONTRIBUTORS "AS IS" AND ANY EXPRESS OR IMPLIED WARRANTIES, INCLUDING, BUT NOT LIMITED TO, THE IMPLIED WARRANTIES OF MERCHANTABILITY AND FITNESS FOR A PARTICULAR PURPOSE ARE DISCLAIMED. IN NO EVENT SHALL KTH OR ITS CONTRIBUTORS BE LIABLE FOR ANY DIRECT, INDIRECT, INCIDENTAL, SPECIAL, EXEMPLARY, OR CONSEQUENTIAL DAMAGES (INCLUDING, BUT NOT LIMITED TO, PROCUREMENT OF SUBSTITUTE GOODS OR SERVICES; LOSS OF USE, DATA, OR PROFITS; OR BUSINESS INTERRUPTION) HOWEVER CAUSED AND ON ANY THEORY OF LIABILITY, WHETHER IN CONTRACT, STRICT LIABILITY, OR TORT (INCLUDING NEGLIGENCE OR OTHERWISE) ARISING IN ANY WAY OUT OF THE USE OF THIS SOFTWARE, EVEN IF ADVISED OF THE POSSIBILITY OF SUCH DAMAGE.

(14) Alexey Zelkin

Copyright (c) 2000, 2001 Alexey Zelkin <phantom@FreeBSD.org>
All rights reserved.

Redistribution and use in source and binary forms, with or without modification, are permitted provided that the following conditions

LICENCE TERMS (cont.)

are met:

1. Redistributions of source code must retain the above copyright notice, this list of conditions and the following disclaimer.
2. Redistributions in binary form must reproduce the above copyright notice, this list of conditions and the following disclaimer in the documentation and/or other materials provided with the distribution.

THIS SOFTWARE IS PROVIDED BY THE AUTHOR AND CONTRIBUTORS ``AS IS'' AND ANY EXPRESS OR IMPLIED WARRANTIES, INCLUDING, BUT NOT LIMITED TO, THE IMPLIED WARRANTIES OF MERCHANTABILITY AND FITNESS FOR A PARTICULAR PURPOSE ARE DISCLAIMED. IN NO EVENT SHALL THE AUTHOR OR CONTRIBUTORS BE LIABLE FOR ANY DIRECT, INDIRECT, INCIDENTAL, SPECIAL, EXEMPLARY, OR CONSEQUENTIAL DAMAGES (INCLUDING, BUT NOT LIMITED TO, PROCUREMENT OF SUBSTITUTE GOODS OR SERVICES; LOSS OF USE, DATA, OR PROFITS; OR BUSINESS INTERRUPTION) HOWEVER CAUSED AND ON ANY THEORY OF LIABILITY, WHETHER IN CONTRACT, STRICT LIABILITY, OR TORT (INCLUDING NEGLIGENCE OR OTHERWISE) ARISING IN ANY WAY OUT OF THE USE OF THIS SOFTWARE, EVEN IF ADVISED OF THE POSSIBILITY OF SUCH DAMAGE.

(15) Andrey A. Chernov

Copyright (C) 1997 by Andrey A. Chernov, Moscow, Russia.
All rights reserved.

Redistribution and use in source and binary forms, with or without modification, are permitted provided that the following conditions are met:

1. Redistributions of source code must retain the above copyright notice, this list of conditions and the following disclaimer.
2. Redistributions in binary form must reproduce the above copyright notice, this list of conditions and the following disclaimer in the documentation and/or other materials provided with the distribution.

THIS SOFTWARE IS PROVIDED BY THE AUTHOR ``AS IS'' AND ANY EXPRESS OR IMPLIED WARRANTIES, INCLUDING, BUT NOT LIMITED TO, THE IMPLIED WARRANTIES OF MERCHANTABILITY AND FITNESS FOR A PARTICULAR PURPOSE ARE DISCLAIMED. IN NO EVENT SHALL THE REGENTS OR CONTRIBUTORS BE LIABLE FOR ANY DIRECT, INDIRECT, INCIDENTAL, SPECIAL, EXEMPLARY, OR CONSEQUENTIAL DAMAGES (INCLUDING, BUT NOT LIMITED TO, PROCUREMENT OF SUBSTITUTE GOODS OR SERVICES; LOSS OF USE, DATA, OR PROFITS; OR BUSINESS INTERRUPTION) HOWEVER CAUSED AND ON ANY THEORY OF LIABILITY, WHETHER IN CONTRACT, STRICT LIABILITY, OR TORT (INCLUDING NEGLIGENCE OR OTHERWISE) ARISING IN ANY WAY OUT OF THE USE OF THIS SOFTWARE, EVEN IF ADVISED OF THE POSSIBILITY OF SUCH DAMAGE.

(16) FreeBSD

Copyright (c) 1997-2002 FreeBSD Project.
All rights reserved.

Redistribution and use in source and binary forms, with or without modification, are permitted provided that the following conditions are met:

1. Redistributions of source code must retain the above copyright notice, this list of conditions and the following disclaimer.
2. Redistributions in binary form must reproduce the above copyright notice, this list of conditions and the following disclaimer in the

documentation and/or other materials provided with the distribution.

THIS SOFTWARE IS PROVIDED BY THE AUTHOR AND CONTRIBUTORS ``AS IS'' AND ANY EXPRESS OR IMPLIED WARRANTIES, INCLUDING, BUT NOT LIMITED TO, THE IMPLIED WARRANTIES OF MERCHANTABILITY AND FITNESS FOR A PARTICULAR PURPOSE ARE DISCLAIMED. IN NO EVENT SHALL THE AUTHOR OR CONTRIBUTORS BE LIABLE FOR ANY DIRECT, INDIRECT, INCIDENTAL, SPECIAL, EXEMPLARY, OR CONSEQUENTIAL DAMAGES (INCLUDING, BUT NOT LIMITED TO, PROCUREMENT OF SUBSTITUTE GOODS OR SERVICES; LOSS OF USE, DATA, OR PROFITS; OR BUSINESS INTERRUPTION) HOWEVER CAUSED AND ON ANY THEORY OF LIABILITY, WHETHER IN CONTRACT, STRICT LIABILITY, OR TORT (INCLUDING NEGLIGENCE OR OTHERWISE) ARISING IN ANY WAY OUT OF THE USE OF THIS SOFTWARE, EVEN IF ADVISED OF THE POSSIBILITY OF SUCH DAMAGE.

(17) S. L. Moshier

Author: S. L. Moshier.

Copyright (c) 1984,2000 S.L. Moshier

Permission to use, copy, modify, and distribute this software for any purpose without fee is hereby granted, provided that this entire notice is included in all copies of any software which is or includes a copy or modification of this software and in all copies of the supporting documentation for such software.

THIS SOFTWARE IS BEING PROVIDED "AS IS", WITHOUT ANY EXPRESS OR IMPLIED WARRANTY. IN PARTICULAR, THE AUTHOR MAKES NO REPRESENTATION OR WARRANTY OF ANY KIND CONCERNING THE MERCHANTABILITY OF THIS SOFTWARE OR ITS FITNESS FOR ANY PARTICULAR PURPOSE.

(18) Citrus Project

Copyright (c)1999 Citrus Project,
All rights reserved.

Redistribution and use in source and binary forms, with or without modification, are permitted provided that the following conditions are met:

1. Redistributions of source code must retain the above copyright notice, this list of conditions and the following disclaimer.
2. Redistributions in binary form must reproduce the above copyright notice, this list of conditions and the following disclaimer in the documentation and/or other materials provided with the distribution.

THIS SOFTWARE IS PROVIDED BY THE AUTHOR AND CONTRIBUTORS ``AS IS'' AND ANY EXPRESS OR IMPLIED WARRANTIES, INCLUDING, BUT NOT LIMITED TO, THE IMPLIED WARRANTIES OF MERCHANTABILITY AND FITNESS FOR A PARTICULAR PURPOSE ARE DISCLAIMED. IN NO EVENT SHALL THE AUTHOR OR CONTRIBUTORS BE LIABLE FOR ANY DIRECT, INDIRECT, INCIDENTAL, SPECIAL, EXEMPLARY, OR CONSEQUENTIAL DAMAGES (INCLUDING, BUT NOT LIMITED TO, PROCUREMENT OF SUBSTITUTE GOODS OR SERVICES; LOSS OF USE, DATA, OR PROFITS; OR BUSINESS INTERRUPTION) HOWEVER CAUSED AND ON ANY THEORY OF LIABILITY, WHETHER IN CONTRACT, STRICT LIABILITY, OR TORT (INCLUDING NEGLIGENCE OR OTHERWISE) ARISING IN ANY WAY OUT OF THE USE OF THIS SOFTWARE, EVEN IF ADVISED OF THE POSSIBILITY OF SUCH DAMAGE.

LICENCE TERMS (cont.)

(19) Todd C. Miller

Copyright (c) 1998 Todd C. Miller <Todd.Miller@courtesan.com>
All rights reserved.

Redistribution and use in source and binary forms, with or without modification, are permitted provided that the following conditions are met:

1. Redistributions of source code must retain the above copyright notice, this list of conditions and the following disclaimer.
2. Redistributions in binary form must reproduce the above copyright notice, this list of conditions and the following disclaimer in the documentation and/or other materials provided with the distribution.
3. The name of the author may not be used to endorse or promote products derived from this software without specific prior written permission.

THIS SOFTWARE IS PROVIDED "AS IS" AND ANY EXPRESS OR IMPLIED WARRANTIES, INCLUDING, BUT NOT LIMITED TO, THE IMPLIED WARRANTIES OF MERCHANTABILITY AND FITNESS FOR A PARTICULAR PURPOSE ARE DISCLAIMED. IN NO EVENT SHALL THE AUTHOR BE LIABLE FOR ANY DIRECT, INDIRECT, INCIDENTAL, SPECIAL, EXEMPLARY, OR CONSEQUENTIAL DAMAGES (INCLUDING, BUT NOT LIMITED TO, PROCUREMENT OF SUBSTITUTE GOODS OR SERVICES; LOSS OF USE, DATA, OR PROFITS; OR BUSINESS INTERRUPTION) HOWEVER CAUSED AND ON ANY THEORY OF LIABILITY, WHETHER IN CONTRACT, STRICT LIABILITY, OR TORT (INCLUDING NEGLIGENCE OR OTHERWISE) ARISING IN ANY WAY OUT OF THE USE OF THIS SOFTWARE, EVEN IF ADVISED OF THE POSSIBILITY OF SUCH DAMAGE.

(20) DJ Delorie (i386)
Copyright (C) 1991 DJ Delorie
All rights reserved.

Redistribution, modification, and use in source and binary forms is permitted provided that the above copyright notice and following paragraph are duplicated in all such forms.

This file is distributed WITHOUT ANY WARRANTY; without even the implied warranty of MERCHANTABILITY or FITNESS FOR A PARTICULAR PURPOSE.

(21) Free Software Foundation LGPL License (*-linux* targets only)

Copyright (C) 1990-1999, 2000, 2001 Free Software Foundation, Inc.
This file is part of the GNU C Library.
Contributed by Mark Kettenis <kettenis@phys.uva.nl>, 1997.

The GNU C Library is free software; you can redistribute it and/or modify it under the terms of the GNU Lesser General Public License as published by the Free Software Foundation; either version 2.1 of the License, or (at your option) any later version.

The GNU C Library is distributed in the hope that it will be useful, but WITHOUT ANY WARRANTY; without even the implied warranty of MERCHANTABILITY or FITNESS FOR A PARTICULAR PURPOSE. See the GNU Lesser General Public License for more details.

You should have received a copy of the GNU Lesser General Public License along with the GNU C Library; if not, write to the Free Software Foundation, Inc., 51 Franklin Street, Fifth Floor, Boston, MA

02110-1301 USA.

(22) Xavier Leroy LGPL License (i[3456]86-*-linux* targets only)

Copyright (C) 1996 Xavier Leroy (Xavier.Leroy@inria.fr)

This program is free software; you can redistribute it and/or modify it under the terms of the GNU Library General Public License as published by the Free Software Foundation; either version 2 of the License, or (at your option) any later version.

This program is distributed in the hope that it will be useful, but WITHOUT ANY WARRANTY; without even the implied warranty of MERCHANTABILITY or FITNESS FOR A PARTICULAR PURPOSE. See the GNU Library General Public License for more details.

(23) Intel (i960)

Copyright (c) 1993 Intel Corporation

Intel hereby grants you permission to copy, modify, and distribute this software and its documentation. Intel grants this permission provided that the above copyright notice appears in all copies and that both the copyright notice and this permission notice appear in supporting documentation. In addition, Intel grants this permission provided that you prominently mark as "not part of the original" any modifications made to this software or documentation, and that the name of Intel Corporation not be used in advertising or publicity pertaining to distribution of the software or the documentation without specific, written prior permission.

Intel Corporation provides this AS IS, WITHOUT ANY WARRANTY, EXPRESS OR IMPLIED, INCLUDING, WITHOUT LIMITATION, ANY WARRANTY OF MERCHANTABILITY OR FITNESS FOR A PARTICULAR PURPOSE. Intel makes no guarantee or representations regarding the use of, or the results of the use of, the software and documentation in terms of correctness, accuracy, reliability, currentness, or otherwise; and you rely on the software, documentation and results solely at your own risk.

IN NO EVENT SHALL INTEL BE LIABLE FOR ANY LOSS OF USE, LOSS OF BUSINESS, LOSS OF PROFITS, INDIRECT, INCIDENTAL, SPECIAL OR CONSEQUENTIAL DAMAGES OF ANY KIND. IN NO EVENT SHALL INTEL'S TOTAL LIABILITY EXCEED THE SUM PAID TO INTEL FOR THE PRODUCT LICENSED HEREUNDER.

(24) Hewlett-Packard (hppa targets only)

(c) Copyright 1986 HEWLETT-PACKARD COMPANY

To anyone who acknowledges that this file is provided "AS IS" without any express or implied warranty:

permission to use, copy, modify, and distribute this file for any purpose is hereby granted without fee, provided that the above copyright notice and this notice appears in all copies, and that the name of Hewlett-Packard Company not be used in advertising or publicity pertaining to distribution of the software without specific, written prior permission.

Hewlett-Packard Company makes no representations about the

suitability of this software for any purpose.

(25) Henry Spencer (only *-linux targets)

Copyright 1992, 1993, 1994 Henry Spencer. All rights reserved.
This software is not subject to any license of the American Telephone and Telegraph Company or of the Regents of the University of California.

Permission is granted to anyone to use this software for any purpose on any computer system, and to alter it and redistribute it, subject to the following restrictions:

1. The author is not responsible for the consequences of use of this software, no matter how awful, even if they arise from flaws in it.
2. The origin of this software must not be misrepresented, either by explicit claim or by omission. Since few users ever read sources, credits must appear in the documentation.
3. Altered versions must be plainly marked as such, and must not be misrepresented as being the original software. Since few users ever read sources, credits must appear in the documentation.
4. This notice may not be removed or altered.

(26) Mike Barcroft

Copyright (c) 2001 Mike Barcroft <mike@FreeBSD.org>
All rights reserved.

Redistribution and use in source and binary forms, with or without modification, are permitted provided that the following conditions are met:

1. Redistributions of source code must retain the above copyright notice, this list of conditions and the following disclaimer.
2. Redistributions in binary form must reproduce the above copyright notice, this list of conditions and the following disclaimer in the documentation and/or other materials provided with the distribution.

THIS SOFTWARE IS PROVIDED BY THE AUTHOR AND CONTRIBUTORS ``AS IS'' AND ANY EXPRESS OR IMPLIED WARRANTIES, INCLUDING, BUT NOT LIMITED TO, THE IMPLIED WARRANTIES OF MERCHANTABILITY AND FITNESS FOR A PARTICULAR PURPOSE ARE DISCLAIMED. IN NO EVENT SHALL THE AUTHOR OR CONTRIBUTORS BE LIABLE FOR ANY DIRECT, INDIRECT, INCIDENTAL, SPECIAL, EXEMPLARY, OR CONSEQUENTIAL DAMAGES (INCLUDING, BUT NOT LIMITED TO, PROCUREMENT OF SUBSTITUTE GOODS OR SERVICES; LOSS OF USE, DATA, OR PROFITS; OR BUSINESS INTERRUPTION) HOWEVER CAUSED AND ON ANY THEORY OF LIABILITY, WHETHER IN CONTRACT, STRICT LIABILITY, OR TORT (INCLUDING NEGLIGENCE OR OTHERWISE) ARISING IN ANY WAY OUT OF THE USE OF THIS SOFTWARE, EVEN IF ADVISED OF THE POSSIBILITY OF SUCH DAMAGE.

(27) Konstantin Chuguev (--enable-newlib-iconv)

Copyright (c) 1999, 2000
Konstantin Chuguev. All rights reserved.

Redistribution and use in source and binary forms, with or without

modification, are permitted provided that the following conditions are met:

1. Redistributions of source code must retain the above copyright notice, this list of conditions and the following disclaimer.
2. Redistributions in binary form must reproduce the above copyright notice, this list of conditions and the following disclaimer in the documentation and/or other materials provided with the distribution.

THIS SOFTWARE IS PROVIDED BY THE AUTHOR AND CONTRIBUTORS ``AS IS'' AND ANY EXPRESS OR IMPLIED WARRANTIES, INCLUDING, BUT NOT LIMITED TO, THE IMPLIED WARRANTIES OF MERCHANTABILITY AND FITNESS FOR A PARTICULAR PURPOSE ARE DISCLAIMED. IN NO EVENT SHALL THE AUTHOR OR CONTRIBUTORS BE LIABLE FOR ANY DIRECT, INDIRECT, INCIDENTAL, SPECIAL, EXEMPLARY, OR CONSEQUENTIAL DAMAGES (INCLUDING, BUT NOT LIMITED TO, PROCUREMENT OF SUBSTITUTE GOODS OR SERVICES; LOSS OF USE, DATA, OR PROFITS; OR BUSINESS INTERRUPTION) HOWEVER CAUSED AND ON ANY THEORY OF LIABILITY, WHETHER IN CONTRACT, STRICT LIABILITY, OR TORT (INCLUDING NEGLIGENCE OR OTHERWISE) ARISING IN ANY WAY OUT OF THE USE OF THIS SOFTWARE, EVEN IF ADVISED OF THE POSSIBILITY OF SUCH DAMAGE.

iconv (Charset Conversion Library) v2.0

(28) Artem Bityuckiy (--enable-newlib-iconv)

Copyright (c) 2003, Artem B. Bityuckiy, SoftMine Corporation.
Rights transferred to Franklin Electronic Publishers.

Redistribution and use in source and binary forms, with or without modification, are permitted provided that the following conditions are met:

1. Redistributions of source code must retain the above copyright notice, this list of conditions and the following disclaimer.
2. Redistributions in binary form must reproduce the above copyright notice, this list of conditions and the following disclaimer in the documentation and/or other materials provided with the distribution.

THIS SOFTWARE IS PROVIDED BY THE AUTHOR AND CONTRIBUTORS ``AS IS'' AND ANY EXPRESS OR IMPLIED WARRANTIES, INCLUDING, BUT NOT LIMITED TO, THE IMPLIED WARRANTIES OF MERCHANTABILITY AND FITNESS FOR A PARTICULAR PURPOSE ARE DISCLAIMED. IN NO EVENT SHALL THE AUTHOR OR CONTRIBUTORS BE LIABLE FOR ANY DIRECT, INDIRECT, INCIDENTAL, SPECIAL, EXEMPLARY, OR CONSEQUENTIAL DAMAGES (INCLUDING, BUT NOT LIMITED TO, PROCUREMENT OF SUBSTITUTE GOODS OR SERVICES; LOSS OF USE, DATA, OR PROFITS; OR BUSINESS INTERRUPTION) HOWEVER CAUSED AND ON ANY THEORY OF LIABILITY, WHETHER IN CONTRACT, STRICT LIABILITY, OR TORT (INCLUDING NEGLIGENCE OR OTHERWISE) ARISING IN ANY WAY OUT OF THE USE OF THIS SOFTWARE, EVEN IF ADVISED OF THE POSSIBILITY OF SUCH DAMAGE.

(29) IBM, Sony, Toshiba (only spu-* targets)

(C) Copyright 2001,2006,
International Business Machines Corporation,
Sony Computer Entertainment, Incorporated,
Toshiba Corporation,

All rights reserved.

LICENCE TERMS (cont.)

Redistribution and use in source and binary forms, with or without modification, are permitted provided that the following conditions are met:

- * Redistributions of source code must retain the above copyright notice, this list of conditions and the following disclaimer.
- * Redistributions in binary form must reproduce the above copyright notice, this list of conditions and the following disclaimer in the documentation and/or other materials provided with the distribution.
- * Neither the names of the copyright holders nor the names of their contributors may be used to endorse or promote products derived from this software without specific prior written permission.

THIS SOFTWARE IS PROVIDED BY THE COPYRIGHT HOLDERS AND CONTRIBUTORS "AS IS" AND ANY EXPRESS OR IMPLIED WARRANTIES, INCLUDING, BUT NOT LIMITED TO, THE IMPLIED WARRANTIES OF MERCHANTABILITY AND FITNESS FOR A PARTICULAR PURPOSE ARE DISCLAIMED. IN NO EVENT SHALL THE COPYRIGHT OWNER OR CONTRIBUTORS BE LIABLE FOR ANY DIRECT, INDIRECT, INCIDENTAL, SPECIAL, EXEMPLARY, OR CONSEQUENTIAL DAMAGES (INCLUDING, BUT NOT LIMITED TO, PROCUREMENT OF SUBSTITUTE GOODS OR SERVICES; LOSS OF USE, DATA, OR PROFITS; OR BUSINESS INTERRUPTION) HOWEVER CAUSED AND ON ANY THEORY OF LIABILITY, WHETHER IN CONTRACT, STRICT LIABILITY, OR TORT (INCLUDING NEGLIGENCE OR OTHERWISE) ARISING IN ANY WAY OUT OF THE USE OF THIS SOFTWARE, EVEN IF ADVISED OF THE POSSIBILITY OF SUCH DAMAGE.

(30) - Alex Tatmanjants (targets using libc/posix)

Copyright (c) 1995 Alex Tatmanjants <alex@elvisti.kiev.ua>
at Electronni Visti IA, Kiev, Ukraine.
All rights reserved.

Redistribution and use in source and binary forms, with or without modification, are permitted provided that the following conditions are met:

1. Redistributions of source code must retain the above copyright notice, this list of conditions and the following disclaimer.
2. Redistributions in binary form must reproduce the above copyright notice, this list of conditions and the following disclaimer in the documentation and/or other materials provided with the distribution.

THIS SOFTWARE IS PROVIDED BY THE AUTHOR "AS IS" AND ANY EXPRESS OR IMPLIED WARRANTIES, INCLUDING, BUT NOT LIMITED TO, THE IMPLIED WARRANTIES OF MERCHANTABILITY AND FITNESS FOR A PARTICULAR PURPOSE ARE DISCLAIMED. IN NO EVENT SHALL THE AUTHOR BE LIABLE FOR ANY DIRECT, INDIRECT, INCIDENTAL, SPECIAL, EXEMPLARY, OR CONSEQUENTIAL DAMAGES (INCLUDING, BUT NOT LIMITED TO, PROCUREMENT OF SUBSTITUTE GOODS OR SERVICES; LOSS OF USE, DATA, OR PROFITS; OR BUSINESS INTERRUPTION) HOWEVER CAUSED AND ON ANY THEORY OF LIABILITY, WHETHER IN CONTRACT, STRICT LIABILITY, OR TORT (INCLUDING NEGLIGENCE OR OTHERWISE) ARISING IN ANY WAY OUT OF THE USE OF THIS SOFTWARE, EVEN IF ADVISED OF THE POSSIBILITY OF SUCH DAMAGE.

(31) - M. Warner Losh (targets using libc/posix)

Copyright (c) 1998, M. Warner Losh <imp@freebsd.org>
All rights reserved.

Redistribution and use in source and binary forms, with or without

modification, are permitted provided that the following conditions are met:

1. Redistributions of source code must retain the above copyright notice, this list of conditions and the following disclaimer.
2. Redistributions in binary form must reproduce the above copyright notice, this list of conditions and the following disclaimer in the documentation and/or other materials provided with the distribution.

THIS SOFTWARE IS PROVIDED BY THE AUTHOR AND CONTRIBUTORS "AS IS" AND ANY EXPRESS OR IMPLIED WARRANTIES, INCLUDING, BUT NOT LIMITED TO, THE IMPLIED WARRANTIES OF MERCHANTABILITY AND FITNESS FOR A PARTICULAR PURPOSE ARE DISCLAIMED. IN NO EVENT SHALL THE AUTHOR OR CONTRIBUTORS BE LIABLE FOR ANY DIRECT, INDIRECT, INCIDENTAL, SPECIAL, EXEMPLARY, OR CONSEQUENTIAL DAMAGES (INCLUDING, BUT NOT LIMITED TO, PROCUREMENT OF SUBSTITUTE GOODS OR SERVICES; LOSS OF USE, DATA, OR PROFITS; OR BUSINESS INTERRUPTION) HOWEVER CAUSED AND ON ANY THEORY OF LIABILITY, WHETHER IN CONTRACT, STRICT LIABILITY, OR TORT (INCLUDING NEGLIGENCE OR OTHERWISE) ARISING IN ANY WAY OUT OF THE USE OF THIS SOFTWARE, EVEN IF ADVISED OF THE POSSIBILITY OF SUCH DAMAGE.

(32) - Andrey A. Chernov (targets using libc/posix)

Copyright (C) 1996 by Andrey A. Chernov, Moscow, Russia.
All rights reserved.

Redistribution and use in source and binary forms, with or without modification, are permitted provided that the following conditions are met:

1. Redistributions of source code must retain the above copyright notice, this list of conditions and the following disclaimer.
2. Redistributions in binary form must reproduce the above copyright notice, this list of conditions and the following disclaimer in the documentation and/or other materials provided with the distribution.

THIS SOFTWARE IS PROVIDED BY THE AUTHOR "AS IS" AND ANY EXPRESS OR IMPLIED WARRANTIES, INCLUDING, BUT NOT LIMITED TO, THE IMPLIED WARRANTIES OF MERCHANTABILITY AND FITNESS FOR A PARTICULAR PURPOSE ARE DISCLAIMED. IN NO EVENT SHALL THE REGENTS OR CONTRIBUTORS BE LIABLE FOR ANY DIRECT, INDIRECT, INCIDENTAL, SPECIAL, EXEMPLARY, OR CONSEQUENTIAL DAMAGES (INCLUDING, BUT NOT LIMITED TO, PROCUREMENT OF SUBSTITUTE GOODS OR SERVICES; LOSS OF USE, DATA, OR PROFITS; OR BUSINESS INTERRUPTION) HOWEVER CAUSED AND ON ANY THEORY OF LIABILITY, WHETHER IN CONTRACT, STRICT LIABILITY, OR TORT (INCLUDING NEGLIGENCE OR OTHERWISE) ARISING IN ANY WAY OUT OF THE USE OF THIS SOFTWARE, EVEN IF ADVISED OF THE POSSIBILITY OF SUCH DAMAGE.

(33) - Daniel Eischen (targets using libc/posix)

Copyright (c) 2001 Daniel Eischen <deischen@FreeBSD.org>.
All rights reserved.

Redistribution and use in source and binary forms, with or without modification, are permitted provided that the following conditions are met:

1. Redistributions of source code must retain the above copyright notice, this list of conditions and the following disclaimer.
2. Redistributions in binary form must reproduce the above copyright

LICENCE TERMS (cont.)

notice, this list of conditions and the following disclaimer in the documentation and/or other materials provided with the distribution.

THIS SOFTWARE IS PROVIDED BY THE AUTHOR AND CONTRIBUTORS "AS IS" AND ANY EXPRESS OR IMPLIED WARRANTIES, INCLUDING, BUT NOT LIMITED TO, THE IMPLIED WARRANTIES OF MERCHANTABILITY AND FITNESS FOR A PARTICULAR PURPOSE ARE DISCLAIMED. IN NO EVENT SHALL THE REGENTS OR CONTRIBUTORS BE LIABLE FOR ANY DIRECT, INDIRECT, INCIDENTAL, SPECIAL, EXEMPLARY, OR CONSEQUENTIAL DAMAGES (INCLUDING, BUT NOT LIMITED TO, PROCUREMENT OF SUBSTITUTE GOODS OR SERVICES; LOSS OF USE, DATA, OR PROFITS; OR BUSINESS INTERRUPTION) HOWEVER CAUSED AND ON ANY THEORY OF LIABILITY, WHETHER IN CONTRACT, STRICT LIABILITY, OR TORT (INCLUDING NEGLIGENCE OR OTHERWISE) ARISING IN ANY WAY OUT OF THE USE OF THIS SOFTWARE, EVEN IF ADVISED OF THE POSSIBILITY OF SUCH DAMAGE.

(34) - Jon Beniston (only lm32-* targets)

Contributed by Jon Beniston <jon@beniston.com>

Redistribution and use in source and binary forms, with or without modification, are permitted provided that the following conditions are met:

1. Redistributions of source code must retain the above copyright notice, this list of conditions and the following disclaimer.
2. Redistributions in binary form must reproduce the above copyright notice, this list of conditions and the following disclaimer in the documentation and/or other materials provided with the distribution.

THIS SOFTWARE IS PROVIDED BY THE AUTHOR AND CONTRIBUTORS "AS IS" AND ANY EXPRESS OR IMPLIED WARRANTIES, INCLUDING, BUT NOT LIMITED TO, THE IMPLIED WARRANTIES OF MERCHANTABILITY AND FITNESS FOR A PARTICULAR PURPOSE ARE DISCLAIMED. IN NO EVENT SHALL THE AUTHOR OR CONTRIBUTORS BE LIABLE FOR ANY DIRECT, INDIRECT, INCIDENTAL, SPECIAL, EXEMPLARY, OR CONSEQUENTIAL DAMAGES (INCLUDING, BUT NOT LIMITED TO, PROCUREMENT OF SUBSTITUTE GOODS OR SERVICES; LOSS OF USE, DATA, OR PROFITS; OR BUSINESS INTERRUPTION) HOWEVER CAUSED AND ON ANY THEORY OF LIABILITY, WHETHER IN CONTRACT, STRICT LIABILITY, OR TORT (INCLUDING NEGLIGENCE OR OTHERWISE) ARISING IN ANY WAY OUT OF THE USE OF THIS SOFTWARE, EVEN IF ADVISED OF THE POSSIBILITY OF SUCH DAMAGE.

(35) - ARM Ltd (arm and thumb variant targets only)

Copyright (c) 2009 ARM Ltd
All rights reserved.

Redistribution and use in source and binary forms, with or without modification, are permitted provided that the following conditions are met:

1. Redistributions of source code must retain the above copyright notice, this list of conditions and the following disclaimer.
2. Redistributions in binary form must reproduce the above copyright notice, this list of conditions and the following disclaimer in the documentation and/or other materials provided with the distribution.
3. The name of the company may not be used to endorse or promote products derived from this software without specific prior written

permission.

THIS SOFTWARE IS PROVIDED BY ARM LTD "AS IS" AND ANY EXPRESS OR IMPLIED WARRANTIES, INCLUDING, BUT NOT LIMITED TO, THE IMPLIED WARRANTIES OF MERCHANTABILITY AND FITNESS FOR A PARTICULAR PURPOSE ARE DISCLAIMED. IN NO EVENT SHALL ARM LTD BE LIABLE FOR ANY DIRECT, INDIRECT, INCIDENTAL, SPECIAL, EXEMPLARY, OR CONSEQUENTIAL DAMAGES (INCLUDING, BUT NOT LIMITED TO, PROCUREMENT OF SUBSTITUTE GOODS OR SERVICES; LOSS OF USE, DATA, OR PROFITS; OR BUSINESS INTERRUPTION) HOWEVER CAUSED AND ON ANY THEORY OF LIABILITY, WHETHER IN CONTRACT, STRICT LIABILITY, OR TORT (INCLUDING NEGLIGENCE OR OTHERWISE) ARISING IN ANY WAY OUT OF THE USE OF THIS SOFTWARE, EVEN IF ADVISED OF THE POSSIBILITY OF SUCH DAMAGE.

(36) - Xilinx, Inc. (microblaze-* and powerpc-* targets)

Copyright (c) 2004, 2009 Xilinx, Inc. All rights reserved.

Redistribution and use in source and binary forms, with or without modification, are permitted provided that the following conditions are met:

1. Redistributions source code must retain the above copyright notice, this list of conditions and the following disclaimer.
2. Redistributions in binary form must reproduce the above copyright notice, this list of conditions and the following disclaimer in the documentation and/or other materials provided with the distribution.
3. Neither the name of Xilinx nor the names of its contributors may be used to endorse or promote products derived from this software without specific prior written permission.

THIS SOFTWARE IS PROVIDED BY THE COPYRIGHT HOLDER AND CONTRIBUTORS "AS IS" AND ANY EXPRESS OR IMPLIED WARRANTIES, INCLUDING, BUT NOT LIMITED TO, THE IMPLIED WARRANTIES OF MERCHANTABILITY AND FITNESS FOR A PARTICULAR PURPOSE ARE DISCLAIMED. IN NO EVENT SHALL THE COPYRIGHT HOLDER OR CONTRIBUTORS BE LIABLE FOR ANY DIRECT, INDIRECT, INCIDENTAL, SPECIAL, EXEMPLARY, OR CONSEQUENTIAL DAMAGES (INCLUDING, BUT NOT LIMITED TO, PROCUREMENT OF SUBSTITUTE GOODS OR SERVICES; LOSS OF USE, DATA, OR PROFITS; OR BUSINESS INTERRUPTION) HOWEVER CAUSED AND ON ANY THEORY OF LIABILITY, WHETHER IN CONTRACT, STRICT LIABILITY, OR TORT (INCLUDING NEGLIGENCE OR OTHERWISE) ARISING IN ANY WAY OUT OF THE USE OF THIS SOFTWARE, EVEN IF ADVISED OF THE POSSIBILITY OF SUCH DAMAGE.

(37) Texas Instruments Incorporated (tic6x-*, *-tirtos targets)

Copyright (c) 1996-2010,2014 Texas Instruments Incorporated
<http://www.ti.com/>

Redistribution and use in source and binary forms, with or without modification, are permitted provided that the following conditions are met:

Redistributions of source code must retain the above copyright notice, this list of conditions and the following disclaimer.

LICENCE TERMS (cont.)

Redistributions in binary form must reproduce the above copyright notice, this list of conditions and the following disclaimer in the documentation and/or other materials provided with the distribution.

Neither the name of Texas Instruments Incorporated nor the names of its contributors may be used to endorse or promote products derived from this software without specific prior written permission.

THIS SOFTWARE IS PROVIDED BY THE COPYRIGHT HOLDERS AND CONTRIBUTORS "AS IS" AND ANY EXPRESS OR IMPLIED WARRANTIES, INCLUDING, BUT NOT LIMITED TO, THE IMPLIED WARRANTIES OF MERCHANTABILITY AND FITNESS FOR A PARTICULAR PURPOSE ARE DISCLAIMED. IN NO EVENT SHALL THE COPYRIGHT OWNER OR CONTRIBUTORS BE LIABLE FOR ANY DIRECT, INDIRECT, INCIDENTAL, SPECIAL, EXEMPLARY, OR CONSEQUENTIAL DAMAGES (INCLUDING, BUT NOT LIMITED TO, PROCUREMENT OF SUBSTITUTE GOODS OR SERVICES; LOSS OF USE, DATA, OR PROFITS; OR BUSINESS INTERRUPTION) HOWEVER CAUSED AND ON ANY THEORY OF LIABILITY, WHETHER IN CONTRACT, STRICT LIABILITY, OR TORT (INCLUDING NEGLIGENCE OR OTHERWISE) ARISING IN ANY WAY OUT OF THE USE OF THIS SOFTWARE, EVEN IF ADVISED OF THE POSSIBILITY OF SUCH DAMAGE.

(38) National Semiconductor (cr16-* and crx-* targets)

Copyright (c) 2004 National Semiconductor Corporation

The authors hereby grant permission to use, copy, modify, distribute, and license this software and its documentation for any purpose, provided that existing copyright notices are retained in all copies and that this notice is included verbatim in any distributions. No written agreement, license, or royalty fee is required for any of the authorized uses. Modifications to this software may be copyrighted by their authors and need not follow the licensing terms described here, provided that the new terms are clearly indicated on the first page of each file where they apply.

(39) - Adapteva, Inc. (epiphany-* targets)

Copyright (c) 2011, Adapteva, Inc.
All rights reserved.

Redistribution and use in source and binary forms, with or without modification, are permitted provided that the following conditions are met:

* Redistributions of source code must retain the above copyright notice, this list of conditions and the following disclaimer.

* Redistributions in binary form must reproduce the above copyright notice, this list of conditions and the following disclaimer in the documentation and/or other materials provided with the distribution.

* Neither the name of Adapteva nor the names of its contributors may be used to endorse or promote products derived from this software without specific prior written permission.

THIS SOFTWARE IS PROVIDED BY THE COPYRIGHT HOLDERS AND CONTRIBUTORS "AS IS" AND ANY EXPRESS OR IMPLIED WARRANTIES, INCLUDING, BUT NOT LIMITED TO, THE IMPLIED WARRANTIES OF MERCHANTABILITY AND FITNESS FOR A PARTICULAR PURPOSE ARE DISCLAIMED. IN NO EVENT SHALL THE COPYRIGHT HOLDER OR CONTRIBUTORS BE LIABLE FOR ANY DIRECT, INDIRECT, INCIDENTAL, SPECIAL, EXEMPLARY, OR CONSEQUENTIAL

DAMAGES (INCLUDING, BUT NOT LIMITED TO, PROCUREMENT OF SUBSTITUTE GOODS OR SERVICES; LOSS OF USE, DATA, OR PROFITS; OR BUSINESS INTERRUPTION) HOWEVER CAUSED AND ON ANY THEORY OF LIABILITY, WHETHER IN CONTRACT, STRICT LIABILITY, OR TORT (INCLUDING NEGLIGENCE OR OTHERWISE) ARISING IN ANY WAY OUT OF THE USE OF THIS SOFTWARE, EVEN IF ADVISED OF THE POSSIBILITY OF SUCH DAMAGE.

(40) - Altera Corporation (nios2-* targets)

Copyright (c) 2003 Altera Corporation
All rights reserved.

Redistribution and use in source and binary forms, with or without modification, are permitted provided that the following conditions are met:

o Redistributions of source code must retain the above copyright notice, this list of conditions and the following disclaimer.

o Redistributions in binary form must reproduce the above copyright notice, this list of conditions and the following disclaimer in the documentation and/or other materials provided with the distribution.

o Neither the name of Altera Corporation nor the names of its contributors may be used to endorse or promote products derived from this software without specific prior written permission.

THIS SOFTWARE IS PROVIDED BY ALTERA CORPORATION, THE COPYRIGHT HOLDER, AND ITS CONTRIBUTORS "AS IS" AND ANY EXPRESS OR IMPLIED WARRANTIES, INCLUDING, BUT NOT LIMITED TO, THE IMPLIED WARRANTIES OF MERCHANTABILITY AND FITNESS FOR A PARTICULAR PURPOSE ARE DISCLAIMED. IN NO EVENT SHALL THE COPYRIGHT HOLDER OR CONTRIBUTORS BE LIABLE FOR ANY DIRECT, INDIRECT, INCIDENTAL, SPECIAL, EXEMPLARY, OR CONSEQUENTIAL DAMAGES (INCLUDING, BUT NOT LIMITED TO, PROCUREMENT OF SUBSTITUTE GOODS OR SERVICES; LOSS OF USE, DATA, OR PROFITS; OR BUSINESS INTERRUPTION) HOWEVER CAUSED AND ON ANY THEORY OF LIABILITY, WHETHER IN CONTRACT, STRICT LIABILITY, OR TORT (INCLUDING NEGLIGENCE OR OTHERWISE) ARISING IN ANY WAY OUT OF THE USE OF THIS SOFTWARE, EVEN IF ADVISED OF THE POSSIBILITY OF SUCH DAMAGE.

(41) Ed Schouten - Free BSD

Copyright (c) 2008 Ed Schouten <ed@FreeBSD.org>
All rights reserved.

Redistribution and use in source and binary forms, with or without modification, are permitted provided that the following conditions are met:

1. Redistributions of source code must retain the above copyright notice, this list of conditions and the following disclaimer.

2. Redistributions in binary form must reproduce the above copyright notice, this list of conditions and the following disclaimer in the documentation and/or other materials provided with the distribution.

THIS SOFTWARE IS PROVIDED BY THE AUTHOR AND CONTRIBUTORS "AS IS" AND ANY EXPRESS OR IMPLIED WARRANTIES, INCLUDING, BUT NOT LIMITED TO, THE IMPLIED WARRANTIES OF MERCHANTABILITY AND FITNESS FOR A PARTICULAR PURPOSE ARE DISCLAIMED. IN NO EVENT SHALL THE AUTHOR OR CONTRIBUTORS BE LIABLE FOR ANY DIRECT, INDIRECT, INCIDENTAL, SPECIAL, EXEMPLARY, OR CONSEQUENTIAL DAMAGES (INCLUDING, BUT NOT LIMITED TO, PROCUREMENT OF SUBSTITUTE GOODS OR SERVICES; LOSS OF USE, DATA, OR PROFITS; OR BUSINESS INTERRUPTION)

LICENCE TERMS (cont.)

HOWEVER CAUSED AND ON ANY THEORY OF LIABILITY, WHETHER IN CONTRACT, STRICT LIABILITY, OR TORT (INCLUDING NEGLIGENCE OR OTHERWISE) ARISING IN ANY WAY OUT OF THE USE OF THIS SOFTWARE, EVEN IF ADVISED OF THE POSSIBILITY OF SUCH DAMAGE.

agere_sta_fw.bin -- 9.48 Hermes I
agere_ap_fw.bin -- 9.48 Hermes I

The above firmware images were compiled from the Agere linux driver wl_lkm_718_release.tar.gz, and dumped. The driver is covered by the following copyright and software license.

* SOFTWARE LICENSE

*
* This software is provided subject to the following terms and conditions,
* which you should read carefully before using the software. Using this
* software indicates your acceptance of these terms and conditions. If you do
* not agree with these terms and conditions, do not use the software.
*
* COPYRIGHT © 1994 - 1995 by AT&T. All Rights Reserved
* COPYRIGHT © 1996 - 2000 by Lucent Technologies. All Rights Reserved
* COPYRIGHT © 2001 - 2004 by Agere Systems Inc. All Rights Reserved
* All rights reserved.
*
* Redistribution and use in source or binary forms, with or without
* modifications, are permitted provided that the following conditions are met:
*
* . Redistributions of source code must retain the above copyright notice, this
* list of conditions and the following Disclaimer as comments in the code as
* well as in the documentation and/or other materials provided with the
* distribution.
*
* . Redistributions in binary form must reproduce the above copyright notice,
* this list of conditions and the following Disclaimer in the documentation
* and/or other materials provided with the distribution.
*
* . Neither the name of Agere Systems Inc. nor the names of the contributors
* may be used to endorse or promote products derived from this software
* without specific prior written permission.
*
* Disclaimer
*
* THIS SOFTWARE IS PROVIDED "AS IS" AND ANY EXPRESS OR IMPLIED WARRANTIES,
* INCLUDING, BUT NOT LIMITED TO, INFRINGEMENT AND THE IMPLIED WARRANTIES OF
* MERCHANTABILITY AND FITNESS FOR A PARTICULAR PURPOSE ARE DISCLAIMED. ANY
* USE, MODIFICATION OR DISTRIBUTION OF THIS SOFTWARE IS SOLELY AT THE USERS OWN
* RISK. IN NO EVENT SHALL AGERE SYSTEMS INC. OR CONTRIBUTORS BE LIABLE FOR ANY
* DIRECT, INDIRECT, INCIDENTAL, SPECIAL, EXEMPLARY, OR CONSEQUENTIAL DAMAGES
* (INCLUDING, BUT NOT LIMITED TO, PROCUREMENT OF SUBSTITUTE GOODS OR SERVICES;
* LOSS OF USE, DATA, OR PROFITS; OR BUSINESS INTERRUPTION) HOWEVER CAUSED AND
* ON ANY THEORY OF LIABILITY, INCLUDING, BUT NOT LIMITED TO, CONTRACT, STRICT
* LIABILITY, OR TORT (INCLUDING NEGLIGENCE OR OTHERWISE) ARISING IN ANY WAY OUT
* OF THE USE OF THIS SOFTWARE, EVEN IF ADVISED OF THE POSSIBILITY OF SUCH
* DAMAGE.

The following statement from Agere clarifies the status of the firmware

I would like to confirm that the two drivers; Linux LKM Wireless Driver Source Code, Version 7.18 and Linux LKM Wireless Driver Source Code, Version 7.22 comply with Open Source BSD License. Therefore the source code can be distributed in unmodified or modified form consistent with the terms of the license.

The Linux driver architecture was based on two modules, the MSF (Module specific functions) and the HCF (Hardware Control Functions). Included in the HCF is run-time firmware (binary format) which is downloaded into the RAM of the Hermes 1/2/2.5 WMAC.

This hex coded firmware is not based on any open source software and hence it is not subject to any Open Source License. The firmware was developed by Agere and runs on the DISC processor embedded within the Hermes 1/2/2.5 Wireless MAC devices.

Hope this helps.

Sincerely,

Viren Pathare
Intellectual Property Licensing Manager
Agere

Copyright (C) 2019 Advanced Micro Devices, Inc. All rights reserved.

REDISTRIBUTION: Permission is hereby granted, free of any license fees, to any person obtaining a copy of this microcode (the "Software"), to install, reproduce, copy and distribute copies, in binary form only, of the Software and to permit persons to whom the Software is provided to do the same, provided that the following conditions are met:

No reverse engineering, decompilation, or disassembly of this Software is permitted.

Redistributions must reproduce the above copyright notice, this permission notice, and the following disclaimers and notices in the Software documentation and/or other materials provided with the Software.

DISCLAIMER: THE USE OF THE SOFTWARE IS AT YOUR SOLE RISK. THE SOFTWARE IS PROVIDED "AS IS" AND WITHOUT WARRANTY OF ANY KIND AND COPYRIGHT HOLDER AND ITS LICENSORS EXPRESSLY DISCLAIM ALL WARRANTIES, EXPRESS AND IMPLIED, INCLUDING, BUT NOT LIMITED TO, THE IMPLIED WARRANTIES OF MERCHANTABILITY, FITNESS FOR A PARTICULAR PURPOSE AND NON-INFRINGEMENT. COPYRIGHT HOLDER AND ITS LICENSORS DO NOT WARRANT THAT THE SOFTWARE WILL MEET YOUR REQUIREMENTS, OR THAT THE OPERATION OF THE SOFTWARE WILL BE UNINTERRUPTED OR ERROR-FREE. THE ENTIRE RISK ASSOCIATED WITH THE USE OF THE SOFTWARE IS ASSUMED BY YOU. FURTHERMORE, COPYRIGHT HOLDER AND ITS LICENSORS DO NOT WARRANT OR MAKE ANY REPRESENTATIONS REGARDING THE USE OR THE RESULTS OF THE USE OF THE SOFTWARE IN TERMS OF ITS CORRECTNESS,

LICENCE TERMS (cont.)

ACCURACY, RELIABILITY, CURRENTNESS, OR OTHERWISE.

DISCLAIMER: UNDER NO CIRCUMSTANCES INCLUDING NEGLIGENCE, SHALL COPYRIGHT HOLDER AND ITS LICENSORS OR ITS DIRECTORS, OFFICERS, EMPLOYEES OR AGENTS ("AUTHORIZED REPRESENTATIVES") BE LIABLE FOR ANY INCIDENTAL, INDIRECT, SPECIAL OR CONSEQUENTIAL DAMAGES (INCLUDING DAMAGES FOR LOSS OF BUSINESS PROFITS, BUSINESS INTERRUPTION, LOSS OF BUSINESS INFORMATION, AND THE LIKE) ARISING OUT OF THE USE, MISUSE OR INABILITY TO USE THE SOFTWARE, BREACH OR DEFAULT, INCLUDING THOSE ARISING FROM INFRINGEMENT OR ALLEGED INFRINGEMENT OF ANY PATENT, TRADEMARK, COPYRIGHT OR OTHER INTELLECTUAL PROPERTY RIGHT EVEN IF COPYRIGHT HOLDER AND ITS AUTHORIZED REPRESENTATIVES HAS BEEN ADVISED OF THE POSSIBILITY OF SUCH DAMAGES. IN NO EVENT SHALL COPYRIGHT HOLDER OR ITS AUTHORIZED REPRESENTATIVES TOTAL LIABILITY FOR ALL DAMAGES, LOSSES, AND CAUSES OF ACTION (WHETHER IN CONTRACT, TORT (INCLUDING NEGLIGENCE) OR OTHERWISE) EXCEED THE AMOUNT OF US\$10.

Notice: The Software is subject to United States export laws and regulations. You agree to comply with all domestic and international export laws and regulations that apply to the Software, including but not limited to the Export Administration Regulations administered by the U.S. Department of Commerce and International Traffic in Arm Regulations administered by the U.S. Department of State. These laws include restrictions on destinations, end users and end use.

Copyright (C) 2010-2018 Advanced Micro Devices, Inc., All rights reserved.

Permission is hereby granted by Advanced Micro Devices, Inc. ("AMD"), free of any license fees, to any person obtaining a copy of this microcode in binary form (the "Software") ("You"), to install, reproduce, copy and distribute copies of the Software and to permit persons to whom the Software is provided to do the same, subject to the following terms and conditions. Your use of any portion of the Software shall constitute Your acceptance of the following terms and conditions. If You do not agree to the following terms and conditions, do not use, retain or redistribute any portion of the Software.

If You redistribute this Software, You must reproduce the above copyright notice and this license with the Software.

Without specific, prior, written permission from AMD, You may not reference AMD or AMD products in the promotion of any product derived from or incorporating this Software in any manner that implies that AMD endorses or has certified such product derived from or incorporating this Software.

You may not reverse engineer, decompile, or disassemble this Software or any portion thereof.

THE SOFTWARE IS PROVIDED "AS IS" WITHOUT ANY EXPRESS OR IMPLIED WARRANTY OF ANY KIND, INCLUDING BUT NOT LIMITED TO WARRANTIES OF MERCHANTABILITY, NONINFRINGEMENT, TITLE, FITNESS FOR ANY PARTICULAR PURPOSE, OR WARRANTIES ARISING FROM CONDUCT, COURSE OF DEALING, OR USAGE OF TRADE. IN NO EVENT SHALL AMD OR ITS LICENSORS BE LIABLE FOR ANY DAMAGES WHATSOEVER (INCLUDING, WITHOUT LIMITATION, DAMAGES FOR LOSS OF PROFITS, BUSINESS INTERRUPTION, OR LOSS OF DATA OR

INFORMATION) ARISING OUT OF AMD'S NEGLIGENCE, GROSS NEGLIGENCE, THE USE OF OR INABILITY TO USE THE SOFTWARE, EVEN IF AMD HAS BEEN ADVISED OF THE POSSIBILITY OF SUCH DAMAGES. BECAUSE SOME JURISDICTIONS PROHIBIT THE EXCLUSION OR LIMITATION OF LIABILITY FOR CONSEQUENTIAL OR INCIDENTAL DAMAGES OR THE EXCLUSION OF IMPLIED WARRANTIES, THE ABOVE LIMITATION MAY NOT APPLY TO YOU.

Without limiting the foregoing, the Software may implement third party technologies for which You must obtain licenses from parties other than AMD. You agree that AMD has not obtained or conveyed to You, and that You shall be responsible for obtaining the rights to use and/or distribute the applicable underlying intellectual property rights related to the third party technologies. These third party technologies are not licensed hereunder.

If You use the Software (in whole or in part), You shall adhere to all applicable U.S., European, and other export laws, including but not limited to the U.S. Export Administration Regulations ("EAR"), (15 C.F.R. Sections 730 through 774), and E.U. Council Regulation (EC) No 1334/2000 of 22 June 2000. Further, pursuant to Section 740.6 of the EAR, You hereby certify that, except pursuant to a license granted by the United States Department of Commerce Bureau of Industry and Security or as otherwise permitted pursuant to a License Exception under the U.S. Export Administration Regulations ("EAR"), You will not (1) export, re-export or release to a national of a country in Country Groups D:1, E:1 or E:2 any restricted technology, software, or source code You receive hereunder, or (2) export to Country Groups D:1, E:1 or E:2 the direct product of such technology or software, if such foreign produced direct product is subject to national security controls as identified on the Commerce Control List (currently found in Supplement 1 to Part 774 of EAR). For the most current Country Group listings, or for additional information about the EAR or Your obligations under those regulations, please refer to the U.S. Bureau of Industry and Security's website at <http://www.bis.doc.gov/>.

Amlogic Co., Inc. grants permission to use and redistribute aforementioned firmware files for the use with devices containing Amlogic chipsets, but not as part of the Linux kernel or in any other form which would require these files themselves to be covered by the terms of the GNU General Public License or the GNU Lesser General Public License.

These firmware files are distributed in the hope that they will be useful, but are provided WITHOUT ANY WARRANTY, INCLUDING BUT NOT LIMITED TO IMPLIED WARRANTY OF MERCHANTABILITY OR FITNESS FOR A PARTICULAR PURPOSE.

Amlogic Contact: Arden Jin <Arden.Jin@amlogic.com>

This is a concatenation of LICENCE.txt and NOTICE.txt from the open-ath9k-htc-firmware repository describing licensing terms for the

LICENCE TERMS (cont.)

firmware image and its sources.

The source code repository is publicly available at <https://github.com/qca/open-ath9k-htc-firmware>.

LICENCE.txt

Files with a Qualcomm Atheros / Atheros licence fall under the following licence. Please see NOTICES.TXT for information about other files in this repository.

Copyright (c) 2013 Qualcomm Atheros, Inc.

All rights reserved.

Redistribution and use in source and binary forms, with or without modification, are permitted (subject to the limitations in the disclaimer below) provided that the following conditions are met:

- * Redistributions of source code must retain the above copyright notice, this list of conditions and the following disclaimer.
- * Redistributions in binary form must reproduce the above copyright notice, this list of conditions and the following disclaimer in the documentation and/or other materials provided with the distribution.
- * Neither the name of Qualcomm Atheros nor the names of its contributors may be used to endorse or promote products derived from this software without specific prior written permission.

NO EXPRESS OR IMPLIED LICENSES TO ANY PARTY'S PATENT RIGHTS ARE GRANTED BY THIS LICENSE. THIS SOFTWARE IS PROVIDED BY THE COPYRIGHT HOLDERS AND CONTRIBUTORS "AS IS" AND ANY EXPRESS OR IMPLIED WARRANTIES, INCLUDING, BUT NOT LIMITED TO, THE IMPLIED WARRANTIES OF MERCHANTABILITY AND FITNESS FOR A PARTICULAR PURPOSE ARE DISCLAIMED. IN NO EVENT SHALL THE COPYRIGHT OWNER OR CONTRIBUTORS BE LIABLE FOR ANY DIRECT, INDIRECT, INCIDENTAL, SPECIAL, EXEMPLARY, OR CONSEQUENTIAL DAMAGES (INCLUDING, BUT NOT LIMITED TO, PROCUREMENT OF SUBSTITUTE GOODS OR SERVICES; LOSS OF USE, DATA, OR PROFITS; OR BUSINESS INTERRUPTION) HOWEVER CAUSED AND ON ANY THEORY OF LIABILITY, WHETHER IN CONTRACT, STRICT LIABILITY, OR TORT (INCLUDING NEGLIGENCE OR OTHERWISE) ARISING IN ANY WAY OUT OF THE USE OF THIS SOFTWARE, EVEN IF ADVISED OF THE POSSIBILITY OF SUCH DAMAGE.

NOTICE.TXT

This NOTICE.TXT file contains certain notices of software components included with the software that QUALCOMM ATHEROS Incorporated ('Qualcomm Atheros') is

required to provide you. Notwithstanding anything in the notices in this file, your use of these software components together with the Qualcomm Atheros software (Qualcomm Atheros software hereinafter referred to as 'Software') is subject to the terms of your license from Qualcomm Atheros. Compliance with all copyright laws and software license agreements included in the notice section of this file are the responsibility of the user. Except as may be granted by separate express written agreement, this file provides no license to any Qualcomm Atheros patents, trademarks, copyrights, or other intellectual property.

Copyright (c) 2013 QUALCOMM ATHEROS Incorporated. All rights reserved.

QUALCOMM ATHEROS[®] is a registered trademark and registered service mark of QUALCOMM ATHEROS Incorporated. All other trademarks and service marks are the property of their respective owners.

NOTICES:

/*

* Copyright (c) 2005-2012 Atheros Communications Inc.

*

* Permission to use, copy, modify, and/or distribute this software for any purpose with or without fee is hereby granted, provided that the above copyright notice and this permission notice appear in all copies.

*

* THE SOFTWARE IS PROVIDED "AS IS" AND THE AUTHOR DISCLAIMS ALL WARRANTIES WITH REGARD TO THIS SOFTWARE INCLUDING ALL IMPLIED WARRANTIES OF MERCHANTABILITY AND FITNESS. IN NO EVENT SHALL THE AUTHOR BE LIABLE FOR ANY SPECIAL, DIRECT, INDIRECT, OR CONSEQUENTIAL DAMAGES OR ANY DAMAGES WHATSOEVER RESULTING FROM LOSS OF USE, DATA OR PROFITS, WHETHER IN AN ACTION OF CONTRACT, NEGLIGENCE OR OTHER TORTIOUS ACTION, ARISING OUT OF OR IN CONNECTION WITH THE USE OR PERFORMANCE OF THIS SOFTWARE.

*/

/*

* Copyright (c) 2002-2005 Sam Leffler, Errno Consulting

* Copyright (c) 2002-2005 Atheros Communications, Inc.

* Copyright (c) 2008-2010, Atheros Communications Inc.

*

* Redistribution and use in source and binary forms are permitted provided that the following conditions are met:

* 1. The materials contained herein are unmodified and are used unmodified.

* 2. Redistributions of source code must retain the above copyright notice, this list of conditions and the following NO

* "WARRANTY" disclaimer below ("Disclaimer"), without modification.

* 3. Redistributions in binary form must reproduce at minimum a disclaimer similar to the Disclaimer below and any redistribution

* must be conditioned upon including a substantially similar Disclaimer requirement for further binary redistribution.

* 4. Neither the names of the above-listed copyright holders nor the names of any contributors may be used to endorse or promote

* product derived from this software without specific prior written permission.

*

* NO WARRANTY

LICENCE TERMS (cont.)

* THIS SOFTWARE IS PROVIDED BY THE COPYRIGHT HOLDERS AND CONTRIBUTORS
* "AS IS" AND ANY EXPRESS OR IMPLIED WARRANTIES, INCLUDING, BUT NOT
* LIMITED TO, THE IMPLIED WARRANTIES OF NONINFRINGEMENT,
* MERCHANTABILITY AND FITNESS FOR A PARTICULAR PURPOSE ARE DISCLAIMED.
* IN NO EVENT SHALL THE COPYRIGHT HOLDERS OR CONTRIBUTORS BE LIABLE
* FOR SPECIAL, EXEMPLARY, OR CONSEQUENTIAL DAMAGES (INCLUDING, BUT NOT
* LIMITED TO, PROCUREMENT OF SUBSTITUTE GOODS OR SERVICES; LOSS OF
* USE, DATA, OR PROFITS; OR BUSINESS INTERRUPTION) HOWEVER CAUSED AND
* ON ANY THEORY OF LIABILITY, WHETHER IN CONTRACT, STRICT LIABILITY,
* OR TORT (INCLUDING NEGLIGENCE OR OTHERWISE) ARISING IN ANY WAY OUT
* OF THE USE OF THIS SOFTWARE, EVEN IF ADVISED OF THE POSSIBILITY OF
* SUCH DAMAGES.
*/

The following files are from ECoS with a GPLv2 licence with modification
and linking caveats. Please see the licence below for more information:

```
target_firmware/magpie_fw_dev/build/magpie_1_1/boot/cmnos/printf/src/cmnos_printf.c
target_firmware/magpie_fw_dev/target/cmnos/cmnos_printf.c
target_firmware/magpie_fw_dev/target/cmnos/k2_fw_cmnos_printf.c
```

```
#####ECOSGPLCOPYRIGHTBEGIN#####
// -----
// This file is part of eCos, the Embedded Configurable Operating System.
// Copyright (C) 1998, 1999, 2000, 2001, 2002 Red Hat, Inc.
// Copyright (C) 2002 Gary Thomas
//
// eCos is free software; you can redistribute it and/or modify it under
// the terms of the GNU General Public License as published by the Free
// Software Foundation; either version 2 or (at your option) any later version.
//
// eCos is distributed in the hope that it will be useful, but WITHOUT ANY
// WARRANTY; without even the implied warranty of MERCHANTABILITY or
// FITNESS FOR A PARTICULAR PURPOSE. See the GNU General Public License
// for more details.
//
// You should have received a copy of the GNU General Public License along
// with eCos; if not, write to the Free Software Foundation, Inc.,
// 59 Temple Place, Suite 330, Boston, MA 02111-1307 USA.
//
// As a special exception, if other files instantiate templates or use macros
// or inline functions from this file, or you compile this file and link it
// with other works to produce a work based on this file, this file does not
// by itself cause the resulting work to be covered by the GNU General Public
// License. However the source code for this file must still be made available
// in accordance with section (3) of the GNU General Public License.
//
// This exception does not invalidate any other reasons why a work based on
// this file might be covered by the GNU General Public License.
//
// Alternative licenses for eCos may be arranged by contacting Red Hat, Inc.
// at http://sources.redhat.com/ecos/ecos-license/
// -----
#####ECOSGPLCOPYRIGHTEND#####
```

Some of the source code is sourced from Tensilica, Inc.

Although most of the files fall under the MIT licence, some of the source
files generated as part of the system development have a proprietary
Tensilica licence.

With permission from Tensilica, Inc, these files have been relicenced
under the following licence:

```
/*
 * Copyright (c) 2013 Tensilica Inc.
 *
 * Permission is hereby granted, free of charge, to any person obtaining
 * a copy of this software and associated documentation files (the
 * "Software"), to deal in the Software without restriction, including
 * without limitation the rights to use, copy, modify, merge, publish,
 * distribute, sublicense, and/or sell copies of the Software, and to
 * permit persons to whom the Software is furnished to do so, subject to
 * the following conditions:
 *
 * The above copyright notice and this permission notice shall be included
 * in all copies or substantial portions of the Software.
 *
 * THE SOFTWARE IS PROVIDED "AS IS", WITHOUT WARRANTY OF ANY KIND,
 * EXPRESS OR IMPLIED, INCLUDING BUT NOT LIMITED TO THE WARRANTIES OF
 * MERCHANTABILITY, FITNESS FOR A PARTICULAR PURPOSE AND NONINFRINGEMENT.
 * IN NO EVENT SHALL THE AUTHORS OR COPYRIGHT HOLDERS BE LIABLE FOR ANY
 * CLAIM, DAMAGES OR OTHER LIABILITY, WHETHER IN AN ACTION OF CONTRACT,
 * TORT OR OTHERWISE, ARISING FROM, OUT OF OR IN CONNECTION WITH THE
 * SOFTWARE OR THE USE OR OTHER DEALINGS IN THE SOFTWARE.
 */
```

Copyright (c) 2008-2010, Atheros Communications, Inc.
All rights reserved.

Redistribution. Redistribution and use in binary form, without
modification, are permitted provided that the following conditions are
met:

- * Redistributions must reproduce the above copyright notice and the
following disclaimer in the documentation and/or other materials
provided with the distribution.
- * Neither the name of Atheros Communications, Inc. nor the names of
its suppliers may be used to endorse or promote products derived
from this software without specific prior written permission.
- * No reverse engineering, decompilation, or disassembly of this
software is permitted.

Limited patent license. Atheros Communications, Inc. grants a
world-wide, royalty-free, non-exclusive license under patents it
now or hereafter owns or controls to make, have made, use, import,

LICENCE TERMS (cont.)

offer to sell and sell ("Utilize") this software, but solely to the extent that any such patent is necessary to Utilize the software in conjunction with an Atheros Chipset. The patent license shall not apply to any other combinations which include this software. No hardware per se is licensed hereunder.

DISCLAIMER. THIS SOFTWARE IS PROVIDED BY THE COPYRIGHT HOLDERS AND CONTRIBUTORS "AS IS" AND ANY EXPRESS OR IMPLIED WARRANTIES, INCLUDING, BUT NOT LIMITED TO, THE IMPLIED WARRANTIES OF MERCHANTABILITY AND FITNESS FOR A PARTICULAR PURPOSE ARE DISCLAIMED. IN NO EVENT SHALL THE COPYRIGHT OWNER OR CONTRIBUTORS BE LIABLE FOR ANY DIRECT, INDIRECT, INCIDENTAL, SPECIAL, EXEMPLARY, OR CONSEQUENTIAL DAMAGES (INCLUDING, BUT NOT LIMITED TO, PROCUREMENT OF SUBSTITUTE GOODS OR SERVICES; LOSS OF USE, DATA, OR PROFITS; OR BUSINESS INTERRUPTION) HOWEVER CAUSED AND ON ANY THEORY OF LIABILITY, WHETHER IN CONTRACT, STRICT LIABILITY, OR TORT (INCLUDING NEGLIGENCE OR OTHERWISE) ARISING IN ANY WAY OUT OF THE USE OF THIS SOFTWARE, EVEN IF ADVISED OF THE POSSIBILITY OF SUCH DAMAGE.

Copyright (C) 2015 Atmel Corporation. All rights reserved.

REDISTRIBUTION: Permission is hereby granted by Atmel Corporation (Atmel), free of any license fees, to any person obtaining a copy of this firmware (the "Software"), to install, reproduce, copy and distribute copies, in binary form, in hexadecimal or equivalent formats, of the Software and to permit persons to whom the Software is provided to do the same, subject to the following conditions:

- * Any redistribution of the Software must reproduce the above copyright notice, this license notice, and the following disclaimers and notices in the documentation and/or other materials provided with the Software.
- * Neither the name of Atmel Corporation, its products nor the names of its suppliers may be used to endorse or promote products derived from this Software without specific prior written permission.
- * All matters arising out of or in connection with this License and/or Software shall be governed by California law and the parties agree to the exclusive jurisdiction of the Californian courts to decide all disputes arising.
- * The licensee shall defend and indemnify Atmel against any and all claims, costs, losses and damages (including reasonable legal fees) incurred by tme arising out of any claim relating to the Software due to the licensee's use or sub-licensing of the Software

DISCLAIMER: THIS SOFTWARE IS PROVIDED BY ATMEL "AS IS" AND ANY EXPRESS OR IMPLIED WARRANTIES, INCLUDING, BUT NOT LIMITED TO, THE IMPLIED WARRANTIES OF MERCHANTABILITY, FITNESS FOR A PARTICULAR PURPOSE AND NON-INFRINGEMENT ARE DISCLAIMED. IN NO EVENT SHALL ATMEL BE LIABLE FOR ANY DIRECT, INDIRECT, INCIDENTAL, SPECIAL, EXEMPLARY, OR CONSEQUENTIAL DAMAGES (INCLUDING, BUT NOT LIMITED TO, PROCUREMENT OF SUBSTITUTE GOODS OR SERVICES; LOSS OF USE, DATA, OR PROFITS; OR BUSINESS INTERRUPTION) HOWEVER CAUSED AND ON ANY THEORY OF LIABILITY, WHETHER IN CONTRACT, STRICT LIABILITY, OR TORT (INCLUDING NEGLIGENCE OR OTHERWISE) ARISING IN ANY WAY OUT OF THE USE OF THIS SOFTWARE, EVEN IF ADVISED OF THE POSSIBILITY OF SUCH DAMAGE.

SOFTWARE LICENSE AGREEMENT

The accompanying software in binary code form ("Software"), is licensed to you, or, if you are accepting on behalf of an entity, the entity and its affiliates exercising rights hereunder ("Licensee") subject to the terms of this software license agreement ("Agreement"), unless Licensee and Broadcom Corporation ("Broadcom") execute a separate written software license agreement governing use of the Software. ANY USE, REPRODUCTION, OR DISTRIBUTION OF THE SOFTWARE CONSTITUTES LICENSEE'S ACCEPTANCE OF THIS AGREEMENT.

1. License. Subject to the terms and conditions of this Agreement, Broadcom hereby grants to Licensee a limited, non-exclusive, non-transferable, royalty-free license: (i) to use and integrate the Software with any other software; and (ii) to reproduce and distribute the Software complete, unmodified, and as provided by Broadcom, solely for use with Broadcom proprietary integrated circuit product(s) sold by Broadcom with which the Software was designed to be used, or their successors.
2. Restrictions. Licensee shall distribute Software with a copy of this Agreement. Licensee shall not remove, efface or obscure any copyright or trademark notices from the Software. Reproductions of the Broadcom copyright notice shall be included with each copy of the Software, except where such Software is embedded in a manner not readily accessible to the end user. Licensee shall not: (i) use, license, sell or otherwise distribute the Software except as provided in this Agreement; (ii) attempt to modify in any way, reverse engineer, decompile or disassemble any portion of the Software; or (iii) use the Software or other material in violation of any applicable law or regulation, including but not limited to any regulatory agency. This Agreement shall automatically terminate upon Licensee's failure to comply with any of the terms of this Agreement. In such event, Licensee will destroy all copies of the Software and its component parts.
3. Ownership. The Software is licensed and not sold. Title to and ownership of the Software, including all intellectual property rights thereto, and any portion thereof remain with Broadcom or its licensors. Licensee hereby covenants that it will not assert any claim that the Software created by or for Broadcom infringe any intellectual property right owned or controlled by Licensee.
4. Disclaimer. THE SOFTWARE IS OFFERED "AS IS," AND BROADCOM PROVIDES AND GRANTS AND LICENSEE RECEIVES NO SUPPORT AND NO WARRANTIES OF ANY KIND, EXPRESS OR IMPLIED, BY STATUTE, COMMUNICATION OR CONDUCT WITH LICENSEE, OR OTHERWISE. BROADCOM SPECIFICALLY DISCLAIMS ANY IMPLIED WARRANTIES OF MERCHANTABILITY, FITNESS FOR A SPECIFIC PURPOSE, OR NONINFRINGEMENT CONCERNING THE SOFTWARE OR ANY UPGRADES TO OR DOCUMENTATION FOR THE SOFTWARE. WITHOUT LIMITATION OF THE ABOVE, BROADCOM GRANTS NO WARRANTY THAT THE SOFTWARE IS ERROR-FREE OR WILL OPERATE WITHOUT INTERRUPTION, AND GRANTS NO WARRANTY REGARDING ITS USE OR THE RESULTS THEREFROM INCLUDING, WITHOUT LIMITATION, ITS CORRECTNESS, ACCURACY, OR RELIABILITY. TO THE MAXIMUM EXTENT PERMITTED BY LAW, IN NO EVENT SHALL BROADCOM OR ANY OF ITS LICENSORS HAVE ANY LIABILITY FOR ANY DIRECT, INDIRECT, INCIDENTAL, SPECIAL, OR CONSEQUENTIAL DAMAGES, HOWEVER CAUSED AND ON ANY THEORY OF LIABILITY, WHETHER FOR BREACH OF CONTRACT, TORT (INCLUDING NEGLIGENCE) OR OTHERWISE, ARISING OUT OF THIS AGREEMENT OR USE, REPRODUCTION, OR DISTRIBUTION OF THE SOFTWARE, INCLUDING BUT NOT LIMITED TO LOSS OF DATA AND LOSS OF PROFITS, EVEN IF SUCH PARTY HAS BEEN ADVISED OF THE POSSIBILITY OF SUCH DAMAGES. THESE

LICENCE TERMS (cont.)

LIMITATIONS SHALL APPLY NOTWITHSTANDING ANY FAILURE OF ESSENTIAL PURPOSE OF ANY LIMITED REMEDY.

5. Export Laws. LICENSEE UNDERSTANDS AND AGREES THAT THE SOFTWARE IS SUBJECT TO UNITED STATES AND OTHER APPLICABLE EXPORT-RELATED LAWS AND REGULATIONS AND THAT LICENSEE MAY NOT EXPORT, RE-EXPORT OR TRANSFER THE SOFTWARE OR ANY DIRECT PRODUCT OF THE SOFTWARE EXCEPT AS PERMITTED UNDER THOSE LAWS. WITHOUT LIMITING THE FOREGOING, EXPORT, RE-EXPORT, OR TRANSFER OF THE SOFTWARE TO CUBA, IRAN, NORTH KOREA, SUDAN, AND SYRIA IS PROHIBITED.

Copyright (c) 2012, Creative Technology Ltd
All rights reserved.

Redistribution. Redistribution and use in binary form, without modification, are permitted provided that the following conditions are met:

- * Redistributions must reproduce the above copyright notice and the following disclaimer in the documentation and/or other materials provided with the distribution.
- * Neither the name of Creative Technology Ltd or its affiliates ("CTL") nor the names of its suppliers may be used to endorse or promote products derived from this software without specific prior written permission.
- * No reverse engineering, decompilation, or disassembly of this software (or any part thereof) is permitted.

Limited patent license. CTL grants a limited, world-wide, royalty-free, non-exclusive license under patents it now or hereafter owns or controls to make, have made, use, import, offer to sell and sell ("Utilize") this software, but strictly only to the extent that any such patent is necessary to Utilize the software alone, or in combination with an operating system licensed under an approved Open Source license as listed by the Open Source Initiative at <http://opensource.org/licenses>. The patent license shall not be applicable, to any other combinations which include this software. No hardware per se is licensed hereunder.

DISCLAIMER. THIS SOFTWARE IS PROVIDED BY THE COPYRIGHT HOLDERS AND CONTRIBUTORS "AS IS" AND ANY EXPRESS OR IMPLIED WARRANTIES, INCLUDING, BUT NOT LIMITED TO, THE IMPLIED WARRANTIES OF MERCHANTABILITY AND FITNESS FOR A PARTICULAR PURPOSE ARE DISCLAIMED. IN NO EVENT SHALL THE COPYRIGHT OWNER OR CONTRIBUTORS BE LIABLE FOR ANY DIRECT, INDIRECT, INCIDENTAL, SPECIAL, EXEMPLARY, OR CONSEQUENTIAL DAMAGES (INCLUDING, BUT NOT LIMITED TO, PROCUREMENT OF SUBSTITUTE GOODS OR SERVICES; LOSS OF USE, DATA, OR PROFITS; OR BUSINESS INTERRUPTION) HOWEVER CAUSED AND ON ANY THEORY OF LIABILITY, WHETHER IN CONTRACT, STRICT LIABILITY, OR TORT (INCLUDING NEGLIGENCE OR OTHERWISE) ARISING IN ANY WAY OUT OF THE USE OF THIS SOFTWARE, EVEN IF ADVISED OF THE POSSIBILITY OF SUCH DAMAGE.

NO OTHER RIGHTS GRANTED. USER HEREBY ACKNOWLEDGES AND AGREES THAT USE OF THIS SOFTWARE SHALL NOT CREATE OR GIVE GROUNDS FOR A LICENSE BY IMPLICATION, ESTOPPEL, OR OTHERWISE TO ANY INTELLECTUAL PROPERTY RIGHTS (PATENT, COPYRIGHT, TRADE SECRET, MASK WORK, OR OTHER PROPRIETARY RIGHT)

EMBODIED IN ANY OTHER CTL HARDWARE OR SOFTWARE WHETHER SOLELY OR IN COMBINATION WITH THIS SOFTWARE.

Copyright © 2015, Cavium, Inc. All rights reserved.

Software License Agreement

ANY USE, REPRODUCTION, OR DISTRIBUTION OF THE ACCOMPANYING BINARY SOFTWARE CONSTITUTES LICENSEE'S ACCEPTANCE OF THE TERMS AND CONDITIONS OF THIS AGREEMENT.

Licensed Software. Subject to the terms and conditions of this Agreement, Cavium, Inc. ("Cavium") grants to Licensee a worldwide, non-exclusive, and royalty-free license to use, reproduce, and distribute the binary software in its complete and unmodified form as provided by Cavium.

Restrictions. Licensee must reproduce the Cavium copyright notice above with each binary software copy. Licensee must not reverse engineer, decompile, disassemble or modify in any way the binary software. Licensee must not use the binary software in violation of any applicable law or regulation. This Agreement shall automatically terminate upon Licensee's breach of any term or condition of this Agreement in which case, Licensee shall destroy all copies of the binary software.

Warranty Disclaimer. THE LICENSED SOFTWARE IS OFFERED "AS IS," AND CAVIUM GRANTS AND LICENSEE RECEIVES NO WARRANTIES OF ANY KIND, WHETHER EXPRESS, IMPLIED, STATUTORY, OR BY COURSE OF COMMUNICATION OR DEALING WITH LICENSEE, OR OTHERWISE. CAVIUM AND ITS LICENSORS SPECIFICALLY DISCLAIM ANY IMPLIED WARRANTIES OF MERCHANTABILITY, FITNESS FOR A PARTICULAR PURPOSE, TITLE, OR NONINFRINGEMENT OF THIRD PARTY RIGHTS, CONCERNING THE LICENSED SOFTWARE, DERIVATIVE WORKS, OR ANY DOCUMENTATION PROVIDED WITH THE FOREGOING. WITHOUT LIMITING THE GENERALITY OF THE FOREGOING, CAVIUM DOES NOT WARRANT THAT THE LICENSED SOFTWARE IS ERROR-FREE OR WILL OPERATE WITHOUT INTERRUPTION, AND CAVIUM GRANTS NO WARRANTY REGARDING ITS USE OR THE RESULTS THEREFROM, INCLUDING ITS CORRECTNESS, ACCURACY, OR RELIABILITY.

Limitation of Liability. IN NO EVENT WILL LICENSEE, CAVIUM, OR ANY OF CAVIUM'S LICENSORS HAVE ANY LIABILITY HEREUNDER FOR ANY INDIRECT, SPECIAL, OR CONSEQUENTIAL DAMAGES, HOWEVER CAUSED AND ON ANY THEORY OF LIABILITY, WHETHER FOR BREACH OF CONTRACT, TORT (INCLUDING NEGLIGENCE), OR OTHERWISE, ARISING OUT OF THIS AGREEMENT, INCLUDING DAMAGES FOR LOSS OF PROFITS, OR THE COST OF PROCUREMENT OF SUBSTITUTE GOODS, EVEN IF SUCH PARTY HAS BEEN ADVISED OF THE POSSIBILITY OF SUCH DAMAGES.

Export and Import Laws. Licensee acknowledges and agrees that the Licensed Software (including technical data and related technology) may be controlled by the export control laws, rules, regulations, restrictions and national security controls of the United States and other applicable foreign agencies (the "Export Controls"), and agrees not export or re-export, or allow the export or re-export of export-controlled the Licensed Software (including technical data and related technology) or any copy, portion or direct product of the foregoing in violation of the Export Controls. Licensee hereby represents that (i) Licensee is not an entity or person to whom provision of the Licensed Software (including technical data and related technology) is restricted or prohibited by the Export Controls; and (ii) Licensee will not export, re-export or otherwise transfer the export-controlled Licensed Software (including

LICENCE TERMS (cont.)

technical data and related technology) in violation of U.S. sanction programs or export control regulations to (a) any country, or national or resident of any country, subject to a United States trade embargo, (b) any person or entity to whom shipment is restricted or prohibited by the Export Controls, or (c) anyone who is engaged in activities related to the design, development, production, or use of nuclear materials, nuclear facilities, nuclear weapons, missiles or chemical or biological weapons.

Copyright (c) 2011 Chelsio Communications
All rights reserved.

Chelsio Communication Terminator 4/5 ethernet controller firmware

Redistribution and use in binary form, without modification, are permitted provided that the following conditions are met:

1. Redistribution in binary form must reproduce the above copyright notice, this list of conditions and the following disclaimer in the documentation and/or other materials provided with the distribution.
2. The name of Chelsio Communications may not be used to endorse or promote products derived from this software without specific prior written permission.
3. Reverse engineering, decompilation, or disassembly of this firmware is not permitted.

DISCLAIMER. THIS SOFTWARE IS PROVIDED BY THE COPYRIGHT HOLDERS AND CONTRIBUTORS "AS IS" AND ANY EXPRESS OR IMPLIED WARRANTIES, INCLUDING, BUT NOT LIMITED TO, THE IMPLIED WARRANTIES OF MERCHANTABILITY AND FITNESS FOR A PARTICULAR PURPOSE ARE DISCLAIMED. IN NO EVENT SHALL THE COPYRIGHT OWNER OR CONTRIBUTORS BE LIABLE FOR ANY DIRECT, INDIRECT, INCIDENTAL, SPECIAL, EXEMPLARY, OR CONSEQUENTIAL DAMAGES (INCLUDING, BUT NOT LIMITED TO, PROCUREMENT OF SUBSTITUTE GOODS OR SERVICES; LOSS OF USE, DATA, OR PROFITS; OR BUSINESS INTERRUPTION) HOWEVER CAUSED AND ON ANY THEORY OF LIABILITY, WHETHER IN CONTRACT, STRICT LIABILITY, OR TORT (INCLUDING NEGLIGENCE OR OTHERWISE) ARISING IN ANY WAY OUT OF THE USE OF THIS SOFTWARE, EVEN IF ADVISED OF THE POSSIBILITY OF SUCH DAMAGE.

Copyright (c) 2007-2013, ST Microelectronics NV.
All rights reserved.

Redistribution. Redistribution and use in binary form, without modification, are permitted provided that the following conditions are met:

* Redistributions must reproduce the above copyright notice and the following disclaimer in the documentation and/or other materials provided with the distribution.

* Neither the name of ST Microelectronics NV. nor the names of its suppliers may be used to endorse or promote products derived from this software without specific prior written permission.

* No reverse engineering, decompilation, or disassembly of this software is permitted.

Limited patent license. ST Microelectronics NV. grants a world-wide, royalty-free, non-exclusive license under patents it now or hereafter owns or controls to make, have made, use, import, offer to sell and sell ("Utilize") this software, but solely to the extent that any such patent is necessary to Utilize the software in conjunction with an ST Microelectronics chipset. The patent license shall not apply to any other combinations which include this software. No hardware per se is licensed hereunder.

DISCLAIMER. THIS SOFTWARE IS PROVIDED BY THE COPYRIGHT HOLDERS AND CONTRIBUTORS "AS IS" AND ANY EXPRESS OR IMPLIED WARRANTIES, INCLUDING, BUT NOT LIMITED TO, THE IMPLIED WARRANTIES OF MERCHANTABILITY AND FITNESS FOR A PARTICULAR PURPOSE ARE DISCLAIMED. IN NO EVENT SHALL THE COPYRIGHT OWNER OR CONTRIBUTORS BE LIABLE FOR ANY DIRECT, INDIRECT, INCIDENTAL, SPECIAL, EXEMPLARY, OR CONSEQUENTIAL DAMAGES (INCLUDING, BUT NOT LIMITED TO, PROCUREMENT OF SUBSTITUTE GOODS OR SERVICES; LOSS OF USE, DATA, OR PROFITS; OR BUSINESS INTERRUPTION) HOWEVER CAUSED AND ON ANY THEORY OF LIABILITY, WHETHER IN CONTRACT, STRICT LIABILITY, OR TORT (INCLUDING NEGLIGENCE OR OTHERWISE) ARISING IN ANY WAY OUT OF THE USE OF THIS SOFTWARE, EVEN IF ADVISED OF THE POSSIBILITY OF SUCH DAMAGE.

CYPRESS WIRELESS CONNECTIVITY DEVICES
DRIVER END USER LICENSE AGREEMENT (SOURCE AND BINARY DISTRIBUTION)

PLEASE READ THIS END USER LICENSE AGREEMENT ("Agreement") CAREFULLY BEFORE DOWNLOADING, INSTALLING, OR USING THIS SOFTWARE, ANY ACCOMPANYING DOCUMENTATION, OR ANY UPDATES PROVIDED BY CYPRESS ("Software"). BY DOWNLOADING, INSTALLING, OR USING THE SOFTWARE, YOU ARE AGREEING TO BE BOUND BY THIS AGREEMENT. IF YOU DO NOT AGREE TO ALL OF THE TERMS OF THIS AGREEMENT, PROMPTLY RETURN AND DO NOT USE THE SOFTWARE. IF YOU HAVE PURCHASED THE SOFTWARE, YOUR RIGHT TO RETURN THE SOFTWARE EXPIRES 30 DAYS AFTER YOUR PURCHASE AND APPLIES ONLY TO THE ORIGINAL PURCHASER.

Software Provided in Binary Code Form. This paragraph applies to any Software provided in binary code form. Subject to the terms and conditions of this Agreement, Cypress Semiconductor Corporation ("Cypress") grants you a non-exclusive, non-transferable license under its copyright rights in the Software to reproduce and distribute the Software in object code form only, solely for use in connection with Cypress integrated circuit products ("Purpose").

Software Provided in Source Code Form. This paragraph applies to any Software provided in source code form ("Cypress Source Code"). Subject to the terms and conditions of this Agreement, Cypress grants you a non-exclusive, non-transferable license under its copyright rights in the Cypress Source Code to reproduce, modify, compile, and distribute the Cypress Source Code (whether in source code form or as compiled into binary code form) solely for the Purpose. Cypress retains ownership of the Cypress Source Code and any compiled version thereof. Subject to Cypress' ownership of the underlying Cypress Source Code, you retain ownership of any modifications you make to the Cypress Source Code. You agree not to remove any Cypress copyright or other notices from the Cypress Source Code and any modifications thereof. Any reproduction, modification, translation, compilation, or representation of the Cypress Source Code except as permitted in this paragraph is prohibited without the express written permission of Cypress.

Free and Open Source Software. Portions of the Software may be licensed under

LICENCE TERMS (cont.)

free and/or open source licenses such as the GNU General Public License ("FOSS"). FOSS is subject to the applicable license agreement and not this Agreement. If you are entitled to receive the source code from Cypress for any FOSS included with the Software, either the source code will be included with the Software or you may obtain the source code at no charge from <<http://www.cypress.com/go/opensource>>. The applicable license terms will accompany each source code package. To review the license terms applicable to any FOSS for which Cypress is not required to provide you with source code, please see the Software's installation directory on your computer.

Proprietary Rights. The Software, including all intellectual property rights therein, is and will remain the sole and exclusive property of Cypress or its suppliers. Except as otherwise expressly provided in this Agreement, you may not: (i) modify, adapt, or create derivative works based upon the Software; (ii) copy the Software; (iii) except and only to the extent explicitly permitted by applicable law despite this limitation, decompile, translate, reverse engineer, disassemble or otherwise reduce the Software to human-readable form; or (iv) use the Software other than for the Purpose.

No Support. Cypress may, but is not required to, provide technical support for the Software.

Term and Termination. This Agreement is effective until terminated. This Agreement and Your license rights will terminate immediately without notice from Cypress if you fail to comply with any provision of this Agreement. Upon termination, you must destroy all copies of Software in your possession or control. Termination of this Agreement will not affect any licenses validly granted as of the termination date to any end users of the Software. The following paragraphs shall survive any termination of this Agreement: "Free and Open Source Software," "Proprietary Rights," "Compliance With Law," "Disclaimer," "Limitation of Liability," and "General."

Compliance With Law. Each party agrees to comply with all applicable laws, rules and regulations in connection with its activities under this Agreement. Without limiting the foregoing, the Software may be subject to export control laws and regulations of the United States and other countries. You agree to comply strictly with all such laws and regulations and acknowledge that you have the responsibility to obtain licenses to export, re-export, or import the Software.

Disclaimer. TO THE MAXIMUM EXTENT PERMITTED BY APPLICABLE LAW, CYPRESS MAKES NO WARRANTY OF ANY KIND, EXPRESS OR IMPLIED, WITH REGARD TO THE SOFTWARE, INCLUDING, BUT NOT LIMITED TO, INFRINGEMENT AND THE IMPLIED WARRANTIES OF MERCHANTABILITY AND FITNESS FOR A PARTICULAR PURPOSE. Cypress reserves the right to make changes to the Software without notice. Cypress does not assume any liability arising out of the application or use of Software or any product or circuit described in the Software. Cypress does not authorize its products for use as critical components in life-support systems where a malfunction or failure may reasonably be expected to result in significant injury to the user. The inclusion of Cypress' product in a life-support system or application implies that the manufacturer of such system or application assumes all risk of such use and in doing so indemnifies Cypress against all charges.

Limitation of Liability. IN NO EVENT WILL CYPRESS OR ITS SUPPLIERS, RESELLERS, OR DISTRIBUTORS BE LIABLE FOR ANY LOST REVENUE, PROFIT, OR DATA, OR FOR SPECIAL, INDIRECT, CONSEQUENTIAL, INCIDENTAL, OR PUNITIVE DAMAGES

HOWEVER CAUSED AND REGARDLESS OF THE THEORY OF LIABILITY, ARISING OUT OF THE USE OF OR INABILITY TO USE THE SOFTWARE EVEN IF CYPRESS OR ITS SUPPLIERS, RESELLERS, OR DISTRIBUTORS HAVE BEEN ADVISED OF THE POSSIBILITY OF SUCH DAMAGES. IN NO EVENT SHALL CYPRESS' OR ITS SUPPLIERS' RESELLERS', OR DISTRIBUTORS' TOTAL LIABILITY TO YOU, WHETHER IN CONTRACT, TORT (INCLUDING NEGLIGENCE), OR OTHERWISE, EXCEED THE PRICE PAID BY YOU FOR THE SOFTWARE. THE FOREGOING LIMITATIONS SHALL APPLY EVEN IF THE ABOVE-STATED WARRANTY FAILS OF ITS ESSENTIAL PURPOSE. BECAUSE SOME STATES OR JURISDICTIONS DO NOT ALLOW LIMITATION OR EXCLUSION OF CONSEQUENTIAL OR INCIDENTAL DAMAGES, THE ABOVE LIMITATION MAY NOT APPLY TO YOU.

Restricted Rights. The Software under this Agreement is commercial computer software as that term is described in 48 C.F.R. 252.227-7014(a)(1). If acquired by or on behalf of a civilian agency, the U.S. Government acquires this commercial computer software and/or commercial computer software documentation subject to the terms of this Agreement as specified in 48 C.F.R. 12.212 (Computer Software) and 12.211 (Technical Data) of the Federal Acquisition Regulations ("FAR") and its successors. If acquired by or on behalf of any agency within the Department of Defense ("DOD"), the U.S. Government acquires this commercial computer software and/or commercial computer software documentation subject to the terms of this Agreement as specified in 48 C.F.R. 227.7202-3 of the DOD FAR Supplement ("DFAR") and its successors.

General. This Agreement will bind and inure to the benefit of each party's successors and assigns, provided that you may not assign or transfer this Agreement, in whole or in part, without Cypress' written consent. This Agreement shall be governed by and construed in accordance with the laws of the State of California, United States of America, as if performed wholly within the state and without giving effect to the principles of conflict of law. The parties consent to personal and exclusive jurisdiction of and venue in, the state and federal courts within Santa Clara County, California; provided however, that nothing in this Agreement will limit Cypress' right to bring legal action in any venue in order to protect or enforce its intellectual property rights. No failure of either party to exercise or enforce any of its rights under this Agreement will act as a waiver of such rights. If any portion hereof is found to be void or unenforceable, the remaining provisions of this Agreement shall remain in full force and effect. This Agreement is the complete and exclusive agreement between the parties with respect to the subject matter hereof, superseding and replacing any and all prior agreements, communications, and understandings (both written and oral) regarding such subject matter. Any notice to Cypress will be deemed effective when actually received and must be sent to Cypress Semiconductor Corporation, ATTN: Chief Legal Officer, 198 Champion Court, San Jose, CA 95134 USA.

Firmware provided by Patrick Boettcher <pboettcher@dibcom.fr> to Devin Heitmueller <dheitmueller@kernellabs.com> on October 8, 2009.

The USB firmware file "dvh-usb-dib0700.1.20.fw" for DiBcom's DiB0700, used together with the Linux driver module dvh-usb-dib0700, is provided under the following licensing terms:

Copyright (c) 2009, DiBcom

LICENCE TERMS (cont.)

Permission to use, copy, modify, and/or distribute this software for any purpose with or without fee is hereby granted, provided that the above copyright notice and this permission notice appear in all copies.

THE SOFTWARE IS PROVIDED "AS IS" AND THE AUTHOR DISCLAIMS ALL WARRANTIES WITH REGARD TO THIS SOFTWARE INCLUDING ALL IMPLIED WARRANTIES OF MERCHANTABILITY AND FITNESS. IN NO EVENT SHALL THE AUTHOR BE LIABLE FOR ANY SPECIAL, DIRECT, INDIRECT, OR CONSEQUENTIAL DAMAGES OR ANY DAMAGES WHATSOEVER RESULTING FROM LOSS OF USE, DATA OR PROFITS, WHETHER IN AN ACTION OF CONTRACT, NEGLIGENCE OR OTHER TORTIOUS ACTION, ARISING OUT OF OR IN CONNECTION WITH THE USE OR PERFORMANCE OF THIS SOFTWARE.

Copyright (c) 1999-2001, Intel Corporation

All rights reserved.

Redistribution and use in source and binary forms, with or without modification, are permitted provided that the following conditions are met:

1. Redistributions of source code must retain the above copyright notice, this list of conditions and the following disclaimer.
2. Redistributions in binary form must reproduce the above copyright notice, this list of conditions and the following disclaimer in the documentation and/or other materials provided with the distribution.
3. Neither the name of Intel Corporation nor the names of its contributors may be used to endorse or promote products derived from this software without specific prior written permission.

THIS SOFTWARE IS PROVIDED BY THE COPYRIGHT HOLDERS AND CONTRIBUTORS "AS IS" AND ANY EXPRESS OR IMPLIED WARRANTIES, INCLUDING, BUT NOT LIMITED TO, THE IMPLIED WARRANTIES OF MERCHANTABILITY AND FITNESS FOR A PARTICULAR PURPOSE ARE DISCLAIMED. IN NO EVENT SHALL CONTRIBUTORS BE LIABLE FOR ANY DIRECT, INDIRECT, INCIDENTAL, SPECIAL, EXEMPLARY, OR CONSEQUENTIAL DAMAGES (INCLUDING, BUT NOT LIMITED TO, PROCUREMENT OF SUBSTITUTE GOODS OR SERVICES; LOSS OF USE, DATA, OR PROFITS; OR BUSINESS INTERRUPTION) HOWEVER CAUSED AND ON ANY THEORY OF LIABILITY, WHETHER IN CONTRACT, STRICT LIABILITY, OR TORT (INCLUDING NEGLIGENCE OR OTHERWISE) ARISING IN ANY WAY OUT OF THE USE OF THIS SOFTWARE, EVEN IF ADVISED OF THE POSSIBILITY OF SUCH DAMAGE.

copyright (c) 2011, ENE TECHNOLOGY INC.

Permission to use, copy, modify, and/or distribute this software for any purpose with or without fee is hereby granted, provided that the above copyright notice and this permission notice appear in all copies.

THE SOFTWARE IS PROVIDED "AS IS" AND THE AUTHOR DISCLAIMS ALL WARRANTIES WITH REGARD TO THIS SOFTWARE INCLUDING ALL IMPLIED WARRANTIES OF MERCHANTABILITY AND FITNESS. IN NO EVENT SHALL THE AUTHOR BE LIABLE FOR ANY SPECIAL, DIRECT, INDIRECT, OR

CONSEQUENTIAL DAMAGES OR ANY DAMAGES WHATSOEVER RESULTING FROM LOSS OF USE, DATA OR PROFITS, WHETHER IN AN ACTION OF CONTRACT, NEGLIGENCE OR OTHER TORTIOUS ACTION, ARISING OUT OF OR IN CONNECTION WITH THE USE OR PERFORMANCE OF THIS SOFTWARE.

Copyright (c) 2015, Intel Corporation.
All rights reserved.

Redistribution.

Redistribution and use in binary form, without modification, are permitted provided that the following conditions are met:

- * Redistributions must reproduce the above copyright notice and the following disclaimer in the documentation and/or other materials provided with the distribution.
- * Neither the name of Intel Corporation nor the names of its suppliers may be used to endorse or promote products derived from this software without specific prior written permission.
- * No reverse engineering, decompilation, or disassembly of this software is permitted.

Limited patent license.

Intel Corporation grants a world-wide, royalty-free, non-exclusive license under patents it now or hereafter owns or controls to make, have made, use, import, offer to sell and sell ("Utilize") this software, but solely to the extent that any such patent is necessary to Utilize the software alone. The patent license shall not apply to any combinations which include this software. No hardware per se is licensed hereunder.

DISCLAIMER.

THIS SOFTWARE IS PROVIDED BY THE COPYRIGHT HOLDERS AND CONTRIBUTORS "AS IS" AND ANY EXPRESS OR IMPLIED WARRANTIES, INCLUDING, BUT NOT LIMITED TO, THE IMPLIED WARRANTIES OF MERCHANTABILITY AND FITNESS FOR A PARTICULAR PURPOSE ARE DISCLAIMED. IN NO EVENT SHALL THE COPYRIGHT OWNER OR CONTRIBUTORS BE LIABLE FOR ANY DIRECT, INDIRECT, INCIDENTAL, SPECIAL, EXEMPLARY, OR CONSEQUENTIAL DAMAGES (INCLUDING, BUT NOT LIMITED TO, PROCUREMENT OF SUBSTITUTE GOODS OR SERVICES; LOSS OF USE, DATA, OR PROFITS; OR BUSINESS INTERRUPTION) HOWEVER CAUSED AND ON ANY THEORY OF LIABILITY, WHETHER IN CONTRACT, STRICT LIABILITY, OR TORT (INCLUDING NEGLIGENCE OR OTHERWISE) ARISING IN ANY WAY OUT OF THE USE OF THIS SOFTWARE, EVEN IF ADVISED OF THE POSSIBILITY OF SUCH DAMAGE.

Copyright (c) 2015, Intel Corporation.
All rights reserved.

Redistribution. Redistribution and use in binary form, without modification, are permitted provided that the following conditions are met:

- * Redistributions must reproduce the above copyright notice and the following disclaimer in the documentation and/or other materials

LICENCE TERMS (cont.)

provided with the distribution.

- * Neither the name of Intel Corporation nor the names of its suppliers may be used to endorse or promote products derived from this software without specific prior written permission.
- * No reverse engineering, decompilation, or disassembly of this software is permitted.

Limited patent license. Intel Corporation grants a world-wide, royalty-free, non-exclusive license under patents it now or hereafter owns or controls to make, have made, use, import, offer to sell and sell ("Utilize") this software, but solely to the extent that any such patent is necessary to Utilize the software alone, or in combination with an operating system licensed under an approved Open Source license as listed by the Open Source Initiative at <http://opensource.org/licenses>. The patent license shall not apply to any other combinations which include this software. No hardware per se is licensed hereunder.

DISCLAIMER. THIS SOFTWARE IS PROVIDED BY THE COPYRIGHT HOLDERS AND CONTRIBUTORS "AS IS" AND ANY EXPRESS OR IMPLIED WARRANTIES, INCLUDING, BUT NOT LIMITED TO, THE IMPLIED WARRANTIES OF MERCHANTABILITY AND FITNESS FOR A PARTICULAR PURPOSE ARE DISCLAIMED. IN NO EVENT SHALL THE COPYRIGHT OWNER OR CONTRIBUTORS BE LIABLE FOR ANY DIRECT, INDIRECT, INCIDENTAL, SPECIAL, EXEMPLARY, OR CONSEQUENTIAL DAMAGES (INCLUDING, BUT NOT LIMITED TO, PROCUREMENT OF SUBSTITUTE GOODS OR SERVICES; LOSS OF USE, DATA, OR PROFITS; OR BUSINESS INTERRUPTION) HOWEVER CAUSED AND ON ANY THEORY OF LIABILITY, WHETHER IN CONTRACT, STRICT LIABILITY, OR TORT (INCLUDING NEGLIGENCE OR OTHERWISE) ARISING IN ANY WAY OUT OF THE USE OF THIS SOFTWARE, EVEN IF ADVISED OF THE POSSIBILITY OF SUCH DAMAGE.

Copyright (c) 2008, Intel Corporation.

All rights reserved.

Redistribution.

Redistribution and use in binary form, without modification, are permitted provided that the following conditions are met:

- * Redistributions must reproduce the above copyright notice and the following disclaimer in the documentation and/or other materials provided with the distribution.
- * Neither the name of Intel Corporation nor the names of its suppliers may be used to endorse or promote products derived from this software without specific prior written permission.
- * No reverse engineering, decompilation, or disassembly of this software is permitted.

Limited patent license.

Intel Corporation grants a world-wide, royalty-free, non-exclusive license under patents it now or hereafter owns or controls to make,

have made, use, import, offer to sell and sell ("Utilize") this software, but solely to the extent that any such patent is necessary to Utilize the software alone. The patent license shall not apply to any combinations which include this software. No hardware per se is licensed hereunder.

DISCLAIMER.

THIS SOFTWARE IS PROVIDED BY THE COPYRIGHT HOLDERS AND CONTRIBUTORS "AS IS" AND ANY EXPRESS OR IMPLIED WARRANTIES, INCLUDING, BUT NOT LIMITED TO, THE IMPLIED WARRANTIES OF MERCHANTABILITY AND FITNESS FOR A PARTICULAR PURPOSE ARE DISCLAIMED. IN NO EVENT SHALL THE COPYRIGHT OWNER OR CONTRIBUTORS BE LIABLE FOR ANY DIRECT, INDIRECT, INCIDENTAL, SPECIAL, EXEMPLARY, OR CONSEQUENTIAL DAMAGES (INCLUDING, BUT NOT LIMITED TO, PROCUREMENT OF SUBSTITUTE GOODS OR SERVICES; LOSS OF USE, DATA, OR PROFITS; OR BUSINESS INTERRUPTION) HOWEVER CAUSED AND ON ANY THEORY OF LIABILITY, WHETHER IN CONTRACT, STRICT LIABILITY, OR TORT (INCLUDING NEGLIGENCE OR OTHERWISE) ARISING IN ANY WAY OUT OF THE USE OF THIS SOFTWARE, EVEN IF ADVISED OF THE POSSIBILITY OF SUCH DAMAGE.

Copyright © 2014, Intel Corporation.
All rights reserved.

Redistribution. Redistribution and use in binary form, without modification, are permitted provided that the following conditions are met:

- * Redistributions must reproduce the above copyright notice and the following disclaimer in the documentation and/or other materials provided with the distribution.
- * Neither the name of Intel Corporation nor the names of its suppliers may be used to endorse or promote products derived from this software without specific prior written permission.
- * No reverse engineering, decompilation, or disassembly of this software is permitted.

Limited patent license. Intel Corporation grants a world-wide, royalty-free, non-exclusive license under patents it now or hereafter owns or controls to make, have made, use, import, offer to sell and sell ("Utilize") this software, but solely to the extent that any such patent is necessary to Utilize the software alone, or in combination with an operating system licensed under an approved Open Source license as listed by the Open Source Initiative at <http://opensource.org/licenses>. The patent license shall not apply to any other combinations which include this software. No hardware per se is licensed hereunder.

DISCLAIMER. THIS SOFTWARE IS PROVIDED BY THE COPYRIGHT HOLDERS AND CONTRIBUTORS "AS IS" AND ANY EXPRESS OR IMPLIED WARRANTIES, INCLUDING, BUT NOT LIMITED TO, THE IMPLIED WARRANTIES OF MERCHANTABILITY AND FITNESS FOR A PARTICULAR PURPOSE ARE DISCLAIMED. IN NO EVENT SHALL THE COPYRIGHT OWNER OR CONTRIBUTORS BE LIABLE FOR ANY DIRECT, INDIRECT, INCIDENTAL, SPECIAL, EXEMPLARY, OR CONSEQUENTIAL DAMAGES (INCLUDING, BUT NOT LIMITED TO, PROCUREMENT OF SUBSTITUTE GOODS OR SERVICES; LOSS OF USE, DATA, OR PROFITS; OR BUSINESS INTERRUPTION) HOWEVER CAUSED AND

LICENCE TERMS (cont.)

ON ANY THEORY OF LIABILITY, WHETHER IN CONTRACT, STRICT LIABILITY, OR TORT (INCLUDING NEGLIGENCE OR OTHERWISE) ARISING IN ANY WAY OUT OF THE USE OF THIS SOFTWARE, EVEN IF ADVISED OF THE POSSIBILITY OF SUCH DAMAGE.

Copyright 2017, NXP
All rights reserved.

Redistribution. Reproduction and redistribution in binary form, without modification, for use solely in conjunction with a NXP chipset, is permitted provided that the following conditions are met:

- . Redistributions must reproduce the above copyright notice and the following disclaimer in the documentation and/or other materials provided with the distribution.
- . Neither the name of NXP nor the names of its suppliers may be used to endorse or promote products derived from this Software without specific prior written permission.
- . No reverse engineering, decompilation, or disassembly of this Software is permitted.

Limited patent license. NXP (.Licensor.) grants you (.Licensee.) a limited, worldwide, royalty-free, non-exclusive license under the Patents to make, have made, use, import, offer to sell and sell the Software. No hardware per se is licensed hereunder. The term .Patents. as used in this agreement means only those patents or patent applications owned solely and exclusively by Licensor as of the date of Licensor's submission of the Software and any patents deriving priority (i.e., having a first effective filing date) therefrom. The term .Software. as used in this agreement means the firmware image submitted by Licensor, under the terms of this license, to [git://git.kernel.org/pub/scm/linux/kernel/git/firmware/linux-firmware.git](http://git.kernel.org/pub/scm/linux/kernel/git/firmware/linux-firmware.git). Notwithstanding anything to the contrary herein, Licensor does not grant and Licensee does not receive, by virtue of this agreement or the Licensor's submission of any Software, any license or other rights under any patent or patent application owned by any affiliate of Licensor or any other entity (other than Licensor), whether expressly, impliedly, by virtue of estoppel or exhaustion, or otherwise.

DISCLAIMER. THIS SOFTWARE IS PROVIDED BY THE COPYRIGHT HOLDERS AND CONTRIBUTORS "AS IS" AND ANY EXPRESS OR IMPLIED WARRANTIES, INCLUDING, BUT NOT LIMITED TO, THE IMPLIED WARRANTIES OF MERCHANTABILITY AND FITNESS FOR A PARTICULAR PURPOSE ARE DISCLAIMED. IN NO EVENT SHALL THE COPYRIGHT OWNER OR CONTRIBUTORS BE LIABLE FOR ANY DIRECT, INDIRECT, INCIDENTAL, SPECIAL, EXEMPLARY, OR CONSEQUENTIAL DAMAGES (INCLUDING, BUT NOT LIMITED TO, PROCUREMENT OF SUBSTITUTE GOODS OR SERVICES; LOSS OF USE, DATA, OR PROFITS; OR BUSINESS INTERRUPTION) HOWEVER CAUSED AND ON ANY THEORY OF LIABILITY, WHETHER IN CONTRACT, STRICT LIABILITY, OR TORT (INCLUDING NEGLIGENCE OR OTHERWISE) ARISING IN ANY WAY OUT OF THE USE OF THIS SOFTWARE, EVEN IF ADVISED OF THE POSSIBILITY OF SUCH DAMAGE.

Copyright (c) 2014, Intel Corporation.
All rights reserved.

Redistribution. Redistribution and use in binary form, without modification, are permitted provided that the following conditions are met:

- * Redistributions must reproduce the above copyright notice and the following disclaimer in the documentation and/or other materials provided with the distribution.
- * Neither the name of Intel Corporation nor the names of its suppliers may be used to endorse or promote products derived from this software without specific prior written permission.
- * No reverse engineering, decompilation, or disassembly of this software is permitted.

Limited patent license. Intel Corporation grants a world-wide, royalty-free, non-exclusive license under patents it now or hereafter owns or controls to make, have made, use, import, offer to sell and sell ("Utilize") this software, but solely to the extent that any such patent is necessary to Utilize the software alone, or in combination with an operating system licensed under an approved Open Source license as listed by the Open Source Initiative at <http://opensource.org/licenses>. The patent license shall not apply to any other combinations which include this software. No hardware per se is licensed hereunder.

DISCLAIMER. THIS SOFTWARE IS PROVIDED BY THE COPYRIGHT HOLDERS AND CONTRIBUTORS "AS IS" AND ANY EXPRESS OR IMPLIED WARRANTIES, INCLUDING, BUT NOT LIMITED TO, THE IMPLIED WARRANTIES OF MERCHANTABILITY AND FITNESS FOR A PARTICULAR PURPOSE ARE DISCLAIMED. IN NO EVENT SHALL THE COPYRIGHT OWNER OR CONTRIBUTORS BE LIABLE FOR ANY DIRECT, INDIRECT, INCIDENTAL, SPECIAL, EXEMPLARY, OR CONSEQUENTIAL DAMAGES (INCLUDING, BUT NOT LIMITED TO, PROCUREMENT OF SUBSTITUTE GOODS OR SERVICES; LOSS OF USE, DATA, OR PROFITS; OR BUSINESS INTERRUPTION) HOWEVER CAUSED AND ON ANY THEORY OF LIABILITY, WHETHER IN CONTRACT, STRICT LIABILITY, OR TORT (INCLUDING NEGLIGENCE OR OTHERWISE) ARISING IN ANY WAY OUT OF THE USE OF THIS SOFTWARE, EVEN IF ADVISED OF THE POSSIBILITY OF SUCH DAMAGE.

Copyright (c) 2014, ITE Tech. Inc.

The firmware files "dvh-usb-it9135-01.fw" and "dvh-usb-it9135-02.fw" are for ITEtech it9135 Ax and Bx chip versions.

Permission to use, copy, modify, and/or distribute this software for any purpose with or without fee is hereby granted, provided that the above copyright notice and this permission notice appear in all copies.

THE SOFTWARE IS PROVIDED "AS IS" AND THE AUTHOR DISCLAIMS ALL WARRANTIES WITH REGARD TO THIS SOFTWARE INCLUDING ALL IMPLIED WARRANTIES OF MERCHANTABILITY AND FITNESS. IN NO EVENT SHALL THE AUTHOR BE LIABLE FOR ANY SPECIAL, DIRECT, INDIRECT, OR CONSEQUENTIAL DAMAGES OR ANY DAMAGES WHATSOEVER RESULTING FROM LOSS OF USE, DATA OR PROFITS, WHETHER IN AN ACTION OF CONTRACT, NEGLIGENCE OR OTHER TORTIOUS ACTION,

LICENCE TERMS (cont.)

ARISING OUT OF OR IN CONNECTION WITH THE USE OR PERFORMANCE OF THIS SOFTWARE.

Copyright (c) 2006-2015, Intel Corporation.
All rights reserved.

Redistribution. Redistribution and use in binary form, without modification, are permitted provided that the following conditions are met:

- * Redistributions must reproduce the above copyright notice and the following disclaimer in the documentation and/or other materials provided with the distribution.
- * Neither the name of Intel Corporation nor the names of its suppliers may be used to endorse or promote products derived from this software without specific prior written permission.
- * No reverse engineering, decompilation, or disassembly of this software is permitted.

Limited patent license. Intel Corporation grants a world-wide, royalty-free, non-exclusive license under patents it now or hereafter owns or controls to make, have made, use, import, offer to sell and sell ("Utilize") this software, but solely to the extent that any such patent is necessary to Utilize the software alone, or in combination with an operating system licensed under an approved Open Source license as listed by the Open Source Initiative at <http://opensource.org/licenses>. The patent license shall not apply to any other combinations which include this software. No hardware per se is licensed hereunder.

DISCLAIMER. THIS SOFTWARE IS PROVIDED BY THE COPYRIGHT HOLDERS AND CONTRIBUTORS "AS IS" AND ANY EXPRESS OR IMPLIED WARRANTIES, INCLUDING, BUT NOT LIMITED TO, THE IMPLIED WARRANTIES OF MERCHANTABILITY AND FITNESS FOR A PARTICULAR PURPOSE ARE DISCLAIMED. IN NO EVENT SHALL THE COPYRIGHT OWNER OR CONTRIBUTORS BE LIABLE FOR ANY DIRECT, INDIRECT, INCIDENTAL, SPECIAL, EXEMPLARY, OR CONSEQUENTIAL DAMAGES (INCLUDING, BUT NOT LIMITED TO, PROCUREMENT OF SUBSTITUTE GOODS OR SERVICES; LOSS OF USE, DATA, OR PROFITS; OR BUSINESS INTERRUPTION) HOWEVER CAUSED AND ON ANY THEORY OF LIABILITY, WHETHER IN CONTRACT, STRICT LIABILITY, OR TORT (INCLUDING NEGLIGENCE OR OTHERWISE) ARISING IN ANY WAY OUT OF THE USE OF THIS SOFTWARE, EVEN IF ADVISED OF THE POSSIBILITY OF SUCH DAMAGE.

Copyright 1999 Kawasaki LSI.

Redistribution and use in source and binary forms, with or without modification, are permitted provided that the following conditions are met:

1. Redistributions of source code must retain the above copyright notice, this list of conditions and the following disclaimer.
2. Redistributions in binary form must reproduce the above copyright notice, this list of conditions and the following disclaimer in the documentation and/or other materials provided with the distribution.

3. All advertising materials mentioning features or use of this software must display the following acknowledgement:

This product includes software developed by Kawasaki LSI.

4. Neither the name of the company nor the names of its contributors may be used to endorse or promote products derived from this software without specific prior written permission.

THIS SOFTWARE IS PROVIDED BY KAWASAKI LSI "AS IS" AND ANY EXPRESS OR IMPLIED WARRANTIES, INCLUDING, BUT NOT LIMITED TO, THE IMPLIED WARRANTIES OF MERCHANTABILITY AND FITNESS FOR A PARTICULAR PURPOSE ARE DISCLAIMED. IN NO EVENT SHALL KAWASAKI LSI BE LIABLE FOR ANY DIRECT, INDIRECT, INCIDENTAL, SPECIAL, EXEMPLARY, OR CONSEQUENTIAL DAMAGES (INCLUDING, BUT NOT LIMITED TO, PROCUREMENT OF SUBSTITUTE GOODS OR SERVICES; LOSS OF USE, DATA, OR PROFITS; OR BUSINESS INTERRUPTION) HOWEVER CAUSED AND ON ANY THEORY OF LIABILITY, WHETHER IN CONTRACT, STRICT LIABILITY, OR TORT (INCLUDING NEGLIGENCE OR OTHERWISE) ARISING IN ANY WAY OUT OF THE USE OF THIS SOFTWARE, EVEN IF ADVISED OF THE POSSIBILITY OF SUCH DAMAGE.

Copyright © 2019. Marvell International Ltd. All rights reserved.

Redistribution and use in binary form is permitted provided that the following conditions are met:

1. Redistributions must reproduce the above copyright notice, this list of conditions and the following disclaimer in the documentation and/or other materials provided with the distribution.
2. Redistribution and use shall be used only with Marvell silicon products. Any other use, reproduction, modification, translation, or compilation of the Software is prohibited.
3. No reverse engineering, decompilation, or disassembly is permitted.

TO THE MAXIMUM EXTENT PERMITTED BY APPLICABLE LAW, THIS SOFTWARE IS PROVIDED "AS IS" WITHOUT WARRANTY OF ANY KIND, INCLUDING, WITHOUT LIMITATION, ANY EXPRESS OR IMPLIED WARRANTIES OF MERCHANTABILITY, ACCURACY, FITNESS OR SUFFICIENCY FOR A PARTICULAR PURPOSE, SATISFACTORY QUALITY, CORRESPONDENCE WITH DESCRIPTION, QUIET ENJOYMENT OR NON-INFRINGEMENT OF THIRD PARTY INTELLECTUAL PROPERTY RIGHTS. MARVELL, ITS AFFILIATES AND THEIR SUPPLIERS DISCLAIM ANY WARRANTY THAT THE DELIVERABLES WILL OPERATE WITHOUT INTERRUPTION OR BE ERROR-FREE.

The software accompanying this license statement (the "Software") is the property of Moxa Inc. (the "Moxa"), and is protected by United States and International Copyright Laws and International treaty provisions. No ownership rights are granted by this Agreement or possession of the Software. Therefore, you must treat the Licensed Software like any other copyrighted material. Your rights and obligations in its use are described as follows:

1. You may freely redistribute this software under this license.
2. You may freely download and use this software on Moxa's device.
3. You may not modify or attempt to reverse engineer the software, or

LICENCE TERMS (cont.)

make any attempt to change or even examine the source code of the software.

4. You may not re-license or sub-license the software to any person or business, using any other license.
5. Moxa(r) is worldwide registered trademark.

Copyright (c) 2006-2010, Myricom Inc.
All rights reserved.

Redistribution and use in source and binary forms, with or without modification, are permitted provided that the following conditions are met:

1. Redistributions of source code must retain the above copyright notice, this list of conditions and the following disclaimer.
2. Neither the name of the Myricom Inc, nor the names of its contributors may be used to endorse or promote products derived from this software without specific prior written permission.

THIS SOFTWARE IS PROVIDED BY THE COPYRIGHT HOLDERS AND CONTRIBUTORS "AS IS" AND ANY EXPRESS OR IMPLIED WARRANTIES, INCLUDING, BUT NOT LIMITED TO, THE IMPLIED WARRANTIES OF MERCHANTABILITY AND FITNESS FOR A PARTICULAR PURPOSE ARE DISCLAIMED. IN NO EVENT SHALL THE COPYRIGHT OWNER OR CONTRIBUTORS BE LIABLE FOR ANY DIRECT, INDIRECT, INCIDENTAL, SPECIAL, EXEMPLARY, OR CONSEQUENTIAL DAMAGES (INCLUDING, BUT NOT LIMITED TO, PROCUREMENT OF SUBSTITUTE GOODS OR SERVICES; LOSS OF USE, DATA, OR PROFITS; OR BUSINESS INTERRUPTION) HOWEVER CAUSED AND ON ANY THEORY OF LIABILITY, WHETHER IN CONTRACT, STRICT LIABILITY, OR TORT (INCLUDING NEGLIGENCE OR OTHERWISE) ARISING IN ANY WAY OUT OF THE USE OF THIS SOFTWARE, EVEN IF ADVISED OF THE POSSIBILITY OF SUCH DAMAGE.

Copyright (c) 2017, NETRONOME Systems, Inc. All rights reserved.

Agilio(r) Firmware License Agreement (the "AGREEMENT")

BY INSTALLING OR USING IN ANY MANNER THE SOFTWARE THAT ACCOMPANIES THIS AGREEMENT (THE "SOFTWARE") YOU (THE "LICENSEE") ACKNOWLEDGE TO BE BOUND BY ALL OF THE TERMS OF THIS AGREEMENT.

LICENSE GRANT. Subject to the terms and conditions set forth herein, Netronome Systems, Inc. ("NETRONOME") hereby grants LICENSEE a non-exclusive license to use, reproduce and distribute the SOFTWARE exclusively in object form.

Restrictions. LICENSEE agrees that, (a) unless explicitly provided by NETRONOME, the source code of the SOFTWARE is not being provided to LICENSEE and is confidential and proprietary to NETRONOME and that LICENSEE has no right to access or use such source code. Accordingly, LICENSEE agrees that it shall not cause or permit the disassembly, decompilation or reverse engineering of the SOFTWARE or otherwise attempt to gain access to the source code for the SOFTWARE; and (b) LICENSEE agrees that it shall not subject the SOFTWARE in whole or in part, to the terms of any software license that requires, as a condition of use,

modification and/or distribution that the source code of the SOFTWARE, or the SOFTWARE be i) disclosed or distributed in source code form; ii) licensed for the purpose of making derivative works of the source code of the SOFTWARE; or iii) redistribution of the source code of the SOFTWARE at no charge.

DISCLAIMER OF ALL WARRANTIES. THE SOFTWARE IS PROVIDED "AS IS" AND WITH ALL FAULTS AND NETRONOME AND ITS LICENSORS HEREBY DISCLAIM ALL EXPRESS OR IMPLIED WARRANTIES OF ANY KIND, INCLUDING, WITHOUT LIMITATION, ANY WARRANTIES OF MERCHANTABILITY, NON-INFRINGEMENT AND FITNESS FOR A PARTICULAR PURPOSE.

LIMITATIONS OF LIABILITY. EXCEPT WHERE PROHIBITED BY LAW, IN NO EVENT SHALL NETRONOME OR ANY OTHER PARTY INVOLVED IN THE CREATION, PRODUCTION, OR DELIVERY OF THE SOFTWARE BE LIABLE FOR ANY LOSS OF PROFITS, DATA, USE OF THE SOFTWARE, DOCUMENTATION OR EQUIPMENT, OR FOR ANY SPECIAL, INCIDENTAL, CONSEQUENTIAL, EXEMPLARY, PUNITIVE, MULTIPLE OR OTHER DAMAGES, ARISING FROM OR IN CONNECTION WITH THE SOFTWARE EVEN IF NETRONOME OR ITS LICENSORS HAVE BEEN MADE AWARE OF THE POSSIBILITY OF SUCH DAMAGES AND NOTWITHSTANDING ANY FAILURE OF ESSENTIAL PURPOSE OF ANY LIMITED REMEDY.

EXPORT COMPLIANCE. LICENSEE shall not use or export or transmit the SOFTWARE, directly or indirectly, to any restricted countries or in any other manner that would violate any applicable US and other export control and other regulations and laws as shall from time to time govern the delivery, license and use of technology, including without limitation the Export Administration Act of 1979, as amended, and any regulations issued thereunder.

PROHIBITION OF SOFTWARE USE IN HIGH RISK ACTIVITIES AND LIFE SUPPORT APPLICATIONS. The SOFTWARE is not designed, manufactured or intended for use as on-line control equipment in hazardous environments requiring fail-safe performance, such as in the operation of nuclear facilities, aircraft navigation or communications systems, air traffic control, life support systems, human implantation or any other application where product failure could lead to loss of life or catastrophic property damage or weapons systems, in which the failure of the SOFTWARE could lead directly to death, personal injury, or severe physical or environmental damage ("High Risk Activities"). Accordingly NETRONOME and, where applicable, NETRONOME'S third party licensors specifically disclaim any express or implied warranty of fitness for High Risk Activities.

License For Customer Use of NVIDIA Software

IMPORTANT NOTICE -- READ CAREFULLY: This License For Customer Use of NVIDIA Software ("LICENSE") is the agreement which governs use of the software of NVIDIA Corporation and its subsidiaries ("NVIDIA") downloadable herefrom, including computer software and associated printed materials ("SOFTWARE"). By downloading, installing, copying, or otherwise using the SOFTWARE, you agree to be bound by the terms of this LICENSE. If you do not agree to the terms of this LICENSE, do not download the SOFTWARE.

RECITALS

Use of NVIDIA's products requires three elements: the SOFTWARE, the hardware, and a personal computer. The SOFTWARE is protected by copyright laws and international copyright treaties, as well as other intellectual property laws and treaties. The SOFTWARE may be protected by various patents, and is not sold, and instead is only licensed for use, strictly in accordance with this document. The hardware is protected by various patents, and is sold, but this agreement does not cover that sale, since it may not necessarily be sold as a package with the SOFTWARE. This agreement sets forth the terms and conditions of the SOFTWARE LICENSE only.

1. DEFINITIONS

1.1 Customer. Customer means the entity or individual that downloads or otherwise obtains the SOFTWARE.

2. GRANT OF LICENSE

2.1 Rights and Limitations of Grant. NVIDIA hereby grants Customer the following non-exclusive, non-transferable right to use the SOFTWARE, with the following limitations:

2.1.1 Rights. Customer may install and use multiple copies of the SOFTWARE on a shared computer or concurrently on different computers, and make multiple back-up copies of the SOFTWARE, solely for Customer's use within Customer's Enterprise. "Enterprise" shall mean individual use by Customer or any legal entity (such as a corporation or university) and the subsidiaries it owns by more than fifty percent (50%).

2.1.2 Open Source Exception. Notwithstanding the foregoing terms of Section 2.1.1, SOFTWARE may be copied and redistributed solely for use on operating systems distributed under the terms of an OSI-approved open source license as listed by the Open Source Initiative at <http://opensource.org>, provided that the binary files thereof are not modified, and Customer provides a copy of this license with the SOFTWARE.

2.1.3 Limitations.

No Reverse Engineering. Customer may not reverse engineer, decompile, or disassemble the SOFTWARE, nor attempt in any other manner to obtain the source code.

Usage. SOFTWARE is licensed only for use with microprocessor(s) which have been (i) designed by NVIDIA and (ii) either (a) sold by or (b) licensed by NVIDIA. Customer shall not use SOFTWARE in conjunction with, nor cause SOFTWARE to be executed by, any other microprocessor.

No Translation. Customer shall not translate SOFTWARE, nor cause or permit SOFTWARE to be translated, from the architecture or language in which it is originally provided by NVIDIA, into any other architecture or language.

No Rental. Customer may not rent or lease the SOFTWARE to someone else.

3. TERMINATION

This LICENSE will automatically terminate if Customer fails to comply with any of the terms and conditions hereof. In such event, Customer must destroy all copies of the SOFTWARE and all of its component parts.

Defensive Suspension. If Customer commences or participates in any legal proceeding against NVIDIA, then NVIDIA may, in its sole discretion, suspend or terminate all license grants and any other rights provided under this LICENSE during the pendency of such legal proceedings.

4. COPYRIGHT

All title and copyrights in and to the SOFTWARE (including but not limited to all images, photographs, animations, video, audio, music, text, and other information incorporated into the SOFTWARE), the accompanying printed materials, and any copies of the SOFTWARE, are owned by NVIDIA, or its suppliers. The SOFTWARE is protected by copyright laws and international treaty provisions. Accordingly, Customer is required to treat the SOFTWARE like any other copyrighted material, except as otherwise allowed pursuant to this LICENSE and that it may make one copy of the SOFTWARE solely for backup or archive purposes.

5. APPLICABLE LAW

This agreement shall be deemed to have been made in, and shall be construed pursuant to, the laws of the State of California.

6. DISCLAIMER OF WARRANTIES AND LIMITATION ON LIABILITY

6.1 No Warranties. TO THE MAXIMUM EXTENT PERMITTED BY APPLICABLE LAW, THE SOFTWARE IS PROVIDED "AS IS" AND NVIDIA AND ITS SUPPLIERS DISCLAIM ALL WARRANTIES, EITHER EXPRESS OR IMPLIED, INCLUDING, BUT NOT LIMITED TO, IMPLIED WARRANTIES OF MERCHANTABILITY AND FITNESS FOR A PARTICULAR PURPOSE.

6.2 No Liability for Consequential Damages. TO THE MAXIMUM EXTENT PERMITTED BY APPLICABLE LAW, IN NO EVENT SHALL NVIDIA OR ITS SUPPLIERS BE LIABLE FOR ANY SPECIAL, INCIDENTAL, INDIRECT, OR CONSEQUENTIAL DAMAGES WHATSOEVER (INCLUDING, WITHOUT LIMITATION, DAMAGES FOR LOSS OF BUSINESS PROFITS, BUSINESS INTERRUPTION, LOSS OF BUSINESS INFORMATION, OR ANY OTHER PECUNIARY LOSS) ARISING OUT OF THE USE OF OR INABILITY TO USE THE SOFTWARE, EVEN IF NVIDIA HAS BEEN ADVISED OF THE POSSIBILITY OF SUCH DAMAGES.

7. MISCELLANEOUS

The United Nations Convention on Contracts for the International Sale of Goods is specifically disclaimed. If any provision of this LICENSE is inconsistent with, or cannot be fully enforced under, the law, such provision will be construed as limited to the extent necessary to be consistent with and fully enforceable under the law. This agreement is the final, complete and exclusive agreement between the parties relating to the subject matter hereof, and supersedes all prior or contemporaneous understandings and agreements relating to such subject matter, whether oral or written. Customer agrees

LICENCE TERMS (cont.)

that it will not ship, transfer or export the SOFTWARE into any country, or use the SOFTWARE in any manner, prohibited by the United States Bureau of Export Administration or any export laws, restrictions or regulations. This LICENSE may only be modified in writing signed by an authorized officer of NVIDIA.

Copyright (c) 2006, One Laptop per Child and Marvell Corporation. All rights reserved.

Redistribution. Redistribution and use in binary form, without modification, are permitted provided that the following conditions are met:

- * Redistributions must reproduce the above copyright notice and the following disclaimer in the documentation and/or other materials provided with the distribution.
- * Neither the name of Marvell Corporation nor the names of its suppliers may be used to endorse or promote products derived from this software without specific prior written permission.
- * No reverse engineering, decompilation, or disassembly of this software is permitted.
- * You may not use or attempt to use this software in conjunction with any product that is offered by a third party as a replacement, substitute or alternative to a Marvell Product where a Marvell Product is defined as a proprietary wireless LAN embedded client solution of Marvell or a Marvell Affiliate.

DISCLAIMER. THIS SOFTWARE IS PROVIDED BY THE COPYRIGHT HOLDERS AND CONTRIBUTORS "AS IS" AND ANY EXPRESS OR IMPLIED WARRANTIES, INCLUDING, BUT NOT LIMITED TO, THE IMPLIED WARRANTIES OF MERCHANTABILITY AND FITNESS FOR A PARTICULAR PURPOSE ARE DISCLAIMED. IN NO EVENT SHALL THE COPYRIGHT OWNER OR CONTRIBUTORS BE LIABLE FOR ANY DIRECT, INDIRECT, INCIDENTAL, SPECIAL, EXEMPLARY, OR CONSEQUENTIAL DAMAGES (INCLUDING, BUT NOT LIMITED TO, PROCUREMENT OF SUBSTITUTE GOODS OR SERVICES; LOSS OF USE, DATA, OR PROFITS; OR BUSINESS INTERRUPTION) HOWEVER CAUSED AND ON ANY THEORY OF LIABILITY, WHETHER IN CONTRACT, STRICT LIABILITY, OR TORT (INCLUDING NEGLIGENCE OR OTHERWISE) ARISING IN ANY WAY OUT OF THE USE OF THIS SOFTWARE, EVEN IF ADVISED OF THE POSSIBILITY OF SUCH DAMAGE.

Copyright © 2003-2013 QLogic Corporation
QLogic Linux Intelligent Ethernet (3000 and 3100 Series) Adapter Firmware

Redistribution and use in binary form, without modification, for use in conjunction with QLogic authorized products is permitted provided that the following conditions are met:

1. Redistribution in binary form must reproduce the above copyright notice, this list of conditions and the following disclaimer in the documentation and/or other materials provided with the distribution.
2. The name of QLogic Corporation may not be used to endorse or promote products derived from this software without specific prior written permission.
3. Reverse engineering, decompilation, or disassembly of this firmware is not

permitted.

REGARDLESS OF WHAT LICENSING MECHANISM IS USED OR APPLICABLE, THIS PROGRAM IS PROVIDED BY QLOGIC CORPORATION "AS IS" AND ANY EXPRESS OR IMPLIED WARRANTIES, INCLUDING, BUT NOT LIMITED TO, THE IMPLIED WARRANTIES OF MERCHANTABILITY AND FITNESS FOR A PARTICULAR PURPOSE ARE DISCLAIMED. IN NO EVENT SHALL THE AUTHOR BE LIABLE FOR ANY DIRECT, INDIRECT, INCIDENTAL, SPECIAL, EXEMPLARY, OR CONSEQUENTIAL DAMAGES (INCLUDING, BUT NOT LIMITED TO, PROCUREMENT OF SUBSTITUTE GOODS OR SERVICES; LOSS OF USE, DATA, OR PROFITS; OR BUSINESS INTERRUPTION) HOWEVER CAUSED AND ON ANY THEORY OF LIABILITY, WHETHER IN CONTRACT, STRICT LIABILITY, OR TORT (INCLUDING NEGLIGENCE OR OTHERWISE) ARISING IN ANY WAY OUT OF THE USE OF THIS SOFTWARE, EVEN IF ADVISED OF THE POSSIBILITY OF SUCH DAMAGE.

USER ACKNOWLEDGES AND AGREES THAT USE OF THIS PROGRAM WILL NOT CREATE OR GIVE GROUNDS FOR A LICENSE BY IMPLICATION, ESTOPPEL, OR OTHERWISE IN ANY INTELLECTUAL PROPERTY RIGHTS (PATENT, COPYRIGHT, TRADE SECRET, MASK WORK, OR OTHER PROPRIETARY RIGHT) EMBODIED IN ANY OTHER QLOGIC HARDWARE OR SOFTWARE EITHER SOLELY OR IN COMBINATION WITH THIS PROGRAM.

Copyright (c) 2014, Intel Corporation.
All rights reserved.

Redistribution. Redistribution and use in binary form, without modification, are permitted provided that the following conditions are met:

- * Redistributions must reproduce the above copyright notice and the following disclaimer in the documentation and/or other materials provided with the distribution.
- * Neither the name of Intel Corporation nor the names of its suppliers may be used to endorse or promote products derived from this software without specific prior written permission.
- * No reverse engineering, decompilation, or disassembly of this software is permitted.

Limited patent license. Intel Corporation grants a world-wide, royalty-free, non-exclusive license under patents it now or hereafter owns or controls to make, have made, use, import, offer to sell and sell ("Utilize") this software, but solely to the extent that any such patent is necessary to Utilize the software alone, or in combination with an operating system licensed under an approved Open Source license as listed by the Open Source Initiative at <http://opensource.org/licenses>. The patent license shall not apply to any other combinations which include this software. No hardware per se is licensed hereunder.

DISCLAIMER. THIS SOFTWARE IS PROVIDED BY THE COPYRIGHT HOLDERS AND CONTRIBUTORS "AS IS" AND ANY EXPRESS OR IMPLIED WARRANTIES, INCLUDING, BUT NOT LIMITED TO, THE IMPLIED WARRANTIES OF MERCHANTABILITY AND FITNESS FOR A PARTICULAR PURPOSE ARE DISCLAIMED. IN NO EVENT SHALL THE COPYRIGHT OWNER OR CONTRIBUTORS BE LIABLE FOR ANY DIRECT, INDIRECT, INCIDENTAL, SPECIAL, EXEMPLARY, OR CONSEQUENTIAL DAMAGES (INCLUDING, BUT NOT LIMITED TO, PROCUREMENT OF SUBSTITUTE GOODS OR SERVICES; LOSS OF USE, DATA, OR PROFITS; OR BUSINESS INTERRUPTION) HOWEVER CAUSED AND

LICENCE TERMS (cont.)

ON ANY THEORY OF LIABILITY, WHETHER IN CONTRACT, STRICT LIABILITY, OR TORT (INCLUDING NEGLIGENCE OR OTHERWISE) ARISING IN ANY WAY OUT OF THE USE OF THIS SOFTWARE, EVEN IF ADVISED OF THE POSSIBILITY OF SUCH DAMAGE.

PLEASE READ THIS LICENSE AGREEMENT ("AGREEMENT") CAREFULLY. THIS AGREEMENT IS A BINDING LEGAL AGREEMENT ENTERED INTO BY AND BETWEEN YOU (OR IF YOU ARE ENTERING INTO THIS AGREEMENT ON BEHALF OF AN ENTITY, THEN THE ENTITY THAT YOU REPRESENT) AND QUALCOMM TECHNOLOGIES, INC. ("QTI" "WE" "OUR" OR "US"). THIS IS THE AGREEMENT THAT APPLIES TO YOUR USE OF THE DESIGNATED AND/OR LINKED APPLICATIONS, THE ENCLOSED QUALCOMM TECHNOLOGIES' MATERIALS, INCLUDING RELATED DOCUMENTATION AND ANY UPDATES OR IMPROVEMENTS THEREOF (COLLECTIVELY, "MATERIALS"). BY USING OR COMPLETING THE INSTALLATION OF THE MATERIALS, YOU ARE ACCEPTING THIS AGREEMENT AND YOU AGREE TO BE BOUND BY ITS TERMS AND CONDITIONS. IF YOU DO NOT AGREE TO THESE TERMS, QTI IS UNWILLING TO AND DOES NOT LICENSE THE MATERIALS TO YOU. IF YOU DO NOT AGREE TO THESE TERMS YOU MUST DISCONTINUE THE INSTALLATION PROCESS AND YOU MAY NOT USE THE MATERIALS OR RETAIN ANY COPIES OF THE MATERIALS. ANY USE OR POSSESSION OF THE MATERIALS BY YOU IS SUBJECT TO THE TERMS AND CONDITIONS SET FORTH IN THIS AGREEMENT.

1. RIGHT TO USE DELIVERABLES; RESTRICTIONS.

1.1 License. Subject to the terms and conditions of this Agreement, including, without limitation, the restrictions, conditions, limitations and exclusions set forth in this Agreement, QTI hereby grants to you a nonexclusive, limited license under QTI's copyrights to: (i) install and use the Materials; and (ii) to reproduce and redistribute the binary code portions of the Materials (the "Redistributable Binary Code"). You may make and use a reasonable number of copies of any documentation.

1.2 Redistribution Restrictions. Distribution of the Redistributable Binary Code is subject to the following restrictions: (i) Redistributable Binary Code may only be distributed in binary format and may not be distributed in source code format;; (ii) the Redistributable Binary Code may only operate in conjunction with platforms incorporating Qualcomm Technologies, Inc. chipsets; (iii) redistribution of the Redistributable Binary Code must include the .txt file setting forth the terms and condition of this Agreement; (iv) you may not use Qualcomm Technologies' or its affiliates or subsidiaries name, logo or trademarks; and (v) copyright, trademark, patent and any other notices that appear on the Materials may not be removed or obscured.

1.3 Additional Restrictions. Except as expressly permitted by this Agreement, you shall have no right to sublicense, transfer or otherwise disclose the Materials to any third party. You shall not reverse engineer, reverse assemble, reverse translate, decompile or reduce to source code form any portion of the Materials provided in object code form or executable form. Except for the purposes expressly permitted in this Agreement, You shall not use the Materials for any other purpose. QTI (or its licensors) shall retain title and all ownership rights in and to the Materials and any alterations, modifications (including all derivative works), translations or adaptations made of the Materials, and all copies thereof, and nothing herein shall be deemed to grant any right to You under any of QTI's or its affiliates' patents. You shall not subject the Materials to any third party license terms (e.g., open source license terms). You shall not use the Materials for the purpose of identifying or providing evidence to support any potential

patent infringement claim against QTI, its affiliates, or any of QTI's or QTI's affiliates' suppliers and/or direct or indirect customers. QTI hereby reserves all rights not expressly granted herein.

1.4 Third Party Software and Materials. The Software may contain or link to certain software and/or materials that are written or owned by third parties. Such third party code and materials may be licensed under separate or different terms and conditions and are not licensed to you under the terms of this Agreement. You agree to comply with all terms and conditions imposed on you in the applicable third party licenses. Such terms and conditions may impose certain obligations on you as a condition to the permitted use of such third party code and materials. QTI does not represent or warrant that such third party licensors have or will continue to license or make available their code and materials to you.

1.5 Feedback. QTI may from time to time receive suggestions, feedback or other information from You regarding the Materials. Any suggestions, feedback or other disclosures received from You are and shall be entirely voluntary on the part of You. Notwithstanding any other term in this Agreement, QTI shall be free to use suggestions, feedback or other information received from You, without obligation of any kind to You. The Parties agree that all inventions, product improvements, and modifications conceived of or made by QTI that are based, either in whole or in part, on ideas, feedback, suggestions, or recommended improvements received from You are the exclusive property of QTI, and all right, title and interest in and to any such inventions, product improvements, and modifications will vest solely in QTI.

1.6 No Technical Support. QTI is under no obligation to provide any form of technical support for the Materials, and if QTI, in its sole discretion, chooses to provide any form of support or information relating to the Materials, such support and information shall be deemed confidential and proprietary to QTI.

2. WARRANTY DISCLAIMER. YOU EXPRESSLY ACKNOWLEDGE AND AGREE THAT THE USE OF THE MATERIALS IS AT YOUR SOLE RISK. THE MATERIALS AND TECHNICAL SUPPORT, IF ANY, ARE PROVIDED "AS IS" AND WITHOUT WARRANTY OF ANY KIND, WHETHER EXPRESS OR IMPLIED. QTI ITS LICENSORS AND AFFILIATES MAKE NO WARRANTIES, EXPRESS OR IMPLIED, WITH RESPECT TO THE MATERIALS OR ANY OTHER INFORMATION OR DOCUMENTATION PROVIDED UNDER THIS AGREEMENT, INCLUDING BUT NOT LIMITED TO ANY WARRANTY OF MERCHANTABILITY OR FITNESS FOR A PARTICULAR PURPOSE OR AGAINST INFRINGEMENT, OR ANY EXPRESS OR IMPLIED WARRANTY ARISING OUT OF TRADE USAGE OR OUT OF A COURSE OF DEALING OR COURSE OF PERFORMANCE. NOTHING CONTAINED IN THIS AGREEMENT SHALL BE CONSTRUED AS (I) A WARRANTY OR REPRESENTATION BY QTI, ITS LICENSORS OR AFFILIATES AS TO THE VALIDITY OR SCOPE OF ANY PATENT, COPYRIGHT OR OTHER INTELLECTUAL PROPERTY RIGHT OR (II) A WARRANTY OR REPRESENTATION BY QTI THAT ANY MANUFACTURE OR USE WILL BE FREE FROM INFRINGEMENT OF PATENTS, COPYRIGHTS OR OTHER INTELLECTUAL PROPERTY RIGHTS OF OTHERS, AND IT SHALL BE THE SOLE RESPONSIBILITY OF YOU TO MAKE SUCH DETERMINATION AS IS NECESSARY WITH RESPECT TO THE ACQUISITION OF LICENSES UNDER PATENTS AND OTHER INTELLECTUAL PROPERTY OF THIRD PARTIES.

3. NO OTHER LICENSES OR INTELLECTUAL PROPERTY RIGHTS. Neither this Agreement, nor any act by QTI or any of its affiliates pursuant to this Agreement or relating to the Materials (including, without limitation, the provision by QTI or its affiliates of the Materials), shall provide to You any license or any other rights whatsoever under any patents, trademarks, trade secrets, copyrights or any other intellectual property of QTI or any of its affiliates, except for

LICENCE TERMS (cont.)

the copyright rights expressly licensed under this Agreement. You understand and agree that:

(i) Neither this Agreement, nor delivery of the Materials, grants any right to practice, or any other right at all with respect to, any patent of QTI or any of its affiliates; and

(ii) A separate license agreement from QUALCOMM Incorporated is needed to use or practice any patent of QUALCOMM Incorporated. You agree not to contend in any context that, as a result of the provision or use of the Materials, either QTI or any of its affiliates has any obligation to extend, or You or any other party has obtained any right to, any license, whether express or implied, with respect to any patent of QTI or any of its affiliates for any purpose.

4. **TERMINATION.** This Agreement shall be effective upon acceptance, or access or use of the Materials (whichever occurs first) by You and shall continue until terminated. You may terminate the Agreement at any time by deleting and destroying all copies of the Materials and all related information in Your possession or control. This Agreement terminates immediately and automatically, with or without notice, if You fail to comply with any provision hereof. Additionally, QTI may at any time terminate this Agreement, without cause, upon notice to You. Upon termination You must, to the extent possible, delete or destroy all copies of the Materials in Your possession and the license granted to You in this Agreement shall terminate. Sections 1.2 through 10 shall survive the termination of this Agreement. In the event that any restrictions, conditions, limitations are found to be either invalid or unenforceable, the rights granted to You in Section 1 (License) shall be null, void and ineffective from the Effective Date, and QTI shall also have the right to terminate this Agreement immediately, and with retroactive effect to the effective date.

5. **LIMITATION OF LIABILITY.** IN NO EVENT SHALL QTI, QTI'S AFFILIATES OR ITS LICENSORS BE LIABLE TO YOU FOR ANY INCIDENTAL, CONSEQUENTIAL OR SPECIAL DAMAGES, INCLUDING BUT NOT LIMITED TO ANY LOST PROFITS, LOST SAVINGS, OR OTHER INCIDENTAL DAMAGES, ARISING OUT OF THE USE OR INABILITY TO USE, OR THE DELIVERY OR FAILURE TO DELIVER, ANY OF THE DELIVERABLES, OR ANY BREACH OF ANY OBLIGATION UNDER THIS AGREEMENT, EVEN IF QTI HAS BEEN ADVISED OF THE POSSIBILITY OF SUCH DAMAGES. THE FOREGOING LIMITATION OF LIABILITY SHALL REMAIN IN FULL FORCE AND EFFECT REGARDLESS OF WHETHER YOUR REMEDIES HEREUNDER ARE DETERMINED TO HAVE FAILED OF THEIR ESSENTIAL PURPOSE. THE ENTIRE LIABILITY OF QTI, QTI'S AFFILIATES AND ITS LICENSORS, AND THE SOLE AND EXCLUSIVE REMEDY OF YOU, FOR ANY CLAIM OR CAUSE OF ACTION ARISING HEREUNDER (WHETHER IN CONTRACT, TORT, OR OTHERWISE) SHALL NOT EXCEED US\$50.

6. **INDEMNIFICATION.** You agree to indemnify and hold harmless QTI and its officers, directors, employees and successors and assigns against any and all third party claims, demands, causes of action, losses, liabilities, damages, costs and expenses, incurred by QTI (including but not limited to costs of defense, investigation and reasonable attorney's fees) arising out of, resulting from or related to: (i) any breach of this Agreement by You; and (ii) your acts, omissions, products and services. If requested by QTI, You agree to defend QTI in connection with any third party claims, demands, or causes of action resulting from, arising out of or in connection with any of the foregoing.

7. **ASSIGNMENT.** You shall not assign this Agreement or any right or interest under this Agreement, nor delegate any obligation to be performed under this Agreement, without QTI's prior written consent. For purposes of this Section 7, an "assignment" by You under this Section shall be deemed to include, without

limitation, any merger, consolidation, sale of all or substantially all of its assets, or any substantial change in the management or control of You. Any attempted assignment in contravention of this Section 9 shall be void. QTI may freely assign this Agreement or delegate any or all of its rights and obligations hereunder to any third party.

8. **COMPLIANCE WITH LAWS; APPLICABLE LAW.** You agree to comply with all applicable local, international and national laws and regulations and with U.S. Export Administration Regulations, as they apply to the subject matter of this Agreement. This Agreement is governed by the laws of the State of California, excluding California's choice of law rules.

9. **CONTRACTING PARTIES.** If the Materials are downloaded on any computer owned by a corporation or other legal entity, then this Agreement is formed by and between QTI and such entity. The individual accepting the terms of this Agreement represents and warrants to QTI that they have the authority to bind such entity to the terms and conditions of this Agreement.

10. **MISCELLANEOUS PROVISIONS.** This Agreement, together with all exhibits attached hereto, which are incorporated herein by this reference, constitutes the entire agreement between QTI and You and supersedes all prior negotiations, representations and agreements between the parties with respect to the subject matter hereof. No addition or modification of this Agreement shall be effective unless made in writing and signed by the respective representatives of QTI and You. The restrictions, limitations, exclusions and conditions set forth in this Agreement shall apply even if QTI or any of its affiliates becomes aware of or fails to act in a manner to address any violation or failure to comply therewith. You hereby acknowledge and agree that the restrictions, limitations, conditions and exclusions imposed in this Agreement on the rights granted in this Agreement are not a derogation of the benefits of such rights. You further acknowledges that, in the absence of such restrictions, limitations, conditions and exclusions, QTI would not have entered into this Agreement with You. Each party shall be responsible for and shall bear its own expenses in connection with this Agreement. If any of the provisions of this Agreement are determined to be invalid, illegal, or otherwise unenforceable, the remaining provisions shall remain in full force and effect. This Agreement is entered into solely in the English language, and if for any reason any other language version is prepared by any party, it shall be solely for convenience and the English version shall govern and control all aspects. If You are located in the province of Quebec, Canada, the following applies: The Parties hereby confirm they have requested this Agreement and all related documents be prepared in English.

Copyright (c) 2003-2017 QLogic Corporation
QLogic Linux Fibre Channel Adapter Firmware

Redistribution and use in binary form, without modification, for use in conjunction with QLogic authorized products is permitted provided that the following conditions are met:

1. Redistribution in binary form must reproduce the above copyright notice, this list of conditions and the following disclaimer in the documentation and/or other materials provided with the distribution.
2. The name of QLogic Corporation may not be used to endorse or promote products derived from this software without specific prior written permission.

LICENCE TERMS (cont.)

3. Reverse engineering, decompilation, or disassembly of this firmware is not permitted.

REGARDLESS OF WHAT LICENSING MECHANISM IS USED OR APPLICABLE, THIS PROGRAM IS PROVIDED BY QLOGIC CORPORATION "AS IS" AND ANY EXPRESS OR IMPLIED WARRANTIES, INCLUDING, BUT NOT LIMITED TO, THE IMPLIED WARRANTIES OF MERCHANTABILITY AND FITNESS FOR A PARTICULAR PURPOSE ARE DISCLAIMED. IN NO EVENT SHALL THE AUTHOR BE LIABLE FOR ANY DIRECT, INDIRECT, INCIDENTAL, SPECIAL, EXEMPLARY, OR CONSEQUENTIAL DAMAGES (INCLUDING, BUT NOT LIMITED TO, PROCUREMENT OF SUBSTITUTE GOODS OR SERVICES; LOSS OF USE, DATA, OR PROFITS; OR BUSINESS INTERRUPTION) HOWEVER CAUSED AND ON ANY THEORY OF LIABILITY, WHETHER IN CONTRACT, STRICT LIABILITY, OR TORT (INCLUDING NEGLIGENCE OR OTHERWISE) ARISING IN ANY WAY OUT OF THE USE OF THIS SOFTWARE, EVEN IF ADVISED OF THE POSSIBILITY OF SUCH DAMAGE.

USER ACKNOWLEDGES AND AGREES THAT USE OF THIS PROGRAM WILL NOT CREATE OR GIVE GROUNDS FOR A LICENSE BY IMPLICATION, ESTOPPEL, OR OTHERWISE IN ANY INTELLECTUAL PROPERTY RIGHTS (PATENT, COPYRIGHT, TRADE SECRET, MASK WORK, OR OTHER PROPRIETARY RIGHT) EMBODIED IN ANY OTHER QLOGIC HARDWARE OR SOFTWARE EITHER SOLELY OR IN COMBINATION WITH THIS PROGRAM.

Copyright (C) 1995, 1996, 1997, 1998, 1999, 2000 QLogic, Inc.
All rights reserved.

Redistribution and use in source and binary forms are permitted provided that the following conditions are met:

1. Redistribution of source code must retain the above copyright notice, this list of conditions and the following disclaimer.
2. Redistribution in binary form must reproduce the above copyright notice, this list of conditions and the following disclaimer in the documentation and/or other materials provided with the distribution.
3. The name of the author may not be used to endorse or promote products derived from this software without specific prior written permission

THIS SOFTWARE IS PROVIDED BY THE AUTHOR "AS IS" AND ANY EXPRESS OR IMPLIED WARRANTIES, INCLUDING, BUT NOT LIMITED TO, THE IMPLIED WARRANTIES OF MERCHANTABILITY AND FITNESS FOR A PARTICULAR PURPOSE ARE DISCLAIMED. IN NO EVENT SHALL THE AUTHOR BE LIABLE FOR ANY DIRECT, INDIRECT, INCIDENTAL, SPECIAL, EXEMPLARY, OR CONSEQUENTIAL DAMAGES (INCLUDING, BUT NOT LIMITED TO, PROCUREMENT OF SUBSTITUTE GOODS OR SERVICES; LOSS OF USE, DATA, OR PROFITS; OR BUSINESS INTERRUPTION) HOWEVER CAUSED AND ON ANY THEORY OF LIABILITY, WHETHER IN CONTRACT, STRICT LIABILITY, OR TORT (INCLUDING NEGLIGENCE OR OTHERWISE) ARISING IN ANY WAY OUT OF THE USE OF THIS SOFTWARE, EVEN IF ADVISED OF THE POSSIBILITY OF SUCH DAMAGE.

Copyright (c) 2015, Qualcomm Atheros, Inc.
All rights reserved.

Redistribution. Reproduction and redistribution in binary form, without modification, for use solely in conjunction with a Qualcomm Atheros, Inc. chipset, is permitted provided that the following conditions are met:

- Redistributions must reproduce the above copyright notice and the following

disclaimer in the documentation and/or other materials provided with the distribution.

- Neither the name of Qualcomm Atheros, Inc. nor the names of its suppliers may be used to endorse or promote products derived from this Software without specific prior written permission.
- No reverse engineering, decompilation, or disassembly of this Software is permitted.

Limited patent license. Qualcomm Atheros, Inc. ("Licensor") grants you ("Licensee") a limited, worldwide, royalty-free, non-exclusive license under the Patents to make, have made, use, import, offer to sell and sell the Software. No hardware per se is licensed hereunder.

The term "Patents" as used in this agreement means only those patents or patent applications owned solely and exclusively by Licensor as of the date of Licensor's submission of the Software and any patents deriving priority (i.e., having a first effective filing date) therefrom. The term "Software" as used in this agreement means the firmware image submitted by Licensor, under the terms of this license, to [git://git.kernel.org/pub/scm/linux/kernel/git/firmware/linux-firmware.git](https://git.kernel.org/pub/scm/linux/kernel/git/firmware/linux-firmware.git).

Notwithstanding anything to the contrary herein, Licensor does not grant and Licensee does not receive, by virtue of this agreement or the Licensor's submission of any Software, any license or other rights under any patent or patent application owned by any affiliate of Licensor or any other entity (other than Licensor), whether expressly, impliedly, by virtue of estoppel or exhaustion, or otherwise.

DISCLAIMER. THIS SOFTWARE IS PROVIDED BY THE COPYRIGHT HOLDERS AND CONTRIBUTORS "AS IS" AND ANY EXPRESS OR IMPLIED WARRANTIES, INCLUDING, BUT NOT LIMITED TO, THE IMPLIED WARRANTIES OF MERCHANTABILITY AND FITNESS FOR A PARTICULAR PURPOSE ARE DISCLAIMED. IN NO EVENT SHALL THE COPYRIGHT OWNER OR CONTRIBUTORS BE LIABLE FOR ANY DIRECT, INDIRECT, INCIDENTAL, SPECIAL, EXEMPLARY, OR CONSEQUENTIAL DAMAGES (INCLUDING, BUT NOT LIMITED TO, PROCUREMENT OF SUBSTITUTE GOODS OR SERVICES; LOSS OF USE, DATA, OR PROFITS; OR BUSINESS INTERRUPTION) HOWEVER CAUSED AND ON ANY THEORY OF LIABILITY, WHETHER IN CONTRACT, STRICT LIABILITY, OR TORT (INCLUDING NEGLIGENCE OR OTHERWISE) ARISING IN ANY WAY OUT OF THE USE OF THIS SOFTWARE, EVEN IF ADVISED OF THE POSSIBILITY OF SUCH DAMAGE.

Copyright (c) 2015-2017, Qualcomm Atheros, Inc.
All rights reserved.

Redistribution. Reproduction and redistribution in binary form, without modification, for use solely in conjunction with a Qualcomm Atheros, Inc. chipset, is permitted provided that the following conditions are met:

- Redistributions must reproduce the above copyright notice and the following disclaimer in the documentation and/or other materials provided with the distribution.
- Neither the name of Qualcomm Atheros, Inc. nor the names of its suppliers may be used to endorse or promote products derived from this Software without specific prior written permission.

LICENCE TERMS (cont.)

- No reverse engineering, decompilation, or disassembly of this Software is permitted.

Limited patent license. Qualcomm Atheros, Inc. ("Licensor") grants you ("Licensee") a limited, worldwide, royalty-free, non-exclusive license under the Patents to make, have made, use, import, offer to sell and sell the Software. No hardware per se is licensed hereunder.

The term "Patents" as used in this agreement means only those patents or patent applications owned solely and exclusively by Licensor as of the date of Licensor's submission of the Software and any patents deriving priority (i.e., having a first effective filing date) therefrom. The term "Software" as used in this agreement means the firmware image submitted by Licensor, under the terms of this license, to [git://git.kernel.org/pub/scm/linux/kernel/git/firmware/linux-firmware.git](https://git.kernel.org/pub/scm/linux/kernel/git/firmware/linux-firmware.git).

Notwithstanding anything to the contrary herein, Licensor does not grant and Licensee does not receive, by virtue of this agreement or the Licensor's submission of any Software, any license or other rights under any patent or patent application owned by any affiliate of Licensor or any other entity (other than Licensor), whether expressly, impliedly, by virtue of estoppel or exhaustion, or otherwise.

DISCLAIMER. THIS SOFTWARE IS PROVIDED BY THE COPYRIGHT HOLDERS AND CONTRIBUTORS "AS IS" AND ANY EXPRESS OR IMPLIED WARRANTIES, INCLUDING, BUT NOT LIMITED TO, THE IMPLIED WARRANTIES OF MERCHANTABILITY AND FITNESS FOR A PARTICULAR PURPOSE ARE DISCLAIMED. IN NO EVENT SHALL THE COPYRIGHT OWNER OR CONTRIBUTORS BE LIABLE FOR ANY DIRECT, INDIRECT, INCIDENTAL, SPECIAL, EXEMPLARY, OR CONSEQUENTIAL DAMAGES (INCLUDING, BUT NOT LIMITED TO, PROCUREMENT OF SUBSTITUTE GOODS OR SERVICES; LOSS OF USE, DATA, OR PROFITS; OR BUSINESS INTERRUPTION) HOWEVER CAUSED AND ON ANY THEORY OF LIABILITY, WHETHER IN CONTRACT, STRICT LIABILITY, OR TORT (INCLUDING NEGLIGENCE OR OTHERWISE) ARISING IN ANY WAY OUT OF THE USE OF THIS SOFTWARE, EVEN IF ADVISED OF THE POSSIBILITY OF SUCH DAMAGE.

Copyright (c) 2014, Renesas Electronics Corporation
All rights reserved.

Redistribution and use in binary form, without modification, are permitted provided that the following conditions are met:

1. Redistribution in binary form must reproduce the above copyright notice, this list of conditions and the following disclaimer in the documentation and/or other materials provided with the distribution.
2. The name of Renesas Electronics Corporation may not be used to endorse or promote products derived from this software without specific prior written permission.
3. Reverse engineering, decompilation, or disassembly of this software is not permitted.

THIS SOFTWARE IS PROVIDED "AS IS" AND RENESAS ELECTRONICS CORPORATION DISCLAIMS ANY EXPRESS OR IMPLIED WARRANTIES, INCLUDING, BUT NOT LIMITED TO, THE IMPLIED WARRANTIES OF MERCHANTABILITY AND FITNESS FOR A PARTICULAR PURPOSE, AND NON-INFRINGEMENT OF THIRD PARTY RIGHTS. IN NO EVENT SHALL RENESAS ELECTRONICS CORPORATION BE LIABLE FOR ANY DIRECT, INDIRECT, INCIDENTAL, SPECIAL, EXEMPLARY, OR CONSEQUENTIAL DAMAGES (INCLUDING, BUT NOT LIMITED TO, PROCUREMENT OF SUBSTITUTE GOODS OR SERVICES; LOSS OF USE, DATA, OR PROFITS; OR BUSINESS

INTERRUPTION) HOWEVER CAUSED AND ON ANY THEORY OF LIABILITY, WHETHER IN CONTRACT, STRICT LIABILITY, OR TORT (INCLUDING NEGLIGENCE OR OTHERWISE) ARISING IN ANY WAY OUT OF THE USE OF THIS SOFTWARE, EVEN IF ADVISED OF THE POSSIBILITY OF SUCH DAMAGE.

Copyright (C) 2009-2017 Advanced Micro Devices, Inc. All rights reserved.

REDISTRIBUTION: Permission is hereby granted, free of any license fees, to any person obtaining a copy of this microcode (the "Software"), to install, reproduce, copy and distribute copies, in binary form only, of the Software and to permit persons to whom the Software is provided to do the same, provided that the following conditions are met:

No reverse engineering, decompilation, or disassembly of this Software is permitted.

Redistributions must reproduce the above copyright notice, this permission notice, and the following disclaimers and notices in the Software documentation and/or other materials provided with the Software.

DISCLAIMER: THE USE OF THE SOFTWARE IS AT YOUR SOLE RISK. THE SOFTWARE IS PROVIDED "AS IS" AND WITHOUT WARRANTY OF ANY KIND AND COPYRIGHT HOLDER AND ITS LICENSORS EXPRESSLY DISCLAIM ALL WARRANTIES, EXPRESS AND IMPLIED, INCLUDING, BUT NOT LIMITED TO, THE IMPLIED WARRANTIES OF MERCHANTABILITY, FITNESS FOR A PARTICULAR PURPOSE AND NON-INFRINGEMENT. COPYRIGHT HOLDER AND ITS LICENSORS DO NOT WARRANT THAT THE SOFTWARE WILL MEET YOUR REQUIREMENTS, OR THAT THE OPERATION OF THE SOFTWARE WILL BE UNINTERRUPTED OR ERROR-FREE. THE ENTIRE RISK ASSOCIATED WITH THE USE OF THE SOFTWARE IS ASSUMED BY YOU. FURTHERMORE, COPYRIGHT HOLDER AND ITS LICENSORS DO NOT WARRANT OR MAKE ANY REPRESENTATIONS REGARDING THE USE OR THE RESULTS OF THE USE OF THE SOFTWARE IN TERMS OF ITS CORRECTNESS, ACCURACY, RELIABILITY, CURRENTNESS, OR OTHERWISE.

DISCLAIMER: UNDER NO CIRCUMSTANCES INCLUDING NEGLIGENCE, SHALL COPYRIGHT HOLDER AND ITS LICENSORS OR ITS DIRECTORS, OFFICERS, EMPLOYEES OR AGENTS ("AUTHORIZED REPRESENTATIVES") BE LIABLE FOR ANY INCIDENTAL, INDIRECT, SPECIAL OR CONSEQUENTIAL DAMAGES (INCLUDING DAMAGES FOR LOSS OF BUSINESS PROFITS, BUSINESS INTERRUPTION, LOSS OF BUSINESS INFORMATION, AND THE LIKE) ARISING OUT OF THE USE, MISUSE OR INABILITY TO USE THE SOFTWARE, BREACH OR DEFAULT, INCLUDING THOSE ARISING FROM INFRINGEMENT OR ALLEGED INFRINGEMENT OF ANY PATENT, TRADEMARK, COPYRIGHT OR OTHER INTELLECTUAL PROPERTY RIGHT EVEN IF COPYRIGHT HOLDER AND ITS AUTHORIZED REPRESENTATIVES HAS BEEN ADVISED OF THE POSSIBILITY OF SUCH DAMAGES. IN NO EVENT SHALL COPYRIGHT HOLDER OR ITS AUTHORIZED REPRESENTATIVES TOTAL LIABILITY FOR ALL DAMAGES, LOSSES, AND CAUSES OF ACTION (WHETHER IN CONTRACT, TORT (INCLUDING NEGLIGENCE) OR OTHERWISE) EXCEED THE AMOUNT OF US\$10.

Notice: The Software is subject to United States export laws and regulations. You agree to comply with all domestic and international export laws and regulations that apply to the Software, including but not limited to the Export Administration Regulations administered by the U.S. Department of Commerce and International Traffic in Arm Regulations administered by the U.S. Department of State. These laws include

LICENCE TERMS (cont.)

restrictions on destinations, end users and end use.

Copyright (c) 2013, Ralink, A MediaTek Company
All rights reserved.

Redistribution. Redistribution and use in binary form, without modification, are permitted provided that the following conditions are met:

- * Redistributions must reproduce the above copyright notice and the following disclaimer in the documentation and/or other materials provided with the distribution.
- * Neither the name of Ralink Technology Corporation nor the names of its suppliers may be used to endorse or promote products derived from this software without specific prior written permission.
- * No reverse engineering, decompilation, or disassembly of this software is permitted.

Limited patent license. Ralink Technology Corporation grants a world-wide, royalty-free, non-exclusive license under patents it now or hereafter owns or controls to make, have made, use, import, offer to sell and sell ("Utilize") this software, but solely to the extent that any such patent is necessary to Utilize the software alone, or in combination with an operating system licensed under an approved Open Source license as listed by the Open Source Initiative at <http://opensource.org/licenses>. The patent license shall not apply to any other combinations which include this software. No hardware per se is licensed hereunder.

DISCLAIMER. THIS SOFTWARE IS PROVIDED BY THE COPYRIGHT HOLDERS AND CONTRIBUTORS "AS IS" AND ANY EXPRESS OR IMPLIED WARRANTIES, INCLUDING, BUT NOT LIMITED TO, THE IMPLIED WARRANTIES OF MERCHANTABILITY AND FITNESS FOR A PARTICULAR PURPOSE ARE DISCLAIMED. IN NO EVENT SHALL THE COPYRIGHT OWNER OR CONTRIBUTORS BE LIABLE FOR ANY DIRECT, INDIRECT, INCIDENTAL, SPECIAL, EXEMPLARY, OR CONSEQUENTIAL DAMAGES (INCLUDING, BUT NOT LIMITED TO, PROCUREMENT OF SUBSTITUTE GOODS OR SERVICES; LOSS OF USE, DATA, OR PROFITS; OR BUSINESS INTERRUPTION) HOWEVER CAUSED AND ON ANY THEORY OF LIABILITY, WHETHER IN CONTRACT, STRICT LIABILITY, OR TORT (INCLUDING NEGLIGENCE OR OTHERWISE) ARISING IN ANY WAY OUT OF THE USE OF THIS SOFTWARE, EVEN IF ADVISED OF THE POSSIBILITY OF SUCH DAMAGE.

Copyright (c) 2007, Ralink Technology Corporation
All rights reserved.

Redistribution. Redistribution and use in binary form, without modification, are permitted provided that the following conditions are met:

- * Redistributions must reproduce the above copyright notice and the following disclaimer in the documentation and/or other materials provided with the distribution.
- * Neither the name of Ralink Technology Corporation nor the names of its

suppliers may be used to endorse or promote products derived from this software without specific prior written permission.

- * No reverse engineering, decompilation, or disassembly of this software is permitted.

Limited patent license. Ralink Technology Corporation grants a world-wide, royalty-free, non-exclusive license under patents it now or hereafter owns or controls to make, have made, use, import, offer to sell and sell ("Utilize") this software, but solely to the extent that any such patent is necessary to Utilize the software alone, or in combination with an operating system licensed under an approved Open Source license as listed by the Open Source Initiative at <http://opensource.org/licenses>. The patent license shall not apply to any other combinations which include this software. No hardware per se is licensed hereunder.

DISCLAIMER. THIS SOFTWARE IS PROVIDED BY THE COPYRIGHT HOLDERS AND CONTRIBUTORS "AS IS" AND ANY EXPRESS OR IMPLIED WARRANTIES, INCLUDING, BUT NOT LIMITED TO, THE IMPLIED WARRANTIES OF MERCHANTABILITY AND FITNESS FOR A PARTICULAR PURPOSE ARE DISCLAIMED. IN NO EVENT SHALL THE COPYRIGHT OWNER OR CONTRIBUTORS BE LIABLE FOR ANY DIRECT, INDIRECT, INCIDENTAL, SPECIAL, EXEMPLARY, OR CONSEQUENTIAL DAMAGES (INCLUDING, BUT NOT LIMITED TO, PROCUREMENT OF SUBSTITUTE GOODS OR SERVICES; LOSS OF USE, DATA, OR PROFITS; OR BUSINESS INTERRUPTION) HOWEVER CAUSED AND ON ANY THEORY OF LIABILITY, WHETHER IN CONTRACT, STRICT LIABILITY, OR TORT (INCLUDING NEGLIGENCE OR OTHERWISE) ARISING IN ANY WAY OUT OF THE USE OF THIS SOFTWARE, EVEN IF ADVISED OF THE POSSIBILITY OF SUCH DAMAGE.

Copyright (c) 2010, Realtek Semiconductor Corporation
All rights reserved.

Redistribution. Redistribution and use in binary form, without modification, are permitted provided that the following conditions are met:

- * Redistributions must reproduce the above copyright notice and the following disclaimer in the documentation and/or other materials provided with the distribution.
- * Neither the name of Realtek Semiconductor Corporation nor the names of its suppliers may be used to endorse or promote products derived from this software without specific prior written permission.
- * No reverse engineering, decompilation, or disassembly of this software is permitted.

Limited patent license. Realtek Semiconductor Corporation grants a world-wide, royalty-free, non-exclusive license under patents it now or hereafter owns or controls to make, have made, use, import, offer to sell and sell ("Utilize") this software, but solely to the extent that any such patent is necessary to Utilize the software alone, or in combination with an operating system licensed under an approved Open Source license as listed by the Open Source Initiative at <http://opensource.org/licenses>. The patent license shall not apply to any other combinations which include this software. No hardware per se is licensed hereunder.

LICENCE TERMS (cont.)

DISCLAIMER. THIS SOFTWARE IS PROVIDED BY THE COPYRIGHT HOLDERS AND CONTRIBUTORS "AS IS" AND ANY EXPRESS OR IMPLIED WARRANTIES, INCLUDING, BUT NOT LIMITED TO, THE IMPLIED WARRANTIES OF MERCHANTABILITY AND FITNESS FOR A PARTICULAR PURPOSE ARE DISCLAIMED. IN NO EVENT SHALL THE COPYRIGHT OWNER OR CONTRIBUTORS BE LIABLE FOR ANY DIRECT, INDIRECT, INCIDENTAL, SPECIAL, EXEMPLARY, OR CONSEQUENTIAL DAMAGES (INCLUDING, BUT NOT LIMITED TO, PROCUREMENT OF SUBSTITUTE GOODS OR SERVICES; LOSS OF USE, DATA, OR PROFITS; OR BUSINESS INTERRUPTION) HOWEVER CAUSED AND ON ANY THEORY OF LIABILITY, WHETHER IN CONTRACT, STRICT LIABILITY, OR TORT (INCLUDING NEGLIGENCE OR OTHERWISE) ARISING IN ANY WAY OUT OF THE USE OF THIS SOFTWARE, EVEN IF ADVISED OF THE POSSIBILITY OF SUCH DAMAGE.

FIRMWARE LICENSE TERMS

Copyright (c) 2005-2014 Siano Mobile Silicon Ltd.
All rights reserved.

Redistribution. Redistribution and use in binary form, without modification, are permitted provided that the following conditions are met:

* Redistributions must reproduce the above copyright notice and the following disclaimer in the documentation and/or other materials provided with the distribution.

* Neither the name of Siano Mobile Silicon Ltd. nor the names of its suppliers may be used to endorse or promote products derived from this software without specific prior written permission.

* No reverse engineering, decompilation, or disassembly of this software is permitted.

DISCLAIMER. THIS SOFTWARE IS PROVIDED BY THE COPYRIGHT HOLDERS AND CONTRIBUTORS "AS IS" AND ANY EXPRESS OR IMPLIED WARRANTIES, INCLUDING, BUT NOT LIMITED TO, THE IMPLIED WARRANTIES OF MERCHANTABILITY AND FITNESS FOR A PARTICULAR PURPOSE ARE DISCLAIMED. IN NO EVENT SHALL THE COPYRIGHT OWNER OR CONTRIBUTORS BE LIABLE FOR ANY DIRECT, INDIRECT, INCIDENTAL, SPECIAL, EXEMPLARY, OR CONSEQUENTIAL DAMAGES (INCLUDING, BUT NOT LIMITED TO, PROCUREMENT OF SUBSTITUTE GOODS OR SERVICES; LOSS OF USE, DATA, OR PROFITS; OR BUSINESS INTERRUPTION) HOWEVER CAUSED AND ON ANY THEORY OF LIABILITY, WHETHER IN CONTRACT, STRICT LIABILITY, OR TORT (INCLUDING NEGLIGENCE OR OTHERWISE) ARISING IN ANY WAY OUT OF THE USE OF THIS SOFTWARE, EVEN IF ADVISED OF THE POSSIBILITY OF SUCH DAMAGE

FIRMWARE LICENSE TERMS

Copyright (c) ST Microelectronics

All rights reserved.

Redistribution. Redistribution and use in binary form, without modification, are

permitted provided that the following conditions are met:

* Redistributions must reproduce the above copyright notice and the following disclaimer in the documentation and/or other materials provided with the distribution.

* Neither the name of ST Microelectronics nor the names of its suppliers may be used to endorse or promote products derived from this software without specific prior written permission.

* No reverse engineering, decompilation, or disassembly of this software is permitted.

Limited patent license. ST Microelectronics grants a world-wide, royalty-free, non-exclusive license under patents it now or hereafter owns or controls to make, have made, use, import, offer to sell and sell ("Utilize") this software, but solely to the extent that any such patent is necessary to Utilize the software alone, or in combination with an operating system licensed under an approved Open Source license as listed by the Open Source Initiative at <http://opensource.org/licenses>. The patent license shall not apply to any other combinations which include this software. No hardware per se is licensed hereunder.

DISCLAIMER. THIS SOFTWARE IS PROVIDED BY THE COPYRIGHT HOLDERS AND CONTRIBUTORS "AS IS" AND ANY EXPRESS OR IMPLIED WARRANTIES, INCLUDING, BUT NOT LIMITED TO, THE IMPLIED WARRANTIES OF MERCHANTABILITY AND FITNESS FOR A PARTICULAR PURPOSE ARE DISCLAIMED.

STMicroelectronics has made every effort possible to ensure that this software is free of any bugs or errors; however, in no way is the software to be considered error or bug free. You assume all responsibility for any damages or lost data that may result from any errors or bugs in the software. IN NO EVENT WILL STMicroelectronics BE LIABLE TO YOU FOR ANY GENERAL, SPECIAL, INDIRECT, CONSEQUENTIAL, INCIDENTAL OR OTHER DAMAGES ARISING OUT OF THIS LICENSE.

Note

Explicit permission from ST Microelectronics was obtained to upload this firmware to the linux-firmware git repository under the ST Microelectronics firmware license above.

Copyright (c) 2016 Texas Instruments Incorporated

All rights reserved not granted herein.

Limited License.

Texas Instruments Incorporated grants a world-wide, royalty-free, non-exclusive license under copyrights and patents it now or hereafter owns or controls to make, have made, use, import, offer to sell and sell ("Utilize") this software subject to the terms herein. With respect to the foregoing patent license, such license is granted solely to the extent that any such patent is necessary to Utilize the software alone. The patent license shall not apply to any combinations which include this software, other than combinations with devices manufactured by or for TI ("TI Devices"). No hardware patent is licensed hereunder.

LICENCE TERMS (cont.)

Redistributions must preserve existing copyright notices and reproduce this license (including the above copyright notice and the disclaimer and (if applicable) source code license limitations below) in the documentation and/or other materials provided with the distribution

Redistribution and use in binary form, without modification, are permitted provided that the following conditions are met:

- * No reverse engineering, decompilation, or disassembly of this software is permitted with respect to any software provided in binary form.
- * any redistribution and use are licensed by TI for use only with TI Devices.
- * Nothing shall obligate TI to provide you with source code for the software licensed and provided to you in object code.

If software source code is provided to you, modification and redistribution of the source code are permitted provided that the following conditions are met:

- * any redistribution and use of the source code, including any resulting derivative works, are licensed by TI for use only with TI Devices.
- * any redistribution and use of any object code compiled from the source code and any resulting derivative works, are licensed by TI for use only with TI Devices.

Neither the name of Texas Instruments Incorporated nor the names of its suppliers may be used to endorse or promote products derived from this software without specific prior written permission.

DISCLAIMER.

THIS SOFTWARE IS PROVIDED BY TI AND TI'S LICENSORS "AS IS" AND ANY EXPRESS OR IMPLIED WARRANTIES, INCLUDING, BUT NOT LIMITED TO, THE IMPLIED WARRANTIES OF MERCHANTABILITY AND FITNESS FOR A PARTICULAR PURPOSE ARE DISCLAIMED. IN NO EVENT SHALL TI AND TI'S LICENSORS BE LIABLE FOR ANY DIRECT, INDIRECT, INCIDENTAL, SPECIAL, EXEMPLARY, OR CONSEQUENTIAL DAMAGES (INCLUDING, BUT NOT LIMITED TO, PROCUREMENT OF SUBSTITUTE GOODS OR SERVICES; LOSS OF USE, DATA, OR PROFITS; OR BUSINESS INTERRUPTION) HOWEVER CAUSED AND ON ANY THEORY OF LIABILITY, WHETHER IN CONTRACT, STRICT LIABILITY, OR TORT (INCLUDING NEGLIGENCE OR OTHERWISE) ARISING IN ANY WAY OUT OF THE USE OF THIS SOFTWARE, EVEN IF ADVISED OF THE POSSIBILITY OF SUCH DAMAGE.

Copyright (c) 2015 Texas Instruments Incorporated

All rights reserved not granted herein.

Limited License.

Texas Instruments Incorporated grants a world-wide, royalty-free, non-exclusive license under copyrights and patents it now or hereafter owns or controls to make, have made, use, import, offer to sell and sell ("Utilize") this software

subject to the terms herein. With respect to the foregoing patent license, such license is granted solely to the extent that any such patent is necessary to Utilize the software alone. The patent license shall not apply to any combinations which include this software, other than combinations with devices manufactured by or for TI ("TI Devices"). No hardware patent is licensed hereunder.

Redistributions must preserve existing copyright notices and reproduce this license (including the above copyright notice and the disclaimer and (if applicable) source code license limitations below) in the documentation and/or other materials provided with the distribution

Redistribution and use in binary form, without modification, are permitted provided that the following conditions are met:

- * No reverse engineering, decompilation, or disassembly of this software is permitted with respect to any software provided in binary form.
- * any redistribution and use are licensed by TI for use only with TI Devices.
- * Nothing shall obligate TI to provide you with source code for the software licensed and provided to you in object code.

If software source code is provided to you, modification and redistribution of the source code are permitted provided that the following conditions are met:

- * any redistribution and use of the source code, including any resulting derivative works, are licensed by TI for use only with TI Devices.
- * any redistribution and use of any object code compiled from the source code and any resulting derivative works, are licensed by TI for use only with TI Devices.

Neither the name of Texas Instruments Incorporated nor the names of its suppliers may be used to endorse or promote products derived from this software without specific prior written permission.

DISCLAIMER.

THIS SOFTWARE IS PROVIDED BY TI AND TI'S LICENSORS "AS IS" AND ANY EXPRESS OR IMPLIED WARRANTIES, INCLUDING, BUT NOT LIMITED TO, THE IMPLIED WARRANTIES OF MERCHANTABILITY AND FITNESS FOR A PARTICULAR PURPOSE ARE DISCLAIMED. IN NO EVENT SHALL TI AND TI'S LICENSORS BE LIABLE FOR ANY DIRECT, INDIRECT, INCIDENTAL, SPECIAL, EXEMPLARY, OR CONSEQUENTIAL DAMAGES (INCLUDING, BUT NOT LIMITED TO, PROCUREMENT OF SUBSTITUTE GOODS OR SERVICES; LOSS OF USE, DATA, OR PROFITS; OR BUSINESS INTERRUPTION) HOWEVER CAUSED AND ON ANY THEORY OF LIABILITY, WHETHER IN CONTRACT, STRICT LIABILITY, OR TORT (INCLUDING NEGLIGENCE OR OTHERWISE) ARISING IN ANY WAY OUT OF THE USE OF THIS SOFTWARE, EVEN IF ADVISED OF THE POSSIBILITY OF SUCH DAMAGE.

This license applies to eagle4 firmware & DSPcode namely, the files eagleIV.fw DSP4p.bin*

LICENCE TERMS (cont.)

Copyright (2006) Ikanos Communications, Inc.

Redistribution and use in source and binary forms, with or without modification, are permitted provided that the following conditions are met:

* Redistribution of source code must retain the above copyright notice, this list of conditions and the following disclaimer.

* Redistribution in binary form must reproduce the above copyright notice, this list of conditions and the following disclaimer in the documentation and/or other materials provided with the distribution.

* The name of Ikanos Corporation may not be used to endorse or promote products derived from this source code without specific prior written consent of Ikanos Corporation.

THIS SOFTWARE IS PROVIDED BY THE COPYRIGHT HOLDERS AND CONTRIBUTORS "AS IS" AND ANY EXPRESS OR IMPLIED WARRANTIES, INCLUDING, BUT NOT LIMITED TO, THE IMPLIED WARRANTIES OF MERCHANTABILITY AND FITNESS FOR A PARTICULAR PURPOSE ARE DISCLAIMED. IN NO EVENT SHALL THE COPYRIGHT OWNER OR CONTRIBUTORS BE LIABLE FOR ANY DIRECT, INDIRECT, INCIDENTAL, SPECIAL, EXEMPLARY, OR CONSEQUENTIAL DAMAGES (INCLUDING, BUT NOT LIMITED TO, PROCUREMENT OF SUBSTITUTE GOODS OR SERVICES; LOSS OF USE, DATA, OR PROFITS; OR BUSINESS INTERRUPTION) HOWEVER CAUSED AND ON ANY THEORY OF LIABILITY, WHETHER IN CONTRACT, STRICT LIABILITY, OR TORT (INCLUDING NEGLIGENCE OR OTHERWISE) ARISING IN ANY WAY OUT OF THE USE OF THIS SOFTWARE, EVEN IF ADVISED OF THE POSSIBILITY OF SUCH DAMAGE. USER ACKNOWLEDGES AND AGREES THAT THE PURCHASE OR USE OF THIS SOFTWARE WILL NOT CREATE OR GIVE GROUNDS FOR A LICENSE BY IMPLICATION, ESTOPPEL, OR OTHERWISE IN ANY INTELLECTUAL PROPERTY RIGHTS (PATENT, COPYRIGHT, TRADE SECRET, MASK WORK, OR OTHER PROPRIETARY RIGHT) EMBODIED IN ANY OTHER IKANOS HARDWARE OR SOFTWARE EITHER SOLELY OR IN COMBINATION WITH THIS SOFTWARE.

The following license applies to the binary-only VT6656 firmware as contained in the file "vntwusb.fw"

Copyright 1998-2010 VIA Technologies, Inc. All Rights Reserved.

Permission is hereby granted, free of charge, to any person obtaining a copy of this software and associated documentation files (the "Software"), to deal in the Software without restriction, including without limitation the rights to use, copy, modify, merge, publish, distribute, sublicense, and/or sell copies of the Software, and to permit persons to whom the Software is furnished to do so, subject to the following conditions:

The above copyright notice and this permission notice shall be included in all copies or substantial portions of the Software.

THE SOFTWARE IS PROVIDED "AS IS", WITHOUT WARRANTY OF ANY KIND, EXPRESS OR IMPLIED, INCLUDING BUT NOT LIMITED TO THE WARRANTIES

OF MERCHANTABILITY, FITNESS FOR A PARTICULAR PURPOSE AND NONINFRINGEMENT. IN NO EVENT SHALL THE AUTHORS OR COPYRIGHT HOLDERS BE LIABLE FOR ANY CLAIM, DAMAGES OR OTHER LIABILITY, WHETHER IN AN ACTION OF CONTRACT, TORT OR OTHERWISE, ARISING FROM, OUT OF OR IN CONNECTION WITH THE SOFTWARE OR THE USE OR OTHER DEALINGS IN THE SOFTWARE.

Copyright (c) 2000 – 2013 Texas Instruments Incorporated

All rights reserved not granted herein.

Limited License.

Texas Instruments Incorporated grants a world-wide, royalty-free, non-exclusive license under copyrights and patents it now or hereafter owns or controls to make, have made, use, import, offer to sell and sell ("Utilize") this software subject to the terms herein. With respect to the foregoing patent license, such license is granted solely to the extent that any such patent is necessary to Utilize the software alone. The patent license shall not apply to any combinations which include this software, other than combinations with devices manufactured by or for TI ("TI Devices"). No hardware patent is licensed hereunder.

Redistributions must preserve existing copyright notices and reproduce this license (including the above copyright notice and the disclaimer and (if applicable) source code license limitations below) in the documentation and/or other materials provided with the distribution

Redistribution and use in binary form, without modification, are permitted provided that the following conditions are met:

- * No reverse engineering, decompilation, or disassembly of this software is permitted with respect to any software provided in binary form.
- * any redistribution and use are licensed by TI for use only with TI Devices.
- * Nothing shall obligate TI to provide you with source code for the software licensed and provided to you in object code.

If software source code is provided to you, modification and redistribution of the source code are permitted provided that the following conditions are met:

- * any redistribution and use of the source code, including any resulting derivative works, are licensed by TI for use only with TI Devices.
- * any redistribution and use of any object code compiled from the source code and any resulting derivative works, are licensed by TI for use only with TI Devices.

Neither the name of Texas Instruments Incorporated nor the names of its suppliers may be used to endorse or promote products derived from this software without specific prior written permission.

DISCLAIMER.

LICENCE TERMS (cont.)

THIS SOFTWARE IS PROVIDED BY TI AND TI'S LICENSORS "AS IS" AND ANY EXPRESS OR IMPLIED WARRANTIES, INCLUDING, BUT NOT LIMITED TO, THE IMPLIED WARRANTIES OF MERCHANTABILITY AND FITNESS FOR A PARTICULAR PURPOSE ARE DISCLAIMED. IN NO EVENT SHALL TI AND TI'S LICENSORS BE LIABLE FOR ANY DIRECT, INDIRECT, INCIDENTAL, SPECIAL, EXEMPLARY, OR CONSEQUENTIAL DAMAGES (INCLUDING, BUT NOT LIMITED TO, PROCUREMENT OF SUBSTITUTE GOODS OR SERVICES; LOSS OF USE, DATA, OR PROFITS; OR BUSINESS INTERRUPTION) HOWEVER CAUSED AND ON ANY THEORY OF LIABILITY, WHETHER IN CONTRACT, STRICT LIABILITY, OR TORT (INCLUDING NEGLIGENCE OR OTHERWISE) ARISING IN ANY WAY OUT OF THE USE OF THIS SOFTWARE, EVEN IF ADVISED OF THE POSSIBILITY OF SUCH DAMAGE.

The following XC4000 firmware file "dvh-fe-xc4000-1.4.1.fw" was created based on version 1.4 of "xc4000_firmwares.h".

Firmware provided as part of an XC4000 Linux developers kit by Brian Mathews <bmathews@xceive.com> to Devin Heitmueller <dheitmueller@kernellabs.org> on July 1, 2009.

The code was released by Xceive under the following license:

```
// Copyright (c) 2009, Xceive Corporation <info@xceive.com>
//
// Permission to use, copy, modify, and/or distribute this software, only
// for use with Xceive ICs, for any purpose with or without fee is hereby
// granted, provided that the above copyright notice and this permission
// notice appear in all source code copies.
//
// THE SOFTWARE IS PROVIDED "AS IS" AND THE AUTHOR DISCLAIMS ALL WARRANTIES
// WITH REGARD TO THIS SOFTWARE INCLUDING ALL IMPLIED WARRANTIES OF
// MERCHANTABILITY AND FITNESS. IN NO EVENT SHALL THE AUTHOR BE LIABLE FOR
// ANY SPECIAL, DIRECT, INDIRECT, OR CONSEQUENTIAL DAMAGES OR ANY DAMAGES
// WHATSOEVER RESULTING FROM LOSS OF USE, DATA OR PROFITS, WHETHER IN AN
// ACTION OF CONTRACT, NEGLIGENCE OR OTHER TORTIOUS ACTION, ARISING OUT OF
// OR IN CONNECTION WITH THE USE OR PERFORMANCE OF THIS SOFTWARE.
```

The following XC5000 firmware file "dvh-fe-xc5000-1.6.114.fw" was created based on "xc5000_firmwares_32000Khz.h".

Firmware provided as part of an XC5000 Linux developers kit by Brian Mathews <bmathews@xceive.com> to Devin Heitmueller <dheitmueller@linuxtv.org> on July 1, 2009.

The code was released by Xceive under the following license:

```
// Copyright (c) 2009, Xceive Corporation <info@xceive.com>
//
// Permission to use, copy, modify, and/or distribute this software, only
// for use with Xceive ICs, for any purpose with or without fee is hereby
// granted, provided that the above copyright notice and this permission
// notice appear in all source code copies.
//
// THE SOFTWARE IS PROVIDED "AS IS" AND THE AUTHOR DISCLAIMS ALL WARRANTIES
// WITH REGARD TO THIS SOFTWARE INCLUDING ALL IMPLIED WARRANTIES OF
```

```
// MERCHANTABILITY AND FITNESS. IN NO EVENT SHALL THE AUTHOR BE LIABLE FOR
// ANY SPECIAL, DIRECT, INDIRECT, OR CONSEQUENTIAL DAMAGES OR ANY DAMAGES
// WHATSOEVER RESULTING FROM LOSS OF USE, DATA OR PROFITS, WHETHER IN AN
// ACTION OF CONTRACT, NEGLIGENCE OR OTHER TORTIOUS ACTION, ARISING OUT OF
// OR IN CONNECTION WITH THE USE OR PERFORMANCE OF THIS SOFTWARE.
```

The following XC5000C firmware file "dvh-fe-xc5000C-4.1.30.7.fw" was created based on "Xc5200_firmwares_32000Khz.h".

Firmware provided as part of an XC5000C Linux developers kit by Ramon Cazares <Ramon.Cazares@CrestaTech.com> to Devin Heitmueller <dheitmueller@linuxtv.org> on July 25, 2012.

The code was released by Cresta Technology under the following license:

```
// Copyright (c) 2012, Cresta Technology Corporation <info@crestatech.com>
//
// Permission to use, copy, modify, and/or distribute this software, only
// for use with Cresta Technology ICs, for any purpose with or without fee is
// hereby granted, provided that the above copyright notice and this
// permission notice appear in all source code copies.
//
// THE SOFTWARE IS PROVIDED "AS IS" AND THE AUTHOR DISCLAIMS ALL WARRANTIES
// WITH REGARD TO THIS SOFTWARE INCLUDING ALL IMPLIED WARRANTIES OF
// MERCHANTABILITY AND FITNESS. IN NO EVENT SHALL THE AUTHOR BE LIABLE FOR
// ANY SPECIAL, DIRECT, INDIRECT, OR CONSEQUENTIAL DAMAGES OR ANY DAMAGES
// WHATSOEVER RESULTING FROM LOSS OF USE, DATA OR PROFITS, WHETHER IN AN
// ACTION OF CONTRACT, NEGLIGENCE OR OTHER TORTIOUS ACTION, ARISING OUT OF
// OR IN CONNECTION WITH THE USE OR PERFORMANCE OF THIS SOFTWARE.
```

Copyright (c) 2018, Cadence Design Systems, Inc.
All rights reserved.

Redistribution. Redistribution and use in binary form, without modification, are permitted provided that the following conditions are met:

- * Redistributions must reproduce the above copyright notice and the following disclaimer in the documentation and/or other materials provided with the distribution.
- * Neither the name of Cadence Design Systems, Inc., its products nor the names of its suppliers may be used to endorse or promote products derived from this Software without specific prior written permission.
- * No reverse engineering, decompilation, or disassembly of this software is permitted.

DISCLAIMER. THIS SOFTWARE IS PROVIDED BY THE COPYRIGHT HOLDERS AND CONTRIBUTORS "AS IS" AND ANY EXPRESS OR IMPLIED WARRANTIES, INCLUDING, BUT NOT LIMITED TO, THE IMPLIED WARRANTIES OF MERCHANTABILITY AND FITNESS FOR A PARTICULAR PURPOSE ARE DISCLAIMED. IN NO EVENT SHALL THE COPYRIGHT OWNER OR CONTRIBUTORS BE LIABLE FOR ANY DIRECT, INDIRECT,

LICENCE TERMS (cont.)

INCIDENTAL, SPECIAL, EXEMPLARY, OR CONSEQUENTIAL DAMAGES (INCLUDING, BUT NOT LIMITED TO, PROCUREMENT OF SUBSTITUTE GOODS OR SERVICES; LOSS OF USE, DATA, OR PROFITS; OR BUSINESS INTERRUPTION) HOWEVER CAUSED AND ON ANY THEORY OF LIABILITY, WHETHER IN CONTRACT, STRICT LIABILITY, OR TORT (INCLUDING NEGLIGENCE OR OTHERWISE) ARISING IN ANY WAY OUT OF THE USE OF THIS SOFTWARE, EVEN IF ADVISED OF THE POSSIBILITY OF SUCH DAMAGE.

This software contains:

HDCP Cipher is licensed under the FreeBSD license. A copy of the FreeBSD license can be found at <https://www.freebsd.org/copyright/freebsd-license.html>. The source code for HDCP Cipher can be found here: <http://www3.cs.stonybrook.edu/~rob/hdcp.html>

SSL Library is licensed under the Apache License, Version 2.0. A copy of the Apache License, Version 2.0 can be found at <http://www.apache.org/licenses/LICENSE-2.0>. The original source code for SSL Library can be found here: <https://tls.mbed.org/download>

Fast discrete Fourier and cosine transforms and inverses
author: Monty <xiphmont@mit.edu>
modifications by: Monty
last modification date: Jul 1 1996

/* These Fourier routines were originally based on the Fourier routines of the same names from the NETLIB bihar and fftpack fortran libraries developed by Paul N. Swarztrauber at the National Center for Atmospheric Research in Boulder, CO USA. They have been reimplemented in C and optimized in a few ways for OggSquish. */

/* As the original fortran libraries are public domain, the C Fourier routines in this file are hereby released to the public domain as well. The C routines here produce output exactly equivalent to the original fortran routines. Of particular interest are the facts that (like the original fortran), these routines can work on arbitrary length vectors that need not be powers of two in length. */

* WHENCE *

This file attempts to document the origin and licensing information, if known, for each piece of firmware distributed for use with the Linux kernel.

Driver: BCM-0bb4-0306 Cypress Bluetooth firmware for HTC Vive

File: brcm/BCM-0bb4-0306.hcd

License: Redistributable. See LICENCE.cypress for details.

Driver: ambassador -- Madge Ambassador (Collage PCI 155 Server) ATM NIC.

File: atmsar11.fw

License: Allegedly GPLv2+, but no source visible. Marked:

Madge Ambassador ATM Adapter microcode.
Copyright (C) 1995-1999 Madge Networks Ltd.

This microcode data is placed under the terms of the GNU General Public License. The GPL is contained in /usr/doc/copyright/GPL on a Debian system and in the file COPYING in the Linux kernel source.

We would prefer you not to distribute modified versions without consultation and not to ask for assembly/other microcode source.

Driver: snd-korg1212 -- Korg 1212 IO audio device

File: korg/k1212.dsp

License: Unknown

Found in alsa-firmware package in hex form; no licensing information.

Driver: snd-maestro3 -- ESS Allegro Maestro3 audio device

File: ess/maestro3_assp_kernel.fw
File: ess/maestro3_assp_minisc.fw

License: Unknown

Found in alsa-firmware package in hex form with a comment claiming to be GPLv2+, but without source -- and with another comment saying "ESS drops binary dsp code images on our heads, but we don't get to see specs on the dsp."

Driver: snd-ymfpici -- Yamaha YMF724/740/744/754 audio devices

File: yamaha/ds1_ctrl.fw
File: yamaha/ds1_dsp.fw
File: yamaha/ds1e_ctrl.fw

License: Unknown

Found alsa-firmware package in hex form, with the following comment:
Copyright (c) 1997-1999 Yamaha Corporation. All Rights Reserved.

Driver: advansys - AdvanSys SCSI

File: advansys/mcode.bin
File: advansys/3550.bin
File: advansys/38C0800.bin
File: advansys/38C1600.bin

Licence: BSD, no source available.

Found in hex form in kernel source.

Driver: qla1280 - Qlogic QLA 1240/1x80/1x160 SCSI support

File: qllogic/1040.bin
File: qllogic/1280.bin
File: qllogic/12160.bin

Licence: Redistributable. See LICENCE.qla1280 for details

Driver: smctr -- SMC ISA/MCA Token Ring adapter

File: tr_smctr.bin
Version: 6.3C1
Info: MCT.BIN v6.3C1 03/01/95

Original licence info:

* This firmware is licensed to you strictly for use in conjunction
* with the use of SMC TokenRing adapters. There is no warranty
* expressed or implied about its fitness for any purpose.

Driver: kaweth -- USB KLSI KL5USB101-based Ethernet device

File: kaweth/new_code.bin
File: kaweth/new_code_fix.bin
File: kaweth/trigger_code.bin
File: kaweth/trigger_code_fix.bin

Licence: Redistributable. See LICENCE.kaweth for details

Found in hex form in the kernel source.

Driver: dvb-ttusb-budget -- Technotrend/Hauppauge Nova-USB devices

File: ttusb-budget/dspbootcode.bin

Licence: Unknown

Found in hex form in the kernel source.

Driver: keyspan -- USB Keyspan USA-xxx serial device

File: keyspan/mpr.fw
File: keyspan/usa18x.fw
File: keyspan/usa19.fw
File: keyspan/usa19qi.fw
File: keyspan/usa19qw.fw
File: keyspan/usa19w.fw
File: keyspan/usa28.fw
File: keyspan/usa28xa.fw
File: keyspan/usa28xb.fw
File: keyspan/usa28x.fw
File: keyspan/usa49w.fw
File: keyspan/usa49wlc.fw

Converted from Intel HEX files, used in our binary representation of ihex.

Original licence information:

Copyright (C) 1999-2001
Keyspan, A division of InnoSys Incorporated ("Keyspan")

as an unpublished work. This notice does not imply unrestricted or public access to the source code from which this firmware image is derived. Except as noted below this firmware image may not be reproduced, used, sold or transferred to any third party without Keyspan's prior written consent. All Rights Reserved.

Permission is hereby granted for the distribution of this firmware image as part of a Linux or other Open Source operating system kernel in text or binary form as required.

This firmware may not be modified and may only be used with Keyspan hardware. Distribution and/or Modification of the keyspan.c driver which includes this firmware, in whole or in part, requires the inclusion of this statement."

Driver: keyspan_pda -- USB Keyspan PDA single-port serial device

File: keyspan_pda/keyspan_pda.fw
Source: keyspan_pda/keyspan_pda.S

File: keyspan_pda/xircom_pgs.fw
Source: keyspan_pda/xircom_pgs.S

Source: keyspan_pda/Makefile

Licence: GPLv2 or later. See GPL-2 and GPL-3 for details.

LICENCE TERMS (cont.)

Compiled from original 8051 source into Intel HEX, used in our binary ihex form.

Driver: emi26 -- EMI 2|6 USB Audio interface

File: emi26/bitstream.fw
Version: 1.1.1.131
Info: DATE=2001dec06

File: emi26/firmware.fw
Version: 1.0.2.916
Info: DATE=12.02.2002

File: emi26/loader.fw

Converted from Intel HEX files, used in our binary representation of ihex.

Original licence information:

```
/*
 * This firmware is for the Emagic EMI 2|6 Audio Interface
 *
 * The firmware contained herein is Copyright (c) 1999-2002 Emagic
 * as an unpublished work. This notice does not imply unrestricted
 * or public access to this firmware which is a trade secret of Emagic,
 * and which may not be reproduced, used, sold or transferred to
 * any third party without Emagic's written consent. All Rights Reserved.
 *
 * Permission is hereby granted for the distribution of this firmware
 * image as part of a Linux or other Open Source operating system kernel
 * in text or binary form as required.
 *
 * This firmware may not be modified and may only be used with the
 * Emagic EMI 2|6 Audio Interface. Distribution and/or Modification of
 * any driver which includes this firmware, in whole or in part,
 * requires the inclusion of this statement.
 */
```

Driver: emi62 -- EMI 6|2m USB Audio interface

File: emi62/bitstream.fw
Version: 1.0.0.191
Info: DATE= 2002oct28

File: emi62/loader.fw
Version: 1.0.2.002
Info: DATE=10.01.2002

File: emi62/midi.fw
Version: 1.04.062
Info: DATE=16.10.2002

File: emi62/spdif.fw
Version: 1.04.062
Info: DATE=16.10.2002

Converted from Intel HEX files, used in our binary representation of ihex.

Original licence information: None

Driver: ti_usb_3410_5052 -- USB TI 3410/5052 serial device

File: ti_3410.fw
Info: firmware 9/10/04 FW3410_Special_StartWdogOnStartPort

File: ti_5052.fw
Info: firmware 9/18/04

Licence: Allegedly GPLv2+, but no source visible. Marked:
Copyright (C) 2004 Texas Instruments

Found in hex form in kernel source.

Driver: ti_usb_3410_5052 -- Multi-Tech USB cell modems

File: mts_cdma.fw
File: mts_gsm.fw
File: mts_edge.fw

Licence: "all firmware components are redistributable in binary form"
per support@multitech.com
Copyright (C) 2005 Multi-Tech Systems, Inc.

Found in hex form in ftp://ftp.multitech.com/wireless/wireless_linux.zip

Driver: ti_usb_3410_5052 -- Multi-Tech USB fax modems

File: mts_mt9234mu.fw
File: mts_mt9234zba.fw

Licence: Unknown

Driver: whiteheat -- USB ConnectTech WhiteHEAT serial device

File: whiteheat.fw
Version: 4.06

File: whiteheat_loader.fw

Licence: Allegedly GPLv2, but no source visible. Marked:
Copyright (C) 2000-2002 ConnectTech Inc

Debug loader claims the following behaviour:

Port 1 LED flashes when the vend_ax program is running
Port 2 LED flashes when any SETUP command arrives

LICENCE TERMS (cont.)

Port 3 LED flashes when any valid VENDOR request occurs
Port 4 LED flashes when the EXTERNAL RAM DOWNLOAD request occurs

Converted from Intel HEX files, used in our binary representation of ihex.

Driver: ip2 -- Computone IntelliPort Plus serial device

File: intelliport2.bin

Licence: Unknown

Found in hex form in kernel source.

Driver: cpia2 -- cameras based on Vision's CPiA2

File: cpia2/stv0672_vp4.bin

Licence: Allegedly GPLv2+, but no source visible. Marked:
Copyright (C) 2001 STMicroelectronics, Inc.
Contact: steve.miller@st.com
Description: This file contains patch data for the CPiA2 (stv0672) VP4.

Found in hex form in kernel source.

Driver: dabusb -- Digital Audio Broadcasting (DAB) Receiver for USB and Linux

File: dabusb/firmware.fw
File: dabusb/bitstream.bin

Licence: Distributable

* Copyright (C) 1999 BayCom GmbH

*

* Redistribution and use in source and binary forms, with or without
* modification, are permitted provided that redistributions of source
* code retain the above copyright notice and this comment without
* modification.

Driver: vicam -- USB 3com HomeConnect (aka vicam)

File: vicam/firmware.fw

Licence: Unknown

Found in hex form in kernel source.

Driver: io_edgeport - USB Inside Out Edgeport Serial Driver

File: edgeport/boot.fw
File: edgeport/boot2.fw
File: edgeport/down.fw
File: edgeport/down2.fw

Licence: Allegedly GPLv2+, but no source visible. Marked:
/*
/* Edgeport/4 Binary Image
/* Generated by HEX2C v1.06
/* Copyright (C) 1998 Inside Out Networks, All rights reserved.
/*

Found in hex form in kernel source.

Driver: io_ti - USB Inside Out Edgeport Serial Driver
(TI Devices)

File: edgeport/down3.bin

Licence:
/*
/* Edgeport Binary Image (for TI based products)
/* Generated by TIBin2C v2.00 (watchport)
/* Copyright (C) 2001 Inside Out Networks, All rights reserved.
/*

Found in hex form in kernel source.

Driver: dsp56k - Atari DSP56k support

File: dsp56k/bootstrap.bin
Source: dsp56k/bootstrap.asm
Source: dsp56k/Makefile
Source: dsp56k/concat-bootstrap.pl

Licence: GPLv2 or later. See GPL-2 and GPL-3 for details.

DSP56001 assembler, buildable with a56 from
<http://www.zdomain.com/a56.html>

Driver: snd-sb16-csp - Sound Blaster 16/AWE CSP support

File: sb16/mulaw_main.csp
File: sb16/alaw_main.csp
File: sb16/ima_adpcm_init.csp
File: sb16/ima_adpcm_playback.csp
File: sb16/ima_adpcm_capture.csp

LICENCE TERMS (cont.)

Licence: Allegedly GPLv2+, but no source visible. Marked:

/*

* Copyright (c) 1994 Creative Technology Ltd.

* Microcode files for SB16 Advanced Signal Processor

*/

Found in hex form in kernel source.

Driver: qla2xxx - QLogic QLA2XXX Fibre Channel

File: ql2100_fw.bin

Version: 1.19.38 TP

File: ql2200_fw.bin

Version: 2.02.08 TP

File: ql2300_fw.bin

Version: 3.03.28 IPX

File: ql2322_fw.bin

Version: 3.03.28 IPX

File: ql2400_fw.bin

Version: 8.07.00 MID

File: ql2500_fw.bin

Version: 8.07.00 MIDQ

Licence: Redistributable. See LICENCE.qla2xxx for details

Available from <http://ldriver.qlogic.com/firmware/>

Driver: orinoco - Agere/Prism/Symbol Orinoco support

File: agere_sta_fw.bin

Version: 9.48 Hermes I

File: agere_ap_fw.bin

Version: 9.48 Hermes I

Licence: Redistributable. See LICENCE.agere for details

Driver: ar9170 - Atheros 802.11n "otus" USB

File: ar9170-1.fw

File: ar9170-2.fw

Licence: Redistributable. See LICENCE.atheros_firmware for details

Driver: ath9k_htc - Atheros HTC devices (USB)

File: ar9271.fw

File: ar7010.fw

File: ar7010_1_1.fw

File: htc_9271.fw

Version: 1.3.1

File: htc_7010.fw

Version: 1.3.1

Licence: Redistributable. See LICENCE.atheros_firmware for details

File: ath9k_htc/htc_7010-1.4.0.fw

Version: 1.4.0

File: ath9k_htc/htc_9271-1.4.0.fw

Version: 1.4.0

Licence: Free software. See LICENCE.open-ath9k-htc-firmware for details

Driver: cassini - Sun Cassini

File: sun/cassini.bin

Licence: Unknown

Found in hex form in kernel source.

Driver: slicoss - Alacritech IS-NIC products

File: slicoss/gbdownload.sys

File: slicoss/gbrcvucode.sys

File: slicoss/oasisdbgdownload.sys

File: slicoss/oasisdownload.sys

File: slicoss/oasisrcvucode.sys

Licence:

Copyright (C) 1999-2009 Alacritech, Inc.

as an unpublished work. This notice does not imply unrestricted or public access to the source code from which this firmware image is derived. Except as noted below this firmware image may not be reproduced, used, sold or transferred to any third party without Alacritech's prior written consent. All Rights Reserved.

Permission is hereby granted for the distribution of this firmware image as part of a Linux or other Open Source operating system kernel in text or binary form as required.

This firmware may not be modified.

Found in hex form in kernel source.

Driver: sxg - Alacritech IS-NIC products

File: sxg/saharadownloadB.sys

File: sxg/saharadbdownloadB.sys

LICENCE TERMS (cont.)

Licence:

Copyright (C) 1999-2009 Alacritech, Inc.

as an unpublished work. This notice does not imply unrestricted or public access to the source code from which this firmware image is derived. Except as noted below this firmware image may not be reproduced, used, sold or transferred to any third party without Alacritech's prior written consent. All Rights Reserved.

Permission is hereby granted for the distribution of this firmware image as part of a Linux or other Open Source operating system kernel in text or binary form as required.

This firmware may not be modified.

Found in hex form in kernel source.

Driver: cxgb3 - Chelsio Terminator 3 1G/10G Ethernet adapter

File: cxgb3/t3b_psram-1.1.0.bin
File: cxgb3/t3c_psram-1.1.0.bin
File: cxgb3/t3fw-7.0.0.bin
File: cxgb3/t3fw-7.1.0.bin
File: cxgb3/t3fw-7.4.0.bin
File: cxgb3/t3fw-7.10.0.bin
File: cxgb3/t3fw-7.12.0.bin

Licence: GPLv2 or OpenIB.org BSD license, no source visible

Driver: cxgb3 - Chelsio Terminator 3 1G/10G Ethernet adapter

File: cxgb3/ael2005_opt_edc.bin
File: cxgb3/ael2005_twx_edc.bin
File: cxgb3/ael2020_twx_edc.bin

Licence:

* Copyright (c) 2007-2009 NetLogic Microsystems, Inc.

*
* Permission is hereby granted for the distribution of this firmware
* data in hexadecimal or equivalent format, provided this copyright
* notice is accompanying it.

Found in hex form in kernel source.

Driver: cxgb4 - Chelsio Terminator 4/5/6 1/10/25/40/100G Ethernet adapter

File: cxgb4/t4fw-1.14.4.0.bin
File: cxgb4/t4fw-1.15.37.0.bin
File: cxgb4/t4fw-1.24.3.0.bin
Link: cxgb4/t4fw.bin -> t4fw-1.24.3.0.bin
File: cxgb4/t5fw-1.14.4.0.bin

File: cxgb4/t5fw-1.15.37.0.bin
File: cxgb4/t5fw-1.24.3.0.bin
Link: cxgb4/t5fw.bin -> t5fw-1.24.3.0.bin
File: cxgb4/t6fw-1.24.3.0.bin
Link: cxgb4/t6fw.bin -> t6fw-1.24.3.0.bin
File: cxgb4/aaq1202_fw.cld
File: cxgb4/bcm8483.bin

Licence: Redistributable. See LICENCE.chelsio_firmware for details

Driver: e100 -- Intel PRO/100 Ethernet NIC

File: e100/d101m_ucose.bin
File: e100/d101s_ucose.bin
File: e100/d102e_ucose.bin

Licence: Redistributable. See LICENCE.e100 for details

Driver: acenic -- Alteon AceNIC Gigabit Ethernet card

File: acenic/tg1.bin
File: acenic/tg2.bin

Licence: Unknown

Found in hex form in kernel source, but source allegedly available at <http://alteon.shareable.org/>

Driver: tg3 -- Broadcom Tigon3 based gigabit Ethernet cards

File: tigon/tg3.bin
File: tigon/tg3_tso.bin
File: tigon/tg3_tso5.bin
File: tigon/tg357766.bin

Licence:

* Firmware is:

* Derived from proprietary unpublished source code,
* Copyright (C) 2000-2013 Broadcom Corporation.

*
* Permission is hereby granted for the distribution of this firmware
* data in hexadecimal or equivalent format, provided this copyright
* notice is accompanying it.

Found in hex form in kernel source.

Driver: starfire - Adaptec Starfire/DuraLAN support

File: adaptec/starfire_rx.bin

LICENCE TERMS (cont.)

File: adaptec/starfire_tx.bin

Licence: Allegedly GPLv2, but no source visible.

Found in hex form in kernel source, with the following notice:

BECAUSE THE PROGRAM IS LICENSED FREE OF CHARGE IT IS LICENSED "AS IS" AND THERE IS NO WARRANTY FOR THE PROGRAM, INCLUDING BUT NOT LIMITED TO THE IMPLIED WARRANTIES OF MERCHANTABILITY OR FITNESS FOR A PARTICULAR PURPOSE (TO THE EXTENT PERMITTED BY APPLICABLE LAW). USE OF THE PROGRAM IS AT YOUR OWN RISK. IN NO EVENT WILL ADAPTEC OR ITS LICENSORS BE LIABLE TO YOU FOR DAMAGES, INCLUDING ANY GENERAL, SPECIAL, INCIDENTAL OR CONSEQUENTIAL DAMAGES ARISING OUT OF THE USE OR INABILITY TO USE THE PROGRAM.

Driver: i2400m-usb - Intel 2400 Wireless WiMAX Connection over USB

File: i2400m-fw-usb-1.4.sbcf
File: i2400m-fw-usb-1.5.sbcf
File: i6050-fw-usb-1.5.sbcf

Licence: Redistributable. See LICENCE.i2400m for details

Also available from <http://linuxwimax.org/Download>

Driver: libertas - Marvell Libertas fullmac-type 802.11b/g cards

File: libertas/cf8381.bin
File: libertas/cf8381_helper.bin
File: libertas/cf8385.bin
File: libertas/cf8385_helper.bin
File: libertas/gspi8682.bin
File: libertas/gspi8682_helper.bin
File: libertas/gspi8686_v9.bin
File: libertas/gspi8686_v9_helper.bin
File: libertas/gspi8688.bin
File: libertas/gspi8688_helper.bin
File: libertas/sd8385.bin
File: libertas/sd8385_helper.bin
File: libertas/sd8682.bin
File: libertas/sd8682_helper.bin
File: libertas/sd8686_v8.bin
File: libertas/sd8686_v8_helper.bin
File: libertas/sd8686_v9.bin
File: libertas/sd8686_v9_helper.bin
File: libertas/usb8388_v5.bin
File: libertas/usb8388_v9.bin
File: libertas/usb8682.bin
File: mrvl/sd8688.bin
Link: libertas/sd8688.bin -> ../mrvl/sd8688.bin
File: mrvl/sd8688_helper.bin
Link: libertas/sd8688_helper.bin -> ../mrvl/sd8688_helper.bin

Licence: Redistributable. See LICENCE.Marvell for details. Extracted from

Linux driver tarballs downloaded from Marvell's "Extranet" with permission.

Driver: libertas - Marvell Libertas 802.11b/g cards, OLPC firmware

File: libertas/lbtf_sdio.bin
Version: 9.0.7.p4

File: lbtf_usb.bin
Version: 5.132.3.p1

File: libertas/usb8388_olpc.bin
Version: 5.110.22.p23

Licence: Redistributable. See LICENCE.OLPC for details.

Available from <http://dev.laptop.org/pub/firmware/libertas/>

Driver: mw18k - Marvell Libertas softmac-type 802.11b/g/n cards

File: mw18k/fmimage_8687.fw
File: mw18k/helper_8687.fw
File: mw18k/fmimage_8366.fw
File: mw18k/fmimage_8366_ap-1.fw
File: mw18k/fmimage_8366_ap-2.fw
File: mw18k/fmimage_8366_ap-3.fw
Version: 5.2.8.16
File: mw18k/helper_8366.fw

File: mw18k/fmimage_8764_ap-1.fw
Version: 7.4.0.9

Licence: Redistributable. See LICENCE.Marvell for details. 8687 images downloaded from Marvell's "Extranet" with permission. 8366 images contributed directly by Marvell.

Driver: mwifiex - Marvell Wi-Fi fullmac-type 802.11n/ac cards

File: mrvl/sd8787_uapsta.bin
Version: W14.68.35.p66

File: mrvl/usb8766_uapsta.bin
Version: 14.68.22.p16

File: mrvl/sd8797_uapsta.bin
Version: W14.68.29.p59

File: mrvl/usb8797_uapsta.bin
Version: W14.68.29.p60

File: mrvl/sd8897_uapsta.bin
Version: W15.68.19.17

LICENCE TERMS (cont.)

File: mrvl/usb8897_uapsta.bin
Version: 15.68.4.p103

File: mrvl/pcie8897_uapsta.bin
Version: W15.68.19.p21

File: mrvl/sd8887_uapsta.bin
Version: W15.68.7.p189

File: mrvl/sd8801_uapsta.bin
Version: W14.68.36.p204

File: mrvl/usb8801_uapsta.bin
Version: W14.68.36.p138

File: mrvl/pcieuart8997_combo_v4.bin
Version: W16.68.1.p179

File: mrvl/pcieusb8997_combo_v4.bin
Version: W16.68.1.p195

File: mrvl/pcie8997_wlan_v4.bin
Version: W16.68.1.p195

File: mrvl/usbusb8997_combo_v4.bin
Version: W16.68.1.p183

File: mrvl/sdsd8997_combo_v4.bin
Version: W16.68.1.p179

File: mrvl/sdsd8977_combo_v2.bin
Version: W16.68.1.p195

Licence: Redistributable. See LICENCE.Marvell for details. Originates from <http://git.marvell.com/?p=mwififex-firmware.git>

Driver: iwlwifi - Intel Wireless Wifi

File: iwlwifi-3945-2.ucode
Version: 15.32.2.9

File: iwlwifi-4965-2.ucode
Version: 228.61.2.24

File: iwlwifi-5000-1.ucode
Version: 5.4.A.11 (aka 5.4.1.16)

File: iwlwifi-5000-2.ucode
Version: 8.24.2.12

File: iwlwifi-5000-5.ucode
Version: 8.83.5.1

File: iwlwifi-5150-2.ucode

Version: 8.24.2.2

File: iwlwifi-1000-3.ucode
Version: 128.50.3.1

File: iwlwifi-1000-5.ucode
Version: 39.31.5.1

File: iwlwifi-6000-4.ucode
Version: 9.221.4.1

File: iwlwifi-6050-4.ucode
Version: 9.201.4.1

File: iwlwifi-6050-5.ucode
Version: 41.28.5.1

File: iwlwifi-6000g2a-5.ucode
Version: 17.168.5.3

File: iwlwifi-6000g2a-6.ucode
Version: 18.168.6.1

File: iwlwifi-6000g2b-5.ucode
Version: 17.168.5.1

File: iwlwifi-6000g2b-6.ucode
Version: 18.168.6.1

File: iwlwifi-135-6.ucode
Version: 18.168.6.1

File: iwlwifi-100-5.ucode
Version: 39.31.5.1

File: iwlwifi-105-6.ucode
Version: 18.168.6.1

File: iwlwifi-2030-6.ucode
Version: 18.168.6.1

File: iwlwifi-2000-6.ucode
Version: 18.168.6.1

File: iwlwifi-7260-7.ucode
Version: 22.1.7.0

File: iwlwifi-7260-8.ucode
Version: 22.24.8.0

File: iwlwifi-7260-9.ucode
Version: 25.228.9.0

File: iwlwifi-7260-10.ucode
Version: 23.15.10.0

File: iwlwifi-7260-12.ucode

LICENCE TERMS (cont.)

Version: 25.17.12.0

File: iwlwifi-7260-13.ucode

Version: 25.30.13.0

File: iwlwifi-7260-16.ucode

Version: 16.242414.0

File: iwlwifi-7260-17.ucode

Version: 17.bfb58538.0

File: iwlwifi-3160-7.ucode

Version: 22.1.7.0

File: iwlwifi-3160-8.ucode

Version: 22.24.8.0

File: iwlwifi-3160-9.ucode

Version: 25.228.9.0

File: iwlwifi-3160-10.ucode

Version: 23.15.10.0

File: iwlwifi-3160-12.ucode

Version: 25.17.12.0

File: iwlwifi-3160-13.ucode

Version: 25.30.13.0

File: iwlwifi-3160-16.ucode

Version: 16.242414.0

File: iwlwifi-3160-17.ucode

Version: 17.bfb58538.0

File: iwlwifi-7265-8.ucode

Version: 22.24.8.0

File: iwlwifi-7265-9.ucode

Version: 25.228.9.0

File: iwlwifi-7265-10.ucode

Version: 23.15.10.0

File: iwlwifi-7265-12.ucode

Version: 25.17.12.0

File: iwlwifi-7265-13.ucode

Version: 25.30.13.0

File: iwlwifi-7265-16.ucode

Version: 16.242414.0

File: iwlwifi-7265-17.ucode

Version: 17.bfb58538.0

File: iwlwifi-7265D-10.ucode

Version: 23.15.10.0

File: iwlwifi-7265D-12.ucode

Version: 25.17.12.0

File: iwlwifi-7265D-13.ucode

Version: 25.30.13.0

File: iwlwifi-7265D-16.ucode

Version: 16.242414.0

File: iwlwifi-7265D-17.ucode

Version: 17.352738.0

File: iwlwifi-7265D-21.ucode

Version: 21.302800.0

File: iwlwifi-7265D-22.ucode

Version: 22.391740.0

File: iwlwifi-7265D-27.ucode

Version: 27.541033.0

File: iwlwifi-7265D-29.ucode

Version: 29.3e3b4de5.0

File: iwlwifi-3168-21.ucode

Version: 21.302800.0

File: iwlwifi-3168-22.ucode

Version: 22.391740.0

File: iwlwifi-3168-27.ucode

Version: 27.541033.0

File: iwlwifi-3168-29.ucode

Version: 29.3e3b4de5.0

File: iwlwifi-8000C-13.ucode

Version: 25.30.13.0

File: iwlwifi-8000C-16.ucode

Version: 16.242414.0

File: iwlwifi-8000C-21.ucode

Version: 21.302800.0

File: iwlwifi-8000C-22.ucode

Version: 22.391740.0

File: iwlwifi-8000C-27.ucode

Version: 27.541033.0

File: iwlwifi-8000C-31.ucode

Version: 31.560484.0

File: iwlwifi-8000C-34.ucode

LICENCE TERMS (cont.)

Version: 34.610288.0

File: iwlwifi-8000C-36.ucode
Version: 36.8fd77bb3.0

File: iwlwifi-8265-21.ucode
Version: 21.302800.0

File: iwlwifi-8265-22.ucode
Version: 22.391740.0

File: iwlwifi-8265-27.ucode
Version: 27.541033.0

File: iwlwifi-8265-31.ucode
Version: 31.560484.0

File: iwlwifi-8265-34.ucode
Version: 34.610288.0

File: iwlwifi-8265-36.ucode
Version: 36.8fd77bb3.0

File: iwlwifi-9000-pu-b0-jf-b0-33.ucode
Version: 33.610294.0

File: iwlwifi-9000-pu-b0-jf-b0-34.ucode
Version: 34.ba501b11.0

File: iwlwifi-9000-pu-b0-jf-b0-38.ucode
Version: 38.755cfdd8.0

File: iwlwifi-9000-pu-b0-jf-b0-41.ucode
Version: 41.fc1a7aea.0

File: iwlwifi-9000-pu-b0-jf-b0-43.ucode
Version: 43.95eb4e97.0

File: iwlwifi-9000-pu-b0-jf-b0-46.ucode
Version: 46.a41adfe7.0

File: iwlwifi-9260-th-b0-jf-b0-33.ucode
Version: 33.610294.0

File: iwlwifi-9260-th-b0-jf-b0-34.ucode
Version: 34.ba501b11.0

File: iwlwifi-9260-th-b0-jf-b0-38.ucode
Version: 38.755cfdd8.0

File: iwlwifi-9260-th-b0-jf-b0-41.ucode
Version: 41.fc1a7aea.0

File: iwlwifi-9260-th-b0-jf-b0-43.ucode
Version: 43.95eb4e97.0

File: iwlwifi-9260-th-b0-jf-b0-46.ucode

Version: 46.a41adfe7.0

File: iwlwifi-cc-a0-46.ucode
Version: 46.3cfab8da.0

File: iwlwifi-cc-a0-48.ucode
Version: 48.13675109.0

File: iwlwifi-Qu-b0-hr-b0-48.ucode
Version: 48.13675109.0

File: iwlwifi-Qu-b0-jf-b0-48.ucode
Version: 48.13675109.0

File: iwlwifi-Qu-c0-hr-b0-48.ucode
Version: 48.13675109.0

File: iwlwifi-Qu-c0-jf-b0-48.ucode
Version: 48.13675109.0

File: iwlwifi-QuZ-a0-hr-b0-48.ucode
Version: 48.13675109.0

File: iwlwifi-QuZ-a0-jf-b0-48.ucode
Version: 48.13675109.0

Licence: Redistributable. See LICENCE.iwlwifi_firmware for details

Also available from <http://wireless.kernel.org/en/users/Drivers/iwlwifi#Firmware>

Driver: ipu3-imgu - Intel IPU3 (3rd Gen Image Processing Unit) driver

File: intel/irci_irci_ecr-master_20161208_0213_20170112_1500.bin
Version: irci_irci_ecr-master_20161208_0213_20170112_1500
md5sum: 59abc311fce49c5a180b5a8a3917912d
Link: intel/ipu3-fw.bin -> irci_irci_ecr-master_20161208_0213_20170112_1500.bin

Licence: Redistributable. See LICENSE.ipu3_firmware for details

Driver: cx231xx - Conexant Cx23100/101/102 USB broadcast A/V decoder

File: v4l-cx231xx-avcore-01.fw

Licence: Redistributable.

Conexant grants permission to use and redistribute these firmware files for use with Conexant devices, but not as a part of the Linux kernel or in any other form which would require these files themselves to be covered by the terms of the GNU General Public License. These firmware files are distributed in the hope that they will be useful, but WITHOUT ANY WARRANTY; without even the implied warranty of MERCHANTABILITY or FITNESS FOR A PARTICULAR PURPOSE.

LICENCE TERMS (cont.)

Driver: tehuti - Tehuti Networks 10G Ethernet

File: tehuti/bdx.bin

Licence:

Copyright (C) 2007 Tehuti Networks Ltd.

Permission is hereby granted for the distribution of this firmware data in hexadecimal or equivalent format, provided this copyright notice is accompanying it.

Found in hex form in kernel source.

Driver: typhoon - 3cr990 series Typhoon

File: 3com/typhoon.bin

Licence:

```
/*
 * Copyright 1999-2004 3Com Corporation. All Rights Reserved.
 *
 * Redistribution and use in source and binary forms of the 3c990img.h
 * microcode software are permitted provided that the following conditions
 * are met:
 * 1. Redistribution of source code must retain the above copyright
 * notice, this list of conditions and the following disclaimer.
 * 2. Redistribution in binary form must reproduce the above copyright
 * notice, this list of conditions and the following disclaimer in the
 * documentation and/or other materials provided with the distribution.
 * 3. The name of 3Com may not be used to endorse or promote products
 * derived from this software without specific prior written permission
 *
 * THIS SOFTWARE IS PROVIDED BY 3COM ``AS IS" AND ANY EXPRESS OR
 * IMPLIED WARRANTIES, INCLUDING, BUT NOT LIMITED TO, THE IMPLIED WARRANTIES
 * OF MERCHANTABILITY AND FITNESS FOR A PARTICULAR PURPOSE ARE DISCLAIMED.
 * IN NO EVENT SHALL THE AUTHOR BE LIABLE FOR ANY DIRECT, INDIRECT,
 * INCIDENTAL, SPECIAL, EXEMPLARY, OR CONSEQUENTIAL DAMAGES (INCLUDING, BUT
 * NOT LIMITED TO, PROCUREMENT OF SUBSTITUTE GOODS OR SERVICES; LOSS OF USE,
 * DATA, OR PROFITS; OR BUSINESS INTERRUPTION) HOWEVER CAUSED AND ON ANY
 * THEORY OF LIABILITY, WHETHER IN CONTRACT, STRICT LIABILITY, OR TORT
 * (INCLUDING NEGLIGENCE OR OTHERWISE) ARISING IN ANY WAY OUT OF THE USE OF
 * THIS SOFTWARE, EVEN IF ADVISED OF THE POSSIBILITY OF SUCH DAMAGE.
 *
 * USER ACKNOWLEDGES AND AGREES THAT PURCHASE OR USE OF THE 3c990img.h
 * MICROCODE SOFTWARE WILL NOT CREATE OR GIVE GROUNDS FOR A LICENSE BY
 * IMPLICATION, ESTOPPEL, OR OTHERWISE IN ANY INTELLECTUAL PROPERTY RIGHTS
 * (PATENT, COPYRIGHT, TRADE SECRET, MASK WORK, OR OTHER PROPRIETARY RIGHT)
 * EMBODIED IN ANY OTHER 3COM HARDWARE OR SOFTWARE EITHER SOLELY OR IN
 * COMBINATION WITH THE 3c990img.h MICROCODE SOFTWARE
 */
```

Found in hex form in kernel source.

Driver: yam - YAM driver for AX.25

File: yam/1200.bin

File: yam/9600.bin

Licence:

* (C) F6FBB 1998

Found in hex form in kernel source.

Driver: 3c359 - 3Com 3C359 Token Link Velocity XL adapter

File: 3com/3C359.bin

Licence:

```
/*
 * The firmware this driver downloads into the tokenring card is a
 * separate program and is not GPL'd source code, even though the Linux
 * side driver and the routine that loads this data into the card are.
 *
 * This firmware is licensed to you strictly for use in conjunction
 * with the use of 3Com 3C359 TokenRing adapters. There is no
 * warranty expressed or implied about its fitness for any purpose.
 */
/* 3c359_microcode.mac: 3Com 3C359 Tokenring microcode.
 *
 * Notes:
 * - Loaded from xl_init upon adapter initialization.
 *
 * Available from 3Com as part of their standard 3C359 driver.
 */
```

Found in hex form in kernel source.

Driver: pcnet_cs - NE2000 compatible PCMCIA adapter

File: cis/LA-PCM.cis

File: cis/PCMLM28.cis

File: cis/DP83903.cis

File: cis/NE2K.cis

File: cis/tamarack.cis

File: cis/PE-200.cis

File: cis/PE520.cis

Source: cis/

Licence: Dual GPLv2/MPL

LICENCE TERMS (cont.)

Originally developed by the pcmcia-cs project
Copyright (C) 1998, 1999, 2000 David A. Hinds

Driver: 3c589_cs - 3Com PCMCIA adapter

File: cis/3CXEM556.cis
Source: cis/src/3CXEM556.cis

Licence: Dual GPLv2/MPL

Originally developed by the pcmcia-cs project
Copyright (C) 1998, 1999, 2000 David A. Hinds

Driver: 3c574_cs - 3Com PCMCIA adapter

File: cis/3CCFEM556.cis
Source: cis/src/3CCFEM556.cis

Licence: Dual GPLv2/MPL

Originally developed by the pcmcia-cs project
Copyright (C) 1998, 1999, 2000 David A. Hinds

Driver: serial_cs - Serial PCMCIA adapter

File: cis/MT5634ZLX.cis
File: cis/RS-COM-2P.cis
File: cis/COMpad2.cis
File: cis/COMpad4.cis
Source: cis/src/MT5634ZLX.cis
Source: cis/src/RS-COM-2P.cis
Source: cis/src/COMpad2.cis
Source: cis/src/COMpad4.cis

Licence: Dual GPLv2/MPL

Originally developed by the pcmcia-cs project
Copyright (C) 1998, 1999, 2000 David A. Hinds

Driver: serial_cs - Serial PCMCIA adapter

File: cis/SW_555_SER.cis
File: cis/SW_7xx_SER.cis
File: cis/SW_8xx_SER.cis

Licence: GPLv3. See GPL-3 for details.

Copyright Sierra Wireless

Driver: smc91c92_cs - SMC 91Cxx PCMCIA

File: ositech/Xilinx7OD.bin

Licence: Allegedly GPL, but no source visible. Marked:
This file contains the firmware of Seven of Diamonds from OSITECH.
(Special thanks to Kevin MacPherson of OSITECH)

Found in hex form in kernel source.

Driver: cx23418 - Conexant PCI Broadcast A/V with MPEG encoder

File: v4l-cx23418-apu.fw
File: v4l-cx23418-cpu.fw
File: v4l-cx23418-dig.fw

Licence: Redistributable.

Conexant grants permission to use and redistribute these firmware files for use with Conexant devices, but not as a part of the Linux kernel or in any other form which would require these files themselves to be covered by the terms of the GNU General Public License. These firmware files are distributed in the hope that they will be useful, but WITHOUT ANY WARRANTY; without even the implied warranty of MERCHANTABILITY or FITNESS FOR A PARTICULAR PURPOSE.

Driver: cx23885 - Conexant PCI Express Broadcast A/V decoder

File: v4l-cx23885-avcore-01.fw

Licence: Redistributable.

Conexant grants permission to use and redistribute these firmware files for use with Conexant devices, but not as a part of the Linux kernel or in any other form which would require these files themselves to be covered by the terms of the GNU General Public License. These firmware files are distributed in the hope that they will be useful, but WITHOUT ANY WARRANTY; without even the implied warranty of MERCHANTABILITY or FITNESS FOR A PARTICULAR PURPOSE.

Driver: cx23840 - Conexant sideport Broadcast A/V decoder

File: v4l-cx25840.fw

Licence: Redistributable.

Conexant grants permission to use and redistribute these firmware files for use with Conexant devices, but not as a part of the Linux kernel or in any other form which would require these files themselves

LICENCE TERMS (cont.)

to be covered by the terms of the GNU General Public License.
These firmware files are distributed in the hope that they will be
useful, but WITHOUT ANY WARRANTY; without even the implied warranty
of MERCHANTABILITY or FITNESS FOR A PARTICULAR PURPOSE.

Driver: qllogicpti - PTI Qlogic, ISP Driver

File: qllogic/isp1000.bin

Licence: Unknown

Found in hex form in kernel source.

Driver: myri_sbus - MyriCOM Gigabit Ethernet

File: myricom/lanai.bin

Licence: Unknown

Found in hex form in kernel source.

Driver: bnx2x: Broadcom Everest

File: bnx2x-e1-4.8.53.0.fw
File: bnx2x-e1h-4.8.53.0.fw
File: bnx2x-e1-5.2.7.0.fw
File: bnx2x-e1h-5.2.7.0.fw
File: bnx2x-e1-5.2.13.0.fw
File: bnx2x-e1h-5.2.13.0.fw
File: bnx2x/bnx2x-e1-6.0.34.0.fw
File: bnx2x/bnx2x-e1h-6.0.34.0.fw
File: bnx2x/bnx2x-e2-6.0.34.0.fw
File: bnx2x/bnx2x-e1-6.2.5.0.fw
File: bnx2x/bnx2x-e1h-6.2.5.0.fw
File: bnx2x/bnx2x-e2-6.2.5.0.fw
File: bnx2x/bnx2x-e1-6.2.9.0.fw
File: bnx2x/bnx2x-e1h-6.2.9.0.fw
File: bnx2x/bnx2x-e2-6.2.9.0.fw
File: bnx2x/bnx2x-e2-7.0.20.0.fw
File: bnx2x/bnx2x-e1-7.0.20.0.fw
File: bnx2x/bnx2x-e1h-7.0.20.0.fw
File: bnx2x/bnx2x-e2-7.0.23.0.fw
File: bnx2x/bnx2x-e1-7.0.23.0.fw
File: bnx2x/bnx2x-e1h-7.0.23.0.fw
File: bnx2x/bnx2x-e2-7.0.29.0.fw
File: bnx2x/bnx2x-e1-7.0.29.0.fw
File: bnx2x/bnx2x-e1h-7.0.29.0.fw
File: bnx2x/bnx2x-e2-7.2.16.0.fw
File: bnx2x/bnx2x-e1-7.2.16.0.fw
File: bnx2x/bnx2x-e1h-7.2.16.0.fw
File: bnx2x/bnx2x-e2-7.2.51.0.fw

File: bnx2x/bnx2x-e1-7.2.51.0.fw
File: bnx2x/bnx2x-e1h-7.2.51.0.fw
File: bnx2x/bnx2x-e1-7.8.2.0.fw
File: bnx2x/bnx2x-e1h-7.8.2.0.fw
File: bnx2x/bnx2x-e2-7.8.2.0.fw
File: bnx2x/bnx2x-e1-7.8.17.0.fw
File: bnx2x/bnx2x-e1h-7.8.17.0.fw
File: bnx2x/bnx2x-e2-7.8.17.0.fw
File: bnx2x/bnx2x-e1-7.8.19.0.fw
File: bnx2x/bnx2x-e1h-7.8.19.0.fw
File: bnx2x/bnx2x-e2-7.8.19.0.fw
File: bnx2x/bnx2x-e1-7.10.51.0.fw
File: bnx2x/bnx2x-e1h-7.10.51.0.fw
File: bnx2x/bnx2x-e2-7.10.51.0.fw
File: bnx2x/bnx2x-e1-7.12.30.0.fw
File: bnx2x/bnx2x-e1h-7.12.30.0.fw
File: bnx2x/bnx2x-e2-7.12.30.0.fw
File: bnx2x/bnx2x-e1-7.13.1.0.fw
File: bnx2x/bnx2x-e1h-7.13.1.0.fw
File: bnx2x/bnx2x-e2-7.13.1.0.fw
File: bnx2x/bnx2x-e1-7.13.11.0.fw
File: bnx2x/bnx2x-e1h-7.13.11.0.fw
File: bnx2x/bnx2x-e2-7.13.11.0.fw

License:

Copyright (c) 2007-2011 Broadcom Corporation

This file contains firmware data derived from proprietary unpublished
source code, Copyright (c) 2007-2011 Broadcom Corporation.

Permission is hereby granted for the distribution of this firmware data
in hexadecimal or equivalent format, provided this copyright notice is
accompanying it.

Found in hex form in kernel source.

Driver: bnx2 - Broadcom NetXtremell

File: bnx2/bnx2-mips-06-4.6.16.fw
File: bnx2/bnx2-mips-06-5.0.0.j3.fw
File: bnx2/bnx2-mips-06-5.0.0.j6.fw
File: bnx2/bnx2-mips-06-6.0.15.fw
File: bnx2/bnx2-mips-06-6.2.1.fw
File: bnx2/bnx2-mips-06-6.2.3.fw
File: bnx2/bnx2-mips-09-4.6.17.fw
File: bnx2/bnx2-mips-09-5.0.0.j3.fw
File: bnx2/bnx2-mips-09-5.0.0.j9.fw
File: bnx2/bnx2-mips-09-5.0.0.j15.fw
File: bnx2/bnx2-mips-09-6.0.17.fw
File: bnx2/bnx2-mips-09-6.2.1.fw
File: bnx2/bnx2-mips-09-6.2.1a.fw
File: bnx2/bnx2-mips-09-6.2.1b.fw
File: bnx2/bnx2-rv2p-06-4.6.16.fw

LICENCE TERMS (cont.)

File: bnx2/bnx2-rv2p-06-5.0.0.j3.fw
File: bnx2/bnx2-rv2p-06-6.0.15.fw
File: bnx2/bnx2-rv2p-09-4.6.15.fw
File: bnx2/bnx2-rv2p-09-5.0.0.j3.fw
File: bnx2/bnx2-rv2p-09-5.0.0.j10.fw
File: bnx2/bnx2-rv2p-09-6.0.17.fw
File: bnx2/bnx2-rv2p-09ax-5.0.0.j3.fw
File: bnx2/bnx2-rv2p-09ax-5.0.0.j10.fw
File: bnx2/bnx2-rv2p-09ax-6.0.17.fw

Licence:

This file contains firmware data derived from proprietary unpublished source code, Copyright (c) 2004 - 2010 Broadcom Corporation.

Permission is hereby granted for the distribution of this firmware data in hexadecimal or equivalent format, provided this copyright notice is accompanying it.

Found in hex form in kernel source.

Driver: netxen_nic - NetXen Multi port (1/10) Gigabit Ethernet NIC

File: phanfw.bin
Version: 4.0.590

Licence: Redistributable. See LICENCE.phanfw for details.

Available from http://driver.qlogic.com/firmware/netxen_nic/new/

Driver: dvb-ttpci -- AV7110 cards

File: av7110/bootcode.bin
Source: av7110/Boot.S
Source: av7110/Makefile

Licence: GPLv2 or later. See GPL-2 and GPL-3 for details.

ARM assembly source code from <https://linuxtv.org/downloads/firmware/Boot.S>

Driver: snd-wavefront - ISA WaveFront sound card

File: yamaha/yss225_registers.bin

Licence: Allegedly GPLv2+, but no source visible.

Found in hex form in kernel source, with the following comment:
Copyright (c) 1998-2002 by Paul Davis <pbdb@op.net>

Driver: rt61pci - Ralink RT2561, RT2561S, RT2661 wireless MACs

File: rt2561.bin
File: rt2561s.bin
File: rt2661.bin

Licence: Redistributable. See LICENCE.ralink-firmware.txt for details

Downloaded from <http://www.ralinktech.com/ralink/Home/Support/Linux.html>

Driver: rt73usb - Ralink RT2571W, RT2671 wireless MACs

File: rt73.bin

Licence: Redistributable. See LICENCE.ralink-firmware.txt for details

Downloaded from <http://www.ralinktech.com/ralink/Home/Support/Linux.html>

Driver: mt7601u - MediaTek MT7601U Wireless MACs

File: mt7601u.bin
Version: 34

Licence: Redistributable. See LICENCE.ralink_a_mediatek_company_firmware for details

Downloaded from <http://www.mediatek.com/en/downloads/>

Driver: rt2800pci - Ralink RT2860, RT2890, RT3090, RT3290, RT5390 wireless MACs

File: rt2860.bin
Version: 40

File: rt3290.bin
Version: 37

Licence: Redistributable. See LICENCE.ralink-firmware.txt for details

Binary file supplied originally by Shiang Tu <shiang_tu@ralinktech.com>, latest from <http://www.mediatek.com/en/downloads1/downloads/>

Driver: rt2860sta - Ralink RT3090 wireless MACs

Link: rt3090.bin -> rt2860.bin

Licence: Redistributable. See LICENCE.ralink-firmware.txt for details

LICENCE TERMS (cont.)

Driver: rt2800usb - Ralink RT2870, RT3070, RT3071, RT3072, RT5370 wireless MACs

File: rt2870.bin
Version: 36

Licence: Redistributable. See LICENCE.ralink-firmware.txt for details

Binary file supplied originally by Shiang Tu <shiang_tu@ralinktech.com>, latest from <http://www.mediatek.com/en/downloads1/downloads/>

Driver: rt2870sta - Ralink RT2870, RT3070, RT3071 wireless MACs

Link: rt3070.bin -> rt2870.bin
File: rt3071.bin

Licence: Redistributable. See LICENCE.ralink-firmware.txt for details

rt3071.bin is a copy of bytes 4096-8191 of rt2870.bin for compatibility.

Driver: usbdx/usbdxfast/usbdxsigma - usbdx data acquisition cards

File: usbdx_firmware.bin
File: usbdxfast_firmware.bin
File: usbdxsigma_firmware.bin
Source: usbdx/

Licence: GPLv2. See GPLv2 for details.

Provided from the author, Bernd Porr <BerndPorr@f2s.com>

Driver: xc4000 - Xceive 4000 Tuner driver

File: dvb-fe-xc4000-1.4.1.fw
Version: 1.4.1

Licence: Redistributable. See LICENCE.xc4000 for details

Driver: xc5000 - Xceive 5000 Tuner driver

File: dvb-fe-xc5000-1.6.114.fw
Version: 1.6.114

File: dvb-fe-xc5000c-4.1.30.7.fw
Version: 4.1.30.7

Licence: Redistributable. See LICENCE.xc5000 and LICENCE.xc5000c for details

Driver: dib0700 - DiBcom dib0700 USB DVB bridge driver

File: dvb-usb-dib0700-1.20.fw
Version: 1.20

Licence: Redistributable. See LICENSE.dib0700 for details

Driver: ath3k - DFU Driver for Atheros bluetooth chipset AR3011

File: ath3k-1.fw
Version: 1.0

Fix EEPROM radio table issue and change PID to 3005

Licence: Redistributable. See LICENCE.atheros_firmware for details

Driver: mga - Matrox G200/G400/G550

File: matrox/g200_warp.fw
File: matrox/g400_warp.fw

Licence:

Copyright 1999 Matrox Graphics Inc.
All Rights Reserved.

Permission is hereby granted, free of charge, to any person obtaining a copy of this software and associated documentation files (the "Software"), to deal in the Software without restriction, including without limitation the rights to use, copy, modify, merge, publish, distribute, sublicense, and/or sell copies of the Software, and to permit persons to whom the Software is furnished to do so, subject to the following conditions:

The above copyright notice and this permission notice shall be included in all copies or substantial portions of the Software.

THE SOFTWARE IS PROVIDED "AS IS", WITHOUT WARRANTY OF ANY KIND, EXPRESS OR IMPLIED, INCLUDING BUT NOT LIMITED TO THE WARRANTIES OF MERCHANTABILITY, FITNESS FOR A PARTICULAR PURPOSE AND NONINFRINGEMENT. IN NO EVENT SHALL MATROX GRAPHICS INC., OR ANY OTHER CONTRIBUTORS BE LIABLE FOR ANY CLAIM, DAMAGES OR OTHER LIABILITY, WHETHER IN AN ACTION OF CONTRACT, TORT OR OTHERWISE, ARISING FROM, OUT OF OR IN CONNECTION WITH THE SOFTWARE OR THE USE OR OTHER DEALINGS IN THE SOFTWARE.

Found in hex form in kernel source.

Driver: r128 - ATI Rage 128

File: r128/r128_cce.bin

LICENCE TERMS (cont.)

Licence:

Copyright 2000 Advanced Micro Devices, Inc.

- * Permission is hereby granted, free of charge, to any person obtaining a
- * copy of this software and associated documentation files (the "Software"),
- * to deal in the Software without restriction, including without limitation
- * the rights to use, copy, modify, merge, publish, distribute, sublicense,
- * and/or sell copies of the Software, and to permit persons to whom the
- * Software is furnished to do so, subject to the following conditions:
- *
- * The above copyright notice and this permission notice (including the next
- * paragraph) shall be included in all copies or substantial portions of the
- * Software.
- *
- * THE SOFTWARE IS PROVIDED "AS IS", WITHOUT WARRANTY OF ANY KIND, EXPRESS OR
- * IMPLIED, INCLUDING BUT NOT LIMITED TO THE WARRANTIES OF MERCHANTABILITY,
- * FITNESS FOR A PARTICULAR PURPOSE AND NONINFRINGEMENT. IN NO EVENT SHALL
- * PRECISION INSIGHT AND/OR ITS SUPPLIERS BE LIABLE FOR ANY CLAIM, DAMAGES OR
- * OTHER LIABILITY, WHETHER IN AN ACTION OF CONTRACT, TORT OR OTHERWISE,
- * ARISING FROM, OUT OF OR IN CONNECTION WITH THE SOFTWARE OR THE USE OR OTHER
- * DEALINGS IN THE SOFTWARE.

Found in decimal form in kernel source.

Driver: radeon - ATI Radeon

File: radeon/R100_cp.bin
File: radeon/R200_cp.bin
File: radeon/R300_cp.bin
File: radeon/R420_cp.bin
File: radeon/RS600_cp.bin
File: radeon/RS690_cp.bin
File: radeon/R520_cp.bin
File: radeon/R600_pfp.bin
File: radeon/R600_me.bin
File: radeon/RV610_pfp.bin
File: radeon/RV610_me.bin
File: radeon/RV630_pfp.bin
File: radeon/RV630_me.bin
File: radeon/RV620_pfp.bin
File: radeon/RV620_me.bin
File: radeon/RV635_pfp.bin
File: radeon/RV635_me.bin
File: radeon/RV670_pfp.bin
File: radeon/RV670_me.bin
File: radeon/RS780_pfp.bin
File: radeon/RS780_me.bin
File: radeon/RV770_pfp.bin
File: radeon/RV770_me.bin
File: radeon/RV730_pfp.bin
File: radeon/RV730_me.bin
File: radeon/RV710_pfp.bin
File: radeon/RV710_me.bin

Licence:

* Copyright 2007-2009 Advanced Micro Devices, Inc.

* All Rights Reserved.

*

- * Permission is hereby granted, free of charge, to any person obtaining a
- * copy of this software and associated documentation files (the "Software"),
- * to deal in the Software without restriction, including without limitation
- * the rights to use, copy, modify, merge, publish, distribute, sublicense,
- * and/or sell copies of the Software, and to permit persons to whom the
- * Software is furnished to do so, subject to the following conditions:
- *

- * The above copyright notice and this permission notice (including the next
- * paragraph) shall be included in all copies or substantial portions of the
- * Software.

*

- * THE SOFTWARE IS PROVIDED "AS IS", WITHOUT WARRANTY OF ANY KIND, EXPRESS OR
- * IMPLIED, INCLUDING BUT NOT LIMITED TO THE WARRANTIES OF MERCHANTABILITY,
- * FITNESS FOR A PARTICULAR PURPOSE AND NONINFRINGEMENT. IN NO EVENT SHALL
- * IN NO EVENT SHALL THE COPYRIGHT OWNER(S) AND/OR ITS SUPPLIERS BE
- * LIABLE FOR ANY CLAIM, DAMAGES OR OTHER LIABILITY, WHETHER IN AN ACTION
- * OF CONTRACT, TORT OR OTHERWISE, ARISING FROM, OUT OF OR IN CONNECTION
- * WITH THE SOFTWARE OR THE USE OR OTHER DEALINGS IN THE SOFTWARE.

Found in hex form in kernel source.

Driver: radeon - ATI Radeon

File: radeon/R600_rlc.bin
File: radeon/R600_uvd.bin
File: radeon/RS780_uvd.bin
File: radeon/R700_rlc.bin
File: radeon/RV710_uvd.bin
File: radeon/RV710_smc.bin
File: radeon/RV730_smc.bin
File: radeon/RV740_smc.bin
File: radeon/RV770_smc.bin
File: radeon/RV770_uvd.bin
File: radeon/CEDAR_me.bin
File: radeon/CEDAR_pfp.bin
File: radeon/CEDAR_rlc.bin
File: radeon/CEDAR_smc.bin
File: radeon/CYPRESS_me.bin
File: radeon/CYPRESS_pfp.bin
File: radeon/CYPRESS_rlc.bin
File: radeon/CYPRESS_uvd.bin
File: radeon/CYPRESS_smc.bin
File: radeon/JUNIPER_me.bin
File: radeon/JUNIPER_pfp.bin
File: radeon/JUNIPER_rlc.bin
File: radeon/JUNIPER_smc.bin
File: radeon/REDWOOD_me.bin
File: radeon/REDWOOD_pfp.bin
File: radeon/REDWOOD_rlc.bin
File: radeon/REDWOOD_smc.bin

File: radeon/PALM_me.bin
File: radeon/PALM_pfp.bin
File: radeon/SUMO_rlc.bin
File: radeon/SUMO_uvd.bin
File: radeon/BARTS_mc.bin
File: radeon/BARTS_me.bin
File: radeon/BARTS_pfp.bin
File: radeon/BARTS_smc.bin
File: radeon/BTC_rlc.bin
File: radeon/CAICOS_mc.bin
File: radeon/CAICOS_me.bin
File: radeon/CAICOS_pfp.bin
File: radeon/CAICOS_smc.bin
File: radeon/TURKS_mc.bin
File: radeon/TURKS_me.bin
File: radeon/TURKS_pfp.bin
File: radeon/TURKS_smc.bin
File: radeon/CAYMAN_mc.bin
File: radeon/CAYMAN_me.bin
File: radeon/CAYMAN_pfp.bin
File: radeon/CAYMAN_rlc.bin
File: radeon/CAYMAN_smc.bin
File: radeon/SUMO_pfp.bin
File: radeon/SUMO_me.bin
File: radeon/SUMO2_pfp.bin
File: radeon/SUMO2_me.bin
File: radeon/ARUBA_me.bin
File: radeon/ARUBA_pfp.bin
File: radeon/ARUBA_rlc.bin
File: radeon/PITCAIRN_ce.bin
File: radeon/PITCAIRN_mc.bin
File: radeon/PITCAIRN_mc2.bin
File: radeon/PITCAIRN_me.bin
File: radeon/PITCAIRN_pfp.bin
File: radeon/PITCAIRN_rlc.bin
File: radeon/PITCAIRN_smc.bin
File: radeon/TAHITI_ce.bin
File: radeon/TAHITI_mc.bin
File: radeon/TAHITI_mc2.bin
File: radeon/TAHITI_me.bin
File: radeon/TAHITI_pfp.bin
File: radeon/TAHITI_rlc.bin
File: radeon/TAHITI_uvd.bin
File: radeon/TAHITI_smc.bin
File: radeon/TAHITI_vce.bin
File: radeon/VERDE_ce.bin
File: radeon/VERDE_mc.bin
File: radeon/VERDE_mc2.bin
File: radeon/VERDE_me.bin
File: radeon/VERDE_pfp.bin
File: radeon/VERDE_rlc.bin
File: radeon/VERDE_smc.bin
File: radeon/OLAND_ce.bin
File: radeon/OLAND_mc.bin
File: radeon/OLAND_mc2.bin
File: radeon/OLAND_me.bin
File: radeon/OLAND_pfp.bin

File: radeon/OLAND_rlc.bin
File: radeon/OLAND_smc.bin
File: radeon/HAINAN_ce.bin
File: radeon/HAINAN_mc.bin
File: radeon/HAINAN_mc2.bin
File: radeon/HAINAN_me.bin
File: radeon/HAINAN_pfp.bin
File: radeon/HAINAN_rlc.bin
File: radeon/HAINAN_smc.bin
File: radeon/BONAIRE_ce.bin
File: radeon/BONAIRE_mc.bin
File: radeon/BONAIRE_mc2.bin
File: radeon/BONAIRE_me.bin
File: radeon/BONAIRE_mec.bin
File: radeon/BONAIRE_pfp.bin
File: radeon/BONAIRE_rlc.bin
File: radeon/BONAIRE_sdma.bin
File: radeon/BONAIRE_uvd.bin
File: radeon/BONAIRE_smc.bin
File: radeon/BONAIRE_vce.bin
File: radeon/KABINI_ce.bin
File: radeon/KABINI_me.bin
File: radeon/KABINI_mec.bin
File: radeon/KABINI_pfp.bin
File: radeon/KABINI_rlc.bin
File: radeon/KABINI_sdma.bin
File: radeon/KAVERI_ce.bin
File: radeon/KAVERI_me.bin
File: radeon/KAVERI_mec.bin
File: radeon/KAVERI_pfp.bin
File: radeon/KAVERI_rlc.bin
File: radeon/KAVERI_sdma.bin
File: radeon/HAWAII_ce.bin
File: radeon/HAWAII_mc.bin
File: radeon/HAWAII_mc2.bin
File: radeon/HAWAII_me.bin
File: radeon/HAWAII_mec.bin
File: radeon/HAWAII_pfp.bin
File: radeon/HAWAII_rlc.bin
File: radeon/HAWAII_sdma.bin
File: radeon/HAWAII_smc.bin
File: radeon/MULLINS_ce.bin
File: radeon/MULLINS_me.bin
File: radeon/MULLINS_mec.bin
File: radeon/MULLINS_pfp.bin
File: radeon/MULLINS_rlc.bin
File: radeon/MULLINS_sdma.bin
File: radeon/pitcairn_ce.bin
File: radeon/pitcairn_k_smc.bin
File: radeon/pitcairn_mc.bin
File: radeon/pitcairn_me.bin
File: radeon/pitcairn_pfp.bin
File: radeon/pitcairn_rlc.bin
File: radeon/pitcairn_smc.bin
File: radeon/tahiti_ce.bin
File: radeon/tahiti_k_smc.bin
File: radeon/tahiti_mc.bin

File: radeon/tahiti_me.bin
File: radeon/tahiti_pfp.bin
File: radeon/tahiti_rlc.bin
File: radeon/tahiti_smc.bin
File: radeon/verde_ce.bin
File: radeon/verde_k_smc.bin
File: radeon/verde_mc.bin
File: radeon/verde_me.bin
File: radeon/verde_pfp.bin
File: radeon/verde_rlc.bin
File: radeon/verde_smc.bin
File: radeon/oland_ce.bin
File: radeon/oland_k_smc.bin
File: radeon/oland_mc.bin
File: radeon/oland_me.bin
File: radeon/oland_pfp.bin
File: radeon/oland_rlc.bin
File: radeon/oland_smc.bin
File: radeon/hainan_ce.bin
File: radeon/hainan_k_smc.bin
File: radeon/hainan_mc.bin
File: radeon/hainan_me.bin
File: radeon/hainan_pfp.bin
File: radeon/hainan_rlc.bin
File: radeon/hainan_smc.bin
File: radeon/bonaire_ce.bin
File: radeon/bonaire_k_smc.bin
File: radeon/bonaire_mc.bin
File: radeon/bonaire_me.bin
File: radeon/bonaire_mec.bin
File: radeon/bonaire_pfp.bin
File: radeon/bonaire_rlc.bin
File: radeon/bonaire_sdma.bin
File: radeon/bonaire_sdma1.bin
File: radeon/bonaire_smc.bin
File: radeon/bonaire_uvd.bin
File: radeon/bonaire_vce.bin
File: radeon/kabini_ce.bin
File: radeon/kabini_me.bin
File: radeon/kabini_mec.bin
File: radeon/kabini_pfp.bin
File: radeon/kabini_rlc.bin
File: radeon/kabini_sdma.bin
File: radeon/kabini_sdma1.bin
File: radeon/kabini_uvd.bin
File: radeon/kabini_vce.bin
File: radeon/kaveri_ce.bin
File: radeon/kaveri_me.bin
File: radeon/kaveri_mec.bin
File: radeon/kaveri_mec2.bin
File: radeon/kaveri_pfp.bin
File: radeon/kaveri_rlc.bin
File: radeon/kaveri_sdma.bin
File: radeon/kaveri_sdma1.bin
File: radeon/kaveri_uvd.bin
File: radeon/kaveri_vce.bin
File: radeon/hawaii_ce.bin

File: radeon/hawaii_k_smc.bin
File: radeon/hawaii_mc.bin
File: radeon/hawaii_me.bin
File: radeon/hawaii_mec.bin
File: radeon/hawaii_pfp.bin
File: radeon/hawaii_rlc.bin
File: radeon/hawaii_sdma.bin
File: radeon/hawaii_sdma1.bin
File: radeon/hawaii_smc.bin
File: radeon/hawaii_uvd.bin
File: radeon/hawaii_vce.bin
File: radeon/mullins_ce.bin
File: radeon/mullins_me.bin
File: radeon/mullins_mec.bin
File: radeon/mullins_pfp.bin
File: radeon/mullins_rlc.bin
File: radeon/mullins_sdma.bin
File: radeon/mullins_sdma1.bin
File: radeon/mullins_uvd.bin
File: radeon/mullins_vce.bin
File: radeon/banks_k_2_smc.bin
File: radeon/si58_mc.bin

Licence: Redistributable. See LICENSE.radeon for details.

Driver: amdgpu - AMD Radeon

File: amdgpu/tahiti_ce.bin
File: amdgpu/tahiti_k_smc.bin
File: amdgpu/tahiti_mc.bin
File: amdgpu/tahiti_me.bin
File: amdgpu/tahiti_pfp.bin
File: amdgpu/tahiti_rlc.bin
File: amdgpu/tahiti_smc.bin
File: amdgpu/pitcairn_ce.bin
File: amdgpu/pitcairn_k_smc.bin
File: amdgpu/pitcairn_mc.bin
File: amdgpu/pitcairn_me.bin
File: amdgpu/pitcairn_pfp.bin
File: amdgpu/pitcairn_rlc.bin
File: amdgpu/pitcairn_smc.bin
File: amdgpu/verde_ce.bin
File: amdgpu/verde_k_smc.bin
File: amdgpu/verde_mc.bin
File: amdgpu/verde_me.bin
File: amdgpu/verde_pfp.bin
File: amdgpu/verde_rlc.bin
File: amdgpu/verde_smc.bin
File: amdgpu/hainan_ce.bin
File: amdgpu/hainan_k_smc.bin
File: amdgpu/hainan_mc.bin
File: amdgpu/hainan_me.bin
File: amdgpu/hainan_pfp.bin
File: amdgpu/hainan_rlc.bin
File: amdgpu/hainan_smc.bin

File: amdgpu/oland_ce.bin
 File: amdgpu/oland_k_smc.bin
 File: amdgpu/oland_mc.bin
 File: amdgpu/oland_me.bin
 File: amdgpu/oland_pfp.bin
 File: amdgpu/oland_rlc.bin
 File: amdgpu/oland_smc.bin
 File: amdgpu/si58_mc.bin
 File: amdgpu/banks_k_2_smc.bin
 File: amdgpu/bonaire_ce.bin
 File: amdgpu/bonaire_k_smc.bin
 File: amdgpu/bonaire_mc.bin
 File: amdgpu/bonaire_me.bin
 File: amdgpu/bonaire_mec.bin
 File: amdgpu/bonaire_pfp.bin
 File: amdgpu/bonaire_rlc.bin
 File: amdgpu/bonaire_sdma.bin
 File: amdgpu/bonaire_sdma1.bin
 File: amdgpu/bonaire_smc.bin
 File: amdgpu/bonaire_uvd.bin
 File: amdgpu/bonaire_vce.bin
 File: amdgpu/hawaii_ce.bin
 File: amdgpu/hawaii_k_smc.bin
 File: amdgpu/hawaii_mc.bin
 File: amdgpu/hawaii_me.bin
 File: amdgpu/hawaii_mec.bin
 File: amdgpu/hawaii_pfp.bin
 File: amdgpu/hawaii_rlc.bin
 File: amdgpu/hawaii_sdma.bin
 File: amdgpu/hawaii_sdma1.bin
 File: amdgpu/hawaii_smc.bin
 File: amdgpu/hawaii_uvd.bin
 File: amdgpu/hawaii_vce.bin
 File: amdgpu/kabini_ce.bin
 File: amdgpu/kabini_me.bin
 File: amdgpu/kabini_mec.bin
 File: amdgpu/kabini_pfp.bin
 File: amdgpu/kabini_rlc.bin
 File: amdgpu/kabini_sdma.bin
 File: amdgpu/kabini_sdma1.bin
 File: amdgpu/kabini_uvd.bin
 File: amdgpu/kabini_vce.bin
 File: amdgpu/mullins_ce.bin
 File: amdgpu/mullins_me.bin
 File: amdgpu/mullins_mec.bin
 File: amdgpu/mullins_pfp.bin
 File: amdgpu/mullins_rlc.bin
 File: amdgpu/mullins_sdma.bin
 File: amdgpu/mullins_sdma1.bin
 File: amdgpu/mullins_uvd.bin
 File: amdgpu/mullins_vce.bin
 File: amdgpu/kaveri_ce.bin
 File: amdgpu/kaveri_me.bin
 File: amdgpu/kaveri_mec.bin
 File: amdgpu/kaveri_mec2.bin
 File: amdgpu/kaveri_pfp.bin
 File: amdgpu/kaveri_rlc.bin

File: amdgpu/kaveri_sdma.bin
 File: amdgpu/kaveri_sdma1.bin
 File: amdgpu/kaveri_uvd.bin
 File: amdgpu/kaveri_vce.bin
 File: amdgpu/topaz_ce.bin
 File: amdgpu/topaz_k_smc.bin
 File: amdgpu/topaz_mc.bin
 File: amdgpu/topaz_me.bin
 File: amdgpu/topaz_mec2.bin
 File: amdgpu/topaz_mec.bin
 File: amdgpu/topaz_pfp.bin
 File: amdgpu/topaz_rlc.bin
 File: amdgpu/topaz_sdma1.bin
 File: amdgpu/topaz_sdma.bin
 File: amdgpu/topaz_smc.bin
 File: amdgpu/tonga_ce.bin
 File: amdgpu/tonga_k_smc.bin
 File: amdgpu/tonga_mc.bin
 File: amdgpu/tonga_me.bin
 File: amdgpu/tonga_mec2.bin
 File: amdgpu/tonga_mec.bin
 File: amdgpu/tonga_pfp.bin
 File: amdgpu/tonga_rlc.bin
 File: amdgpu/tonga_sdma1.bin
 File: amdgpu/tonga_sdma.bin
 File: amdgpu/tonga_smc.bin
 File: amdgpu/tonga_uvd.bin
 File: amdgpu/tonga_vce.bin
 File: amdgpu/carrizo_ce.bin
 File: amdgpu/carrizo_me.bin
 File: amdgpu/carrizo_mec2.bin
 File: amdgpu/carrizo_mec.bin
 File: amdgpu/carrizo_pfp.bin
 File: amdgpu/carrizo_rlc.bin
 File: amdgpu/carrizo_sdma1.bin
 File: amdgpu/carrizo_sdma.bin
 File: amdgpu/carrizo_uvd.bin
 File: amdgpu/carrizo_vce.bin
 File: amdgpu/fiji_ce.bin
 File: amdgpu/fiji_mc.bin
 File: amdgpu/fiji_me.bin
 File: amdgpu/fiji_mec2.bin
 File: amdgpu/fiji_mec.bin
 File: amdgpu/fiji_pfp.bin
 File: amdgpu/fiji_rlc.bin
 File: amdgpu/fiji_sdma1.bin
 File: amdgpu/fiji_sdma.bin
 File: amdgpu/fiji_smc.bin
 File: amdgpu/fiji_uvd.bin
 File: amdgpu/fiji_vce.bin
 File: amdgpu/stoney_ce.bin
 File: amdgpu/stoney_me.bin
 File: amdgpu/stoney_mec.bin
 File: amdgpu/stoney_pfp.bin
 File: amdgpu/stoney_rlc.bin
 File: amdgpu/stoney_sdma.bin
 File: amdgpu/stoney_uvd.bin

LICENCE TERMS (cont.)

File: amdgpu/stoney_vce.bin
File: amdgpu/polaris10_ce.bin
File: amdgpu/polaris10_ce_2.bin
File: amdgpu/polaris10_mc.bin
File: amdgpu/polaris10_k_mc.bin
File: amdgpu/polaris10_me.bin
File: amdgpu/polaris10_me_2.bin
File: amdgpu/polaris10_mec2.bin
File: amdgpu/polaris10_mec2_2.bin
File: amdgpu/polaris10_mec.bin
File: amdgpu/polaris10_mec_2.bin
File: amdgpu/polaris10_pfp.bin
File: amdgpu/polaris10_pfp_2.bin
File: amdgpu/polaris10_rlc.bin
File: amdgpu/polaris10_sdma1.bin
File: amdgpu/polaris10_sdma.bin
File: amdgpu/polaris10_smc.bin
File: amdgpu/polaris10_k_smc.bin
File: amdgpu/polaris10_k2_smc.bin
File: amdgpu/polaris10_smc_sk.bin
File: amdgpu/polaris10_uvd.bin
File: amdgpu/polaris10_vce.bin
File: amdgpu/polaris11_ce.bin
File: amdgpu/polaris11_ce_2.bin
File: amdgpu/polaris11_mc.bin
File: amdgpu/polaris11_k_mc.bin
File: amdgpu/polaris11_me.bin
File: amdgpu/polaris11_me_2.bin
File: amdgpu/polaris11_mec2.bin
File: amdgpu/polaris11_mec2_2.bin
File: amdgpu/polaris11_mec.bin
File: amdgpu/polaris11_mec_2.bin
File: amdgpu/polaris11_pfp.bin
File: amdgpu/polaris11_pfp_2.bin
File: amdgpu/polaris11_rlc.bin
File: amdgpu/polaris11_sdma1.bin
File: amdgpu/polaris11_sdma.bin
File: amdgpu/polaris11_smc.bin
File: amdgpu/polaris11_k_smc.bin
File: amdgpu/polaris11_k2_smc.bin
File: amdgpu/polaris11_smc_sk.bin
File: amdgpu/polaris11_uvd.bin
File: amdgpu/polaris11_vce.bin
File: amdgpu/polaris12_ce.bin
File: amdgpu/polaris12_ce_2.bin
File: amdgpu/polaris12_mc.bin
File: amdgpu/polaris12_k_mc.bin
File: amdgpu/polaris12_me.bin
File: amdgpu/polaris12_me_2.bin
File: amdgpu/polaris12_mec.bin
File: amdgpu/polaris12_mec_2.bin
File: amdgpu/polaris12_mec2.bin
File: amdgpu/polaris12_mec2_2.bin
File: amdgpu/polaris12_pfp.bin
File: amdgpu/polaris12_pfp_2.bin
File: amdgpu/polaris12_rlc.bin
File: amdgpu/polaris12_sdma.bin

File: amdgpu/polaris12_sdma1.bin
File: amdgpu/polaris12_smc.bin
File: amdgpu/polaris12_k_smc.bin
File: amdgpu/polaris12_uvd.bin
File: amdgpu/polaris12_vce.bin
File: amdgpu/vegam_ce.bin
File: amdgpu/vegam_me.bin
File: amdgpu/vegam_mec.bin
File: amdgpu/vegam_mec2.bin
File: amdgpu/vegam_pfp.bin
File: amdgpu/vegam_rlc.bin
File: amdgpu/vegam_sdma.bin
File: amdgpu/vegam_sdma1.bin
File: amdgpu/vegam_smc.bin
File: amdgpu/vegam_uvd.bin
File: amdgpu/vegam_vce.bin
File: amdgpu/vega10_acg_smc.bin
File: amdgpu/vega10_asd.bin
File: amdgpu/vega10_ce.bin
File: amdgpu/vega10_gpu_info.bin
File: amdgpu/vega10_me.bin
File: amdgpu/vega10_mec.bin
File: amdgpu/vega10_mec2.bin
File: amdgpu/vega10_pfp.bin
File: amdgpu/vega10_rlc.bin
File: amdgpu/vega10_sdma.bin
File: amdgpu/vega10_sdma1.bin
File: amdgpu/vega10_smc.bin
File: amdgpu/vega10_sos.bin
File: amdgpu/vega10_uvd.bin
File: amdgpu/vega10_vce.bin
File: amdgpu/vega12_asd.bin
File: amdgpu/vega12_ce.bin
File: amdgpu/vega12_gpu_info.bin
File: amdgpu/vega12_me.bin
File: amdgpu/vega12_mec.bin
File: amdgpu/vega12_mec2.bin
File: amdgpu/vega12_pfp.bin
File: amdgpu/vega12_rlc.bin
File: amdgpu/vega12_sdma.bin
File: amdgpu/vega12_sdma1.bin
File: amdgpu/vega12_smc.bin
File: amdgpu/vega12_sos.bin
File: amdgpu/vega12_uvd.bin
File: amdgpu/vega12_vce.bin
File: amdgpu/vega20_asd.bin
File: amdgpu/vega20_ce.bin
File: amdgpu/vega20_me.bin
File: amdgpu/vega20_mec.bin
File: amdgpu/vega20_mec2.bin
File: amdgpu/vega20_pfp.bin
File: amdgpu/vega20_rlc.bin
File: amdgpu/vega20_sdma.bin
File: amdgpu/vega20_sdma1.bin
File: amdgpu/vega20_smc.bin
File: amdgpu/vega20_sos.bin
File: amdgpu/vega20_uvd.bin

LICENCE TERMS (cont.)

File: amdgpu/vega20_vce.bin
File: amdgpu/raven_asd.bin
File: amdgpu/raven_ce.bin
File: amdgpu/raven_gpu_info.bin
File: amdgpu/raven_me.bin
File: amdgpu/raven_mec.bin
File: amdgpu/raven_mec2.bin
File: amdgpu/raven_pfp.bin
File: amdgpu/raven_rlc.bin
File: amdgpu/raven_sdma.bin
File: amdgpu/raven_vcn.bin
File: amdgpu/raven_dmcu.bin
File: amdgpu/picasso_asd.bin
File: amdgpu/picasso_ce.bin
File: amdgpu/picasso_gpu_info.bin
File: amdgpu/picasso_me.bin
File: amdgpu/picasso_mec.bin
File: amdgpu/picasso_mec2.bin
File: amdgpu/picasso_pfp.bin
File: amdgpu/picasso_rlc.bin
File: amdgpu/picasso_rlc_am4.bin
File: amdgpu/picasso_sdma.bin
File: amdgpu/picasso_vcn.bin
File: amdgpu/raven2_asd.bin
File: amdgpu/raven2_ce.bin
File: amdgpu/raven2_gpu_info.bin
File: amdgpu/raven2_me.bin
File: amdgpu/raven2_mec.bin
File: amdgpu/raven2_mec2.bin
File: amdgpu/raven2_pfp.bin
File: amdgpu/raven2_rlc.bin
File: amdgpu/raven2_sdma.bin
File: amdgpu/raven2_vcn.bin

Licence: Redistributable. See LICENSE.amdgpu for details.

Driver: s2255drv

File: f2255usb.bin
Version: 1.2.8

Licence: Redistributable.

Sensoray grants permission to use and redistribute these firmware files for use with Sensoray devices, but not as a part of the Linux kernel or in any other form which would require these files themselves to be covered by the terms of the GNU General Public License. These firmware files are distributed in the hope that they will be useful, but WITHOUT ANY WARRANTY; without even the implied warranty of MERCHANTABILITY or FITNESS FOR A PARTICULAR PURPOSE.

Driver: rtl8192e - Realtek 8192 PCI wireless driver

File: RTL8192E/boot.img
File: RTL8192E/data.img
File: RTL8192E/main.img

Licence: Redistributable, provided by Realtek in their driver source download.

Driver: lgs8gxx - Legend Silicon GB20600 demodulator driver

File: lgs8g75.fw

Licence: Unknown

Driver: ib_qib - QLogic Infiniband

File: qllogic/sd7220.fw

Licence:

* Copyright (c) 2007, 2008 QLogic Corporation. All rights reserved.

*
* This software is available to you under a choice of one of two
* licenses. You may choose to be licensed under the terms of the GNU
* General Public License (GPL) Version 2, available from the file
* COPYING in the main directory of this source tree, or the
* OpenIB.org BSD license below:

*
* Redistribution and use in source and binary forms, with or
* without modification, are permitted provided that the following
* conditions are met:

*
* - Redistributions of source code must retain the above
* copyright notice, this list of conditions and the following
* disclaimer.

*
* - Redistributions in binary form must reproduce the above
* copyright notice, this list of conditions and the following
* disclaimer in the documentation and/or other materials
* provided with the distribution.

*
* THE SOFTWARE IS PROVIDED "AS IS", WITHOUT WARRANTY OF ANY KIND,
* EXPRESS OR IMPLIED, INCLUDING BUT NOT LIMITED TO THE WARRANTIES OF
* MERCHANTABILITY, FITNESS FOR A PARTICULAR PURPOSE AND
* NONINFRINGEMENT. IN NO EVENT SHALL THE AUTHORS OR COPYRIGHT HOLDERS
* BE LIABLE FOR ANY CLAIM, DAMAGES OR OTHER LIABILITY, WHETHER IN AN
* ACTION OF CONTRACT, TORT OR OTHERWISE, ARISING FROM, OUT OF OR IN
* CONNECTION WITH THE SOFTWARE OR THE USE OR OTHER DEALINGS IN THE
* SOFTWARE.

Found in hex form in kernel source.

LICENCE TERMS (cont.)

Driver: qed - QLogic 4xxxx Ethernet Driver Core Module.

File: qed/qed_init_values_zipped-8.4.2.0.bin
File: qed/qed_init_values_zipped-8.7.3.0.bin
File: qed/qed_init_values_zipped-8.10.5.0.bin
File: qed/qed_init_values-8.10.9.0.bin
File: qed/qed_init_values_zipped-8.10.10.0.bin
File: qed/qed_init_values-8.14.6.0.bin
File: qed/qed_init_values_zipped-8.15.3.0.bin
File: qed/qed_init_values-8.18.9.0.bin
File: qed/qed_init_values_zipped-8.20.0.0.bin
File: qed/qed_init_values-8.20.0.0.bin
File: qed/qed_init_values-8.30.12.0.bin
File: qed/qed_init_values_zipped-8.33.1.0.bin
File: qed/qed_init_values_zipped-8.33.11.0.bin
File: qed/qed_init_values-8.33.12.0.bin
File: qed/qed_init_values_zipped-8.37.2.0.bin
File: qed/qed_init_values_zipped-8.37.7.0.bin
File: qed/qed_init_values-8.37.7.0.bin

Licence:

This file contains firmware data derived from proprietary unpublished source code.

Copyright (c) 2015-2018 QLogic Corporation.

Permission is hereby granted for the distribution of this firmware data in hexadecimal or equivalent format, provided this copyright notice is accompanying it.

Driver: ueagle-atm - Driver for USB ADSL Modems based on Eagle IV Chipset

File: ueagle-atm/CMV4p.bin.v2
File: ueagle-atm/DSP4p.bin
File: ueagle-atm/eagleIV.fw
Version: 1.0

Licence: Redistributable. See LICENCE.ueagle-atm4-firmware for details

Driver: ueagle-atm - Driver for USB ADSL Modems based on Eagle I,II,III

File: ueagle-atm/930-fpga.bin
File: ueagle-atm/CMVeiWO.bin
File: ueagle-atm/CMVepFR10.bin
File: ueagle-atm/DSP9p.bin
File: ueagle-atm/eagleIII.fw
File: ueagle-atm/adi930.fw
File: ueagle-atm/CMVep.bin
File: ueagle-atm/CMVepFR.bin
File: ueagle-atm/DSPei.bin
File: ueagle-atm/CMV9i.bin
File: ueagle-atm/CMVepES03.bin
File: ueagle-atm/CMVepIT.bin
File: ueagle-atm/DSPep.bin

File: ueagle-atm/CMV9p.bin
File: ueagle-atm/CMVepES.bin
File: ueagle-atm/CMVepWO.bin
File: ueagle-atm/eagleI.fw
File: ueagle-atm/CMVei.bin
File: ueagle-atm/CMVepFR04.bin
File: ueagle-atm/DSP9i.bin
File: ueagle-atm/eagleII.fw
Version: 1.1

Licence: Redistributable. Based on

<https://mail.gna.org/public/eagleusb-dev/2004-11/msg00172.html>

Driver: vxge - Exar X3100 Series 10GbE PCIe I/O Virtualized Server Adapter

File: vxge/X3fw.ncf
File: vxge/X3fw-pxe.ncf
Version: 1.8.1

Licence:

This file contains firmware data derived from proprietary unpublished source code, Copyright (c) 2010 Exar Corporation.

Permission is hereby granted for the distribution of this firmware data in hexadecimal or equivalent format, provided this copyright notice is accompanying it.

Driver: brcmsmac - Broadcom 802.11n softmac wireless LAN driver.

File: brcm/bcm43xx-0.fw
File: brcm/bcm43xx_hdr-0.fw
Version: 610.812

Licence: Redistributable. See LICENCE.broadcom_bcm43xx for details.

Driver: brcmfmac - Broadcom 802.11n fullmac wireless LAN driver.

File: brcm/bcm4329-fullmac-4.bin
File: brcm/brcmfmac43236b.bin
File: brcm/brcmfmac4329-sdio.bin
File: brcm/brcmfmac4330-sdio.bin
File: brcm/brcmfmac4334-sdio.bin
File: brcm/brcmfmac4335-sdio.bin
File: brcm/brcmfmac4339-sdio.bin
File: brcm/brcmfmac43241b0-sdio.bin
File: brcm/brcmfmac43241b4-sdio.bin
File: brcm/brcmfmac43241b5-sdio.bin
File: brcm/brcmfmac43242a.bin
File: brcm/brcmfmac43143.bin
File: brcm/brcmfmac43143-sdio.bin

LICENCE TERMS (cont.)

File: brcm/brcmfmac43430a0-sdio.bin
File: brcm/brcmfmac43455-sdio.bin
File: brcm/brcmfmac4350c2-pcie.bin
File: brcm/brcmfmac4350-pcie.bin
File: brcm/brcmfmac4356-sdio.bin
File: brcm/brcmfmac43569.bin
File: brcm/brcmfmac43570-pcie.bin
File: brcm/brcmfmac4358-pcie.bin
File: brcm/brcmfmac43602-pcie.bin
File: brcm/brcmfmac43602-pcie.ap.bin
File: brcm/brcmfmac4366b-pcie.bin
File: brcm/brcmfmac4366c-pcie.bin
File: brcm/brcmfmac4371-pcie.bin

Licence: Redistributable. See LICENCE.broadcom_bcm43xx for details.

File: brcm/brcmfmac43340-sdio.bin
File: brcm/brcmfmac43362-sdio.bin
File: brcm/brcmfmac43430-sdio.bin
File: brcm/brcmfmac4354-sdio.bin
File: brcm/brcmfmac4356-pcie.bin
File: brcm/brcmfmac4373-sdio.bin
File: brcm/brcmfmac4373.bin

Licence: Redistributable. See LICENCE.cypress for details.

File: "brcm/brcmfmac4330-sdio.Prowise-PT301.txt"
File: "brcm/brcmfmac43340-sdio.meegopad-t08.txt"
File: "brcm/brcmfmac43362-sdio.cubietech,cubietruck.txt"
File: "brcm/brcmfmac43362-sdio.lemaker,bananapro.txt"
File: "brcm/brcmfmac43430a0-sdio.jumper-ezpad-mini3.txt"
File: "brcm/brcmfmac43430a0-sdio.ONDA-V80 PLUS.txt"
File: "brcm/brcmfmac43430-sdio.AP6212.txt"
File: "brcm/brcmfmac43430-sdio.Hampoo-D2D3_Vi8A1.txt"
File: "brcm/brcmfmac43430-sdio.MUR1DX.txt"
File: "brcm/brcmfmac43430-sdio.raspberrypi,3-model-b.txt"
File: "brcm/brcmfmac43455-sdio.raspberrypi,3-model-b-plus.txt"
File: "brcm/brcmfmac4356-pcie.gpd-win-pocket.txt"

Licence: GPLv2. See GPLv2 for details.

Driver: tda7706 - FM radio Highly integrated tuner for AM/FM car-radio

File: TDA7706_OM_v2.5.1_boot.txt
File: TDA7706_OM_v3.0.2_boot.txt

Licence: Redistributable. See LICENCE.tda7706-firmware.txt for details.
Copyright © 2010 STMicroelectronics

Driver: wl1251 - Texas Instruments 802.11 WLAN driver for WiLink4 chips

File: ti-connectivity/wl1251-fw.bin
Version: 4.0.4.3.7

File: ti-connectivity/wl1251-nvs.bin

Licence: Redistributable. See LICENCE.wl1251 for details.

The published NVS files are for testing only. Every device needs to have a unique NVS which is properly calibrated for best results.

The driver expects to find the firmwares under a ti-connectivity subdirectory. So if your system looks for firmwares in /lib/firmware, the firmwares for wl12xx chips must be located in /lib/firmware/ti-connectivity/.

Driver: wl12xx - Texas Instruments 802.11 WLAN driver for WiLink6/7 chips

File: ti-connectivity/wl1271-fw.bin
Version: 6.1.0.50.350 (STA-only)
File: ti-connectivity/wl1271-fw-2.bin
Version: 6.1.5.50.74 (STA-only)
File: ti-connectivity/wl1271-fw-ap.bin
Version: 6.2.1.0.54 (AP-only)
File: ti-connectivity/wl127x-fw-3.bin
Version: 6.3.0.0.77
File: ti-connectivity/wl127x-fw-plt-3.bin
Version: 6.3.0.0.77 (PLT-only)
File: ti-connectivity/wl127x-fw-4-sr.bin
Version: 6.3.5.0.98 (Single-role)
File: ti-connectivity/wl127x-fw-4-mr.bin
Version: 6.5.2.0.15 (Multi-role)
File: ti-connectivity/wl127x-fw-4-plt.bin
Version: 6.3.5.0.98 (PLT-only)
File: ti-connectivity/wl127x-fw-5-sr.bin
Version: 6.3.10.0.142 (Single-role)
File: ti-connectivity/wl127x-fw-5-mr.bin
Version: 6.5.7.0.50 (Multi-role)
File: ti-connectivity/wl127x-fw-5-plt.bin
Version: 6.3.10.0.142 (PLT-only)

File: ti-connectivity/wl128x-fw.bin
Version: 7.1.5.50.74 (STA-only)
File: ti-connectivity/wl128x-fw-ap.bin
Version: 7.2.1.0.54 (AP-only)
File: ti-connectivity/wl128x-fw-3.bin
Version: 7.3.0.0.77
File: ti-connectivity/wl128x-fw-plt-3.bin
Version: 7.3.0.0.77
File: ti-connectivity/wl128x-fw-4-sr.bin
Version: 7.3.5.0.98 (Single-role)
File: ti-connectivity/wl128x-fw-4-mr.bin
Version: 7.5.2.0.15 (Multi-role)
File: ti-connectivity/wl128x-fw-4-plt.bin
Version: 7.3.5.0.98 (PLT)
File: ti-connectivity/wl128x-fw-5-sr.bin
Version: 7.3.10.0.142 (Single-role)

LICENCE TERMS (cont.)

File: ti-connectivity/wl128x-fw-5-mr.bin
Version: 7.5.7.0.50 (Multi-role)
File: ti-connectivity/wl128x-fw-5-plt.bin
Version: 7.3.10.2.142 (PLT-only)

File: ti-connectivity/wl127x-nvs.bin
File: ti-connectivity/wl128x-nvs.bin
Link: ti-connectivity/wl12xx-nvs.bin -> wl127x-nvs.bin
Link: ti-connectivity/wl1271-nvs.bin -> wl127x-nvs.bin

Licence: Redistributable. See LICENCE.ti-connectivity for details.

The NVS file includes two parts:

- radio calibration
- HW configuration parameters (aka. INI values)

The published NVS files are for testing only. Every device needs to have a unique NVS which is properly calibrated for best results. You can find more information about NVS generation for your device here:

<http://wireless.kernel.org/en/users/Drivers/wl12xx/calibrator>

If you're using a wl127x based device, use a symbolic link called wl1271-nvs.bin that links to the wl127x-nvs.bin file. If you are using wl128x, link to wl128x-nvs.bin instead.

The driver expects to find the firmwares under a ti-connectivity subdirectory. So if your system looks for firmwares in /lib/firmware, the firmwares for wl12xx chips must be located in /lib/firmware/ti-connectivity/.

Driver: wl18xx - Texas Instruments 802.11 WLAN driver for WiLink8 chips

File: ti-connectivity/wl18xx-fw.bin
Version: 8.2.0.0.100
File: ti-connectivity/wl18xx-fw-2.bin
Version: 8.5.0.0.55
File: ti-connectivity/wl18xx-fw-3.bin
Version: 8.8.0.0.13
File: ti-connectivity/wl18xx-fw-4.bin
Version: 8.9.0.0.79

Licence: Redistributable. See LICENCE.ti-connectivity for details.

The driver expects to find the firmwares under a ti-connectivity subdirectory. So if your system looks for firmwares in /lib/firmware, the firmwares for wl18xx chips must be located in /lib/firmware/ti-connectivity/.

Driver: TI_ST - Texas Instruments bluetooth driver

File: ti-connectivity/TIInit_6.2.31.bts
Version: 2.44 (TI_P31.123)

File: ti-connectivity/TIInit_6.6.15.bts
Version: 2.14 (TI_P6_15.93)
File: ti-connectivity/TIInit_7.2.31.bts

Licence: Redistributable. See LICENCE.ti-connectivity for details.

TIInit_7.2.31.bts version 7.2.31

In order to use that file copy it to /lib/firmware/ti-connectivity.

Driver: tlg2300 - Telgent 2300 V4L/DVB driver.

File: tlg2300_firmware.bin

Licence: Redistributable.

Telegent System grants permission to use and redistribute these firmware files for use with devices containing the chip tlg2300, but not as a part of the Linux kernel or in any other form which would require these files themselves to be covered by the terms of the GNU General Public License. These firmware files are distributed in the hope that they will be useful, but WITHOUT ANY WARRANTY; without even the implied warranty of MERCHANTABILITY or FITNESS FOR A PARTICULAR PURPOSE.

Driver: r8712u - Realtek 802.11n WLAN driver for RTL8712U

File: rtlwifi/rtl8712u.bin
Info: From Vendor's rtl8712_8188_8191_8192SU_usb_linux_v7_0.20100831
Reverted rtl8188C_8192C_8192D_usb_linux_v3.4.2_3727.20120404

Licence: Redistributable. See LICENCE.rtlwifi_firmware.txt for details.

Driver: rtl8192ce - Realtek 802.11n WLAN driver for RTL8192CE

File: rtlwifi/rtl8192cfw.bin
File: rtlwifi/rtl8192cfwU.bin
File: rtlwifi/rtl8192cfwU_B.bin
Info: From Vendor's realtek/rtlwifi_linux_mac80211_0019.0320.2014V628 driver

Licence: Redistributable. See LICENCE.rtlwifi_firmware.txt for details.

Driver: rtl8192cu - Realtek 802.11n WLAN driver for RTL8192CU

File: rtlwifi/rtl8192cufw.bin
File: rtlwifi/rtl8192cufw_A.bin
File: rtlwifi/rtl8192cufw_B.bin
File: rtlwifi/rtl8192cufw_TMSC.bin

LICENCE TERMS (cont.)

Licence: Redistributable. See LICENCE.rtlwifi_firmware.txt for details.

Driver: rtl8192se - Realtek 802.11n WLAN driver for RTL8192SE

Info: updated from rtl_92ce_92se_92de_linux_mac80211_0004.0816.2011 driver version
File: rtlwifi/rtl8192sefw.bin

Licence: Redistributable. See LICENCE.rtlwifi_firmware.txt for details.

Driver: rtl8192de - Realtek 802.11n WLAN driver for RTL8192DE

Info: Updated from Realtek version rtl_92ce_92se_92de_8723ae_linux_mac80211_0007.0809.2012
File: rtlwifi/rtl8192defw.bin

Licence: Redistributable. See LICENCE.rtlwifi_firmware.txt for details.

Driver: rtl8723e - Realtek 802.11n WLAN driver for RTL8723E

Info: Taken from Realtek version rtl_92ce_92se_92de_8723ae_linux_mac80211_0007.0809.2012
File: rtlwifi/rtl8723fw.bin
File: rtlwifi/rtl8723fw_B.bin

Licence: Redistributable. See LICENCE.rtlwifi_firmware.txt for details.

Driver: rtl8723be - Realtek 802.11n WLAN driver for RTL8723BE

Info: From Vendor's realtek/rtlwifi_linux_mac80211_0019.0320.2014V628 driver
File: rtlwifi/rtl8723befw.bin
Info: Update to version 36 - Sent by Realtek
File: rtlwifi/rtl8723befw_36.bin

Licence: Redistributable. See LICENCE.rtlwifi_firmware.txt for details.

Driver: rtl8723de - Realtek 802.11ac WLAN driver for RTL8723DE

Info: Supplied by Vendor at https://github.com/pkshih/rtlwifi_rtl8723de
File: rtlwifi/rtl8723defw.bin

Licence: Redistributable. See LICENCE.rtlwifi_firmware.txt for details.

Driver: r8723au - Realtek 802.11n WLAN driver for RTL8723AU

Info: Taken from Realtek driver rtl8723A_WiFi_linux_v4.1.3_6044.20121224
Firmware is embedded in the driver as data statements. This info
has been extracted into a binary file.

File: rtlwifi/rtl8723aufw_A.bin
File: rtlwifi/rtl8723aufw_B.bin
File: rtlwifi/rtl8723aufw_B_NoBT.bin

Licence: Redistributable. See LICENCE.rtlwifi_firmware.txt for details.

Driver: rtl8188ee - Realtek 802.11n WLAN driver for RTL8188EE

Info: Taken from Realtek version rtl_92ce_92se_92de_8723ae_88ee_linux_mac80211_0010.0109.2013
File: rtlwifi/rtl8188efw.bin

Licence: Redistributable. See LICENCE.rtlwifi_firmware.txt for details.

Driver: rtl8188eu - Realtek 802.11n WLAN driver for RTL8188EU

Info: Taken from Realtek version RTL8188EUS_linux_v4.1.4_6773.20130222
File: rtlwifi/rtl8188eufw.bin

Licence: Redistributable. See LICENCE.rtlwifi_firmware.txt for details.

Driver: rtl8821ae - Realtek 802.11n WLAN driver for RTL8821AE

Info: From Vendor's realtek/rtlwifi_linux_mac80211_0019.0320.2014V628 driver
File: rtlwifi/rtl8821aefw.bin
File: rtlwifi/rtl8821aefw_wowlan.bin
Info: Update to version 29 - Sent by Realtek
File: rtlwifi/rtl8821aefw_29.bin

Licence: Redistributable. See LICENCE.rtlwifi_firmware.txt for details.

Driver: rtl8822be - Realtek 802.11n WLAN driver for RTL8822BE

Info: Sent to Larry Finger by Realtek engineer Ping-Ke Shih <pkshih@realtek.com>
File: rtlwifi/rtl8822befw.bin

Licence: Redistributable. See LICENCE.rtlwifi_firmware.txt for details.

Driver: rtw88 - Realtek 802.11ac WLAN driver for RTL8822BE and RTL8822CE

Info: Sent to Larry Finger by Realtek engineer Yan-Hsuan Chuang <yhchuang@realtek.com>
File: rtw88/rtw8822b_fw.bin
File: rtw88/rtw8822c_fw.bin
File: rtw88/rtw8822c_wow_fw.bin
File: rtw88/README

Licence: Redistributable. See LICENCE.rtlwifi_firmware.txt for details.

LICENCE TERMS (cont.)

Driver: rtl8192ee - Realtek 802.11n WLAN driver for RTL8192EE

Info: Initial version taken from Realtek version
rtl_92ce_92se_92de_8723ae_88ee_8723be_92ee_linux_mac80211_0017.1224.2013
Updated Jan. 14, 2015 with file added by Realtek to
http://github.com/lwfinger/rtlwifi_new.git.
File: rtlwifi/rtl8192eefw.bin

Licence: Redistributable. See LICENCE.rtlwifi_firmware.txt for details.

Driver: rtl8723bs - Realtek 802.11n WLAN driver for RTL8723BS

Info: Firmware files extracted from data statements in Realtek driver
v4.3.5.5_12290.20140916_BTCOEX20140507-4E40.
File: rtlwifi/rtl8723bs_bt.bin
File: rtlwifi/rtl8723bs_nic.bin
File: rtlwifi/rtl8723bs_ap_wowlan.bin
File: rtlwifi/rtl8723bs_wowlan.bin

Licence: Redistributable. See LICENCE.rtlwifi_firmware.txt for details.

Driver: rtl8xxxu - Realtek 802.11n WLAN driver for RTL8XXX USB devices

Info: rtl8723au taken from Realtek driver
rtl8723A_WiFi_linux_v4.1.3_6044.20121224
Firmware is embedded in the driver as data statements. This info
has been extracted into a binary file.
File: rtlwifi/rtl8723aufw_A.bin
File: rtlwifi/rtl8723aufw_B.bin
File: rtlwifi/rtl8723aufw_B_NoBT.bin

Info: rtl8723bu taken from Realtek driver
rtl8723BU_WiFi_linux_v4.3.16_14189.20150519_BTCOEX20150119-5844
Firmware is embedded in the driver as data statements. This info
has been extracted into a binary file.
File: rtlwifi/rtl8723bu_nic.bin
File: rtlwifi/rtl8723bu_wowlan.bin
File: rtlwifi/rtl8723bu_ap_wowlan.bin

Info: rtl8192eu taken from Realtek driver
rtl8192EU_linux_v4.3.1.1_11320.20140505
Firmware is embedded in the driver as data statements. This info
has been extracted into a binary file.
File: rtlwifi/rtl8192eu_nic.bin
File: rtlwifi/rtl8192eu_wowlan.bin
File: rtlwifi/rtl8192eu_ap_wowlan.bin

Licence: Redistributable. See LICENCE.rtlwifi_firmware.txt for details.

Driver: r8169 - RealTek 8169/8168/8101 ethernet driver.

File: rtl_nic/rtl8168d-1.fw
File: rtl_nic/rtl8168d-2.fw
File: rtl_nic/rtl8105e-1.fw
File: rtl_nic/rtl8168e-1.fw
File: rtl_nic/rtl8168e-2.fw

File: rtl_nic/rtl8168e-3.fw
Version: 0.0.4

File: rtl_nic/rtl8168f-1.fw
Version: 0.0.5

File: rtl_nic/rtl8168f-2.fw
Version: 0.0.4

File: rtl_nic/rtl8411-1.fw
Version: 0.0.3

File: rtl_nic/rtl8411-2.fw
Version: 0.0.1

File: rtl_nic/rtl8402-1.fw
Version: 0.0.1

File: rtl_nic/rtl8106e-1.fw
Version: 0.0.1

File: rtl_nic/rtl8106e-2.fw
Version: 0.0.1

File: rtl_nic/rtl8168g-1.fw
Version: 0.0.3

File: rtl_nic/rtl8168g-2.fw
Version: 0.0.1

File: rtl_nic/rtl8168g-3.fw
Version: 0.0.1

File: rtl_nic/rtl8168h-1.fw
Version: 0.0.2

File: rtl_nic/rtl8168h-2.fw
Version: 0.0.2

File: rtl_nic/rtl8107e-1.fw
Version: 0.0.2

File: rtl_nic/rtl8107e-2.fw
Version: 0.0.2

Licence:

* Copyright © 2011-2013, Realtek Semiconductor Corporation

*

* Permission is hereby granted for the distribution of this firmware

LICENCE TERMS (cont.)

* data in hexadecimal or equivalent format, provided this copyright
* notice is accompanying it.

Driver: vt6656 - VIA VT6656 USB wireless driver

File: vntwusb.fw

Licence: Redistributable. See LICENCE.via_vt6656 for details.

Driver: DFU Driver for Atheros bluetooth chipset AR3012

File: ar3k/AthrBT_0x01020001.dfu
File: ar3k/ramps_0x01020001_26.dfu
File: ar3k/AthrBT_0x01020200.dfu
File: ar3k/ramps_0x01020200_26.dfu
File: ar3k/ramps_0x01020200_40.dfu
File: ar3k/AthrBT_0x31010000.dfu
File: ar3k/ramps_0x31010000_40.dfu
File: ar3k/AthrBT_0x11020000.dfu
File: ar3k/ramps_0x11020000_40.dfu
File: ar3k/ramps_0x01020201_26.dfu
File: ar3k/ramps_0x01020201_40.dfu
File: ar3k/AthrBT_0x41020000.dfu
File: ar3k/ramps_0x41020000_40.dfu
File: ar3k/AthrBT_0x11020100.dfu
File: ar3k/ramps_0x11020100_40.dfu
File: ar3k/AthrBT_0x31010100.dfu
File: ar3k/ramps_0x31010100_40.dfu

Licence: Redistributable. See LICENCE.atheros_firmware for details

Driver: DFU Driver for Atheros bluetooth chipset AR3012

File: ar3k/AthrBT_0x01020201.dfu
File: ar3k/1020201coex/ramps_0x01020201_26_HighPriority.dfu

Licence: Redistributable. See LICENCE.QualcommAtheros_ar3k for details

Driver: Atheros AR300x UART HCI Bluetooth Chip driver

File: ar3k/1020201/PS_ASIC.pst
File: ar3k/1020201/RamPatch.txt
File: ar3k/1020200/ar3kbdaddr.pst
File: ar3k/1020200/PS_ASIC.pst
File: ar3k/1020200/RamPatch.txt
File: ar3k/30101/ar3kbdaddr.pst
File: ar3k/30101/PS_ASIC.pst
File: ar3k/30101/RamPatch.txt
File: ar3k/30000/ar3kbdaddr.pst

File: ar3k/30000/PS_ASIC.pst
File: ar3k/30000/RamPatch.txt

Licence: Redistributable. See LICENCE.atheros_firmware for details

Driver: ath6kl - Atheros support for AR6003

File: ath6k/AR6004/hw1.3/fw-3.bin
File: ath6k/AR6004/hw1.3/bdata.bin
File: ath6k/AR6004/hw1.2/fw-2.bin
File: ath6k/AR6004/hw1.2/bdata.bin
File: ath6k/AR6003/hw1.0/otp.bin.z77
File: ath6k/AR6003/hw1.0/bdata.SD31.bin
File: ath6k/AR6003/hw1.0/bdata.SD32.bin
File: ath6k/AR6003/hw1.0/data.patch.bin
File: ath6k/AR6003/hw1.0/bdata.WB31.bin
File: ath6k/AR6003/hw1.0/athwlan.bin.z77
File: ath6k/AR6003/hw2.1.1/fw-2.bin
File: ath6k/AR6003/hw2.1.1/fw-3.bin
File: ath6k/AR6003/hw2.1.1/otp.bin
File: ath6k/AR6003/hw2.1.1/athwlan.bin
File: ath6k/AR6003/hw2.1.1/endpointping.bin
File: ath6k/AR6003/hw2.1.1/bdata.SD31.bin
File: ath6k/AR6003/hw2.1.1/bdata.SD32.bin
File: ath6k/AR6003/hw2.1.1/data.patch.bin
File: ath6k/AR6003/hw2.1.1/bdata.WB31.bin
File: ath6k/AR6003/hw2.0/otp.bin.z77
File: ath6k/AR6003/hw2.0/bdata.SD31.bin
File: ath6k/AR6003/hw2.0/bdata.SD32.bin
File: ath6k/AR6003/hw2.0/data.patch.bin
File: ath6k/AR6003/hw2.0/bdata.WB31.bin
File: ath6k/AR6003/hw2.0/athwlan.bin.z77
File: ath6k/AR6002/EEPROM.data
File: ath6k/AR6002/EEPROM.bin
File: ath6k/AR6002/athwlan.bin.z77
File: ath6k/AR6002/data.patch.hw2_0.bin

Licence: Redistributable. See LICENCE.atheros_firmware for details

Driver: ath10k - Qualcomm Atheros support for QCA988x family of chips

File: ath10k/QCA988X/hw2.0/board.bin
File: ath10k/QCA988X/hw2.0/firmware-4.bin
Version: 10.2.4.45
Licence: ath10k/QCA988X/hw2.0/notice_ath10k_firmware-4.txt
File: ath10k/QCA988X/hw2.0/firmware-5.bin
Version: 10.2.4-1.0-00045
Licence: ath10k/QCA988X/hw2.0/notice_ath10k_firmware-5.txt
File: ath10k/QCA6174/hw2.1/board.bin
File: ath10k/QCA6174/hw2.1/board-2.bin
File: ath10k/QCA6174/hw2.1/firmware-5.bin
Version: SW_RM.1.1.1-00157-QCARMSWPZ-1
Licence: ath10k/QCA6174/hw2.1/notice_ath10k_firmware-5.txt

LICENCE TERMS (cont.)

File: ath10k/QCA6174/hw3.0/board.bin
File: ath10k/QCA6174/hw3.0/board-2.bin
File: ath10k/QCA6174/hw3.0/firmware-4.bin
Version: WLAN.RM.2.0-00180-QCARMSWPZ-1
Licence: ath10k/QCA6174/hw3.0/notice_ath10k_firmware-4.txt
File: ath10k/QCA6174/hw3.0/firmware-6.bin
Version: WLAN.RM.4.4.1-00140-QCARMSWPZ-1
Licence: ath10k/QCA6174/hw3.0/notice_ath10k_firmware-6.txt
File: ath10k/QCA9377/hw1.0/board.bin
File: ath10k/QCA9377/hw1.0/board-2.bin
File: ath10k/QCA9377/hw1.0/firmware-5.bin
Version: WLAN.TF.1.0-00002-QCATFSWPZ-5
Licence: ath10k/QCA9377/hw1.0/notice_ath10k_firmware-5.txt
File: ath10k/QCA99X0/hw2.0/board.bin
File: ath10k/QCA99X0/hw2.0/firmware-5.bin
Version: 10.4.1.00030-1
Licence: ath10k/QCA99X0/hw2.0/notice_ath10k_firmware-5.txt
File: ath10k/QCA4019/hw1.0/board-2.bin
File: ath10k/QCA4019/hw1.0/firmware-5.bin
Version: 10.4-3.6-00140
Licence: ath10k/QCA4019/hw1.0/notice_ath10k_firmware-5.txt
File: ath10k/QCA9887/hw1.0/board.bin
File: ath10k/QCA9887/hw1.0/firmware-5.bin
Version: 10.2.4-1.0-00045
Licence: ath10k/QCA9887/hw1.0/notice_ath10k_firmware-5.txt
File: ath10k/QCA9888/hw2.0/board-2.bin
File: ath10k/QCA9888/hw2.0/firmware-5.bin
Version: 10.4-3.9.0.2-00040
Licence: ath10k/QCA9888/hw2.0/notice_ath10k_firmware-5.txt
File: ath10k/QCA9984/hw1.0/board-2.bin
File: ath10k/QCA9984/hw1.0/firmware-5.bin
Version: 10.4-3.9.0.2-00046
Licence: ath10k/QCA9984/hw1.0/notice_ath10k_firmware-5.txt
File: ath10k/QCA9377/hw1.0/firmware-6.bin
Version: WLAN.TF.2.1-00021-QCARMSWP-1
Licence: ath10k/QCA9377/hw1.0/notice_ath10k_firmware-6.txt

Licence: Redistributable. See LICENSE.QualcommAtheros_ath10k for details

Driver: myri10ge - Myri10GE 10GbE NIC driver

File: myri10ge_eth_z8e.dat
File: myri10ge_ethp_z8e.dat
File: myri10ge_rss_eth_z8e.dat
File: myri10ge_rss_ethp_z8e.dat
File: myri10ge_eth_big_z8e.dat
File: myri10ge_ethp_big_z8e.dat
File: myri10ge_rss_eth_big_z8e.dat
File: myri10ge_rss_ethp_big_z8e.dat
Version: 1.4.57

Licence: Redistributable. See LICENCE.myri10ge_firmware for details.

Driver: ath6kl - Atheros support for AR6003 WiFi-Bluetooth combo module

File: ath6k/AR6003.1/hw2.1.1/athwlan.bin
File: ath6k/AR6003.1/hw2.1.1/bdata.SD31.bin
File: ath6k/AR6003.1/hw2.1.1/bdata.SD32.bin
File: ath6k/AR6003.1/hw2.1.1/bdata.WB31.bin
File: ath6k/AR6003.1/hw2.1.1/data.patch.bin
File: ath6k/AR6003.1/hw2.1.1/endpointping.bin
File: ath6k/AR6003.1/hw2.1.1/otp.bin

Licence: Redistributable. See LICENCE.atheros_firmware for details

Driver: ath6kl - Atheros support for AR3001 WiFi-Bluetooth combo module

File: ar3k/30101coex/ar3kaddr.pst
File: ar3k/30101coex/PS_ASIC_aclLowPri.pst
File: ar3k/30101coex/PS_ASIC_aclHighPri.pst
File: ar3k/30101coex/PS_ASIC.pst
File: ar3k/30101coex/RamPatch.txt

Licence: Redistributable. See LICENCE.atheros_firmware for details

Driver: drxk - Micronas DRX-K demodulator driver

File: dvb-usb-terratec-h5-drxk.fw

Licence: Redistributable.

TERRATEC grants permission to use and redistribute these firmware files for use with TERRATEC devices, but not as part of the Linux kernel or in any other form which would require these files themselves to be covered by the terms of the GNU General Public License.

These firmware files are distributed in the hope that they will be useful, but WITHOUT ANY WARRANTY; without even the implied warranty of MERCHANTABILITY or FITNESS FOR A PARTICULAR PURPOSE.

Driver: ene-ub6250 -- ENE UB6250 SD card reader driver

File: ene-ub6250/sd_init1.bin
File: ene-ub6250/sd_init2.bin
File: ene-ub6250/sd_rdw.bin
File: ene-ub6250/ms_init.bin
File: ene-ub6250/msp_rdw.bin
File: ene-ub6250/ms_rdw.bin

Licence: Redistributable. See LICENCE.ene_firmware for details.

LICENCE TERMS (cont.)

Driver: isci -- Intel C600 SAS controller driver

File: isci/isci_firmware.bin
Source: isci/

Licence: GPLv2. See GPL-2 for details.

Driver: ar5523 -- Atheros AR5523 based USB Wifi dongles

File: ar5523.bin

Licence: Redistributable. See LICENCE.atheros_firmware for details

Driver: s5p-mfc - Samsung MFC video encoder/decoder driver

File: s5p-mfc.fw
File: s5p-mfc-v6.fw
File: s5p-mfc-v6-v2.fw
File: s5p-mfc-v7.fw
File: s5p-mfc-v8.fw

Licence: Redistributable.

Samsung grants permission to use and redistribute aforementioned firmware files for the use with Exynos series devices, but not as part of the Linux kernel, or in any other form which would require these files themselves to be covered by the terms of the GNU General Public License.

These firmware files are distributed in the hope that they will be useful, but WITHOUT ANY WARRANTY; without even the implied warranty of MERCHANTABILITY or FITNESS FOR A PARTICULAR PURPOSE.

Driver: carl9170 -- Atheros AR9170 802.11 draft-n USB driver

File: carl9170-1.fw
Version: 1.9.6
Source: carl9170fw/

Downloaded from <http://linuxwireless.org/en/users/Drivers/carl9170>

Licence: GPLv2. Some build scripts use the New BSD (3-clause) licence.. See GPL-2 for details.

Driver: snd-hda-codec-ca0132 - Creative Sound Core3D codec

File: ctefx.bin
File: ctspeq.bin

Licence: Redistributable. See LICENCE.ca0132 for details

Found also in alsa-firmware package.

Driver: btusb - Bluetooth USB driver

File: intel/ibt-hw-37.7.bseq
Version: 1316.02.00
File: intel/ibt-hw-37.7.10-fw-1.80.2.3.d.bseq
Version: BT_WilkinsPeak_B3_REL_87_0001
File: intel/ibt-hw-37.7.10-fw-1.0.2.3.d.bseq
Version: BT_WilkinsPeak_B3_REL_87_0001
File: intel/ibt-hw-37.7.10-fw-1.80.1.2d.d.bseq
Version: BT_WilkinsPeak_B5_REL_42_0001
File: intel/ibt-hw-37.7.10-fw-1.0.1.2d.d.bseq
Version: BT_WilkinsPeak_B5_REL_42_0001
File: intel/ibt-hw-37.8.bseq
Version: 1339_02.00
File: intel/ibt-hw-37.8.10-fw-1.10.2.27.d.bseq
Version: BT_StonePeak_C0_REL_59_0001
File: intel/ibt-hw-37.8.10-fw-1.10.3.11.e.bseq
Version: BT_StonePeak_D0_REL_50_0002
File: intel/ibt-hw-37.8.10-fw-22.50.19.14.f.bseq
Version: BT_StonePeak_D1_REL_52_00005
File: intel/ibt-11-5.ddc
Version: LnP/SfP_REL0522
File: intel/ibt-11-5.sfi
Version: BT_LightningPeak_REL0487
File: intel/ibt-12-16.ddc
Version: BT_WindStormPeak_REL0306
File: intel/ibt-12-16.sfi
Version: BT_WindStormPeak_REL0306
File: intel/ibt-17-16-1.sfi
Version: BT_JeffersonPeak_B0_B0_REL0472
File: intel/ibt-17-16-1.ddc
Version: BT_JeffersonPeak_B0_B0_REL0472
File: intel/ibt-17-2.sfi
Version: BT_JeffersonPeak_B0_B0_REL0472
File: intel/ibt-17-2.ddc
Version: BT_JeffersonPeak_B0_B0_REL0472
File: intel/ibt-17-0-1.sfi
Version: BT_JeffersonPeak_A0_B0_REL0201
File: intel/ibt-17-0-1.ddc
Version: BT_JeffersonPeak_A0_B0_REL0201
File: intel/ibt-17-1.sfi
Version: BT_JeffersonPeak_A0_B0_REL0201
File: intel/ibt-17-1.ddc
Version: BT_JeffersonPeak_A0_B0_REL0201
File: intel/ibt-18-16-1.sfi
Version: BT_ThunderPeak_B0_B0_REL0472
File: intel/ibt-18-16-1.ddc
Version: BT_ThunderPeak_B0_B0_REL0472
File: intel/ibt-18-2.sfi
Version: BT_ThunderPeak_B0_B0_REL0472
File: intel/ibt-18-2.ddc
Version: BT_ThunderPeak_B0_B0_REL0472
File: intel/ibt-18-0-1.sfi

LICENCE TERMS (cont.)

Version: BT_ThunderPeak_A0_B0_REL0201
File: intel/ibt-18-0-1.ddc
Version: BT_ThunderPeak_A0_B0_REL0201
File: intel/ibt-18-1.sfi
Version: BT_ThunderPeak_A0_B0_REL0201
File: intel/ibt-18-1.ddc
Version: BT_ThunderPeak_A0_B0_REL0201
File: intel/ibt-20-0-3.sfi
Version: BT_CyclonePeak_A0_REL0310
File: intel/ibt-20-0-3.ddc
Version: BT_CyclonePeak_A0_REL0310
File: intel/ibt-20-1-3.sfi
Version: BT_CyclonePeak_A0_REL0310
File: intel/ibt-20-1-3.ddc
Version: BT_CyclonePeak_A0_REL_0310
File: intel/ibt-20-1-4.sfi
Version: BT_CyclonePeak_A0_REL0310
File: intel/ibt-20-1-4.ddc
Version: BT_CyclonePeak_A0_REL0310
File: intel/ibt-19-0-0.sfi
Version: BT_Quasar_REL0310
File: intel/ibt-19-0-0.ddc
Version: BT_Quasar_REL0310
File: intel/ibt-19-0-1.sfi
Version: BT_Quasar_REL0310
File: intel/ibt-19-0-1.ddc
Version: BT_Quasar_REL0310
File: intel/ibt-19-0-4.sfi
Version: BT_HarrisonPeak_REL0310
File: intel/ibt-19-0-4.ddc
Version: BT_HarrisonPeak_REL0310
File: intel/ibt-19-16-4.sfi
Version: BT_HarrisonPeak_REL0310
File: intel/ibt-19-16-4.ddc
Version: BT_HarrisonPeak_REL0310
File: intel/ibt-19-32-1.sfi
Version: BT_HarrisonPeak_REL0310
File: intel/ibt-19-32-1.ddc
Version: BT_HarrisonPeak_REL0310
File: intel/ibt-19-32-0.sfi
Version: BT_HarrisonPeak_REL0310
File: intel/ibt-19-32-0.ddc
Version: BT_HarrisonPeak_REL0310

Licence: Redistributable. See LICENCE.ibt_firmware for details

File: rtl_bt/rtl8192ee_fw.bin
File: rtl_bt/rtl8192eu_fw.bin
File: rtl_bt/rtl8723a_fw.bin
File: rtl_bt/rtl8723b_fw.bin
File: rtl_bt/rtl8723bs_fw.bin
File: rtl_bt/rtl8723bs_config-OBDA8723.bin
File: rtl_bt/rtl8761a_fw.bin
File: rtl_bt/rtl8812ae_fw.bin
File: rtl_bt/rtl8821a_fw.bin
File: rtl_bt/rtl8822b_fw.bin

File: rtl_bt/rtl8822b_config.bin
File: rtl_bt/rtl8723d_fw.bin
File: rtl_bt/rtl8723d_config.bin
File: rtl_bt/rtl8821c_fw.bin
File: rtl_bt/rtl8821c_config.bin
File: rtl_bt/rtl8822cu_fw.bin

Licence: Redistributable. See LICENCE.rtlwifi_firmware.txt for details.

Found in vendor driver, linux_bt_usb_2.11.20140423_8723be.rar
From https://github.com/troy-tan/driver_store
Files rtl_bt/rtl8822b_* came directly from Realtek. These files are updated on April 14, 2017.
Files rtl_bt/rtl8821c_* and rtl_bt/rtl8723d_* came directly from Realtek.
File rtl_bt/rtl8822cu_fw.bin came directly from Realtek.
updated on February 24, 2019
File rtl_bt/rtl8822cu_fw.bin came directly from Realtek.

Driver: btmnk_usb - Bluetooth USB driver

File: mt7650.bin

Licence: Redistributable. See LICENCE.ralink_a_mediatek_company_firmware for details

Driver: rp2 -- Comtrol RocketPort 2 serial driver

File: rp2.fw

Licence: Redistributable.

Copyright (C) 2013 Comtrol Corporation

Comtrol grants permission to use and redistribute these firmware files for use with Comtrol devices, but not as part of the Linux kernel or in any other form which would require these files themselves to be covered by the terms of the GNU General Public License.

These firmware files are distributed in the hope that they will be useful, but WITHOUT ANY WARRANTY; without even the implied warranty of MERCHANTABILITY or FITNESS FOR A PARTICULAR PURPOSE.

Driver: go7007

File: go7007/s2250-1.fw
File: go7007/s2250-2.fw
Link: s2250.fw -> go7007/s2250-2.fw
Link: s2250_loader.fw -> go7007/s2250-1.fw

Licence:

Sensoray grants permission to use and redistribute these firmware files for use with Sensoray devices, but not as a part of the Linux

LICENCE TERMS (cont.)

kernel or in any other form which would require these files themselves to be covered by the terms of the GNU General Public License. These firmware files are distributed in the hope that they will be useful, but WITHOUT ANY WARRANTY; without even the implied warranty of MERCHANTABILITY or FITNESS FOR A PARTICULAR PURPOSE.

File: go7007/go7007fw.bin
File: go7007/go7007tv.bin
File: go7007/lr192.fw
File: go7007/px-m402u.fw
File: go7007/px-tv402u.fw
File: go7007/wis-startrek.fw

License: Redistributable. See LICENCE.go7007 for details

Driver: ccp - Platform Security Processor (PSP) device

File: amd/amd_sev_fam17h_model0xh.sbin
Version: 2019-02-13

License: Redistributable. See LICENSE.amd-sev for details

Driver: microcode_amd - AMD CPU Microcode Update Driver for Linux

File: amd-ucode/microcode_amd.bin
Version: 2013-07-10
File: amd-ucode/microcode_amd_fam15h.bin
Version: 2018-05-24
File: amd-ucode/microcode_amd_fam16h.bin
Version: 2014-10-28
File: amd-ucode/microcode_amd_fam17h.bin
Version: 2018-11-28

License: Redistributable. See LICENSE.amd-ucode for details

Driver: mxu11x0 - MOXA UPort 11x0 USB Serial hub driver

File: moxa/moxa-1110.fw
File: moxa/moxa-1130.fw
File: moxa/moxa-1131.fw
File: moxa/moxa-1150.fw
File: moxa/moxa-1151.fw

License: Redistributable. See LICENCE.moxa for details

Driver: mxuport - MOXA UPort USB Serial hub driver

File: moxa/moxa-1250.fw
File: moxa/moxa-1251.fw

File: moxa/moxa-1410.fw
File: moxa/moxa-1450.fw
File: moxa/moxa-1451.fw
File: moxa/moxa-1613.fw
File: moxa/moxa-1618.fw
File: moxa/moxa-1653.fw
File: moxa/moxa-1658.fw

License: Redistributable. See LICENCE.moxa for details

Driver: cw1200 - ST-E CW1100/CW1200 WLAN driver

File: wsm_22.bin
Version: WSM395
License: Redistributable. See LICENCE.cw1200 for details.

File: sdd_sagrad_1091_1098.bin

License:
Copyright (c) 2011-2013 Sagrad, Inc.

This SDD ("Static Dynamic Data") file is licensed strictly for use with the Sagrad WiFi modules (such as the SG901-1091/1098) that utilize the cw1200 driver. There is no warranty expressed or implied about its fitness for any purpose.

Permission is hereby granted for the distribution of this SDD file as part of Linux or other Open Source operating system kernel in text or binary form as required.

(Please note that the actual device firmware is separately licensed)

Driver: BFA/BNA - QLogic BR-series Adapter FC/FCOE drivers

File: cbfw-3.2.1.1.bin
File: ctfw-3.2.1.1.bin
File: ct2fw-3.2.1.1.bin
File: cbfw-3.2.3.0.bin
File: ctfw-3.2.3.0.bin
File: ct2fw-3.2.3.0.bin
File: cbfw-3.2.5.1.bin
File: ctfw-3.2.5.1.bin
File: ct2fw-3.2.5.1.bin

License:

This file contains firmware data derived from proprietary unpublished source code.

Copyright (c) 2013-2014 Brocade Communications Systems, Inc.
Copyright (c) 2014-2015 QLogic Corporation.

Permission is hereby granted for the distribution of this firmware data in hexadecimal or equivalent format, provided this copyright notice is

LICENCE TERMS (cont.)

accompanying it.

QLogic grants permission to use and redistribute these firmware files for use with QLogic BR-series devices, but not as a part of the Linux kernel or in any other form which would require these files themselves to be covered by the terms of the GNU General Public License. These firmware files are distributed in the hope that they will be useful, but WITHOUT ANY WARRANTY; without even the implied warranty of MERCHANTABILITY or FITNESS FOR A PARTICULAR PURPOSE.

Driver: qat - Intel(R) QAT crypto accelerator

File: qat_895xcc.bin
File: qat_895xcc_mmp.bin
File: qat_c3xxx.bin
File: qat_c3xxx_mmp.bin
File: qat_c62x.bin
File: qat_c62x_mmp.bin
Link: qat_mmp.bin -> qat_895xcc_mmp.bin

Licence: Redistributable. See LICENCE.qat_firmware for details

Driver: rsi -- Redpine Signals Inc 91x driver

File: rsi_91x.fw

File: rsi/rs9113_wlan_qsps.rps
Version: 1.6.1

File: rsi/rs9113_wlan_bt_dual_mode.rps
Version: 1.6.1

File: rsi/rs9113_ap_bt_dual_mode.rps
Version: 1.6.1

File: rsi/rs9116_wlan.rps
Version: 1.0.5b

File: rsi/rs9116_wlan_bt_classic.rps
Version: 1.0.5b

Licence:
* Firmware is:
* Derived from proprietary unpublished source code,
* Copyright (C) 2019 Redpine Signals Inc.
*
* Permission is hereby granted for the distribution of this firmware
* as part of Linux or other Open Source operating system kernel
* provided this copyright notice is accompanying it.

Driver: xhci-rcar -- Renesas R-Car Gen2/3 USB 3.0 host controller driver

File: r8a779x_usb3_v1.dlmem
File: r8a779x_usb3_v2.dlmem
File: r8a779x_usb3_v3.dlmem

Licence: Redistributable. See LICENCE.r8a779x_usb3 for details.

Driver: snd_soc_sst_acpi

File: intel/fw_sst_0f28.bin-48kHz_i2s_master

Licence: Redistributable. See LICENCE.fw_sst_0f28 for details

Driver: as102 - Abilis Systems Single DVB-T Receiver

File: as102_data1_st.hex
File: as102_data2_st.hex

Licence: Redistributable. See LICENCE.Abilis for details

Driver: it9135 -- ITEtech IT913x DVB-T USB driver

File: dvb-usb-it9135-01.fw
File: dvb-usb-it9135-02.fw

Licence: Redistributable. See LICENCE.it913x for details

Driver: snd_soc_sst_acpi

File: intel/IntcSST2.bin
Version: 8.4.1.77

Licence: Redistributable. See LICENCE.IntcSST2 for details

Driver: snd_intel_sst_core

File: intel/fw_sst_0f28.bin
File: intel/fw_sst_0f28_ssp0.bin

Licence: Redistributable. See LICENCE.fw_sst_0f28 for details

Driver: snd_intel_sst_core

File: intel/fw_sst_22a8.bin
Version: 01.0B.02.02

LICENCE TERMS (cont.)

License: Redistributable. See LICENCE.fw_sst_0f28 for details

Driver: snd-soc-skl

File: intel/dsp_fw_release_v969.bin

Version: 8.20.00.969

File: intel/dsp_fw_release_v3402.bin

Version: 9.21.00.3402_161

Link: intel/dsp_fw_release.bin -> intel/dsp_fw_release_v3402.bin

License: Redistributable. See LICENCE.adsp_sst for details

File: intel/dsp_fw_bxt_v2219.bin

Version: 9.22.01.2219_64

File: intel/dsp_fw_bxt_v3366.bin

Version: 9.22.01.3366_157

Link: intel/dsp_fw_bxt_v3366.bin -> intel/dsp_fw_bxt_v3366.bin

License: Redistributable. See LICENCE.adsp_sst for details

File: intel/dsp_fw_kbl_v701.bin

Version: 9.21.00.701

File: intel/dsp_fw_kbl_v1037.bin

Version: 09.21.00.1037

File: intel/dsp_fw_kbl_v2042.bin

Version: 9.21.00.2042_46

File: intel/dsp_fw_kbl_v2630.bin

Version: 9.21.00.2630_97

File: intel/dsp_fw_kbl_v3266.bin

Version: 9.21.00.3266_144

File: intel/dsp_fw_kbl_v3420.bin

Version: 9.21.00.3420_163

File: intel/dsp_fw_kbl_v3402.bin

Version: 9.21.00.3402_161

Link: intel/dsp_fw_kbl_v3402.bin -> dsp_fw_kbl_v3402.bin

License: Redistributable. See LICENCE.adsp_sst for details

File: intel/dsp_fw_glk_v1814.bin

Version: 9.92.01.1814

File: intel/dsp_fw_glk_v2880.bin

Version: 9.22.00.2880

File: intel/dsp_fw_glk_v2768.bin

Version: 9.22.01.2768

File: intel/dsp_fw_glk_v3366.bin

Version: 9.22.01.3366_157

Link: intel/dsp_fw_glk_v3366.bin -> dsp_fw_glk_v3366.bin

File: intel/dsp_fw_cnl_v1191.bin

Version: 10.00.00.1191

File: intel/dsp_fw_cnl_v1858.bin

Version: 10.23.00.1858

File: intel/dsp_fw_cnl_v1858.bin

Link: intel/dsp_fw_cnl_v1858.bin -> intel/dsp_fw_cnl_v1858.bin

License: Redistributable. See LICENCE.adsp_sst for details

Driver: smsmdtv - Siano MDTV Core module

File: cmmb_vega_12mhz.inp

File: cmmb_venice_12mhz.inp

File: dvb_nova_12mhz.inp

File: dvb_nova_12mhz_b0.inp

File: isdbt_nova_12mhz.inp

File: isdbt_nova_12mhz_b0.inp

File: isdbt_rio.inp

File: sms1xxx-hcw-55xxx-dvbt-02.fw

File: sms1xxx-hcw-55xxx-isdbt-02.fw

File: sms1xxx-nova-a-dvbt-01.fw

File: sms1xxx-nova-b-dvbt-01.fw

File: sms1xxx-stellar-dvbt-01.fw

File: tdmn_nova_12mhz.inp

License: Redistributable. See LICENCE.siano for details

Driver: xhci-tegra -- NVIDIA Tegra XHCI driver

File: nvidia/tegra124/xusb.bin

Version: v45.46

File: nvidia/tegra210/xusb.bin

Version: v50.10

License: Redistributable. See LICENCE.nvidia for details

Driver: tegra-vic -- NVIDIA Tegra VIC driver

File: nvidia/tegra124/vic03_ucose.bin

File: nvidia/tegra210/vic04_ucose.bin

File: nvidia/tegra186/vic04_ucose.bin

License: Redistributable. See LICENCE.nvidia for details

Driver: atusb - ATUSB IEEE 802.15.4 transceiver driver

File: atusb/atusb-0.2.dfu

Version: 0.2

File: atusb/atusb-0.3.dfu

Version: 0.3

File: atusb/rzusb-0.3.bin

Version: 0.3

Info: atusb/ChangeLog

LICENCE TERMS (cont.)

Licence: GPLv2 or later. See GPL-2 and GPL-3 for details.

Driver: qca - Qualcomm Atheros Bluetooth support for QCA61x4 chips

File: qca/nvm_usb_00000201.bin
File: qca/nvm_usb_00000200.bin
File: qca/nvm_usb_00000300.bin
File: qca/nvm_usb_00000302.bin
File: qca/nvm_00130300.bin
File: qca/nvm_00130302.bin
File: qca/rampatch_usb_00000200.bin
File: qca/rampatch_usb_00000201.bin
File: qca/rampatch_usb_00000300.bin
File: qca/rampatch_usb_00000302.bin
File: qca/rampatch_00130300.bin
File: qca/rampatch_00130302.bin
File: qca/crbtfw21.tlv
File: qca/crnv21.bin
File: qca/nvm_00440302.bin
File: qca/rampatch_00440302.bin

Licence: Redistributable. See LICENCE.QualcommAtheros_ath10k and qca/NOTICE.txt for details

Driver: liquidio -- Cavium LiquidIO driver

File: liquidio/lio_23xx_nic.bin
Version: v1.7.2

File: liquidio/lio_23xx_vsw.bin
Version: v1.7.2

File: liquidio/lio_210nv_nic.bin
Version: v1.7.2

File: liquidio/lio_210sv_nic.bin
Version: v1.7.2

File: liquidio/lio_410nv_nic.bin
Version: v1.7.2

Licence: Redistributable. See LICENCE.cavium_liquidio for details

Driver: nitrox -- Cavium CNN55XX crypto driver

File: cavium/cnn55xx_ae.fw
Version: v01

File: cavium/cnn55xx_se.fw
Version: v10

Licence: Redistributable. See LICENCE.cavium for details

Driver: i915 -- Intel Integrated Graphics driver

File: i915/skl_dmc_ver1_23.bin
File: i915/skl_dmc_ver1_26.bin
File: i915/skl_dmc_ver1_27.bin
File: i915/skl_dmc_ver1.bin
Version: DMC API/ABI ver 1 - release 27 for Skylake

File: i915/bxt_dmc_ver1_07.bin
File: i915/bxt_dmc_ver1.bin
Version: DMC API/ABI ver 1 - release 07 for Broxton

File: i915/kbl_dmc_ver1_01.bin
File: i915/kbl_dmc_ver1.bin
Version: DMC API/ABI ver 1 - release 01 for Kabylake

File: i915/kbl_dmc_ver1_04.bin
File: i915/kbl_dmc_ver1_04.bin
Version: DMC API/ABI ver 1 - release 04 for Kabylake

File: i915/skl_guc_ver1.bin
Version: Guc API/ABI ver 1 - release 1059 for Skylake

File: i915/skl_guc_ver4.bin
Version: Guc API/ABI ver 4 - release 3 for Skylake

File: i915/skl_guc_ver6_1.bin
File: i915/skl_guc_ver6.bin
Version: Guc API/ABI ver 6 - release 1 for Skylake

File: i915/skl_guc_ver9_33.bin
Version: Guc API/ABI ver 9 - release 33 for Skylake

File: i915/skl_guc_32.0.3.bin
Version: Guc API/ABI ver 32 - release 0 for Skylake

File: i915/skl_guc_33.0.0.bin
Version: Guc API/ABI ver 33 - release 0 for Skylake

File: i915/skl_huc_ver01_07_1398.bin
Version: HuC API/ABI ver 1 - release 7 for Skylake

File: i915/bxt_huc_ver01_07_1398.bin
Version: HuC API/APB ver 1 - release 7 for Broxton

File: i915/bxt_huc_ver01_8_2893.bin
Version: HuC API/APB ver 1 - release 8 for Broxton

File: i915/kbl_huc_ver02_00_1810.bin
Version: HuC API/APB ver 2 - for Kabylake

File: i915/bxt_guc_ver8_7.bin
Version: Guc API/APB ver 8 - release 7 for Broxton

LICENCE TERMS (cont.)

File: i915/bxt_guc_ver9_29.bin
Version: Guc API/APB ver 9 - release 29 for Broxton

File: i915/bxt_guc_32.0.3.bin
Version: Guc API/APB ver 32 - release 0 for Broxton

File: i915/bxt_guc_33.0.0.bin
Version: Guc API/APB ver 33 - release 0 for Broxton

File: i915/kbl_guc_ver9_14.bin
Version: Guc API/APB ver 9 release 14 for Kabylake

File: i915/kbl_guc_ver9_39.bin
Version: Guc API/APB ver 9 release 39 for Kabylake

File: i915/kbl_guc_32.0.3.bin
Version: Guc API/APB ver 32 release 0 for Kabylake

File: i915/kbl_guc_33.0.0.bin
Version: Guc API/APB ver 33 release 0 for Kabylake

File: i915/glk_guc_32.0.3.bin
Version: Guc API/APB ver 32 release 0 for Geminilake

File: i915/glk_guc_33.0.0.bin
Version: Guc API/APB ver 33 release 0 for Geminilake

File: i915/glk_huc_ver03_01_2893.bin
Version: Huc API/APB ver 3 release 1 for Geminilake

File: i915/glk_dmc_ver1_04.bin
Version: DMC API/ABI ver 1 - release 04 for Geminilake

File: i915/cnl_dmc_ver1_06.bin
Version: DMC API/ABI ver 1 - release 06 for Cannonlake

File: i915/cnl_dmc_ver1_07.bin
Version: DMC API/ABI ver 1 - release 07 for Cannonlake

File: i915/icl_dmc_ver1_07.bin
Version: DMC API/ABI ver 1 - release 07 for icelake

File: i915/icl_guc_32.0.3.bin
Version: Guc API/APB ver 32 release 0 for Icelake

File: i915/icl_guc_33.0.0.bin
Version: Guc API/APB ver 33 release 0 for Icelake

File: i915/icl_huc_ver8_4_3238.bin
Version: Huc API/APB ver 8 release 4 for Icelake
License: Redistributable. See LICENSE.i915 for details

Driver: nouveau - NVIDIA GPU driver

File: nvidia/gk20a/fecs_data.bin

File: nvidia/gk20a/fecs_inst.bin
File: nvidia/gk20a/gpccs_data.bin
File: nvidia/gk20a/gpccs_inst.bin
File: nvidia/gk20a/sw_bundle_init.bin
File: nvidia/gk20a/sw_ctx.bin
File: nvidia/gk20a/sw_method_init.bin
File: nvidia/gk20a/sw_nonctx.bin
File: nvidia/gm200/acr/bl.bin
File: nvidia/gm200/acr/ucode_load.bin
File: nvidia/gm200/acr/ucode_unload.bin
File: nvidia/gm200/gr/fecs_bl.bin
File: nvidia/gm200/gr/fecs_data.bin
File: nvidia/gm200/gr/fecs_inst.bin
File: nvidia/gm200/gr/fecs_sig.bin
File: nvidia/gm200/gr/gpccs_bl.bin
File: nvidia/gm200/gr/gpccs_data.bin
File: nvidia/gm200/gr/gpccs_inst.bin
File: nvidia/gm200/gr/gpccs_sig.bin
File: nvidia/gm200/gr/sw_bundle_init.bin
File: nvidia/gm200/gr/sw_ctx.bin
File: nvidia/gm200/gr/sw_method_init.bin
File: nvidia/gm200/gr/sw_nonctx.bin
File: nvidia/gm204/acr/bl.bin
File: nvidia/gm204/acr/ucode_load.bin
File: nvidia/gm204/acr/ucode_unload.bin
File: nvidia/gm204/gr/fecs_bl.bin
File: nvidia/gm204/gr/fecs_data.bin
File: nvidia/gm204/gr/fecs_inst.bin
File: nvidia/gm204/gr/fecs_sig.bin
File: nvidia/gm204/gr/gpccs_bl.bin
File: nvidia/gm204/gr/gpccs_data.bin
File: nvidia/gm204/gr/gpccs_inst.bin
File: nvidia/gm204/gr/gpccs_sig.bin
File: nvidia/gm204/gr/sw_bundle_init.bin
File: nvidia/gm204/gr/sw_ctx.bin
File: nvidia/gm204/gr/sw_method_init.bin
File: nvidia/gm204/gr/sw_nonctx.bin
File: nvidia/gm206/acr/bl.bin
File: nvidia/gm206/acr/ucode_load.bin
File: nvidia/gm206/acr/ucode_unload.bin
File: nvidia/gm206/gr/fecs_bl.bin
File: nvidia/gm206/gr/fecs_data.bin
File: nvidia/gm206/gr/fecs_inst.bin
File: nvidia/gm206/gr/fecs_sig.bin
File: nvidia/gm206/gr/gpccs_bl.bin
File: nvidia/gm206/gr/gpccs_data.bin
File: nvidia/gm206/gr/gpccs_inst.bin
File: nvidia/gm206/gr/gpccs_sig.bin
File: nvidia/gm206/gr/sw_bundle_init.bin
File: nvidia/gm206/gr/sw_ctx.bin
File: nvidia/gm206/gr/sw_method_init.bin
File: nvidia/gm206/gr/sw_nonctx.bin
File: nvidia/gm20b/acr/bl.bin
File: nvidia/gm20b/acr/ucode_load.bin
File: nvidia/gm20b/gr/fecs_bl.bin
File: nvidia/gm20b/gr/fecs_data.bin
File: nvidia/gm20b/gr/fecs_inst.bin

File: nvidia/gm20b/gr/fecs_sig.bin
 File: nvidia/gm20b/gr/gpccs_data.bin
 File: nvidia/gm20b/gr/gpccs_inst.bin
 File: nvidia/gm20b/gr/sw_bundle_init.bin
 File: nvidia/gm20b/gr/sw_ctx.bin
 File: nvidia/gm20b/gr/sw_method_init.bin
 File: nvidia/gm20b/gr/sw_nonctx.bin
 File: nvidia/gm20b/pmu/desc.bin
 File: nvidia/gm20b/pmu/image.bin
 File: nvidia/gm20b/pmu/sig.bin
 File: nvidia/gp100/acr/bl.bin
 File: nvidia/gp100/acr/ucode_load.bin
 File: nvidia/gp100/acr/ucode_unload.bin
 File: nvidia/gp100/gr/fecs_bl.bin
 File: nvidia/gp100/gr/fecs_data.bin
 File: nvidia/gp100/gr/fecs_inst.bin
 File: nvidia/gp100/gr/fecs_sig.bin
 File: nvidia/gp100/gr/gpccs_bl.bin
 File: nvidia/gp100/gr/gpccs_data.bin
 File: nvidia/gp100/gr/gpccs_inst.bin
 File: nvidia/gp100/gr/gpccs_sig.bin
 File: nvidia/gp100/gr/sw_bundle_init.bin
 File: nvidia/gp100/gr/sw_ctx.bin
 File: nvidia/gp100/gr/sw_method_init.bin
 File: nvidia/gp100/gr/sw_nonctx.bin
 File: nvidia/gp102/acr/bl.bin
 File: nvidia/gp102/acr/ucode_load.bin
 File: nvidia/gp102/acr/ucode_unload.bin
 File: nvidia/gp102/acr/unload_bl.bin
 File: nvidia/gp102/gr/fecs_bl.bin
 File: nvidia/gp102/gr/fecs_data.bin
 File: nvidia/gp102/gr/fecs_inst.bin
 File: nvidia/gp102/gr/fecs_sig.bin
 File: nvidia/gp102/gr/gpccs_bl.bin
 File: nvidia/gp102/gr/gpccs_data.bin
 File: nvidia/gp102/gr/gpccs_inst.bin
 File: nvidia/gp102/gr/gpccs_sig.bin
 File: nvidia/gp102/gr/sw_bundle_init.bin
 File: nvidia/gp102/gr/sw_ctx.bin
 File: nvidia/gp102/gr/sw_method_init.bin
 File: nvidia/gp102/gr/sw_nonctx.bin
 File: nvidia/gp102/nvdec/scrubber.bin
 File: nvidia/gp102/sec2/desc.bin
 File: nvidia/gp102/sec2/image.bin
 File: nvidia/gp102/sec2/sig.bin
 File: nvidia/gp102/sec2/desc-1.bin
 File: nvidia/gp102/sec2/image-1.bin
 File: nvidia/gp102/sec2/sig-1.bin
 File: nvidia/gp104/acr/bl.bin
 File: nvidia/gp104/acr/ucode_load.bin
 File: nvidia/gp104/acr/ucode_unload.bin
 File: nvidia/gp104/acr/unload_bl.bin
 File: nvidia/gp104/gr/fecs_bl.bin
 File: nvidia/gp104/gr/fecs_data.bin
 File: nvidia/gp104/gr/fecs_inst.bin
 File: nvidia/gp104/gr/fecs_sig.bin
 File: nvidia/gp104/gr/gpccs_bl.bin

File: nvidia/gp104/gr/gpccs_data.bin
 File: nvidia/gp104/gr/gpccs_inst.bin
 File: nvidia/gp104/gr/gpccs_sig.bin
 File: nvidia/gp104/gr/sw_bundle_init.bin
 File: nvidia/gp104/gr/sw_ctx.bin
 File: nvidia/gp104/gr/sw_method_init.bin
 File: nvidia/gp104/gr/sw_nonctx.bin
 File: nvidia/gp104/nvdec/scrubber.bin
 File: nvidia/gp104/sec2/desc.bin
 File: nvidia/gp104/sec2/image.bin
 File: nvidia/gp104/sec2/sig.bin
 File: nvidia/gp104/sec2/desc-1.bin
 File: nvidia/gp104/sec2/image-1.bin
 File: nvidia/gp104/sec2/sig-1.bin
 File: nvidia/gp106/acr/bl.bin
 File: nvidia/gp106/acr/ucode_load.bin
 File: nvidia/gp106/acr/ucode_unload.bin
 File: nvidia/gp106/acr/unload_bl.bin
 File: nvidia/gp106/gr/fecs_bl.bin
 File: nvidia/gp106/gr/fecs_data.bin
 File: nvidia/gp106/gr/fecs_inst.bin
 File: nvidia/gp106/gr/fecs_sig.bin
 File: nvidia/gp106/gr/gpccs_bl.bin
 File: nvidia/gp106/gr/gpccs_data.bin
 File: nvidia/gp106/gr/gpccs_inst.bin
 File: nvidia/gp106/gr/gpccs_sig.bin
 File: nvidia/gp106/gr/sw_bundle_init.bin
 File: nvidia/gp106/gr/sw_ctx.bin
 File: nvidia/gp106/gr/sw_method_init.bin
 File: nvidia/gp106/gr/sw_nonctx.bin
 File: nvidia/gp106/nvdec/scrubber.bin
 File: nvidia/gp106/sec2/desc.bin
 File: nvidia/gp106/sec2/image.bin
 File: nvidia/gp106/sec2/sig.bin
 File: nvidia/gp106/sec2/desc-1.bin
 File: nvidia/gp106/sec2/image-1.bin
 File: nvidia/gp106/sec2/sig-1.bin
 File: nvidia/gp107/acr/bl.bin
 File: nvidia/gp107/acr/ucode_load.bin
 File: nvidia/gp107/acr/ucode_unload.bin
 File: nvidia/gp107/acr/unload_bl.bin
 File: nvidia/gp107/gr/fecs_bl.bin
 File: nvidia/gp107/gr/fecs_data.bin
 File: nvidia/gp107/gr/fecs_inst.bin
 File: nvidia/gp107/gr/fecs_sig.bin
 File: nvidia/gp107/gr/gpccs_bl.bin
 File: nvidia/gp107/gr/gpccs_data.bin
 File: nvidia/gp107/gr/gpccs_inst.bin
 File: nvidia/gp107/gr/gpccs_sig.bin
 File: nvidia/gp107/gr/sw_bundle_init.bin
 File: nvidia/gp107/gr/sw_ctx.bin
 File: nvidia/gp107/gr/sw_method_init.bin
 File: nvidia/gp107/gr/sw_nonctx.bin
 File: nvidia/gp107/nvdec/scrubber.bin
 File: nvidia/gp107/sec2/desc.bin
 File: nvidia/gp107/sec2/image.bin
 File: nvidia/gp107/sec2/sig.bin

LICENCE TERMS (cont.)

File: nvidia/gp107/sec2/desc-1.bin
File: nvidia/gp107/sec2/image-1.bin
File: nvidia/gp107/sec2/sig-1.bin
File: nvidia/gp10b/acr/bl.bin
File: nvidia/gp10b/acr/ucode_load.bin
File: nvidia/gp10b/gr/fecs_bl.bin
File: nvidia/gp10b/gr/fecs_data.bin
File: nvidia/gp10b/gr/fecs_inst.bin
File: nvidia/gp10b/gr/fecs_sig.bin
File: nvidia/gp10b/gr/gpccs_bl.bin
File: nvidia/gp10b/gr/gpccs_data.bin
File: nvidia/gp10b/gr/gpccs_inst.bin
File: nvidia/gp10b/gr/gpccs_sig.bin
File: nvidia/gp10b/gr/sw_bundle_init.bin
File: nvidia/gp10b/gr/sw_ctx.bin
File: nvidia/gp10b/gr/sw_method_init.bin
File: nvidia/gp10b/gr/sw_nonctx.bin
File: nvidia/gp10b/pmu/desc.bin
File: nvidia/gp10b/pmu/image.bin
File: nvidia/gp10b/pmu/sig.bin
File: nvidia/gp108/acr/bl.bin
File: nvidia/gp108/acr/ucode_load.bin
File: nvidia/gp108/acr/ucode_unload.bin
File: nvidia/gp108/acr/unload_bl.bin
File: nvidia/gp108/gr/fecs_bl.bin
File: nvidia/gp108/gr/fecs_data.bin
File: nvidia/gp108/gr/fecs_inst.bin
File: nvidia/gp108/gr/fecs_sig.bin
File: nvidia/gp108/gr/gpccs_bl.bin
File: nvidia/gp108/gr/gpccs_data.bin
File: nvidia/gp108/gr/gpccs_inst.bin
File: nvidia/gp108/gr/gpccs_sig.bin
File: nvidia/gp108/gr/sw_bundle_init.bin
File: nvidia/gp108/gr/sw_ctx.bin
File: nvidia/gp108/gr/sw_method_init.bin
File: nvidia/gp108/gr/sw_nonctx.bin
File: nvidia/gp108/nvdec/scrubber.bin
File: nvidia/gp108/sec2/desc.bin
File: nvidia/gp108/sec2/image.bin
File: nvidia/gp108/sec2/sig.bin
File: nvidia/gv100/acr/bl.bin
File: nvidia/gv100/acr/ucode_load.bin
File: nvidia/gv100/acr/ucode_unload.bin
File: nvidia/gv100/acr/unload_bl.bin
File: nvidia/gv100/gr/fecs_bl.bin
File: nvidia/gv100/gr/fecs_data.bin
File: nvidia/gv100/gr/fecs_inst.bin
File: nvidia/gv100/gr/fecs_sig.bin
File: nvidia/gv100/gr/gpccs_bl.bin
File: nvidia/gv100/gr/gpccs_data.bin
File: nvidia/gv100/gr/gpccs_inst.bin
File: nvidia/gv100/gr/gpccs_sig.bin
File: nvidia/gv100/gr/sw_bundle_init.bin
File: nvidia/gv100/gr/sw_ctx.bin
File: nvidia/gv100/gr/sw_method_init.bin
File: nvidia/gv100/gr/sw_nonctx.bin
File: nvidia/gv100/nvdec/scrubber.bin

File: nvidia/gv100/sec2/desc.bin
File: nvidia/gv100/sec2/image.bin
File: nvidia/gv100/sec2/sig.bin

File: nvidia/tu10x/typec/ccg_primary.cyacd
File: nvidia/tu10x/typec/ccg_secondary.cyacd
File: nvidia/tu10x/typec/ccg_boot.cyacd

Licence: Redistributable. See LICENCE.nvidia for details

Driver: wilc1000 - Atmel 802.11n WLAN driver for WILC1000

File: atmel/wilc1000_fw.bin
File: atmel/wilc1000_ap_fw.bin
File: atmel/wilc1000_p2p_fw.bin
File: atmel/wilc1000_wifi_firmware.bin

Licence: Redistributable. See LICENSE.atmel for details

Driver: hfi1 - Intel OPA Gen 1 adapter

File: hfi1_dc8051.fw
Version: 1.27.0
File: hfi1_fabric.fw
Version: 0x1055
File: hfi1_pcie.fw
Version: 0x4755
File: hfi1_sbus.fw
Version: 0x10130001

Licence: Redistributable. See LICENSE.hfi1_firmware for details

Driver: knav_qmss_queue - TI Keystone 2 QMSS driver

File: ti-keystone/ks2_qmss_pdsp_acc48_k2_le_1_0_0_9.bin

Licence: Redistributable. See LICENCE.ti-keystone for details.

Driver: mwlfwifi - Marvell mac80211 driver for 80211ac cards.

File: mwlfwifi/88W8864.bin
Version: 7.2.8.6

File: mwlfwifi/88W8897.bin
Version: 8.2.0.10

Licence: Redistributable. See LICENCE.Marvell for details.

LICENCE TERMS (cont.)

Driver: mtk-vpu - Mediatek VPU video processing unit driver

File: vpu_d.bin
File: vpu_p.bin

Licence: Redistributable.

MediaTek Inc. grants permission to use and redistribute aforementioned firmware files for the use with devices containing MediaTek chipsets, but not as part of the Linux kernel or in any other form which would require these files themselves to be covered by the terms of the GNU General Public License or the GNU Lesser General Public License.

These firmware files are distributed in the hope that they will be useful, but are provided WITHOUT ANY WARRANTY, INCLUDING BUT NOT LIMITED TO IMPLIED WARRANTY OF MERCHANTABILITY OR FITNESS FOR A PARTICULAR PURPOSE.

Driver: btmtdk - MediaTek Bluetooth Driver

File: mediatek/mt7622pr2h.bin
Version: 20180621204904
File: mediatek/mt7668pr2h.bin
Version: 20180517181834

Licence: Redistributable. See LICENCE.mediatek for details.

Driver: rk3399-dptx - ROCKCHIP rk3399 dptx firmware

File: rockchip/dptx.bin
Version: 3.1

Licence: Redistributable. See LICENCE.rockchip for details.

Driver: mt76x0 - MediaTek MT76x0 Wireless MACs

File: mediatek/mt7610u.bin
File: mediatek/mt7610e.bin
Version: 2.6
File: mediatek/mt7650e.bin
Version: 1.0.07-b370

Licence: Redistributable. See LICENCE.mediatek for details.

Driver: mt76x2e - MediaTek MT76x2 Wireless MACs

File: mt7662.bin
Version: 1.9

File: mt7662_rom_patch.bin

Version: 0.0.2_P69

Licence: Redistributable. See LICENCE.ralink_a_mediatek_company_firmware for details

Driver: mt76x2u - MediaTek MT76x2u Wireless MACs

File: mediatek/mt7662u.bin
Version: 1.5

File: mediatek/mt7662u_rom_patch.bin
Version: 0.0.2_P48

Licence: Redistributable. See LICENCE.mediatek for details.

Driver: mt7615e - MediaTek MT7615e Wireless MACs

File: mediatek/mt7615_n9.bin
Version: 20190114
File: mediatek/mt7615_cr4.bin
Version: 20190114
File: mediatek/mt7615_rom_patch.bin
Version: 20190114

Licence: Redistributable. See LICENCE.mediatek for details.

Driver: nfp - Netronome Flow Processor

Link: netronome/nic_AMDA0081-0001_1x40.nffw -> nic/nic_AMDA0081-0001_1x40.nffw
Link: netronome/nic_AMDA0097-0001_2x40.nffw -> nic/nic_AMDA0097-0001_2x40.nffw
Link: netronome/nic_AMDA0099-0001_2x10.nffw -> nic/nic_AMDA0099-0001_2x10.nffw
Link: netronome/nic_AMDA0081-0001_4x10.nffw -> nic/nic_AMDA0081-0001_4x10.nffw
Link: netronome/nic_AMDA0097-0001_4x10_1x40.nffw -> nic/nic_AMDA0097-0001_4x10_1x40.nffw
Link: netronome/nic_AMDA0099-0001_1x10_1x25.nffw -> nic/nic_AMDA0099-0001_1x10_1x25.nffw
Link: netronome/nic_AMDA0099-0001_2x25.nffw -> nic/nic_AMDA0099-0001_2x25.nffw
Link: netronome/nic_AMDA0096-0001_2x10.nffw -> nic/nic_AMDA0096-0001_2x10.nffw
Link: netronome/nic_AMDA0097-0001_8x10.nffw -> nic/nic_AMDA0097-0001_8x10.nffw
Link: netronome/nic_AMDA0058-0011_2x40.nffw -> nic/nic_AMDA0058-0011_2x40.nffw
Link: netronome/nic_AMDA0058-0012_2x40.nffw -> nic/nic_AMDA0058-0012_2x40.nffw
Link: netronome/nic_AMDA0078-0011_1x100.nffw -> nic/nic_AMDA0078-0011_1x100.nffw
File: netronome/nic/nic_AMDA0081-0001_1x40.nffw
File: netronome/nic/nic_AMDA0097-0001_2x40.nffw
File: netronome/nic/nic_AMDA0099-0001_2x10.nffw
File: netronome/nic/nic_AMDA0081-0001_4x10.nffw
File: netronome/nic/nic_AMDA0097-0001_4x10_1x40.nffw
File: netronome/nic/nic_AMDA0099-0001_1x10_1x25.nffw
File: netronome/nic/nic_AMDA0099-0001_2x25.nffw
File: netronome/nic/nic_AMDA0096-0001_2x10.nffw
File: netronome/nic/nic_AMDA0097-0001_8x10.nffw
File: netronome/nic/nic_AMDA0058-0011_2x40.nffw
File: netronome/nic/nic_AMDA0058-0012_2x40.nffw
File: netronome/nic/nic_AMDA0078-0011_1x100.nffw

LICENCE TERMS (cont.)

File: netronome/nic-sriov/nic_AMDA0081-0001_1x40.nffw
File: netronome/nic-sriov/nic_AMDA0097-0001_2x40.nffw
File: netronome/nic-sriov/nic_AMDA0099-0001_2x10.nffw
File: netronome/nic-sriov/nic_AMDA0081-0001_4x10.nffw
File: netronome/nic-sriov/nic_AMDA0097-0001_4x10_1x40.nffw
File: netronome/nic-sriov/nic_AMDA0099-0001_1x10_1x25.nffw
File: netronome/nic-sriov/nic_AMDA0099-0001_2x25.nffw
File: netronome/nic-sriov/nic_AMDA0096-0001_2x10.nffw
File: netronome/nic-sriov/nic_AMDA0097-0001_8x10.nffw
File: netronome/nic-sriov/nic_AMDA0058-0011_2x40.nffw
File: netronome/nic-sriov/nic_AMDA0058-0012_2x40.nffw
File: netronome/nic-sriov/nic_AMDA0078-0011_1x100.nffw

Version: v2.1.16.1

File: netronome/flower/nic_AMDA0099.nffw
File: netronome/flower/nic_AMDA0096.nffw
File: netronome/flower/nic_AMDA0097.nffw
File: netronome/flower/nic_AMDA0058.nffw
Link: netronome/flower/nic_AMDA0081.nffw -> netronome/flower/nic_AMDA0097.nffw
Link: netronome/flower/nic_AMDA0081-0001_1x40.nffw -> netronome/flower/nic_AMDA0081.nffw
Link: netronome/flower/nic_AMDA0097-0001_2x40.nffw -> netronome/flower/nic_AMDA0097.nffw
Link: netronome/flower/nic_AMDA0099-0001_2x10.nffw -> netronome/flower/nic_AMDA0099.nffw
Link: netronome/flower/nic_AMDA0081-0001_4x10.nffw -> netronome/flower/nic_AMDA0081.nffw
Link: netronome/flower/nic_AMDA0097-0001_4x10_1x40.nffw -> netronome/flower/nic_AMDA0097.nffw
Link: netronome/flower/nic_AMDA0099-0001_2x25.nffw -> netronome/flower/nic_AMDA0099.nffw
Link: netronome/flower/nic_AMDA0096-0001_2x10.nffw -> netronome/flower/nic_AMDA0096.nffw
Link: netronome/flower/nic_AMDA0097-0001_8x10.nffw -> netronome/flower/nic_AMDA0097.nffw
Link: netronome/flower/nic_AMDA0099-0001_1x10_1x25.nffw -> netronome/flower/nic_AMDA0099.nffw
Link: netronome/flower/nic_AMDA0058-0011_1x100.nffw -> netronome/flower/nic_AMDA0058.nffw
Link: netronome/flower/nic_AMDA0058-0011_2x40.nffw -> netronome/flower/nic_AMDA0058.nffw
Link: netronome/flower/nic_AMDA0058-0011_4x10_1x40.nffw -> netronome/flower/nic_AMDA0058.nffw
Link: netronome/flower/nic_AMDA0058-0011_8x10.nffw -> netronome/flower/nic_AMDA0058.nffw
Link: netronome/flower/nic_AMDA0058-0012_1x100.nffw -> netronome/flower/nic_AMDA0058.nffw
Link: netronome/flower/nic_AMDA0058-0012_2x40.nffw -> netronome/flower/nic_AMDA0058.nffw
Link: netronome/flower/nic_AMDA0058-0012_4x10_1x40.nffw -> netronome/flower/nic_AMDA0058.nffw
Link: netronome/flower/nic_AMDA0058-0012_8x10.nffw -> netronome/flower/nic_AMDA0058.nffw
Link: netronome/flower/nic_AMDA0078-0011_1x100.nffw -> netronome/flower/nic_AMDA0058.nffw
Link: netronome/flower/nic_AMDA0078-0011_2x40.nffw -> netronome/flower/nic_AMDA0058.nffw
Link: netronome/flower/nic_AMDA0078-0011_4x10_1x40.nffw -> netronome/flower/nic_AMDA0058.nffw
Link: netronome/flower/nic_AMDA0078-0011_8x10.nffw -> netronome/flower/nic_AMDA0058.nffw
Link: netronome/flower/nic_AMDA0078-0012_1x100.nffw -> netronome/flower/nic_AMDA0058.nffw
Link: netronome/flower/nic_AMDA0078-0012_2x40.nffw -> netronome/flower/nic_AMDA0058.nffw
Link: netronome/flower/nic_AMDA0078-0012_4x10_1x40.nffw -> netronome/flower/nic_AMDA0058.nffw
Link: netronome/flower/nic_AMDA0078-0012_8x10.nffw -> netronome/flower/nic_AMDA0058.nffw

Version: AOTC-2.10.A.38

File: netronome/bpf/nic_AMDA0081-0001_1x40.nffw
File: netronome/bpf/nic_AMDA0097-0001_2x40.nffw
File: netronome/bpf/nic_AMDA0099-0001_2x10.nffw
File: netronome/bpf/nic_AMDA0081-0001_4x10.nffw
File: netronome/bpf/nic_AMDA0097-0001_4x10_1x40.nffw
File: netronome/bpf/nic_AMDA0099-0001_1x10_1x25.nffw
File: netronome/bpf/nic_AMDA0099-0001_2x25.nffw

File: netronome/bpf/nic_AMDA0096-0001_2x10.nffw
File: netronome/bpf/nic_AMDA0097-0001_8x10.nffw
File: netronome/bpf/nic_AMDA0058-0011_2x40.nffw
File: netronome/bpf/nic_AMDA0058-0012_2x40.nffw
File: netronome/bpf/nic_AMDA0078-0011_1x100.nffw

Version: v2.0.6.124

Licence: Redistributable. See LICENCE.Netronome for details

Driver: wil6210 - Qualcomm Atheros support for 11ad family of chips

File: wil6210.fw
File: wil6210.brd
Version: 5.2.0.18

Licence: Redistributable. See LICENSE.QualcommAtheros_ath10k for details

Driver: venus - Qualcomm Venus video codec accelerator

File: qcom/venus-1.8/venus.mdt
File: qcom/venus-1.8/venus.b00
File: qcom/venus-1.8/venus.b01
File: qcom/venus-1.8/venus.b02
File: qcom/venus-1.8/venus.b03
File: qcom/venus-1.8/venus.b04

Version: 1.8-00109

File: qcom/venus-4.2/venus.mdt
File: qcom/venus-4.2/venus.b00
File: qcom/venus-4.2/venus.b01
File: qcom/venus-4.2/venus.b02
File: qcom/venus-4.2/venus.b03
File: qcom/venus-4.2/venus.b04

Version: 4.2

File: qcom/venus-5.2/venus.mdt
File: qcom/venus-5.2/venus.b00
File: qcom/venus-5.2/venus.b01
File: qcom/venus-5.2/venus.b02
File: qcom/venus-5.2/venus.b03
File: qcom/venus-5.2/venus.b04
File: qcom/venus-5.2/venus.mbn

Version: 5.2-00023

Licence: Redistributable. See LICENSE.qcom and qcom/NOTICE.txt for details

Binary files supplied originally from

<https://developer.qualcomm.com/hardware/dragonboard-410c/tools>

Driver: imx-sdma - support for i.MX SDMA driver

File: imx/sdma/sdma-imx6q.bin

Version: 3.3

File: imx/sdma/sdma-imx7d.bin

Version: 4.2

Licence: Redistributable. See LICENSE.sdma_firmware for details

Driver: adreno - Qualcomm Adreno GPU firmware

File: qcom/a300_pfp.fw

Link: a300_pfp.fw -> qcom/a300_pfp.fw

File: qcom/a300_pm4.fw

Link: a300_pm4.fw -> qcom/a300_pm4.fw

File: qcom/a530_pfp.fw

File: qcom/a530_pm4.fw

File: qcom/a530v3_gpmu.fw2

File: qcom/a530_zap.b00

File: qcom/a530_zap.b01

File: qcom/a530_zap.b02

File: qcom/a530_zap.mdt

Licence: Redistributable. See LICENSE.qcom and qcom/NOTICE.txt for details

Binary files supplied originally from

<https://developer.qualcomm.com/hardware/dragonboard-410c/tools>

Driver: mlxsw_spectrum - Mellanox Spectrum switch

File: mellanox/mlxsw_spectrum-13.1420.122.mfa2

File: mellanox/mlxsw_spectrum-13.1530.152.mfa2

File: mellanox/mlxsw_spectrum-13.1620.192.mfa2

File: mellanox/mlxsw_spectrum-13.1702.6.mfa2

File: mellanox/mlxsw_spectrum-13.1703.4.mfa2

File: mellanox/mlxsw_spectrum-13.1910.622.mfa2

File: mellanox/mlxsw_spectrum-13.2000.1122.mfa2

Licence:

Copyright (c) 2017-2019 Mellanox Technologies, Ltd. All rights reserved.

Redistribution and use in source and binary forms, with or without modification, are permitted provided that the following conditions are met:

1. Redistributions of source code must retain the above copyright notice, this list of conditions and the following disclaimer.
2. Redistributions in binary form must reproduce the above copyright notice, this list of conditions and the following disclaimer in the documentation and/or other materials provided with the distribution.

3. Neither the names of the copyright holders nor the names of its contributors may be used to endorse or promote products derived from this software without specific prior written permission.

Alternatively, this software may be distributed under the terms of the GNU General Public License ("GPL") version 2 as published by the Free Software Foundation.

THIS SOFTWARE IS PROVIDED BY THE COPYRIGHT HOLDERS AND CONTRIBUTORS "AS IS" AND ANY EXPRESS OR IMPLIED WARRANTIES, INCLUDING, BUT NOT LIMITED TO, THE IMPLIED WARRANTIES OF MERCHANTABILITY AND FITNESS FOR A PARTICULAR PURPOSE ARE DISCLAIMED. IN NO EVENT SHALL THE COPYRIGHT OWNER OR CONTRIBUTORS BE LIABLE FOR ANY DIRECT, INDIRECT, INCIDENTAL, SPECIAL, EXEMPLARY, OR CONSEQUENTIAL DAMAGES (INCLUDING, BUT NOT LIMITED TO, PROCUREMENT OF SUBSTITUTE GOODS OR SERVICES; LOSS OF USE, DATA, OR PROFITS; OR BUSINESS INTERRUPTION) HOWEVER CAUSED AND ON ANY THEORY OF LIABILITY, WHETHER IN CONTRACT, STRICT LIABILITY, OR TORT (INCLUDING NEGLIGENCE OR OTHERWISE) ARISING IN ANY WAY OUT OF THE USE OF THIS SOFTWARE, EVEN IF ADVISED OF THE POSSIBILITY OF SUCH DAMAGE.

"iperf, Copyright (c) 2014-2019, The Regents of the University of California, through Lawrence Berkeley National Laboratory (subject to receipt of any required approvals from the U.S. Dept. of Energy). All rights reserved."

Redistribution and use in source and binary forms, with or without modification, are permitted provided that the following conditions are met:

(1) Redistributions of source code must retain the above copyright notice, this list of conditions and the following disclaimer.

(2) Redistributions in binary form must reproduce the above copyright notice, this list of conditions and the following disclaimer in the documentation and/or other materials provided with the distribution.

(3) Neither the name of the University of California, Lawrence Berkeley National Laboratory, U.S. Dept. of Energy nor the names of its contributors may be used to endorse or promote products derived from this software without specific prior written permission.

THIS SOFTWARE IS PROVIDED BY THE COPYRIGHT HOLDERS AND CONTRIBUTORS "AS IS" AND ANY EXPRESS OR IMPLIED WARRANTIES, INCLUDING, BUT NOT LIMITED TO, THE IMPLIED WARRANTIES OF MERCHANTABILITY AND FITNESS FOR A PARTICULAR PURPOSE ARE DISCLAIMED. IN NO EVENT SHALL THE COPYRIGHT OWNER OR CONTRIBUTORS BE LIABLE FOR ANY DIRECT, INDIRECT, INCIDENTAL, SPECIAL, EXEMPLARY, OR CONSEQUENTIAL DAMAGES (INCLUDING, BUT NOT LIMITED TO, PROCUREMENT OF SUBSTITUTE GOODS OR SERVICES; LOSS OF USE, DATA, OR PROFITS; OR BUSINESS INTERRUPTION) HOWEVER CAUSED AND ON ANY THEORY OF LIABILITY, WHETHER IN CONTRACT, STRICT LIABILITY, OR TORT (INCLUDING NEGLIGENCE OR OTHERWISE) ARISING IN ANY WAY OUT OF THE USE OF THIS SOFTWARE, EVEN IF ADVISED OF THE POSSIBILITY OF SUCH DAMAGE.

You are under no obligation whatsoever to provide any bug fixes, patches, or upgrades to the features, functionality or performance of the source code ("Enhancements") to anyone; however, if you choose to make your Enhancements available either publicly, or directly to Lawrence Berkeley National Laboratory, without imposing a separate written license agreement for such

LICENCE TERMS (cont.)

Enhancements, then you hereby grant the following license: a non-exclusive, royalty-free perpetual license to install, use, modify, prepare derivative works, incorporate into other computer software, distribute, and sublicense such enhancements or derivative works thereof, in binary and source code form.

Copyright (c) 2001 Eric Jackson <ericj@monkey.org>

Redistribution and use in source and binary forms, with or without modification, are permitted provided that the following conditions are met:

1. Redistributions of source code must retain the above copyright notice, this list of conditions and the following disclaimer.
2. Redistributions in binary form must reproduce the above copyright notice, this list of conditions and the following disclaimer in the documentation and/or other materials provided with the distribution.
3. The name of the author may not be used to endorse or promote products derived from this software without specific prior written permission.

THIS SOFTWARE IS PROVIDED BY THE AUTHOR "AS IS" AND ANY EXPRESS OR IMPLIED WARRANTIES, INCLUDING, BUT NOT LIMITED TO, THE IMPLIED WARRANTIES OF MERCHANTABILITY AND FITNESS FOR A PARTICULAR PURPOSE ARE DISCLAIMED. IN NO EVENT SHALL THE AUTHOR BE LIABLE FOR ANY DIRECT, INDIRECT, INCIDENTAL, SPECIAL, EXEMPLARY, OR CONSEQUENTIAL DAMAGES (INCLUDING, BUT NOT LIMITED TO, PROCUREMENT OF SUBSTITUTE GOODS OR SERVICES; LOSS OF USE, DATA, OR PROFITS; OR BUSINESS INTERRUPTION) HOWEVER CAUSED AND ON ANY THEORY OF LIABILITY, WHETHER IN CONTRACT, STRICT LIABILITY, OR TORT (INCLUDING NEGLIGENCE OR OTHERWISE) ARISING IN ANY WAY OUT OF THE USE OF THIS SOFTWARE, EVEN IF ADVISED OF THE POSSIBILITY OF SUCH DAMAGE.

Copyright (c) 1991, 1993

The Regents of the University of California. All rights reserved.

Redistribution and use in source and binary forms, with or without modification, are permitted provided that the following conditions are met:

1. Redistributions of source code must retain the above copyright notice, this list of conditions and the following disclaimer.
2. Redistributions in binary form must reproduce the above copyright notice, this list of conditions and the following disclaimer in the documentation and/or other materials provided with the distribution.
3. Neither the name of the University nor the names of its contributors may be used to endorse or promote products derived from this software without specific prior written permission.

THIS SOFTWARE IS PROVIDED BY THE REGENTS AND CONTRIBUTORS "AS IS" AND ANY EXPRESS OR IMPLIED WARRANTIES, INCLUDING, BUT NOT LIMITED TO, THE IMPLIED WARRANTIES OF MERCHANTABILITY AND FITNESS FOR A PARTICULAR PURPOSE ARE DISCLAIMED. IN NO EVENT SHALL THE REGENTS OR CONTRIBUTORS BE LIABLE FOR ANY DIRECT, INDIRECT, INCIDENTAL, SPECIAL, EXEMPLARY, OR CONSEQUENTIAL DAMAGES (INCLUDING, BUT NOT LIMITED TO, PROCUREMENT OF SUBSTITUTE GOODS

OR SERVICES; LOSS OF USE, DATA, OR PROFITS; OR BUSINESS INTERRUPTION) HOWEVER CAUSED AND ON ANY THEORY OF LIABILITY, WHETHER IN CONTRACT, STRICT LIABILITY, OR TORT (INCLUDING NEGLIGENCE OR OTHERWISE) ARISING IN ANY WAY OUT OF THE USE OF THIS SOFTWARE, EVEN IF ADVISED OF THE POSSIBILITY OF SUCH DAMAGE.

Driver: cdns-mhdp - Cadence MHDP DP bridge

File: cadence/mhdp8546.bin

Version: 1.2.15

Licence: Redistributable. See LICENCE.cadence for details

Driver: fsl-mc bus - NXP Management Complex Bus Driver

File: dpaa2/mc/mc_10.10.0_ls1088a.itb

File: dpaa2/mc/mc_10.10.0_ls2088a.itb

File: dpaa2/mc/mc_10.10.0_lx2160a.itb

File: dpaa2/mc/mc_10.14.3_ls1088a.itb

File: dpaa2/mc/mc_10.14.3_ls2088a.itb

File: dpaa2/mc/mc_10.14.3_lx2160a.itb

File: dpaa2/mc/mc_10.16.2_ls1088a.itb

File: dpaa2/mc/mc_10.16.2_ls2088a.itb

File: dpaa2/mc/mc_10.16.2_lx2160a.itb

Licence: Redistributable. See LICENSE.nxp_mc_firmware for details

Driver: msc-phy - Microchip PHY drivers

File: microchip/mscc_vsc8574_revb_int8051_29e8.bin

File: microchip/mscc_vsc8584_revb_int8051_fb48.bin

Licence: Redistributable. See LICENCE.microchip for details

Driver: meson-vdec - Amlogic video decoder

File: meson/vdec/g12a_h264.bin

File: meson/vdec/g12a_vp9.bin

File: meson/vdec/gxbb_h264.bin

File: meson/vdec/gxl_h263.bin

File: meson/vdec/gxl_h264.bin

File: meson/vdec/gxl_hevc.bin

File: meson/vdec/gxl_hevc_mmu.bin

File: meson/vdec/gxl_mjpeg.bin

File: meson/vdec/gxl_mpeg12.bin

File: meson/vdec/gxl_mpeg4_5.bin

File: meson/vdec/gxm_h264.bin

LICENCE TERMS (cont.)

Licence: Redistributable. See LICENSE.amlogic_vdec for details.

Copyright 1987 by MIT Student Information Processing Board

Permission to use, copy, modify, and distribute this software and its documentation for any purpose is hereby granted, provided that the names of M.I.T. and the M.I.T. S.I.P.B. not be used in advertising or publicity pertaining to distribution of the software without specific, written prior permission. M.I.T. and the M.I.T. S.I.P.B. make no representations about the suitability of this software for any purpose. It is provided ""as is"" without express or implied warranty.

Copyright 1987, 1988 by MIT Student Information Processing Board

Permission to use, copy, modify, and distribute this software and its documentation for any purpose is hereby granted, provided that the names of M.I.T. and the M.I.T. S.I.P.B. not be used in advertising or publicity pertaining to distribution of the software without specific, written prior permission. M.I.T. and the M.I.T. S.I.P.B. make no representations about the suitability of this software for any purpose. It is provided ""as is"" without express or implied warranty.

This quote is just too good to not pass on:

""BTW, I would have rejected the name Story Server because its initials are SS, the name of the secret police in Nazi Germany, probably the most despised pair of letters in western culture."" --- <http://scriptingnewsarchive.userland.com/1999/12/13>

Let no one say political correctness isn't dead...

Copyright (c) 1998-2000 Thai Open Source Software Center Ltd and Clark Cooper
Copyright (c) 2001-2017 Expat maintainers

Permission is hereby granted, free of charge, to any person obtaining a copy of this software and associated documentation files (the "Software"), to deal in the Software without restriction, including without limitation the rights to use, copy, modify, merge, publish, distribute, sublicense, and/or sell copies of the Software, and to permit persons to whom the Software is furnished to do so, subject to the following conditions:

The above copyright notice and this permission notice shall be included in all copies or substantial portions of the Software.

THE SOFTWARE IS PROVIDED "AS IS", WITHOUT WARRANTY OF ANY KIND, EXPRESS OR IMPLIED, INCLUDING BUT NOT LIMITED TO THE WARRANTIES OF

MERCHANTABILITY, FITNESS FOR A PARTICULAR PURPOSE AND NONINFRINGEMENT. IN NO EVENT SHALL THE AUTHORS OR COPYRIGHT HOLDERS BE LIABLE FOR ANY CLAIM, DAMAGES OR OTHER LIABILITY, WHETHER IN AN ACTION OF CONTRACT, TORT OR OTHERWISE, ARISING FROM, OUT OF OR IN CONNECTION WITH THE SOFTWARE OR THE USE OR OTHER DEALINGS IN THE SOFTWARE.

The DEC portions are under the following license:
Portions Copyright (C) 1993 by Digital Equipment Corporation.

Permission to use, copy, modify, and distribute this software for any purpose with or without fee is hereby granted, provided that the above copyright notice and this permission notice appear in all copies, and that the name of Digital Equipment Corporation not be used in advertising or publicity pertaining to distribution of the document or software without specific, written prior permission.

THE SOFTWARE IS PROVIDED ``AS IS" AND DIGITAL EQUIPMENT CORP. DISCLAIMS ALL WARRANTIES WITH REGARD TO THIS SOFTWARE, INCLUDING ALL IMPLIED WARRANTIES OF MERCHANTABILITY AND FITNESS. IN NO EVENT SHALL DIGITAL EQUIPMENT CORPORATION BE LIABLE FOR ANY SPECIAL, DIRECT, INDIRECT, OR CONSEQUENTIAL DAMAGES OR ANY DAMAGES WHATSOEVER RESULTING FROM LOSS OF USE, DATA OR PROFITS, WHETHER IN AN ACTION OF CONTRACT, NEGLIGENCE OR OTHER TORTIOUS ACTION, ARISING OUT OF OR IN CONNECTION WITH THE USE OR PERFORMANCE OF THIS SOFTWARE.

Mach Operating System
Copyright (C) 1991,1990,1989 Carnegie Mellon University
All Rights Reserved.

Permission to use, copy, modify and distribute this software and its documentation is hereby granted, provided that both the copyright notice and this permission notice appear in all copies of the software, derivative works or modified versions, and any portions thereof, and that both notices appear in supporting documentation.

CARNEGIE MELLON ALLOWS FREE USE OF THIS SOFTWARE IN ITS ``AS IS" CONDITION. CARNEGIE MELLON DISCLAIMS ANY LIABILITY OF ANY KIND FOR ANY DAMAGES WHATSOEVER RESULTING FROM THE USE OF THIS SOFTWARE.

Carnegie Mellon requests users of this software to return to

Software Distribution Coordinator
School of Computer Science
Carnegie Mellon University
Pittsburgh PA 15213-3890

or Software.Distribution@CS.CMU.EDU any improvements or extensions that they make and grant Carnegie Mellon the rights to redistribute these changes.

LICENCE TERMS (cont.)

Copyright 1995 by Tom Lord

All Rights Reserved

Permission to use, copy, modify, and distribute this software and its documentation for any purpose and without fee is hereby granted, provided that the above copyright notice appear in all copies and that both that copyright notice and this permission notice appear in supporting documentation, and that the name of the copyright holder not be used in advertising or publicity pertaining to distribution of the software without specific, written prior permission.

Tom Lord DISCLAIMS ALL WARRANTIES WITH REGARD TO THIS SOFTWARE, INCLUDING ALL IMPLIED WARRANTIES OF MERCHANTABILITY AND FITNESS, IN NO EVENT SHALL TOM LORD BE LIABLE FOR ANY SPECIAL, INDIRECT OR CONSEQUENTIAL DAMAGES OR ANY DAMAGES WHATSOEVER RESULTING FROM LOSS OF USE, DATA OR PROFITS, WHETHER IN AN ACTION OF CONTRACT, NEGLIGENCE OR OTHER TORTIOUS ACTION, ARISING OUT OF OR IN CONNECTION WITH THE USE OR PERFORMANCE OF THIS SOFTWARE.

Copyright (c) 2007, 2008	Johannes Berg
Copyright (c) 2007	Andy Lutomirski
Copyright (c) 2007	Mike Kershaw
Copyright (c) 2008-2009	Luis R. Rodriguez

Permission to use, copy, modify, and/or distribute this software for any purpose with or without fee is hereby granted, provided that the above copyright notice and this permission notice appear in all copies.

THE SOFTWARE IS PROVIDED ""AS IS"" AND THE AUTHOR DISCLAIMS ALL WARRANTIES WITH REGARD TO THIS SOFTWARE INCLUDING ALL IMPLIED WARRANTIES OF MERCHANTABILITY AND FITNESS. IN NO EVENT SHALL THE AUTHOR BE LIABLE FOR ANY SPECIAL, DIRECT, INDIRECT, OR CONSEQUENTIAL DAMAGES OR ANY DAMAGES WHATSOEVER RESULTING FROM LOSS OF USE, DATA OR PROFITS, WHETHER IN AN ACTION OF CONTRACT, NEGLIGENCE OR OTHER TORTIOUS ACTION, ARISING OUT OF OR IN CONNECTION WITH THE USE OR PERFORMANCE OF THIS SOFTWARE.

COPYRIGHT AND PERMISSION NOTICE

Copyright (c) 1996 - 2019, Daniel Stenberg, <daniel@haxx.se>, and many contributors, see the THANKS file.

All rights reserved.

Permission to use, copy, modify, and distribute this software for any purpose with or without fee is hereby granted, provided that the above copyright notice and this permission notice appear in all copies.

THE SOFTWARE IS PROVIDED ""AS IS"", WITHOUT WARRANTY OF ANY KIND, EXPRESS OR IMPLIED, INCLUDING BUT NOT LIMITED TO THE WARRANTIES OF MERCHANTABILITY, FITNESS FOR A PARTICULAR PURPOSE AND NONINFRINGEMENT OF THIRD PARTY RIGHTS. IN

NO EVENT SHALL THE AUTHORS OR COPYRIGHT HOLDERS BE LIABLE FOR ANY CLAIM, DAMAGES OR OTHER LIABILITY, WHETHER IN AN ACTION OF CONTRACT, TORT OR OTHERWISE, ARISING FROM, OUT OF OR IN CONNECTION WITH THE SOFTWARE OR THE USE OR OTHER DEALINGS IN THE SOFTWARE.

Except as contained in this notice, the name of a copyright holder shall not be used in advertising or otherwise to promote the sale, use or other dealings in this Software without prior written authorization of the copyright holder.

libffi - Copyright (c) 1996-2014 Anthony Green, Red Hat, Inc and others.
See source files for details.

Permission is hereby granted, free of charge, to any person obtaining a copy of this software and associated documentation files (the ""Software""), to deal in the Software without restriction, including without limitation the rights to use, copy, modify, merge, publish, distribute, sublicense, and/or sell copies of the Software, and to permit persons to whom the Software is furnished to do so, subject to the following conditions:

The above copyright notice and this permission notice shall be included in all copies or substantial portions of the Software.

THE SOFTWARE IS PROVIDED ""AS IS"", WITHOUT WARRANTY OF ANY KIND, EXPRESS OR IMPLIED, INCLUDING BUT NOT LIMITED TO THE WARRANTIES OF MERCHANTABILITY, FITNESS FOR A PARTICULAR PURPOSE AND NONINFRINGEMENT. IN NO EVENT SHALL THE AUTHORS OR COPYRIGHT HOLDERS BE LIABLE FOR ANY CLAIM, DAMAGES OR OTHER LIABILITY, WHETHER IN AN ACTION OF CONTRACT, TORT OR OTHERWISE, ARISING FROM, OUT OF OR IN CONNECTION WITH THE SOFTWARE OR THE USE OR OTHER DEALINGS IN THE SOFTWARE.

Except where otherwise noted in the source code (e.g. the files hash.c, list.c and the trio files, which are covered by a similar licence but with different Copyright notices) all the files are:

Copyright (C) 1998-2012 Daniel Veillard. All Rights Reserved.

Permission is hereby granted, free of charge, to any person obtaining a copy of this software and associated documentation files (the ""Software""), to deal in the Software without restriction, including without limitation the rights to use, copy, modify, merge, publish, distribute, sublicense, and/or sell copies of the Software, and to permit persons to whom the Software is furnished to do so, subject to the following conditions:

The above copyright notice and this permission notice shall be included in all copies or substantial portions of the Software.

THE SOFTWARE IS PROVIDED ""AS IS"", WITHOUT WARRANTY OF ANY KIND, EXPRESS OR IMPLIED, INCLUDING BUT NOT LIMITED TO THE WARRANTIES OF MERCHANTABILITY, FIT-

LICENCE TERMS (cont.)

NESS FOR A PARTICULAR PURPOSE AND NONINFRINGEMENT. IN NO EVENT SHALL THE AUTHORS OR COPYRIGHT HOLDERS BE LIABLE FOR ANY CLAIM, DAMAGES OR OTHER LIABILITY, WHETHER IN AN ACTION OF CONTRACT, TORT OR OTHERWISE, ARISING FROM, OUT OF OR IN CONNECTION WITH THE SOFTWARE OR THE USE OR OTHER DEALINGS IN THE SOFTWARE.

Copyright (C) 2000 Gary Pennington and Daniel Veillard.
Copyright (C) 1998 Bjorn Reese and Daniel Stenberg.

Permission to use, copy, modify, and distribute this software for any purpose with or without fee is hereby granted, provided that the above copyright notice and this permission notice appear in all copies.

THIS SOFTWARE IS PROVIDED "AS IS" AND WITHOUT ANY EXPRESS OR IMPLIED WARRANTIES, INCLUDING, WITHOUT LIMITATION, THE IMPLIED WARRANTIES OF MERCHANTABILITY AND FITNESS FOR A PARTICULAR PURPOSE. THE AUTHORS AND CONTRIBUTORS ACCEPT NO RESPONSIBILITY IN ANY CONCEIVABLE MANNER.

The authors of this software are Rob Pike, Sape Mullender, and Russ Cox
Copyright (c) 2003 by Lucent Technologies.

Permission to use, copy, modify, and distribute this software for any purpose without fee is hereby granted, provided that this entire notice is included in all copies of any software which is or includes a copy or modification of this software and in all copies of the supporting documentation for such software.

THIS SOFTWARE IS BEING PROVIDED "AS IS", WITHOUT ANY EXPRESS OR IMPLIED WARRANTY. IN PARTICULAR, NEITHER THE AUTHORS NOR LUCENT TECHNOLOGIES MAKE ANY REPRESENTATION OR WARRANTY OF ANY KIND CONCERNING THE MERCHANTABILITY OF THIS SOFTWARE OR ITS FITNESS FOR ANY PARTICULAR PURPOSE.

Copyright (c) 1999-2004,2005 Free Software Foundation, Inc.

Permission is hereby granted, free of charge, to any person obtaining a copy of this software and associated documentation files (the "Software"), to deal in the Software without restriction, including without limitation the rights to use, copy, modify, merge, publish, distribute, distribute with modifications, sublicense, and/or sell copies of the Software, and to permit persons to whom the Software is furnished to do so, subject to the following conditions:

The above copyright notice and this permission notice shall be included in all copies or substantial portions of the Software.

THE SOFTWARE IS PROVIDED "AS IS", WITHOUT WARRANTY OF ANY KIND, EXPRESS OR IMPLIED, INCLUDING BUT NOT LIMITED TO THE WARRANTIES OF MERCHANTABILITY, FITNESS FOR A PARTICULAR PURPOSE AND NONINFRINGEMENT.

IN NO EVENT SHALL THE ABOVE COPYRIGHT HOLDERS BE LIABLE FOR ANY CLAIM, DAMAGES OR OTHER LIABILITY, WHETHER IN AN ACTION OF CONTRACT, TORT OR OTHERWISE, ARISING FROM, OUT OF OR IN CONNECTION WITH THE SOFTWARE OR THE USE OR OTHER DEALINGS IN THE SOFTWARE.

Except as contained in this notice, the name(s) of the above copyright holders shall not be used in advertising or otherwise to promote the sale, use or other dealings in this Software without prior written authorization.

Copyright (c) 2012 - 2022 Krzysztof Gabis

Permission is hereby granted, free of charge, to any person obtaining a copy of this software and associated documentation files (the "Software"), to deal in the Software without restriction, including without limitation the rights to use, copy, modify, merge, publish, distribute, sublicense, and/or sell copies of the Software, and to permit persons to whom the Software is furnished to do so, subject to the following conditions:

The above copyright notice and this permission notice shall be included in all copies or substantial portions of the Software.

THE SOFTWARE IS PROVIDED "AS IS", WITHOUT WARRANTY OF ANY KIND, EXPRESS OR IMPLIED, INCLUDING BUT NOT LIMITED TO THE WARRANTIES OF MERCHANTABILITY, FITNESS FOR A PARTICULAR PURPOSE AND NONINFRINGEMENT. IN NO EVENT SHALL THE AUTHORS OR COPYRIGHT HOLDERS BE LIABLE FOR ANY CLAIM, DAMAGES OR OTHER LIABILITY, WHETHER IN AN ACTION OF CONTRACT, TORT OR OTHERWISE, ARISING FROM, OUT OF OR IN CONNECTION WITH THE SOFTWARE OR THE USE OR OTHER DEALINGS IN THE SOFTWARE.

Copyright (c) 2009 Dave Gamble

Permission is hereby granted, free of charge, to any person obtaining a copy of this software and associated documentation files (the "Software"), to deal in the Software without restriction, including without limitation the rights to use, copy, modify, merge, publish, distribute, sublicense, and/or sell copies of the Software, and to permit persons to whom the Software is furnished to do so, subject to the following conditions:

The above copyright notice and this permission notice shall be included in all copies or substantial portions of the Software.

THE SOFTWARE IS PROVIDED "AS IS", WITHOUT WARRANTY OF ANY KIND, EXPRESS OR IMPLIED, INCLUDING BUT NOT LIMITED TO THE WARRANTIES OF MERCHANTABILITY, FITNESS FOR A PARTICULAR PURPOSE AND NONINFRINGEMENT. IN NO EVENT SHALL THE AUTHORS OR COPYRIGHT HOLDERS BE LIABLE FOR ANY CLAIM, DAMAGES OR OTHER LIABILITY, WHETHER IN AN ACTION OF CONTRACT, TORT OR OTHERWISE, ARISING FROM, OUT OF OR IN CONNECTION WITH THE SOFTWARE OR THE USE OR OTHER DEALINGS IN THE SOFTWARE.

LICENCE TERMS (cont.)

Copyright (c) 2005-2007 Russ Cox,
Massachusetts Institute of Technology

Permission is hereby granted, free of charge, to any person obtaining a copy of this software and associated documentation files (the "Software"), to deal in the Software without restriction, including without limitation the rights to use, copy, modify, merge, publish, distribute, sublicense, and/or sell copies of the Software, and to permit persons to whom the Software is furnished to do so, subject to the following conditions:

The above copyright notice and this permission notice shall be included in all copies or substantial portions of the Software.

THE SOFTWARE IS PROVIDED "AS IS", WITHOUT WARRANTY OF ANY KIND, EXPRESS OR IMPLIED, INCLUDING BUT NOT LIMITED TO THE WARRANTIES OF MERCHANTABILITY, FITNESS FOR A PARTICULAR PURPOSE AND NONINFRINGEMENT. IN NO EVENT SHALL THE AUTHORS OR COPYRIGHT HOLDERS BE LIABLE FOR ANY CLAIM, DAMAGES OR OTHER LIABILITY, WHETHER IN AN ACTION OF CONTRACT, TORT OR OTHERWISE, ARISING FROM, OUT OF OR IN CONNECTION WITH THE SOFTWARE OR THE USE OR OTHER DEALINGS IN THE SOFTWARE.

Copyright (c) 1999,2000,2001,2002,2003
The Board of Trustees of the University of Illinois
All Rights Reserved.

Permission is hereby granted, free of charge, to any person obtaining a copy of this software (lperf) and associated documentation files (the "Software"), to deal in the Software without restriction, including without limitation the rights to use, copy, modify, merge, publish, distribute, sublicense, and/or sell copies of the Software, and to permit persons to whom the Software is furnished to do so, subject to the following conditions:

Redistributions of source code must retain the above copyright notice, this list of conditions and the following disclaimers.

Redistributions in binary form must reproduce the above copyright notice, this list of conditions and the following disclaimers in the documentation and/or other materials provided with the distribution.

Neither the names of the University of Illinois, NCSA, nor the names of its contributors may be used to endorse or promote products derived from this Software without specific prior written permission.

THE SOFTWARE IS PROVIDED "AS IS", WITHOUT WARRANTY OF ANY KIND, EXPRESS OR IMPLIED, INCLUDING BUT NOT LIMITED TO THE WARRANTIES OF MERCHANTABILITY, FITNESS FOR A PARTICULAR PURPOSE AND NONINFRINGEMENT. IN NO EVENT SHALL THE CONTRIBUTORS OR COPYRIGHT HOLDERS BE LIABLE FOR ANY CLAIM, DAMAGES OR OTHER LIABILITY,

WHETHER IN AN ACTION OF CONTRACT, TORT OR OTHERWISE, ARISING FROM, OUT OF OR IN CONNECTION WITH THE SOFTWARE OR THE USE OR OTHER DEALINGS IN THE SOFTWARE.

National Laboratory for Applied Network Research
National Center for Supercomputing Applications
University of Illinois at Urbana-Champaign
<http://www.ncsa.uiuc.edu>

stdio.c
by Mark Gates <mgates@nlanr.net>
and Ajay Tirumalla <tirumala@ncsa.uiuc.edu>

input and output numbers, converting with kilo, mega, giga

This work may be reproduced and distributed in whole or in part, in any medium, physical or electronic, so as long as this copyright notice remains intact and unchanged on all copies. Commercial redistribution is permitted and encouraged, but you may not redistribute, in whole or in part, under terms more restrictive than those under which you received it. If you redistribute a modified or translated version of this work, you must also make the source code to the modified or translated version available in electronic form without charge. However, mere aggregation as part of a larger work shall not count as a modification for this purpose.

All code examples in this work are placed into the public domain, and may be used, modified and redistributed without restriction.

BECAUSE THIS WORK IS LICENSED FREE OF CHARGE, THERE IS NO WARRANTY FOR THE WORK, TO THE EXTENT PERMITTED BY APPLICABLE LAW. EXCEPT WHEN OTHERWISE STATED IN WRITING THE COPYRIGHT HOLDERS AND/OR OTHER PARTIES PROVIDE THE WORK "AS IS" WITHOUT WARRANTY OF ANY KIND, EITHER EXPRESSED OR IMPLIED, INCLUDING, BUT NOT LIMITED TO, THE IMPLIED WARRANTIES OF MERCHANTABILITY AND FITNESS FOR A PARTICULAR PURPOSE. SHOULD THE WORK PROVE DEFECTIVE, YOU ASSUME THE COST OF ALL NECESSARY REPAIR OR CORRECTION.

IN NO EVENT UNLESS REQUIRED BY APPLICABLE LAW OR AGREED TO IN WRITING WILL ANY COPYRIGHT HOLDER, OR ANY OTHER PARTY WHO MAY MODIFY AND/OR REDISTRIBUTE THE WORK AS PERMITTED ABOVE, BE LIABLE TO YOU FOR DAMAGES, INCLUDING ANY GENERAL, SPECIAL, INCIDENTAL OR CONSEQUENTIAL DAMAGES ARISING OUT OF THE USE OR INABILITY TO USE THE WORK, EVEN IF SUCH HOLDER OR OTHER PARTY HAS BEEN ADVISED OF THE POSSIBILITY OF SUCH DAMAGES.

XZ Utils Licensing
=====

Different licenses apply to different files in this package. Here is a rough summary of which licenses apply to which parts of this package (but check the individual files to be sure!):

LICENCE TERMS (cont.)

- liblzma is in the public domain.
- xz, xzdec, and lzmadec command line tools are in the public domain unless GNU getopt_long had to be compiled and linked in from the lib directory. The getopt_long code is under GNU LGPLv2.1+.
- The scripts to grep, diff, and view compressed files have been adapted from gzip. These scripts and their documentation are under GNU GPLv2+.
- All the documentation in the doc directory and most of the XZ Utils specific documentation files in other directories are in the public domain.
- Translated messages are in the public domain.
- The build system contains public domain files, and files that are under GNU GPLv2+ or GNU GPLv3+. None of these files end up in the binaries being built.
- Test files and test code in the tests directory, and debugging utilities in the debug directory are in the public domain.
- The extra directory may contain public domain files, and files that are under various free software licenses.

You can do whatever you want with the files that have been put into the public domain. If you find public domain legally problematic, take the previous sentence as a license grant. If you still find the lack of copyright legally problematic, you have too many lawyers.

As usual, this software is provided "as is", without any warranty.

If you copy significant amounts of public domain code from XZ Utils into your project, acknowledging this somewhere in your software is polite (especially if it is proprietary, non-free software), but naturally it is not legally required. Here is an example of a good notice to put into "about box" or into documentation:

This software includes code from XZ Utils <<https://tukaani.org/xz/>>.

The following license texts are included in the following files:

- COPYING.LGPLv2.1: GNU Lesser General Public License version 2.1
- COPYING.GPLv2: GNU General Public License version 2
- COPYING.GPLv3: GNU General Public License version 3

Note that the toolchain (compiler, linker etc.) may add some code pieces that are copyrighted. Thus, it is possible that e.g. liblzma binary wouldn't actually be in the public domain in its entirety even though it contains no copyrighted code from the XZ Utils source package.

If you have questions, don't hesitate to ask the author(s) for more information.

check the individual files to be sure!):

- liblzma is in the public domain.
- xz, xzdec, and lzmadec command line tools are in the public domain unless GNU getopt_long had to be compiled and linked in from the lib directory. The getopt_long code is under GNU LGPLv2.1+.
- The scripts to grep, diff, and view compressed files have been adapted from gzip. These scripts and their documentation are under GNU GPLv2+.
- All the documentation in the doc directory and most of the XZ Utils specific documentation files in other directories are in the public domain.
- Translated messages are in the public domain.
- The build system contains public domain files, and files that are under GNU GPLv2+ or GNU GPLv3+. None of these files end up in the binaries being built.
- Test files and test code in the tests directory, and debugging utilities in the debug directory are in the public domain.
- The extra directory may contain public domain files, and files that are under various free software licenses.

You can do whatever you want with the files that have been put into the public domain. If you find public domain legally problematic, take the previous sentence as a license grant. If you still find the lack of copyright legally problematic, you have too many lawyers.

As usual, this software is provided "as is", without any warranty.

If you copy significant amounts of public domain code from XZ Utils into your project, acknowledging this somewhere in your software is polite (especially if it is proprietary, non-free software), but naturally it is not legally required. Here is an example of a good notice to put into "about box" or into documentation:

This software includes code from XZ Utils <<https://tukaani.org/xz/>>.

The following license texts are included in the following files:

- COPYING.LGPLv2.1: GNU Lesser General Public License version 2.1
- COPYING.GPLv2: GNU General Public License version 2
- COPYING.GPLv3: GNU General Public License version 3

Note that the toolchain (compiler, linker etc.) may add some code pieces that are copyrighted. Thus, it is possible that e.g. liblzma binary wouldn't actually be in the public domain in its entirety even though it contains no copyrighted code from the XZ Utils source package.

LICENCE TERMS (cont.)

If you have questions, don't hesitate to ask the author(s) for more information.

 This software contains source code (src/portable_endian.h) that is:
 // "License": Public Domain
 // I, Mathias Panzenböck, place this file hereby into the public domain. Use it at your own risk for whatever you like.

2001-09-15

The author disclaims copyright to this source code. In place of a legal notice, here is a blessing:

May you do good and not evil.
 May you find forgiveness for yourself and forgive others.
 May you share freely, never taking more than you give.

[India Only]

Information on hazardous constituents as specified in sub-rule1 of rule16 in electrical and electronic equipment.

Declaration of Conformity with the requirements of the E-Waste (Management) Amendment Rules, 2023 with the sub-rule1 of rule16 limits with respect to Lead, Mercury, Cadmium, Hexavalent chromium, Polybrominated biphenyls, Polybrominated diphenyl ethers.

The content of hazardous substance with the exemption of the applications listed in SCHEDULE II of the E-Waste (Management) Second Amendment Rules, 2023:

1. Lead (Pb) – not over 0.1% by weight.
2. Cadmium (Cd) – not over 0.01% by weight.
3. Mercury (Hg) – not over 0.1% by weight.
4. Hexavalent chromium (Cr6+) – not over 0.1% by weight.
5. Polybrominated biphenyls (PBBs) – not over 0.1% by weight.
6. Polybrominated diphenyl ethers (PBDEs) – not over 0.1% by weight.



For the purpose of recycling to facilitate effective utilization of resources, please return this product to a nearby authorized collection center, registered dismantler or recycler, or Panasonic service center when disposing of this product. Customer care number (Toll free) : 1800 103 1333 , 1800 105 1333 Please see the Panasonic website for further information on collection centers, etc. or call the customer care toll-free number <https://www.panasonic.com/in/corporate/e-waste-management.html>

Do's & Don'ts		
No.	Do's	Don'ts
1	All electrical and electronic products are required to be handed over only to the Authorized recycler.	The product should not be opened by the user himself / herself, but only by authorized service personnel.
2	The product should be handed over only to authorized recycler for disposal.	The product is not meant for re-sale to any unauthorized agencies / scrap dealers / kabariwalas.
3	Keep the product in an isolated area, after it becomes non-functional / unrepairable so as to prevent its accidental breakage.	The product is not meant for mixing into household waste stream.
4	Refer to Operating Instructions for handling of end of life products	Do not keep any replaced spare part(s) from the product in an exposed area.
5	Always dispose of products that have reached end of life at Panasonic Life Solutions India Authorized Service Centre.	Do not donate old electronic items to anybody. Do not dispose of your product in garbage bins along with municipal waste that ultimately reaches landfill.
6	Wherever possible or as instructed, separate the packaging material according to responsible waste disposal options and sorting for recycling.	Do not give e-waste to informal and unorganized sectors like Local Scrap Dealers / Rag Pickers.

如需完整版使用说明书, 请参见官网。

사용설명서 전체 내용에 대해서는 웹사이트를 참조하십시오.

For full version Operating Instructions, please refer to the web site.

<https://panasonic.net/electricworks/ecm/powerelctrictools/download/>



[한국시장만]

• 사용자 안내문

이 기기는 업무용 환경에서 사용할 목적으로 적합성평가를 받은 기기로서 가정용 환경에서 사용 하는 경우 전파간섭의 우려가 있습니다.

- 이 제품은 실내 전용으로서 옥외에서 사용해서는 안됩니다.



R-R-PKL-EYFRW2

기 자 재 명 칭 : Assembly Controller

제 조 자 : Panasonic Corporation

제 조 국 가 : 일본

인증받은자의상호 : 파나소닉코리아주식회사

제 조 연 월 일 : 상품에 별도 기재

FRW2 23 07 0001

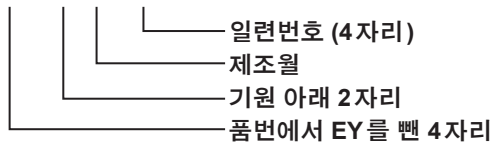

[中国大陆]

制造商: 松下电器株式会社

日本大阪府门真市大字门真 1006 番地

进口商: 松下电气设备(中国)有限公司上海第二分公司

上海市黄浦区淮海中路 2-8 号 10 楼 08 室

原产地: 日本

Panasonic Corporation

1006, Kadoma, Osaka 571-8501, Japan

<https://www.panasonic.com>

CN. KR. EN.

EY9411FRW203 20231208 S