

Model	Rated Voltage	Rated Current	Power	Power Factor	Hole size (mm)
NNNC60165WLE88	220V-240V ~	0.05A	10W (1x9W/LED Module)	0.96	φ75-φ80

- * The style and color of the lamp are based on the object.
- * The information may be subject to change without notice.

Model

(Please refer to the specification)

To Users

Thank you for purchasing our products.
Please read these instructions carefully before using this product, and save this manual for future use.

Safety Precautions

In order to prevent damage to body and property, these instructions must be followed.

⚠ Danger

- Do not cover the lamp with thermal insulation material. Avoid causing fire accident.

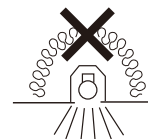

Leave a space between the appliance and thermal insulation materials, sound insulation materials and building materials, as shown in the figure below.

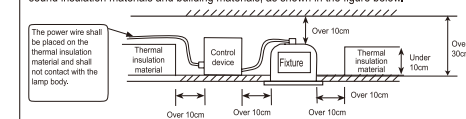

⚠ Warning

- Please install it in strict accordance with the instructions. Improper installation may cause lamp falling, electric shock and fire, etc.
- Do not modify the lamp and change parts (LED module, LED control device). Avoid accidents such as lamp falling, electric shock, fire, etc.
- This lamp is designed to be recessed on the horizontal ceilings. Do not install it on walls or sloping ceilings to avoid accidents such as fire or lamp falling.
- Do not use the power supply exceeding the specified parameters (Rated voltage 220V~240V, Frequency 50/60Hz). Avoid accidents such as electric shock and fire.
- The minimum distance between the lamp and the target object shall be greater than 30cm.
- Do not install the lamp in the place where the object may appear within the above minimum distance (such as above door, above furniture, in a wardrobe, locker, etc.). To avoid causing accidents due to overheat, such as fire.

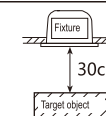

⚠ Notice

- Do not use in circumstances such as direct exposure to sunlight, moisture and corrosive gases. Avoid causing accidents such as fire, electric shock, falling lamp and rusting.
- Do not use the lamp in a place that may be affected by rain, such as under the roof, in the passage outside the room. Avoid causing accidents such as fire, electric shock, lamp falling, rusting, discoloring and peeling off.
- Please do not apply the lamp in places where the temperature is beyond 5°C~35 °C so as to avoid causing fire accident or shortening lamp's service life.
- Do not install the lamp on the insecure ceilings such as the ceiling made of asbestos. Avoid causing damage to the ceiling material or lamp falling.
- Do not put high temperature objects (stove, gas cooker, etc.) or objects emitting moisture under the lamp. Avoid causing fire, electric shock and other accidents.
- It is not advisable to install the lamp directly on the surface of common flammable material.
- If the external flexible cable or wire of the lamp is damaged, it shall be replaced by the manufacturer or a person with similar qualification, so as to avoid danger.



⚠ Notices During Installation

- When there is wallpaper on the installation surface, please install the lamp after the glue is fully dry to protect the lamp from rusting or discoloring. When the illumination distance is very short, or the illuminated surface is peculiar, uneven light distribution may occur. The LED lamp may have chromatic aberration, and even if it is the same product model, the color and brightness will be different. Do not use the lamp in a place where there is a large temperature difference between the indoor temperature and the temperature inside the ceiling. Or it will cause accidents such as electric shock and rusting.

⚠ Operating Instructions

- The light source of the lamp is non replaceable, when the light source has reached the end of its service life, the entire lamp should be replaced.
- Do not spray insecticide on the lamp. Avoid polluting or damaging the lamp.
- Please do not use organic solvents, insecticides or detergents other than neutral detergents to wipe the lamp. Avoid discoloration, deterioration, strength loss or damage of the lamp.

Components and Installation Methods

Before installation, make sure to cut off the power to avoid electric shock.

1 Preparation Before Installation

- Make sure to take out all the attachments.
- Make sure to take out all the attachments and tape before installation to prevent fire accident.
 - ※ Hold the main body of the lamp and take out the LED control device from the package. Do not pull the wire on the LED control device to avoid causing damage to the lamp.
- Ensure the installation position on the ceiling is strong enough to bear the weight of the lamp. Avoid causing lamp falling or other accidents.
- Adjustable angle model, confirm the smoothness of the angle before installation, and adjust slightly with the wrench. See the "Specifications Section" for details about the size of the hole on the ceiling.

2 Connection of Power Wire (Two people are recommended for the installation)

- To ensure safety, please be sure to cut off the power, before connecting the external power wire.
 - One person holds the lamp, and the other connects the power wire.
 - Terminal block with shell is recommended for wire connection. (The terminal block is to be purchased by yourself)
- Please properly connect the power wire of the lamp and the power wire of output end of the bluetooth electronic control device to the terminal block according to the signs on the LED control device.
- ※ ① After the connection, the brown and blue wires shall not be exposed outside the shell of the terminal block.
 - ※ ② The terminal block shall not be placed on the lamp.
 - ※ Improper connection may cause accidents such as fire and electric shock.

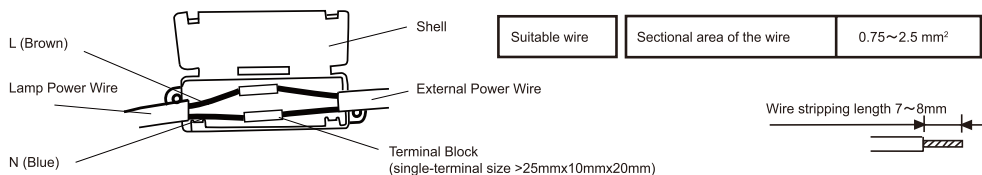

3 Connection of Dimmer and Lamp (Not applicable to non-adjustable lamps)

- To ensure safety, please be sure to cut off the power, before connecting the external power wire.
- The connecting port of the dimmer controller has basic insulation level.
- When connecting the power wire of the dimmer to the controller, one person shall hold the lamp and the other person takes off the power cap.
- Please correctly connect the power wire of the dimmer according to the signs on the power tag. DIM + is the + pole and DIM - is the - pole.
 - ※ 1. The 0-10V direct current output of the dimmer shall be of isolation type.
 - 2. Improper connection may cause accidents such as fire and electric shock.

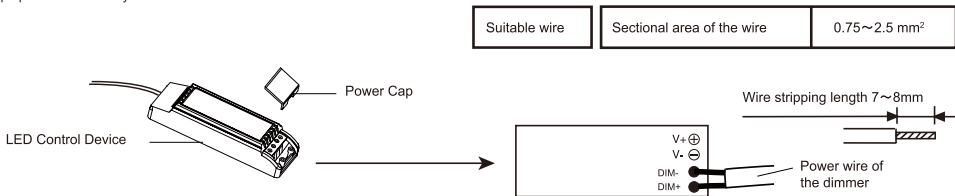

4 Installation and Dismounting of the Lamp

- Put the control device horizontally on the ceiling, as shown in the following figures. (The distance between the lamp and the control device shall be over 10cm)
 - ※ Do not twist the wires so as to avoid poor contact of the lamp.
- Use both hands to hold the lamp, and after installing the spring, push the lamp into the inserting hole on the ceiling.
- Dismounting method: Use both hands to pinch the external edge of the downlight, make the lamp downwards vertically, pull it to the state of suspension, press the spring and dismount the lamp.
 - ※ Improper installation or dismounting will cause lamp falling and damage to the lamp.

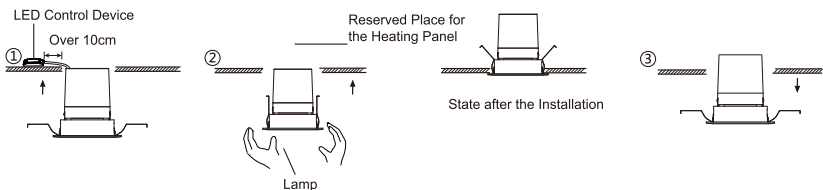

5 Adjustment of Illumination Direction (Not applicable to non-adjustable lamps)

- Adjust the swing angle according to the range shown below. [Notice] Improper adjustment may cause damage to the lamp. Horizontal rotation of the lamp is not allowed after installation to avoid wire winding. Reach into the lamp holder to adjust the angle with your fingers, but do not touch the lamp cap when the lamp is on or within 30 minutes after the lamp is off.

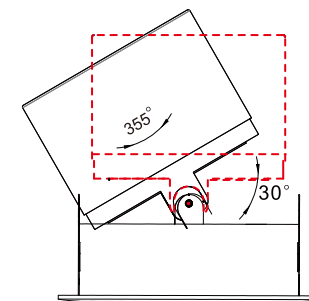

Repair · Maintenance

Make sure to cut off the power to avoid electric shock.

- In order to use this product safely and efficiently, please clean and check it regularly (once every 6 months).
- When cleaning, please wipe the lamp with soft cloth with neutral detergent, and then wipe it up with dry cloth.
- Do not use organic solvents, insecticides or detergents other than neutral detergents to wipe the lamp. Avoid discoloration, deterioration, strength loss or damage of the lamp.
 - Do not use the above solutions to wipe the lamp to avoid lamp corrosion or abrasion.



Installation diagram: (take NNNC604133WVZ88 as an example)

- * Do not install the lamp on the insecure ceiling such as the ceiling made of asbestos so as to avoid causing damage to the ceiling material or causing lamp falling.

