

Panasonic



Certificates & Standards

RoHs

Dimension and Materials

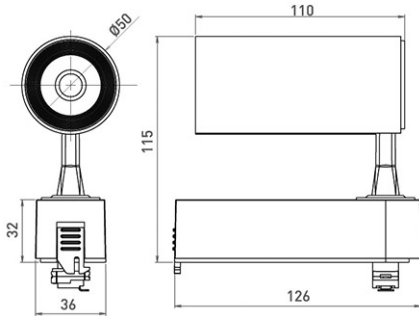

Photometric Chart

Ref. No.	
Type of Luminaire	Spotlight
	Track Lighting
	Track Lighting
Set Model No.	NNP03015031
Type of Light Source	LED
Power Input	12W
System Lumen Output	1000 lm
System Efficacy	
Power Voltage	100-240V
Power Factor	
Lifetime	30000H(L70)
CCT	3000K
CRI	90
SDCM	
Input Frequency	50/60Hz
Dimming	non-Dimmable
Dimming Range	
UGR	
Glare Cut Angle	72deg.
Beam Angle	36deg.
Rotation Angle	350deg.
Tilt Angle	
IP code	20
IK code	
Ambient Temperature Range	-20 - 40°C
Surge Protection	
Classification of Luminaires	
THDi	
Effective Projected Area	
Driver	Integrated
Cut Out Size	
Dimensions	50mm*50mm*105mm
Weight	
Body	ADC
Reflector	
Diffuser	
Trim	
Casing	
Country of Origin	China
Brand	Panasonic
Remarks	

Others

Spec and certification may change without notice.