

Panasonic



Certificates & Standards

RoHs

Dimension and Materials

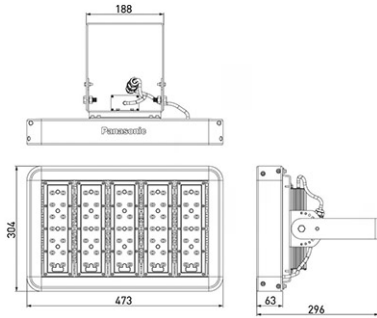

Photometric Chart

Ref. No.	
Type of Luminaire	Floodlight Standard Floodlight (Pro) A Series
Set Model No.	NNP19941031
Type of Light Source	LED
Power Input	200W
System Lumen Output	26000 lm
System Efficacy	
Power Voltage	110-240V
Power Factor	0.90
Lifetime	50000H(L70)
CCT	5000K
CRI	70
SDCM	
Input Frequency	50/60Hz
Dimming	non-Dimmable
Dimming Range	
UGR	
Glare Cut Angle	60deg.
Beam Angle	60deg.
Rotation Angle	
Tilt Angle	
IP code	65
IK code	
Ambient Temperature Range	-40 - 50°C
Surge Protection	
Classification of Luminaires	
THDi	
Effective Projected Area	
Driver	Integrated
Cut Out Size	
Dimensions	304mm*473mm*296mm
Weight	
Body	ADC
Reflector	
Diffuser	
Trim	
Casing	
Country of Origin	China
Brand	Panasonic
Remarks	

Spec and certification may change without notice.

Others