

Panasonic



Certificates & Standards

RoHs

Dimension and Materials

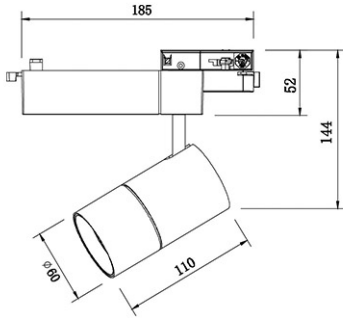

Height to lighted plane (m)	Initial beam center illuminance (lux)	Beam Diameter (mm)	Initial beam edge illuminance (lux)
1	4,755	650	2,045
2	1,189	1,300	511
3	528	1,950	227

Ref. No.	
Type of Luminaire	Spotlight
	Track Lighting
	Ex-A
Set Model No.	NNV00131WE1A
Type of Light Source	LED
Power Input	15W
System Lumen Output	1500 lm
System Efficacy	100 lm/W
Power Voltage	220-240V
Power Factor	0.9
Lifetime	50000H(L70)
CCT	4000K
CRI	80
SDCM	<5
Input Frequency	50/60Hz
Dimming	non-Dimmable
Dimming Range	
UGR	
Glare Cut Angle	
Beam Angle	36deg.
Rotation Angle	
Tilt Angle	
IP code	20
IK code	
Ambient Temperature Range	5 - 35°C
Surge Protection	
Classification of Luminaires	Class I
THDi	
Effective Projected Area	
Driver	Integrated
Cut Out Size	
Dimensions	60mm*110mm
Weight	0.56 kg
Body	ADC(White)
Reflector	
Diffuser	PMMA(Transparent)
Trim	
Casing	
Country of Origin	China
Brand	Panasonic
Remarks	

Others

Spec and certification may change without notice.