

Panasonic



Certificates & Standards

RoHs

Dimension and Materials

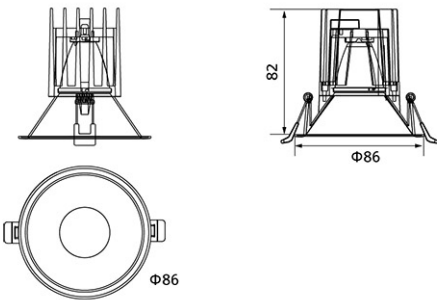

Photometric Chart

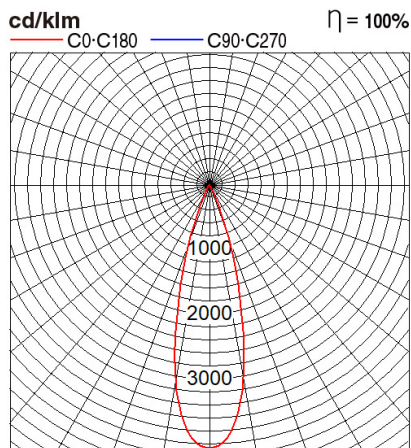

Ref. No.	
Type of Luminaire	Downlight
	Soft Glare DL
	Soft Glare DL
Set Model No.	NNV70656WE1A
Type of Light Source	LED
Power Input	10W
System Lumen Output	850 lm
System Efficacy	85 lm/W
Power Voltage	220-240V
Power Factor	0.95
Lifetime	50000H(L70)
CCT	3000K
CRI	80
SDCM	<3
Input Frequency	50/60Hz
Dimming	non-Dimmable
Dimming Range	
UGR	
Glare Cut Angle	30deg.
Beam Angle	24deg.
Rotation Angle	
Tilt Angle	
IP code	20
IK code	
Ambient Temperature Range	5 - 35°C
Surge Protection	
Classification of Luminaires	Class II
THDi	<10%
Effective Projected Area	
Driver	External
Cut Out Size	75mm
Dimensions	86mm*82mm
Weight	0.22 kg
Body	ADC(Black)
Reflector	PC(White)
Diffuser	PC(Transparent)
Trim	ADC(White)
Casing	
Country of Origin	China
Brand	Panasonic
Remarks	

Spec and certification may change without notice.

Others