

Panasonic



Certificates & Standards

RoHs

Dimension and Materials

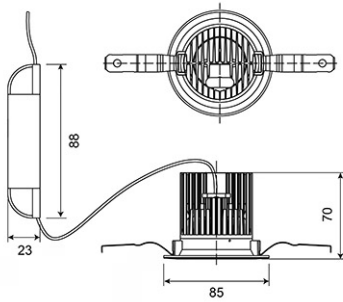

Photometric Chart

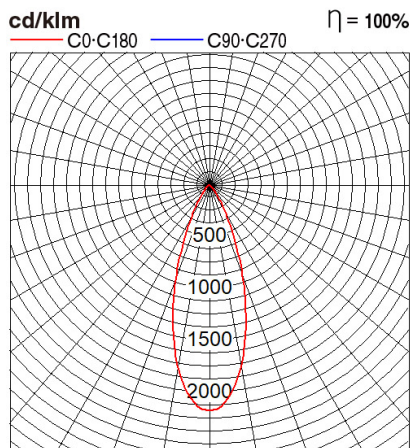

Ref. No.	
Type of Luminaire	Downlight
	Low Wattage Standard DL (Pro)
	Ex-H
Set Model No.	NNV71704WE1A
Type of Light Source	LED
Power Input	8W
System Lumen Output	780 lm
System Efficacy	98 lm/W
Power Voltage	220V
Power Factor	0.9
Lifetime	50000H(L70)
CCT	2700K
CRI	90
SDCM	<5
Input Frequency	50/60Hz
Dimming	non-Dimmable
Dimming Range	
UGR	
Glare Cut Angle	
Beam Angle	36deg.
Rotation Angle	
Tilt Angle	
IP code	20
IK code	
Ambient Temperature Range	5 - 35°C
Surge Protection	
Classification of Luminaires	Class II
THDi	
Effective Projected Area	
Driver	External
Cut Out Size	75mm
Dimensions	85mm*70mm
Weight	2.5 kg
Body	ADC(White)
Reflector	
Diffuser	PMMA(Transparent)
Trim	ADC(White)
Casing	
Country of Origin	China
Brand	Panasonic
Remarks	

Spec and certification may change without notice.

Others