

# Panasonic



## Certificates & Standards

RoHS / TISI

## Dimension and Materials

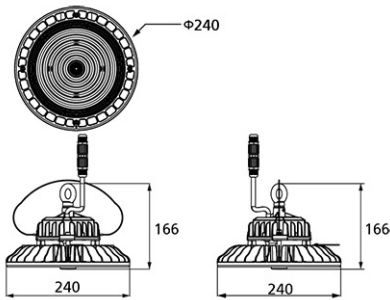

## Photometric Chart

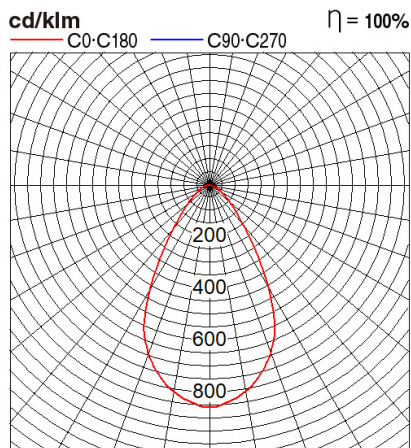

Ref. No.	
Type of Luminaire	High Bay High Efficacy/Standard High Bay Standard Ex 4G
Set Model No.	<b>NYV20151BE2A</b>
Type of Light Source	LED
Power Input	110W
System Lumen Output	15710 lm
System Efficacy	143 lm/W
Power Voltage	220-240V
Power Factor	0.95
Lifetime	50000H(L70)
CCT	5000K
CRI	80
SDCM	<5
Input Frequency	50/60Hz
Dimming	non-Dimmable
Dimming Range	
UGR	
Glare Cut Angle	
Beam Angle	60deg.
Rotation Angle	
Tilt Angle	
IP code	65
IK code	IK10
Ambient Temperature Range	-30 - 50°C
Surge Protection	10kV
Classification of Luminaires	Class I
THDi	
Effective Projected Area	
Driver	Integrated
Cut Out Size	
Dimensions	240mm*166mm
Weight	1.95 kg
Body	ADC(Black)
Reflector	
Diffuser	PC(Transparent)
Trim	
Casing	
Country of Origin	China
Brand	Panasonic
Remarks	Corrosion protection:WF2

Spec and certification may change without notice.

## Others